



FCC TEST REPORT

REPORT NO.: RF920725H01
MODEL NO.: SMC2555W-AG
RECEIVED: Jul. 25, 2003
TESTED: Jul. 27 to 30, 2003

APPLICANT: Accton Technology Corporation

ADDRESS: No.1, Creation Rd. III, Science-based Industrial Park, Hsinchu, Taiwan, R.O.C.

ISSUED BY: Advance Data Technology Corporation

LAB LOCATION: No. 81-1, Lu Liao Keng, 9 Ling, Wu Lung Tsuen, Chiung Lin Hsiang, Hsin Chu Hsien, Taiwan, R.O.C.

This test report consists of 164 pages in total. It may be duplicated completely for legal use with the approval of the applicant. It should not be reproduced except in full, without the written approval of our laboratory. The client should not use it to claim product endorsement by NVLAP or any government agencies. The test results in the report only apply to the tested sample.



Lab Code: 200376-0



Table of Contents

1.	CERTIFICATION.....	5
2.	SUMMARY OF TEST RESULTS.....	6
3.	GENERAL INFORMATION.....	8
3.1	GENERAL DESCRIPTION OF EUT.....	8
3.2	DESCRIPTION OF TEST MODES.....	10
3.3	GENERAL DESCRIPTION OF APPLIED STANDARDS.....	11
3.4	DESCRIPTION OF SUPPORT UNITS.....	12
4.	TEST TYPES AND RESULTS (FOR PART 802.11B).....	15
4.1	CONDUCTED EMISSION MEASUREMENT.....	15
4.1.1	LIMITS OF CONDUCTED EMISSION MEASUREMENT.....	15
4.1.2	TEST INSTRUMENTS.....	15
4.1.3	TEST PROCEDURES.....	16
4.1.4	DEVIATION FROM TEST STANDARD.....	16
4.1.5	TEST SETUP.....	17
4.1.6	EUT OPERATING CONDITIONS.....	17
4.1.7	TEST RESULTS.....	18
4.1.8	TEST RESULTS.....	20
4.2	RADIATED EMISSION MEASUREMENT.....	22
4.2.1	LIMITS OF RADIATED EMISSION MEASUREMENT.....	22
4.2.2	TEST INSTRUMENTS.....	23
4.2.3	TEST PROCEDURES.....	24
4.2.4	DEVIATION FROM TEST STANDARD.....	24
4.2.5	TEST SETUP.....	25
4.2.6	EUT OPERATING CONDITIONS.....	25
4.2.7	TEST RESULTS.....	26
4.3	6DB BANDWIDTH MEASUREMENT.....	34
4.3.1	LIMITS OF 6DB BANDWIDTH MEASUREMENT.....	34
4.3.2	TEST INSTRUMENTS.....	34
4.3.3	TEST PROCEDURE.....	35
4.3.4	DEVIATION FROM TEST STANDARD.....	35
4.3.5	TEST SETUP.....	35
4.3.6	EUT OPERATING CONDITIONS.....	35
4.3.7	TEST RESULTS (A).....	36
4.3.8	TEST RESULTS (B).....	40
4.4	MAXIMUM PEAK OUTPUT POWER.....	44
4.4.1	LIMITS OF MAXIMUM PEAK OUTPUT POWER MEASUREMENT.....	44
4.4.2	INSTRUMENTS.....	44
4.4.3	TEST PROCEDURES.....	45
4.4.4	TEST SETUP.....	45
4.4.5	EUT OPERATING CONDITIONS.....	45
4.4.6	TEST RESULTS (A).....	46



4.4.7	TEST RESULTS (B).....	46
4.5	POWER SPECTRAL DENSITY MEASUREMENT.....	47
4.5.1	LIMITS OF POWER SPECTRAL DENSITY MEASUREMENT.....	47
4.5.2	TEST INSTRUMENTS.....	47
4.5.3	TEST PROCEDURE	48
4.5.4	DEVIATION FROM TEST STANDARD	48
4.5.5	TEST SETUP.....	48
4.5.6	EUT OPERATING CONDITION.....	48
4.5.7	TEST RESULTS(A).....	49
4.5.8	TEST RESULTS(B).....	53
4.6	BAND EDGES MEASUREMENT	57
4.6.1	LIMITS OF BAND EDGES MEASUREMENT.....	57
4.6.2	TEST INSTRUMENTS.....	57
4.6.3	TEST PROCEDURE	57
4.6.4	DEVIATION FROM TEST STANDARD	57
4.6.5	EUT OPERATING CONDITION.....	58
4.6.6	TEST RESULTS (A).....	58
4.6.7	TEST RESULTS (B).....	61
4.7	ANTENNA REQUIREMENT.....	64
4.7.1	STANDARD APPLICABLE	64
4.7.2	ANTENNA CONNECTED CONSTRUCTION.....	64
5.	TEST TYPES AND RESULTS (FOR PART 802.11A).....	65
5.1	CONDUCTED EMISSION MEASUREMENT.....	65
5.1.1	LIMITS OF CONDUCTED EMISSION MEASUREMENT.....	65
5.1.2	TEST INSTRUMENTS.....	65
5.1.3	TEST PROCEDURES	66
5.1.4	DEVIATION FROM TEST STANDARD	66
5.1.5	TEST SETUP.....	67
5.1.6	EUT OPERATING CONDITIONS	67
5.1.7	TEST RESULTS.....	68
5.2	RADIATED EMISSION MEASUREMENT	76
5.2.1	LIMITS OF RADIATED EMISSION MEASUREMENT.....	76
5.2.2	LIMITS OF UNWANTED EMISSION OUT OF THE RESTRICTED BANDS	77
5.2.3	TEST INSTRUMENTS.....	78
5.2.4	TEST PROCEDURES	79
5.2.5	DEVIATION FROM TEST STANDARD	79
5.2.6	TEST SETUP.....	80
5.2.7	EUT OPERATING CONDITIONS	80
5.2.8	TEST RESULTS.....	81
5.2.9	TEST RESULTS.....	83
5.3	PEAK TRANSMIT POWER MEASUREMENT.....	94
5.3.1	LIMITS OF PEAK TRANSMIT POWER MEASUREMENT.....	94
5.3.2	TEST INSTRUMENTS.....	94
5.3.3	TEST PROCEDURE	95



5.3.4 DEVIATION FROM TEST STANDARD 95

5.3.5 TEST SETUP..... 95

5.3.6 EUT OPERATING CONDITIONS 95

5.3.7 TEST RESULTS..... 96

5.4 PEAK POWER EXCURSION MEASUREMENT..... 120

5.4.1 LIMITS OF PEAK POWER EXCURSION MEASUREMENT..... 120

5.4.2 TEST INSTRUMENTS..... 120

5.4.3 TEST PROCEDURE 121

5.4.4 DEVIATION FROM TEST STANDARD 121

5.4.5 TEST SETUP..... 121

5.4.6 EUT OPERATING CONDITIONS 121

5.4.7 TEST RESULTS..... 122

5.5 PEAK POWER SPECTRAL DENSITY MEASUREMENT..... 135

5.5.1 LIMITS OF PEAK POWER SPECTRAL DENSITY MEASUREMENT..... 135

5.5.2 TEST INSTRUMENTS..... 135

5.5.3 TEST PROCEDURES 136

5.5.4 DEVIATION FROM TEST STANDARD 136

5.5.5 TEST SETUP..... 136

5.5.6 EUT OPERATING CONDITIONS 136

5.5.7 TEST RESULTS..... 137

5.6 FREQUENCY STABILITY 150

5.6.1 LIMITS OF FREQUENCY STABILITY MEASUREMENT..... 150

5.6.2 TEST INSTRUMENTS..... 150

5.6.3 TEST PROCEDURE 150

5.6.4 DEVIATION FROM TEST STANDARD 150

5.6.5 TEST SETUP..... 151

5.6.6 EUT OPERATING CONDITION..... 151

5.6.7 TEST RESULTS..... 152

5.7 BAND EDGES MEASUREMENT 153

5.7.1 TEST INSTRUMENTS..... 153

5.7.2 TEST PROCEDURE 153

5.7.3 EUT OPERATING CONDITION..... 153

5.7.4 TEST RESULTS..... 154

5.8 ANTENNA REQUIREMENT..... 159

5.8.1 STANDARD APPLICABLE 159

5.8.2 ANTENNA CONNECTED CONSTRUCTION..... 159

6. PHOTOGRAPHS OF THE TEST CONFIGURATION..... 160

7. INFORMATION ON THE TESTING LABORATORIES..... 164



1. CERTIFICATION

PRODUCT : EliteConnect Universal 2.4GHz/5GHz Wireless
Access Point

BRAND NAME : SMC

MODEL NO. : SMC2555W-AG

APPLICANT : Accton Technology Corporation

STANDARDS : 47 CFR Part 15, Subpart C (Section 15.247),
Subpart E (Section 15.407), ANSI C63.4-1992

We, **Advance Data Technology Corporation**, hereby certify that one sample of the designation has been tested in our facility from Jul. 27 to 30, 2003. The test record data evaluation and Equipment under Test (EUT) configurations represented herein are true and accurate accounts of the measurements of the sample's EMC characteristics under the conditions herein specified.

PREPARED BY: *Amanda Chu* , **DATE:** *Sep. 12, 2003*
(Amanda Chu)

APPROVED BY: *Eric Lin* , **DATE:** *Sep. 12, 2003*
(Eric Lin, Manager)



2. SUMMARY OF TEST RESULTS

The EUT has been tested according to the following specifications:

APPLIED STANDARD: 47 CFR Part 15, Subpart C			
Standard Section	Test Type and Limit	Result	REMARK
15.207	AC Power Conducted Emission	PASS	Meet the requirement of limit Minimum passing margin is -10.58dBuV at 1.338MHz
15.247(a)(2)	Spectrum Bandwidth of a Direct Sequence Spread Spectrum System Limit: min. 500kHz	PASS	Meet the requirement of limit
15.247(b)	Maximum Peak Output Power Limit: max. 30dBm	PASS	Meet the requirement of limit
15.247(c)	Radiated Emissions Limit: Table 15.209	PASS	Meet the requirement of limit Minimum passing margin is -0.9dBuV at 2390.00 MHz
15.247(d)	Power Spectral Density Limit: max. 8dBm	PASS	Meet the requirement of limit
15.247(c)	Band Edge Measurement Limit: 20dB less than the peak value of fundamental frequency	PASS	Meet the requirement of limit



APPLIED STANDARD: 47 CFR Part 15, Subpart E

Standard Section	Test Type	Result	REMARK
15.407(b)(5)	AC Power Conducted Emission	PASS	Meet the requirement of limit Minimum passing margin is -10.78dBuV at 1.338MHz
15.407(b/1/2/3)(b)(5)	Electric Field Strength Spurious Emissions, 30 MHz – 40000 MHz	PASS	Meet the requirement of limit Minimum passing margin is -1.0dBuV at 5408.00MHz
15.407(a/1/2/3)	Peak Transmit Power	PASS	Meet the requirement of limit
15.407(a)(6)	Peak Power Excursion	PASS	Meet the requirement of limit
15.407(a/1/2/3)	Peak Power Spectral Density	PASS	Meet the requirement of limit
15.407(g)	Frequency Stability	PASS	Meet the requirement of limit



3. GENERAL INFORMATION

3.1 GENERAL DESCRIPTION OF EUT

PRODUCT	EliteConnect Universal 2.4GHz/5GHz Wireless Access Point
MODEL NO.	SMC2555W-AG
POWER SUPPLY	5VDC from AC adapter
MODULATION	DSSS, OFDM
TRANSFER RATE	802.11b and draft 802.11g: 1/2/5.5/6/9/11/12/18/24/36/48/54Mbps 802.11a:6 to 54Mbps (Turbo mode: up to 108Mbps *see note 1)
FREQUENCY RANGE	802.11b and draft 802.11g: 2400MHz ~ 2483.5MHz 802.11a: 5.15~5.35GHz and 5.725~5.825GHz
NUMBER OF CHANNEL	802.11b and draft 802.11g: 11 802.11a: 12 for Normal mode / 5 for Turbo mode
CHANNEL SPACING	802.11b and draft 802.11g: 5MHz 802.11a: 20MHz for Normal mode / 40MHz for Turbo mode
OUTPUT POWER	802.11b: 15.63dBm / draft 802.11g: 16.23dBm 802.11a: 15.57dBm
DATA CABLE	NA
ANTENNA TYPE	Dual-Band Omni-Directional Antenna
I/O PORTS	RJ 45 (POE) Port x 1, Console Port x 1
ASSOCIATED DEVICES	NA

NOTE:

1. This EUT is capable of providing data rates of up to 108Mbps in Turbo Mode depending upon reception quality.



2. There is two antennas provided to this EUT, please refer to the following table:

Model No.
R0322-066(without switch)
R0322-046(with switch)

3. The EUT was powered either adapter or POE (Power Over Ethernet):

Adapter:	
Brand:	DELTA
Model No.:	ADP-15KB REV:C
Input power :	100-240Vac 0.5A 50-60Hz
Output power :	5.1Vdc 3.0A

POE:	
Brand:	3COM
Model No.:	PW130
Input power :	100-250Vac 50-60Hz 500mA
Output power :	48Vdc 420mA
*The POE supplied power to EUT via POE port, only used on testing.	

4. Dual-band, the EUT communicates with Wireless-A (802.11a), Wireless-B, (802.11b), and Wireless-G (draft 802.11g) wireless networks.
5. For more detailed features description, please refer to the manufacturer's specifications or User's Manual.



3.2 DESCRIPTION OF TEST MODES

For 802.11b: Eleven channels are provided to this EUT.

Channel	Frequency	Channel	Frequency
1	2412 MHz	7	2442 MHz
2	2417 MHz	8	2447 MHz
3	2422 MHz	9	2452 MHz
4	2427 MHz	10	2457 MHz
5	2432 MHz	11	2462 MHz
6	2437 MHz		

NOTE:

1. Below 1 GHz, the channel 1, 6, and 11 were pre-tested in chamber. The channel 11, worst case one, was chosen for final test.
2. Above 1 GHz, the channel 1, 6, and 11 were tested individually. The EUT with adapter and with POE were pre-tested in chamber. The EUT with adapter, worst case one, was chosen for final test.
3. Transfer rate, 11Mbps with CCK technique and 6Mbps with OFDM technique, the worst case, were chosen for final test.
4. Test result A is for CCK technique and test result B is for OFDM technique which presented in Section 4.

For 802.11a: Twelve channels are provided to this EUT for Normal mode.

Channel	Frequency	Channel	Frequency
1	5180 MHz	7	5300 MHz
2	5200 MHz	8	5320 MHz
3	5220 MHz	9	5745MHz
4	5240 MHz	10	5765MHz
5	5260 MHz	11	5785MHz
6	5280 MHz	12	5805MHz

Five channels are provided to this EUT for Turbo Mode.

Channel	Frequency	Channel	Frequency
1	5210 MHz	4	5760MHz
2	5250 MHz	5	5800MHz
3	5290 MHz		

NOTE:

- 1..The EUT was tested in both normal mode (channel bandwidth of approximately 30MHz) and turbo mode (channel bandwidth of approximately 60MHz).
2. "Normal Mode" allows data rates of up to 54Mbps. The device was, therefore, tested in Normal mode at the data rate that produced the highest output power for normal mode (6Mbps).
3. "Turbo Mode" allows data rates of up to 108Mbps. At data rates higher than 12Mbps the PA gain is reduced to improve signal fidelity. The device was, therefore, tested in turbo mode at the data rate that produced the highest output power for turbo mode (12Mbps).
4. Channel 1, 4, 5, 8, 9 and 12 are the closest frequencies to the band edge, were chosen for final test of Normal Mode.
5. Channel 1 ~ 5 were chosen for final test of turbo mode.



3.3 GENERAL DESCRIPTION OF APPLIED STANDARDS

The EUT is a EliteConnect Universal 2.4GHz/5GHz Wireless Access Point According to the specifications of the manufacturer, it must comply with the requirements of the following standards:

**47 CFR Part 15, Subpart C. (15.247),
Subpart E (15.407). ANSI C63.4 : 1992**

All tests have been performed and recorded as per the above standards.

NOTE: The EUT is also considered as a kind of computer peripheral, because the connection to computer is necessary for typical use. It has been verified to comply with the requirements of 47CFR Part 15, Subpart B, Class B (DoC). The test report has been issued separately.



3.4 DESCRIPTION OF SUPPORT UNITS

The EUT has been tested as an independent unit together with other necessary accessories or support units. The following support units or accessories were used to form a representative test configuration during the tests.

No.	Product	Brand	Model No.	Serial No.	FCC ID
1	NOTEBOOK	DELL	PP01L	TW-09C748-12800-1A3-1999	FCC DoC

No.	Signal cable description
1	NA

Note: 1. All power cords of the above support units are unshielded (1.8m).

WITH ADAPTER:

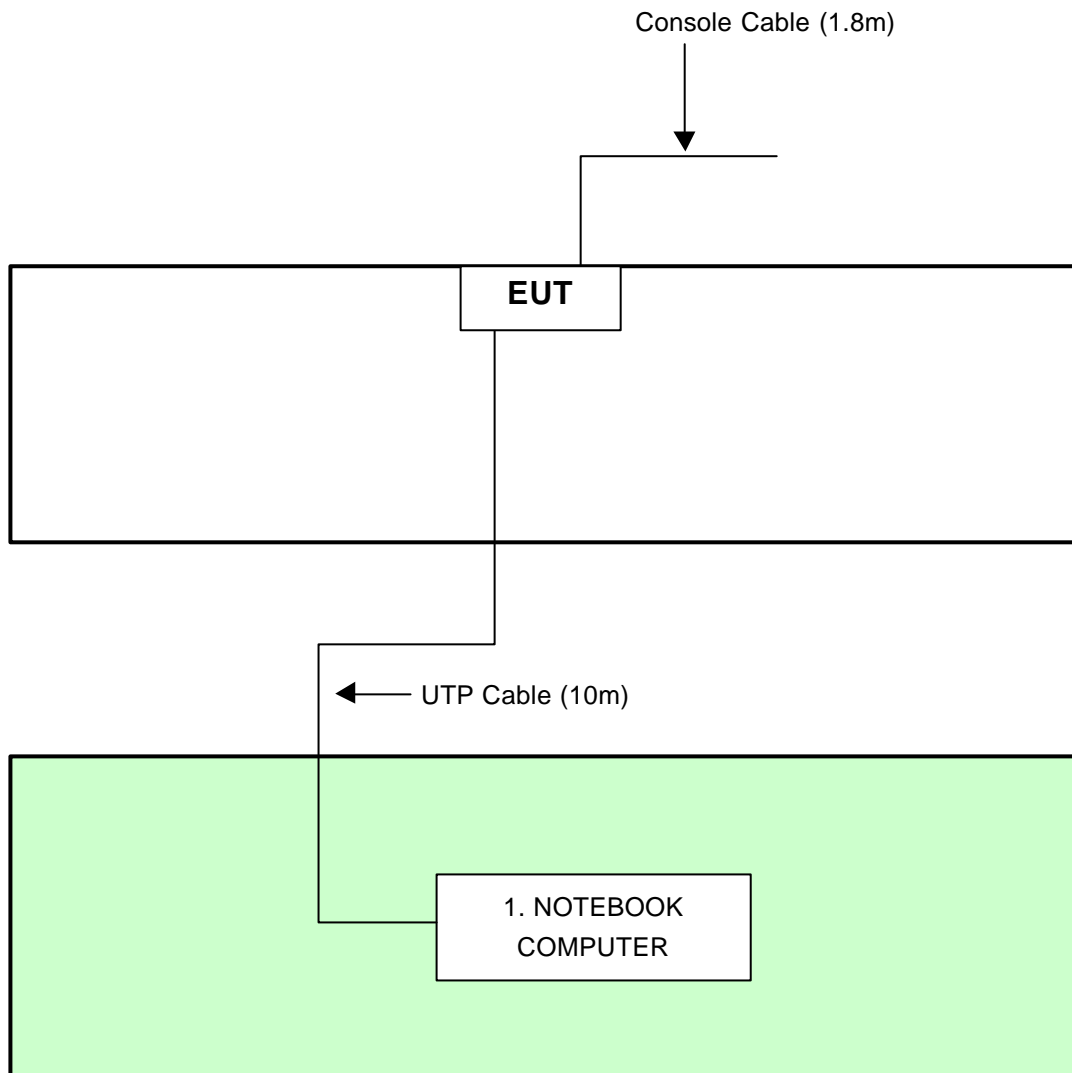

- NOTE:** 1. Support unit 1 was kept in the control room during the test.
2. Please refer to the photos of test configuration in Item 5 also.

WITH POE:

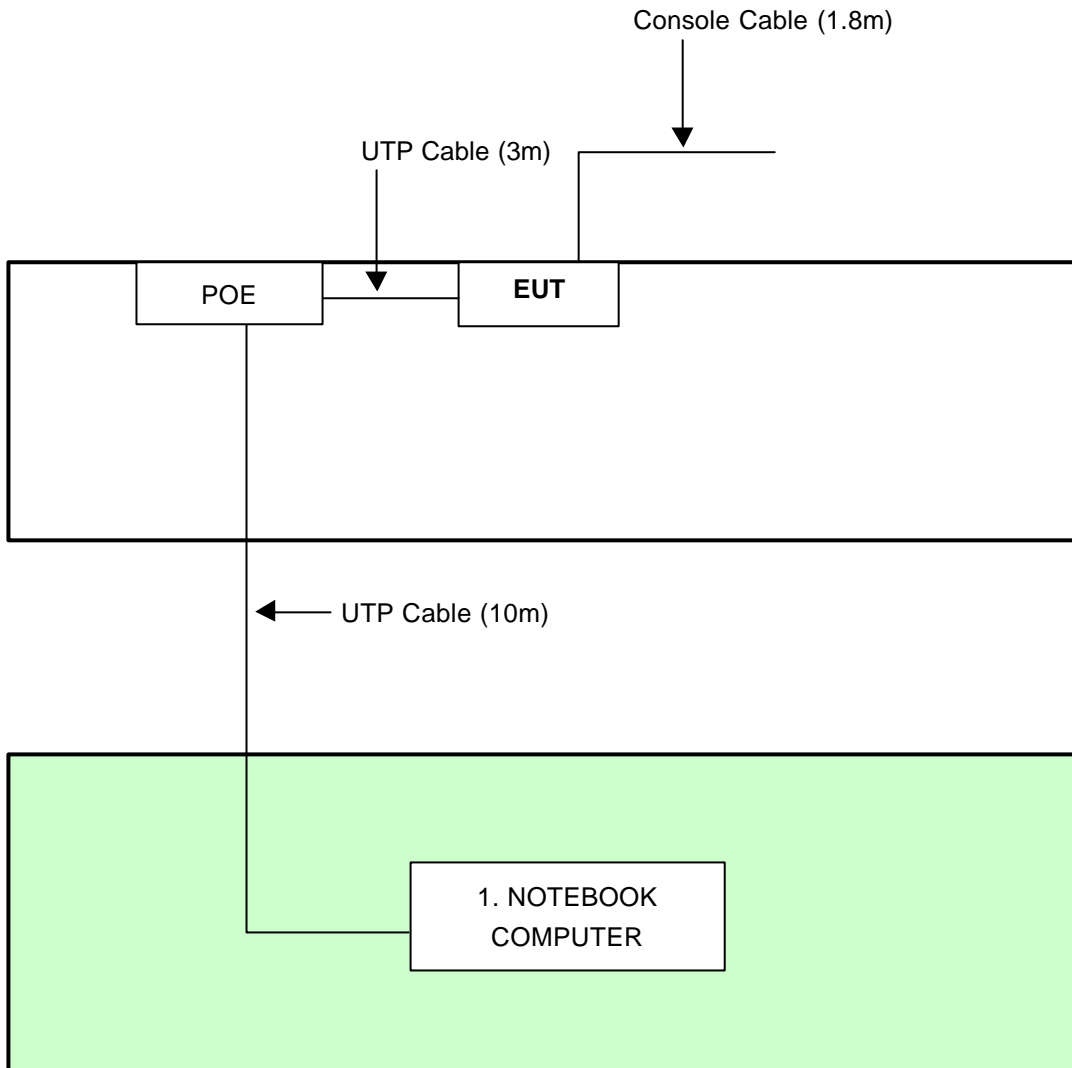

- NOTE:**
- 1. Support unit 1 was kept in the control room during the test.
 - 2. Please refer to the photos of test configuration in Item 5 also.



4. TEST TYPES AND RESULTS (FOR PART 802.11b)

4.1 CONDUCTED EMISSION MEASUREMENT

4.1.1 LIMITS OF CONDUCTED EMISSION MEASUREMENT

FREQUENCY OF EMISSION (MHz)	CONDUCTED LIMIT (dB μ V)	
	Quasi-peak	Average
0.15-0.5	66 to 56	56 to 46
0.5-5	56	46
5-30	60	50

- NOTE:**
1. The lower limit shall apply at the transition frequencies.
 2. The limit decreases in line with the logarithm of the frequency in the range of 0.15 to 0.50 MHz.
 3. All emanations from a class A/B digital device or system, including any network of conductors and apparatus connected thereto, shall not exceed the level of field strengths specified above.

4.1.2 TEST INSTRUMENTS

DESCRIPTION & MANUFACTURER	MODEL NO.	SERIAL NO.	CALIBRATED UNTIL
ROHDE & SCHWARZ Test Receiver	ESCS 30	847124/029	Nov. 17, 2003
ROHDE & SCHWARZ LISN (for EUT)	ESHS-Z5	848773/004	Nov. 13, 2003
KYORITSU LISN (for peripheral)	KNW-407	8/1395/12	Jul. 23, 2004
RF Cable (JETBAO)	RG233/U	Cable_CA_01	Jul. 03, 2004
Terminator(for KYORITSU)	50	3	Apr. 11, 2004
Software	Cond-V2e	NA	NA

- NOTE:**
1. The calibration interval of the above test instruments is 12 months and the calibrations are traceable to NML/ROC and NIST/USA.
 2. The test was performed in ADT Shielded Room No. A.
 3. The VCCI Con A Registration No. is C-817.



4.1.3 TEST PROCEDURES

- a. The EUT was placed 0.4 meters from the conducting wall of the shielded room with EUT being connected to the power mains through a line impedance stabilization network (LISN). Other support units were connected to the power mains through another LISN. The two LISNs provide 50 ohm/ 50uH of coupling impedance for the measuring instrument.
- b. Both lines of the power mains connected to the EUT were checked for maximum conducted interference.
- c. The frequency range from 150 kHz to 30 MHz was searched. Emission levels over 10dB under the prescribed limits could not be reported

4.1.4 DEVIATION FROM TEST STANDARD

No deviation

4.1.5 TEST SETUP

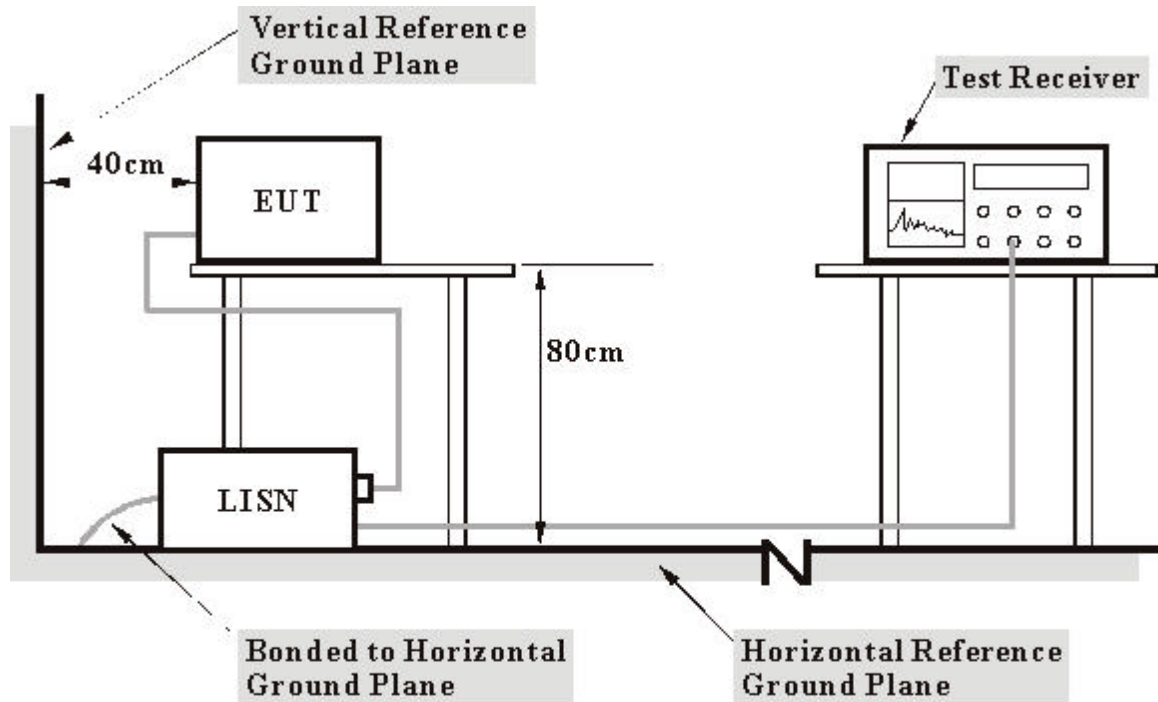

- Note:**
1. Support units were connected to second LISN.
 2. Both of LISNs (AMN) 80 cm from EUT and at the least 80 cm from other units and other metal planes support units.

For the actual test configuration, please refer to the related item – Photographs of the Test Configuration.

4.1.6 EUT OPERATING CONDITIONS

- a. Placed the EUT on the testing table.
- b. Prepared another computer system to act as a communication partner and placed it outside of testing area.
- c. The communication partner run a test program to enable EUT under transmission/receiving condition continuously at specific channel frequency via RJ 45 cable and wireless.
- d. The communication partner sent data to EUT by command "PING".



4.1.7 TEST RESULTS

EUT	EliteConnect Universal 2.4GHz/5GHz Wireless Access Point	MODEL	SMC2555W-AG
MODE	With Adapter, Channel 11	6dB BANDWIDTH	9 kHz
INPUT POWER (SYSTEM)	120Vac, 60Hz	PHASE	Line (L)
ENVIRONMENTAL CONDITIONS	27deg. C, 69%RH, 976 hPa	TESTED BY	Lary Peng

No	Freq. [MHz]	Corr. Factor (dB)	Reading Value [dB (uV)]		Emission Level [dB (uV)]		Limit [dB (uV)]		Margin (dB)	
			Q.P.	AV.	Q.P.	AV.	Q.P.	AV.	Q.P.	AV.
1	0.150	0.20	50.03	-	50.23	-	66.00	56.00	-15.77	-
2	0.244	0.20	39.66	-	39.86	-	61.97	51.97	-22.11	-
3	1.232	0.30	32.71	-	33.01	-	56.00	46.00	-22.99	-
4	2.576	0.33	20.91	-	21.24	-	56.00	46.00	-34.76	-
5	10.852	0.85	36.81	-	37.66	-	60.00	50.00	-22.34	-
6	15.715	1.11	45.53	-	46.64	-	60.00	50.00	-13.36	-

- NOTES: (1) "-": Undetectable
 (2) Q.P. and AV. are abbreviations of quasi-peak and average.
 (3) "-": The Quasi-peak reading value also meets an average limit, thus measurement with the average detector is unnecessary.
 (4) The emission levels of other frequencies were very low against the limit.
 (5) Correction Factor = Insertion loss + Cable loss
 (6) Margin value = Emission level - Limit value

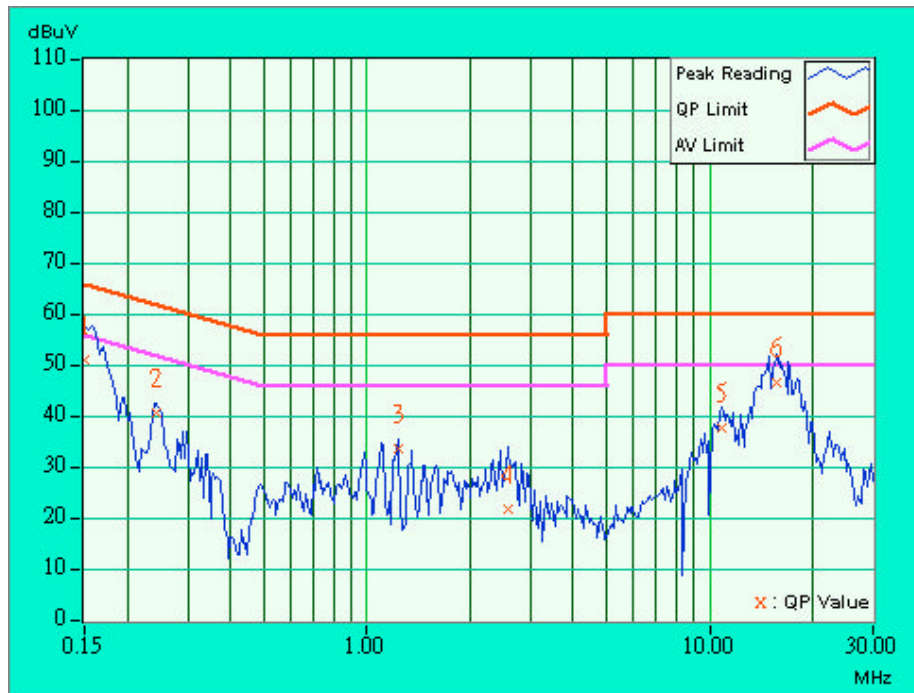



EUT	EliteConnect Universal 2.4GHz/5GHz Wireless Access Point	MODEL	SMC2555W-AG
MODE	With Adapter, Channel 11	6dB BANDWIDTH	9 kHz
INPUT POWER (SYSTEM)	120Vac, 60Hz	PHASE	Neutral (N)
ENVIRONMENTAL CONDITIONS	27deg. C, 69%RH, 976 hPa	TESTED BY	Lary Peng

No	Freq. [MHz]	Corr. Factor (dB)	Reading Value [dB (uV)]		Emission Level [dB (uV)]		Limit [dB (uV)]		Margin (dB)	
			Q.P.	AV.	Q.P.	AV.	Q.P.	AV.	Q.P.	AV.
			1	0.150	0.20	49.97	-	50.17	-	66.00
2	0.240	0.20	40.06	-	40.26	-	62.10	52.10	-21.84	-
3	1.220	0.30	32.45	-	32.75	-	56.00	46.00	-23.25	-
4	11.105	0.74	37.36	-	38.10	-	60.00	50.00	-21.90	-
5	15.441	0.90	45.93	-	46.83	-	60.00	50.00	-13.17	-
6	23.023	0.96	29.50	-	30.46	-	60.00	50.00	-29.54	-

- NOTES: (1) "-": Undetectable
 (2) Q.P. and AV. are abbreviations of quasi-peak and average.
 (3) "-": The Quasi-peak reading value also meets an average limit, thus measurement with the average detector is unnecessary.
 (4) The emission levels of other frequencies were very low against the limit.
 (5) Correction Factor = Insertion loss + Cable loss
 (6) Margin value = Emission level - Limit value

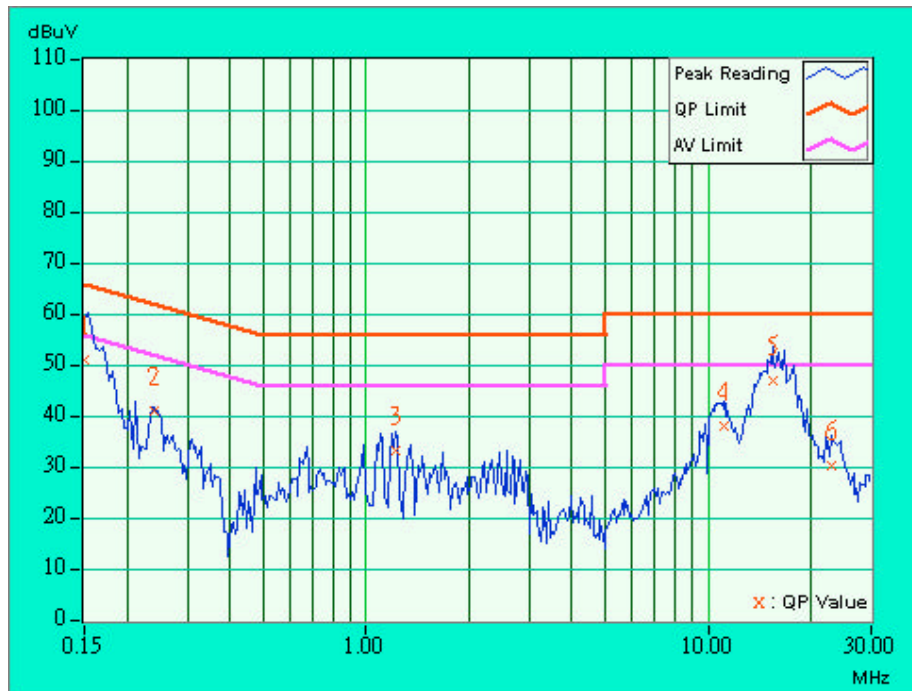



4.1.8 TEST RESULTS

EUT	EliteConnect Universal 2.4GHz/5GHz Wireless Access Point	MODEL	SMC2555W-AG
MODE	With POE, Channel 11	6dB BANDWIDTH	9 kHz
INPUT POWER (SYSTEM)	120Vac, 60Hz	PHASE	Line (L)
ENVIRONMENTAL CONDITIONS	27deg. C, 69%RH, 976 hPa	TESTED BY	Lary Peng

No	Freq. [MHz]	Corr. Factor (dB)	Reading Value [dB (uV)]		Emission Level [dB (uV)]		Limit [dB (uV)]		Margin (dB)	
			Q.P.	AV.	Q.P.	AV.	Q.P.	AV.	Q.P.	AV.
			1	0.158	0.20	52.78	-	52.98	-	65.58
2	0.670	0.24	40.31	-	40.55	-	56.00	46.00	-15.45	-
3	1.338	0.30	45.12	-	45.42	-	56.00	46.00	-10.58	-
4	1.673	0.30	42.80	-	43.10	-	56.00	46.00	-12.90	-
5	9.473	0.76	44.31	-	45.07	-	60.00	50.00	-14.93	-
6	14.570	1.07	48.25	-	49.32	-	60.00	50.00	-10.68	-

- NOTES: (1) "-": Undetectable
 (2) Q.P. and AV. are abbreviations of quasi-peak and average.
 (3) "-": The Quasi-peak reading value also meets an average limit, thus measurement with the average detector is unnecessary.
 (4) The emission levels of other frequencies were very low against the limit.
 (5) Correction Factor = Insertion loss + Cable loss
 (6) Margin value = Emission level - Limit value

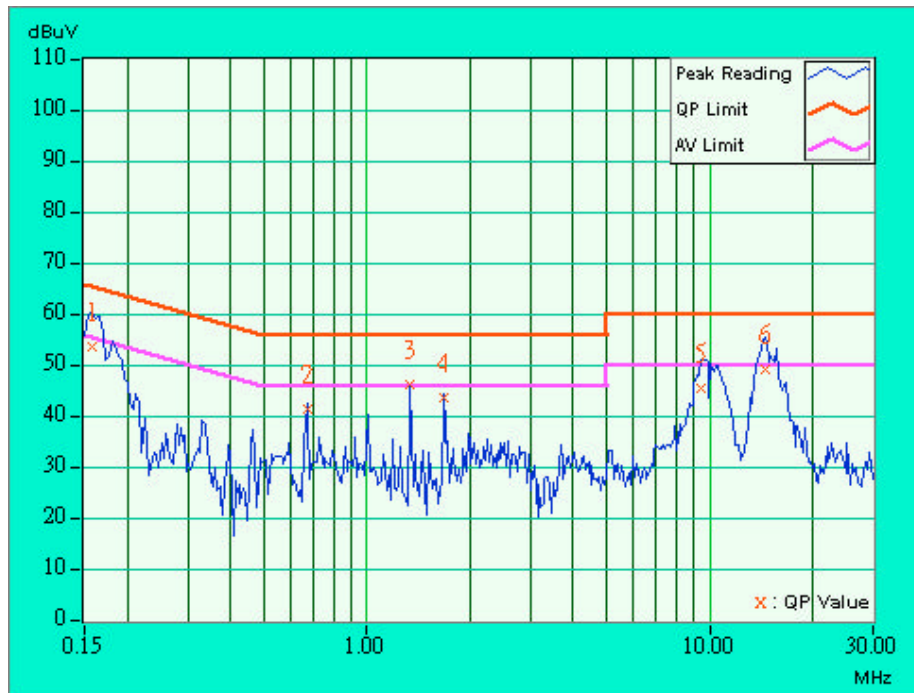



EUT	EliteConnect Universal 2.4GHz/5GHz Wireless Access Point	MODEL	SMC2555W-AG
MODE	With POE, Channel 11	6dB BANDWIDTH	9 kHz
INPUT POWER (SYSTEM)	120Vac, 60Hz	PHASE	Neutral (N)
ENVIRONMENTAL CONDITIONS	27deg. C, 69%RH, 976 hPa	TESTED BY	Lary Peng

No	Freq. [MHz]	Corr. Factor (dB)	Reading Value [dB (uV)]		Emission Level [dB (uV)]		Limit [dB (uV)]		Margin (dB)	
			Q.P.	AV.	Q.P.	AV.	Q.P.	AV.	Q.P.	AV.
			1	0.158	0.20	52.77	-	52.97	-	65.58
2	0.666	0.24	38.11	-	38.35	-	56.00	46.00	-17.65	-
3	1.338	0.30	44.81	-	45.11	-	56.00	46.00	-10.89	-
4	1.673	0.30	42.54	-	42.84	-	56.00	46.00	-13.16	-
5	9.676	0.68	45.71	-	46.39	-	60.00	50.00	-13.61	-
6	14.727	0.89	48.21	-	49.10	-	60.00	50.00	-10.90	-

- NOTES: (1) "-": Undetectable
 (2) Q.P. and AV. are abbreviations of quasi-peak and average.
 (3) "-": The Quasi-peak reading value also meets an average limit, thus measurement with the average detector is unnecessary.
 (4) The emission levels of other frequencies were very low against the limit.
 (5) Correction Factor = Insertion loss + Cable loss
 (6) Margin value = Emission level - Limit value

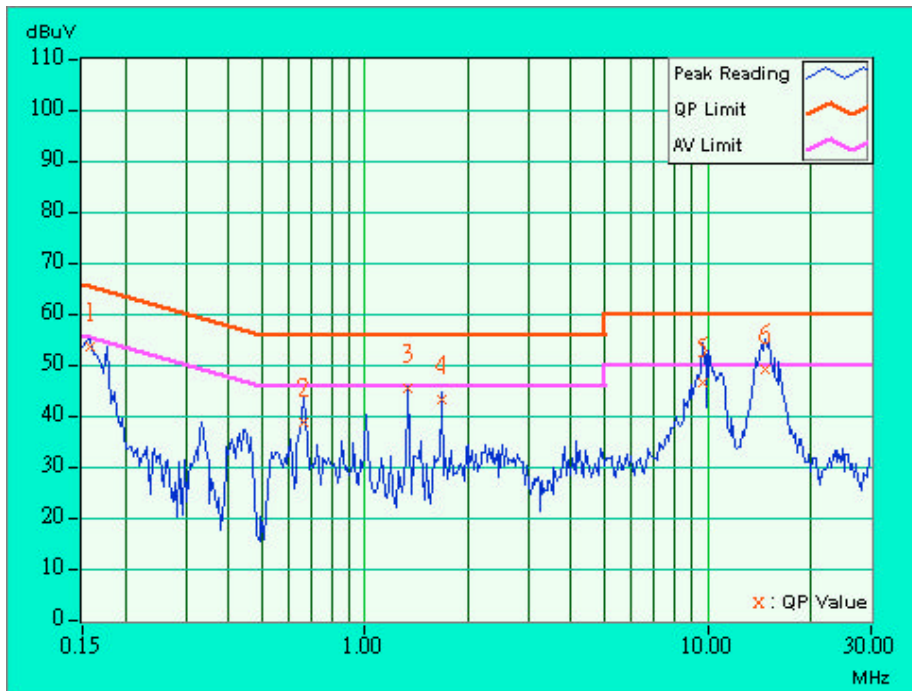



4.2 RADIATED EMISSION MEASUREMENT

4.2.1 LIMITS OF RADIATED EMISSION MEASUREMENT

Emissions radiated outside of the specified bands, shall be according to the general radiated limits in 15.209 as following:

Frequencies (MHz)	Field strength (microvolts/meter)	Measurement distance (meters)
0.009-0.490	2400/F(kHz)	300
0.490-1.705	24000/F(kHz)	30
1.705-30.0	30	30
30-88	100	3
88-216	150	3
216-960	200	3
Above 960	500	3

NOTE:

1. The lower limit shall apply at the transition frequencies.
2. Emission level (dBuV/m) = 20 log Emission level (uV/m).
3. As shown in 15.35(b), for frequencies above 1000MHz, the field strength limits are based on average detector, however, the peak field strength of any emission shall not exceed the maximum permitted average limits, specified above by more than 20dB under any condition of modulation.



4.2.2 TEST INSTRUMENTS

DESCRIPTION & MANUFACTURER	MODEL NO.	SERIAL NO.	CALIBRATED UNTIL
HP Spectrum Analyzer	8594ER	3829U04676	Jul. 14, 2004
ADVANTEST Spectrum Analyzer	R3271A	85060311	May 21, 2004
CHASE RF Pre_Amplifier	CPA9232	1057	Apr. 24, 2004
HP Pre_Amplifier	8449B	3008A01281	June 27, 2004
ROHDE & SCHWARZ Test Receiver	ESVS 10	849231 /019	Nov. 03, 2003
CHASE Broadband Antenna	CBL6111c	2730	Jul 17, 2004
Schwarzbeck Horn_Antenna	3115	5619	Jul. 17, 2004
SCHWARZBECK Tunable Dipole Antenna	UHAP	897	Mar. 07, 2005
SCHWARZBECK Tunable Dipole Antenna	VHAP	880	Mar. 07, 2005
RF Switches (ARNITSU)	CS-201	1565157	Dec. 01, 2003
RF CABLE (Chaintek) 1GHz-20GHz	SF102	22054-2	Feb. 10. 2004
RF Cable(RICHTEC)	9913-30M	STCCAB-30M- 1GHz-021	Nov. 5, 2003
Software	AS60P8	NA	NA
CHANCE MOST Antenna Tower	AT-100	0203	NA
CHANCE MOST Turn Table	TT-100	0203	NA

Note: 1. The calibration interval of the above test instruments is 12 months (36 months for Tunable Dipole Antenna) and the calibrations are traceable to NML/ROC and NIST/USA.

2. * = These equipment are used for the final measurement.
3. The horn antenna and HP preamplifier (model: 8449B) are used only for the measurement of emission frequency above 1GHz if tested.
4. The test was performed in ADT Open Site No. C.
5. The FCC Site Registration No. is 656396.
6. The VCCI Site Registration No. is R-1626.
7. The CANADA Site Registration No. is IC 3789-C.



4.2.3 TEST PROCEDURES

- a. The EUT was placed on the top of a rotating table 0.8 meters above the ground at a 10 meter open area test site. The table was rotated 360 degrees to determine the position of the highest radiation.
- b. The EUT was set 3 meters away from the interference-receiving antenna, which was mounted on the top of a variable-height antenna tower.
- c. The antenna is a broadband antenna, and its height is varied from one meter to four meters above the ground to determine the maximum value of the field strength. Both horizontal and vertical polarizations of the antenna are set to make the measurement.
- d. For each suspected emission, the EUT was arranged to its worst case and then the antenna was tuned to heights from 1 meter to 4 meters and the rotatable table was turned from 0 degrees to 360 degrees to find the maximum reading.
- e. The test-receiver system was set to Peak Detect Function and Specified Bandwidth with Maximum Hold Mode.
- f. If the emission level of the EUT in peak mode was 10 dB lower than the limit specified, then testing could be stopped and the peak values of the EUT would be reported. Otherwise the emissions that did not have 10 dB margin would be re-tested one by one using the quasi-peak method or average method as specified and then reported in Data sheet peak mode and QP mode.

NOTE:

1. The resolution bandwidth and video bandwidth of test receiver/spectrum analyzer is 120kHz for Quasi-peak detection at frequency below 1GHz.
2. The resolution bandwidth and video bandwidth of test receiver/spectrum analyzer is 1 MHz for Peak detection (PK) at frequency above 1GHz.
3. The resolution bandwidth of test receiver/spectrum analyzer is 1 MHz and the video bandwidth is 300 Hz for Average detection (AV) at frequency above 1GHz.

4.2.4 DEVIATION FROM TEST STANDARD

No deviation

4.2.5 TEST SETUP

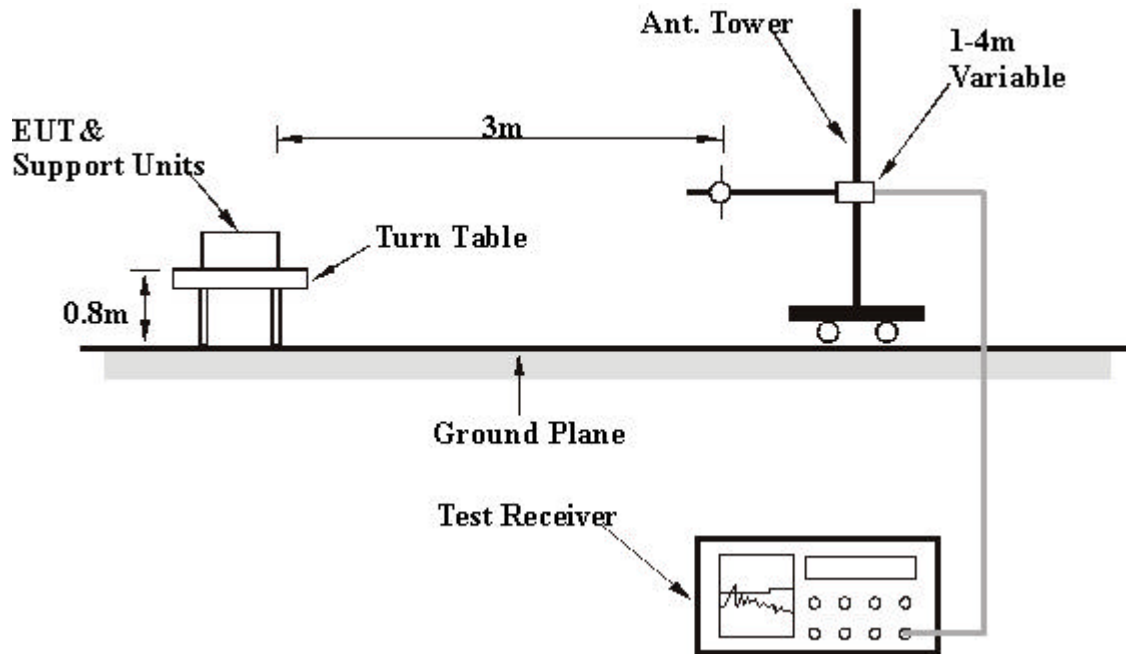

For the actual test configuration, please refer to the related item – Photographs of the Test Configuration.

4.2.6 EUT OPERATING CONDITIONS

Same as 4.1.6



4.2.7 TEST RESULTS

EUT	EliteConnect Universal 2.4GHz/5GHz Wireless Access Point	MODEL	SMC2555W-AG
MODE	With Adapter, Channel 11	FREQUENCY RANGE	Below 1000 MHz
INPUT POWER (SYSTEM)	120Vac, 60Hz	DETECTOR FUNCTION	Quasi-Peak
ENVIRONMENTAL CONDITIONS	29deg. C, 56%RH, 976 hPa	TESTED BY	Eric Lee

ANTENNA POLARITY & TEST DISTANCE: HORIZONTAL AT 3 M

No.	Freq. (MHz)	Emission Level (dBuV/m)	Limit (dBuV/m)	Margin (dB)	Antenna Height (m)	Table Angle (Degree)	Raw Value (dBuV)	Correction Factor (dB/m)
1	40.36	29.9 QP	40.00	-10.10	1.58 H	54	16.30	13.60
2	45.60	24.1 QP	40.00	-15.90	1.06 H	35	13.20	10.90
3	125.12	25.9 QP	43.50	-17.60	1.54 H	356	13.90	12.00
4	220.23	28.0 QP	46.00	-18.00	1.82 H	9	18.60	9.40
5	250.00	29.3 QP	46.00	-16.70	1.28 H	193	16.30	13.00
6	351.56	30.8 QP	46.00	-15.20	1.29 H	99	15.30	15.50
7	375.00	29.2 QP	46.00	-16.80	1.01 H	152	13.00	16.20
8	395.89	37.6 QP	46.00	-8.40	1.22 H	56	20.60	17.00
9	480.00	30.9 QP	46.00	-15.10	1.45 H	30	12.00	18.90
10	499.93	33.9 QP	46.00	-12.10	1.96 H	356	14.60	19.30
11	528.30	41.7 QP	46.00	-4.30	1.87 H	58	22.10	19.60
12	625.20	32.0 QP	46.00	-14.00	1.20 H	58	10.30	21.70

ANTENNA POLARITY & TEST DISTANCE: VERTICAL AT 3 M

No.	Freq. (MHz)	Emission Level (dBuV/m)	Limit (dBuV/m)	Margin (dB)	Antenna Height (m)	Table Angle (Degree)	Raw Value (dBuV)	Correction Factor (dB/m)
1	46.20	26.9 QP	40.00	-13.10	1.58 V	54	16.30	10.60
2	60.23	28.7 QP	40.00	-11.30	1.05 V	349	23.50	5.20
3	70.24	23.9 QP	40.00	-16.10	1.18 V	7	18.00	5.90
4	125.02	32.9 QP	43.50	-10.60	1.35 V	66	20.90	12.00
5	220.30	29.7 QP	46.00	-16.30	1.69 V	356	20.30	9.40
6	250.21	29.2 QP	46.00	-16.80	1.57 V	89	16.20	13.00
7	308.12	25.6 QP	46.00	-20.40	1.52 V	3	11.30	14.30
8	352.00	30.5 QP	46.00	-15.50	1.25 V	119	15.00	15.50
9	375.00	30.2 QP	46.00	-15.80	1.47 V	8	14.00	16.20
10	396.11	32.9 QP	46.00	-13.10	1.40 V	267	15.90	17.00
11	500.00	35.3 QP	46.00	-10.70	1.74 V	58	16.00	19.30
12	528.36	41.2 QP	46.00	-4.80	1.01 V	58	21.60	19.60

- REMARKS:**
1. Emission level(dBuV/m)=Raw Value(dBuV) + Correction Factor(dB)
 2. Correction Factor(dB/m) = Antenna Factor (dB/m) + Cable Factor (dB)
 3. The other emission levels were very low against the limit.
 4. Margin value = Emission level – Limit value.
 5. The limit value is defined as per 15.247



EUT	EliteConnect Universal 2.4GHz/5GHz Wireless Access Point	MODEL	SMC2555W-AG
MODE	With POE, Channel 11	FREQUENCY RANGE	Below 1000 MHz
INPUT POWER (SYSTEM)	120Vac, 60Hz	DETECTOR FUNCTION	Quasi-Peak
ENVIRONMENTAL CONDITIONS	29deg. C, 56%RH, 976 hPa	TESTED BY	Eric Lee

ANTENNA POLARITY & TEST DISTANCE: HORIZONTAL AT 3 M

No.	Freq. (MHz)	Emission Level (dBuV/m)	Limit (dBuV/m)	Margin (dB)	Antenna Height (m)	Table Angle (Degree)	Raw Value (dBuV)	Correction Factor (dB/m)
1	52.00	24.9 QP	40.00	-15.10	2.17 H	25	17.30	7.60
2	60.25	22.1 QP	40.00	-17.90	1.68 H	0	16.90	5.20
3	124.95	25.4 QP	43.50	-18.10	1.13 H	169	13.30	12.00
4	220.16	24.8 QP	46.00	-21.20	1.00 H	42	15.30	9.40
5	249.85	27.6 QP	46.00	-18.40	1.42 H	199	14.60	13.00
6	264.49	32.9 QP	46.00	-13.10	1.39 H	68	18.90	14.00
7	351.63	29.4 QP	46.00	-16.60	1.07 H	190	13.90	15.50
8	374.98	31.8 QP	46.00	-14.20	1.10 H	140	15.60	16.20
9	500.13	33.4 QP	46.00	-12.60	1.35 H	29	14.10	19.30
10	527.53	39.0 QP	46.00	-7.00	1.84 H	323	19.40	19.60

ANTENNA POLARITY & TEST DISTANCE: VERTICAL AT 3 M

No.	Freq. (MHz)	Emission Level (dBuV/m)	Limit (dBuV/m)	Margin (dB)	Antenna Height (m)	Table Angle (Degree)	Raw Value (dBuV)	Correction Factor (dB/m)
1	50.50	32.4 QP	40.00	-7.60	1.48 V	229	24.10	8.30
2	56.13	30.4 QP	40.00	-9.60	1.25 V	161	24.10	6.40
3	69.01	36.7 QP	40.00	-3.30	1.61 V	345	31.00	5.80
4	71.10	32.8 QP	40.00	-7.20	1.66 V	119	26.70	6.10
5	124.96	26.6 QP	43.50	-16.90	1.02 V	25	14.60	12.00
6	250.02	27.0 QP	46.00	-19.00	1.00 V	12	14.00	13.00
7	264.45	28.1 QP	46.00	-17.90	1.36 V	37	14.00	14.00
8	374.72	32.2 QP	46.00	-13.80	1.00 V	351	16.00	16.20
9	396.33	33.1 QP	46.00	-12.90	1.43 V	344	16.10	17.00
10	500.23	33.9 QP	46.00	-12.10	1.38 V	37	14.60	19.30
11	527.52	39.9 QP	46.00	-6.10	1.50 V	174	20.30	19.60
12	625.37	32.6 QP	46.00	-13.40	1.14 V	27	10.90	21.70

- REMARKS:**
1. Emission level(dBuV/m)=Raw Value(dBuV) + Correction Factor(dB)
 2. Correction Factor(dB/m) = Antenna Factor (dB/m) + Cable Factor (dB)
 3. The other emission levels were very low against the limit.
 4. Margin value = Emission level – Limit value.
 5. The limit value is defined as per 15.247.



TEST RESULTS (A)- DSSS

EUT	EliteConnect Universal 2.4GHz/5GHz Wireless Access Point	MODEL	SMC2555W-AG
MODE	Channel 1	FREQUENCY RANGE	1000MHz~24835MHz
INPUT POWER (SYSTEM)	120Vac, 60Hz	DETECTOR FUNCTION	Peak(PK) Average (AV)
ENVIRONMENTAL CONDITIONS	17deg. C, 68%RH, 976 hPa	TESTED BY	Eric Lee

ANTENNA POLARITY & TEST DISTANCE: HORIZONTAL AT 3 M

No.	Freq. (MHz)	Emission Level (dBuV/m)	Limit (dBuV/m)	Margin (dB)	Antenna Height (m)	Table Angle (Degree)	Raw Value (dBuV)	Correction Factor (dB/m)
1	2368.00	53.9 PK	74.00	-20.10	1.03 H	25	24.20	29.70
1	2368.00	41.9 AV	54.00	-12.10	1.03 H	25	12.20	29.70
2	2390.00	54.4 PK	74.00	-19.60	1.08 H	333	24.60	29.80
2	2390.00	45.5 AV	54.00	-8.50	1.08 H	333	15.70	29.80
3	*2412.00	100.2 PK			1.56 H	132	70.30	29.90
3	*2412.00	93.9 AV			1.56 H	132	64.00	29.90
4	4824.00	39.6 PK	74.00	-34.40	1.02 H	25	3.30	36.20
4	4824.00	28.6 AV	54.00	-25.40	1.02 H	25	3.30	36.20
5	7236.00	45.9 PK	74.00	-28.10	1.45 H	21	4.20	41.70
5	7236.00	35.9 AV	54.00	-18.10	1.45 H	21	4.20	41.70
6	9648.00	46.4 PK	74.00	-27.60	1.44 H	101	1.50	44.90
6	9648.00	36.9 AV	54.00	-17.10	1.44 H	101	1.50	44.90

ANTENNA POLARITY & TEST DISTANCE: VERTICAL AT 3 M

No.	Freq. (MHz)	Emission Level (dBuV/m)	Limit (dBuV/m)	Margin (dB)	Antenna Height (m)	Table Angle (Degree)	Raw Value (dBuV)	Correction Factor (dB/m)
1	2368.00	59.9 PK	74.00	-14.10	1.14 V	304	30.20	29.70
1	2368.00	50.5 AV	54.00	-3.50	1.14 V	304	20.80	29.70
2	2390.00	61.2 PK	74.00	-12.80	1.40 V	25	31.40	29.80
2	2390.00	53.1 AV	54.00	-0.90	1.40 V	25	23.30	29.80
3	*2412.00	107.9 PK			1.03 V	32	78.00	29.90
3	*2412.00	100.8 AV			1.03 V	32	70.90	29.90
4	4824.00	42.9 PK	74.00	-31.10	1.02 V	65	6.60	36.20
4	4824.00	30.8 AV	54.00	-23.20	1.02 V	65	6.60	36.20
5	7236.00	49.3 PK	74.00	-24.70	1.87 V	54	7.70	41.70
5	7236.00	38.3 AV	54.00	-15.70	1.87 V	54	7.70	41.70
6	9648.00	51.1 PK	74.00	-22.90	1.64 V	319	6.20	44.90
6	9648.00	40.5 AV	54.00	-13.50	1.64 V	319	-4.40	36.20

- NOTE:**
1. Emission level = Raw Value - Correction Factor
 2. Correction Factor = External Preamp. Gain - Ant. Factor - Cable loss
(External Preamp. Gain = 0, when the test receiver is used for the test.)
 3. The other emission levels were very low against the limit.
 4. Margin value = Emission level - Limit value
 5. The limit value is defined as per 15.247
 6. " * " : Fundamental frequency



EUT	EliteConnect Universal 2.4GHz/5GHz Wireless Access Point	MODEL	SMC2555W-AG
MODE	Channel 6	FREQUENCY RANGE	1000MHz~24835MHz
INPUT POWER (SYSTEM)	120Vac, 60Hz	DETECTOR FUNCTION	Peak(PK) Average (AV)
ENVIRONMENTAL CONDITIONS	17deg. C, 68%RH, 976 hPa	TESTED BY	Eric Lee

ANTENNA POLARITY & TEST DISTANCE: HORIZONTAL AT 3 M								
No.	Freq. (MHz)	Emission Level (dBuV/m)	Limit (dBuV/m)	Margin (dB)	Antenna Height (m)	Table Angle (Degree)	Raw Value (dBuV)	Correction Factor (dB/m)
1	2390.00	55.1 PK	74.00	-18.90	1.26 H	35	25.30	29.80
1	2390.00	40.0 AV	54.00	-14.00	1.26 H	35	10.20	29.80
2	*2437.00	101.3 PK			1.04 H	54	71.30	30.00
2	*2437.00	94.0 AV			1.04 H	54	64.00	30.00
3	2483.50	55.3 PK	74.00	-18.70	1.04 H	24	25.20	30.10
3	2483.50	40.4 AV	54.00	-13.60	1.04 H	24	10.20	30.10
4	4874.00	39.9 PK	74.00	-34.10	1.46 H	321	3.50	36.50
4	4874.00	28.6 AV	54.00	-25.40	1.46 H	321	3.50	36.50
5	7311.00	46.1 PK	74.00	-27.90	4.00 H	32	4.30	41.80
5	7311.00	36.1 AV	54.00	-17.90	4.00 H	32	4.30	41.80
6	9748.00	47.8 PK	74.00	-26.20	1.08 H	321	3.20	44.60
6	9748.00	36.8 AV	54.00	-17.20	1.08 H	321	3.20	44.60

ANTENNA POLARITY & TEST DISTANCE: VERTICAL AT 3 M								
No.	Freq. (MHz)	Emission Level (dBuV/m)	Limit (dBuV/m)	Margin (dB)	Antenna Height (m)	Table Angle (Degree)	Raw Value (dBuV)	Correction Factor (dB/m)
1	2390.00	56.7 PK	74.00	-17.30	1.54 V	26	26.90	29.80
1	2390.00	46.1 AV	54.00	-7.90	1.54 V	26	16.30	29.80
2	*2437.00	107.4 PK			1.63 V	9	77.40	30.00
2	*2437.00	101.3 AV			1.63 V	9	71.30	30.00
3	2483.50	58.4 PK	74.00	-15.60	1.43 V	20	28.30	30.10
3	2483.50	45.3 AV	54.00	-8.70	1.43 V	20	15.20	30.10
4	4874.00	43.5 PK	74.00	-30.50	1.40 V	214	7.00	36.50
4	4874.00	32.6 AV	54.00	-21.40	1.40 V	214	7.00	36.50
5	7311.00	48.4 PK	74.00	-25.60	1.65 V	35	6.70	41.80
5	7311.00	38.4 AV	54.00	-13.20	1.65 V	35	6.70	41.80
6	9748.00	53.6 PK	74.00	-20.40	1.76 V	34	8.90	44.60
6	9748.00	40.8 AV	54.00	-13.20	1.76 V	34	-3.90	36.50

- NOTE:**
1. Emission level = Raw Value - Correction Factor
 2. Correction Factor = External Preamp. Gain - Ant. Factor - Cable loss
(External Preamp. Gain = 0, when the test receiver is used for the test.)
 3. The other emission levels were very low against the limit.
 4. Margin value = Emission level - Limit value
 5. The limit value is defined as per 15.247
 6. " * " : Fundamental frequency



EUT	EliteConnect Universal 2.4GHz/5GHz Wireless Access Point	MODEL	SMC2555W-AG
MODE	Channel 11	FREQUENCY RANGE	1000MHz~24835MHz
INPUT POWER (SYSTEM)	120Vac, 60Hz	DETECTOR FUNCTION	Peak(PK) Average (AV)
ENVIRONMENTAL CONDITIONS	17deg. C, 68%RH, 976 hPa	TESTED BY	Eric Lee

ANTENNA POLARITY & TEST DISTANCE: HORIZONTAL AT 3M								
No.	Freq. (MHz)	Emission Level (dBuV/m)	Limit (dBuV/m)	Margin (dB)	Antenna Height (m)	Table Angle (Degree)	Raw Value (dBuV)	Correction Factor (dB/m)
1	*2462.00	100.2 PK			1.04 H	25	70.10	30.10
1	*2462.00	93.3 AV			1.04 H	25	63.20	30.10
2	2483.50	54.4 PK	74.00	-19.60	1.42 H	25	24.20	30.10
2	2483.50	43.3 AV	54.00	-10.70	1.42 H	25	13.20	30.10
3	4924.00	38.8 PK	74.00	-35.20	1.45 H	247	2.10	36.70
3	4924.00	28.8 AV	54.00	-25.20	1.45 H	247	2.10	36.70
4	7386.00	45.2 PK	74.00	-28.80	1.45 H	247	3.30	41.80
4	7386.00	35.7 AV	54.00	-18.30	1.45 H	247	3.30	41.80
5	9848.00	49.4 PK	74.00	-24.60	1.52 H	324	5.00	44.40
5	9848.00	37.8 AV	54.00	-16.20	1.52 H	324	5.00	44.40

ANTENNA POLARITY & TEST DISTANCE: VERTICAL AT 3M								
No.	Freq. (MHz)	Emission Level (dBuV/m)	Limit (dBuV/m)	Margin (dB)	Antenna Height (m)	Table Angle (Degree)	Raw Value (dBuV)	Correction Factor (dB/m)
1	*2462.00	107.2 PK			1.05 V	326	77.10	30.10
1	*2462.00	101.0 AV			1.05 V	326	70.90	30.10
2	2483.50	60.3 PK	74.00	-13.70	1.08 V	208	30.20	30.10
2	2483.50	53.0 AV	54.00	-1.00	1.08 V	208	22.90	30.10
3	4924.00	43.8 PK	74.00	-30.20	1.25 V	352	7.10	36.70
3	4924.00	33.0 AV	54.00	-21.00	1.25 V	352	7.10	36.70
4	7386.00	48.2 PK	74.00	-25.80	1.40 V	141	6.40	41.80
4	7386.00	38.3 AV	54.00	-15.70	1.40 V	141	6.40	41.80
5	9848.00	50.4 PK	74.00	-23.60	1.46 V	352	6.00	44.40
5	9848.00	39.4 AV	54.00	-14.60	1.46 V	352	6.00	44.40

- NOTE:**
1. Emission level= Raw Value - Correction Factor
 2. Correction Factor = External Preamp. Gain - Ant. Factor - Cable loss
(External Preamp. Gain = 0, when the test receiver is used for the test.)
 3. The other emission levels were very low against the limit.
 4. Margin value = Emission level - Limit value
 5. The limit value is defined as per 15.247
 6. " * " : Fundamental frequency



TEST RESULTS (B)- OFDM

EUT	EliteConnect Universal 2.4GHz/5GHz Wireless Access Point	MODEL	SMC2555W-AG
MODE	Channel 1	FREQUENCY RANGE	1000MHz~24835MHz
INPUT POWER (SYSTEM)	120Vac, 60Hz	DETECTOR FUNCTION	Peak(PK) Average (AV)
ENVIRONMENTAL CONDITIONS	28deg. C, 56%RH, 976 hPa	TESTED BY	Eric Lee

ANTENNA POLARITY & TEST DISTANCE: HORIZONTAL AT 3 M								
No.	Freq. (MHz)	Emission Level (dBuV/m)	Limit (dBuV/m)	Margin (dB)	Antenna Height (m)	Table Angle (Degree)	Raw Value (dBuV)	Correction Factor (dB/m)
1	2368.00	51.3 PK	74.00	-22.70	1.23 H	65	21.60	29.70
1	2368.00	41.3 AV	54.00	-12.70	1.23 H	65	11.60	29.70
2	2390.00	54.4 PK	74.00	-19.60	1.54 H	8	24.60	29.80
2	2390.00	46.0 AV	54.00	-8.00	1.54 H	8	16.20	29.80
3	*2412.00	96.0 PK			1.03 H	140	66.10	29.90
3	*2412.00	86.8 AV			1.03 H	140	56.90	29.90
4	4824.00	37.5 PK	74.00	-36.50	1.01 H	21	1.30	36.20
4	4824.00	27.3 AV	54.00	-26.70	1.01 H	21	1.30	36.20
5	7236.00	42.8 PK	74.00	-31.20	1.47 H	54	1.20	41.70
5	7236.00	34.3 AV	54.00	-19.70	1.47 H	54	1.20	41.70
6	9648.00	46.5 PK	74.00	-27.50	1.03 H	352	1.60	44.90
6	9648.00	36.5 AV	54.00	-17.50	1.03 H	352	1.60	44.90

ANTENNA POLARITY & TEST DISTANCE: VERTICAL AT 3 M								
No.	Freq. (MHz)	Emission Level (dBuV/m)	Limit (dBuV/m)	Margin (dB)	Antenna Height (m)	Table Angle (Degree)	Raw Value (dBuV)	Correction Factor (dB/m)
1	2368.00	58.1 PK	74.00	-15.90	1.23 V	41	28.40	29.70
1	2368.00	49.3 AV	54.00	-4.70	1.23 V	41	19.60	29.70
2	2390.00	61.9 PK	74.00	-12.10	1.25 V	24	32.10	29.80
2	2390.00	52.1 AV	54.00	-1.90	1.25 V	24	22.30	29.80
3	*2412.00	102.4 PK			1.05 V	22	72.50	29.90
3	*2412.00	93.8 AV			1.05 V	22	63.90	29.90
4	4824.00	41.7 PK	74.00	-32.30	1.00 V	21	5.50	36.20
4	4824.00	30.4 AV	54.00	-23.60	1.00 V	21	5.50	36.20
5	7236.00	48.2 PK	74.00	-25.80	1.01 V	21	6.50	41.70
5	7236.00	36.6 AV	54.00	-17.40	1.01 V	21	6.50	41.70
6	9648.00	49.7 PK	74.00	-24.30	1.09 V	0	4.80	44.90
6	9648.00	38.4 AV	54.00	-15.60	1.09 V	0	4.80	44.90

- NOTE:**
1. Emission level = Raw Value - Correction Factor
 2. Correction Factor = External Preamp. Gain - Ant. Factor - Cable loss
(External Preamp. Gain = 0, when the test receiver is used for the test.)
 3. The other emission levels were very low against the limit.
 4. Margin value = Emission level - Limit value
 5. The limit value is defined as per 15.247
 6. “ * “ : Fundamental frequency



EUT	EliteConnect Universal 2.4GHz/5GHz Wireless Access Point	MODEL	SMC2555W-AG
MODE	Channel 6	FREQUENCY RANGE	1000MHz~24835MHz
INPUT POWER (SYSTEM)	120Vac, 60Hz	DETECTOR FUNCTION	Peak(PK) Average (AV)
ENVIRONMENTAL CONDITIONS	28deg. C, 56%RH, 976 hPa	TESTED BY	Eric Lee

ANTENNA POLARITY & TEST DISTANCE: HORIZONTAL AT 3 M								
No.	Freq. (MHz)	Emission Level (dBuV/m)	Limit (dBuV/m)	Margin (dB)	Antenna Height (m)	Table Angle (Degree)	Raw Value (dBuV)	Correction Factor (dB/m)
1	2390.00	55.1 PK	74.00	-18.90	1.26 H	35	25.30	29.80
1	2390.00	40.0 AV	54.00	-14.00	1.26 H	35	10.20	29.80
2	*2437.00	97.1 PK			1.25 H	33	67.10	30.00
2	*2437.00	87.3 AV			1.25 H	33	57.30	30.00
3	2483.50	55.3 PK	74.00	-18.70	1.04 H	24	25.20	30.10
3	2483.50	40.4 AV	54.00	-13.60	1.04 H	24	10.20	30.10
4	4874.00	39.9 PK	74.00	-34.10	1.46 H	321	3.50	36.50
4	4874.00	28.6 AV	54.00	-25.40	1.46 H	321	3.50	36.50
5	7311.00	46.1 PK	74.00	-27.90	4.00 H	32	4.30	41.80
5	7311.00	36.1 AV	54.00	-17.90	4.00 H	32	4.30	41.80
6	9748.00	47.8 PK	74.00	-26.20	1.08 H	321	3.20	44.60
6	9748.00	36.8 AV	54.00	-17.20	1.08 H	321	3.20	44.60

ANTENNA POLARITY & TEST DISTANCE: VERTICAL AT 3 M								
No.	Freq. (MHz)	Emission Level (dBuV/m)	Limit (dBuV/m)	Margin (dB)	Antenna Height (m)	Table Angle (Degree)	Raw Value (dBuV)	Correction Factor (dB/m)
1	2390.00	58.1 PK	74.00	-15.90	1.02 V	32	28.30	29.80
1	2390.00	48.1 AV	54.00	-5.90	1.02 V	32	18.30	29.80
2	*2437.00	103.5 PK			1.25 V	33	73.50	30.00
2	*2437.00	94.0 AV			1.25 V	33	64.00	30.00
3	2483.50	60.4 PK	74.00	-13.60	1.23 V	35	30.20	30.10
3	2483.50	48.7 AV	54.00	-5.30	1.23 V	35	18.60	30.10
4	4874.00	43.6 PK	74.00	-30.40	1.24 V	21	7.10	36.50
4	4874.00	33.6 AV	54.00	-20.40	1.24 V	21	7.10	36.50
5	7311.00	48.5 PK	74.00	-25.50	1.45 V	74	6.70	41.80
5	7311.00	38.1 AV	54.00	-15.90	1.45 V	74	6.70	41.80
6	9748.00	50.4 PK	74.00	-23.60	1.44 V	2	5.70	44.60
6	9748.00	40.4 AV	54.00	-13.60	1.44 V	2	5.70	44.60

- NOTE:**
1. Emission level = Raw Value - Correction Factor
 2. Correction Factor = External Preamp. Gain - Ant. Factor - Cable loss
(External Preamp. Gain = 0, when the test receiver is used for the test.)
 3. The other emission levels were very low against the limit.
 4. Margin value = Emission level - Limit value
 5. The limit value is defined as per 15.247
 6. " * " : Fundamental frequency



EUT	EliteConnect Universal 2.4GHz/5GHz Wireless Access Point	MODEL	SMC2555W-AG
MODE	Channel 11	FREQUENCY RANGE	1000MHz~24835MHz
INPUT POWER (SYSTEM)	120Vac, 60Hz	DETECTOR FUNCTION	Peak(PK) Average (AV)
ENVIRONMENTAL CONDITIONS	28deg. C, 56%RH, 976 hPa	TESTED BY	Eric Lee

ANTENNA POLARITY & TEST DISTANCE: HORIZONTAL AT 3M

No.	Freq. (MHz)	Emission Level (dBuV/m)	Limit (dBuV/m)	Margin (dB)	Antenna Height (m)	Table Angle (Degree)	Raw Value (dBuV)	Correction Factor (dB/m)
1	*2462.00	93.5 PK			1.08 H	352	63.50	30.10
1	*2462.00	83.3 AV			1.08 H	352	53.30	30.10
2	2483.50	54.3 PK	74.00	-19.70	1.02 H	35	24.20	30.10
2	2483.50	45.3 AV	54.00	-8.70	1.02 H	35	15.20	30.10
3	4924.00	38.7 PK	74.00	-35.30	1.02 H	24	2.00	36.70
3	4924.00	29.2 AV	54.00	-24.80	1.02 H	24	2.00	36.70
4	7386.00	44.6 PK	74.00	-29.40	1.08 H	333	2.70	41.80
4	7386.00	33.6 AV	54.00	-20.40	1.08 H	333	2.70	41.80
5	9848.00	48.1 PK	74.00	-25.90	1.07 H	131	3.70	44.40
5	9848.00	37.2 AV	54.00	-16.80	1.07 H	131	3.70	44.40

ANTENNA POLARITY & TEST DISTANCE: VERTICAL AT 3M

No.	Freq. (MHz)	Emission Level (dBuV/m)	Limit (dBuV/m)	Margin (dB)	Antenna Height (m)	Table Angle (Degree)	Raw Value (dBuV)	Correction Factor (dB/m)
1	*2462.00	102.1 PK			1.11 V	312	72.00	30.10
1	*2462.00	94.1 AV			1.11 V	312	64.00	30.10
2	2483.50	61.2 PK	74.00	-12.80	1.40 V	269	31.10	30.10
2	2483.50	52.9 AV	54.00	-1.10	1.40 V	269	22.80	30.10
3	4924.00	42.8 PK	74.00	-31.20	1.23 V	35	6.10	36.70
3	4924.00	32.8 AV	54.00	-21.20	1.23 V	35	6.10	36.70
4	7386.00	49.2 PK	74.00	-24.80	1.24 V	96	7.30	41.80
4	7386.00	38.5 AV	54.00	-15.50	1.24 V	96	7.30	41.80
5	9848.00	49.3 PK	74.00	-24.70	1.05 V	301	5.00	44.40
5	9848.00	40.8 AV	54.00	-13.20	1.05 V	301	5.00	44.40

- NOTE:**
1. Emission level= Raw Value - Correction Factor
 2. Correction Factor = External Preamp. Gain - Ant. Factor - Cable loss
(External Preamp. Gain = 0, when the test receiver is used for the test.)
 3. The other emission levels were very low against the limit.
 4. Margin value = Emission level - Limit value
 5. The limit value is defined as per 15.247
 6. " * " : Fundamental frequency



4.3 6dB BANDWIDTH MEASUREMENT

4.3.1 LIMITS OF 6dB BANDWIDTH MEASUREMENT

The minimum of 6dB Bandwidth Measurement is 0.5 MHz.

4.3.2 TEST INSTRUMENTS

Description & Manufacturer	Model No.	Serial No.	Calibrated Until
R&S SPECTRUM ANALYZER	FSP	1093.4495.30	Dec. 19, 2003

NOTE:

- 1.The measurement uncertainty is less than +/- 2.6dB, which is calculated as per the NAMAS document NIS81.
- 2.The calibration interval of the above test instruments is 12 months and the calibrations are traceable to NML/ROC and NIST/USA.

4.3.3 TEST PROCEDURE

The transmitter output was connected to the spectrum analyzer through an attenuator. The bandwidth of the fundamental frequency was measured by spectrum analyzer with 100kHz RBW and 100kHz VBW. The 6dB bandwidth is defined as the total spectrum the power of which is higher than peak power minus 6 dB.

4.3.4 DEVIATION FROM TEST STANDARD

No deviation

4.3.5 TEST SETUP

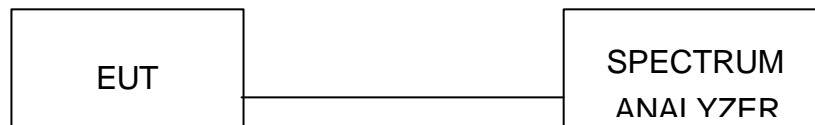

4.3.6 EUT OPERATING CONDITIONS

The software provided by client to enable the EUT under transmission condition continuously at lowest, middle and highest channel frequencies individually.



4.3.7 TEST RESULTS (A)

EUT	EliteConnect Universal 2.4GHz/5GHz Wireless Access Point	MODEL	SMC2555W-AG
INPUT POWER (SYSTEM)	120Vac, 60Hz	ENVIRONMENTAL CONDITIONS	21deg. C, 58%RH, 976 hPa
TESTED BY	Eric Lee		

CHANNEL	CHANNEL FREQUENCY (MHz)	6dB BANDWIDTH (MHz)	MINIMUM LIMIT (MHz)	PASS/FAIL
1	2412	11.96	0.5	PASS
6	2437	11.36	0.5	PASS
11	2462	11.84	0.5	PASS



CH1

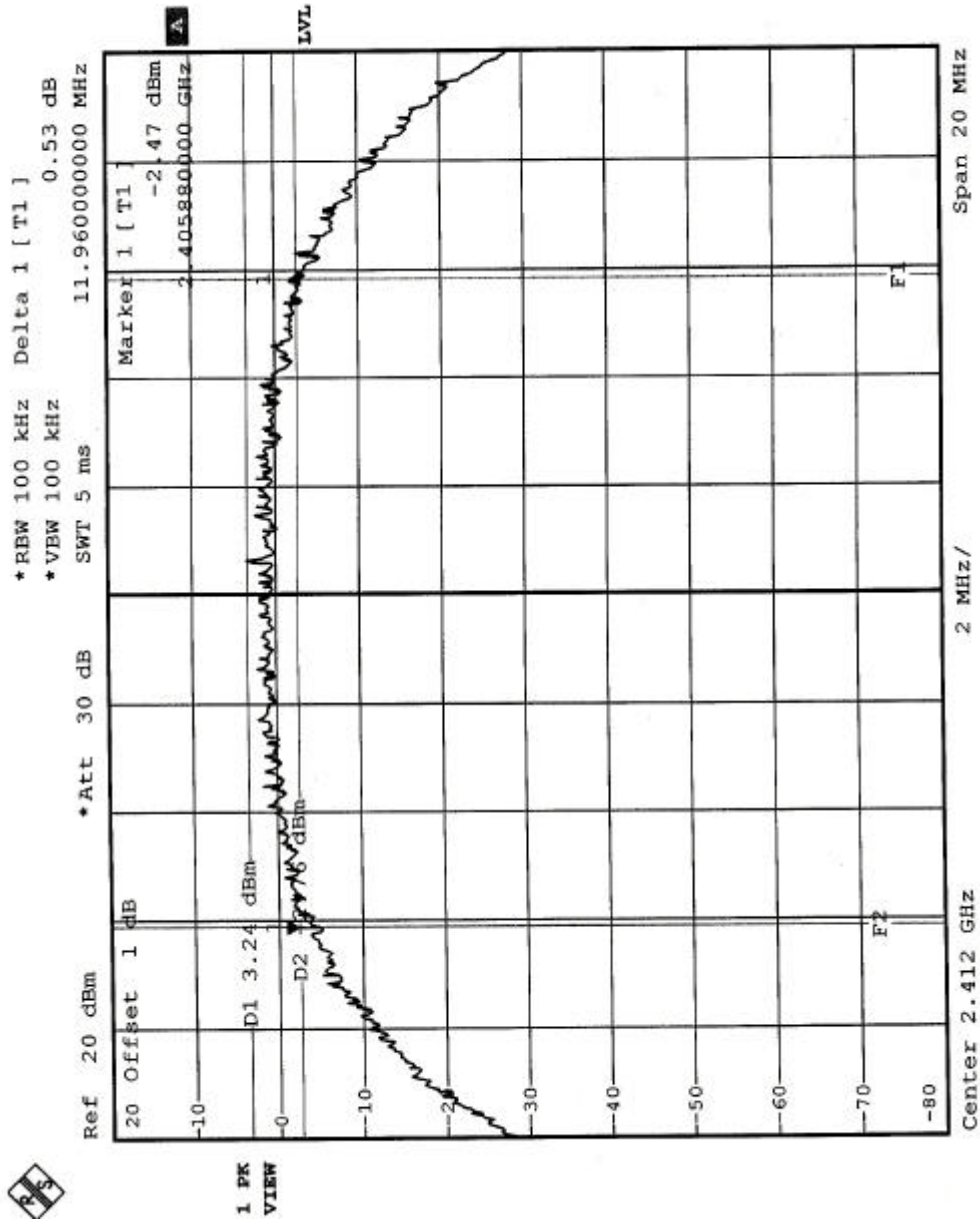



CH6

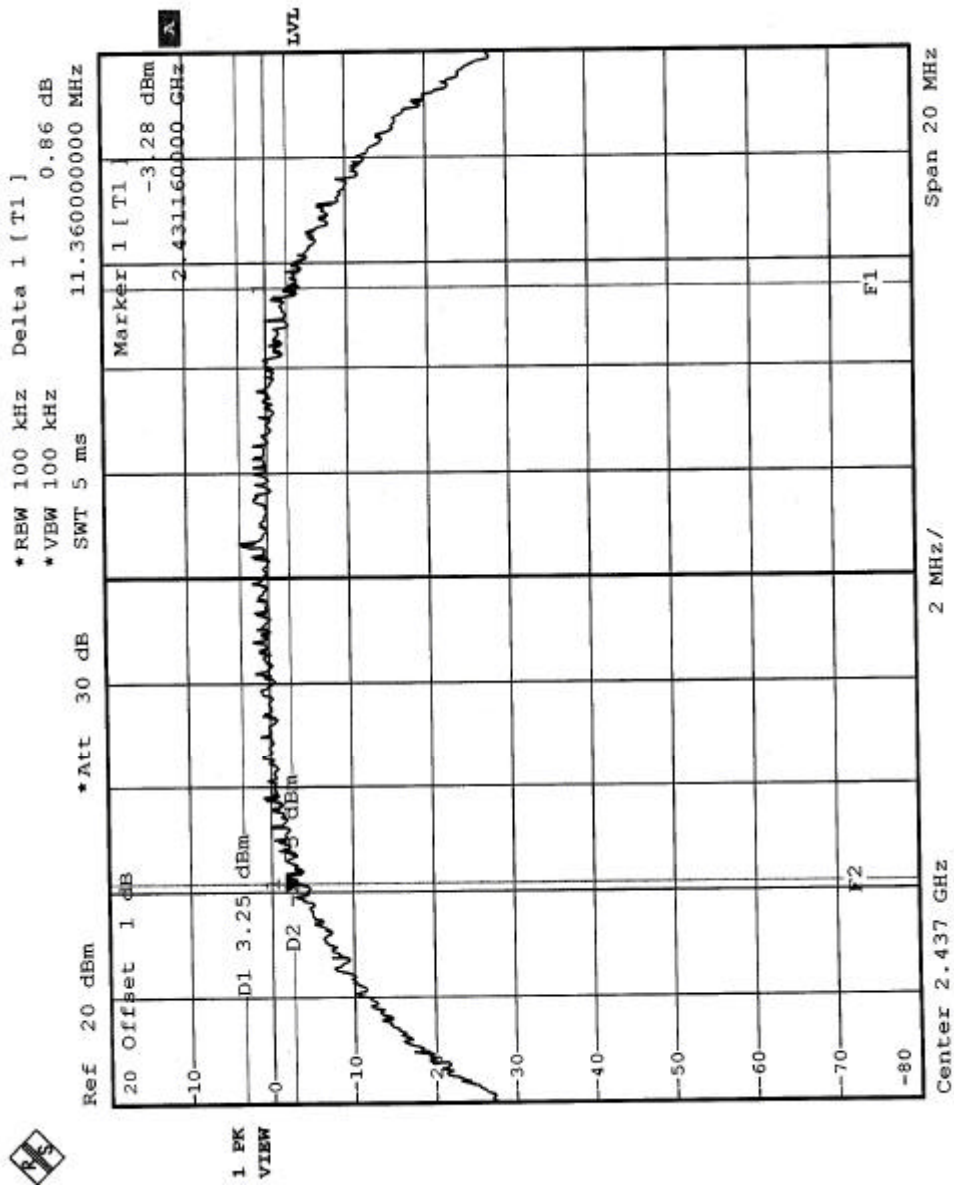



CH11

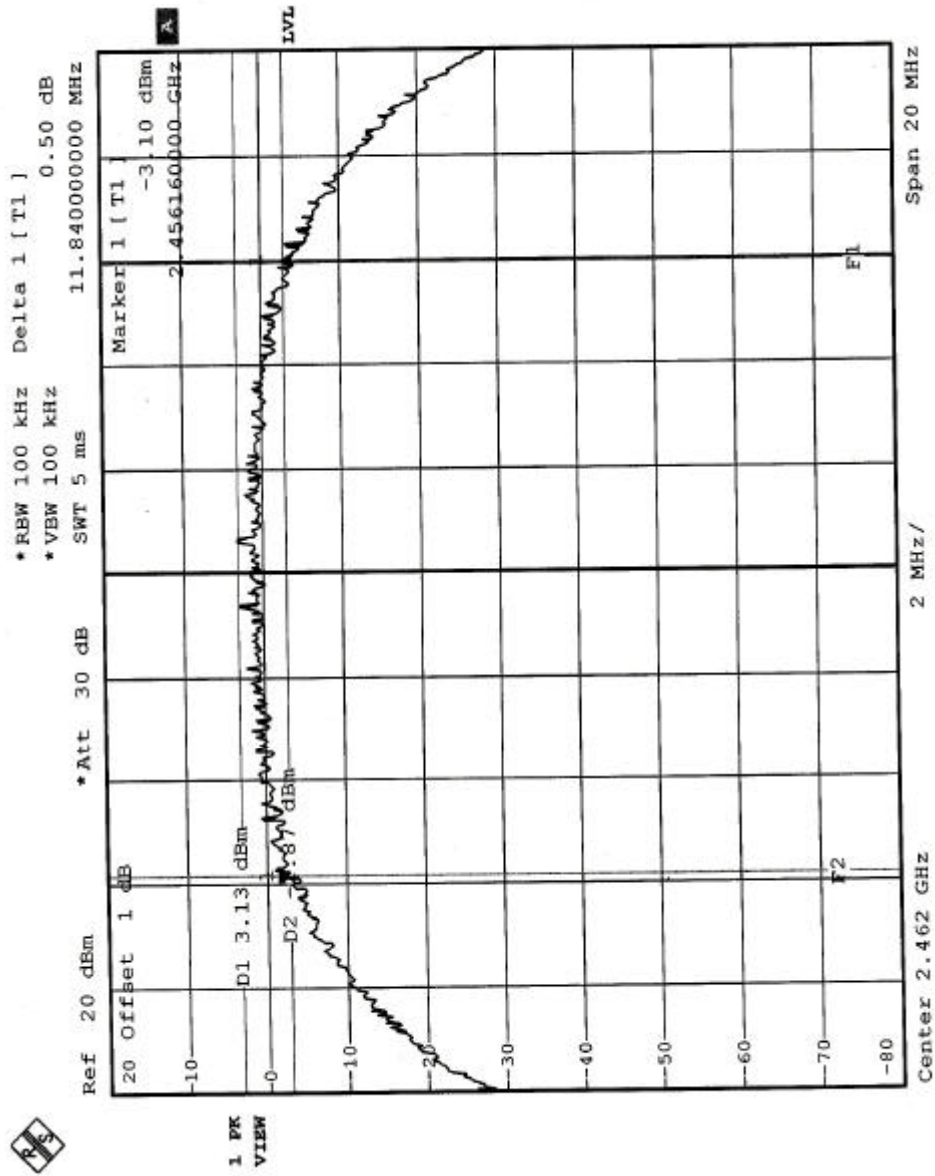



4.3.8 TEST RESULTS (B)

EUT	EliteConnect Universal 2.4GHz/5GHz Wireless Access Point	MODEL	SMC2555W-AG
INPUT POWER (SYSTEM)	120Vac, 60Hz	ENVIRONMENTAL CONDITIONS	21deg. C, 58%RH, 976 hPa
TESTED BY	Eric Lee		

CHANNEL	CHANNEL FREQUENCY (MHz)	6dB BANDWIDTH (MHz)	MINIMUM LIMIT (MHz)	PASS/FAIL
1	2412	16.6	0.5	PASS
6	2437	16.6	0.5	PASS
11	2462	16.6	0.5	PASS



CH1

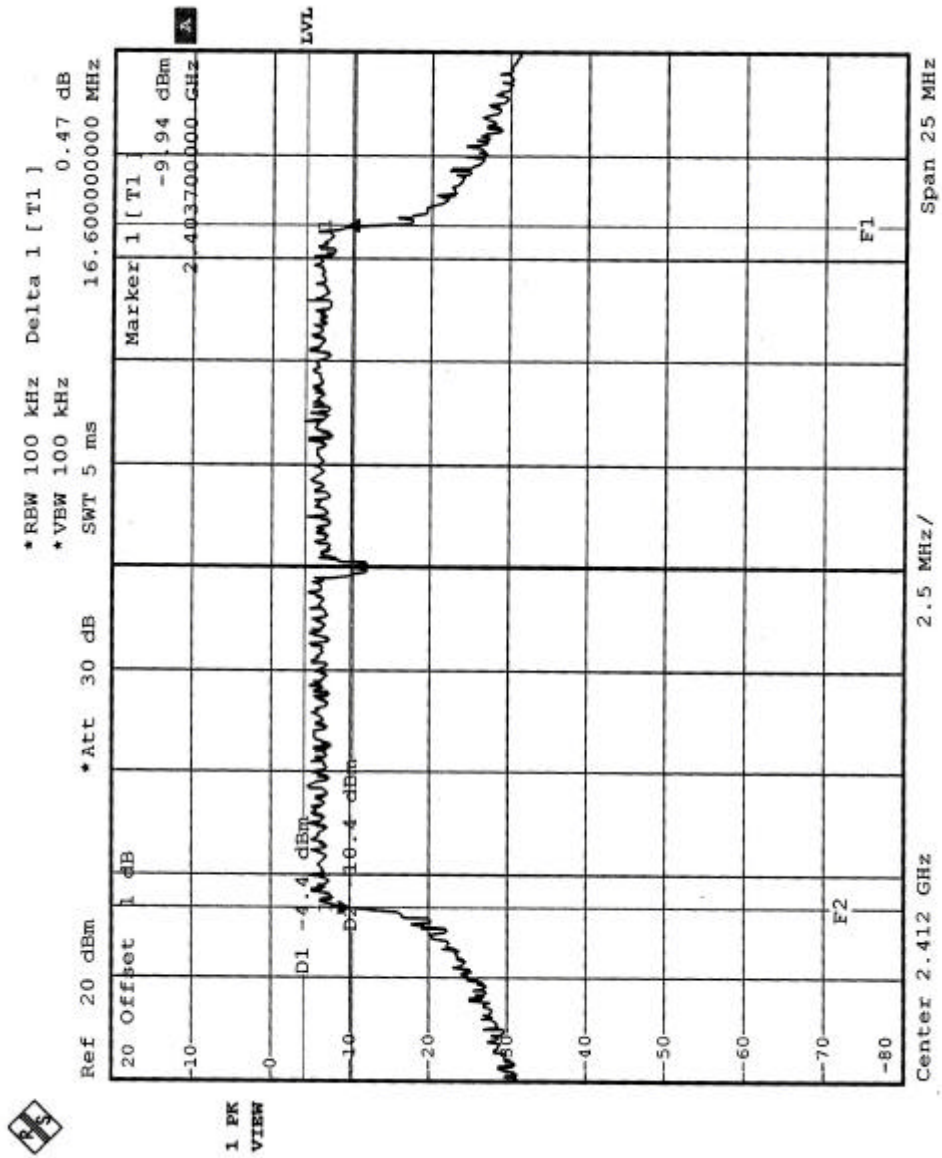



CH6

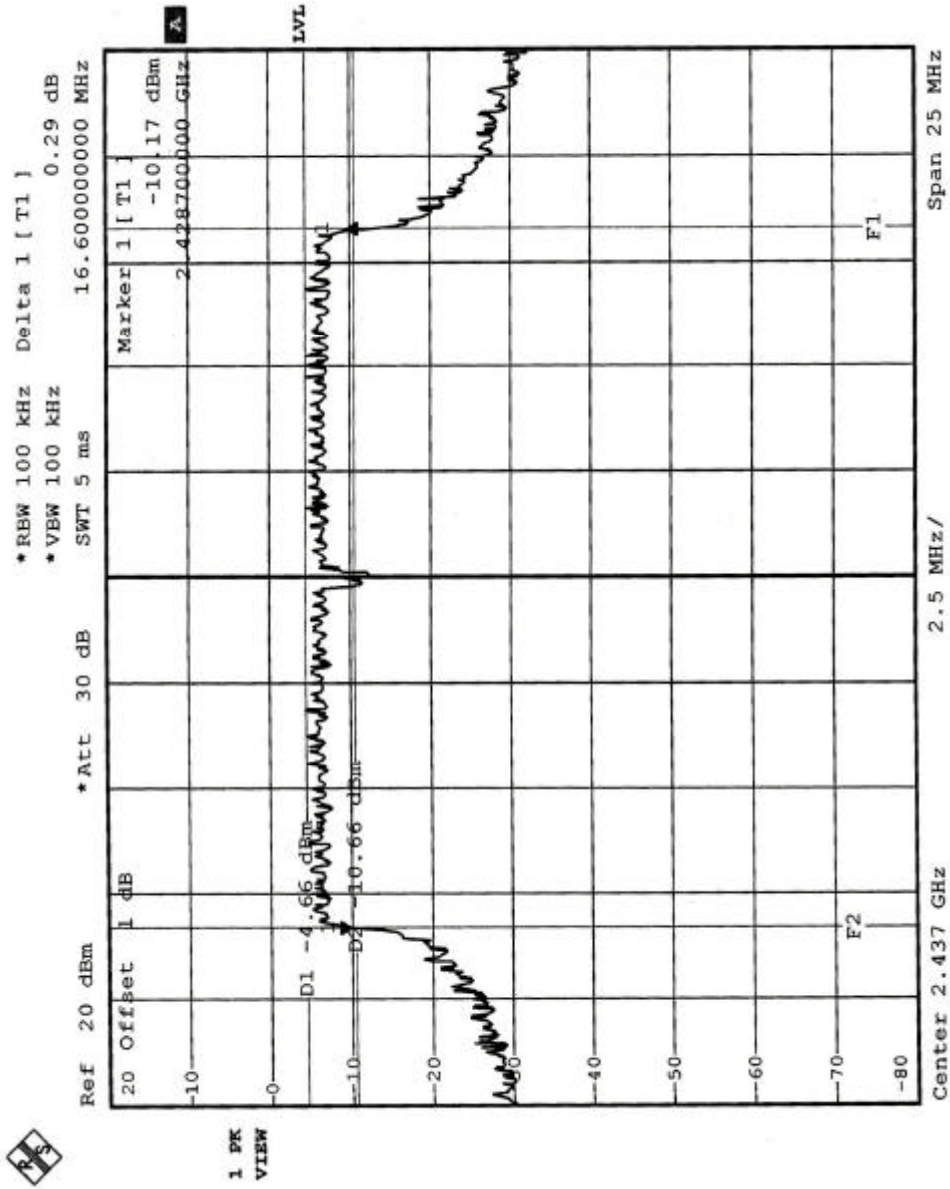



CH11

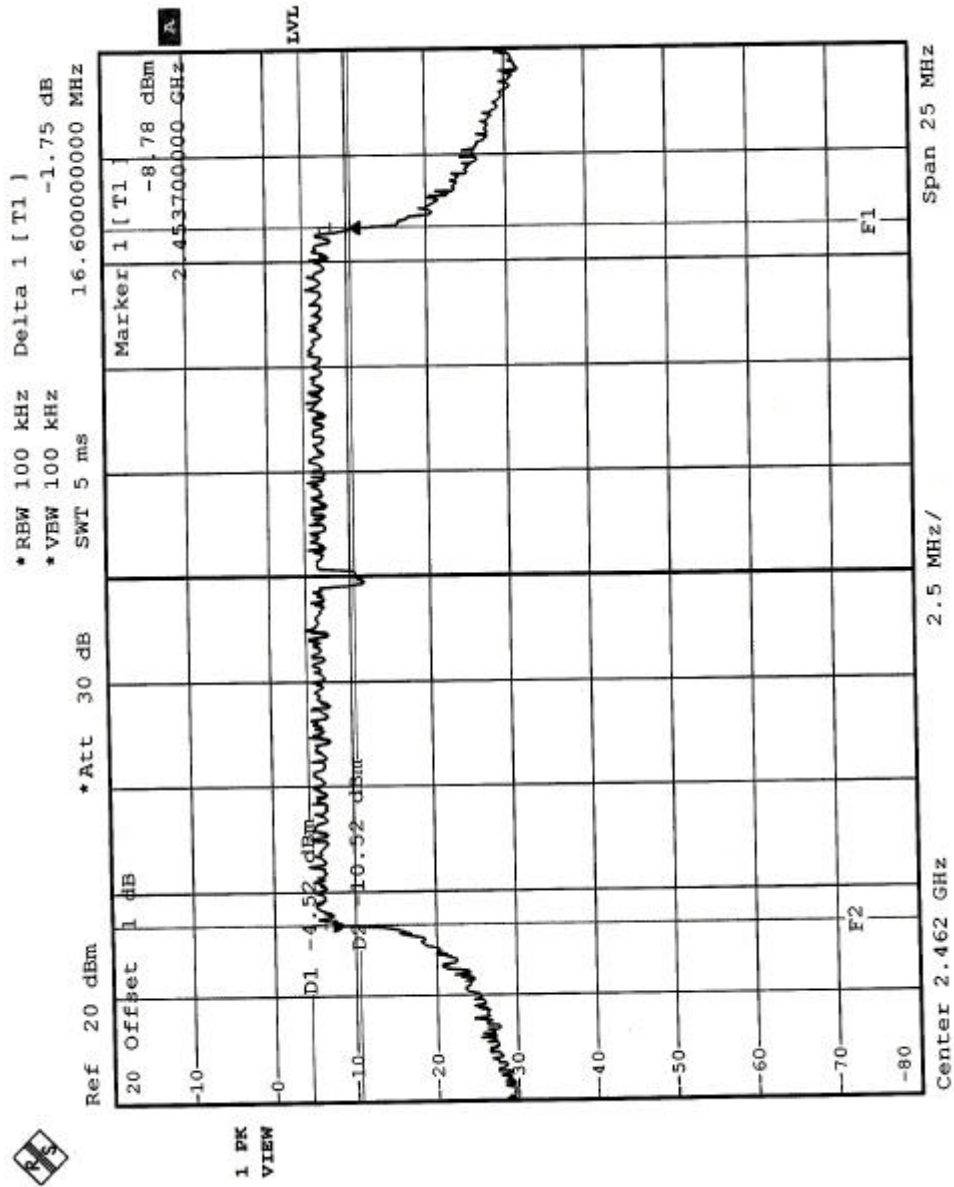



4.4 MAXIMUM PEAK OUTPUT POWER

4.4.1 LIMITS OF MAXIMUM PEAK OUTPUT POWER MEASUREMENT

The Maximum Peak Output Power Measurement is 30dBm.

4.4.2 INSTRUMENTS

Description & Manufacturer	Model No.	Serial No.	Calibrated Until
R&S SPECTRUM ANALYZER	FSP30	100019	Dec. 19, 2003
R&S SIGNAL GENERATOR	SMP04	100011	May 28, 2004
TEKTRONIX OSCILLOSCOPE	TDS 220	B048470	Mar. 05, 2004
NARDA DETECTOR	4503A	FSCM99899	NA

NOTE:

The calibration interval of the above test instruments is 12 months and the calibrations are traceable to NML/ROC and NIST/USA.

4.4.3 TEST PROCEDURES

1. A detector was used on the output port of the EUT. An oscilloscope was used to read the peak response of the detector.
2. Replaced the EUT by the signal generator. The center frequency of the S.G was adjusted to the center frequency of the measured channel.
3. Adjusted the power to have the same peak reading on oscilloscope.
Record the power level.

4.4.4 TEST SETUP



4.4.5 EUT OPERATING CONDITIONS

Same as Item 4.3.6



4.4.6 TEST RESULTS (A)

EUT	EliteConnect Universal 2.4GHz/5GHz Wireless Access Point	MODEL	SMC2555W-AG
INPUT POWER (SYSTEM)	120Vac, 60Hz	ENVIRONMENTAL CONDITIONS	19deg. C, 64%RH, 976 hPa
TESTED BY	Eric Lee		

CHANNEL	CHANNEL FREQUENCY (MHz)	PEAK POWER OUTPUT (dBm)	PEAK POWER LIMIT (dBm)	PASS/FAIL
1	2412	15.63	30	PASS
6	2437	15.48	30	PASS
11	2462	15.29	30	PASS

4.4.7 TEST RESULTS (B)

EUT	EliteConnect Universal 2.4GHz/5GHz Wireless Access Point	MODEL	SMC2555W-AG
INPUT POWER (SYSTEM)	120Vac, 60Hz	ENVIRONMENTAL CONDITIONS	19deg. C, 64%RH, 976 hPa
TESTED BY	Eric Lee		

CHANNEL	CHANNEL FREQUENCY (MHz)	PEAK POWER OUTPUT (dBm)	PEAK POWER LIMIT (dBm)	PASS/FAIL
1	2412	16.23	30	PASS
6	2437	16.11	30	PASS
11	2462	16.01	30	PASS



4.5 POWER SPECTRAL DENSITY MEASUREMENT

4.5.1 LIMITS OF POWER SPECTRAL DENSITY MEASUREMENT

The Maximum of Power Spectral Density Measurement is 8dBm.

4.5.2 TEST INSTRUMENTS

Description & Manufacturer	Model No.	Serial No.	Calibrated Until
R&S SPECTRUM ANALYZER	FSP	1093.4495.30	Dec. 19, 2003

NOTE:

- 1.The measurement uncertainty is less than +/- 2.6dB, which is calculated as per the NAMAS document NIS81.
- 2.The calibration interval of the above test instruments is 12 months and the calibrations are traceable to NML/ROC and NIST/USA.

4.5.3 TEST PROCEDURE

The transmitter output was connected to the spectrum analyzer through an attenuator, the bandwidth of the fundamental frequency was measured with the spectrum analyzer using 3 kHz RBW and 30 kHz VBW, set sweep time = span/3 kHz. The power spectral density was measured and recorded.

The sweep time is allowed to be longer than span/3 kHz for a full response of the mixer in the spectrum analyzer.

4.5.4 DEVIATION FROM TEST STANDARD

No deviation

4.5.5 TEST SETUP

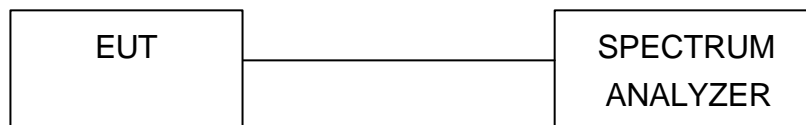

4.5.6 EUT OPERATING CONDITION

Same as Item 4.3.6



4.5.7 TEST RESULTS(A)

EUT	EliteConnect Universal 2.4GHz/5GHz Wireless Access Point	MODEL	SMC2555W-AG
INPUT POWER (SYSTEM)	120Vac, 60Hz	ENVIRONMENTAL CONDITIONS	21deg. C, 58RH, 976 hPa
TESTED BY	Eric Lee		

CHANNEL NUMBER	CHANNEL FREQUENCY (MHz)	RF POWER LEVEL IN 3 kHz BW (dBm)	MAXIMUM LIMIT (dBm)	PASS/FAIL
1	2412	-11.01	8	PASS
6	2437	-11.08	8	PASS
11	2462	-11.28	8	PASS



CH1

