

Lct

SPECIFICATION FOR APPROVAL

承認書

客 戶 承 認 印 章	龍呈國際科技有限公司		
	業 務	工 程	品 管

客 戶 智邦科技股份有限公司

CUSTOMER _____

品 名 DB B-SMA Paddle Ant. GEC6200 Black UL2043

SPECIES GE-C6200

料 號 FDP-ACBSMA-BG

PART NO. _____

客 戶 料 號

CUSTOMER PART NO. _____

龍呈國際科技有限公司

Long Cheng Tech. Int'l Co., Ltd.

新竹縣竹北市中和街 62 巷 15 弄 3 號 3 樓

3Floor, No.3, Alley 15, Lane 62, Chung Ho St.,

Chu-Pei City, Hsin Chu, Taiwan, R.O.C

TEL: 03-5541117 FAX: 03-5541065



龍呈國際科技有限公司

Long Cheng Tech. Int'l Co., Ltd.

新竹縣竹北市中和街 62 巷 15 弄 3 號 3 樓

3Floor, No.3, Alley 15, Lane 62, Chung Ho St.,

TEL:+886-3-5541117 FAX:+886-3-5541065

Chu-Pei City, Hsin Chu, Taiwan, R.O.C

Index

item	Content	Page	Remark
1	Coverpage	1	
2	Index	2	
3	Product Drawing / Package	3-4	
4	Mechanical Specifications	5	
5	Electrical Specifications	6	
6	Electrical Specifications Test	7-11	
7	Material Specifications & MSDS (SGS Report)	12-37	
7-1	Cable	12-18	
7-2	RF connector	19-24	
7-3	PVC Tube	25-27	
7-4	Lead Free - Solder Bar/ Wire	28-31	
7-5	Plastics	32-35	
7-6	Pin / Revit	36	
7-7	Brass Tube / PCB	37-39	
7-8	Glue	40	

6				5				4				3				2				1			
LTR	Zone	REVISION RECORD / Description		DWN	CHK	DATE	LTR	Zone	REVISION RECORD / Description		DWN	CHK	DATE	DRAWING NUMBER									
1		New Release				NOV/25/05								FDP-ACBSMA-BG									

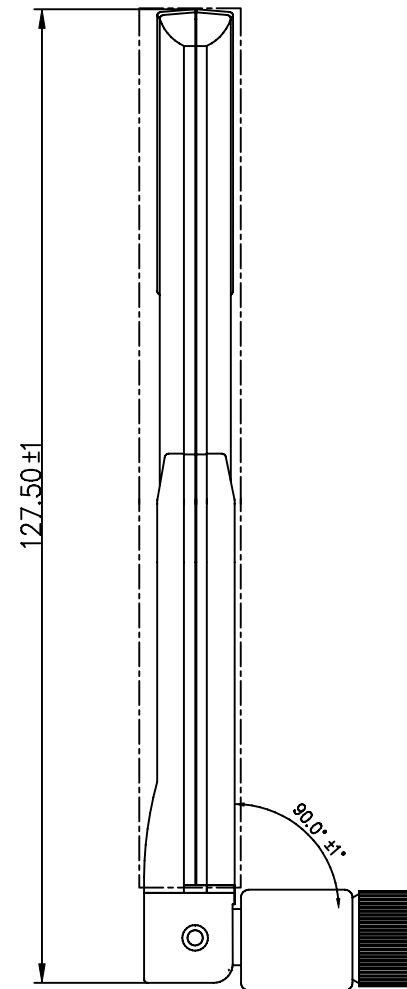
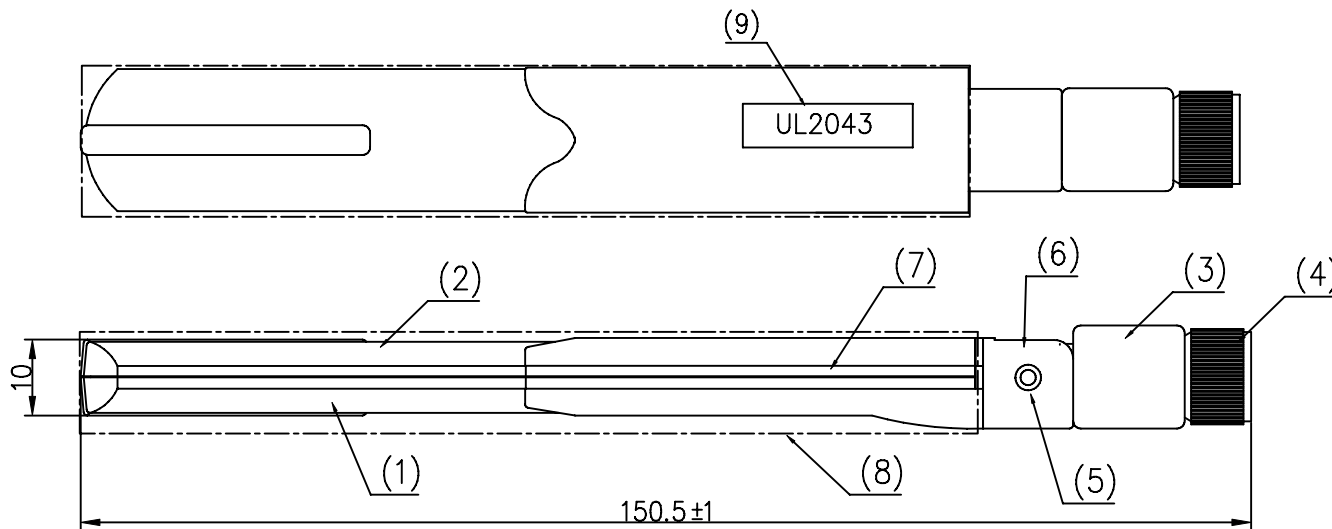

PVC TUBE 透明
115 REF(±5)

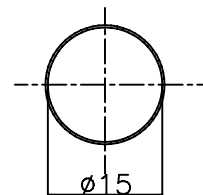

9	Label (銅板) 12mm*4mm	1		M12-012X048-WH
8	PVC TUBE ø15*L115mm T0.3	1		M05-PVCD15-00
7	DB RO PCB 104*16.05	1		M03-DUBAND-00
6	CABLE : ø1.37 Black	1		M02-137GRR-BL
5	RIVET : Zn Surface	2	Stainless	M06-202040-00
4	CN B-SMA M/F RG178 ZLA-7013RP	1	Brass Cr plated	M01-053020-02
3	PL 3BAND-S LO-HOLD B for SMA	1	ABS	M04-3BS030-01
2	UPPER: GE-C6200 (Black)	1	GE6200 ABS+PC	M04-ASGEBL-03
1	COVER Base: GE6200 (Black)	1	GE6200 ABS+PC	M04-ASGEBL-13
NO	DESCRIPTION	Q'ty	MATERIAL	Part Number

UNIT	APVD
mm	
MATERIAL	CHK
SEE NOTE	
FINISH	DWN
SEE NOTE	KIKI

Lct LONG CHENG ELECTRONICS CO. LTD
龍呈國際科技有限公司

DESCRIPTION:
DB B-SMA(M/F) PADDLE ANT. GE-C6200
Black

DIMENSION:		PART NUMBER		REV
1 PLC	±0.5	FDP-ACBSMA-BG		1
2 PLC	±0.3	SIZE	SCALE	SHEET
3 PLC	±0.2	A4	1/1	1 OF 1
ANGLES	±5°			

6		5		4		3		2		1				
LTR	Zone	REVISION RECORD / Description		DWN	CHK	DATE	LTR	Zone	REVISION RECORD / Description		DWN	CHK	DATE	DRAWING NUMBER
1		New Release				Nov/21/05**								S-SMA Package
2														

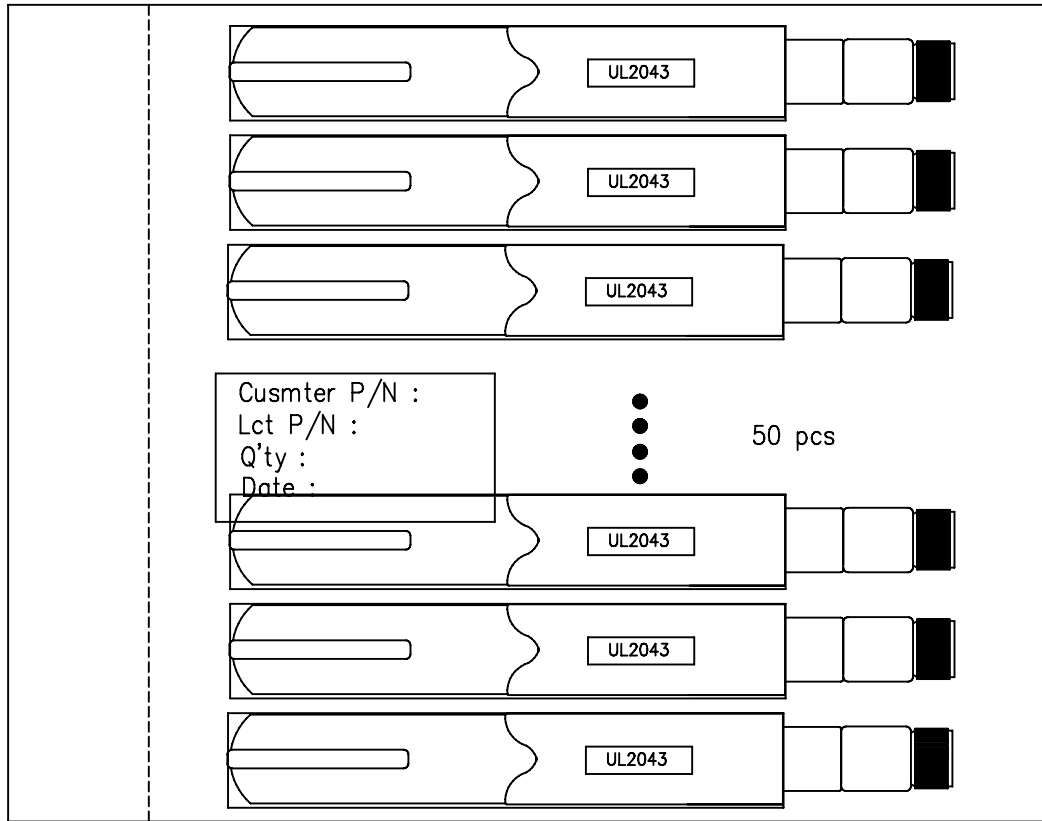

1 PE Bag = 50 pcs
1 Carton = 20 PE BAG = 1000 pcs

9					
8					
7					
6					
5					
4					
3					
2					
1					
NO	DESCRIPTION	Q'ty	MATERIAL	Part Number	

		LONG CHENG ELECTRONICS CO. LTD	
		龍呈國際科技有限公司	
UNIT	APVD	DESCRIPTION:	
mm		B-SMA Package	
MATERIAL	CHK	DIMENSION:	PART NUMBER
SEE NOTE		1 PLC ±0.5	XXXXXXXXXXXX
FINISH	DWN	2 PLC ±0.3	REV 1
SEE NOTE	Kaven	3 PLC ±0.2	
		ANGLES ±5°	SIZE A4
			SCALE 1/1
			SHEET 1 OF 1

機械特性規格

Mechanical Specifications

接頭種類 (Connector Type)	RP-SMA Plug (BSMA) Cr plated
塑膠顏色 (Plastic Color)	Black
同軸線材 (Coaxial Cable Type)	1.37
同軸線材規格 (Coaxial Cable Spec.)	See attached file Cable Spec
天線罩材質 (Radom Material)	ABS+PC GE-C6200
同軸線材顏色 (Coaxial Cable Color)	Black
輻射材料 (Radiator Material)	PCB (Arlon/Rogers)
工作溫度與溼度 (Working Temperature & Humidity)	-25°C - +75°C 90% @ 25°C
重量 (Weight)	27.5g Max.

電氣特性規格

Electrical Specifications

頻率範圍 (Frequency Range)	2.4GHz~2.5GHz/5.15GHz~5.875GHz
增益 (Gain)	2.4~2.5 GHz , Gain = 2dBi 5.15 ~ 5.875 GHz, Gain = 5dBi
電壓駐波比 (VSWR)	VSWR < 2
極化 (Polarzation)	Linear, Vertical
半功率水平波束寬 (HPBW/Horizontal)	360°
半功率垂直波束寬 (HPBW/Vertical)	78°
最大功率 (Max. Power Rating)	2 W (CW)
阻抗匹配 (Impedance)	50 Ohms (typical)

電氣特性測試

Electrical Specifications Test

電壓駐波比測試
(VSWR Test)

測試使用儀器
(Test Instrument)

Anritsu MS4653B Vector Network Measurement System

測試資料
(Test Result)

** 如下頁附圖所示

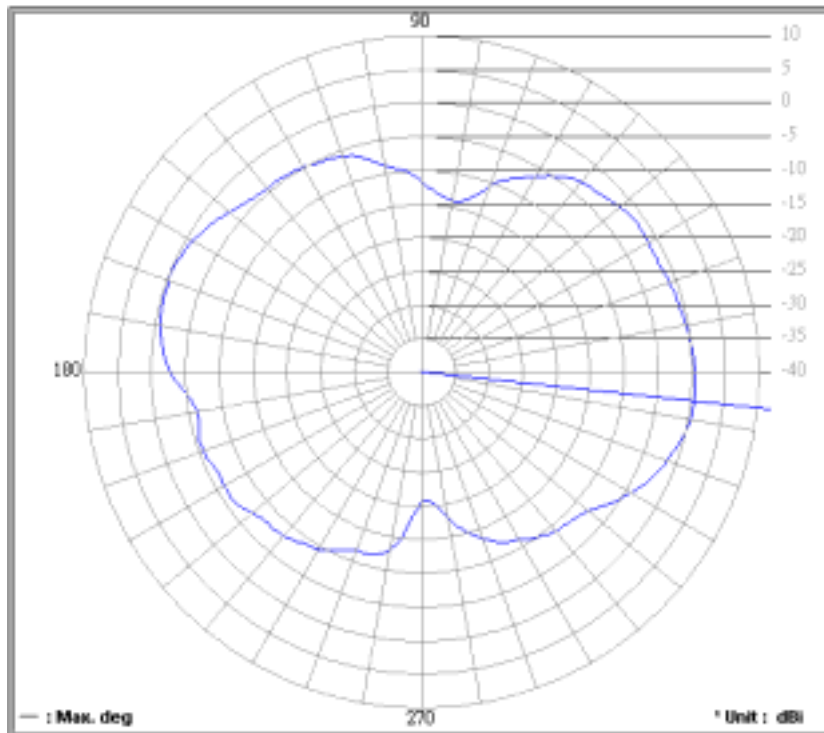

Frequency (MHz) : **2400.00** Antenna Polarity : **Horizontal** Average Gain (dB) : **-6.14**
 Maximum Gain (dB) : **0.85** Maximum Gain (degree) : **354**
 Minimum Gain (dB) : **-26.88** Minimum Gain (degree) : **270**

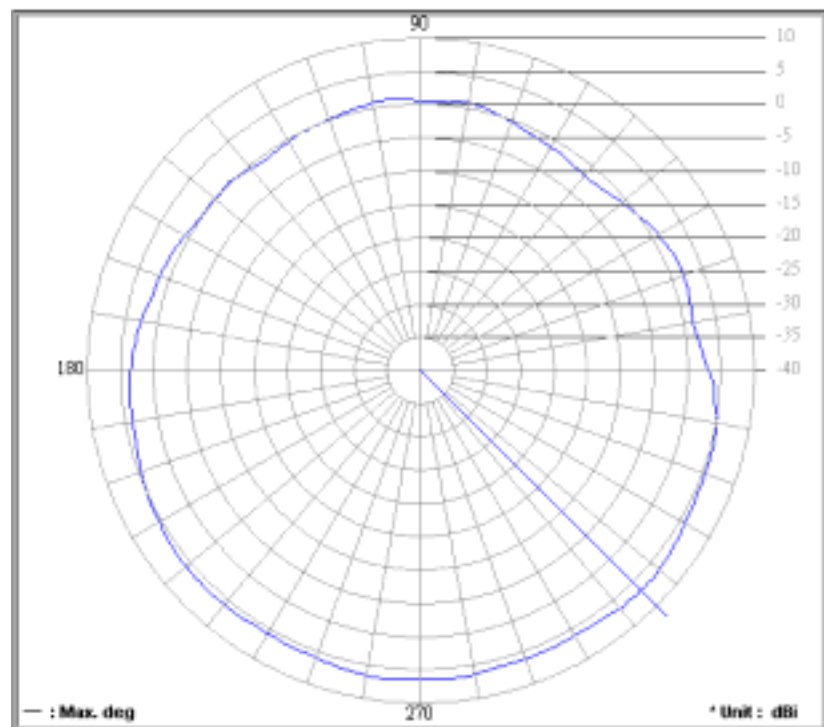

Frequency (MHz) : **5150.00** Antenna Polarity : **Vertical** Average Gain (dB) : **3.91**
 Maximum Gain (dB) : **6.72** Maximum Gain (degree) : **315**
 Minimum Gain (dB) : **-1.76** Minimum Gain (degree) : **90**

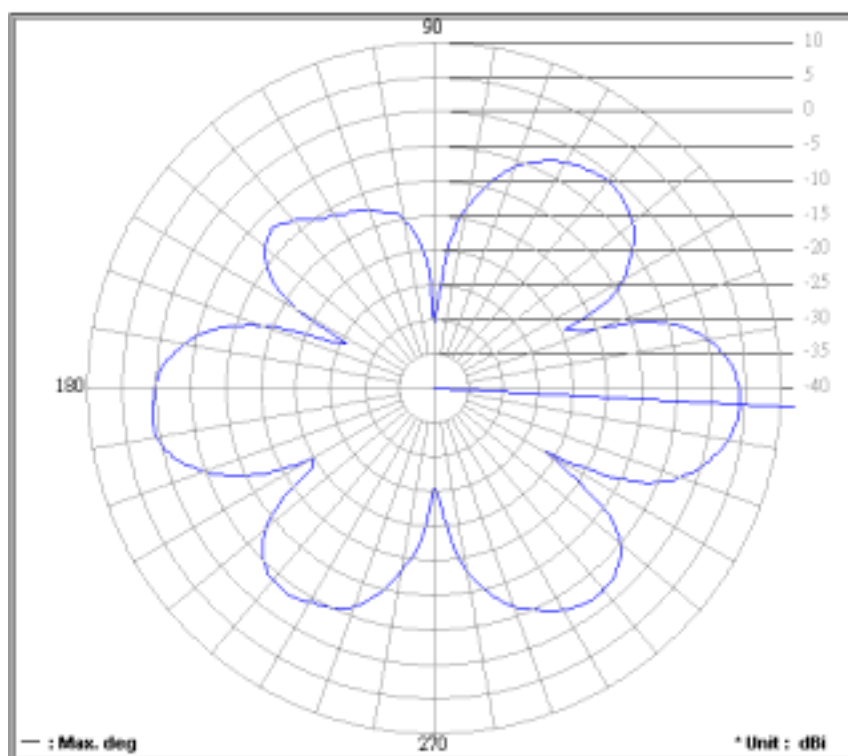

Frequency (MHz): **5150.00** Antenna Polarity: **Horizontal** Average Gain (dB): **-3.01**
 Maximum Gain (dB): **4.11** Maximum Gain (degree): **357**
 Minimum Gain (dB): **-31.34** Minimum Gain (degree): **90**

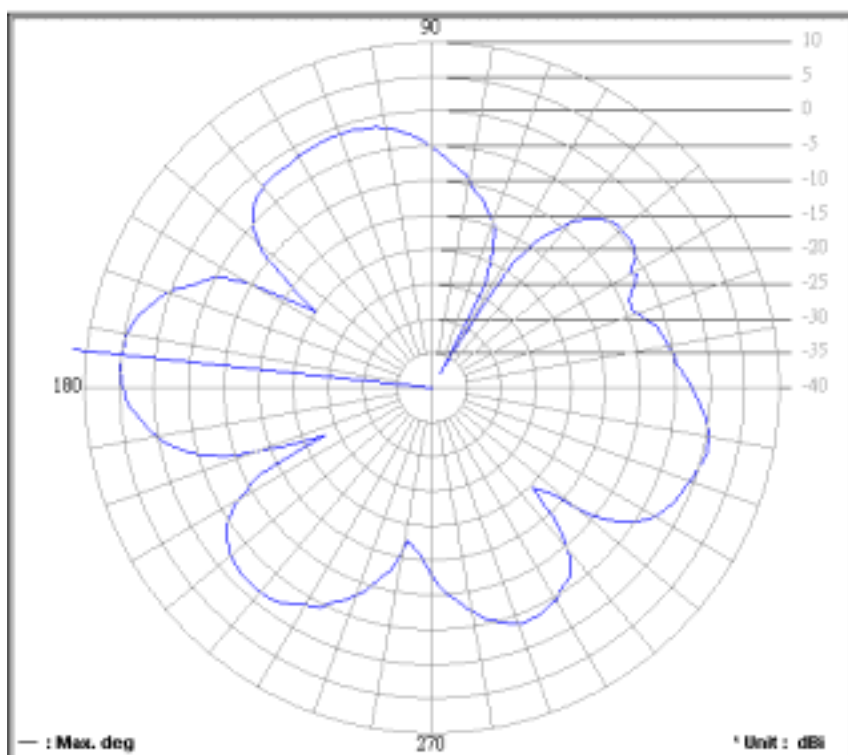

Frequency (MHz): **5150.00** Antenna Polarity: **Horizontal** Average Gain (dB): **-2.83**
 Maximum Gain (dB): **4.95** Maximum Gain (degree): **174**
 Minimum Gain (dB): **-37.51** Minimum Gain (degree): **60**

Test Report

Date : 2004/NOV/5 Tester: Nick

Model / P/n : FDP-ACBSMA-BL

Description : Dual Band B-SMA Paddle Antenna Black

Return Loss Test / VSWR



Smith



BILL OF MATERIAL

LEVEL	ITEM	GB P/N	SPECIFICATION	VENDER	QT'Y	MEMO
1	10	CW30039G054G	UUL 1354 80°C 30V COAXIAL CABLE 1.CONDUCTOR:30AWGx1C,SILVER PLATED COPPER WIRE. 2.INSULATION:FEP, OD=0.92±0.02mm, SELF-COLOR. 3.SHIELD:BRAID (16/5/0.05)TINNED PLATED COPPER WIRE,COVERAGE 90% MIN. 4.JACKET:FEP,OD=1.37±0.05mm,COLOR:BLACK GB COLOR:000 NO MARKING.	V-CN080	1mm	
1	20	W095095000AP	CARDBOARD.	V-CN080	0.000006pce	
1	30	Z100100100C00P	CARTON.	V-CN080	0.000001pce	

ELECTRICAL CHARACTERISTICS

ITEM	SPECIFICATION	MEMO																										
1	OPERATION TEMPERATURE:80°C																											
2	ELECTRICAL PROPERTIES: 2-1.INSULATION RESISTANCE:DC/250V 1000Mohm.m MIN.. 2-2.VOLTAGE RATING:30V. 2-3.WITHSTAND VOLTAGE:AC/500V RMS FOR ONE MINUTE. 2-4.CONDUCTOR RESISTANCE:LESS THAN 520ohm/KM(at 20°C) 2-5.CAPACITANCE:97pF/M(NOMINAL) 2-6.IMPEDANCE:50 ohm NOM @ TDR. 2-7: <table border="1" style="margin-left: 40px;"> <thead> <tr> <th colspan="2">NOM. ATTENUATION(dB/M)</th> </tr> </thead> <tbody> <tr><td>0.1GHz</td><td>0.5</td></tr> <tr><td>0.4GHz</td><td>1.0</td></tr> <tr><td>0.8GHz</td><td>1.5</td></tr> <tr><td>1.0GHz</td><td>1.6</td></tr> <tr><td>1.5GHz</td><td>2.0</td></tr> <tr><td>1.9GHz</td><td>2.3</td></tr> <tr><td>2.4GHz</td><td>2.6</td></tr> <tr><td>2.45GHz</td><td>2.7</td></tr> <tr><td>3.0GHz</td><td>2.9</td></tr> <tr><td>5.2GHz</td><td>4.0</td></tr> <tr><td>5.8GHz</td><td>4.3</td></tr> <tr><td>6.0GHz</td><td>4.3</td></tr> </tbody> </table>	NOM. ATTENUATION(dB/M)		0.1GHz	0.5	0.4GHz	1.0	0.8GHz	1.5	1.0GHz	1.6	1.5GHz	2.0	1.9GHz	2.3	2.4GHz	2.6	2.45GHz	2.7	3.0GHz	2.9	5.2GHz	4.0	5.8GHz	4.3	6.0GHz	4.3	
NOM. ATTENUATION(dB/M)																												
0.1GHz	0.5																											
0.4GHz	1.0																											
0.8GHz	1.5																											
1.0GHz	1.6																											
1.5GHz	2.0																											
1.9GHz	2.3																											
2.4GHz	2.6																											
2.45GHz	2.7																											
3.0GHz	2.9																											
5.2GHz	4.0																											
5.8GHz	4.3																											
6.0GHz	4.3																											

MECHANICAL CHARACTERISTICS

ITEM	SPECIFICATION	MEMO

NOTE

ITEM	SPECIFICATION	MEMO

DRAWN	DRAGON	GOLDEN BRIDGE ELECTECH INC.	DRAWING NO.	AS53-04080005-6	
ENGINEER	DUNNE		REVISION		
CHECKED	WINCO		UNIT	NONE	
APPROVED	JEFF		SCALE	NONE	
SAMPLE NO.	AS53-04080005-6	ORG:	UTE	PAGE NO.	2 OF 2
CUSTOMER:	啓碁科技	SPEC:	ROUND CABLE	DATE	2004.08.16
P/N:				FILE:	R:\SP\SP04\AS53-04080005-6A.DOC

ISSUE	QT'Y	ECN NO.	REVISED DESCRIPTION	DATE	APPROVED

UL 1354 COAXIAL CABLE

- 1.CONDUCTOR: 30AWGx1C,SILVER PLATED COPPER .
- 2.INSULATION:FEP, $\phi 0.92\pm 0.02$ mm, SELF-COLOR.
- 3.SHIELD: BRAID (16/5/0.05)TINNED PLATED COPPER WIRE,COVERAGE 90% MIN.
- 4.JACKET:FEP, $\phi 1.37\pm 0.05$ mm, COLOR:BLACK,GB COLOR:000,NO MARKING.

NOTE:

- 1.RATING TEMPERATURE: 80°C.
- 2.ELECTRICAL PROPERTIES:
 - 2-1.INSULATION RESISTANCE:DC/250V 1000Mohm.m MIN..
 - 2-2.VOLTAGE RATING :30V.
 - 2-3.WITHSTAND VOLTAGE: AC/500V RMS FOR ONE MINUTE.
 - 2-4.CONDUCTOR RESISTANCE:LESS THAN 330ohm/KM(at 20°C)
 - 2-5.CAPACITANCE: 96pF/M(NOMINAL)
 - 2-6.IMPEDANCE: 50ohm NOM@ TDR
 - 2-7.

NOM. ATTENUATION(dB/M)	
0.1GHz	0.5
0.4GHz	1.0
0.8GHz	1.5
1.0GHz	1.6
1.5GHz	2.0
1.9GHz	2.3
2.4GHz	2.6
2.45GHz	2.7
3.0GHz	2.9
5.2GHz	4.0
5.8GHz	4.3
6.0GHz	4.3

3.VENDOR: GOLDEN BRIDGE ELECTECH OR EQUIVALENT.

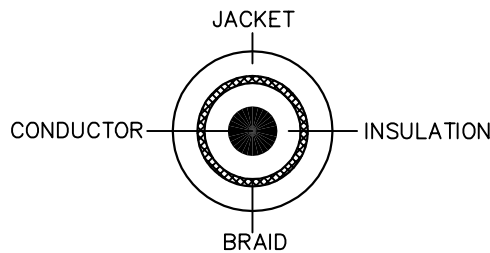

SYMBOL	QT'Y	DESCRIPTION
☒	0	CRITICAL DIMENSION
☐	0	MAJOR DIMENSION

DRAWN	DRAGON	GOLDEN BRIDGE ELECTECH INC.	DRAWING NO.	CW30039G054G
ENGINEER	DUNNE		REVISION	
CHECKED	WINCO		UNIT	mm
APPROVED	JEFF		SCALE	5:1
GENERAL TOLERANCE: >0.5~3= ±0.1 >30~120= ±0.3 >3~6= ±0.1 >120~315= ±0.5 >6~30= ±0.2 ANGLER= ±1°		DESC: 30AWGx1C	PAGE NO.	1 OF 2
		SPEC: FEP,BLACK $\phi 1.37$ mm, L=...	DATE	2004.02.24
			FILES:	R:\SAMPLE\C\CW30039G054G1.DWG



Test Report

GOLDEN BRIDGE ELECTECH INC.
 3F., NO.6, LANE 270, SEC.3, PEI SHEN RD., SHEN
 KENG, TAIPEI, TAIWAN, R.O.C.

Report No : CE/2004/31925
 Date : 2004/03/24
 Page : 1 of 1

The following merchandise was(were) submitted and identified by the client as :

Type of Product : MINI RF CABLE
Style/Item No : COAXIAL CABLE
Sample Received : 2004/03/17.
Testing Date : 2004/03/17 TO 2004/03/24

Test Result

PART NAME NO.1 : BLACK PLASTIC JACKET
 PART NAME NO.2 : GRAY PLASTIC JACKET
 PART NAME NO.3 : WHITE PLASTIC JACKET
 PART NAME NO.4 : TRANSPARENT PLASTIC INSULATION

Test Item(s):	Unit	Method	MDL	Result			
				NO.1	NO.2	NO.3	NO.4
PBBs(Polybrominated biphenyls)(CAS NO:67774-32-7)	%	With reference to 83/264/EEC. Analysis was performed by GC/MS.	0.0005	N.D.	N.D.	N.D.	N.D.
PBBEs(PBDEs)(Polybrominated biphenyl ethers)	%	With reference to 83/264/EEC. Analysis was performed by GC/MS.	0.0005	N.D.	N.D.	N.D.	N.D.

- NOTE: (1) N.D. = Not detected.(<MDL)
 (2) ppm = mg/kg
 (3) MDL= Method Detection Limit
 (4) " ---" = Not Applicable
 (5) " -" = Not Regulation
 (6) * = Results shown are of the adjusted analytical results.
 (7) **= Qualitative analysis(No Unit)
 (8) Negative = Undetectable / Positive = Detectable.

Daniel Yen, M.R. / Operation Manager
 Signed for and on behalf of
 SGS TAIWAN LTD.

This Test Report is issued by the Company subject to its General Conditions of Service printed overleaf. Attention is drawn to the limitations of liability, indemnification, and jurisdictional issues defined therein. The results shown in this test report refer only to the sample(s) tested unless otherwise stated. This Test Report cannot be reproduced, except in full, without prior written permission of the Company. 此報告係由本公司訂定之通用服務條款所製作與發放。請注意此報告所列之資訊，將本公司之名稱、商標、有版權之明細列明。此報告結果除亦列有說明關於檢驗之產品負責。本報告未經本公司蓋章許可，不可部份複製。

TW 0680577



Test Report

No.: GZSCR040931790/LP

Date: SEP 09, 2004

Page 1 of 1

DONGGUAN DACHEN ELECTRICAL PRODUCTS LTD.
HSIN FENG LU DON, HSIN CHENG DISTRICT,
SHEK KIT TOWN, DONG GUAN CITY, GUANG DONG

Report on the submitted sample said to be RF CABLE 镀锡编织铜丝 (镀锡铜)

SGS Ref No. : SZ040910232EC
Country of Origin : CHINA
Sample Receiving Date : SEP 03, 2004
Testing Period : SEP 03, 2004 TO SEP 08, 2004

Test Requested : As specified by client, to determine the Lead, Cadmium, Mercury & Hexavalent Chromium content in the submitted sample.

Test Method : Lead content – In-house method, with reference to EPA method 3050B: 1996.
Cadmium content – In-house method, with reference to BS EN1122: 2001 method B.
Mercury content – In-house method, with reference to EPA 3052: 1996.
Hexavalent Chromium content – with reference to EPA 3060A: 1996 & EPA 7196A: 1992.
Analysis was performed by Inductively Coupled Plasma Atomic Emission Spectrometer (ICP-AES) / UV-VIS Spectrophotometer.

RESULTS

Lead Content (Pb)(ppm)	7
Cadmium Content (Cd)	N.D.
Mercury Content (Hg)	N.D.
Hexavalent Chromium Content [Cr(VI)]	N.D.

Note : - N.D. = Not Detected (< 2 ppm)
- ppm = mg/kg

*** End of Report ***

Signed for and on behalf of
SGS-CSTC Ltd.

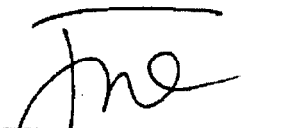
He Xiaoyan, Jane
Tech Manager

This Test Report is issued by the Company subject to its General Conditions of Service printed overleaf or attached. Said Conditions are also available upon request or are accessible at www.sgs.com. Attention is drawn to the limitations of liability, indemnification and jurisdictional policies defined therein. The results shown in this Test Report refer only to the sample(s) tested unless otherwise stated and such sample(s) are retained for 30 days only. This Test Report shall not be reproduced except in full, without written approval of the Company.

GZCM 150809

SGS**Test Report**

No.: GZSCR040307948/LP

Date: MAR 15, 2004 Page 1 of 1

DONGGUAN DACHEN ELECTRICAL PRODUCTS LTD
HSIN FENG LU DON, HSIN CHENG DISTRICT,
SHEK KIT TOWN, DONGGUAN CITY,
GUANGDONG, PEOPLE REPUBLIC OF CHINA

Report on the submitted sample said to be RF1.13 & 1.37 BRAID (镀银铜丝)

SGS Ref No. : SZ040302401EC-5.1
Manufacture / Supplier : GBE
Country of Destination : CHINA
Sample Receiving Date : MAR 14, 2004
Testing Period : MAR 15, 2004 TO MAR 15, 2004

Test Requested : As specified by client, to determine the Lead, Cadmium, Mercury & Hexavalent Chromium content in the submitted sample.

Test Method : Lead content - In-house method .
Cadmium content - In-house method ..
Mercury content - In-house method .
Hexavalent Chromium content - with reference to EPA 3060A & EPA 7196A .
Analysis was performed by inductively Coupled Plasma Atomic Emission Spectrometer (ICP-AES) / UV-VIS Spectrophotometer.

RESULTS**Silvery metal wire**

Lead content (Pb)	N.D.
Cadmium Content (Cd)	N.D.
Mercury Content (Hg)	N.D.
Hexavalent Chromium Content [Cr(VI)]	N.D.

Note : - N.D. = Not Detected (< 2 ppm)
- ppm = mg/kg

*** End of Report ***

Signed for and on behalf of
SGS-CSTC Ltd.



He Xiaoyan, Jane
Tech. Manager

This Test Report is issued by the Company subject to its General Conditions of Service printed overleaf or attached. Said Conditions are also available upon request or are accessible at www.sgs.com. Attention is drawn to the limitations of liability, indemnification and jurisdictional policies defined therein. The results shown in this Test Report refer only to the sample(s) tested unless otherwise stated and such sample(s) are retained for 30 days only. This Test Report shall not be reproduced except in full, without written approval of the Company.

GZCM 121235

SGS

Test Report

No.: GZSCR040307949/LP

Date: MAR 15, 2004

Page 1 of 1

DONGGUAN DACHEN ELECTRICAL PRODUCTS LTD
HSIN FENG LU DON, HSIN CHENG DISTRICT,
SHEK KIT TOWN, DONGGUAN CITY,
GUANGDONG, PEOPLE REPUBLIC OF CHINA

Report on the submitted sample said to be RF1.13 CONDUCTOR (镀银铜丝)

SGS Ref No. : SZ040302401EC-5.2
Manufacture / Supplier : GBE
Country of Destination : CHINA
Sample Receiving Date : MAR 14, 2004
Testing Period : MAR 15, 2004 TO MAR 15, 2004

Test Requested : As specified by client, to determine the Lead, Cadmium, Mercury & Hexavalent Chromium content in the submitted sample.

Test Method : Lead content - In-house method .
Cadmium content - In-house method ..
Mercury content - In-house method .
Hexavalent Chromium content - with reference to EPA 3060A & EPA 7196A .
Analysis was performed by Inductively Coupled Plasma Atomic Emission Spectrometer (ICP-AES) / UV-VIS Spectrophotometer.

RESULTS

	<u>Silvery metal wire</u>
Lead content (Pb)	N.D.
Cadmium Content (Cd)	N.D.
Mercury Content (Hg)	N.D.
Hexavalent Chromium Content [Cr(VI)]	N.D.

Note : - N.D. = Not Detected (< 2 ppm)
- ppm = mg/kg

*** End of Report ***

Signed for and on behalf of
SGS-CSTC Ltd.

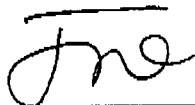

He Xiaoyan, Jane
Tech. Manager

This Test Report is issued by the Company subject to its General Conditions of Service printed overleaf or attached. Said Conditions are also available upon request or are accessible at www.sgs.com. Attention is drawn to the limitations of liability, indemnification and jurisdictional policies defined therein. The results shown in this Test Report refer only to the sample(s) tested unless otherwise stated and such sample(s) are retained for 30 days only. This Test Report shall not be reproduced except in full, without written approval of the Company.

GZCM 121236

Web Hong Sheng 0769-6631811

SGS

Test Report

No.: GZSCR040307950/LP

Date: MAR 15, 2004

Page 1 of 1

DONGGUAN DACHEN ELECTRICAL PRODUCTS LTD
HSIN FENG LU DON, HSIN CHENG DISTRICT,
SHEK KIT TOWN, DONGGUAN CITY,
GUANGDONG, PEOPLE REPUBLIC OF CHINA

Report on the submitted sample said to be RF1.37 CONDUCTOR (镀银铜丝)

SGS Ref No. : SZ040302401EC-5.3
Manufacture / Supplier : GBE
Country of Destination : CHINA
Sample Receiving Date : MAR 14, 2004
Testing Period : MAR 15, 2004 TO MAR 15, 2004

Test Requested : As specified by client, to determine the Lead, Cadmium, Mercury & Hexavalent Chromium content in the submitted sample.

Test Method : Lead content - In-house method .
Cadmium content - In-house method ..
Mercury content - In-house method .
Hexavalent Chromium content - with reference to EPA 3060A & EPA 7196A .
Analysis was performed by Inductively Coupled Plasma Atomic Emission Spectrometer (ICP-AES) / UV-VIS Spectrophotometer.

RESULTS

Silvery metal wire

Lead content (Pb)	N.D.
Cadmium Content (Cd)	N.D.
Mercury Content (Hg)	N.D.
Hexavalent Chromium Content [Cr(VI)]	N.D.

Note : - N.D. = Not Detected (< 2 ppm)
- ppm = mg/kg

*** End of Report ***

Signed for and on behalf of
SGS-CSTC Ltd.

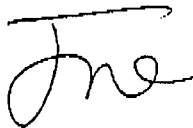

He Xiaoyan, Jane
Tech. Manager

This Test Report is issued by the Company subject to its General Conditions of Service printed overleaf or attached. Said Conditions are also available upon request or are accessible at www.sgs.com. Attention is drawn to the limitations of liability, indemnification and jurisdictional policies defined therein. The results shown in this Test Report refer only to the sample(s) tested unless otherwise stated and such sample(s) are retained for 30 days only. This Test Report shall not be reproduced except in full, without written approval of the Company.

GZCM 121237



Test Report

同皇實業股份有限公司
717 台南縣 路174號

報告號碼 : CE/2005/20551A
日期 : 2005/02/15
頁數 : 1 of 2

以下測試樣品乃供應廠商所提供及確認：

樣品名稱 :
產品型號 : SMA外殼
收件日期 : 2005/02/03.
測試日期 : 2005/02/03 TO 2005/02/15

測試結果

測試部位 NO.1 : 黑色金屬(請參照附件圖片)

測試項目:	單位	測試方法	偵測極限值	結果
				NO.1
六價鉻	ppm	依照US EPA 3060A方法,用UV-VIS做分析	2	N.D.
鎘	ppm	依照 EN1122 方法B:2001或其他酸消化方法,用感應耦合電漿原子發射光譜儀(ICP-AES)做分析	2	16.3
汞	ppm	依照 US EPA 3052 方法或其他酸消化方法,用感應耦合電漿原子發射光譜儀(ICP-AES)做分析	2	N.D.
鉛	ppm	依照 US EPA 3050B 方法或其他酸消化方法,用感應耦合電漿原子發射光譜儀(ICP-AES)做分析	2	37136.2

備註：(1) N.D. = Not detected.(<MDL) / 未檢出(低於偵測極限值)

(2) ppm = mg/kg / 百萬分之一

(3) MDL= Method Detection Limit(偵測極限值)

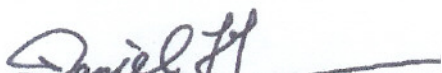
Daniel Yeh, M.R. / Operation Mans
Signed for and on behalf of
SGS TAIWAN LTD.



Test Report

同皇實業股份有限公司
717 台南縣仁德鄉忠義路174號

報告號碼 : CE/2005/20551
日期 : 2005/02/15
頁數 : 2 of 2



This Test Report is issued by the Company subject to its General Conditions of Service printed overleaf. Attention is drawn to the limitations of liability, indemnification, jurisdictional issues defined therein. The results shown in this test report refer only to the sample(s) tested unless otherwise stated. This Test Report cannot be reproduced, except in full, without prior written permission of the Company. 此報告是遵照本公司訂定之通用服務條款所製作發放。請注意此條款列印於背面。將本公司之免責、管轄權皆明確規範之。此報告結果除非另有說明僅對檢驗之樣品負責。本報告未經本公司書面許可，不可部份複製。

TW 1848



Test Report

CONNEKT PRECISION ELECTRONICS CO., LTD
NO.115, HSIN TIEW RD., JENTE HSIANG, TAINAN HSIEN,
TAIWAN R.O.C.

Report No. : CE/2005/51151
Date : 2005/05/16
Page : 1 of 4

The following merchandise was (were) submitted and identified by the client as :

Type of Product : TEFLON
Style/Item No : ZLA-7529RP-4
Sample Received : 2005/05/09
Testing Date : 2005/05/09 TO 2005/05/16

=====
Test Result : - Please see the next page -

Daniel Yeh, M.R. / Operation Manager
Signed for and on behalf of
SGS TAIWAN LTD.



Test Report

CONNEKT PRECISION ELECTRONICS CO., LTD
 NO.115, HSIN TIEW RD., JENTE HSIANG, TAINAN HSIEN,
 TAIWAN R.O.C.

Report No. : CE/2005/51151
 Date : 2005/05/16
 Page : 2 of 4

Test Result

PART NAME NO.1 : WHITE PLASTIC (PLEASE REFER TO THE PHOTO ATTACHED)

Test Item (s):	Unit	Method	MDL	Result
				No.1
Monobromobiphenyl	%	With reference to USEPA3540C or USEPA3550C. Analysis was performed by HPLC/DAD, LC/MS or GC/MS. (prohibited by 2002/95/EC (RoHS), 83/264/EEC, and 76/769/EEC)	0.0005	N.D.
Dibromobiphenyl	%		0.0005	N.D.
Tribromobiphenyl	%		0.0005	N.D.
Tetrabromobiphenyl	%		0.0005	N.D.
Pentabromobiphenyl	%		0.0005	N.D.
Hexabromobiphenyl	%		0.0005	N.D.
Heptabromobiphenyl	%		0.0005	N.D.
Octabromobiphenyl	%		0.0005	N.D.
Nonabromobiphenyl	%		0.0005	N.D.
Decabromobiphenyl	%		0.0005	N.D.
Total PBBs (Polybrominated biphenyls)/Sum of above	%		-	N.D.
Monobromobiphenyl ether	%	With reference to USEPA3540C or USEPA3550C. Analysis was performed by HPLC/DAD, LC/MS or GC/MS. (prohibited by 2002/95/EC (RoHS), 83/264/EEC, and 76/769/EEC)	0.0005	N.D.
Dibromobiphenyl ether	%		0.0005	N.D.
Tribromobiphenyl ether	%		0.0005	N.D.
Tetrabromobiphenyl ether	%		0.0005	N.D.
Pentabromobiphenyl ether	%		0.0005	N.D.
Hexabromobiphenyl ether	%		0.0005	N.D.
Heptabromobiphenyl ether	%		0.0005	N.D.
Octabromobiphenyl ether	%		0.0005	N.D.
Nonabromobiphenyl ether	%		0.0005	N.D.
Decabromobiphenyl ether	%		0.0005	N.D.
Total PBDEs(PBDEs)(Polybrominated biphenyl ethers)/Sum of above	%		-	N.D.



Test Report

CONNEKT PRECISION ELECTRONICS CO., LTD
NO.115, HSIN TIEW RD., JENTE HSIANG, TAINAN HSIEN,
TAIWAN R.O.C.

Report No. : CE/2005/51151
Date : 2005/05/16
Page : 3 of 4

Test Item (s):	Unit	Method	MDL	Result
				No.1
Chromium VI (Cr+6)	ppm	UV-VIS after reference to US EPA 3060A.	2	N.D.
Cadmium (Cd)	ppm	ICP-AES after reference to EN 1122, method B:2001 or other acid digestion.	2	N.D.
Mercury (Hg)	ppm	ICP-AES after reference to US EPA 3052 or other acid digestion.	2	N.D.
Lead (Pb)	ppm	ICP-AES after reference to US EPA 3050B or other acid digestion.	2	N.D.

- NOTE: (1) N.D. = Not detected (<MDL)
(2) ppm = mg/kg
(3) MDL = Method Detection Limit
(4) " - " = No Regulation
(5) " --- " = Not Applicable

Test Report

CONNEKT PRECISION ELECTRONICS CO., LTD
NO.115, HSIN TIEW RD., JENTE HSIANG, TAINAN HSIEN,
TAIWAN R.O.C.

Report No. : CE/2005/51151
Date : 2005/05/16
Page : 4 of 4





Test Report

LONG CHENG TECH. INT'L. CO., LTD.
3F, NO. 3, ALLEY 15, LANE 62, CHUNG HO ST., JUBEI
CITY, HSINCHU HSIEN, TAIWAN, R.O.C.

Report No. : CE/2005/52882
Date : 2005/05/23
Page : 1 of 3

The following merchandise was (were) submitted and identified by the client as :

Type of Product : PVC TUBE
Sample Received : 2005/05/16
Testing Date : 2005/05/16 TO 2005/05/23

=====
Test Result : - Please see the next page -

Daniel Yeh, M.R. / Operation Manager
Signed for and on behalf of
SGS TAIWAN LTD.



Test Report

LONG CHENG TECH. INT'L. CO., LTD.
 3F, NO. 3, ALLEY 15, LANE 62, CHUNG HO ST., JUBEI
 CITY, HSINCHU HSIEN, TAIWAN, R.O.C.

Report No. : CE/2005/52882
 Date : 2005/05/23
 Page : 2 of 3

Test Result

PART NAME NO.1 : TRANSPARENT PVC TUBE (PLEASE REFER TO THE PHOTO ATTACHED)

Test Item (s):	Unit	Method	MDL	Result
				No.1
Monobromobiphenyl	%	With reference to USEPA3540C or USEPA3550C. Analysis was performed by HPLC/DAD, LC/MS or GC/MS. (prohibited by 2002/95/EC (RoHS), 83/264/EEC, and 76/769/EEC)	0.0005	N.D.
Dibromobiphenyl	%		0.0005	N.D.
Tribromobiphenyl	%		0.0005	N.D.
Tetrabromobiphenyl	%		0.0005	N.D.
Pentabromobiphenyl	%		0.0005	N.D.
Hexabromobiphenyl	%		0.0005	N.D.
Heptabromobiphenyl	%		0.0005	N.D.
Octabromobiphenyl	%		0.0005	N.D.
Nonabromobiphenyl	%		0.0005	N.D.
Decabromobiphenyl	%		0.0005	N.D.
Total PBBs(Polybrominated biphenyls)/Sum of above	%		-	N.D.
Monobromobiphenyl ether	%	With reference to USEPA3540C or USEPA3550C. Analysis was performed by HPLC/DAD, LC/MS or GC/MS. (prohibited by 2002/95/EC (RoHS), 83/264/EEC, and 76/769/EEC)	0.0005	N.D.
Dibromobiphenyl ether	%		0.0005	N.D.
Tribromobiphenyl ether	%		0.0005	N.D.
Tetrabromobiphenyl ether	%		0.0005	N.D.
Pentabromobiphenyl ether	%		0.0005	N.D.
Hexabromobiphenyl ether	%		0.0005	N.D.
Heptabromobiphenyl ether	%		0.0005	N.D.
Octabromobiphenyl ether	%		0.0005	N.D.
Nonabromobiphenyl ether	%		0.0005	N.D.
Decabromobiphenyl ether	%		0.0005	N.D.
Total PBBEs(PBDEs)(Polybrominated biphenyl ethers)/Sum of above	%		-	N.D.

- NOTE: (1) N.D. = Not detected (<MDL)
 (2) ppm = mg/kg
 (3) MDL = Method Detection Limit
 (4) " - " = No Regulation

Test Report

LONG CHENG TECH. INT'L. CO., LTD.
3F, NO. 3, ALLEY 15, LANE 62, CHUNG HO ST., JUBEI
CITY, HSINCHU HSIEN, TAIWAN, R.O.C.

Report No. : CE/2005/52882
Date : 2005/05/23
Page : 3 of 3



测试报告

编号: GZSCR050312622/LP

日期: 2005年3月18日 页码 1 of 1

千島金属制品有限公司
东莞市塘厦镇新太阳工业城第二座

本报告是基于所提供的名称为“Sn96.5/Ag3/Cu0.5 无铅锡条”的样品所做的测试

SGS 参考编号 : GZ050302410EC-5.1
收板日期 : 2005年3月14日
测试日期 : 2005年3月14日至2005年3月18日

测试要求 : 分析委托样品中的铅、镉、汞和六价铬含量。

测试方法 : 铅含量 - SGS 内部方法, 参照 EPA 方法 3050B:1996
镉含量 - SGS 内部方法, 参照 BS EN1122:2001 方法 B.
汞含量 - SGS 内部方法, 参照 EPA 方法 3052:1996.
六价铬含量 - 参照 EPA 方法 3060A:1996 和 7196A:1992
分析仪器为电感耦合等离子体发射光谱仪/紫外分光光度计。

测试结果:

	银色金属条
铅含量 (Pb)(ppm)	190
镉含量 (Cd)	N.D.
汞含量 (Hg)	N.D.
六价铬含量 [Cr(VI)]	N.D.

说明: - N.D. = 没有检测到 (< 2 ppm)
- ppm = 毫克/千克

*** 报告完 ***

Signed for and on behalf of
SGS-CSTC Ltd.

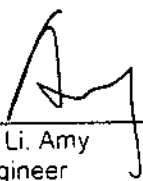
Zhang Li, Amy
Sr. Engineer



This Test Report is issued by the Company subject to its General Conditions of Service printed overleaf or attached. Said Conditions are also available upon request or are accessible at www.sgs.com. Attention is drawn to the limitations of liability, indemnification and jurisdictional policies defined therein. The results shown in this Test Report refer only to the sample(s) tested unless otherwise stated and such sample(s) are retained for 30 days only. This Test Report shall not be reproduced except in full, without written approval of the Company.

GZCM 224593



Test Report

No. 2091267/LD

Date : Jul 27 2004

Page 1 of 2

THOUSAND ISLAND METAL FOIL MANUFACTURING COMPANY
NEW SUN IND., LINCUN,
TANGXIA TOWN,
DONGGUAN CITY,
CHINA

Report on the submitted samples said to be QIAN DAO LEAD FREE FLUX.

SGS Job No.	:	1576288
SGS Ref. No.	:	SZECO040707806EC
Buyer	:	AOC ELECTRONIC CO.
Sample Receiving Date	:	JUL 13 2004
Testing Period	:	JUL 14-23 2004

Test Requested : 1) To determine the Cadmium Content in the submitted sample.
 2) To determine the Lead Content on the submitted sample.
 3) To determine the Mercury Content on the submitted sample.
 4) To determine the Hexavalent Chromium Content on the submitted sample.
 5) Determination of PBBs (polybrominated biphenyls), PBDEs (Polybrominated diphenylethers) of the submitted sample.

Test Method : 1) With reference to BS EN 1122:2001, Method B, analysis was performed by Inductively Coupled Argon Plasma-Atomic Emission Spectrometry (ICP-AES).
 2) As specified in EPA Method 3050B. Analysis was performed by Inductively Coupled Argon Plasma-Atomic Emission Spectrometry (ICP-AES).
 3) As specified in EPA Method 3052. Analysis was performed by Inductively Coupled Argon Plasma-Atomic Emission Spectrometry (ICP-AES).
 4) As specified in EPA Method 3060A & 7196A. The samples were alkaline digested by using EPA Method 3060A, and then analyzed by using Colorimetric method 7196A.
 5) With reference to SGS in-house method. Analysis was performed by GC/MS.

Test Results : 1-5) Please refer to next page.

Signed for and on behalf of
SGS Hong Kong Ltd



Lee Fung Mai, Miranda
Senior Manager

This Test Report is issued by the Company subject to its General Conditions of Service printed overleaf. Attention is drawn to the limitations of liability, indemnification and jurisdictional issues defined therein. The results shown in this test report refer only to the sample(s) tested unless otherwise stated. This Test Report cannot be reproduced, except in full, without prior written permission of the Company.

H10863526

Test Results

Element

1) Cadmium (Cd)	< 2 ppm
2) Lead (Pb)	< 2 ppm
3) Mercury (Hg)	< 2 ppm
4) Hexavalent Chromium (Cr ⁶⁺)	< 2 ppm

(Results shown are of the total weight of samples)

Note : < = Less than
ppm = mg/kg

Flame Retardants	1	Detection Limit
Polybrominated Biphenyls (PBBs)	—	—
Monobromobiphenyl	ND	5 ppm
Di-bromobiphenyl	ND	5 ppm
Tri-bromobiphenyl	ND	5 ppm
Tetra-bromobiphenyl	ND	5 ppm
Penta-bromobiphenyl	ND	5 ppm
Hexa-bromobiphenyl	ND	5 ppm
Hepta-bromobiphenyl	ND	5 ppm
Octa-bromobiphenyl	ND	5 ppm
Nona-bromobiphenyl	ND	5 ppm
Deca-bromobiphenyl	ND	5 ppm
Polybrominated Diphenylethers (PBDEs)	—	—
Monobromodiphenyl ether	ND	5 ppm
Dibromodiphenyl ether	ND	5 ppm
Tribromodiphenyl ether	ND	5 ppm
Tetra-bromodiphenyl ether	ND	5 ppm
Penta-bromodiphenyl ether	ND	5 ppm
Hexa-bromodiphenyl ether	ND	5 ppm
Hepta-bromodiphenyl ether	ND	5 ppm
Octa-bromodiphenyl ether	ND	5 ppm

Note: ND = Not Detected

Non-detected is lower than detection limit value.

Sample Description:

- Transparent Lt. Yellow Liquid

Remark : This report is to supersede test report number 2090099/LD.

*** End of Report ***

This Test Report is issued by the Company subject to its General Conditions of Service printed overleaf. Attention is drawn to the limitations of liability, indemnification and jurisdictional issues defined therein. The results shown in this test report refer only to the sample(s) tested unless otherwise stated. This Test Report cannot be reproduced, except in full, without prior written permission of the Company.

H10883526



测试报告

编号: GZSCR050312626/LP

日期: 2005年3月18日 页码 1 of 1

千島金属锡品有限公司
东莞市塘厦镇新太阳工业城第二座

本报告是基于所提供的名称为“Sn96.5/Ag3/Cu0.5 无铅锡线”的样品所做的测试

SGS 参考编号 : GZ050302410EC-5.5
收板日期 : 2005年3月14日
测试日期 : 2005年3月14日至2005年3月18日

测试要求 : 分析委托样品中的铅, 镉, 汞和六价铬含量.

测试方法 : 铅含量 - SGS 内部方法, 参照 EPA 方法 3050B:1996.
镉含量 - SGS 内部方法, 参照 BS EN1122:2001 方法 B,
汞含量 - SGS 内部方法, 参照 EPA 方法 3052:1996.
六价铬含量 - 参照 EPA 方法 3060A:1996 和 7196A:1992.
分析仪器为电感耦合等离子体发射光谱仪/紫外分光光度计。

测试结果:

	银色金属线
铅含量 (Pb)(ppm)	188
镉含量 (Cd)	N.D.
汞含量 (Hg)	N.D.
六价铬含量 [Cr(VI)]	N.D.

说明: - N.D. = 没有检测到 (< 2 ppm)
- ppm = 毫克/千克

*** 报告完 ***

Signed for and on behalf of
SGS-CSTC Ltd.

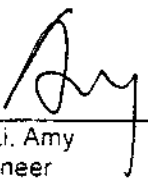
Zhang Li Amy
Sr Engineer



**GE Plastics**

GE Plastics
One Plastics Avenue
Pittsfield, MA 01201
(413) 448-5800

CYCOLOY[®] C6200

North America: Commercial

[Design Solution Center](#) >> [Design Tools](#) >> [Datasheets](#)

ABS+PC, nonchlorinated, nombrominated flame retardant. Recommended for thin-wall applications

Processing

INJECTION MOULDING-USA

CLY-IM-03

Drying Temperature	180-190	deg F
Drying Time (basic)	3-4	h
Drying Time (cumulative)	8	h
Moisture Content, Max	0.04	%
Moisture Content, Min	-	%
Melt Temperature	470-530	deg F
Nozzle Temperature	470-530	deg F
Front Temperature	470-530	deg F
Middle Temperature	430-510	deg F
Rear Temperature	430-490	deg F
Mold Temperature	140-180	deg F
Back Pressure	50-100	psi
Screw Speed	40-70	rpm
Suggested shot size	30-80	%
Clamp Tonnage	3-5	tons/psi
Vent Depth	.0015-.003	inch

Source Eris, last updated: 2001/11/06

CYCOLOY[®] C6200

North America: Commercial

ABS+PC, nonchlorinated, nombrominated flame retardant. Recommended for thin-wall applications

Properties

MECHANICAL

Property	Typical Data	Unit	Method
Tensile Str, yld, Type I, 2.0 in/min	9700	psi	ASTM D 638
Tensile Elong, brk, Type I, 2.0 in/min	50.0	%	ASTM D 638
Flex Stress, yld, 0.10 in/min, 4" span	15000	psi	ASTM D 790
Flex Mod, 0.10 in/min, 4" span	390000	psi	ASTM D 790

IMPACT

Property	Typical Data	Unit	Method
Izod Impact, notched, 73F	10.0	ft-lb/in	ASTM D 256
Instrumented Impact Energy @ peak, 73F	540	in-lbs	ASTM D 3763
Instrumented Impact Energy @ peak, -22F	480	in-lbs	ASTM D 3763

THERMAL

Property	Typical Data	Unit	Method
----------	--------------	------	--------

HDT, 264 psi, 0.125", unannealed	190 deg F	ASTM D 648
HDT, 264 psi, 0.250", unannealed	195 deg F	ASTM D 648
Thermal Index, Elec Prop	85 deg C	UL 746B
Thermal Index, Mech Prop with impact	85 deg C	UL 746B
Thermal Index, Mech prop without impact	85 deg C	UL 746B

PHYSICAL

Property	Typical Data	Unit	Method
Specific Gravity, solid	1.18	-	ASTM D 792
Mold Shrinkage, flow, 0.125"	4-6	in/in E-3	ASTM D 955
Mold Shrinkage, xflow, 0.125"	4-6	in/in E-3	ASTM D 955
Melt Flow Rate, 260C/2.16 kgf	14.5	g/10 min	ASTM D 1238
□ Spiral Flow, 500F, 10 ips, .125 X 60 in	27.0	in	-

ELECTRICAL

Property	Typical Data	Unit	Method
Arc Resistance, Tungsten (+/- 0.125")	6	PLC Code	ASTM D 495
Hot Wire Ignition (+/- 0.125")	2	PLC Code	UL 746A
High Voltage Arc Track Rate (+/- 0.125")	3	PLC Code	UL 746A
High Amp Arc Ign, surface (+/- 0.125")	0	PLC Code	UL 746A
Comparative Track Index (+/- 0.125")	2	PLC Code	UL 746A
Volume Resistivity	>1E15	Ohm-cm	IEC 60093
Surface Resistivity, ROA	>1E15	Ohm/Sq	IEC 60093
Dielectric Strength, in oil, 0.8 mm	35	kV/mm	IEC 60243-1
Dielectric Strength, in oil, 1.6 mm	25.0	kV/mm	IEC 60243-1
Dielectric Strength, in oil, 3.2 mm	17.0	KV/mm	IEC 60243-1
Relative Permittivity, 50 Hz	2.8	-	IEC 60250
Relative Permittivity, 1 MHz	2.7	-	IEC 60250
Dissipation Factor, 50 Hz	0.0040	-	IEC 60250
Dissipation Factor, 1 MHz	0.0080	-	IEC 60250

FLAME CHARACTERISTICS

Property	Typical Data	Unit	Method
UL File Number, GLOBAL	E161759	-	-
UL File Number, USA	E121562	-	-
HB Rated (tested thickness)	0.028	inch	UL 94
V-1 Rated (tested thickness)	0.048	inch	UL 94
V-0 Rated (tested thickness)	0.058	inch	UL 94
5VA Rating (tested thickness)	0.134	inch	UL 94
5VB Rating (tested thickness)	0.079	inch	UL 94
CSA (See File for complete listing)	LS88480	File No.	CSA LISTED

Source Eris, last updated: 2001/11/06

THESE PROPERTY VALUES ARE NOT INTENDED FOR SPECIFICATION PURPOSES.

Disclaimer: THE MATERIALS AND PRODUCTS OF THE BUSINESSES MAKING UP THE GE PLASTICS UNIT OF GENERAL ELECTRIC COMPANY, ITS SUBSIDIARIES AND AFFILIATES ("GEP"), ARE SOLD SUBJECT TO GEP'S STANDARD CONDITIONS OF SALE, WHICH ARE INCLUDED IN THE APPLICABLE DISTRIBUTOR OR OTHER SALES



Wenbin Ouyang
Product Stewardship & Compliance
Greater China

GE Plastics, Greater China
No. 58 Aida Rd, Waigaoqiao Free Trade Zone
Shanghai 200131
The People's Republic of China
Tel: +86-(21)-50460000 ext 3906
Fax: +86-(21)-50450100
Internet: Arnold.Ouyang@gepex.ge.com

February 9th, 2004

Declaration on GE Plastics

Dear Most Valued Customer:

Thank you for using GE Plastics. It is herewith declared that GE Plastics, Greater China does not use any of the following constituents in the confidential and proprietary production of its resin products of LEXAN[®], NORYL[®], CYCOLOY[®], CYCOLAC[®], ULTEM[®], VALOX[®], and XENOY[®].

- | | | |
|--|--|--|
| 1. Cadmium and its compounds | 24. Benzene | 45. Perchloroethylene (Per) |
| 2. Lead and its compounds | 25. Beryllium compounds | 46. Pesticides |
| 3. Mercury and its compounds | 26. Chlorinated fluorocarbons (CFCs/PCKW) | 47. Picric acid |
| 4. Hexavalent chromium compounds | 27. Chlorinated paraffins | 48. Polybrominated biphenyls (PBBs) |
| 5. 1,1,1,2-Tetrachloroethane | 28. Diarylide pigments | 49. Polybrominated diphenyl ethers (PBDEs) |
| 6. 1,1,1-Trichloroethane | 29. N,N-dimethylacetamide (DMA) | 50. Polychlorinated biphenyls (PCBs) |
| 7. 1,1,2,2-Tetrachloroethane | 30. N,N-dimethylformamide (DMF) | 51. Polychlorinated naphthalenes (PCNs) |
| 8. 1,1,2-Trichloroethane | 31. Formaldehyde | 52. Polychlorinated terphenyls (PCTs) |
| 9. 1,2,3-Trichloropropane | 32. Fungicides | 53. Polycyclic aromatic hydrocarbons |
| 10. 1,2,5,6,9,10-Hexabromocyclodecane | 33. Glycol ethers and glycol ether acetates | 54. Polyvinyl chloride |
| 11. 1,2-Dibromoethane | 34. Halogenated dioxins and furans | 55. Selenium compounds |
| 12. 1,1-Dichloroethylene | 35. Halogenated dibenzodioxins and dibenzofurans | 56. Tar oils |
| 13. 1,2-Dichloroethane | 36. Halosis | 57. Tellurium compounds |
| 14. 2,4,6-Tri-tert-butylphenol | 37. Hydrazines | 58. Tetrabromobisphenol-A, bis(2,3-dibromopropyl ether) (e.g. FR-720, PE-68) |
| 15. 2-Naphthylamine or its salts | 38. Hydrochlorofluorocarbons (HCFCs/HFCKW) | 59. Thallium compounds |
| 16. 3,3'-Dichloro-4,4'-diaminodiphenylethane | 39. Metal carbonyls | 60. Trichloroethylene (Tri) |
| 17. 4,4-Methylenebis(2-chloroaniline) | 40. N-methylacetamide (NME) | 61. Vinyl chloride |
| 18. 4-Aminobiphenyl and its chlorides | 41. N-methylformamide (NMF) | 62. Xylenes |
| 19. 4-Aminodiphenyl | 42. Nitrosamine | |
| 20. 4-chloro-2-methylaniline and its salt | 43. Organic Tin Compounds (Tributyl tin and Triphenyl tin) | |
| 21. 4-Nitrodiphenyl and the salts | 44. Pentachlorophenols or its salts | |
| 22. Arsenic compounds | | |
| 23. Asbestos | | |

Please be noted that any incidental presence of the above substances would have to be described as an uncontrollable impurity and would only be present at trace level.

I trust the above information will be of use to you. Should you need further information, you may contact me at the address shown above. Thank you.

Yours faithfully,

Wenbin Ouyang, Ph.D. for GE Plastics

DISCLAIMER: THE MATERIALS AND PRODUCTS OF THE BUSINESSES MAKING UP THE GE PLASTICS UNIT OF GENERAL ELECTRIC COMPANY, ITS SUBSIDIARIES AND AFFILIATES, INCLUDING WITHOUT LIMIT, GE POLYMERLAND, INC. ("GEP") ARE SOLD SUBJECT TO GEP'S STANDARD CONDITIONS OF SALE WHICH ARE INCLUDED IN THE APPLICABLE DISTRIBUTOR OR OTHER SALES AGREEMENT, PRINTED ON THE BACK OF ORDER ACKNOWLEDGMENTS AND INVOICES, AND AVAILABLE UPON REQUEST. ALTHOUGH ANY INFORMATION, RECOMMENDATIONS, OR ADVICE CONTAINED HEREIN IS GIVEN IN GOOD FAITH, GEP MAKES NO WARRANTY OR GUARANTEE, EXPRESS OR IMPLIED, (I) THAT THE RESULTS DESCRIBED HEREIN WILL BE OBTAINED UNDER END-USE CONDITIONS, OR (II) AS TO THE EFFECTIVENESS OF SAFETY OF ANY DESIGN INCORPORATING GEP MATERIALS, PRODUCTS, RECOMMENDATIONS OR ADVICE. EXCEPT AS PROVIDED IN GEP'S STANDARD CONDITIONS OF SALE, GEP AND ITS REPRESENTATIVES SHALL IN NO EVENT BE RESPONSIBLE FOR ANY LOSS RESULTING FROM ANY USE OF ITS MATERIALS OR PRODUCTS DESCRIBED HEREIN. Each user bears full responsibility for making its own determination as to the suitability of GEP's materials, products, recommendations, or advice for its own particular use. Each user must identify and perform all tests and analyses necessary to assure that its finished parts incorporating GEP materials, or products will be safe and suitable for use under end-use conditions. Nothing in this or any other document, nor any oral recommendation or advice, shall be deemed to alter, vary, supersede, or waive any provision of GEP's Standard Conditions of Sale or this Disclaimer, unless any such modification is specially agreed to in a writing signed by GEP. No statement contained herein concerning a possible or suggested use of any materials, products, or design is intended, or should be construed, to grant any license under any patent or other intellectual property right of General Electric Company or any of its subsidiaries or affiliates covering such use or design, or as a recommendation for the use of such materials, product or design, in the infringement of any patent or other intellectual property right.

Chemical Laboratory - KAO.,SGS Taiwan Ltd.

TEST REPORT

REPORT NO.KA/2004/C1138

DATE: 2005/1/4

PAGE: 1 OF 1

THE FOLLOWING MERCHANDISE WAS(WERE) SUBMITTED AND IDENTIFIED BY THE CLIENT AS :

CLIENT : GRAND PACIFIC PETROCHEMICAL CORPORATION.
 PRODUCT DESCRIPTION : ABS.
 STYLE/ITEM NO. : D-1000S.
 TESTING DATE : 2004/12/28 TO 2005/1/4 .
 SAMPLE RECEIVED : 2004/12/28.

WE HAVE TESTED THE SAMPLE(S) SUBMITTED AS REQUESTED AND THE FOLLOWING RESULTS WERE OBTAINED.

TEST ITEM(S)	UNIT	METHOD	DET. LMT	RESULT
CADMIUM	ppm	ANALYSIS BY ICP-AES WITH ADVANCE TREATMENT EN1122, METHOD B:2001.	2	n.d.
CHROMIUM VI	ppm	ANALYSIS BY US EPA 7196A WITH ADVANCE TREATMENT US EPA 3060A.	2	n.d.
MERCURY	ppm	ANALYSIS BY ICP-AES WITH ADVANCE TREATMENT US EPA 3052	2	n.d.
LEAD	ppm	ANALYSIS BY ICP-AES WITH ADVANCE TREATMENT US EPA 3050B	2	n.d.
PBBs	%	WITH REFERENCE TO 83/264/EEC. ANALYSIS WAS PERFORMED BY GC/ECDMS OR HPLC/DAD/MS.	0.0005	n.d.
PBDEs	%	WITH REFERENCE TO 83/264/EEC. ANALYSIS WAS PERFORMED BY GC/ECDMS OR HPLC/DAD/MS.	0.0005	n.d.

NOTE : n.d. = not detected.

<END>



George Huang
 George Huang / Supervisor
 Sign for and on behalf of
 SGS Taiwan Limited

This Test Report is issued by the Company subject to its General Conditions of Service printed overleaf. Attention is drawn to the limitations of liability, indemnification, and Jurisdictional issues defined therein. The results shown in this test report refer only to the sample(s) tested unless otherwise stated. This Test Report cannot be reproduced, except in full, without prior written permission of the Company. 此報告是根據本公司訂定之通用服務條款所製作發給。請注意此條款列明於背面。將本公司之義務、免責、管轄權等明確規範之。此報告結果除非另有說明僅對檢驗之樣品負責。本報告未經本公司書面許可，不可部份複製。

TW 1254579

SGS**Test Report**

映森企業股份有限公司
*241台北縣三重市中正北路540巷13號2樓

報告號碼 : CE/2005/54422
日期 : 2005/05/27
頁數 : 1 of 2

以下測試樣品乃供應廠商所提供及確認：

樣品名稱 : 鐵物釘
買主 / 訂單號碼 : 映森企業股份有限公司
收件日期 : 2005/05/23
測試日期 : 2005/05/23 TO 2005/05/27

測試結果

測試部位 NO.2 : 黑色金屬(請參照照片)

測試項目:	單位	測試方法	偵測極限值	結果
				NO.1
六價鉻	ppm	依照US EPA 3000A方法,用UV-VIS做分析	2	5.62
鉛	ppm	依照 EN1122 方法B:2001或其他酸消化方法,用感應耦合電漿原子發射光譜儀(ICP-AES)做分析	2	N.D.
汞	ppm	依照 US EPA 3052 方法或其他酸消化方法,用感應耦合電漿原子發射光譜儀(ICP-AES)做分析	2	N.D.
鎘	ppm	依照 US EPA 3050B 方法或其他酸消化方法,用感應耦合電漿原子發射光譜儀(ICP-AES)做分析	2	19.0

備註: (1) N.D. = Not detected, (MDL) / 未檢出(低於偵測極限值)
(2) ppm = mg/kg / 百萬分之一
(3) MDL= Method Detection Limit(偵測極限值)

David Yen, M.A., Operation Manager
Signed for and on behalf of
SGS TAIWAN LTD.

This Test Report is issued by the Company subject to its General Conditions of Service printed hereon. Attention is drawn to the Arbitration of Dispute, Indemnification, and Jurisdiction clauses defined therein. The results shown in this report should refer only to the sample(s) sealed un-tampered upon. This Test Report cannot be reproduced, except in full, without prior written permission of the Company. 本報告之測試結果僅供客戶參考, 如有任何爭議, 請向本公司洽詢。本報告之測試結果僅供客戶參考, 如有任何爭議, 請向本公司洽詢。

1911764

No. 53 Wu Chuan Road, Wueh-Shueh, Tainan, Taiwan / 台北縣五股工業區五權路33號
#096-21 2200 322 / #096-21 2200 322 / www.tw.sgs.com

6

5

4

3

2

1

DRAWING
NUMBER

D

D

side B

side A

15.80

102.80

102.80

C

C

B

B

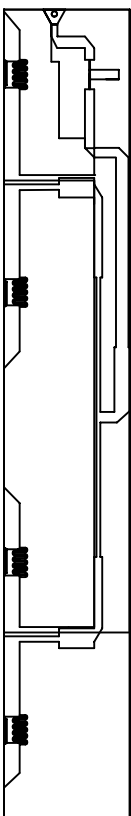

A

A



LONG CHENG ELECTRONICS CO. LTD
 龍呈國際科技有限公司

DESCRIPTION:

Dual Band PCB Roger RO4003

DIMENSION:

- 1 PLC ±0.5
- 2 PLC ±0.3
- 3 PLC ±0.2
- ANGLES ±5°

PART NUMBER

M03-DUBAND-00

REV

0

SIZE

A4

SCALE

SHEET

1 OF 1

UNIT

mm

APVD

MATERIAL

SEE NOTE

CHK

DWN

21-06-2004

DANIEL YANG

FINISH

SEE NOTE

DWN

DATE

6/21/04*

LTR

0

REVISION RECORD

NEW RELEASE

DWN

CHK

6

5

4

3

2

1



Position Statement on Lead-Free Products and WEEE and RoHS Compliance

November 5, 2004

The European Union has adapted the “Restriction on Use of Hazardous Substances in Electrical and Electronic Equipment” (RoHS) and the “Waste Electrical and Electronic Equipment” (WEEE) Directives. Arlon, Materials for Electronics Division, a leading company in Electronic Substrates and High Performance Laminates market, is committed to meet the RoHS and WEEE directives. Arlon’s product portfolio is compliant to RoHS and WEEE directives and has historically not contained the restricted substances.

These restricted substances include: Lead(Pb), Mercury(Hg), Cadmium(Cd), Hexavalent Chromium(Cr⁶⁺), Polybrominated biphenyls (PBB), and Polybrominated diphenyl Ethers (PBDE). Arlon’s product portfolio also does not utilize another brominated flame retardant —tetrabromobisphenol (TBBP-A), which is currently not on the list, but, may be added in the future. Arlon has also restricted these substances in all future products.

The European Union has also announced a warning concerning a proposed ban on the introduction of materials containing Pentabromodiphenyl Ether, Octabromodiphenyl Ether and Decabromodiphenylethers. Arlon has performed a review and found none of these referenced materials are utilized in any of our products.

Commitment to Compliance:

Arlon is able to advise that all Microwave Materials and Electronic Substrates are compliant with RoHS and WEEE Directives. Arlon will continue to work very closely with suppliers to insure all suppliers maintain their compliance with the RoHS and WEEE Directives. It is essential for Arlon’s suppliers/partners to understand and comply to the RoHS and WEEE directives.



MATERIALS FOR ELECTRONIC

9433 Hyssop Drive, Rancho Cucamonga, California 91730 • Telephone: (909) 987-9533 • Fax: (909) 987-8541

1100 Governor Lea Road, Bear, Delaware, 19701 • Telephone: (302) 834-2100, (800) 635-9333 • Fax: (302) 834-2574

44 Wilby Avenue, Little Lever, Bolton, Lancashire, BL31QE, UK • Telephone: (44) 120-457-6068 • Fax: (44) 120-479-6463

Website: www.arlon-med.com





Advanced Circuit Materials

100 South Roosevelt Avenue / Chandler, AZ 85226-3415 / 480.961.1382 / Fax: 480.961.4533

Statement on WEEE and RoHS Directives

Rogers Corporation, as a supplier of High Frequency Circuit Materials, through its Advanced Circuit Materials Division, is committed to providing materials which are safe with respect to the environment and human health. In that regard, Rogers takes note of the European Union WEEE and ROHS directives, which prohibit the following substances in electrical and electronic equipment by 1 July 2006:

- Lead
- Mercury
- Cadmium
- Hexavalent chromium,
- polybrominated biphenyls (PBBs)
- polybrominated diphenyl ethers (PBDEs)

Rogers is able to advise that all our High Frequency Circuit Materials* are in compliance with WEEE and RoHS directives on these substances.

A brominated flame retardant: brominated aromatic imide is used in RO4350B, RO4350ENZ, RO4450B, RO4403. This flame retardant has not been implicated in the possible production of dioxins, as have some other brominated flame retardants; and there are no restrictions on its use.

*(RO2800, RO3003, RO3003M, RO3003Q, RO3003 60Q, RO3006, RO3010, RO3203, RO3206, RO3035 M, RO3210, RO3263, RO4003B, RO4003C, RO4232, RO4233, RO4350B, RO4350BIA, RO4403, RO4450, RT5870, RT5880, RT6002, RT6006, RT6010.2, RT6010.2LM, RT6010.5, RT6010.5LM, RT6010.8, RT6010.8LM, RT6202, TMM3, TMM4, TMM5, TMM6, TMM10I, TMM13I, TMM4I, UL DK2.40, UL DK2.43, UL DK2.45, UL DK2.48, UL DK2.50, UL DK2.55, UL DK2.60, UL22, Rflex 36BP, Rflex 3850, Rflex 38BP)

A handwritten signature in black ink, appearing to read "Frank Gillern".

Frank Gillern
Division Vice President

A handwritten signature in blue ink, appearing to read "Vince Landi".

Vince Landi
Development Manager

A handwritten signature in blue ink, appearing to read "Kelly O'Brien".

Kelly O'Brien
EHS Specialist

The world runs better with Rogers.

www.rogerscorporation.com

Test Report

駱泰企業有限公司
*330桃園縣桃園市龍鳳一街2號

報告號碼 : CE/2004/63057
日期 : 2004/07/02
頁數 : 1 of 1

以下測試樣品乃供應廠商所提供及確認：

樣品名稱 : 瞬間膠
產品型號 : HOLDTITE CA304
生產或供應廠商 : 駱泰企業有限公司 LOCTAI ENTERPRISE CO., LTD.
收件日期 : 2004/06/25.
測試日期 : 2004/06/25 TO 2004/07/02

測試結果

測試部位 NO.1 : 透明膠

測試項目:	單位	測試方法	偵測極限值	結果				
				NO.1				
六價鉻	ppm	依照US EPA 7196A及3060A方法	2	N.D.				
鎘	ppm	依照 EN1122 方法B:2001或其他酸消化方法,用感應藕合電漿原子發射光譜儀(ICP-AES)做分析	2	N.D.				
汞	ppm	依照 US EPA 3052 方法或其他酸消化方法,用感應藕合電漿原子發射光譜儀(ICP-AES)做分析	2	N.D.				
鉛	ppm	依照 US EPA 3050B 方法或其他酸消化方法,用感應藕合電漿原子發射光譜儀(ICP-AES)做分析	2	N.D.				

備註：(1) N.D. = Not detected.(<MDL) / 未檢出(低於偵測極限值)
(2) ppm = mg/kg / 百萬分之一
(3) MDL= Method Detection Limit(偵測極限值)

Daniel Yen, M.R. / Operation Manager
Signed for and on behalf of
SGS TAIWAN LTD.