



SPORTON International Inc.

No. 52, Hwa Ya 1st Rd., Kwei-Shan Hsiang, TaoYuan Hsien, Taiwan, R.O.C.
Ph: 886-3-327-3456 / FAX: 886-3-327-0973 / www.sporton.com.tw

FCC RADIO TEST REPORT

Applicant's company	Accton Technology Corporation
Applicant Address	No. 1 Creation Rd., III, Science-based Industrial Park, Hsinchu 300, Taiwan, R.O.C.
FCC ID	HEDOAP3211A
Manufacturer's company	Accton Technology Corporation
Manufacturer Address	No. 1 Creation Rd., III, Science-based Industrial Park, Hsinchu 300, Taiwan, R.O.C.

Product Name	802.11a outdoor CPE (Client)
Brand Name	Alvarion
Model Name	SU-A-MB-12-EZ
Test Rule Part(s)	47 CFR FCC Part 15 Subpart E § 15.407
Test Freq. Range	5250 ~ 5350MHz / 5470 ~ 5725MHz
Received Date	Jan. 19, 2007
Final Test Date	Sep. 24, 2007
Submission Type	Original Equipment
Operating Mode	Client (without radar detection function)



Statement

Test result included is only for the 802.11a (5250 ~ 5350MHz / 5470 ~ 5725MHz) of the product.

The test result in this report refers exclusively to the presented test model / sample.

Without written approval of SPORTON International Inc., the test report shall not be reproduced except in full.

The measurements and test results shown in this test report were made in accordance with the procedures and found in compliance with the limit given in **ANSI C63.4-2003** and **47 CFR FCC Part 15 Subpart E**.

The test equipment used to perform the test is calibrated and traceable to NML/ROC.



Testing Laboratory
1190

Table of Contents

1. CERTIFICATE OF COMPLIANCE	1
2. SUMMARY OF THE TEST RESULT	2
3. GENERAL INFORMATION	3
3.1. Product Details.....	3
3.2. Accessories.....	3
3.3. Table for Filed Antenna.....	3
3.4. Table for Carrier Frequencies	3
3.5. Table for Test Modes.....	4
3.6. Table for Testing Locations.....	4
3.7. Table for Supporting Units	4
3.8. Table for Parameters of Test Software Setting	5
3.9. Test Configurations	6
4. TEST RESULT	8
4.1. AC Power Line Conducted Emissions Measurement.....	8
4.2. 99% Occupied Bandwidth Measurement	12
4.3. Maximum Conducted Output Power Measurement.....	17
4.4. Power Spectral Density Measurement	22
4.5. Peak Excursion Measurement.....	27
4.6. Radiated Emissions Measurement	32
4.7. Band Edge Emissions Measurement	49
4.8. Frequency Stability Measurement	56
4.9. Antenna Requirements	58
5. LIST OF MEASURING EQUIPMENTS	59
6. TEST LOCATION.....	61
7. TAF CERTIFICATE OF ACCREDITATION	62
APPENDIX A. PHOTOGRAPHS OF EUT.....	A1 ~ A10
APPENDIX B. TEST PHOTOS.....	B1 ~ B5
APPENDIX C. MAXIMUM PERMISSIBLE EXPOSURE.....	C1 ~ C3
APPENDIX D. DYNAMIC FREQUENCY SELECTION TEST REPORT	D1 ~ D22
APPENDIX E. ANTENNA REPORT	



History of This Test Report

Original Issue Date: Sep. 26, 2007

Report No.: FR711904AB

No additional attachment.

Additional attachment were issued as following record:

Attachment No.	Issue Date	Description



1. CERTIFICATE OF COMPLIANCE

Certificate No.: CB9609103

Product Name : 802.11a outdoor CPE (Client)
Brand Name : Alvarion
Model Name : SU-A-MB-12-EZ
Applicant : Accton Technology Corporation
Test Rule Part(s) : 47 CFR FCC Part 15 Subpart E § 15.407

Sporton International as requested by the applicant to evaluate the EMC performance of the product sample received on Jan. 19, 2007 would like to declare that the tested sample has been evaluated and found to be in compliance with the tested rule parts. The data recorded as well as the test configuration specified is true and accurate for showing the sample's EMC nature.

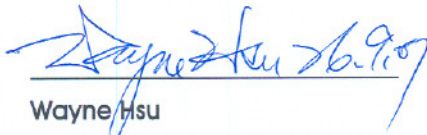
Wayne Hsu
SPORTON INTERNATIONAL INC.

2. SUMMARY OF THE TEST RESULT

Applied Standard: 47 CFR FCC Part 15 Subpart E				
Part	Rule Section	Description of Test	Result	Under Limit
4.1	15.207	AC Power Line Conducted Emissions	Complies	9.24 dB
4.2	15.407(a)	26dB Spectrum Bandwidth	Complies	-
4.3	15.407(a)	Maximum Conducted Output Power	Complies	2.1 dB
4.4	15.407(a)	Power Spectral Density	Complies	5.42 dB
4.5	15.407(a)	Peak Excursion	Complies	7.16 dB
4.6	15.407(b)	Radiated Emissions	Complies	0.37 dB
4.7	15.407(b)	Band Edge Emissions	Complies	0.03 dB
4.8	15.407(g)	Frequency Stability	Complies	-
4.9	15.203	Antenna Requirements	Complies	-

Test Items	Uncertainty	Remark
AC Power Line Conducted Emissions	±2.3dB	Confidence levels of 95%
Maximum Conducted Output Power	±0.5dB	Confidence levels of 95%
Power Spectral Density	±0.5dB	Confidence levels of 95%
Peak Excursion	±0.5dB	Confidence levels of 95%
26dB Spectrum Bandwidth / Frequency Stability	±8.5×10 ⁻⁸	Confidence levels of 95%
Radiated Emissions (9kHz~30MHz)	±0.8dB	Confidence levels of 95%
Radiated Emissions (30MHz~1000MHz)	±1.9dB	Confidence levels of 95%
Radiated / Band Edge Emissions (1GHz~18GHz)	±1.9dB	Confidence levels of 95%
Radiated Emissions (18GHz~40GHz)	±1.9dB	Confidence levels of 95%
Temperature	±0.7°C	Confidence levels of 95%
Humidity	±3.2%	Confidence levels of 95%
DC / AC Power Source	±1.4%	Confidence levels of 95%

3. GENERAL INFORMATION

3.1. Product Details

Items	Description
Power Type	POE
Modulation	OFDM for IEEE 802.11a
Data Modulation	OFDM (BPSK / QPSK / 16QAM / 64QAM)
Data Rate (Mbps)	OFDM (6/9/12/18/24/36/48/54)
Frequency Range	5250 ~ 5350MHz / 5470 ~ 5725MHz
Channel Number	Band 2: 3 ; Band 3: 11
Channel Band Width (99%)	Band 2: 17.60 MHz ; Band 3: 17.82 MHz
Conducted Output Power	Band 2: 7.20 dBm ; Band 3: 10.90 dBm
Carrier Frequencies	Please refer to section 3.4
Antenna	Please refer to section 3.3

3.2. Accessories

Power	Brand	Model	Rating
POE	Alvarion	0334B5555	Input: 100-240V, 50/60Hz, 1.5A Output: 55V, 1A

3.3. Table for Filed Antenna

Ant.	Brand	Model Name	Antenna Type	Connector	Gain (dBi)
1	Lct	E5A_20078O-M42	Patch Antenna	MMCX R/A Plug	17

3.4. Table for Carrier Frequencies

Frequency Band	Channel No.	Frequency	Channel No.	Frequency
5250~5350 MHz Band 2	54	5270 MHz	66	5330 MHz
	60	5300 MHz		
5470~5725 MHz Band 3	100	5500 MHz	124	5620 MHz
	104	5520 MHz	128	5640 MHz
	108	5540 MHz	132	5660 MHz
	112	5560 MHz	136	5680 MHz
	116	5580 MHz	140	5700 MHz
	120	5600 MHz		

3.5. Table for Test Modes

Preliminary tests were performed in different data rate to find the worst radiated emission. The data rate shown in the table below is the worst-case rate with respect to the specific test item. Investigation has been done on all the possible configurations for searching the worst cases. The following table is a list of the test modes shown in this test report.

Test Items	Mode	Data Rate	Channel	Antenna
AC Power Conducted Emission	Normal Link	Auto	140	1
26dB Spectrum Bandwidth 99% Occupied Bandwidth Measurement	Band 2/BPSK	6Mbps	54/60/66	N/A
Max. Conducted Output Power Power Spectral Density Peak Excursion	Band 3/BPSK	6Mbps	100/120/140	N/A
Radiated Emission Below 1GHz	Band 3/BPSK	6Mbps	140	1
Radiated Emission Above 1GHz Band Edge Emission	Band 2/BPSK	6Mbps	54/60/66	1
	Band 3/BPSK	6Mbps	100/120/140	1
Band Edge Emission	Band 2/BPSK	6Mbps	54/66	1
	Band 3/BPSK	6Mbps	100/140	1
Frequency Stability	Un-modulation	-	60	N/A

3.6. Table for Testing Locations

Test Site No.	Site Category	Location	FCC Reg. No.	IC File No.	VCCI Reg. No
03CH03-HY	SAC	Hwa Ya	101377	IC 4088	-
CO04-HY	Conduction	Hwa Ya	101377	IC 4088	-
TH01-HY	OVEN Room	Hwa Ya	-	-	-

Open Area Test Site (OATS); Semi Anechoic Chamber (SAC); Fully Anechoic Chamber (FAC).

Please refer section 6 for Test Site Address.

3.7. Table for Supporting Units

Support Unit	Brand	Model	FCC ID
BROADBAND WIRELESS ACCESS	alvarion	AU-E-SA-5.X-VL	LKT-VL-53C LKT-VL-54C
Notebook	DELL	D520	E2KWM3945ABG
Notebook	DELL	D520	E2KWM3945ABG
ANT	MAX RAD	W2-464	N/A
Notebook	DELL	D400	E2K24GBRL

3.8. Table for Parameters of Test Software Setting

During testing, Channel & Power Controlling Software provided by the customer was used to control the operating channel as well as the output power level. The RF output power selection is for the setting of RF output power expected by the customer and is going to be fixed on the firmware of the final end product.

Power Parameters

Test Software Version	ART					
Frequency	5270 MHz	5300 MHz	5330 MHz	5500 MHz	5600 MHz	5700 MHz
Power Parameters	6	6	0	3.5	8	8

During the test, the following programs under WIN XP were executed:

Executed "ART" to control the EUT continuously transmit RF signal.

Executed "ping.exe" to link with the remote workstation to receive and transmit signal by LAN and WLAN.

3.9. Test Configurations

3.9.1. Radiation Emissions Test Configuration

9kHz~1GHz

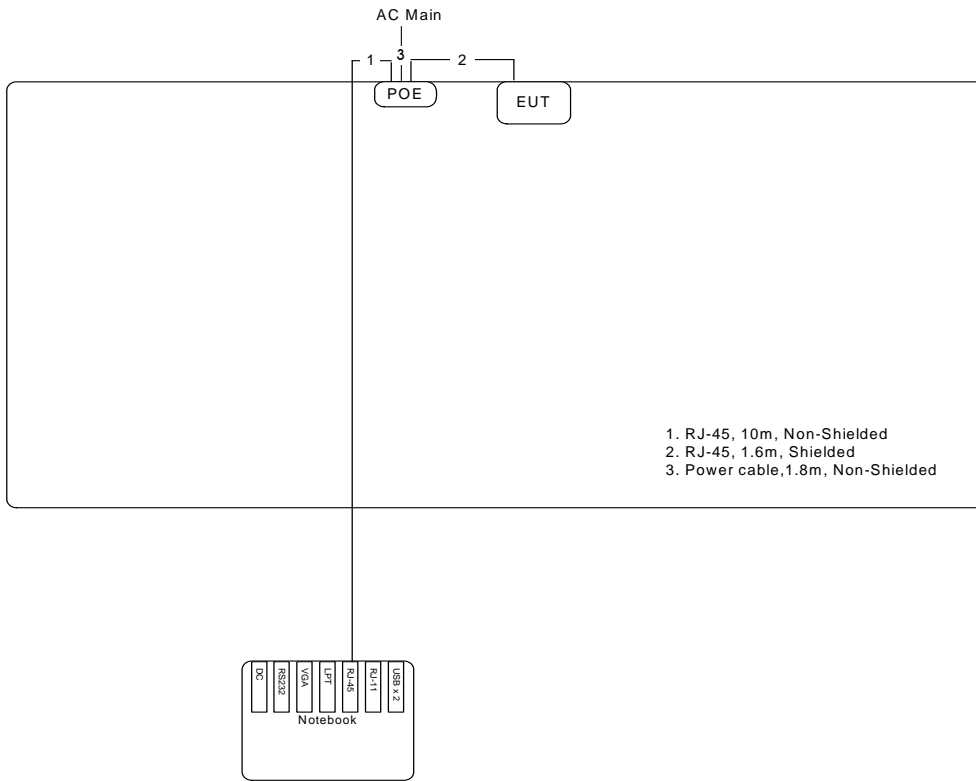

Above 1GHz

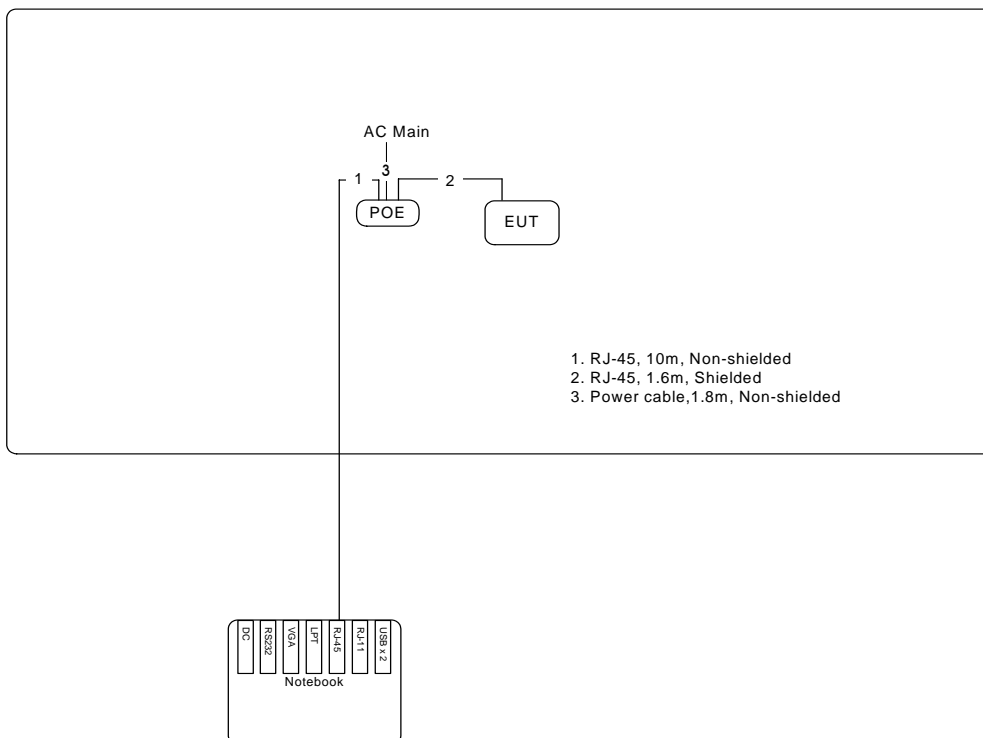

3.9.2. AC Power Line Conduction Emissions Test Configuration

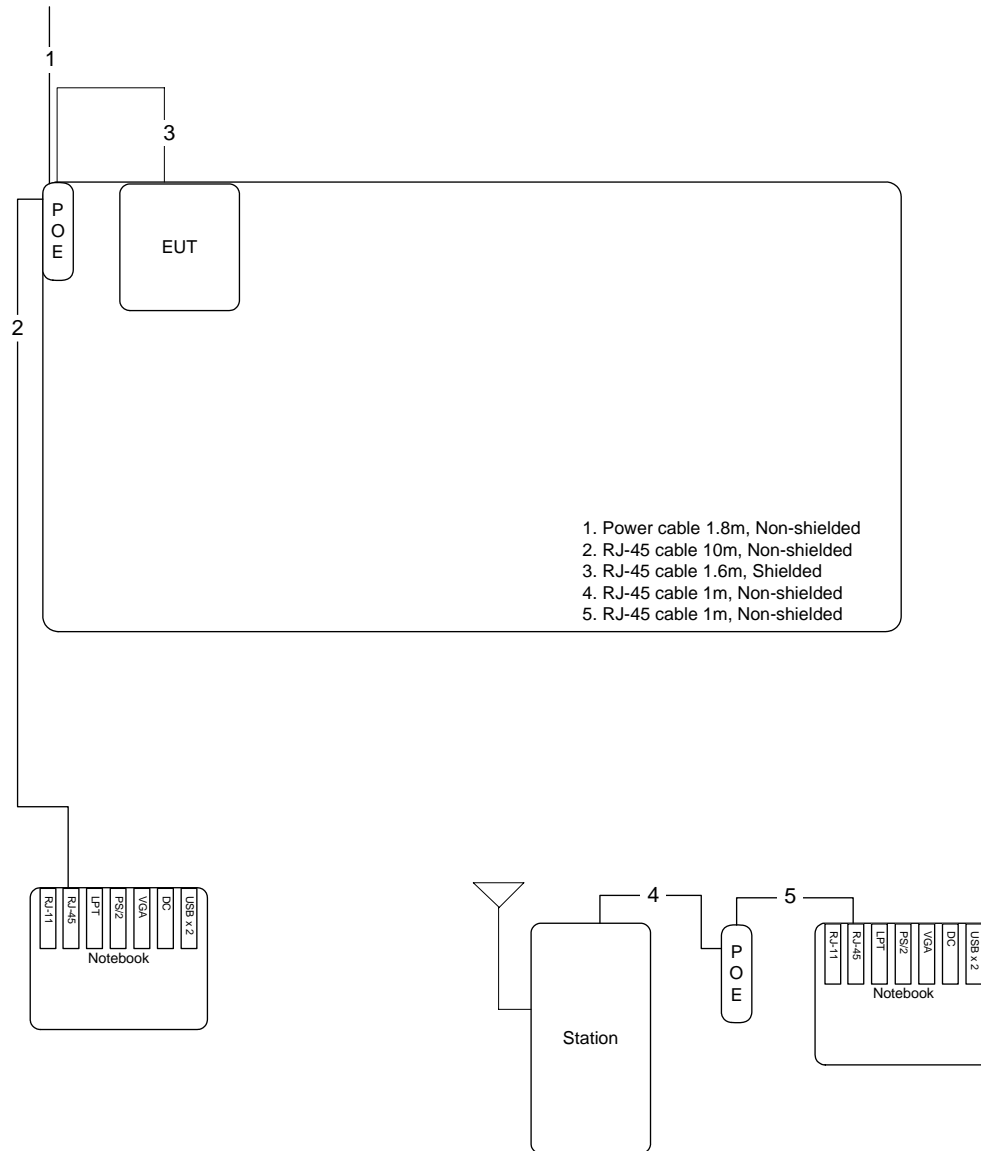

4. TEST RESULT

4.1. AC Power Line Conducted Emissions Measurement

4.1.1. Limit

For this product that is designed to connect to the AC power line, the radio frequency voltage that is conducted back onto the AC power line on any frequency or frequencies within the band 150 kHz to 30 MHz shall not exceed below limits table.

Frequency (MHz)	QP Limit (dBuV)	AV Limit (dBuV)
0.15~0.5	66~56	56~46
0.5~5	56	46
5~30	60	50

4.1.2. Measuring Instruments and Setting

Please refer to section 5 of equipments list in this report. The following table is the setting of the receiver.

Receiver Parameters	Setting
Attenuation	10 dB
Start Frequency	0.15 MHz
Stop Frequency	30 MHz
IF Bandwidth	9 KHz

4.1.3. Test Procedures

1. Configure the EUT according to ANSI C63.4. The EUT or host of EUT has to be placed 0.4 meter far from the conducting wall of the shielding room and at least 80 centimeters from any other grounded conducting surface.
2. Connect EUT or host of EUT to the power mains through a line impedance stabilization network (LISN).
3. All the support units are connected to the other LISNs. The LISN should provide 50uH/50ohms coupling impedance.
4. The frequency range from 150 KHz to 30 MHz was searched.
5. Set the test-receiver system to Peak Detect Function and Specified Bandwidth with Maximum Hold Mode.
6. The measurement has to be done between each power line and ground at the power terminal.

4.1.4. Test Setup Layout

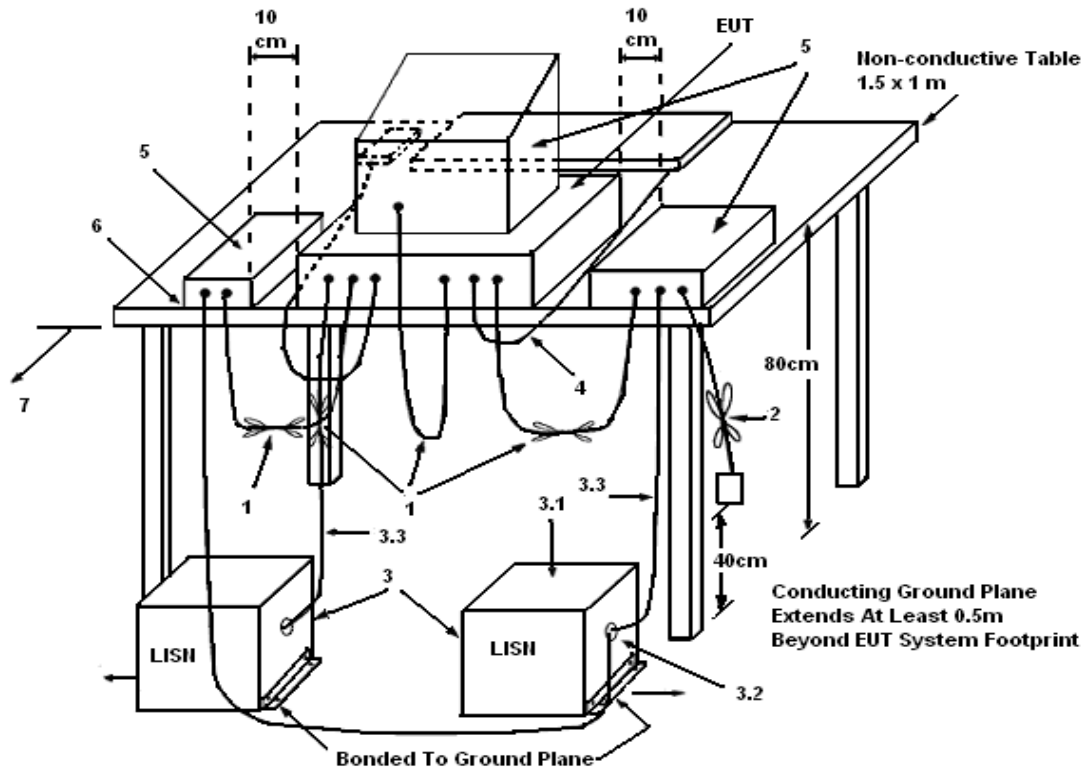

LEGEND:

- (1) Interconnecting cables that hang closer than 40 cm to the ground plane shall be folded back and forth in the center forming a bundle 30 to 40 cm long.
- (2) I/O cables that are not connected to a peripheral shall be bundled in the center. The end of the cable may be terminated, if required, using the correct terminating impedance. The overall length shall not exceed 1 m.
- (3) EUT connected to one LISN. Unused LISN measuring port connectors shall be terminated in 50Ω . LISN can be placed on top of, or immediately beneath, reference ground plane.
 - (3.1) All other equipment powered from additional LISN(s).
 - (3.2) Multiple outlet strip can be used for multiple power cords of non-EUT equipment.
 - (3.3) LISN at least 80 cm from nearest part of EUT chassis.
- (4) Cables of hand-operated devices, such as keyboards, mice, etc., shall be placed as for normal use.
- (5) Non-EUT components of EUT system being tested.
- (6) Rear of EUT, including peripherals, shall all be aligned and flush with rear of tabletop.
- (7) Rear of tabletop shall be 40 cm removed from a vertical conducting plane that is bonded to the ground plane.

4.1.5. Test Deviation

There is no deviation with the original standard.

4.1.6. EUT Operation during Test

The EUT was placed on the test table and programmed in normal function.

4.1.7. Results of AC Power Line Conducted Emissions Measurement

Temperature	20°C	Humidity	59%
Test Engineer	Barry Chen	Phase	Line
Configuration	Normal Link		

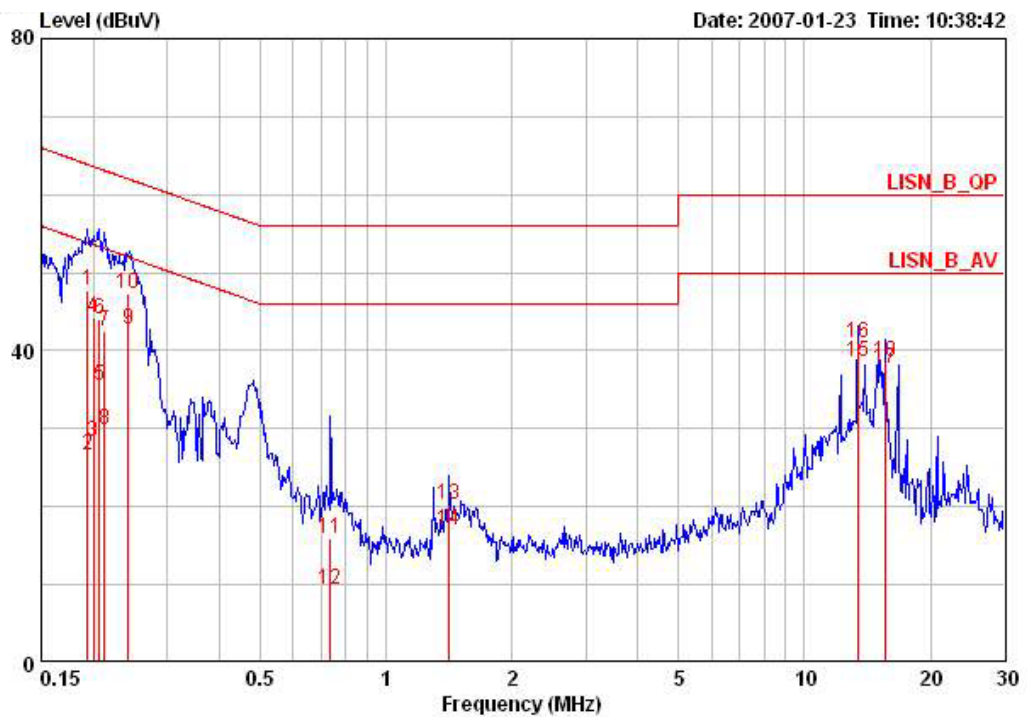

	Freq	Level	Over Limit	Limit Line	Read Level	LISN Factor	Cable Loss	Remark	Pol/Phase
	MHz	dBuV	dB	dBuV	dBuV	dB	dB		
1	0.19344	47.79	-16.10	63.89	47.48	0.11	0.20	QP	LINE
2	0.19344	26.62	-27.27	53.89	26.31	0.11	0.20	AVERAGE	LINE
3	0.19969	28.31	-25.31	53.62	28.01	0.10	0.20	AVERAGE	LINE
4	0.19969	44.34	-19.28	63.62	44.04	0.10	0.20	QP	LINE
5	0.20614	35.49	-17.87	53.36	35.19	0.10	0.20	AVERAGE	LINE
6	0.20614	44.14	-19.22	63.36	43.84	0.10	0.20	QP	LINE
7	0.21279	42.43	-20.66	63.10	42.14	0.09	0.20	QP	LINE
8	0.21279	29.83	-23.26	53.10	29.54	0.09	0.20	AVERAGE	LINE
9	0.24179	42.79	-9.24	52.03	42.52	0.07	0.20	AVERAGE	LINE
10	0.24179	47.24	-14.79	62.03	46.97	0.07	0.20	QP	LINE
11	0.73519	15.97	-40.03	56.00	15.77	0.00	0.20	QP	LINE
12	0.73519	9.32	-36.68	46.00	9.12	0.00	0.20	AVERAGE	LINE
13	1.418	20.20	-35.80	56.00	20.09	0.00	0.11	QP	LINE
14	1.418	17.00	-29.00	46.00	16.89	0.00	0.11	AVERAGE	LINE
15	13.418	38.67	-11.33	50.00	38.17	0.10	0.40	AVERAGE	LINE
16	13.418	41.01	-18.99	60.00	40.51	0.10	0.40	QP	LINE
17	15.556	37.67	-12.33	50.00	37.17	0.10	0.40	AVERAGE	LINE
18	15.556	38.58	-21.42	60.00	38.08	0.10	0.40	QP	LINE

Temperature	20°C	Humidity	59%
Test Engineer	Barry Chen	Phase	Neutral
Configuration	Normal Link		

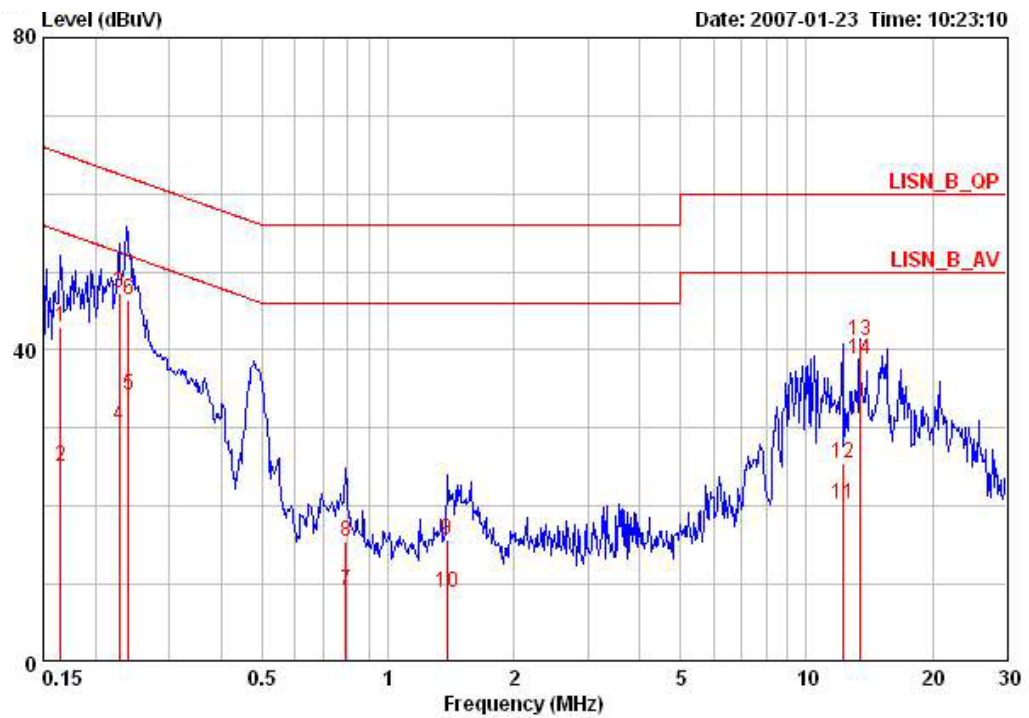

	Freq	Level	Over Limit	Limit Line	Read Level	LISN Factor	Cable Loss	Remark	Pol/Phase
	MHz	dBuV	dB	dBuV	dBuV	dB	dB		
1	0.16501	43.05	-22.16	65.21	42.68	0.17	0.20	QP	NEUTRAL
2	0.16501	25.05	-30.16	55.21	24.68	0.17	0.20	AVERAGE	NEUTRAL
3	0.22797	47.39	-15.13	62.52	47.11	0.08	0.20	QP	NEUTRAL
4	0.22797	30.27	-22.25	52.52	29.99	0.08	0.20	AVERAGE	NEUTRAL
5	0.23997	34.25	-17.84	52.10	33.98	0.07	0.20	AVERAGE	NEUTRAL
6	0.23997	46.49	-15.60	62.10	46.22	0.07	0.20	QP	NEUTRAL
7	0.79180	9.24	-36.76	46.00	9.04	0.00	0.20	AVERAGE	NEUTRAL
8	0.79180	15.49	-40.51	56.00	15.29	0.00	0.20	QP	NEUTRAL
9	1.381	15.73	-40.27	56.00	15.61	0.00	0.12	QP	NEUTRAL
10	1.381	9.01	-36.99	46.00	8.89	0.00	0.12	AVERAGE	NEUTRAL
11	12.188	20.26	-29.74	50.00	19.76	0.10	0.40	AVERAGE	NEUTRAL
12	12.188	25.41	-34.59	60.00	24.91	0.10	0.40	QP	NEUTRAL
13	13.421	41.15	-18.85	60.00	40.65	0.10	0.40	QP	NEUTRAL
14	13.421	38.89	-11.11	50.00	38.39	0.10	0.40	AVERAGE	NEUTRAL

Note:

Level = Read Level + LISN Factor + Cable Loss.

4.2. 99% Occupied Bandwidth Measurement

4.2.1. Limit

No restriction limits. But resolution bandwidth within band edge measurement is 1% of the 99% occupied bandwidth.

4.2.2. Measuring Instruments and Setting

Please refer to section 5 of equipments list in this report. The following table is the setting of the spectrum analyzer.

Spectrum Parameters	Setting
Attenuation	Auto
Span Frequency	> 26dB Bandwidth
RB	300 kHz
VB	1000 kHz
Detector	Peak
Trace	Max Hold
Sweep Time	Auto

4.2.3. Test Procedures

1. The transmitter output (antenna port) was connected to the spectrum analyzer in peak hold mode.
2. The resolution bandwidth of 300 kHz and the video bandwidth of 1000 kHz were used.
3. Measured the spectrum width with power higher than 26dB below carrier.

4.2.4. Test Setup Layout

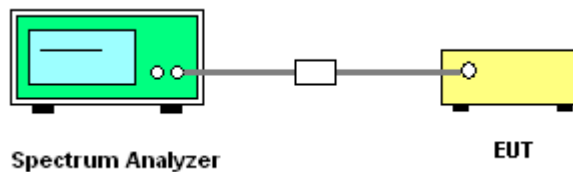

4.2.5. Test Deviation

There is no deviation with the original standard.

4.2.6. EUT Operation during Test

The EUT was programmed to be in continuously transmitting mode.

4.2.7. Test Result of 99% Occupied Bandwidth

Temperature	23°C	Humidity	58%
Test Engineer	Leo Hung	Configurations	802.11a

Configuration IEEE 802.11a

Channel	Frequency	26dB Bandwidth (MHz)	99% Occupied Bandwidth (MHz)
54	5270 MHz	24.80	17.44
60	5300 MHz	25.44	17.44
66	5330 MHz	25.28	17.60
100	5500 MHz	25.64	17.56
120	5600 MHz	25.51	17.56
140	5700 MHz	27.05	17.82

26 dB Bandwidth Plot on Configuration IEEE 802.11a / 5270 MHz

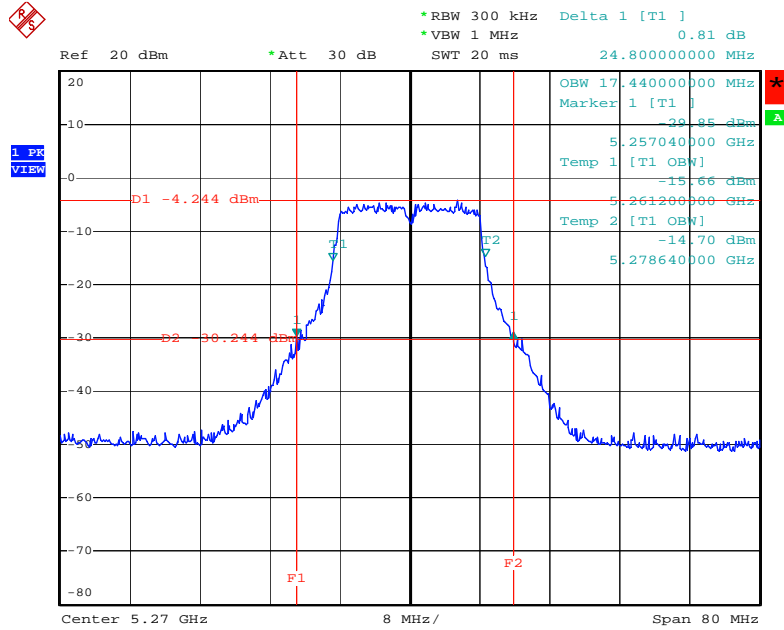

Date: 20.SEP.2007 12:06:03

26 dB Bandwidth Plot on Configuration IEEE 802.11a / 5300 MHz

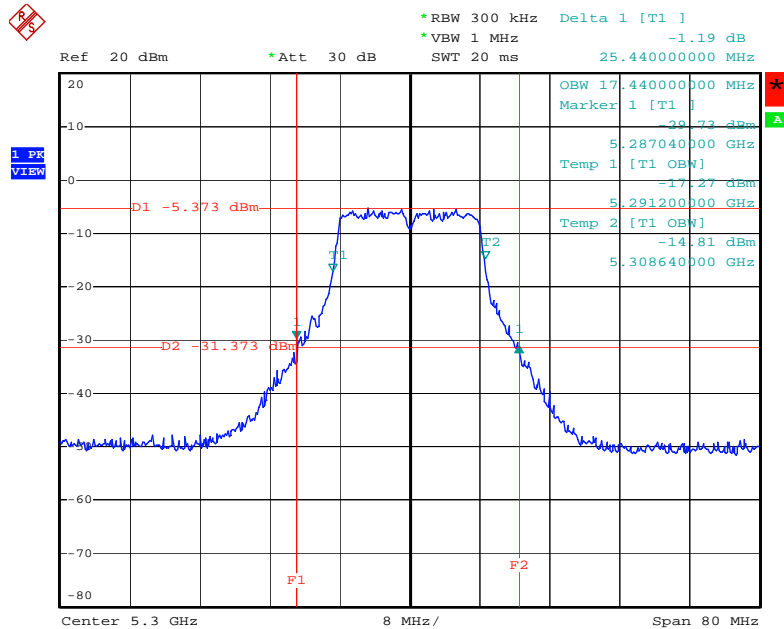

Date: 20.SEP.2007 11:57:32

26 dB Bandwidth Plot on Configuration IEEE 802.11a / 5330 MHz

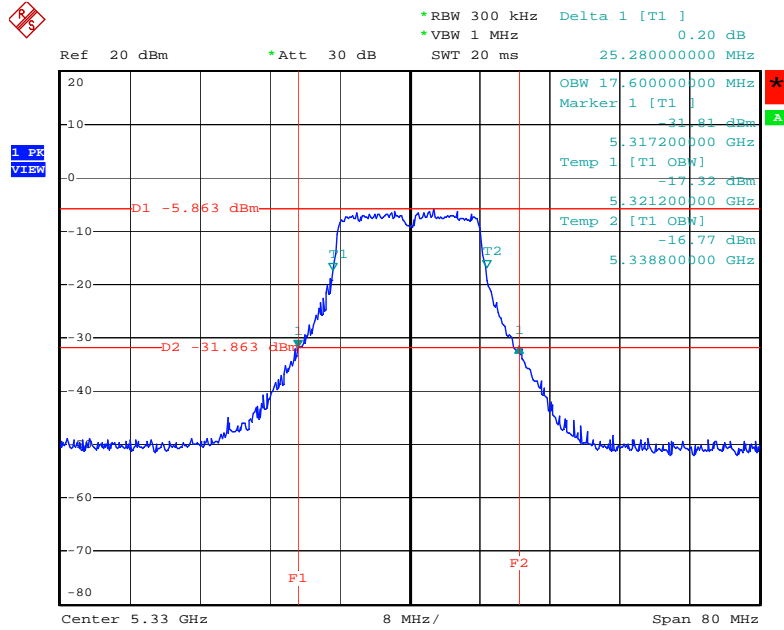

Date: 20.SEP.2007 11:55:53

26 dB Bandwidth Plot on Configuration IEEE 802.11a / 5500 MHz

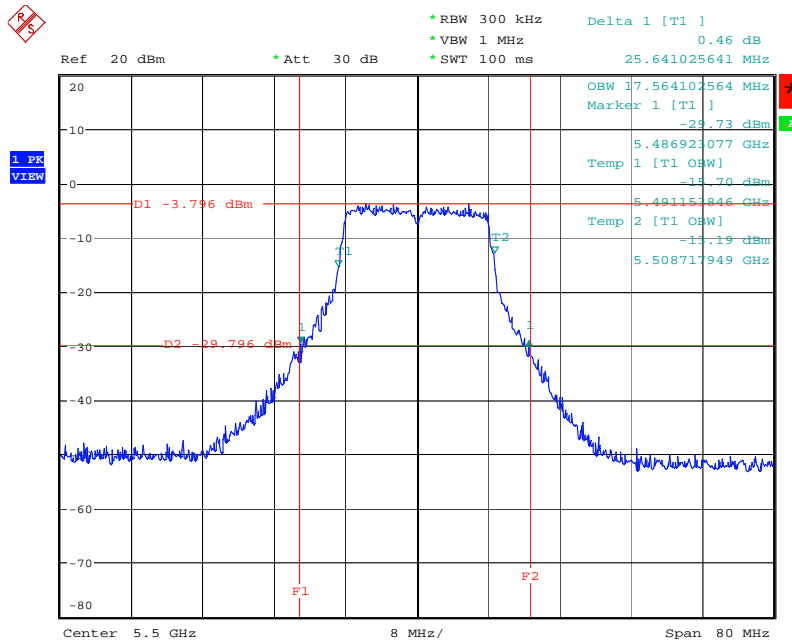

Date: 23.JAN.2007 15:41:27

26 dB Bandwidth Plot on Configuration IEEE 802.11a / 5600 MHz

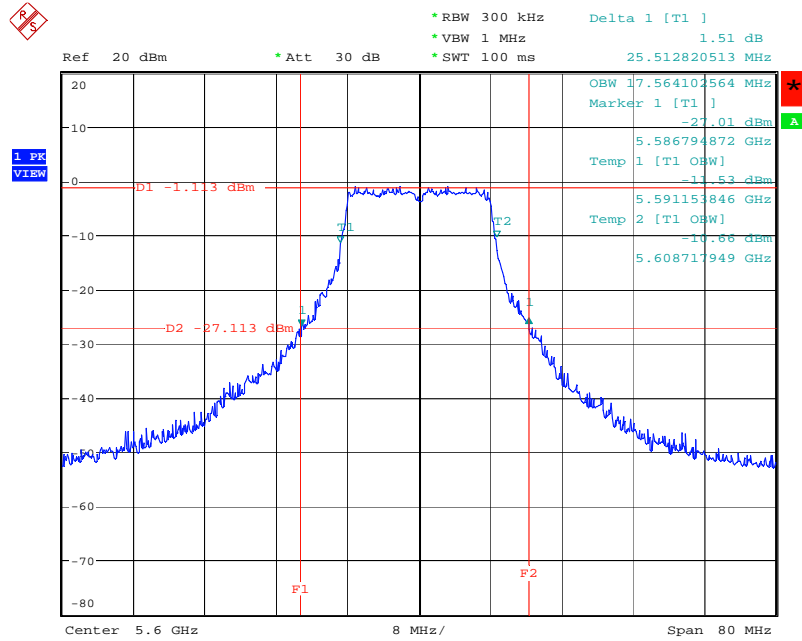

Date: 23.JAN.2007 15:49:16

26 dB Bandwidth Plot on Configuration IEEE 802.11a / 5700 MHz

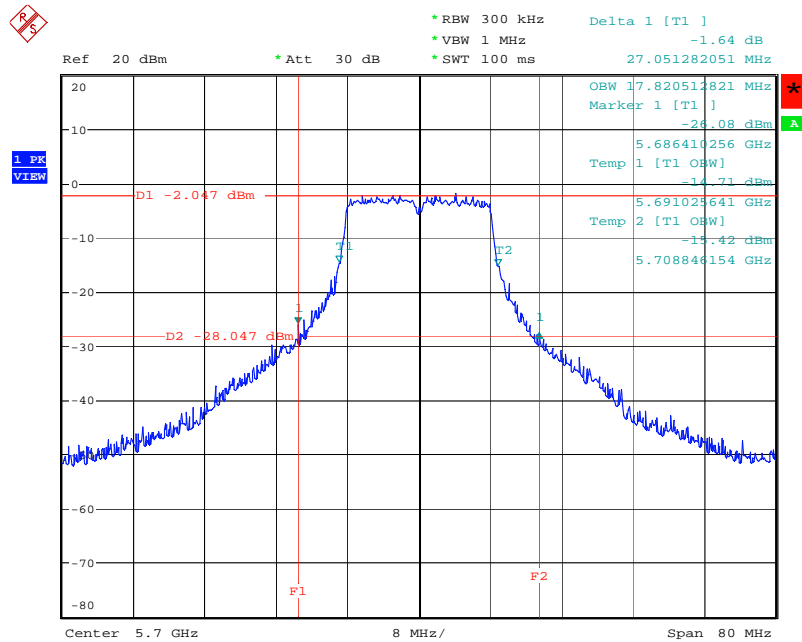

Date: 23.JAN.2007 15:50:36

4.3. Maximum Conducted Output Power Measurement

4.3.1. Limit

For the 5.25-5.35 GHz and 5.47-5.725 GHz bands, the maximum conducted output power over the frequency bands of operation shall not exceed the lesser of 250 mW (24dBm) or 11 dBm + 10log B. If transmitting antennas of directional gain greater than 6 dBi are used, the peak output power and power density from the intentional radiator shall be reduced by the amount in dB that the directional gain of the antenna exceeds 6 dBi.

4.3.2. Measuring Instruments and Setting

Please refer to section 5 of equipments list in this report. The following table is the setting of the spectrum analyzer.

Spectrum Parameter	Setting
Attenuation	Auto
Span Frequency	Encompass the entire emissions bandwidth (EBW) of the signal
RB	1000 kHz
VB	300 kHz
Detector	Sample
Trace	Max Hold
Sweep Time	60s

4.3.3. Test Procedures

1. The transmitter output (antenna port) was connected to the spectrum analyzer.
2. Test was performed in accordance with method #3 of FCC Public Notice DA-02-2138.

4.3.4. Test Setup Layout

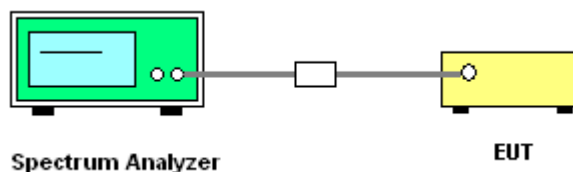

4.3.5. Test Deviation

There is no deviation with the original standard.

4.3.6. EUT Operation during Test

The EUT was programmed to be in continuously transmitting mode.

4.3.7. Test Result of Maximum Conducted Output Power

Temperature	23°C	Humidity	58%
Test Engineer	Leo Hung	Configurations	802.11a

Configuration IEEE 802.11a

Channel	Frequency	Conducted Power (dBm)	Max. Limit (dBm)	Result
54	5270 MHz	7.20	13.00	Complies
60	5300 MHz	6.44	13.00	Complies
66	5330 MHz	5.78	13.00	Complies
100	5500 MHz	7.72	13.00	Complies
120	5600 MHz	10.90	13.00	Complies
140	5700 MHz	9.74	13.00	Complies

Channel Output Power Plot on Configuration IEEE 802.11 a / 5270 MHz

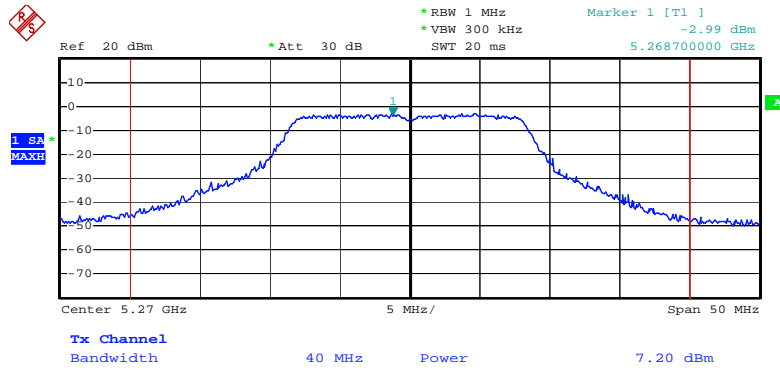

Date: 20.SEP.2007 12:06:44

Channel Output Power Plot on Configuration IEEE 802.11 a / 5300 MHz

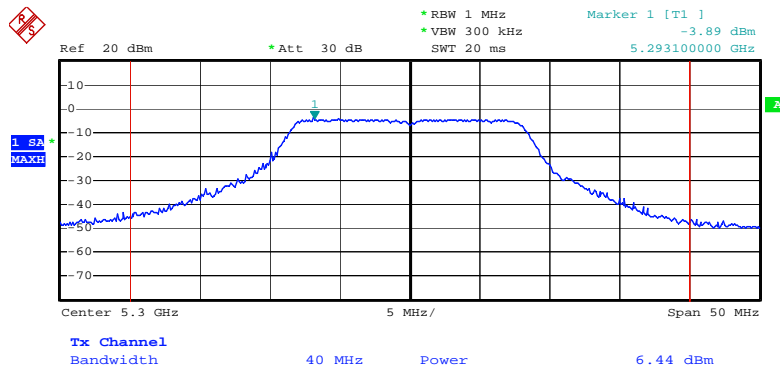

Date: 20.SEP.2007 11:58:13

Channel Output Power Plot on Configuration IEEE 802.11 a / 5330 MHz

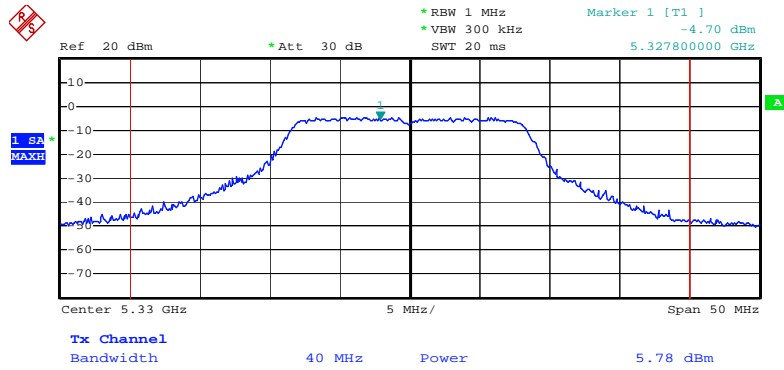

Date: 20.SEP.2007 11:56:34

Channel Output Power Plot on Configuration IEEE 802.11 a / 5500 MHz

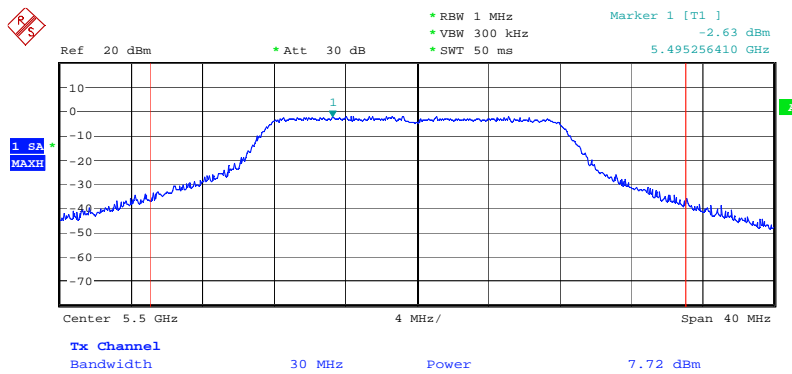

Date: 23.JAN.2007 15:42:11

Channel Output Power Plot on Configuration IEEE 802.11a / 5600 MHz

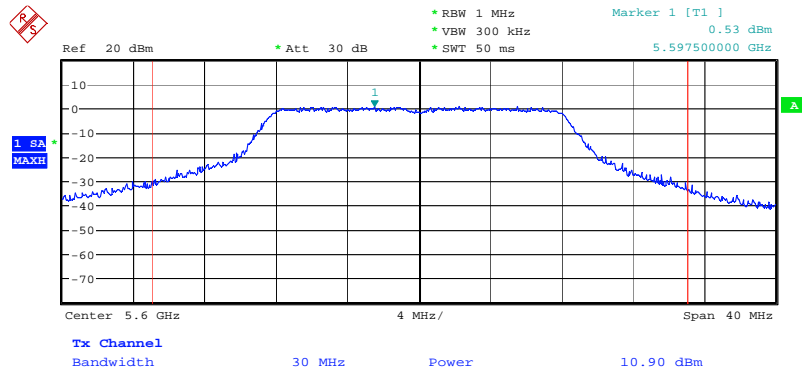

Date: 23.JAN.2007 15:50:00

Channel Output Power Plot on Configuration IEEE 802.11a / 5700 MHz

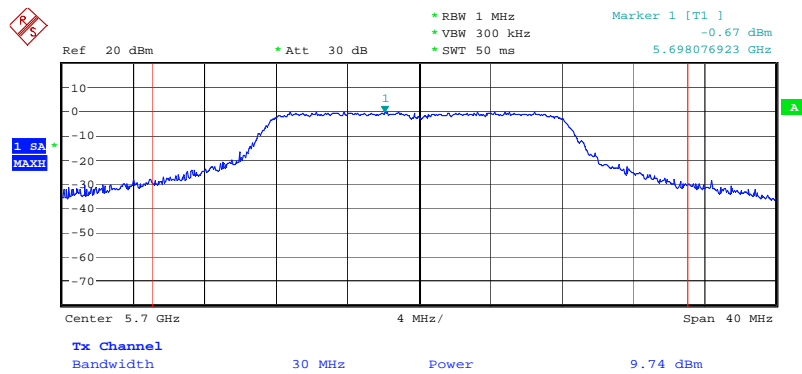

Date: 23.JAN.2007 15:51:20

4.4. Power Spectral Density Measurement

4.4.1. Limit

The power spectral density is defined as the highest level of power in dBm per MHz generated by the transmitter within the power envelope. The following table is power spectral density limits and decrease power density limit rule refer to section 4.3.1.

Frequency Range	Power Spectral Density limit (dBm/MHz)
5.250-5.350 GHz	11
5.470-5.5.725 GHz	11

4.4.2. Measuring Instruments and Setting

Please refer to section 5 of equipments list in this report. The following table is the setting of the spectrum analyzer.

Spectrum Parameter	Setting
Attenuation	Auto
Span Frequency	Encompass the entire emissions bandwidth (EBW) of the signal
RB	1000 kHz
VB	3000 kHz
Detector	Peak
Trace	Max Hold
Sweep Time	Auto

4.4.3. Test Procedures

1. The transmitter output (antenna port) was connected to the spectrum analyzer.
2. Set RBW of spectrum analyzer to 1000kHz and VBW to 3000kHz. Set Detector to Peak, Trace to Max Hold. Mark the frequency with maximum peak power as the center of the display of the spectrum.

4.4.4. Test Setup Layout

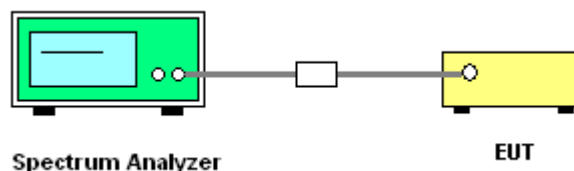

4.4.5. Test Deviation

There is no deviation with the original standard.

4.4.6. EUT Operation during Test

The EUT was programmed to be in continuously transmitting mode.

4.4.7. Test Result of Power Spectral Density

Temperature	23°C	Humidity	58%
Test Engineer	Leo Hung	Configurations	802.11a

Configuration IEEE 802.11a

Frequency	Power Density (dBm)	Max. Limit (dBm)	Result
5270 MHz	-9.44	0.00	Complies
5300 MHz	-10.36	0.00	Complies
5330 MHz	-11.00	0.00	Complies
5500 MHz	-8.46	0.00	Complies
5600 MHz	-5.42	0.00	Complies
5700 MHz	-6.29	0.00	Complies

Power Density Plot on Configuration IEEE 802.11a / 5270 MHz

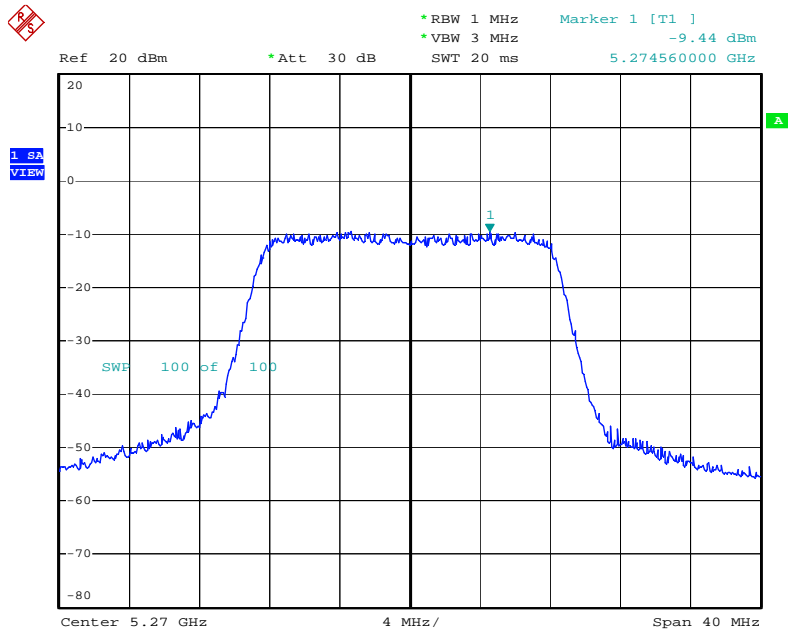

Date: 20.SEP.2007 12:06:10

Power Density Plot on Configuration IEEE 802.11a / 5300 MHz

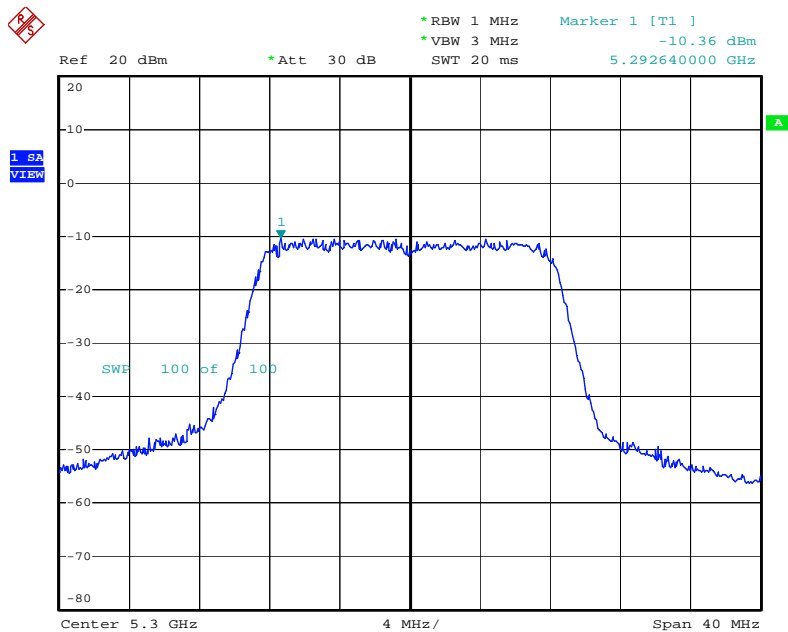

Date: 20.SEP.2007 11:57:38

Power Density Plot on Configuration IEEE 802.11a / 5330 MHz

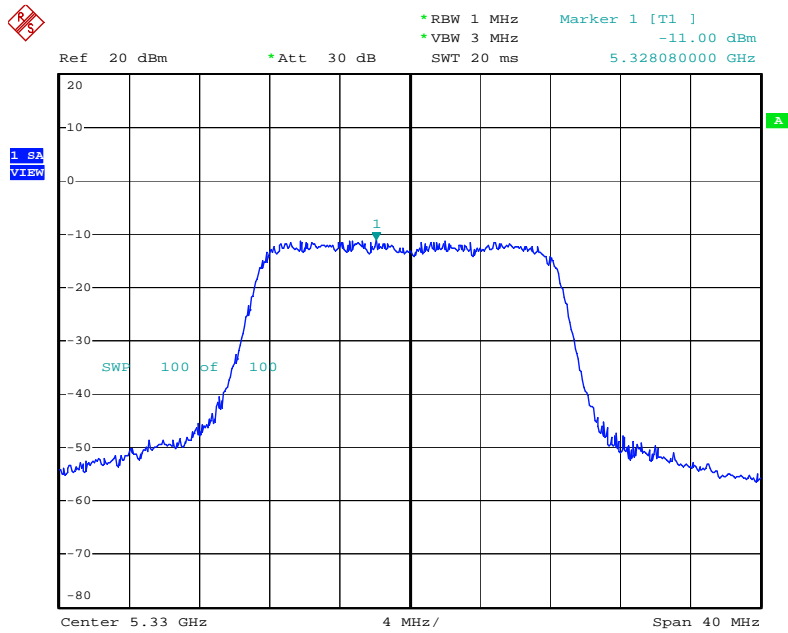

Date: 20.SEP.2007 11:55:59

Power Density Plot on Configuration IEEE 802.11a / 5500 MHz

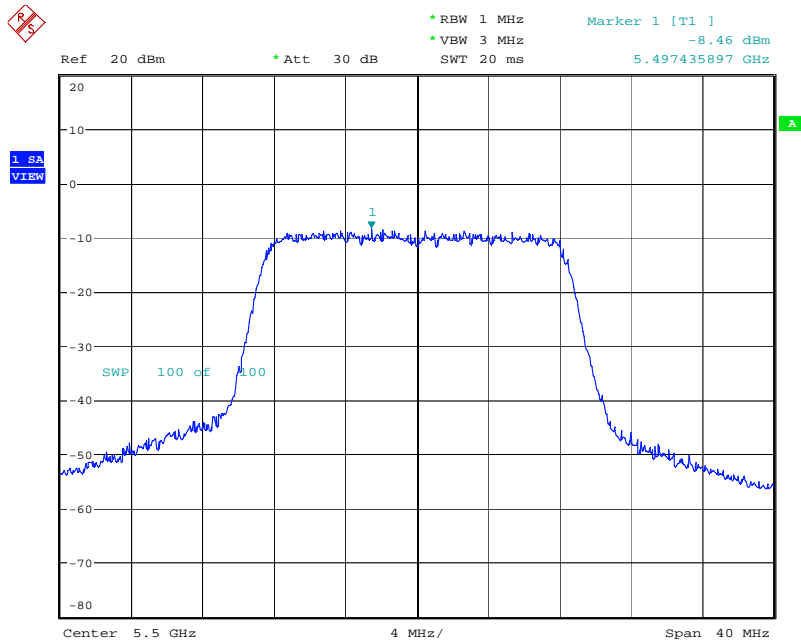

Date: 23.JAN.2007 15:41:36

Power Density Plot on Configuration IEEE 802.11a / 5600 MHz

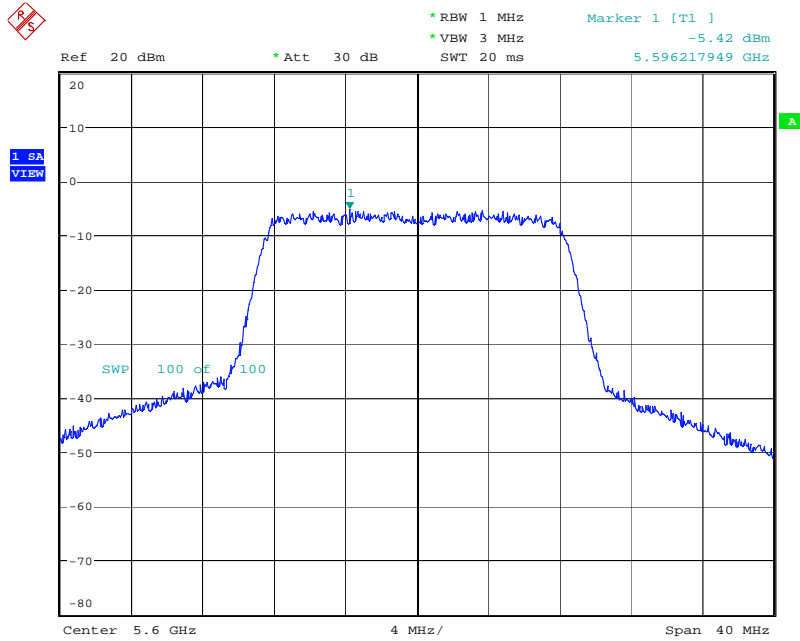

Date: 23.JAN.2007 15:49:25

Power Density Plot on Configuration IEEE 802.11a / 5700 MHz

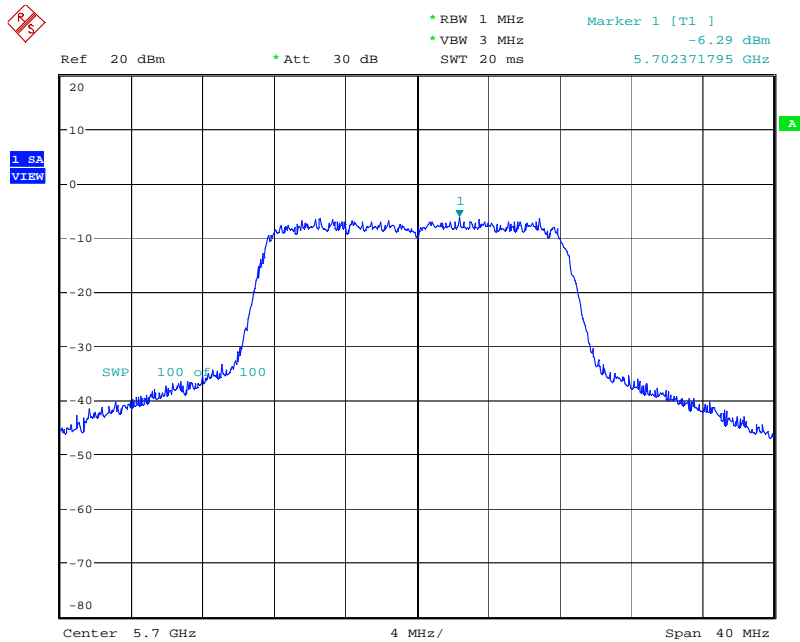

Date: 23.JAN.2007 15:50:44

4.5. Peak Excursion Measurement

4.5.1. Limit

The ratio of the peak excursion of the modulation envelope (measured using a peak hold function) to the maximum conducted output power (measured as specified above) shall not exceed 13 dB across any 1 MHz bandwidth or the emissions bandwidth whichever is less.

4.5.2. Measuring Instruments and Setting

Please refer to section 5 of equipments list in this report. The following table is the setting of the spectrum analyzer.

Spectrum Parameter	Setting
Attenuation	Auto
Span Frequency	Encompass the entire emissions bandwidth (EBW) of the signal
RB	1000 kHz (Peak Trace) / 1000 kHz (Average Trace)
VB	3000 kHz (Peak Trace) / 300 kHz (Average Trace)
Detector	Peak (Peak Trace) / Sample (Average Trace)
Trace	Max Hold
Sweep Time	60s

4.5.3. Test Procedures

1. The transmitter output (antenna port) was connected to the spectrum analyzer.
2. Set the spectrum analyzer span to view the entire emissions bandwidth. The largest difference between the following two traces (Peak Trace and Average Trace) must be ≤ 13 dB for all frequencies across the emissions bandwidth. Submit a plot.
3. Peak Trace: Set RBW = 1 MHz, VBW ≥ 3 MHz with peak detector and max-hold settings.
4. Average Trace: Method #3—video averaging with max hold--and sum power across the band. Set span to encompass the entire emissions bandwidth (EBW) of the signal. Set sweep trigger to "free run". Set RBW = 1 MHz. Set VBW $\geq 1/T$ (IEEE 802.11a VBW = 300kHz $\geq 1/4 \mu$ s). Use sample detector mode if bin width (i.e., span/number of points in spectrum) < 0.5 RBW. Otherwise use peak detector mode. Set max hold. Allow max hold to run for 60 seconds.

4.5.4. Test Setup Layout

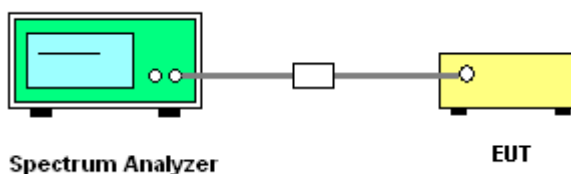

4.5.5. Test Deviation

There is no deviation with the original standard.

4.5.6. EUT Operation during Test

The EUT was programmed to be in continuously transmitting mode.

4.5.7. Test Result of Peak Excursion

Temperature	23°C	Humidity	58%
Test Engineer	Leo Hung	Configurations	802.11a

Configuration IEEE 802.11a

Frequency	Peak Excursion (dB)	Max. Limit (dB)	Result
5270 MHz	5.42	13	Complies
5300 MHz	5.38	13	Complies
5330 MHz	5.86	13	Complies
5500 MHz	5.13	13	Complies
5600 MHz	5.36	13	Complies
5700 MHz	4.32	13	Complies

Peak Excursion Plot on Configuration IEEE 802.11 a / 5270 MHz

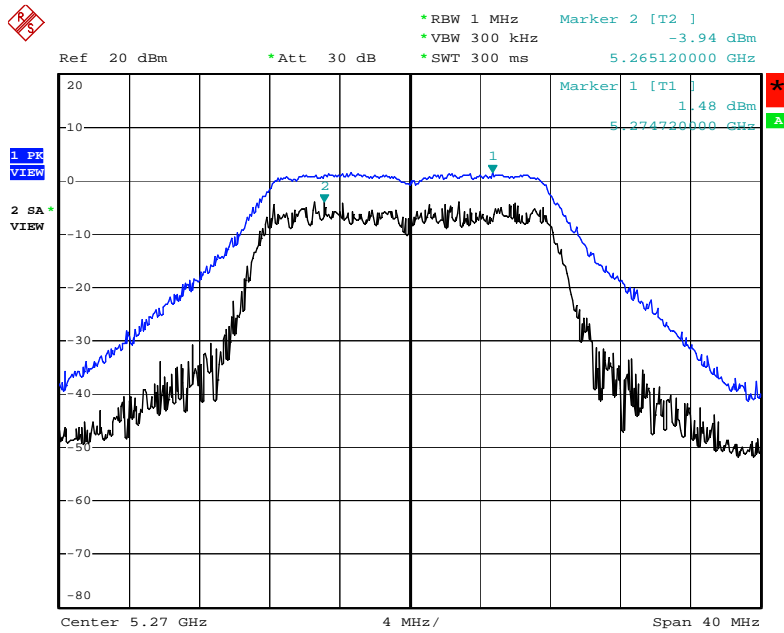

Date: 20.SEP.2007 12:06:56

Peak Excursion Plot on Configuration IEEE 802.11 a / 5300 MHz

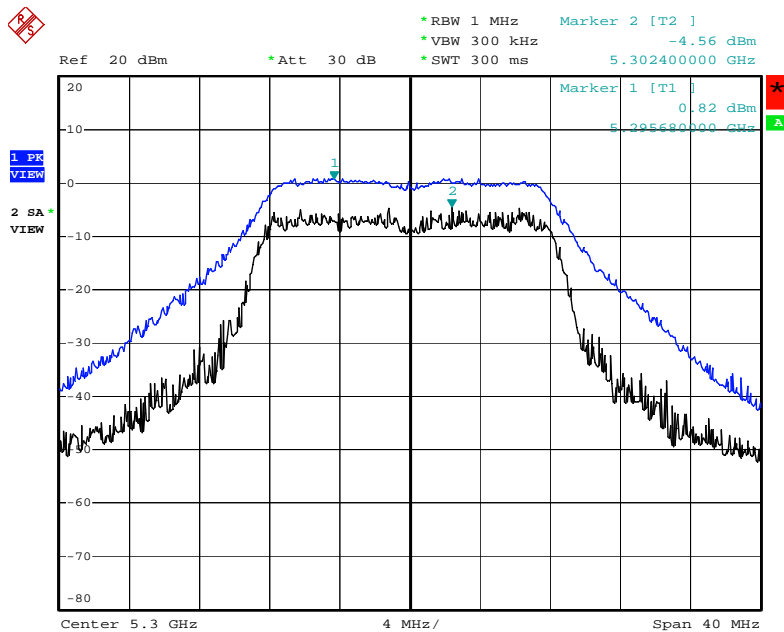

Date: 20.SEP.2007 11:58:25

Peak Excursion Plot on Configuration IEEE 802.11 a / 5330 MHz

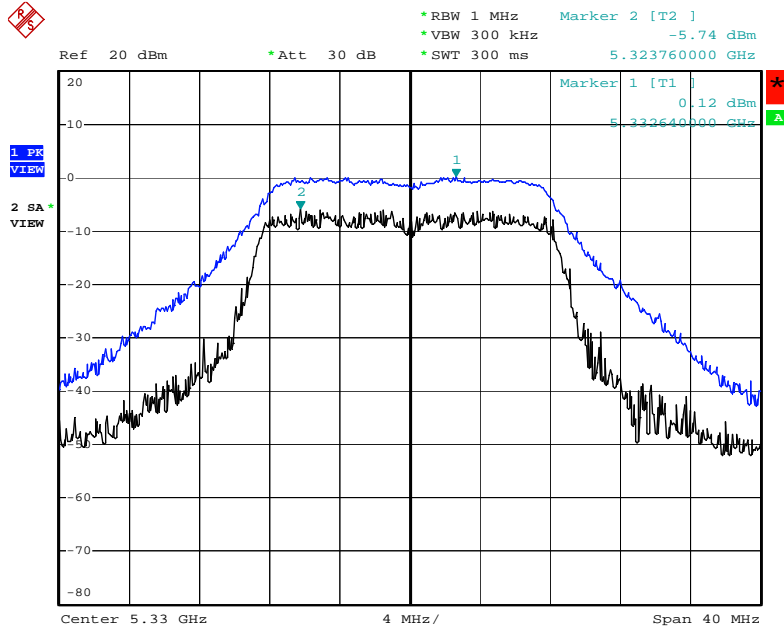

Date: 20.SEP.2007 11:56:46

Peak Excursion Plot on Configuration IEEE 802.11 a / 5500 MHz

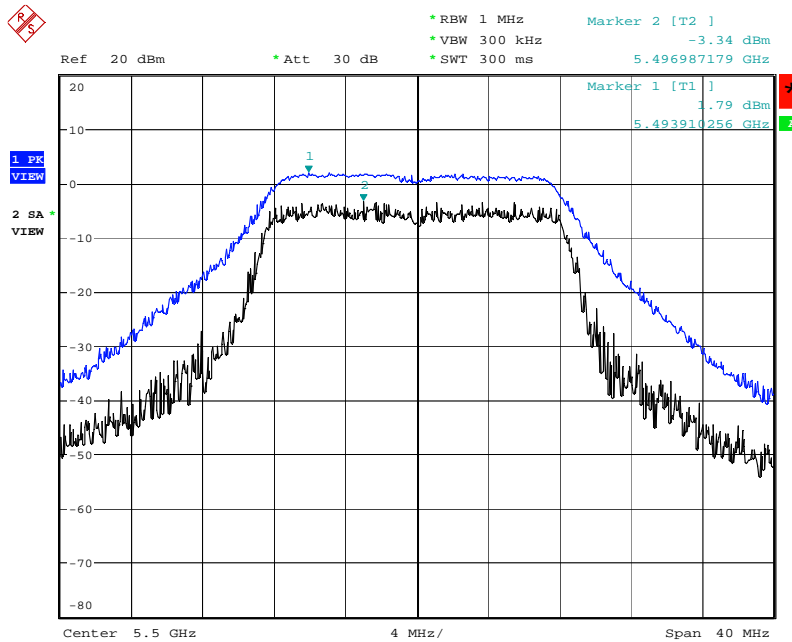

Date: 23.JAN.2007 15:42:24

Peak Excursion Plot on Configuration IEEE 802.11 a / 5600 MHz

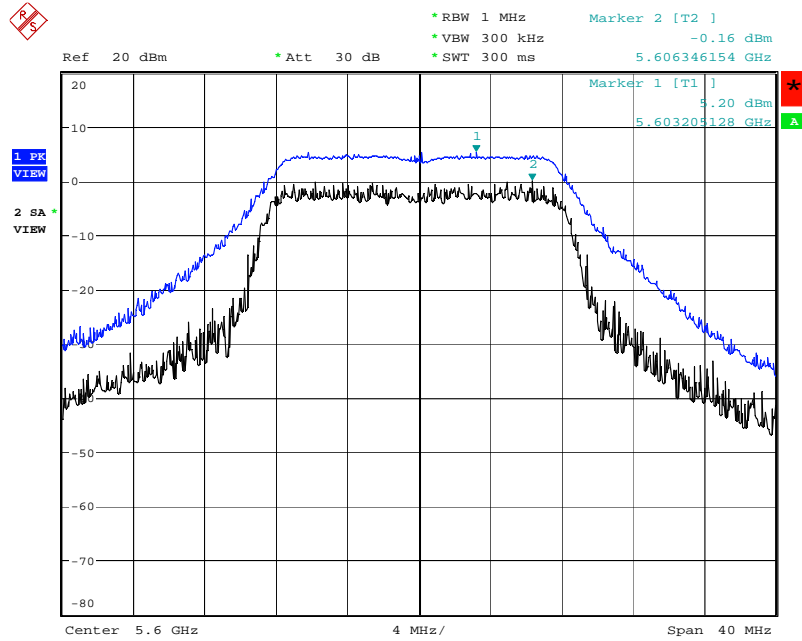

Date: 23.JAN.2007 15:50:13

Peak Excursion Plot on Configuration IEEE 802.11 a / 5700 MHz

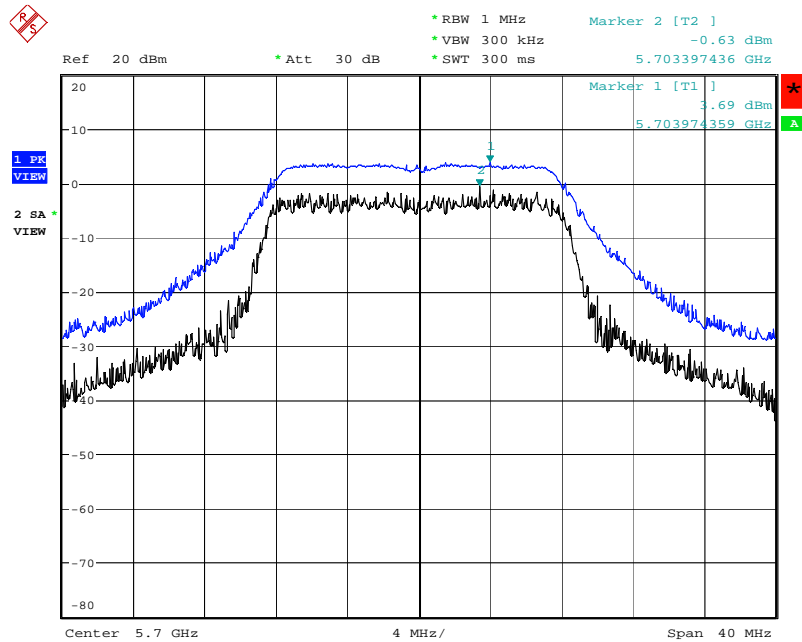

Date: 23.JAN.2007 15:51:33

4.6. Radiated Emissions Measurement

4.6.1. Limit

For transmitters operating in the 5.25-5.35 GHz band: all emissions outside of the 5.25-5.35 GHz band shall not exceed an EIRP of -27 dBm/MHz (68.3dBuV/m at 3m). For transmitters operating in the 5.47-5.725 GHz band: all emissions outside of the 5.47-5.725 GHz band shall not exceed an EIRP of -27 dBm/MHz (68.3dBuV/m at 3m). In addition, In case the emission fall within the restricted band specified on 15.205(a), then the 15.209(a) limit in the table below has to be followed.

Frequencies (MHz)	Field Strength (microrvolts/meter)	Measurement Distance (meters)
0.009~0.490	2400/F(KHz)	300
0.490~1.705	24000/F(KHz)	30
1.705~30.0	30	30
30~88	100	3
88~216	150	3
216~960	200	3
Above 960	500	3

4.6.2. Measuring Instruments and Setting

Please refer to section 5 of equipments list in this report. The following table is the setting of spectrum analyzer and receiver.

Spectrum Parameter	Setting
Attenuation	Auto
Start Frequency	1000 MHz
Stop Frequency	40 GHz
RB / VB (Emission in restricted band)	1 MHz / 1MHz for Peak, 1 MHz / 10Hz for Average
RB / VB (Emission in non-restricted band)	1000KHz / 1000KHz for peak

Receiver Parameter	Setting
Attenuation	Auto
Start ~ Stop Frequency	9kHz~150kHz / RB 200Hz for QP
Start ~ Stop Frequency	150kHz~30MHz / RB 9kHz for QP
Start ~ Stop Frequency	30MHz~1000MHz / RB 120kHz for QP

4.6.3. Test Procedures

1. Configure the EUT according to ANSI C63.4. The EUT was placed on the top of the turntable 0.8 meter above ground. The phase center of the receiving antenna mounted on the top of a height-variable antenna tower was placed 3 meters far away from the turntable.
2. Power on the EUT and all the supporting units. The turntable was rotated by 360 degrees to determine the position of the highest radiation.
3. The height of the broadband receiving antenna was varied between one meter and four meters above ground to find the maximum emissions field strength of both horizontal and vertical polarization.
4. For each suspected emissions, the antenna tower was scan (from 1 M to 4 M) and then the turntable was rotated (from 0 degree to 360 degrees) to find the maximum reading.
5. Set the test-receiver system to Peak or CISPR quasi-peak Detect Function with specified bandwidth under Maximum Hold Mode.
6. For emissions above 1GHz, use 1MHz VBW and RBW for peak reading. Then 1MHz RBW and 10Hz VBW for average reading in spectrum analyzer.
7. When the radiated emissions limits are expressed in terms of the average value of the emissions, and pulsed operation is employed, the measurement field strength shall be determined by averaging over one complete pulse train, including blanking intervals, as long as the pulse train does not exceed 0.1 seconds. As an alternative (provided the transmitter operates for longer than 0.1 seconds) or in cases where the pulse train exceeds 0.1 seconds, the measured field strength shall be determined from the average absolute voltage during a 0.1 second interval during which the field strength is at its maximum value.
8. If the emissions level of the EUT in peak mode was 3 dB lower than the average limit specified, then testing will be stopped and peak values of EUT will be reported, otherwise, the emissions which do not have 3 dB margin will be repeated one by one using the quasi-peak method for below 1GHz.
9. For testing above 1GHz, the emissions level of the EUT in peak mode was lower than average limit (that means the emissions level in peak mode also complies with the limit in average mode), then testing will be stopped and peak values of EUT will be reported, otherwise, the emissions will be measured in average mode again and reported.
10. In case the emission is lower than 30MHz, loop antenna has to be used for measurement and the recorded data should be QP measured by receiver. High – Low scan is not required in this case.

4.6.4. Test Setup Layout

For radiated emissions below 30MHz

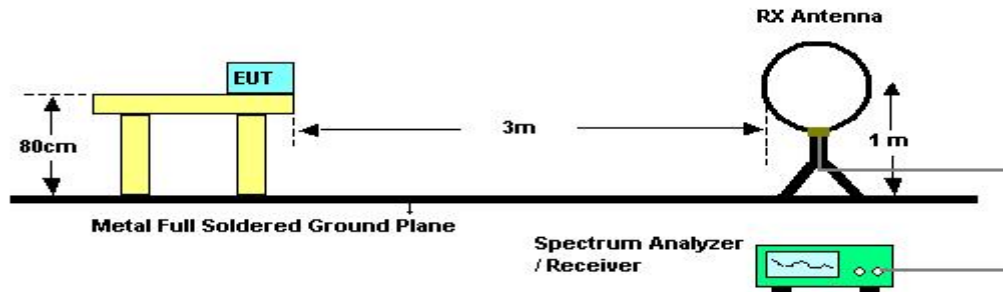

For radiated emissions above 30MHz

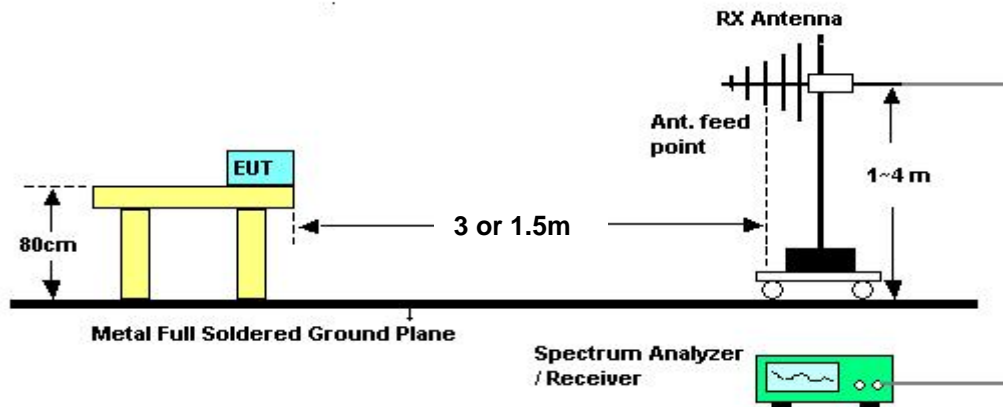

Above 5GHz shall be extrapolated to the specified distance using an extrapolation factor of 20 dB/decade from 3m to 1.5m.

Distance extrapolation factor = $20 \log(\text{specific distance [3m]} / \text{test distance [1.5m]})$ (dB);

Limit line = specific limits (dBuV) + distance extrapolation factor [6 dB].

4.6.5. Test Deviation

There is no deviation with the original standard.

4.6.6. EUT Operation during Test

The EUT was programmed to be in continuously transmitting mode.

4.6.7. Results of Radiated Emissions (9kHz~30MHz)

Temperature	23°C	Humidity	58%
Test Engineer	Beck Wu	Configurations	802.11a Ch 140

Freq. (MHz)	Level (dBuV)	Over Limit (dB)	Limit Line (dBuV)	Remark
-	-	-	-	See Note

Note:

The amplitude of spurious emissions that are attenuated by more than 20dB below the permissible value has no need to be reported.

Distance extrapolation factor = $40 \log(\text{specific distance} / \text{test distance})$ (dB);

Limit line = specific limits (dBuV) + distance extrapolation factor.

4.6.8. Results of Radiated Emissions (30MHz~1GHz)

Temperature	23°C	Humidity	58%
Test Engineer	Beck Wu	Configurations	802.11a Ch 140

Vertical

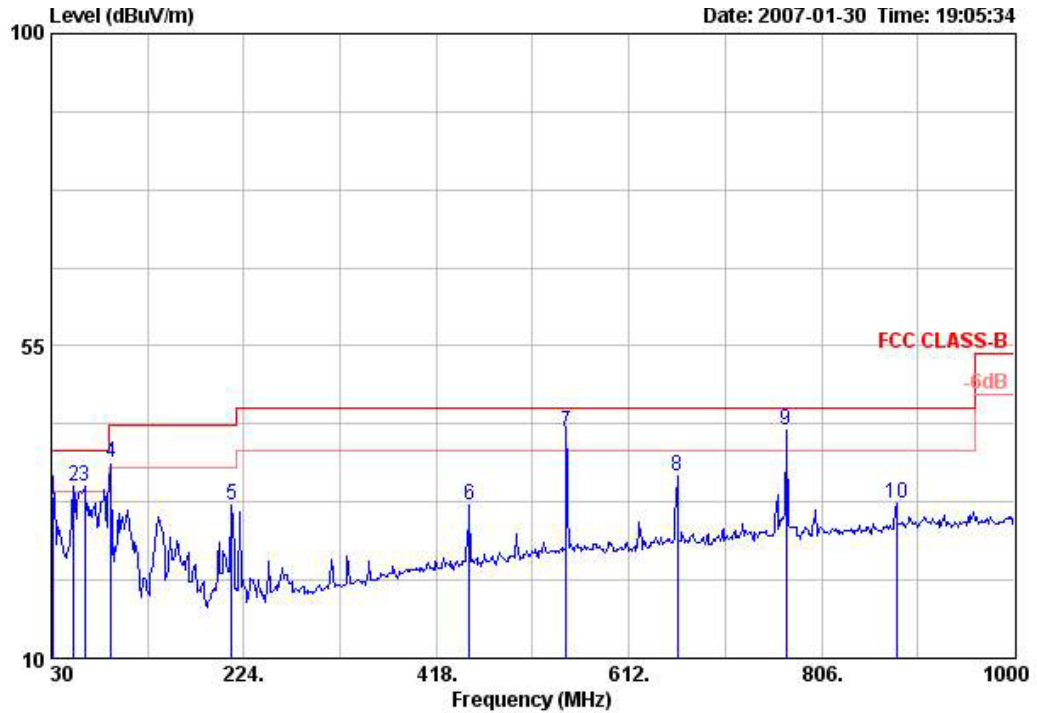

	Read Freq	Read Level	Read Level	Limit Line	Over Limit	Antenna Factor	Preamp Factor	Cable Loss	Remark	Ant Pos	Table Pos	Table Pol/Phase
	MHz	dBuV	dBuV/m	dBuV/m	dB	dB/m	dB	dB		cm	deg	
1	31.940	45.27	33.19	40.00	-6.81	18.66	31.67	0.93	Peak	---	---	VERTICAL
2 !	52.310	56.66	34.73	40.00	-5.27	8.68	31.78	1.17	Peak	---	---	VERTICAL
3 !	63.950	58.78	34.89	40.00	-5.11	6.60	31.82	1.33	Peak	---	---	VERTICAL
4 !	90.140	58.80	38.08	43.50	-5.42	9.40	31.55	1.43	Peak	---	---	VERTICAL
5	211.390	50.83	32.06	43.50	-11.44	10.59	31.42	2.06	Peak	---	---	VERTICAL
6	450.980	42.93	32.14	46.00	-13.86	17.21	30.92	2.92	Peak	---	---	VERTICAL
7 !	548.950	51.30	42.63	46.00	-3.37	18.88	30.75	3.20	Peak	---	---	VERTICAL
8	660.500	43.32	36.13	46.00	-9.87	19.64	30.35	3.52	Peak	---	---	VERTICAL
9 *	770.110	48.88	42.96	46.00	-3.04	20.46	30.23	3.86	Peak	---	---	VERTICAL
10	881.660	36.55	32.26	46.00	-13.74	21.49	29.85	4.06	Peak	---	---	VERTICAL

Horizontal

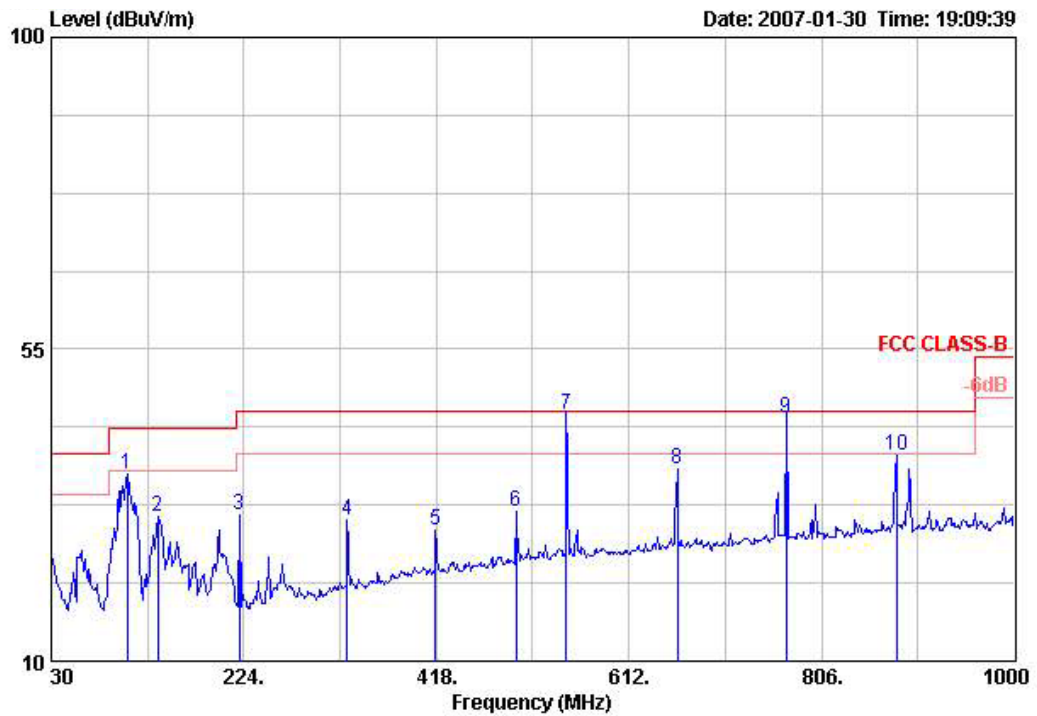

	Read Freq	Read Level	Limit Level	OverLimit	Antenna Factor	Preamp Factor	Cable Loss	Remark	Ant Pos	Table Pos	Pol/Phase
	MHz	dBuV	dBuV/m	dBuV/m	dB	dB/m	dB		cm	deg	
1	106.630	54.98	37.07	43.50	-6.43	12.32	31.73	1.50 Peak	---	---	HORIZONTAL
2	137.670	48.84	30.89	43.50	-12.61	11.94	31.59	1.70 Peak	---	---	HORIZONTAL
3	219.150	49.84	31.05	46.00	-14.95	10.51	31.41	2.10 Peak	---	---	HORIZONTAL
4	327.790	44.44	30.25	46.00	-15.75	14.78	31.28	2.31 Peak	---	---	HORIZONTAL
5	417.030	40.31	28.89	46.00	-17.11	16.81	30.99	2.76 Peak	---	---	HORIZONTAL
6	498.510	41.44	31.66	46.00	-14.34	17.87	30.94	3.28 Peak	---	---	HORIZONTAL
7 *	548.950	54.30	45.63	46.00	-0.37	18.88	30.75	3.20 QP	123	23	HORIZONTAL
8	660.500	44.88	37.70	46.00	-8.30	19.64	30.35	3.52 Peak	---	---	HORIZONTAL
9 *	770.110	51.00	45.09	46.00	-0.91	20.46	30.23	3.86 QP	145	33	HORIZONTAL
10	881.660	43.86	39.56	46.00	-6.44	21.49	29.85	4.06 Peak	---	---	HORIZONTAL

Note:

The amplitude of spurious emissions that are attenuated by more than 20dB below the permissible value has no need to be reported.

Emission level (dBUV/m) = 20 log Emission level (uV/m).

Corrected Reading: Antenna Factor + Cable Loss + Read Level - Preamp Factor = Level.

4.6.9. Results for Radiated Emissions (1GHz~40GHz)

Temperature	23°C	Humidity	58%
Test Engineer	Beck Wu	Configurations	802.11a Ch 54

Vertical

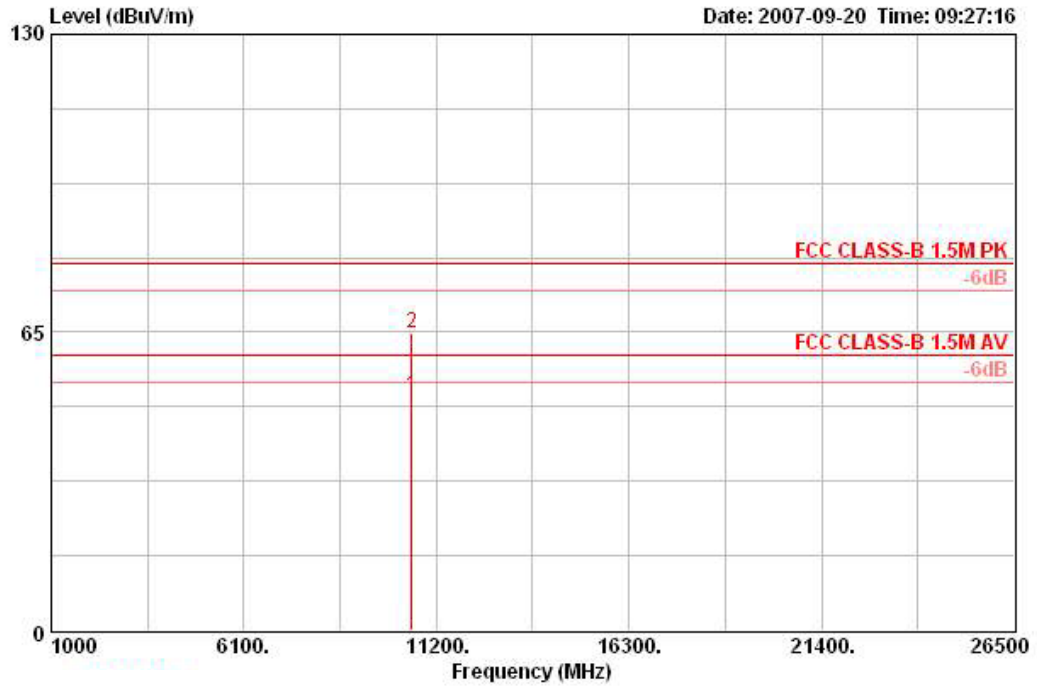

	Freq	Level	Over Limit	Limit Line	ReadAntenna	Preamp	Cable	Table	Ant
	MHz	dBUV/m	dB	dBUV/m	dBuV	dB/m	dB	deg	cm
1	10539.200	50.96	-9.04	60.00	36.76	38.99	35.15	10.37	356
2	10549.200	64.73	-15.27	80.00	50.54	38.98	35.15	10.37	356

Horizontal

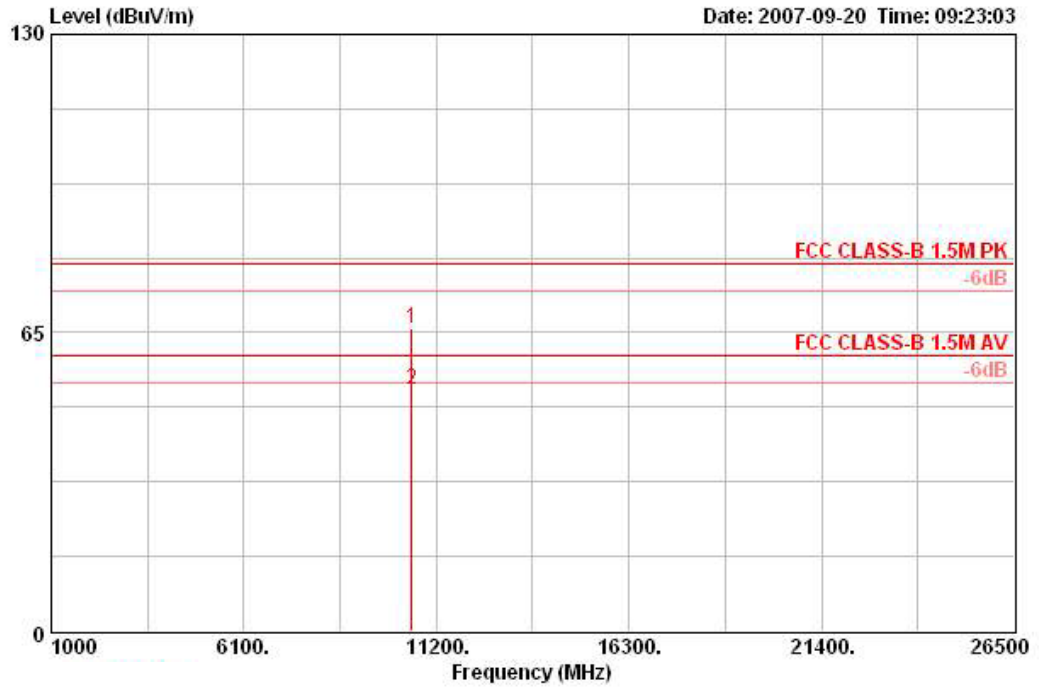

	Freq	Level	Over Limit	Limit Line	Read Level	Antenna Factor	Preamp Factor	Cable Loss	Remark	Table Pos	Ant Pos	Pol/Phase
	MHz	dBuV/m	dB	dBuV/m	dBuV	dB/m	dB	dB		deg	cm	
1	10539.000	65.78	-14.22	80.00	51.58	38.99	35.15	10.37	PEAK	0	122	HORIZONTAL
2	10539.400	52.48	-7.52	60.00	38.29	38.98	35.15	10.37	AVERAGE	0	122	HORIZONTAL

Temperature	23°C	Humidity	58%
Test Engineer	Beck Wu	Configurations	802.11a Ch 60

Vertical

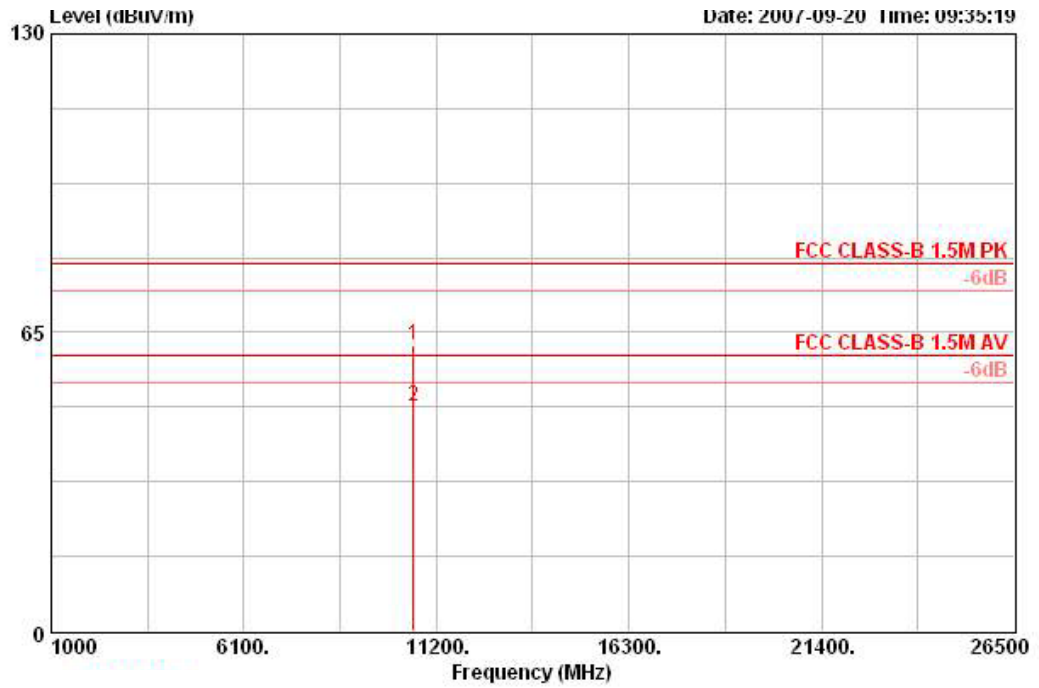

	Freq	Level	Over Limit	Limit Line	Read Level	Antenna Factor	Preamp Factor	Cable Loss	Remark	Table Pos	Ant Pos	Pol/Phase
	MHz	dBuV/m	dB	dBuV/m	dBuV	dB/m	dB	dB		deg	cm	
1	10598.900	62.40	-17.60	80.00	48.19	38.96	35.10	10.36	PEAK	16	100	VERTICAL
2	10601.200	48.95	-11.05	60.00	34.71	38.96	35.08	10.35	AVERAGE	16	100	VERTICAL

Horizontal

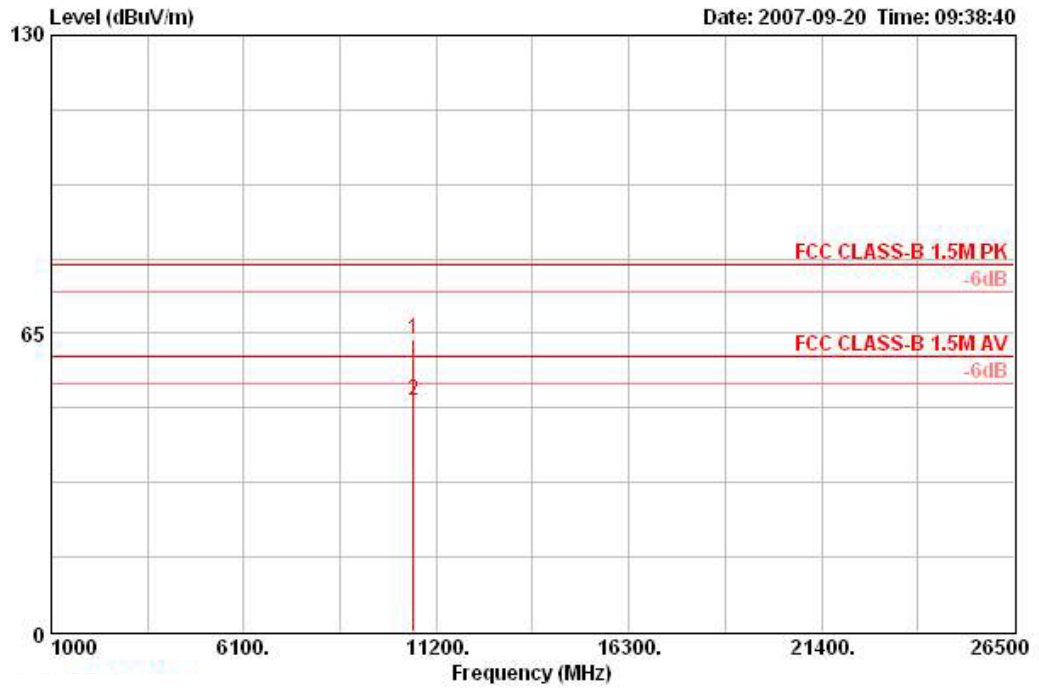

	Freq	Level	Over Limit	Limit Line	Read Level	Antenna Factor	Preamp Factor	Cable Loss	Remark	Table Pos	Ant Pos	Pol/Phase
	MHz	dBuV/m	dB	dBuV/m	dBuV	dB/m	dB	dB		deg	cm	
1	10599.000	63.81	-16.19	80.00	49.60	38.96	35.10	10.36	PEAK	55	100	HORIZONTAL
2	10599.100	50.45	-9.55	60.00	36.24	38.96	35.10	10.36	AVERAGE	55	100	HORIZONTAL

Temperature	23°C	Humidity	58%
Test Engineer	Beck Wu	Configurations	802.11a Ch 66

Vertical

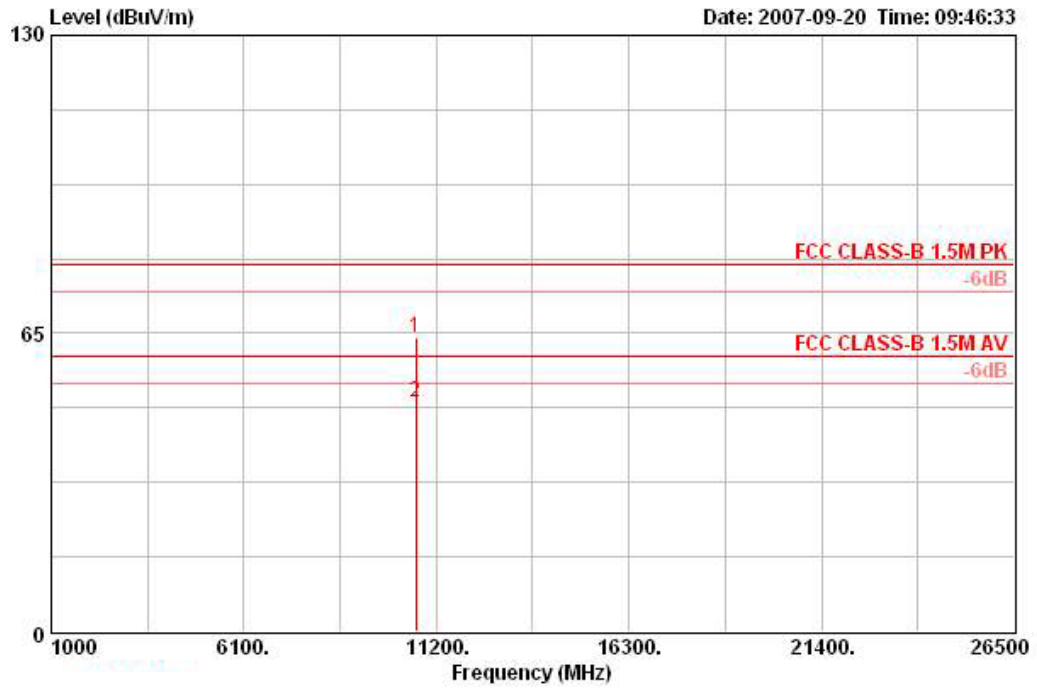

	Freq	Level	Over Limit	Limit Line	Read Level	Antenna Factor	Preamp Factor	Cable Loss	Remark	Table Pos	Ant Pos	Pol/Phase
	MHz	dBuV/m	dB	dBuV/m	dBuV	dB/m	dB	dB		deg	cm	
1	10660.200	64.02	-15.98	80.00	49.77	38.92	35.00	10.34	PEAK	336	100	VERTICAL
2	10660.400	49.95	-10.05	60.00	35.70	38.92	35.00	10.34	AVERAGE	336	100	VERTICAL

Horizontal

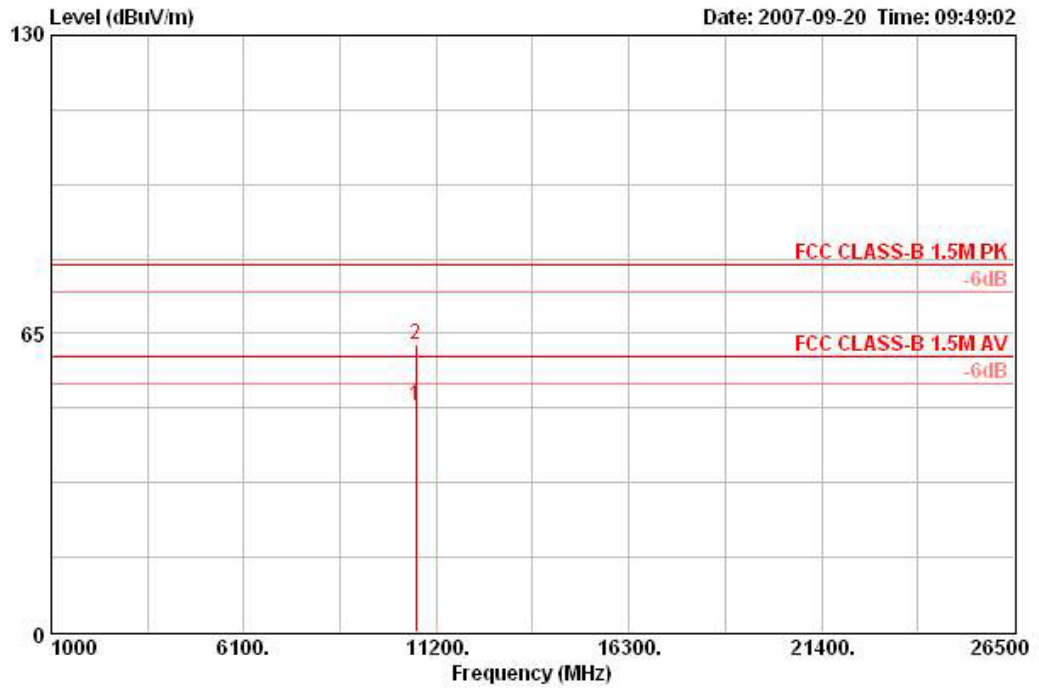

	Freq	Level	Over	Limit	Read	Antenna	Preamp	Cable	Table	Ant
	MHz	dBUV/m	Limit	Line	Level	Factor	Factor	Loss	Pos	Pos
			dB	dBUV/m	dBuV	dB/m	dB	dB	deg	cm
1	10660.200	49.27	-10.73	60.00	35.02	38.92	35.00	10.34	314	100 HORIZONTAL
2	10662.100	62.54	-17.46	80.00	48.27	38.92	34.97	10.33	314	100 HORIZONTAL

Temperature	23°C	Humidity	58%
Test Engineer	Beck Wu	Configurations	802.11a Ch 100

Vertical

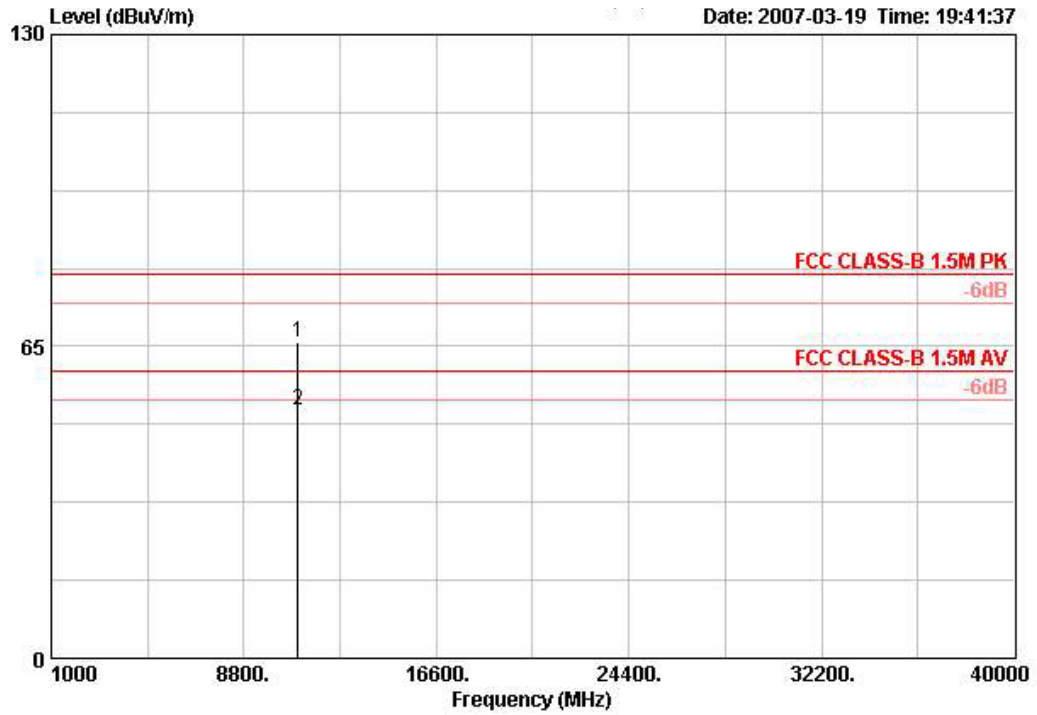

	Read Freq	Read Level	Read Level	Limit Line	OverLimit	Antenna Factor	Preamp Factor	Cable Loss	Remark	Ant Pos	Table Pos	Pol/Phase
	MHz	dBuV	dBuV/m	dBuV/m	dB	dB/m	dB	dB		cm	deg	
1	10999.700	54.63	65.89	80.00	-14.11	38.30	34.76	7.72	PEAK	100	269	VERTICAL
2	11000.200	40.45	51.71	60.00	-8.29	38.30	34.76	7.72	AVERAGE	100	269	VERTICAL

Horizontal

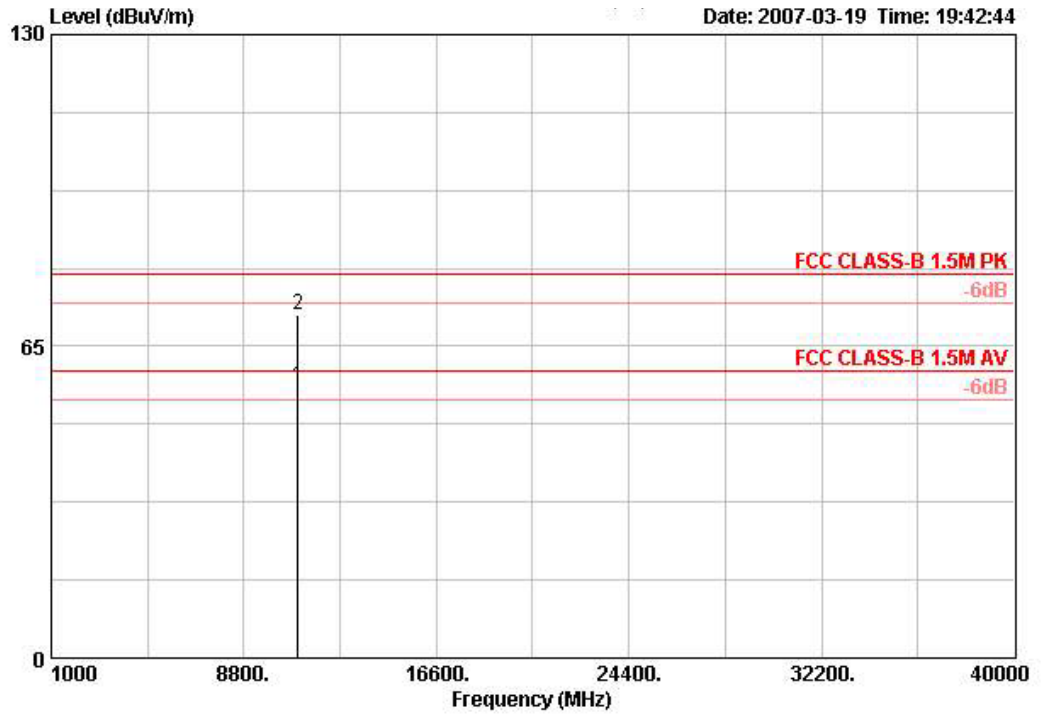

	Read Freq	Read Level	Limit Level	Limit Line	Over Limit	Antenna Factor	Preamp Factor	Cable Loss	Remark	Ant Pos	Table Pos	Pol/Phase
	MHz	dBuV	dBuV/m	dBuV/m	dB	dB/m	dB	dB		cm	deg	
1 !	10999.500	45.44	56.71	60.00	-3.29	38.30	34.76	7.72	AVERAGE	100	299	HORIZONTAL
2	11001.100	60.20	71.46	80.00	-8.54	38.30	34.76	7.72	PEAK	100	299	HORIZONTAL



Temperature	23°C	Humidity	58%
Test Engineer	Beck Wu	Configurations	802.11a Ch 120

Vertical

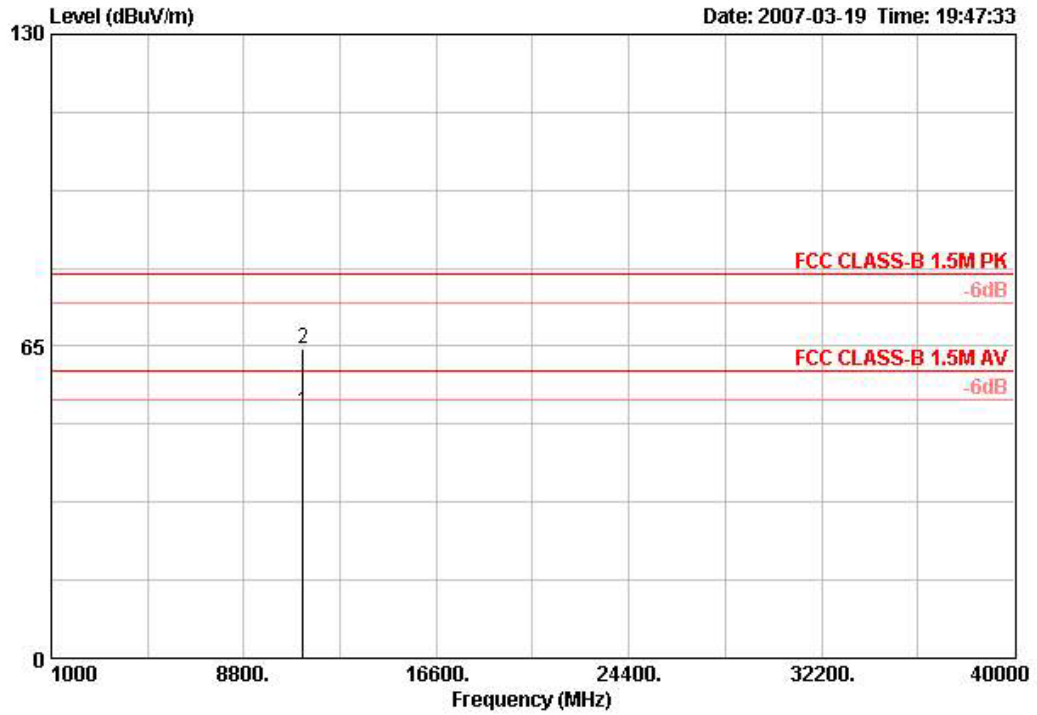

	Read Freq	Read Level	Read Level	Limit Line	Over Limit	Antenna Factor	Preamp Factor	Cable Loss	Remark	Ant Pos	Table Pos	Pol/Phase
	MHz	dBuV	dBuV/m	dBuV/m	dB	dB/m	dB	dB		cm	deg	
1	11201.700	39.86	51.21	60.00	-8.79	38.50	34.85	7.69	AVERAGE	100	253	VERTICAL
2	11206.300	52.96	64.31	80.00	-15.69	38.50	34.85	7.69	PEAK	100	253	VERTICAL

Horizontal

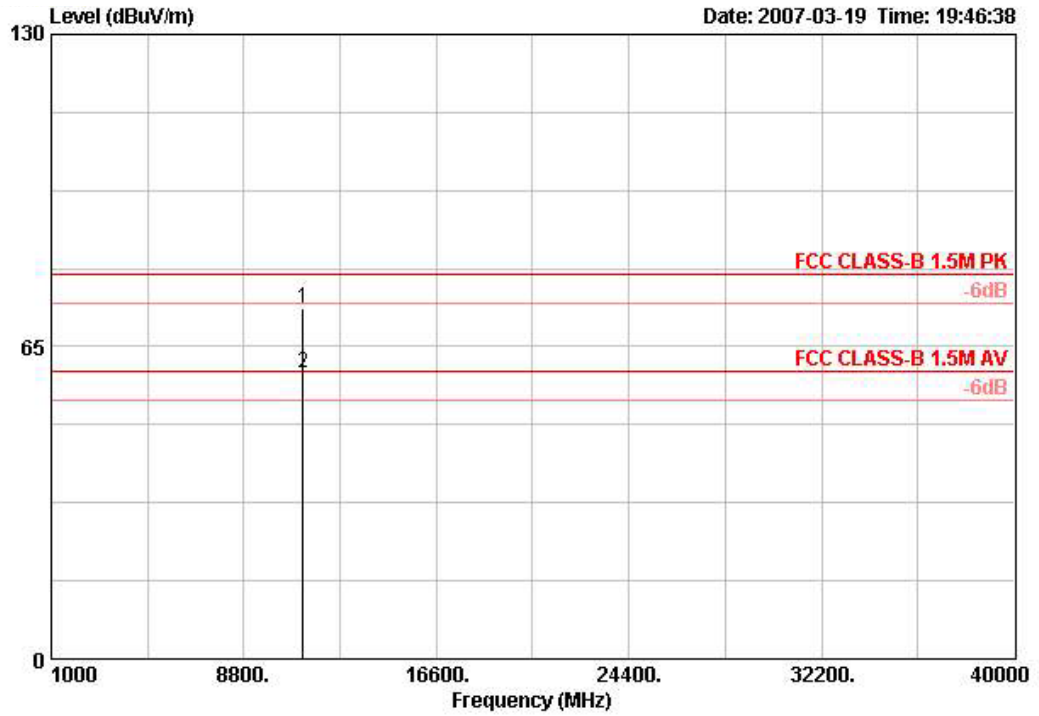

	Read	Limit	Over	Antenna	Preamp	Cable		Ant	Table			
	Level	Line	Limit	Factor	Factor	Loss	Remark	Pos	Pos			
	dBuV	dBuV/m	dBuV/m	dB	dB/m	dB		cm	deg			
1	11200.920	61.73	73.07	80.00	-6.93	38.50	34.85	7.69	PEAK	100	301	HORIZONTAL
2 *	11201.560	48.18	59.52	60.00	-0.48	38.50	34.85	7.69	AVERAGE	100	301	HORIZONTAL

Temperature	23°C	Humidity	58%
Test Engineer	Beck Wu	Configurations	802.11a Ch 140

Vertical

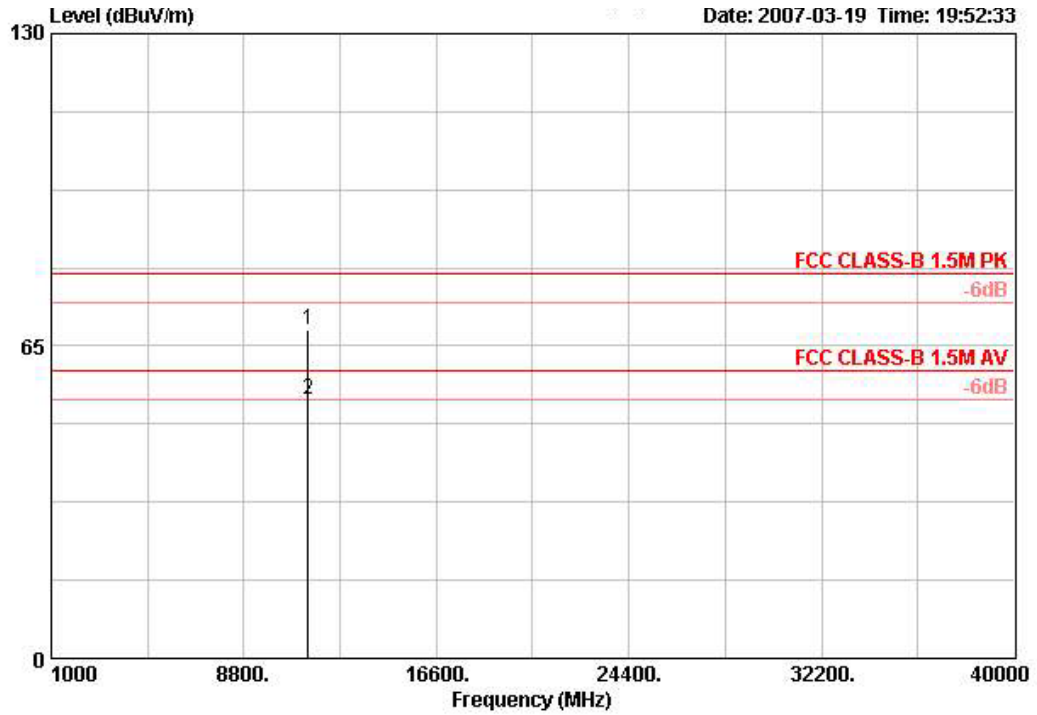

	Read Freq	Read Level	Read Level	Limit Line	Over Limit	Antenna Factor	Preamp Factor	Cable Loss	Remark	Ant Pos	Table Pos	Pol/Phase
	MHz	dBuV	dBuV/m	dBuV/m	dB	dB/m	dB	dB		cm	deg	
1	11393.700	56.83	68.23	80.00	-11.77	38.68	34.95	7.67	PEAK	102	272	VERTICAL
2	11408.600	42.44	53.86	60.00	-6.14	38.70	34.95	7.67	AVERAGE	102	272	VERTICAL

Horizontal

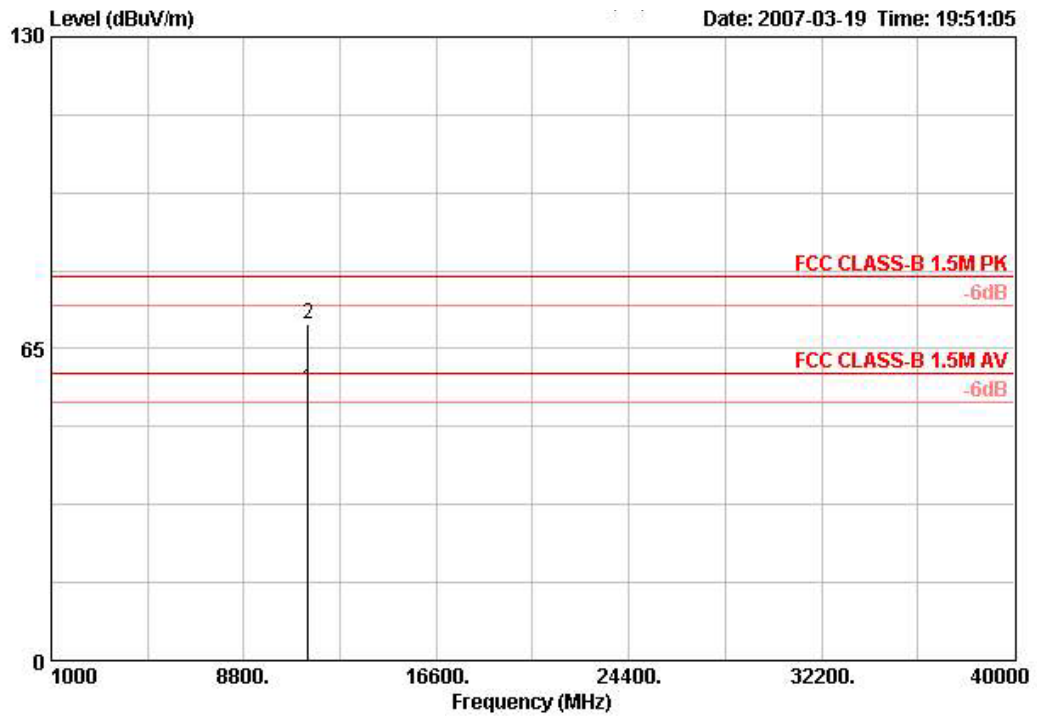

	Read Freq	Read Level	Level	Limit Line	Over Limit	Antenna Factor	Preamp Factor	Cable Loss	Remark	Ant Pos	Table Pos	Pol/Phase
	MHz	dBuV	dBuV/m	dBuV/m	dB	dB/m	dB	dB		cm	deg	
1 !	11400.600	45.43	56.85	60.00	-3.15	38.70	34.95	7.67	AVERAGE	100	298	HORIZONTAL
2	11406.000	58.66	70.07	80.00	-9.93	38.70	34.95	7.67	PEAK	100	298	HORIZONTAL

Note:

The amplitude of spurious emissions that are attenuated by more than 20dB below the permissible value has no need to be reported.

Emission level (dBUV/m) = 20 log Emission level (uV/m).

Corrected Reading: Antenna Factor + Cable Loss + Read Level - Preamp Factor = Level.

The limits above 5GHz shall be extrapolated to the specified distance using an extrapolation factor of 20 dB/decade from 3m to 1.5m.

Distance extrapolation factor = 20 log (specific distance [3m] / test distance [1.5m]) (dB);

Limit line = specific limits (dBUV) + distance extrapolation factor [6 dB].

4.7. Band Edge Emissions Measurement

4.7.1. Limit

For transmitters operating in the 5.25-5.35 GHz band: all emissions outside of the 5.25-5.35 GHz band shall not exceed an EIRP of -27 dBm/MHz (68.3dBuV/m at 3m). For transmitters operating in the 5.47-5.725 GHz band: all emissions outside of the 5.47-5.725 GHz band shall not exceed an EIRP of -27 dBm/MHz (68.3dBuV/m at 3m). In addition, In case the emission fall within the restricted band specified on 15.205(a), then the 15.209(a) limit in the table below has to be followed.

Frequencies (MHz)	Field Strength (micorvolts/meter)	Measurement Distance (meters)
0.009~0.490	2400/F(KHz)	300
0.490~1.705	24000/F(KHz)	30
1.705~30.0	30	30
30~88	100	3
88~216	150	3
216~960	200	3
Above 960	500	3

4.7.2. Measuring Instruments and Setting

Please refer to section 5 of equipments list in this report. The following table is the setting of the spectrum analyzer.

Spectrum Parameter	Setting
Attenuation	Auto
Span Frequency	100 MHz
RB / VB (Emission in restricted band)	1 MHz / 1MHz for Peak, 1 MHz / 10Hz for Average
RB / VB (Emission in non-restricted band)	1 MHz / 1 MHz for Peak

4.7.3. Test Procedures

1. The test procedure is the same as section 4.6.3, only the frequency range investigated is limited to 100MHz around bandedges.
2. In case the emission is fail due to the used RB/VB is too wide, marker-delta method of FCC Public Notice DA00-705 will be followed.

4.7.4. Test Setup Layout

This test setup layout is the same as that shown in section 4.6.4.

4.7.5. Test Deviation

There is no deviation with the original standard.

4.7.6. EUT Operation during Test

The EUT was programmed to be in continuously transmitting mode.

4.7.7. Test Result of Band Edge and Fundamental Emissions

Temperature	23°C	Humidity	58%
Test Engineer	Beck Wu	Configurations	802.11a Channel 54, 66

Channel 54

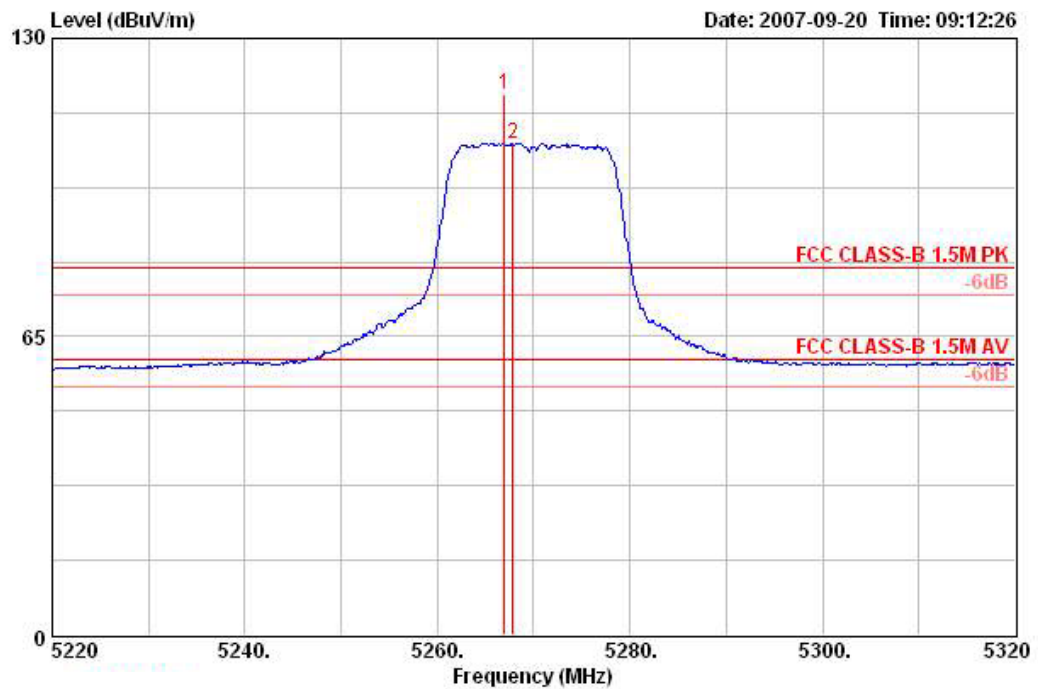

	Freq	Level	Over Limit	Limit Line	Read Level	Antenna Factor	Preamp Factor	Cable Loss	Remark	Table Pos	Ant Pos	Pol/Phase
	MHz	dBuV/m	dB	dBuV/m	dBuV	dB/m	dB	dB		deg	cm	
1	5267.000	117.86			79.08	34.36	0.00	4.41	PEAK	360	123	HORIZONTAL
2	5267.800	107.20			68.43	34.36	0.00	4.41	AVERAGE	360	123	HORIZONTAL

Item 1, 2 are the fundamental frequency at 5270 MHz.

Channel 66

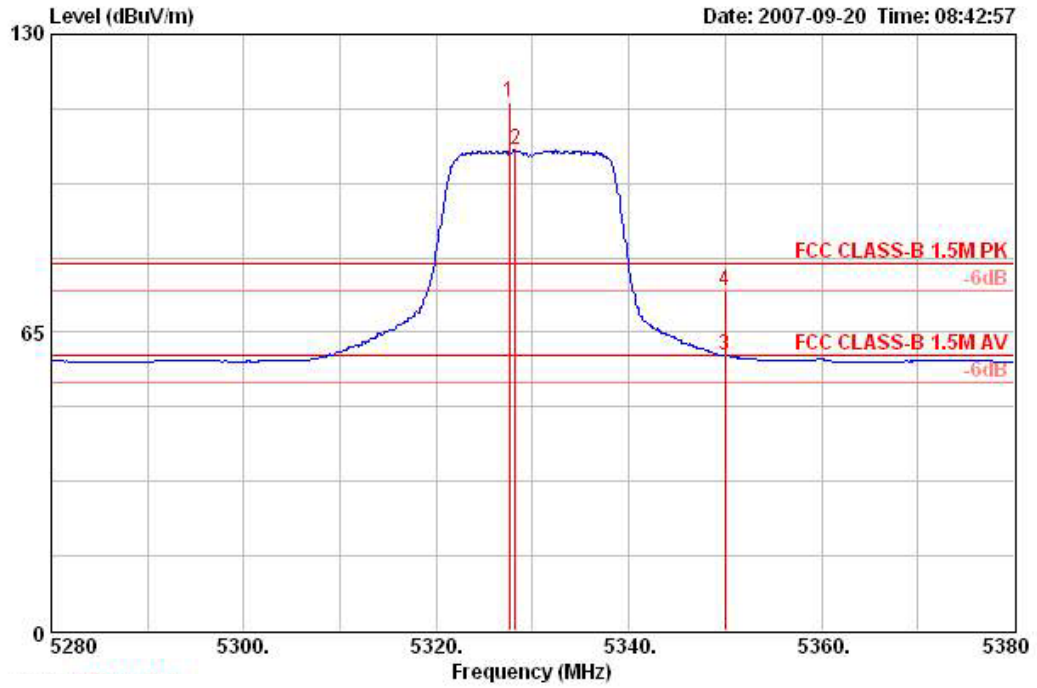

	Freq	Level	Over Limit	Limit Line	Read Level	Antenna Factor	Preamp Factor	Cable Loss	Remark	Table Pos	Ant Pos	Pol/Phase
	MHz	dBuV/m	dB	dBuV/m	dBuV	dB/m	dB	dB		deg	cm	
1	5327.600	115.02			76.15	34.49	0.00	4.39	PEAK	360	111	HORIZONTAL
2	5328.200	104.64			65.77	34.49	0.00	4.39	AVERAGE	360	111	HORIZONTAL
3	5350.000	59.93	-0.07	60.00	20.98	34.57	0.00	4.38	AVERAGE	360	111	HORIZONTAL
4	5350.000	74.15	-5.85	80.00	35.20	34.57	0.00	4.38	PEAK	360	111	HORIZONTAL

Item 1, 2 are the fundamental frequency at 5330 MHz.

Temperature	23°C	Humidity	58%
Test Engineer	Beck Wu	Configurations	802.11a Channel 100, 140

Channel 100

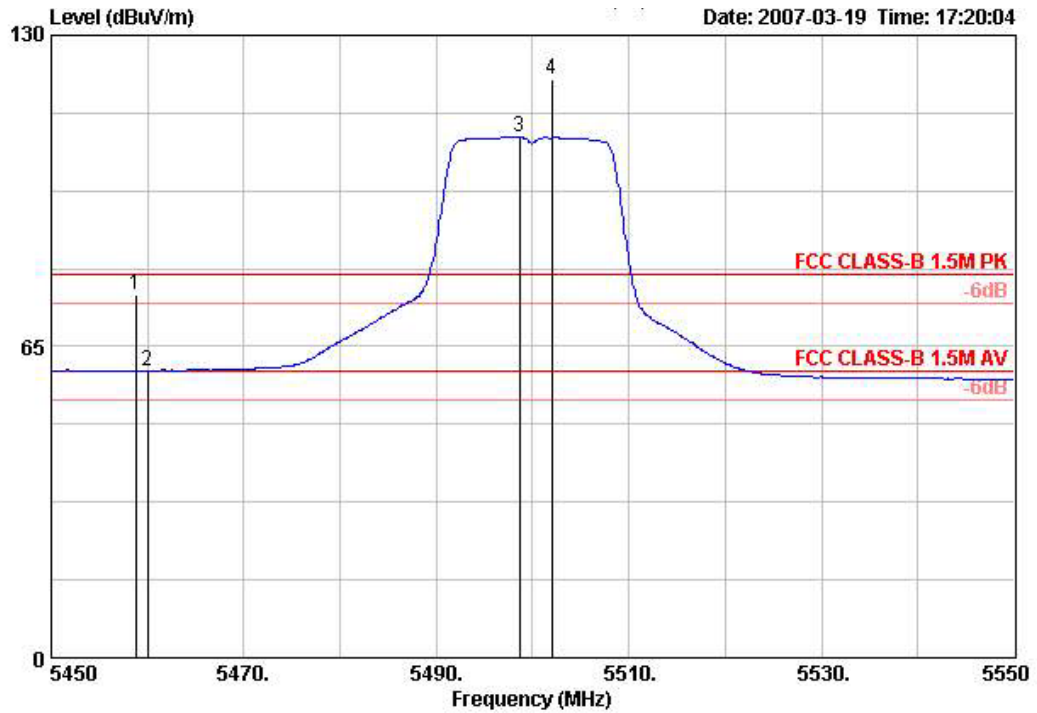

	Read Freq	Read Level	Read Level	Limit Line	OverLimit	Antenna Factor	Preamp Factor	Cable Loss	Remark	Ant Pos	Table Pos	Pol/Phase
	MHz	dBuV	dBuV/m	dBuV/m	dB	dB/m	dB	dB		cm	deg	
1 !	5458.800	37.16	75.87	80.00	-4.13	34.21	0.00	4.50	PEAK	105	350	HORIZONTAL
2 *	5460.000	21.26	59.97	60.00	-0.03	34.21	0.00	4.50	AVERAGE	105	350	HORIZONTAL
3 *	5498.600	69.91	108.73			34.30	0.00	4.52	AVERAGE	105	350	HORIZONTAL
4 *	5502.000	81.94	120.76			34.30	0.00	4.52	PEAK	105	350	HORIZONTAL

Item 3, 4 are the fundamental frequency at 5500 MHz.

Channel 140

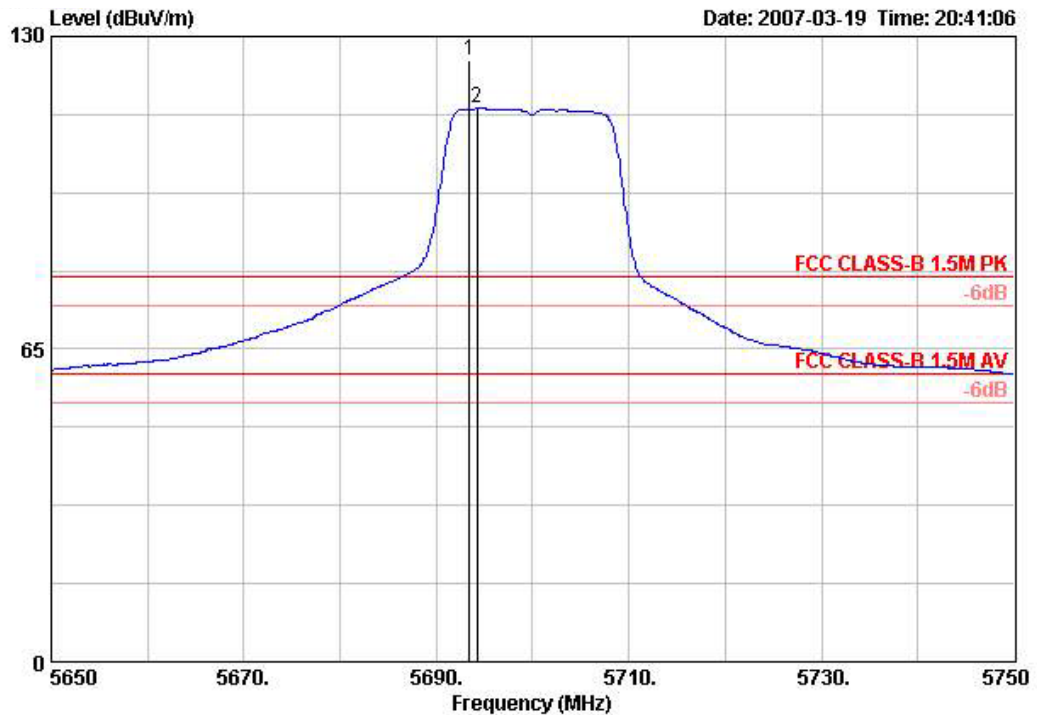

	Read Freq	Read Level	Read Level	Limit Line	Over Limit	Antenna Factor	Preamp Factor	Cable Loss	Remark	Ant Pos	Table Pos	Pol/Phase
	MHz	dBuV	dBuV/m	dBuV/m	dB	dB/m	dB	dB		cm	deg	
1 *	5693.400	86.23	125.21		34.34	0.00	4.64	PEAK		106	349	HORIZONTAL
2 *	5694.200	76.04	115.01		34.34	0.00	4.64	AVERAGE		106	349	HORIZONTAL

Item 1, 2 are the fundamental frequency at 5700 MHz.

Note:

Emission level (dBUV/m) = 20 log Emission level (uV/m)

Corrected Reading: Antenna Factor + Cable Loss + Read Level - Preamp Factor = Level

The limits above 5GHz shall be extrapolated to the specified distance using an extrapolation factor of 20 dB/decade from 3m to 1.5m.

Distance extrapolation factor = 20 log (specific distance [3m] / test distance [1.5m]) (dB);

Limit line = specific limits (dBUV) + distance extrapolation factor [6 dB].

EIRP Emission in Band on Configuration IEEE 802.11a / 5270 MHz

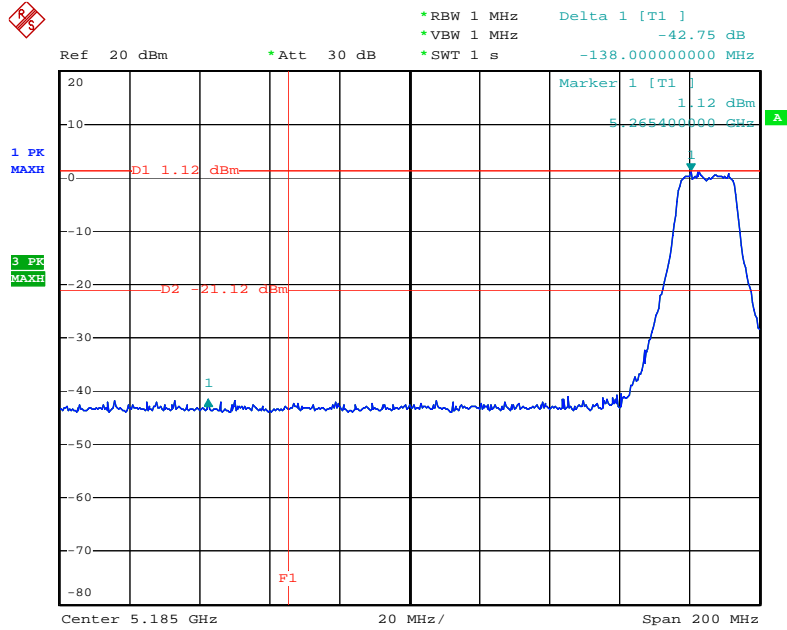

Date: 20.SEP.2007 12:14:10

EIRP Emission in Band on Configuration IEEE 802.11a / 5330 MHz

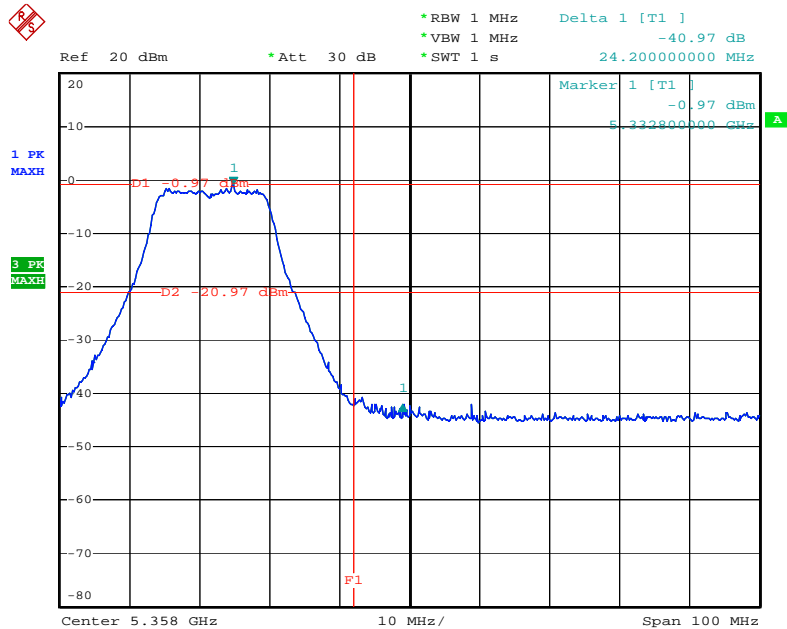

Date: 20.SEP.2007 12:17:07

EIRP Emission in Band on Configuration IEEE 802.11a / 5500 MHz

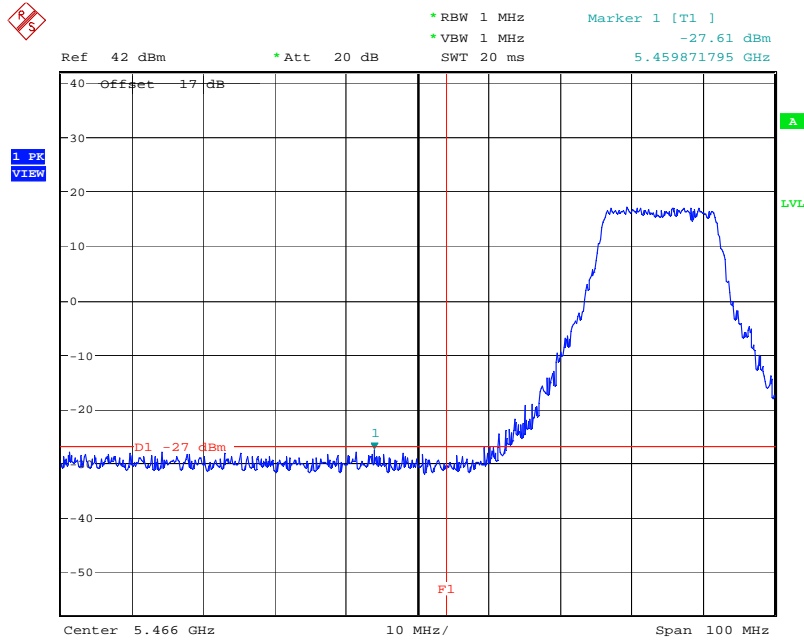

Date: 23.JAN.2007 16:19:17

EIRP Emission in Band on Configuration IEEE 802.11a / 5700 MHz

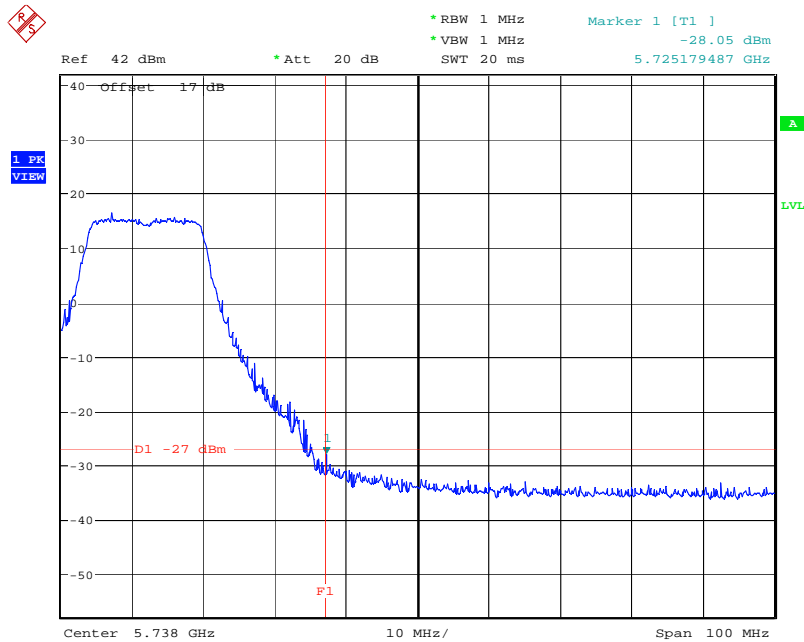

Date: 23.JAN.2007 16:20:07

4.8. Frequency Stability Measurement

4.8.1. Limit

Manufacturers of U-NII devices are responsible for ensuring frequency stability such that an emissions is maintained within the band of operation under all conditions of normal operation as specified in the user's manual or $\pm 20\text{ppm}$ (IEEE 802.11a specification).

4.8.2. Measuring Instruments and Setting

Please refer to section 5 of equipments list in this report. The following table is the setting of the spectrum analyzer.

Spectrum Parameter	Setting
Attenuation	Auto
Span Frequency	Entire absence of modulation emissions bandwidth
RB	10 kHz
VB	10 kHz
Sweep Time	Auto

4.8.3. Test Procedures

1. The transmitter output (antenna port) was connected to the spectrum analyser.
2. EUT have transmitted absence of modulation signal and fixed channelize.
3. Set the spectrum analyzer span to view the entire absence of modulation emissions bandwidth.
4. Set RBW = 10 kHz, VBW = 10 kHz with peak detector and maxhold settings.
5. f_c is declaring of channel frequency. Then the frequency error formula is $(f_c - f) / f_c \times 10^6$ ppm and the limit is less than $\pm 20\text{ppm}$ (IEEE 802.11a specification).
6. The test extreme voltage is to change the primary supply voltage from 85 to 115 percent of the nominal value
7. Extreme temperature rule is $-30^\circ\text{C} \sim 50^\circ\text{C}$.

4.8.4. Test Setup Layout

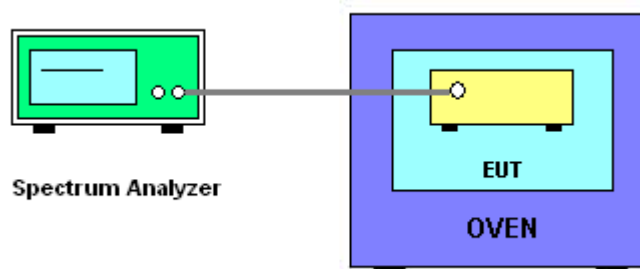

4.8.5. Test Deviation

There is no deviation with the original standard.

4.8.6. EUT Operation during Test

The EUT was programmed to be in continuously un-modulation transmitting mode.

4.8.7. Test Result of Frequency Stability

Voltage vs. Frequency Stability

Voltage	Measurement Frequency (MHz)
(V)	5300
126.50	5300.0081
110.00	5300.0085
93.50	5300.0063
Max. Deviation (MHz)	0.008500
Max. Deviation (ppm)	1.60

Temperature vs. Frequency Stability

Temperature	Measurement Frequency (MHz)
(°C)	5300
-30	5299.9700
-20	5300.0049
-10	5300.0149
0	5300.0165
10	5300.0137
20	5300.0081
30	5300.0099
40	5300.0060
50	5300.0003
Max. Deviation (MHz)	0.030000
Max. Deviation (ppm)	5.66

4.9. Antenna Requirements

4.9.1. Limit

Except for special regulations, the Low-power Radio-frequency Devices must not be equipped with any jacket for installing an antenna with extension cable. An intentional radiator shall be designed to ensure that no antenna other than that furnished by the responsible party shall be used with the device. The use of a permanently attached antenna or of an antenna that uses a unique coupling to the intentional radiator shall be considered sufficient to comply with the provisions of this Section. The manufacturer may design the unit so that the user can replace a broken antenna, but the use of a standard antenna jack or electrical connector is prohibited. Further, this requirement does not apply to intentional radiators that must be professionally installed.

4.9.2. Antenna Connector Construction

Please refer to section 3.3 in this test report; antenna connector complied with the requirements.

5. LIST OF MEASURING EQUIPMENTS

Instrument	Manufacturer	Model No.	Serial No.	Characteristics	Calibration Date	Remark
3m Semi Anechoic Chamber	SIDT FRANKONIA	SAC-3M	03CH03-HY	30 MHz - 1 GHz 3m	Jun. 14, 2007	Radiation (03CH03-HY)
Amplifier	SCHAFFNER	CPA9231A	1886	9 kHz - 2 GHz	Jan. 22, 2007	Radiation (03CH03-HY)
Amplifier	Agilent	8449B	3008A02120	1 GHz - 26.5 GHz	Jun.07, 2007	Radiation (03CH03-HY)
Amplifier	MITEQ	AMF-6F-260400	923364	26.5 GHz - 40 GHz	Jan. 22, 2007*	Radiation (03CH03-HY)
Spectrum Analyzer	R&S	FSP40	100004/040	9 kHz - 40 GHz	Aug. 31, 2007	Radiation (03CH03-HY)
Loop Antenna	R&S	HFH2-Z2	860004/001	9 kHz - 30 MHz	May 23, 2006*	Radiation (03CH03-HY)
Bilog Antenna	SCHAFFNER	CBL 6112D	22237	30 MHz - 1 GHz	Jul. 21, 2007	Radiation (03CH03-HY)
Horn Antenna	EMCO	3115	6741	1GHz ~ 18GHz	May 04, 2007	Radiation (03CH03-HY)
Horn Antenna	SCHWARZBECK	BBHA9170	BBHA9170154	15 GHz - 40 GHz	NCR	Radiation (03CH03-HY)
RF Cable-R03m	Jye Bao	RG142	CB021	30 MHz - 1 GHz	Dec. 02, 2006	Radiation (03CH03-HY)
RF Cable-HIGH	SUHNER	SUCOFLEX 106	03CH03-HY	1 GHz - 40 GHz	Dec. 02, 2006	Radiation (03CH03-HY)
Turn Table	HD	DS 420	420/650/00	0 - 360 degree	N/A	Radiation (03CH03-HY)
Antenna Mast	HD	MA 240	240/560/00	1 m - 4 m	N/A	Radiation (03CH03-HY)
EMC Receiver	R&S	ESCS 30	100359	9kHz - 2.75GHz	Mar. 01, 2007	Conduction (CO04-HY)
LISN	MessTec	NNB-2/16Z	99079	9kHz - 30MHz	Mar. 31, 2007	Conduction (CO04-HY)
LISN (Support Unit)	EMCO	3810/2NM	9703-1839	9kHz - 30MHz	Mar. 22, 2007	Conduction (CO04-HY)
RF Cable-CON	UTIFLEX	3102-26886-4	CB049	9kHz - 30MHz	Apr. 20, 2007	Conduction (CO04-HY)
ISN	SCHAFFNER	ISN T400	21653	9kHz - 30MHz	May 09, 2007	Conduction (CO04-HY)
EMI Filter	LINDGREN	LRE-2030	2651	< 450 Hz	N/A	Conduction (CO04-HY)
Isolation Transformer	Erika Fiedler OHG	D-65396 Walluf	58	45MHz-2.15GHz	N/A	Conduction (CO04-HY)
Spectrum Analyzer	R&S	FSP30	100023	9kHz ~ 30GHz	Dec. 17, 2006	Conducted (TH01-HY)
Power Meter	R&S	NRVS	100444	DC ~ 40GHz	Jun. 27, 2007	Conducted (TH01-HY)
Power Sensor	R&S	NRV-Z51	100458	DC ~ 30GHz	Jun. 27, 2007	Conducted (TH01-HY)
Power Sensor	R&S	NRV-Z32	100057	30MHz ~ 6GHz	Jun. 27, 2007	Conducted (TH01-HY)
AC Power Source	HPC	HPA-500W	HPA-9100024	AC 0 ~ 300V	May 04, 2007*	Conducted (TH01-HY)
DC Power Source	G.W.	GPC-6030D	C671845	DC 1V ~ 60V	Mar. 03, 2007	Conducted (TH01-HY)

Instrument	Manufacturer	Model No.	Serial No.	Characteristics	Calibration Date	Remark
Temp. and Humidity Chamber	KSON	THS-C3L	612	N/A	Oct. 02, 2006	Conducted (TH01-HY)
RF CABLE-1m	Jye Bao	RG142	CB034-1m	20MHz ~ 7GHz	Dec. 01, 2006	Conducted (TH01-HY)
RF CABLE-2m	Jye Bao	RG142	CB035-2m	20MHz ~ 1GHz	Dec. 01, 2006	Conducted (TH01-HY)
Vector Signal Generator	R&S	SMU200A	102098	100kHz ~ 6GHz	Nov. 14, 2006	Conducted (TH01-HY)
Signal Generator	R&S	SMR40	100116	10MHz ~ 40GHz	Mar. 07, 2007	Conducted (TH01-HY)

Note: Calibration Interval of instruments listed above is one year.

*Calibration Interval of instruments listed above is two year.

NCR means Non-Calibration required.

6. TEST LOCATION

SHIJR	ADD : 6Fl., No. 106, Sec. 1, Shintai 5th Rd., Shijr City, Taipei, Taiwan 221, R.O.C. TEL : 886-2-2696-2468 FAX : 886-2-2696-2255
HWA YA	ADD : No. 52, Hwa Ya 1st Rd., Kwei-Shan Hsiang, Tao Yuan Hsien, Taiwan, R.O.C. TEL : 886-3-327-3456 FAX : 886-3-318-0055
LINKOU	ADD : No. 30-2, Dingfu Tsuen, Linkou Shiang, Taipei, Taiwan 244, R.O.C TEL : 886-2-2601-1640 FAX : 886-2-2601-1695
DUNGHU	ADD : No. 3, Lane 238, Kangle St., Neihu Chiu, Taipei, Taiwan 114, R.O.C. TEL : 886-2-2631-4739 FAX : 886-2-2631-9740
JUNGHE	ADD : 7Fl., No. 758, Jungjeng Rd., Junghe City, Taipei, Taiwan 235, R.O.C. TEL : 886-2-8227-2020 FAX : 886-2-8227-2626
NEIHU	ADD : 4Fl., No. 339, Hsin Hu 2 nd Rd., Taipei 114, Taiwan, R.O.C. TEL : 886-2-2794-8886 FAX : 886-2-2794-9777
JHUBEI	ADD : No.8, Lane 724, Bo-ai St., Jhubei City, HsinChu County 302, Taiwan, R.O.C. TEL : 886-3-656-9065 FAX : 886-3-656-9085

7. TAF CERTIFICATE OF ACCREDITATION



Certificate No. : LI190-070110

財團法人全國認證基金會
Taiwan Accreditation Foundation

Certificate of Accreditation

This is to certify that

Sporton International Inc.

EMC & Wireless Communications Laboratory

No.52, Hwa Ya 1st Rd., Hwa Ya Technology Park, Kwei-Shan Hsiang, Tao Yuan Hsien,
Taiwan, R.O.C.

is accredited in respect of laboratory

Accreditation Criteria	: ISO/IEC 17025:2005
Accreditation Number	: 1190
Originally Accredited	: December 15, 2003
Effective Period	: January 10, 2007 to January 09, 2010
Accredited Scope	: Testing Field, see described in the Appendix
Specific Accreditation Program	: Accreditation Program for Designated Testing Laboratory for Commodities Inspection : Accreditation Program for Telecommunication Equipment Testing Laboratory



Jay-San Chen
President, Taiwan Accreditation Foundation
Date : January 10, 2007

P1, total 9 pages

The Appendix forms an integral part of this Certificate, which shall be invalid when used without the Appendix.