



RADIO TEST REPORT

FCC ID : HEDOAP101
Equipment : Outdoor Access Point
Brand Name : Edgecore
Model Name : OAP101XYYYYZ, OAP101eXYYYYZ
(Please refer to section 1.1.5 for detail information.)
Applicant : Accton Technology Corporation
No. 1, Creation Rd. III, Science-based Industrial Park
Hsin Chu 30077, Taiwan R.O.C.
Manufacturer : Accton Technology Corporation
No. 1, Creation Rd. III, Science-based Industrial Park
Hsin Chu 30077, Taiwan R.O.C.
Standard : 47 CFR FCC Part 15.247

The product was received on Jun. 26, 2023, and testing was started from Jul. 10, 2023 and completed on Sep. 06, 2023. We, Sporton International Inc. Hsinchu Laboratory, would like to declare that the tested sample has been evaluated in accordance with the procedures given in ANSI C63.10-2013 and shown compliance with the applicable technical standards.

The test results in this report apply exclusively to the tested model / sample. Without written approval of Sporton International Inc. Hsinchu Laboratory, the test report shall not be reproduced except in full.

Approved by: Sam Chen

Sporton International Inc. Hsinchu Laboratory

No.8, Ln. 724, Bo'ai St., Zhubei City, Hsinchu County 302010, Taiwan (R.O.C.)



Table of Contents

History of this test report.....3

Summary of Test Result.....4

1 General Description5

1.1 Information.....5

1.2 Applicable Standards10

1.3 Testing Location Information.....10

1.4 Measurement Uncertainty10

2 Test Configuration of EUT11

2.1 Test Channel Mode11

2.2 The Worst Case Measurement Configuration13

2.3 EUT Operation during Test14

2.4 Accessories14

2.5 Support Equipment.....15

2.6 Test Setup Diagram16

3 Transmitter Test Result19

3.1 AC Power-line Conducted Emissions19

3.2 DTS Bandwidth.....21

3.3 Maximum Conducted Output Power22

3.4 Power Spectral Density25

3.5 Emissions in Non-restricted Frequency Bands27

3.6 Emissions in Restricted Frequency Bands.....28

4 Test Equipment and Calibration Data32

Appendix A. Test Results of AC Power-line Conducted Emissions

Appendix B. Test Results of DTS Bandwidth

Appendix C. Test Results of Maximum Conducted Output Power

Appendix D. Test Results of Power Spectral Density

Appendix E. Test Results of Emissions in Non-restricted Frequency Bands

Appendix F. Test Results of Emissions in Restricted Frequency Bands

Appendix G. Test Photos

Photographs of EUT v01



Summary of Test Result

Report Clause	Ref Std. Clause	Test Items	Result (PASS/FAIL)	Remark
1.1.2	15.203	Antenna Requirement	PASS	-
3.1	15.207	AC Power-line Conducted Emissions	PASS	-
3.2	15.247(a)	DTS Bandwidth	PASS	-
3.3	15.247(b)	Maximum Conducted Output Power	PASS	-
3.4	15.247(e)	Power Spectral Density	PASS	-
3.5	15.247(d)	Emissions in Non-restricted Frequency Bands	PASS	-
3.6	15.247(d)	Emissions in Restricted Frequency Bands	PASS	-

Note: Reference to Sporton Project No.: 361450

Conformity Assessment Condition:
<p>1. The test results (PASS/FAIL) with all measurement uncertainty excluded are presented against the regulation limits or in accordance with the requirements stipulated by the applicant/manufacturer who shall bear all the risks of non-compliance that may potentially occur if measurement uncertainty is taken into account.</p> <p>2. The measurement uncertainty please refer to each test result in the chapter "Measurement Uncertainty".</p>
Disclaimer:
<p>1. The product specifications of the EUT presented in the test report that may affect the test assessments are declared by the manufacturer who shall take full responsibility for the authenticity.</p> <p>2. The test configuration, test mode and test software were written in this test report are declared by the manufacturer.</p>

Reviewed by: **Sam Chen**
Report Producer: **Vicky Huang**



1 General Description

1.1 Information

1.1.1 RF General Information

Frequency Range (MHz)	IEEE Std. 802.11	Ch. Frequency (MHz)	Channel Number
2400-2483.5	b, g, n (HT20), VHT20, ax (HEW20)	2412-2462	1-11 [11]
2400-2483.5	n (HT40), VHT40, ax (HEW40)	2422-2452	3-9 [7]

Band	Mode	BWch (MHz)	Nant
2.4-2.4835GHz	802.11b	20	2TX
2.4-2.4835GHz	802.11g	20	2TX
2.4-2.4835GHz	802.11n HT20	20	2TX
2.4-2.4835GHz	802.11n HT20-BF	20	2TX
2.4-2.4835GHz	VHT20	20	2TX
2.4-2.4835GHz	VHT20-BF	20	2TX
2.4-2.4835GHz	802.11ax HEW20	20	2TX
2.4-2.4835GHz	802.11ax HEW20-BF	20	2TX
2.4-2.4835GHz	802.11n HT40	40	2TX
2.4-2.4835GHz	802.11n HT40-BF	40	2TX
2.4-2.4835GHz	VHT40	40	2TX
2.4-2.4835GHz	VHT40-BF	40	2TX
2.4-2.4835GHz	802.11ax HEW40	40	2TX
2.4-2.4835GHz	802.11ax HEW40-BF	40	2TX

Note:

- ◆ 11b mode uses a combination of DSSS-DBPSK, DQPSK, CCK modulation.
- ◆ 11g, HT20 and HT40 use a combination of OFDM-BPSK, QPSK, 16QAM, 64QAM modulation.
- ◆ VHT20, VHT40 use a combination of OFDM-BPSK, QPSK, 16QAM, 64QAM, 256QAM, 1024QAM modulation.
- ◆ HEW20, HEW40 use a combination of OFDMA-BPSK, QPSK, 16QAM, 64QAM, 256QAM, 1024QAM modulation.
- ◆ BWch is the nominal channel bandwidth.



1.1.2 Antenna Information

For EUT 1:

Ant.	Port			Brand	Model Name	Antenna Type	Connector	Remark	Gain (dBi)
	Bluetooth	2.4GHz	5GHz						
1	1	-	-	Accton	KG458-160Y17U7X	PCB	I-PEX	Internal Ant.	Note1
2	-	1	-	Accton	KG458-150L17U7X	PCB	I-PEX	Internal Ant.	
3	-	2	-	Accton	KG458-250F17U7X	PCB	I-PEX	Internal Ant.	
4	-	-	1	Accton	KG459-200G17U7X	PCB	I-PEX	Internal Ant.	
5	-	-	2	Accton	KG459-405W17U7X	PCB	I-PEX	Internal Ant.	

Note1:

Ant.	Gain (dBi)		
	Bluetooth	2.4GHz	5GHz
1	5.91	-	-
2	-	5.67	-
3	-	5.99	-
4	-	-	6.91
5	-	-	6.29

Note 2: Directional gain information

Type	Maximum Output Power	Power Spectral Density
Non-BF	Directional gain = Max.gain + array gain. For power measurements on IEEE 802.11 devices Array Gain = 0 dB (i.e., no array gain) for N ANT ≤ 4	$DirectionalGain = 10 \cdot \log \left[\frac{\sum_{j=1}^{N_{ANT}} \left[\sum_{k=1}^{N_{ANT}} S_{j,k} \right]^2}{N_{ANT}} \right]$
BF	$DirectionalGain = 10 \cdot \log \left[\frac{\sum_{j=1}^{N_{ANT}} \left[\sum_{k=1}^{N_{ANT}} S_{j,k} \right]^2}{N_{ANT}} \right]$	$DirectionalGain = 10 \cdot \log \left[\frac{\sum_{j=1}^{N_{ANT}} \left[\sum_{k=1}^{N_{ANT}} S_{j,k} \right]^2}{N_{ANT}} \right]$

Ex.

Directional Gain (NSS1) formula :

$$DirectionalGain = 10 \cdot \log \left[\frac{\sum_{j=1}^{N_{ANT}} \left[\sum_{k=1}^{N_{ANT}} S_{j,k} \right]^2}{N_{ANT}} \right]$$

$NSS1(g1,1) = 10^{G1/20}$; $NSS1(g1,2) = 10^{G2/20}$;

$g_{j,k} = (Nss1(g1,1) + Nss1(g1,2))^2$

$DG = 10 \log[(Nss1(g1,1) + Nss1(g1,2))^2 / N_{ANT}] => 10 \log[(10^{G1/20} + 10^{G2/20})^2 / N_{ANT}]$

Where ;

2.4G G1= 5.67 dBi ; G2= 5.99 dBi ;DG= 8.84dBi

5G G1= 6.91 dBi ; G2= 6.29 dBi ;DG= 9.62dBi



For EUT 2:

Ant.	Port			Brand	Model Name	Antenna Type	Connector	Remark	Gain (dBi)
	Bluetooth	2.4GHz	5GHz						
1	1	-	-	Accton	KG458-160Y17U7X	PCB	I-PEX	Internal Ant.	Note3
2	-	1	-	Accton	KG458-150L17U7X	PCB	I-PEX	Internal Ant.	
3	-	2	-	Accton	KG458-250F17U7X	PCB	I-PEX	Internal Ant.	
4	-	-	1	Master Wave	98110UNXX001	Omni Dipole	I-PEX	External Ant.	
5	-	-	2	Master Wave	98110UNXX001	Omni Dipole	I-PEX	External Ant.	

Note3:

Ant.	Gain (dBi)			Cable Loss (dB)			Net Gain (dBi)		
	Bluetooth	2.4GHz	5GHz	Bluetooth	2.4GHz	5GHz	Bluetooth	2.4GHz	5GHz
1	5.91	-	-	-	-	-	-	-	-
2	-	5.67	-	-	-	-	-	-	-
3	-	5.99	-	-	-	-	-	-	-
4	-	-	6.54	-	-	1.1	-	-	5.44
5	-	-	6.54	-	-	2.13	-	-	4.41

Note4: Directional gain information

Type	Maximum Output Power	Power Spectral Density
Non-BF	Directional gain = Max.gain + array gain. For power measurements on IEEE 802.11 devices Array Gain = 0 dB (i.e., no array gain) for N ANT ≤ 4	$DirectionalGain = 10 \cdot \log \left[\frac{\sum_{j=1}^{N_{ANT}} \left(\sum_{k=1}^{N_{ANT}} \xi_{j,k} \right)^2}{N_{ANT}} \right]$
BF	$DirectionalGain = 10 \cdot \log \left[\frac{\sum_{j=1}^{N_{ANT}} \left(\sum_{k=1}^{N_{ANT}} \xi_{j,k} \right)^2}{N_{ANT}} \right]$	$DirectionalGain = 10 \cdot \log \left[\frac{\sum_{j=1}^{N_{ANT}} \left(\sum_{k=1}^{N_{ANT}} \xi_{j,k} \right)^2}{N_{ANT}} \right]$

Ex.

Directional Gain (NSS1) formula :

$$DirectionalGain = 10 \cdot \log \left[\frac{\sum_{j=1}^{N_{ANT}} \left(\sum_{k=1}^{N_{ANT}} \xi_{j,k} \right)^2}{N_{ANT}} \right]$$

$NSS1(g1,1) = 10^{G1/20}$; $NSS1(g1,2) = 10^{G2/20}$;

$g_{j,k} = (Nss1(g1,1) + Nss1(g1,2))^2$

$DG = 10 \log \left[\frac{(Nss1(g1,1) + Nss1(g1,2))^2}{N_{ANT}} \right] \Rightarrow 10 \log \left[\frac{(10^{G1/20} + 10^{G2/20})^2}{N_{ANT}} \right]$

Where ;

2.4G $G1 = 5.67$ dBi ; $G2 = 5.99$ dBi ; $DG = 8.84$ dBi

5G $G1 = 5.44$ dBi ; $G2 = 4.41$ dBi ; $DG = 7.95$ dBi



Note5: The above information was declared by manufacturer.

Note6: **For WLAN 2.4GHz function:**

For IEEE 802.11b/g/n/VHT/ax mode (2TX/2RX):

Port 1 and Port 2 can be use as transmitting/receiving antenna.

Port 1 and Port 2 could transmit/receive simultaneously.

For WLAN 5GHz function:

For IEEE 802.11a/n/ac/ax mode (2TX/2RX):

Port 1 and Port 2 can be use as transmitting/receiving antenna.

Port 1 and Port 2 could transmit/receive simultaneously

For Bluetooth function:

For Bluetooth mode (1TX/1RX):

Only Port 1 can be used as transmitting/receiving antenna.

1.1.3 Mode Test Duty Cycle

For EUT 1:

Mode	DC	DCF(dB)	T(s)	VBW(Hz) ≥ 1/T
802.11b	0.98	0.09	n/a (DC>=0.98)	n/a (DC>=0.98)
802.11g	0.99	0.04	n/a (DC>=0.98)	n/a (DC>=0.98)
802.11ax HEW20	0.997	0.01	n/a (DC>=0.98)	n/a (DC>=0.98)
802.11ax HEW40	0.997	0.01	n/a (DC>=0.98)	n/a (DC>=0.98)

Note:

- ◆ DC is Duty Cycle.
- ◆ DCF is Duty Cycle Factor.

1.1.4 EUT Operational Condition

EUT Power Type	From PoE or DC 48V			
Beamforming Function	<input checked="" type="checkbox"/>	With beamforming	<input type="checkbox"/>	Without beamforming
	The product has beamforming function for n/VHT/ax in 2.4GHz, n/ac/ax in 5GHz.			
Function	<input checked="" type="checkbox"/>	Point-to-multipoint	<input type="checkbox"/>	Point-to-point
Support RU	<input checked="" type="checkbox"/>	Full RU	<input type="checkbox"/>	Partial RU
Test Software Version	QRCT Version 4.0.00192.0			

Note: The above information was declared by manufacturer.



1.1.5 Table for Multiple Listing

The model names which are identical to each other in all aspects except for the following table:

EUT	Model Name	BT	2.4GHz	5GHz
1	OAP101XYYYYZ (Note 1)	V	V	V (Internal Antenna)
2	OAP101eXYYYYZ (Note 1)	V	V	V (External Antenna)

Note 1: The difference of "XYYYYZ" would be marketing strategy X can be symbol "(" or "blank" Y can be "A~Z, a~z, 1~9 or blank and -"Z can be symbol ")" or "blank"

Note 2: The above information was declared by manufacturer.

Note 3: From the above models, model: OAP101(EUT 1) and OAP101e(EUT 2) was selected as representative model for the test and its data was recorded in this report for Emissions in Restricted Frequency Bands below 1GHz test.

Note 4: From the above models, model: OAP101e(EUT 2) was selected as representative model for the test and its data was recorded in this report for AC power-line conducted emissions test.

Note 5: From the above models, model: OAP101(EUT 1) was selected as representative model for the test and its data was recorded in this report for other test items.



1.2 Applicable Standards

According to the specifications of the manufacturer, the EUT must comply with the requirements of the following standards:

- ♦ 47 CFR FCC Part 15.247
- ♦ ANSI C63.10-2013

The following reference test guidance is not within the scope of accreditation of TAF.

- ♦ FCC KDB 558074 D01 v05r02
- ♦ FCC KDB 662911 D01 v02r01
- ♦ FCC KDB 414788 D01 v01r01

1.3 Testing Location Information

Testing Location Information	
Test Lab. : Sporton International Inc. Hsinchu Laboratory	
Hsinchu (TAF: 3787)	ADD: No.8, Ln. 724, Bo'ai St., Zhubei City, Hsinchu County 302010, Taiwan (R.O.C.) TEL: 886-3-656-9065 FAX: 886-3-656-9085 Test site Designation No. TW3787 with FCC. Conformity Assessment Body Identifier (CABID) TW3787 with ISED.

Test Condition	Test Site No.	Test Engineer	Test Environment (°C / %)	Test Date
RF Conducted	TH03-CB	Kevin Huang	23.2-24.6 / 62-74	Jul. 21, 2023~ Aug. 23, 2023
Radiated (Below 1GHz)	03CH06-CB	Stim Sung	23.7-24.8 / 56-59	Aug. 25, 2023
Radiated (Above 1GHz)	03CH04-CB	Ederson Huang	23-24 / 56-59	Jul. 11, 2023~ Sep. 06, 2023
AC Conduction	CO01-CB	Allen Chung	22~23 / 50~51	Jul. 10, 2023

1.4 Measurement Uncertainty

ISO/IEC 17025 requires that an estimate of the measurement uncertainties associated with the emissions test results be included in the report. The measurement uncertainties given below are based on a 95% confidence level (based on a coverage factor (k=2))

Test Items	Uncertainty	Remark
Conducted Emission (150kHz ~ 30MHz)	3.4 dB	Confidence levels of 95%
Radiated Emission (9kHz ~ 30MHz)	3.7 dB	Confidence levels of 95%
Radiated Emission (30MHz ~ 1,000MHz)	5.1 dB	Confidence levels of 95%
Radiated Emission (1GHz ~ 18GHz)	4.1 dB	Confidence levels of 95%
Radiated Emission (18GHz ~ 40GHz)	4.2 dB	Confidence levels of 95%
Conducted Emission	3.1 dB	Confidence levels of 95%
Output Power Measurement	0.8 dB	Confidence levels of 95%
Power Density Measurement	3.1 dB	Confidence levels of 95%



2 Test Configuration of EUT

2.1 Test Channel Mode

For EUT 1:

Mode	Power Setting
802.11b_Nss1,(1Mbps)_2TX	-
2412MHz	24.5
2417MHz	24.5
2437MHz	27
2457MHz	24.5
2462MHz	24.5
802.11g_Nss1,(6Mbps)_2TX	-
2412MHz	21
2417MHz	23.5
2437MHz	27
2457MHz	23.5
2462MHz	20.5
802.11ax HEW20_Nss1,(MCS0)_2TX	-
2412MHz	20.5
2417MHz	23.5
2437MHz	26.5
2457MHz	24
2462MHz	18.5
802.11ax HEW40_Nss1,(MCS0)_2TX	-
2422MHz	19.5
2427MHz	21
2437MHz	22.5
2447MHz	19.5
2452MHz	18
802.11ax HEW20-BF_Nss1,(MCS0)_2TX	-
2412MHz	20.5
2417MHz	23.5
2437MHz	24.5
2457MHz	24
2462MHz	18.5
802.11ax HEW40-BF_Nss1,(MCS0)_2TX	-
2422MHz	19.5
2427MHz	21
2437MHz	22.5
2447MHz	19.5



Mode	Power Setting
2452MHz	18

Note1: Evaluated HEW20/HEW40 mode only, due to similar modulation. The power setting of HT20/HT40/VHT20/VHT40 mode are the same or lower than HEW20/HEW40.
Note2: The EUT supports beamforming and CDD modes, and the CDD mode is the worst case. Therefore, all test items are evaluated in the report. The beamforming mode only evaluates the output power.



2.2 The Worst Case Measurement Configuration

The Worst Case Mode for Following Conformance Tests	
Tests Item	AC power-line conducted emissions
Condition	AC power-line conducted measurement for line and neutral Test Voltage: 120Vac / 60Hz (Vout=48VDC)
Operating Mode	Normal Link
1	EUT 2 + Power from PoE
2	EUT 2 + Power from DC power supply (48V)
For operating mode 1 is the worst case and it was record in this test report.	

The Worst Case Mode for Following Conformance Tests	
Tests Item	DTS Bandwidth Maximum Conducted Output Power Power Spectral Density Emissions in Non-restricted Frequency Bands
Test Condition	Conducted measurement at transmit chains
Operating Mode	1 EUT 1

The Worst Case Mode for Following Conformance Tests	
Tests Item	Emissions in Restricted Frequency Bands
Test Condition	Radiated measurement If EUT consist of multiple antenna assembly (multiple antenna are used in EUT regardless of spatial multiplexing MIMO configuration), the radiated test should be performed with highest antenna gain of each antenna type.
Operating Mode < 1GHz	CTX
After evaluating, and the worst case was found at Y axis, so it was selected to perform test and its test result was written in the report.	
1	EUT 2 in Y axis + CTX-2.4GHz + Power from PoE
2	EUT 2 in Y axis + CTX-2.4GHz + Power from DC power supply (48V)
Mode 1 has been evaluated to be the worst case among Mode 1~2, thus measurement for Mode 3 ~ 4 will follow this same test mode.	
3	EUT 2 in Y axis + CTX-5GHz + Power from PoE
4	EUT 2 in Y axis + CTX-Bluetooth + Power from PoE
Mode 1 has been evaluated to be the worst case among Mode 1~4, thus measurement for Mode 5 will follow this same test mode.	
5	EUT 1 in Y axis + CTX-2.4GHz + Power from PoE
For operating mode 1 is the worst case and it was record in this test report.	



Operating Mode > 1GHz	CTX
After evaluating, and the worst case was found at Y axis, so it was selected to perform test and its test result was written in the report.	
1	EUT 1 in Y axis

The Worst Case Mode for Following Conformance Tests	
Tests Item	Simultaneous Transmission Analysis - Co-location RF Exposure Evaluation
Operating Mode	
1	EUT 1-WLAN 2.4GHz+WLAN 5GHz+Bluetooth
2	EUT 2-WLAN 2.4GHz+WLAN 5GHz+Bluetooth
Refer to Sporton Test Report No.: FA361450-02 for Co-location RF Exposure Evaluation.	

Note: The PoEs are for measurement only, would not be marketed.

PoEs information as below:

Power	Brand	Model
PoE 1	CISCO	MA-INJ-4
PoE 2	GOSpower	G0720-480-050

2.3 EUT Operation during Test

For CTX Mode:

The EUT was programmed to be in continuously transmitting mode.

For Normal Link Mode:

During the test, the EUT operation to normal function.

2.4 Accessories

Accessories
DC Jack*1
Sealing Collar*3



2.5 Support Equipment

For AC Conduction:

Support Equipment				
No.	Equipment	Brand Name	Model Name	FCC ID
A	PoE 1	CISCO	MA-INJ-4	N/A
B	PoE NB	DELL	E6430	N/A
C	LAN NB	DELL	E6430	N/A
D	2.4G NB	DELL	E6430	N/A
E	5G NB	DELL	E6430	N/A
F	Smart Phone	Samsung	Galaxy J7	N/A

For Radiated (below 1GHz):

Support Equipment				
No.	Equipment	Brand Name	Model Name	FCC ID
A	NB	DELL	E4300	N/A
B	PoE 2	GOSpower	G0720-480-050	N/A

For Radiated (above 1GHz) and RF Conducted:

Support Equipment				
No.	Equipment	Brand Name	Model Name	FCC ID
A	NB	DELL	E4300	N/A
B	PoE 1	CISCO	MA-INJ-4	N/A

2.6 Test Setup Diagram

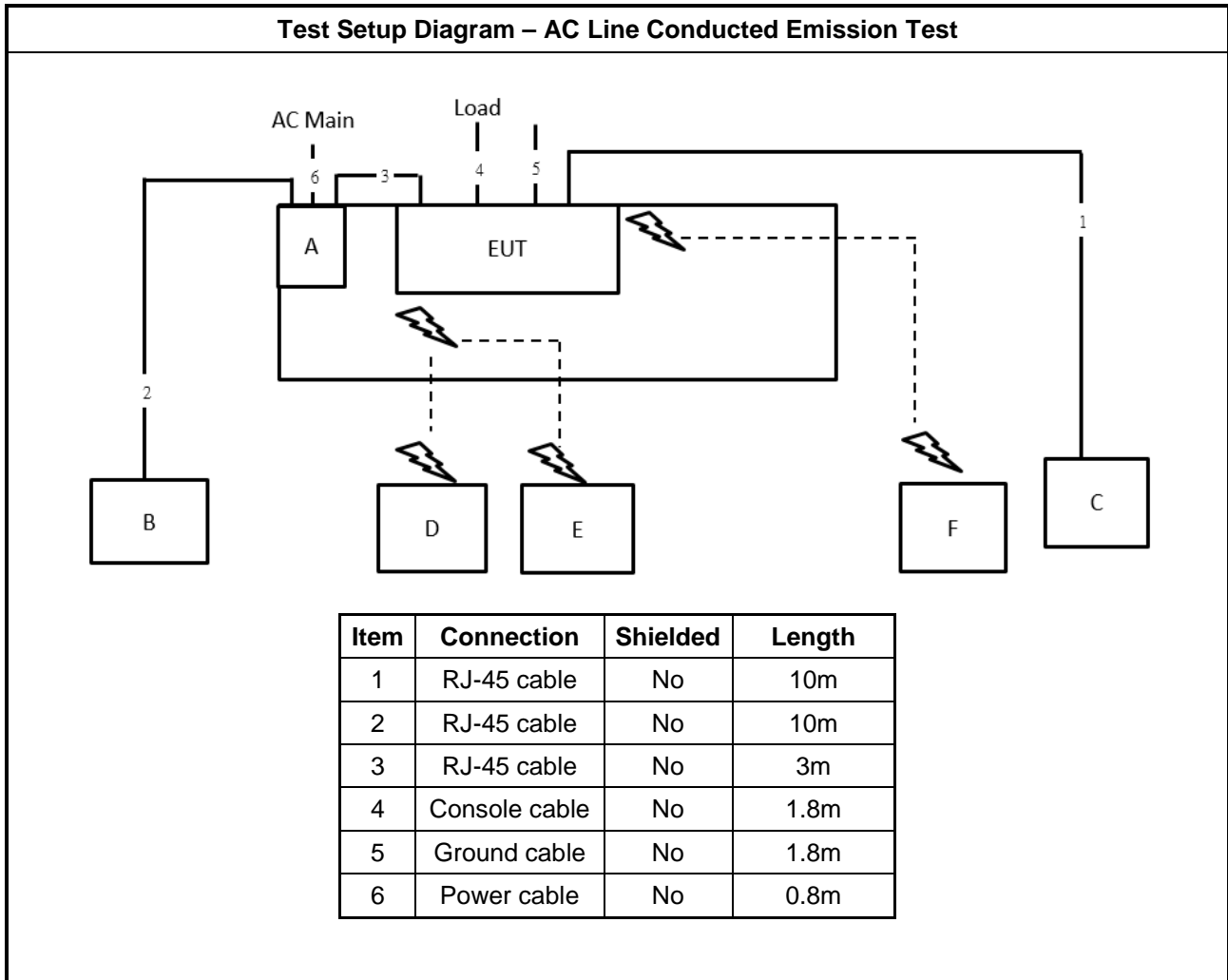

Test Setup Diagram - Radiated Test < 1GHz

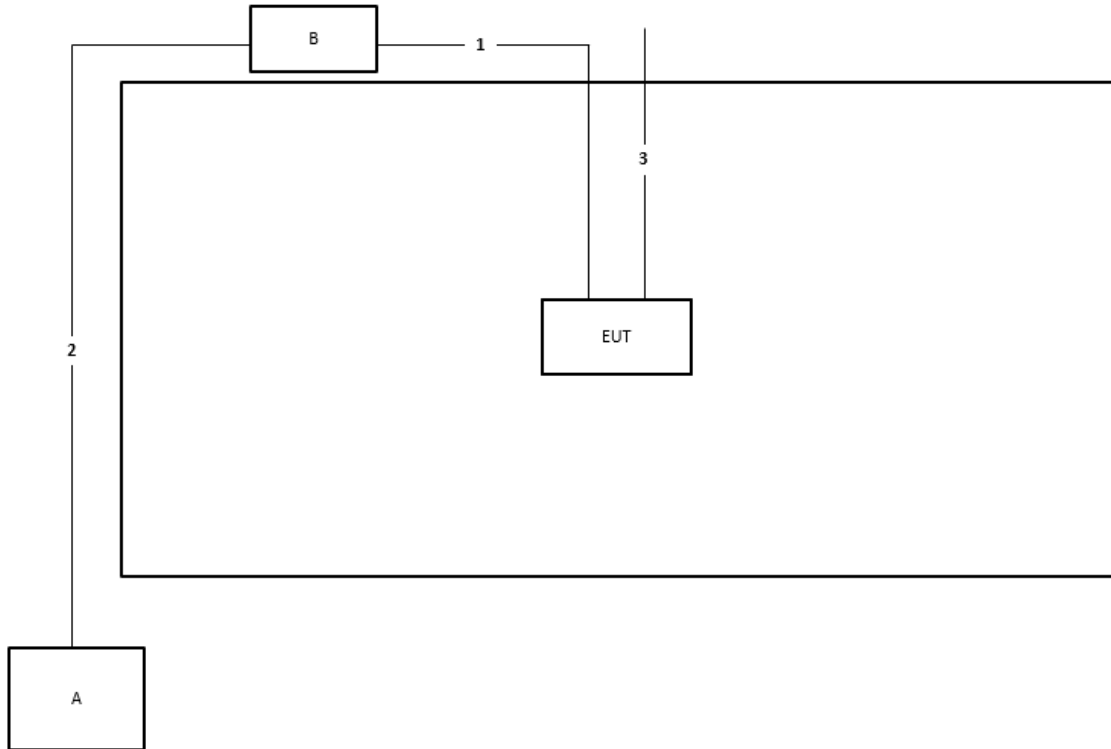

Item	Connection	Shielded	Length
1	RJ-45 cable	No	10m
2	RJ-45 cable	No	1.5m
3	Ground cable	No	1.8m

Test Setup Diagram - Radiated Test > 1GHz

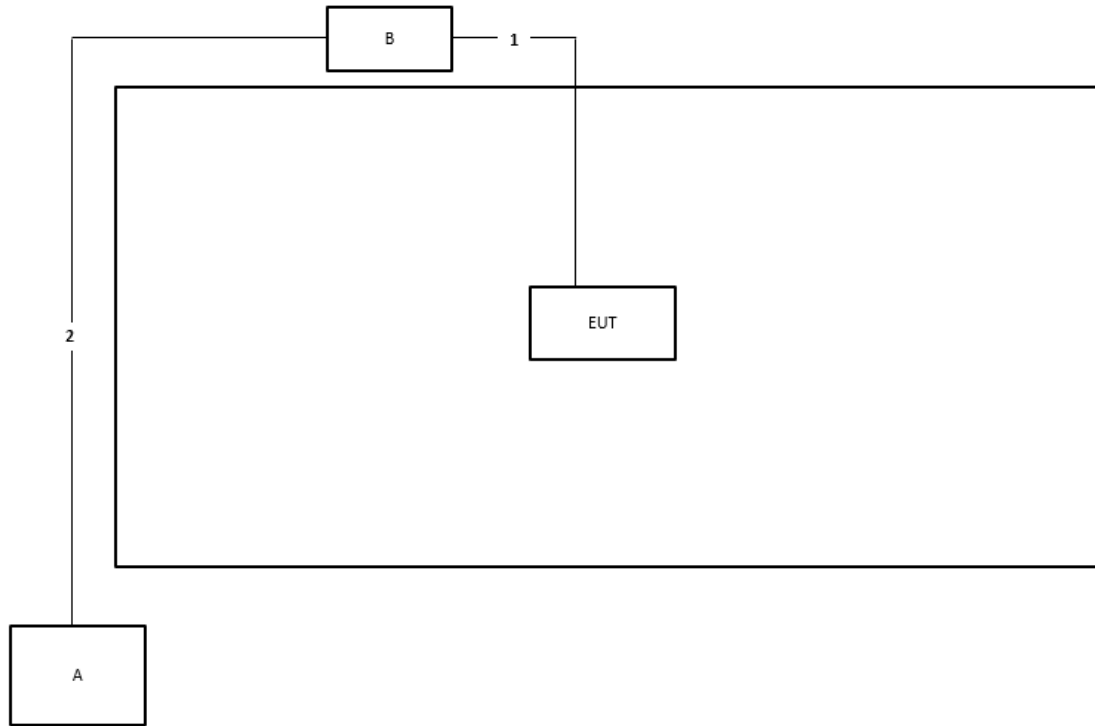

Item	Connection	Shielded	Length
1	RJ-45 cable	No	1.5m
2	RJ-45 cable	No	10m



3 Transmitter Test Result

3.1 AC Power-line Conducted Emissions

3.1.1 AC Power-line Conducted Emissions Limit

AC Power-line Conducted Emissions Limit		
Frequency Emission (MHz)	Quasi-Peak	Average
0.15-0.5	66 - 56 *	56 - 46 *
0.5-5	56	46
5-30	60	50

Note 1: * Decreases with the logarithm of the frequency.

3.1.2 Measuring Instruments

Refer a test equipment and calibration data table in this test report.

3.1.3 Test Procedures

Test Method
<input checked="" type="checkbox"/> Refer as ANSI C63.10-2013, clause 6.2 for AC power-line conducted emissions.

3.1.4 Test Setup

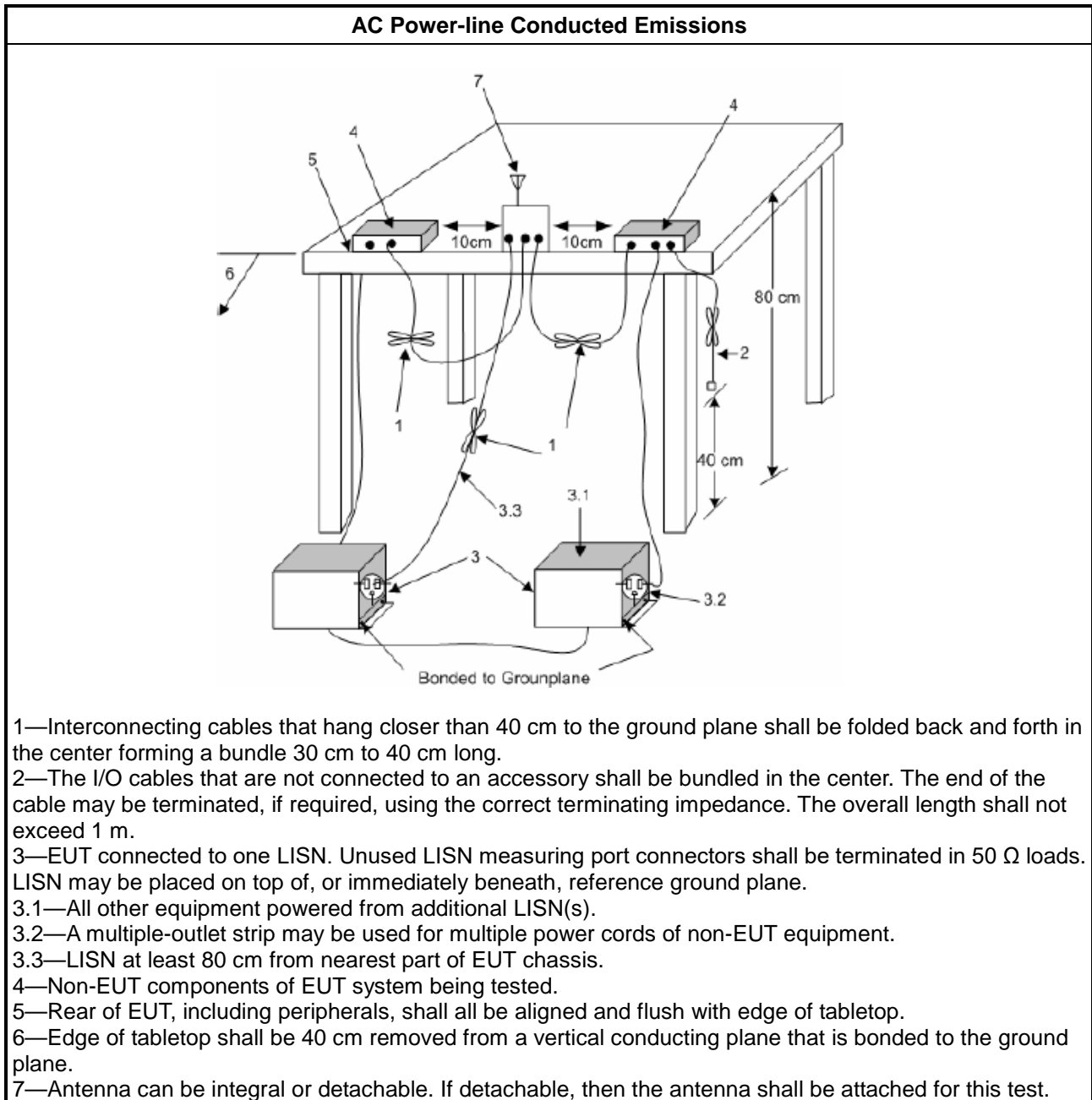

3.1.5 Measurement Results Calculation

The measured Level is calculated using:

- a. Corrected Reading: LISN Factor (LISN) + Attenuator (AT/AUX) + Cable Loss (CL) + Read Level (Raw) = Level
- b. Margin = -Limit + Level

3.1.6 Test Result of AC Power-line Conducted Emissions

Refer as Appendix A

3.2 DTS Bandwidth

3.2.1 6dB Bandwidth Limit

6dB Bandwidth Limit
Systems using digital modulation techniques:
<ul style="list-style-type: none"> ▪ 6 dB bandwidth \geq 500 kHz.

3.2.2 Measuring Instruments

Refer a test equipment and calibration data table in this test report.

3.2.3 Test Procedures

Test Method
<ul style="list-style-type: none"> ▪ For the emission bandwidth shall be measured using one of the options below:
<input checked="" type="checkbox"/> Refer as FCC KDB 558074, clause 8.2 & C63.10 clause 11.8.1 Option 1 for 6 dB bandwidth measurement.
<input type="checkbox"/> Refer as FCC KDB 558074, clause 8.2 & C63.10 clause 11.8.2 Option 2 for 6 dB bandwidth measurement.
<input type="checkbox"/> Refer as ANSI C63.10, clause 6.9.1 for occupied bandwidth testing.

3.2.4 Test Setup

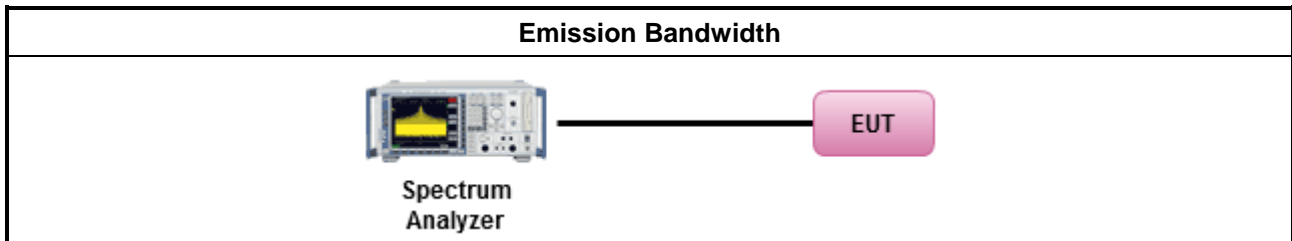

3.2.5 Test Result of Emission Bandwidth

Refer as Appendix B



3.3 Maximum Conducted Output Power

3.3.1 Maximum Conducted Output Power Limit

Maximum Conducted Output Power Limit	
	<ul style="list-style-type: none">▪ If $G_{TX} \leq 6$ dBi, then $P_{Out} \leq 30$ dBm (1 W)
	<ul style="list-style-type: none">▪ Point-to-multipoint systems (P2M): If $G_{TX} > 6$ dBi, then $P_{Out} = 30 - (G_{TX} - 6)$ dBm
	<ul style="list-style-type: none">▪ Point-to-point systems (P2P): If $G_{TX} > 6$ dBi, then $P_{Out} = 30 - (G_{TX} - 6)/3$ dBm
	<ul style="list-style-type: none">▪ Smart antenna system (SAS):
	<ul style="list-style-type: none">- Single beam: If $G_{TX} > 6$ dBi, then $P_{Out} = 30 - (G_{TX} - 6)/3$ dBm
	<ul style="list-style-type: none">- Overlap beam: If $G_{TX} > 6$ dBi, then $P_{Out} = 30 - (G_{TX} - 6)/3$ dBm
	<ul style="list-style-type: none">- Aggregate power on all beams: If $G_{TX} > 6$ dBi, then $P_{Out} = 30 - (G_{TX} - 6)/3 + 8$ dB dBm
P_{Out} = maximum peak conducted output power or maximum conducted output power in dBm, G_{TX} = the maximum transmitting antenna directional gain in dBi.	

3.3.2 Measuring Instruments

Refer a test equipment and calibration data table in this test report.

3.3.3 Test Procedures

Test Method	
<ul style="list-style-type: none"> ▪ Maximum Peak Conducted Output Power 	
	<input type="checkbox"/> Refer as FCC KDB 558074, clause 8.3.1.1 & C63.10 clause 11.9.1.1 (RBW ≥ EBW method).
	<input type="checkbox"/> Refer as FCC KDB 558074, clause 8.3.1.3 & C63.10 clause 11.9.1.3 (peak power meter).
<ul style="list-style-type: none"> ▪ Maximum Conducted Output Power 	
[duty cycle ≥ 98% or external video / power trigger]	
	<input type="checkbox"/> Refer as FCC KDB 558074, clause 8.3.2.2 & C63.10 clause 11.9.2.2.2 Method AVGSA-1.
	<input type="checkbox"/> Refer as FCC KDB 558074, clause 8.3.2.2 & C63.10 clause 11.9.2.2.3 Method AVGSA-1A. (alternative)
duty cycle < 98% and average over on/off periods with duty factor	
	<input type="checkbox"/> Refer as FCC KDB 558074, clause 8.3.2.2 & C63.10 clause 11.9.2.2.4 Method AVGSA-2.
	<input type="checkbox"/> Refer as FCC KDB 558074, clause 8.3.2.2 & C63.10 clause 11.9.2.2.5 Method AVGSA-2A (alternative)
	<input type="checkbox"/> Refer as FCC KDB 558074, clause 8.3.2.2 & C63.10 clause 11.9.2.2.6 Method AVGSA-3
	<input type="checkbox"/> Refer as FCC KDB 558074, clause 8.3.2.2 & C63.10 clause 11.9.2.2.7 Method AVGSA-3A (alternative)
Measurement using a power meter (PM)	
	<input type="checkbox"/> Refer as FCC KDB 558074, clause 8.3.2.3 & C63.10 clause 11.9.2.3.1 Method AVGPM (using an RF average power meter).
	<input checked="" type="checkbox"/> Refer as FCC KDB 558074, clause 8.3.2.3 & C63.10 clause 11.9.2.3.2 Method AVGPM-G (using an gate RF average power meter).
<ul style="list-style-type: none"> ▪ For conducted measurement. 	
	<ul style="list-style-type: none"> ▪ If the EUT supports multiple transmit chains using options given below: Refer as FCC KDB 662911, In-band power measurements. Using the measure-and-sum approach, measured all transmit ports individually. Sum the power (in linear power units e.g., mW) of all ports for each individual sample and save them.
	<ul style="list-style-type: none"> ▪ If multiple transmit chains, EIRP calculation could be following as methods: $P_{total} = P_1 + P_2 + \dots + P_n$ (calculated in linear unit [mW] and transfer to log unit [dBm]) $EIRP_{total} = P_{total} + DG$

3.3.4 Test Setup

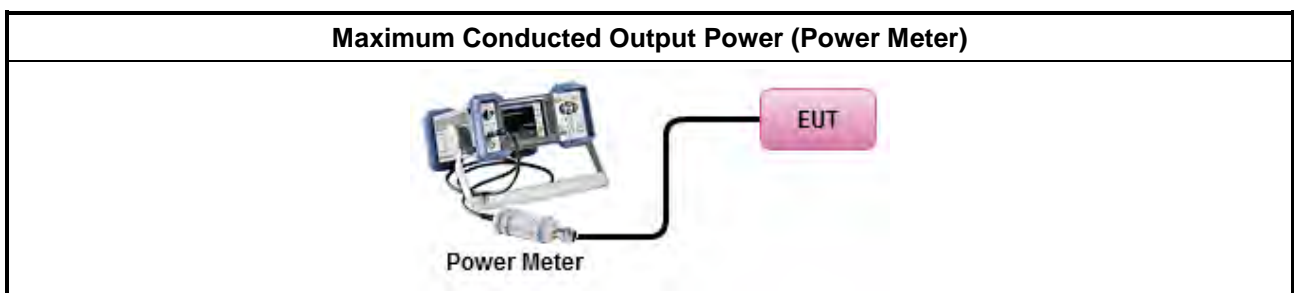



3.3.5 Test Result of Maximum Conducted Output Power

Refer as Appendix C



3.4 Power Spectral Density

3.4.1 Power Spectral Density Limit

Power Spectral Density Limit
<ul style="list-style-type: none"> ▪ Power Spectral Density (PSD) \leq 8 dBm/3kHz

3.4.2 Measuring Instruments

Refer a test equipment and calibration data table in this test report.

3.4.3 Test Procedures

Test Method						
<ul style="list-style-type: none"> ▪ Peak power spectral density procedures that the same method as used to determine the conducted output power. If maximum peak conducted output power was measured to demonstrate compliance to the output power limit, then the peak PSD procedure below (Method PKPSD) shall be used. If maximum conducted output power was measured to demonstrate compliance to the output power limit, then one of the average PSD procedures shall be used, as applicable based on the following criteria (the peak PSD procedure is also an acceptable option). 						
<input checked="" type="checkbox"/> Refer as FCC KDB 558074, clause 8.4 & C63.10 clause 11.10 Method Max. PSD.						
<ul style="list-style-type: none"> ▪ For conducted measurement. <ul style="list-style-type: none"> ▪ If The EUT supports multiple transmit chains using options given below: <table border="1" style="width: 100%; border-collapse: collapse;"> <tbody> <tr> <td style="width: 20px; text-align: center;"><input checked="" type="checkbox"/></td> <td>Option 1: Measure and sum the spectra across the outputs. Refer as FCC KDB 662911, In-band power spectral density (PSD). Sample all transmit ports simultaneously using a spectrum analyzer for each transmit port. Where the trace bin-by-bin of each transmit port summing can be performed. (i.e., in the first spectral bin of output 1 is summed with that in the first spectral bin of output 2 and that from the first spectral bin of output 3, and so on up to the NTX output to obtain the value for the first frequency bin of the summed spectrum.). Add up the amplitude (power) values for the different transmit chains and use this as the new data trace.</td> </tr> <tr> <td style="text-align: center;"><input type="checkbox"/></td> <td>Option 2: Measure and sum spectral maxima across the outputs. With this technique, spectra are measured at each output of the device at the required resolution bandwidth. The maximum value (peak) of each spectrum is determined. These maximum values are then summed mathematically in linear power units across the outputs. These operations shall be performed separately over frequency spans that have different out-of-band or spurious emission limits,</td> </tr> <tr> <td style="text-align: center;"><input type="checkbox"/></td> <td>Option 3: Measure and add 10 log(N) dB, where N is the number of transmit chains. Refer as FCC KDB 662911, In-band power spectral density (PSD). Performed at each transmit chains and each transmit chains shall be compared with the limit have been reduced with 10 log(N). Or each transmit chains shall be add 10 log(N) to compared with the limit.</td> </tr> </tbody> </table> 	<input checked="" type="checkbox"/>	Option 1: Measure and sum the spectra across the outputs. Refer as FCC KDB 662911, In-band power spectral density (PSD). Sample all transmit ports simultaneously using a spectrum analyzer for each transmit port. Where the trace bin-by-bin of each transmit port summing can be performed. (i.e., in the first spectral bin of output 1 is summed with that in the first spectral bin of output 2 and that from the first spectral bin of output 3, and so on up to the NTX output to obtain the value for the first frequency bin of the summed spectrum.). Add up the amplitude (power) values for the different transmit chains and use this as the new data trace.	<input type="checkbox"/>	Option 2: Measure and sum spectral maxima across the outputs. With this technique, spectra are measured at each output of the device at the required resolution bandwidth. The maximum value (peak) of each spectrum is determined. These maximum values are then summed mathematically in linear power units across the outputs. These operations shall be performed separately over frequency spans that have different out-of-band or spurious emission limits,	<input type="checkbox"/>	Option 3: Measure and add 10 log(N) dB, where N is the number of transmit chains. Refer as FCC KDB 662911, In-band power spectral density (PSD). Performed at each transmit chains and each transmit chains shall be compared with the limit have been reduced with 10 log(N). Or each transmit chains shall be add 10 log(N) to compared with the limit.
<input checked="" type="checkbox"/>	Option 1: Measure and sum the spectra across the outputs. Refer as FCC KDB 662911, In-band power spectral density (PSD). Sample all transmit ports simultaneously using a spectrum analyzer for each transmit port. Where the trace bin-by-bin of each transmit port summing can be performed. (i.e., in the first spectral bin of output 1 is summed with that in the first spectral bin of output 2 and that from the first spectral bin of output 3, and so on up to the NTX output to obtain the value for the first frequency bin of the summed spectrum.). Add up the amplitude (power) values for the different transmit chains and use this as the new data trace.					
<input type="checkbox"/>	Option 2: Measure and sum spectral maxima across the outputs. With this technique, spectra are measured at each output of the device at the required resolution bandwidth. The maximum value (peak) of each spectrum is determined. These maximum values are then summed mathematically in linear power units across the outputs. These operations shall be performed separately over frequency spans that have different out-of-band or spurious emission limits,					
<input type="checkbox"/>	Option 3: Measure and add 10 log(N) dB, where N is the number of transmit chains. Refer as FCC KDB 662911, In-band power spectral density (PSD). Performed at each transmit chains and each transmit chains shall be compared with the limit have been reduced with 10 log(N). Or each transmit chains shall be add 10 log(N) to compared with the limit.					

3.4.4 Test Setup

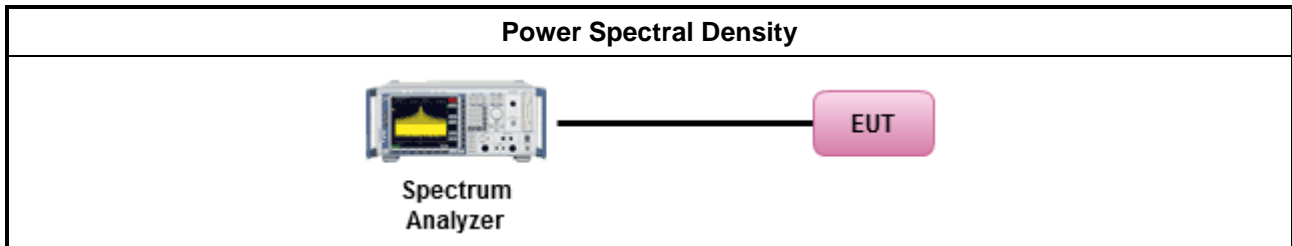

3.4.5 Test Result of Power Spectral Density

Refer as Appendix D

3.5 Emissions in Non-restricted Frequency Bands

3.5.1 Emissions in Non-restricted Frequency Bands Limit

Un-restricted Band Emissions Limit	
RF output power procedure	Limit (dBc)
Peak output power procedure	20
Average output power procedure	30

Note 1: If the peak output power procedure is used to measure the fundamental emission power to demonstrate compliance to requirements, then the peak conducted output power measured within any 100 kHz outside the authorized frequency band shall be attenuated by at least 20 dB relative to the maximum measured in-band peak PSD level.

Note 2: If the average output power procedure is used to measure the fundamental emission power to demonstrate compliance to requirements, then the power in any 100 kHz outside of the authorized frequency band shall be attenuated by at least 30 dB relative to the maximum measured in-band average PSD level.

3.5.2 Measuring Instruments

Refer a test equipment and calibration data table in this test report.

3.5.3 Test Procedures

Test Method
<ul style="list-style-type: none"> Refer as FCC KDB 558074, clause 8.5 for unwanted emissions into non-restricted bands.

3.5.4 Test Setup

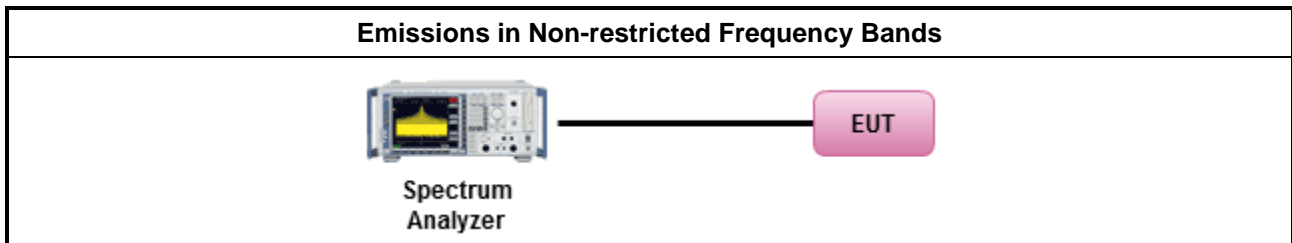

3.5.5 Test Result of Emissions in Non-restricted Frequency Bands

Refer as Appendix E



3.6 Emissions in Restricted Frequency Bands

3.6.1 Emissions in Restricted Frequency Bands Limit

Restricted Band Emissions Limit			
Frequency Range (MHz)	Field Strength (uV/m)	Field Strength (dBuV/m)	Measure Distance (m)
0.009~0.490	2400/F(kHz)	48.5 - 13.8	300
0.490~1.705	24000/F(kHz)	33.8 - 23	30
1.705~30.0	30	29	30
30~88	100	40	3
88~216	150	43.5	3
216~960	200	46	3
Above 960	500	54	3

Note 1: Test distance for frequencies at or above 30 MHz, measurements may be performed at a distance other than the limit distance provided they are not performed in the near field and the emissions to be measured can be detected by the measurement equipment. When performing measurements at a distance other than that specified, the results shall be extrapolated to the specified distance using an extrapolation factor of 20 dB/decade (inverse of linear distance for field-strength measurements, inverse of linear distance-squared for power-density measurements).

Note 2: Test distance for frequencies at below 30 MHz, measurements may be performed at a distance closer than the EUT limit distance; however, an attempt should be made to avoid making measurements in the near field. When performing measurements below 30 MHz at a closer distance than the limit distance, the results shall be extrapolated to the specified distance by either making measurements at a minimum of two or more distances on at least one radial to determine the proper extrapolation factor or by using the square of an inverse linear distance extrapolation factor (40 dB/decade). The test report shall specify the extrapolation method used to determine compliance of the EUT.

Note 3: Using the distance of 1m during the test for above 18 GHz, and the test value to correct for the distance factor at 3m.

3.6.2 Measuring Instruments

Refer a test equipment and calibration data table in this test report.



3.6.3 Test Procedures

Test Method	
<ul style="list-style-type: none"> ▪ The average emission levels shall be measured in [duty cycle \geq 98 or duty factor]. 	
<ul style="list-style-type: none"> ▪ Refer as ANSI C63.10, clause 6.10.3 band-edge testing shall be performed at the lowest frequency channel and highest frequency channel within the allowed operating band. 	
<ul style="list-style-type: none"> ▪ For the transmitter unwanted emissions shall be measured using following options below: 	
	<ul style="list-style-type: none"> ▪ Refer as FCC KDB 558074, clause 8.6 for unwanted emissions into restricted bands.
	<input type="checkbox"/> Refer as FCC KDB 558074, clause 8.6 & C63.10 clause 11.12.2.5.1(trace averaging for duty cycle \geq 98%).
	<input type="checkbox"/> Refer as FCC KDB 558074, clause 8.6 & C63.10 clause 11.12.2.5.2(trace averaging + duty factor).
	<input checked="" type="checkbox"/> Refer as FCC KDB 558074, clause 8.6 & C63.10 clause 11.12.2.5.3(Reduced VBW \geq 1/T).
	<input type="checkbox"/> Refer as ANSI C63.10, clause 11.12.2.5.3 (Reduced VBW). VBW \geq 1/T, where T is pulse time.
	<input type="checkbox"/> Refer as ANSI C63.10, clause 7.5 average value of pulsed emissions.
	<input checked="" type="checkbox"/> Refer as FCC KDB 558074, clause 8.6 & C63.10 clause 11.12.2.4 measurement procedure peak limit.
<ul style="list-style-type: none"> ▪ For the transmitter band-edge emissions shall be measured using following options below: 	
	<ul style="list-style-type: none"> ▪ Refer as FCC KDB 558074 clause 8.7 & C63.10 clause 11.13.1, When the performing peak or average radiated measurements, emissions within 2 MHz of the authorized band edge may be measured using the marker-delta method described below.
	<ul style="list-style-type: none"> ▪ Refer as FCC KDB 558074, clause 8.7 (ANSI C63.10, clause 6.10.6) for marker-delta method for band-edge measurements.
	<ul style="list-style-type: none"> ▪ Refer as FCC KDB 558074, clause 8.7 for narrower resolution bandwidth (100kHz) using the band power and summing the spectral levels (i.e., 1 MHz).
	<ul style="list-style-type: none"> ▪ For conducted unwanted emissions into restricted bands (absolute emission limits). Devices with multiple transmit chains using options given below: (1) Measure and sum the spectra across the outputs or (2) Measure and add 10 log(N) dB
	<ul style="list-style-type: none"> ▪ For FCC KDB 662911 The methodology described here may overestimate array gain, thereby resulting in apparent failures to satisfy the out-of-band limits even if the device is actually compliant. In such cases, compliance may be demonstrated by performing radiated tests around the frequencies at which the apparent failures occurred.

3.6.4 Test Setup

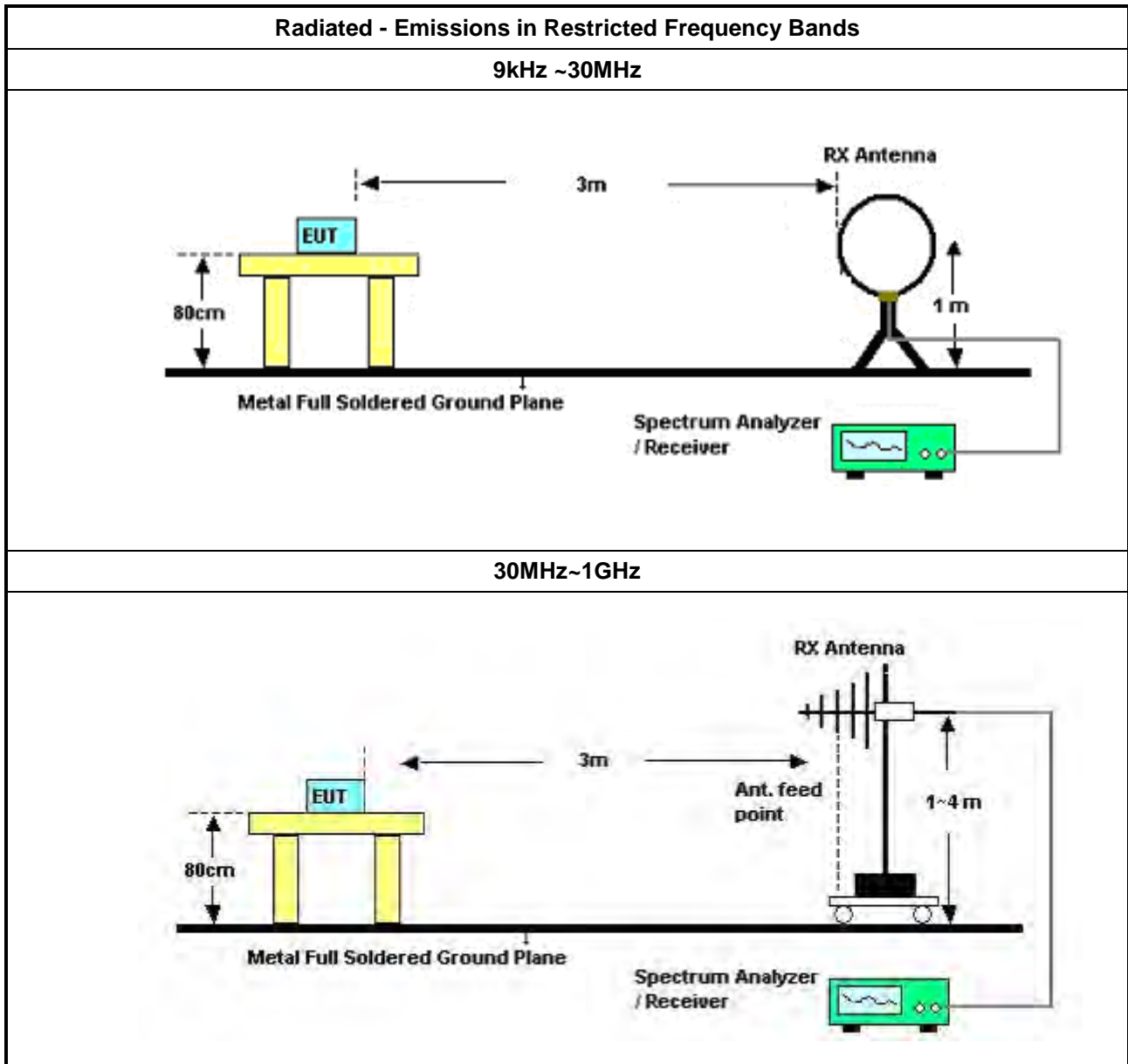

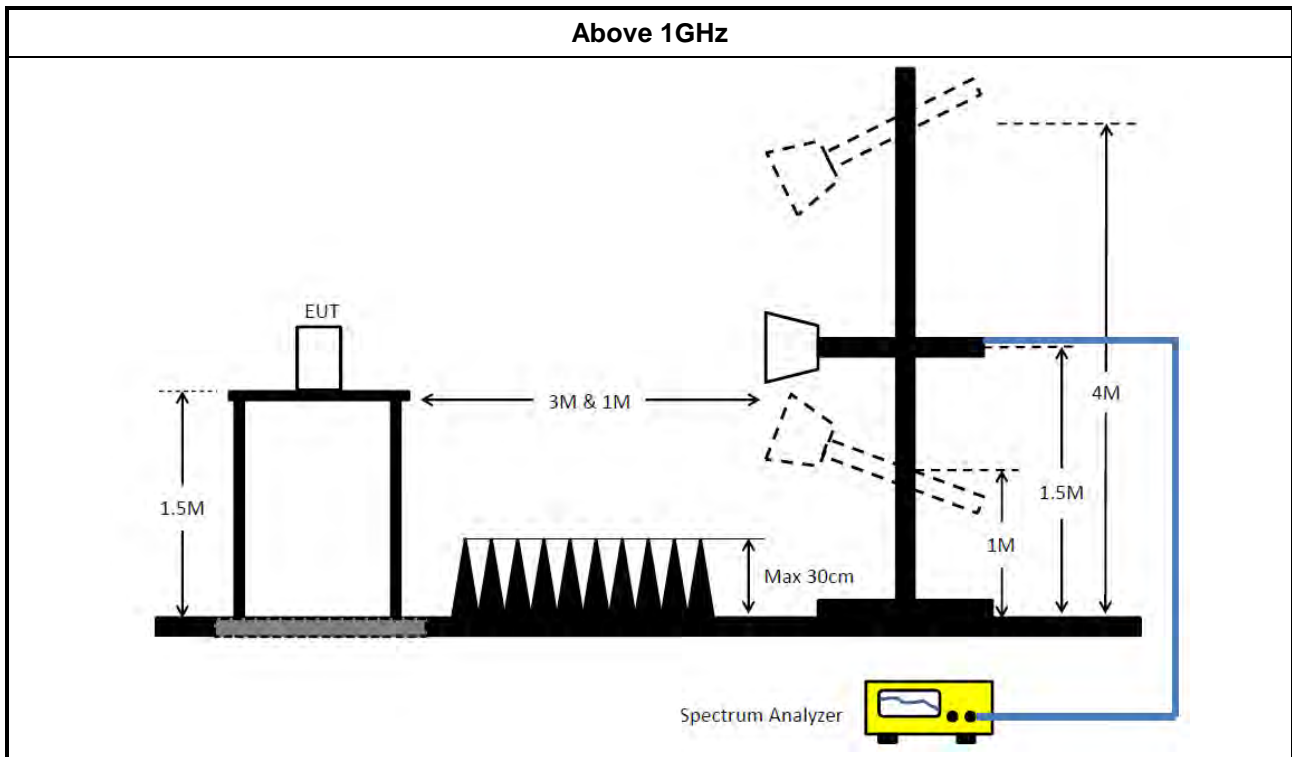

3.6.5 Measurement Results Calculation

The measured Level is calculated using:

Corrected Reading: Antenna factor (AF) + Cable loss (CL) + Read level (Raw) - Preamp factor (PA)(if applicable) = Level.

3.6.6 Emissions in Restricted Frequency Bands (Below 30MHz)

There is a comparison data of both open-field test site and alternative test site - semi-Anechoic chamber according to KDB414788 Radiated Test Site, and the result came out very similar.

All amplitude of spurious emissions that are attenuated by more than 20 dB below the permissible value has no need to be reported.

The radiated emissions were investigated from 9 kHz or the lowest frequency generated within the device, up to the 10th harmonic or 40 GHz, whichever is appropriate.

3.6.7 Test Result of Emissions in Restricted Frequency Bands

Refer as Appendix F



4 Test Equipment and Calibration Data

Instrument	Brand	Model No.	Serial No.	Characteristics	Calibration Date	Calibration Due Date	Remark
EMI Receiver	Agilent	N9038A	My52260123	9kHz ~ 8.4GHz	Feb. 20, 2023	Feb. 19, 2024	Conduction (CO01-CB)
LISN	F.C.C.	FCC-LISN-50-16-2	04083	150kHz ~ 100MHz	Feb. 16, 2023	Feb. 15, 2024	Conduction (CO01-CB)
LISN	Schwarzbeck	NSLK 8127	8127647	9kHz ~ 30MHz	Apr. 27, 2023	Apr. 26, 2024	Conduction (CO01-CB)
Pulse Limiter	Rohde & Schwarz	ESH3-Z2	100430	9kHz ~ 30MHz	Feb. 09, 2023	Feb. 08, 2024	Conduction (CO01-CB)
COND Cable	Woken	Cable	Low cable-CO01	9kHz ~ 30MHz	Oct. 18, 2022	Oct. 17, 2023	Conduction (CO01-CB)
Software	SPORTON	SENSE	V5.10	-	N.C.R.	N.C.R.	Conduction (CO01-CB)
Loop Antenna	Teseq	HLA 6120	31244	9kHz - 30 MHz	Mar. 23, 2023	Mar. 22, 2024	Radiation (03CH06-CB)
3m Semi Anechoic Chamber NSA	TDK	SAC-3M	03CH06-CB	30 MHz ~ 1 GHz	Aug. 03, 2023	Aug. 02, 2024	Radiation (03CH06-CB)
Bilog Antenna with 6 dB attenuator	TESEQ & EMCI	CBL6112D & N-6-06	37878 & AT-N0606	20MHz ~ 2GHz	Jul. 30, 2023	Jul. 29, 2024	Radiation (03CH06-CB)
Pre-Amplifier	Agilent	310N	187290	0.1MHz ~ 1GHz	Nov. 04, 2022	Nov. 03, 2023	Radiation (03CH06-CB)
Spectrum analyzer	R&S	FSP40	100080	9kHz~40GHz	Dec. 21, 2022	Dec. 20, 2023	Radiation (03CH06-CB)
EMI Test Receiver	R&S	ESCS	826547/017	9kHz ~ 2.75GHz	Jun. 13, 2023	Jun. 12, 2024	Radiation (03CH06-CB)
RF Cable-low	Woken	RG402	Low Cable-24+68	30MHz~1GHz	Oct. 03, 2022	Oct. 02, 2023	Radiation (03CH06-CB)
Test Software	SPORTON	SENSE	V5.10	-	N.C.R.	N.C.R.	Radiation (03CH06-CB)
3m Semi Anechoic Chamber VSWR	TDK	SAC-3M	03CH04-CB	1GHz ~18GHz 3m	Feb. 23, 2023	Feb. 22, 2024	Radiation (03CH04-CB)
Horn Antenna	ETS-Lindgren	3115	00143147	750MHz~18GHz	Oct. 12, 2022	Oct. 11, 2023	Radiation (03CH04-CB)
Horn Antenna	SCHWARZBECK	BBHA 9170	BBHA9170507	15GHz ~ 40GHz	Jun. 28, 2023	Jun. 27, 2024	Radiation (03CH04-CB)
Pre-Amplifier	Agilent	83017A	MY53270063	0.5GHz ~ 26.5GHz	Jun. 30, 2023	Jun. 29, 2024	Radiation (03CH04-CB)
Pre-Amplifier	SGH	SGH184	20221107-3	18GHz ~ 40GHz	Nov. 16, 2022	Nov. 15, 2023	Radiation (03CH04-CB)
Spectrum Analyzer	R&S	FSP40	100142	9kHz~40GHz	Mar. 21, 2023	Mar. 20, 2024	Radiation (03CH04-CB)



Instrument	Brand	Model No.	Serial No.	Characteristics	Calibration Date	Calibration Due Date	Remark
RF Cable-high	Woken	RG402	High Cable-21	1GHz - 18GHz	Oct. 03, 2022	Oct. 02, 2023	Radiation (03CH04-CB)
RF Cable-high	Woken	RG402	High Cable-21+67	1GHz - 18GHz	Oct. 03, 2022	Oct. 02, 2023	Radiation (03CH04-CB)
High Cable	Woken	WCA0929M	40G#5+6	1GHz ~ 40 GHz	Dec. 07, 2022	Dec. 06, 2023	Radiation (03CH04-CB)
High Cable	Woken	WCA0929M	40G#5	1GHz ~ 40 GHz	Dec. 07, 2022	Dec. 06, 2023	Radiation (03CH04-CB)
High Cable	Woken	WCA0929M	40G#6	1GHz ~ 40 GHz	Dec. 07, 2022	Dec. 06, 2023	Radiation (03CH04-CB)
Test Software	SPORTON	SENSE	V5.10	-	N.C.R.	N.C.R.	Radiation (03CH04-CB)
Spectrum analyzer	R&S	FSV40	101028	9kHz~40GHz	Dec. 30, 2022	Dec. 29, 2023	Conducted (TH03-CB)
Power Sensor	Anritsu	MA2411B	1726195	300MHz~40GHz	Sep. 04, 2022	Sep. 03, 2023	Conducted (TH03-CB)
Power Meter	Anritsu	ML2495A	1035008	300MHz~40GHz	Sep. 04, 2022	Sep. 03, 2023	Conducted (TH03-CB)
RF Cable	Woken	RG402	High Cable-11	30MHz ~18 GHz	Feb. 14, 2023	Feb. 13, 2024	Conducted (TH03-CB)
RF Cable	Woken	RG402	High Cable-12	30MHz ~18 GHz	Feb. 14, 2023	Feb. 13, 2024	Conducted (TH03-CB)
RF Cable	Woken	RG402	High Cable-13	30MHz ~18 GHz	Feb. 14, 2023	Feb. 13, 2024	Conducted (TH03-CB)
RF Cable-high	Woken	RG402	High Cable-14	1 GHz ~18 GHz	Oct. 03, 2022	Oct. 02, 2023	Conducted (TH03-CB)
RF Cable-high	Woken	RG402	High Cable-15	1 GHz ~18 GHz	Oct. 03, 2022	Oct. 02, 2023	Conducted (TH03-CB)
Switch	SPTCB	SP-SWI	SWI-03	1 GHz ~26.5 GHz	Oct. 04, 2022	Oct. 03, 2023	Conducted (TH03-CB)
Test Software	SPORTON	SENSE	V5.10	-	N.C.R.	N.C.R.	Conducted (TH03-CB)

Note: Calibration Interval of instruments listed above is one year.

NCR means Non-Calibration required.



Summary

Mode	Result	Type	Freq (Hz)	Level (dBuV)	Limit (dBuV)	Margin (dB)	Condition
Mode 1	Pass	QP	159k	56.08	65.52	-9.44	Line

Mode 1

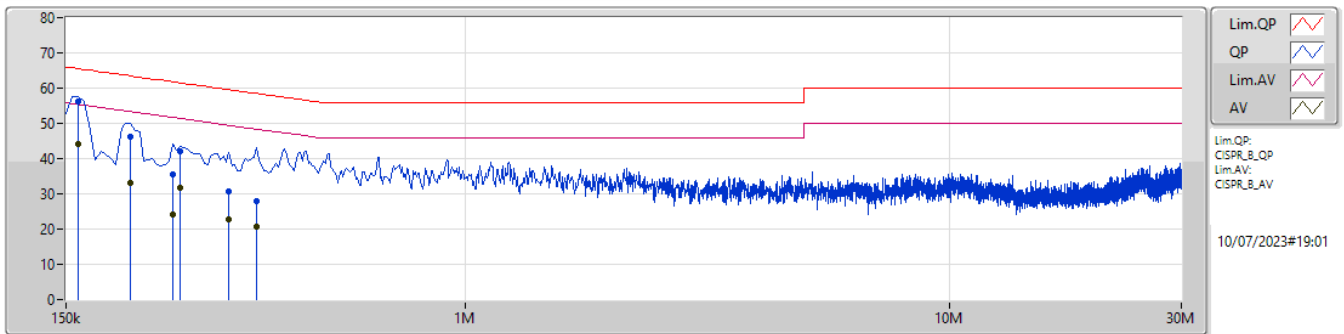

Type	Freq (Hz)	Level (dBuV)	Limit (dBuV)	Margin (dB)	Factor (dB)	Condition	Comment	Raw (dBuV)	LISN (dB)	CL (dB)	AT (dB)
QP	159k	56.08	65.52	-9.44	10.00	Line	"Worst"	46.08	0.09	0.04	9.87
AV	159k	44.08	55.52	-11.44	10.00	Line	-	34.08	0.09	0.04	9.87
QP	204k	46.13	63.44	-17.31	9.98	Line	-	36.15	0.08	0.04	9.86
AV	204k	33.19	53.44	-20.25	9.98	Line	-	23.21	0.08	0.04	9.86
QP	249k	35.42	61.79	-26.37	10.00	Line	-	25.42	0.08	0.05	9.87
AV	249k	24.15	51.79	-27.64	10.00	Line	-	14.15	0.08	0.05	9.87
QP	258k	42.00	61.49	-19.49	10.00	Line	-	32.00	0.08	0.05	9.87
AV	258k	31.57	51.49	-19.92	10.00	Line	-	21.57	0.08	0.05	9.87
QP	325.5k	30.55	59.56	-29.01	10.03	Line	-	20.52	0.09	0.05	9.89
AV	325.5k	22.69	49.56	-26.87	10.03	Line	-	12.66	0.09	0.05	9.89
QP	370.5k	28.00	58.49	-30.49	10.05	Line	-	17.95	0.09	0.06	9.90
AV	370.5k	20.59	48.49	-27.90	10.05	Line	-	10.54	0.09	0.06	9.90

Mode 1

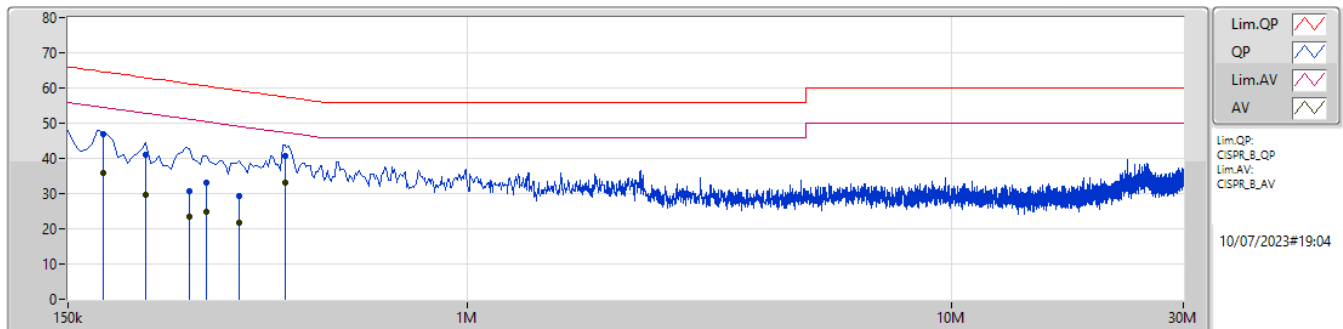

Type	Freq (Hz)	Level (dBuV)	Limit (dBuV)	Margin (dB)	Factor (dB)	Condition	Comment	Raw (dBuV)	LISN (dB)	CL (dB)	AT (dB)
QP	177k	46.82	64.62	-17.80	9.98	Neutral	-	36.84	0.07	0.04	9.87
AV	177k	36.00	54.62	-18.62	9.98	Neutral	-	26.02	0.07	0.04	9.87
QP	217.5k	41.00	62.92	-21.92	9.97	Neutral	-	31.03	0.07	0.04	9.86
AV	217.5k	29.57	52.92	-23.35	9.97	Neutral	-	19.60	0.07	0.04	9.86
QP	267k	30.58	61.20	-30.62	10.00	Neutral	-	20.58	0.07	0.05	9.88
AV	267k	23.46	51.20	-27.74	10.00	Neutral	-	13.46	0.07	0.05	9.88
QP	289.5k	32.95	60.53	-27.58	10.00	Neutral	-	22.95	0.07	0.05	9.88
AV	289.5k	24.86	50.53	-25.67	10.00	Neutral	-	14.86	0.07	0.05	9.88
QP	339k	29.41	59.23	-29.82	10.02	Neutral	-	19.39	0.07	0.06	9.89
AV	339k	21.87	49.23	-27.36	10.02	Neutral	-	11.85	0.07	0.06	9.89
QP	420k	40.83	57.45	-16.62	10.03	Neutral	-	30.80	0.07	0.06	9.90
AV	420k	33.20	47.45	-14.25	10.03	Neutral	"Worst"	23.17	0.07	0.06	9.90



Summary

Mode	Max-N dB (Hz)	Max-OBW (Hz)	ITU-Code	Min-N dB (Hz)	Min-OBW (Hz)
2.4-2.4835GHz	-	-	-	-	-
802.11b_Nss1,(1Mbps)_2TX	9.525M	16.197M	16M2G1D	8.025M	13.199M
802.11g_Nss1,(6Mbps)_2TX	16.275M	25.256M	25M3D1D	15.05M	16.282M
802.11ax HEW20_Nss1,(MCS0)_2TX	18.475M	21.014M	21M0D1D	15.2M	18.797M
802.11ax HEW40_Nss1,(MCS0)_2TX	38M	37.718M	37M7D1D	33.45M	37.403M

Max-N dB = Maximum 6dB down bandwidth; Max-OBW = Maximum 99% occupied bandwidth;
Min-N dB = Minimum 6dB down bandwidth; Min-OBW = Minimum 99% occupied bandwidth

Result

Mode	Result	Limit (Hz)	Port 1-N dB (Hz)	Port 1-OBW (Hz)	Port 2-N dB (Hz)	Port 2-OBW (Hz)
802.11b_Nss1,(1Mbps)_2TX	-	-	-	-	-	-
2412MHz	Pass	500k	8.025M	13.199M	8.525M	13.283M
2437MHz	Pass	500k	9.525M	15.802M	9.05M	16.197M
2462MHz	Pass	500k	8.575M	13.659M	8.55M	13.407M
802.11g_Nss1,(6Mbps)_2TX	-	-	-	-	-	-
2412MHz	Pass	500k	15.05M	16.282M	15.4M	16.299M
2437MHz	Pass	500k	15.675M	23.485M	16.275M	25.256M
2462MHz	Pass	500k	15.675M	16.362M	15.7M	16.33M
802.11ax HEW20_Nss1,(MCS0)_2TX	-	-	-	-	-	-
2412MHz	Pass	500k	15.95M	18.799M	15.2M	18.797M
2437MHz	Pass	500k	16.875M	20.006M	16.825M	21.014M
2462MHz	Pass	500k	18.475M	18.877M	16.8M	18.808M
802.11ax HEW40_Nss1,(MCS0)_2TX	-	-	-	-	-	-
2422MHz	Pass	500k	36.9M	37.555M	35M	37.412M
2437MHz	Pass	500k	34.05M	37.555M	38M	37.718M
2452MHz	Pass	500k	35.8M	37.403M	33.45M	37.451M

Port X-N dB = Port X 6dB down bandwidth;
 Port X-OBW = Port X 99% occupied bandwidth

2.4-2.4835GHz_802.11b_Nss1,(1Mbps)_2TX

EBW

2412MHz

15/08/2023

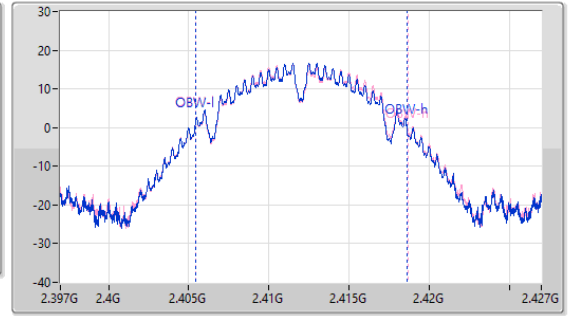
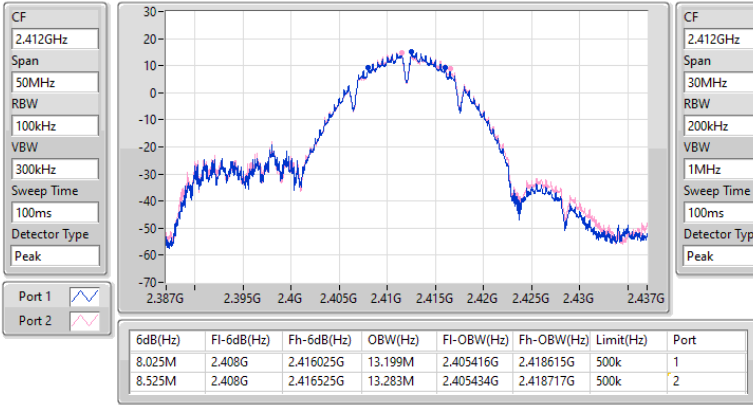

2.4-2.4835GHz_802.11b_Nss1,(1Mbps)_2TX

EBW

2437MHz

15/08/2023

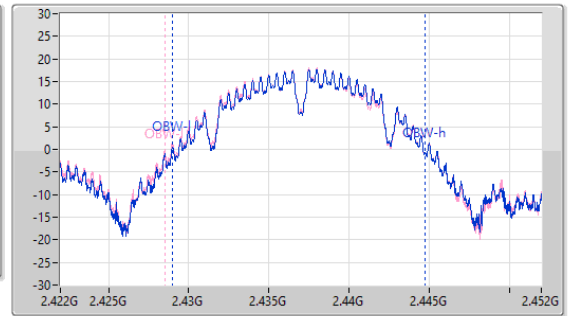
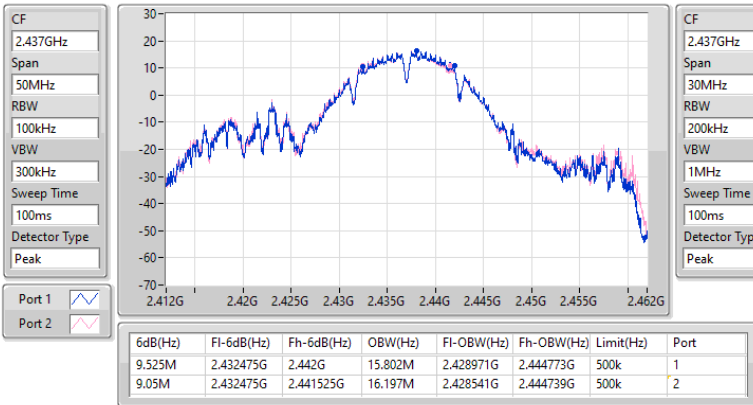

2.4-2.4835GHz_802.11b_Nss1,(1Mbps)_2TX

EBW

2462MHz

15/08/2023

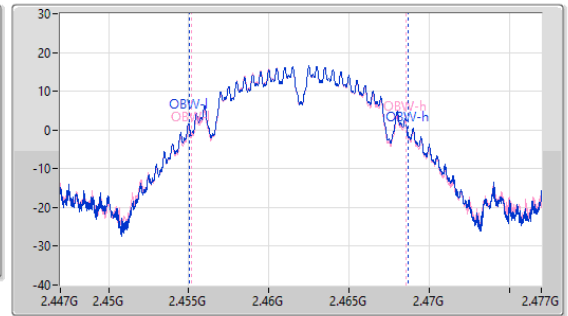
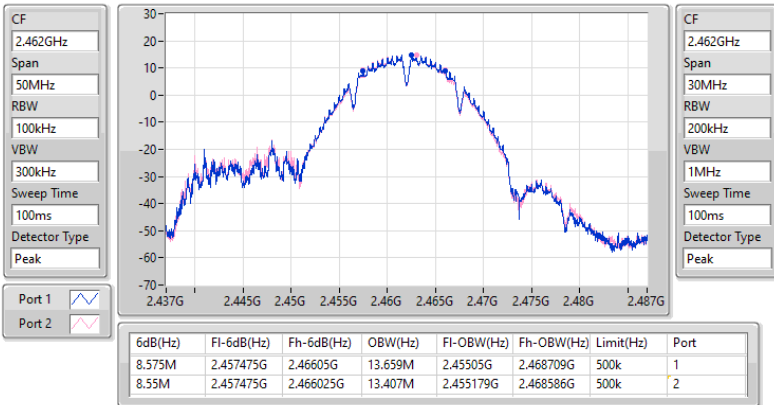

2.4-2.4835GHz_802.11g_Nss1,(6Mbps)_2TX

EBW

2412MHz

15/08/2023

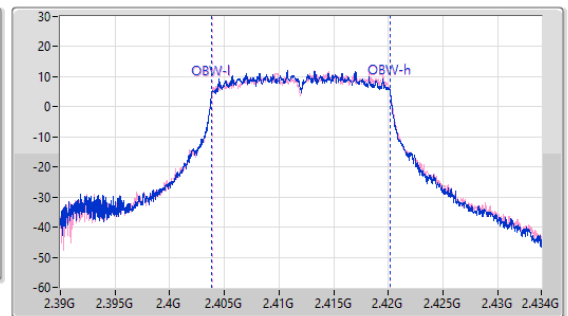
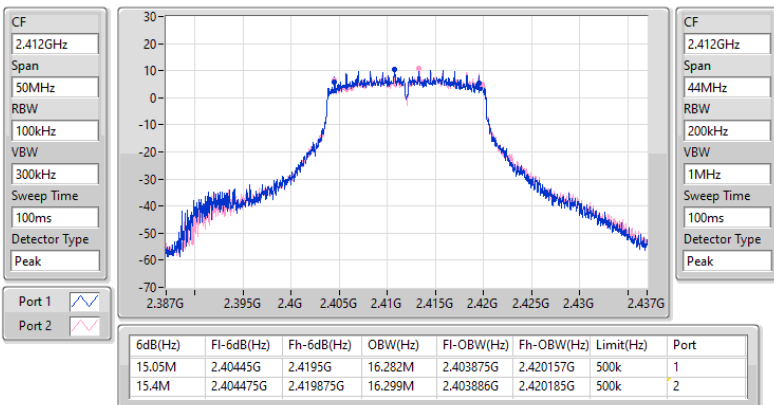

2.4-2.4835GHz_802.11g_Nss1,(6Mbps)_2TX

EBW

2437MHz

15/08/2023

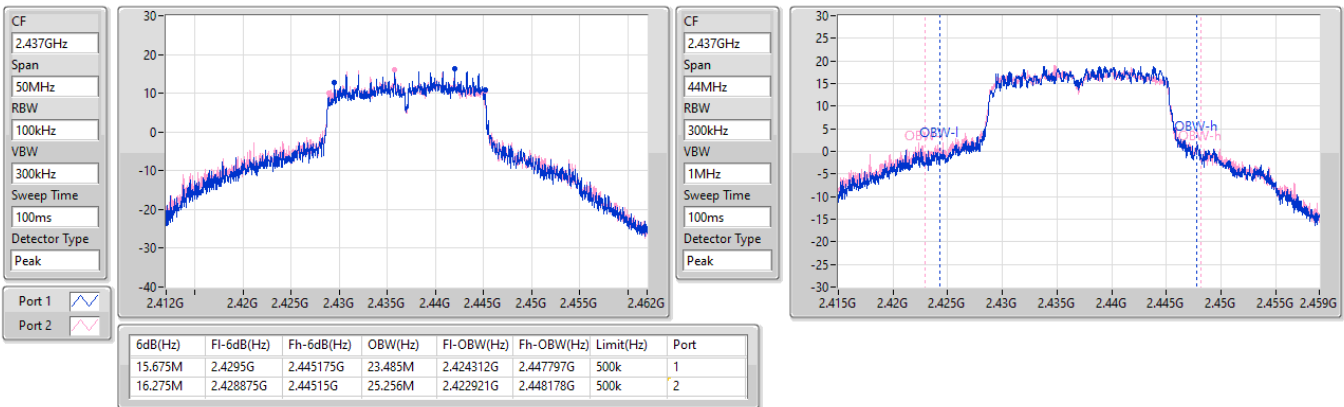

2.4-2.4835GHz_802.11g_Nss1,(6Mbps)_2TX

EBW

2462MHz

15/08/2023

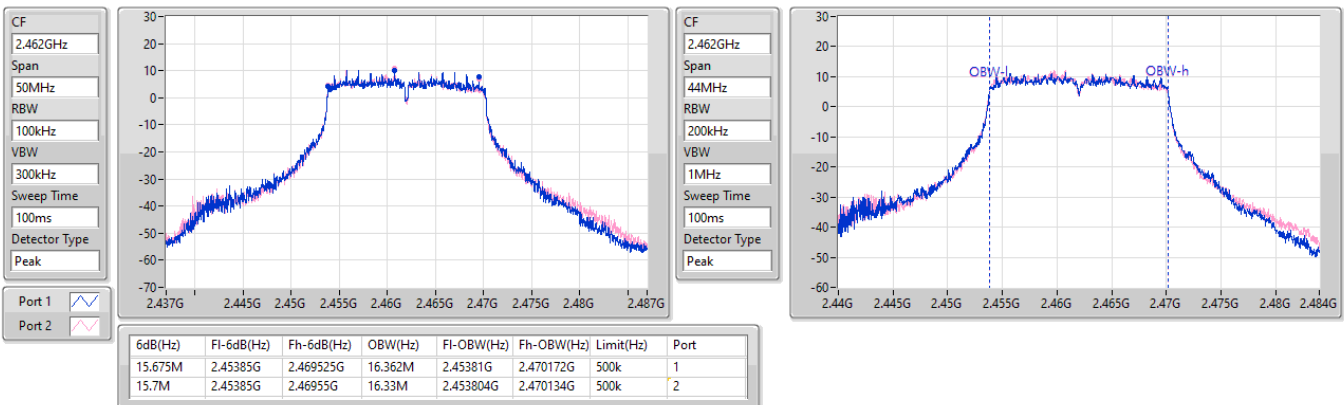

2.4-2.4835GHz_802.11ax HEW20_Nss1,(MCS0)_2TX

EBW

2412MHz

15/08/2023

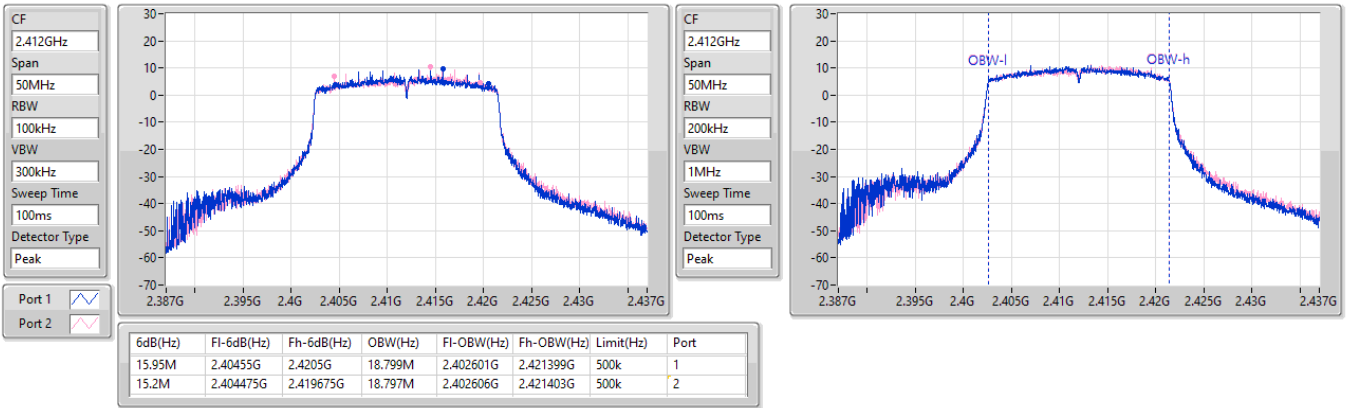

2.4-2.4835GHz_802.11ax HEW20_Nss1,(MCS0)_2TX

EBW

2437MHz

15/08/2023

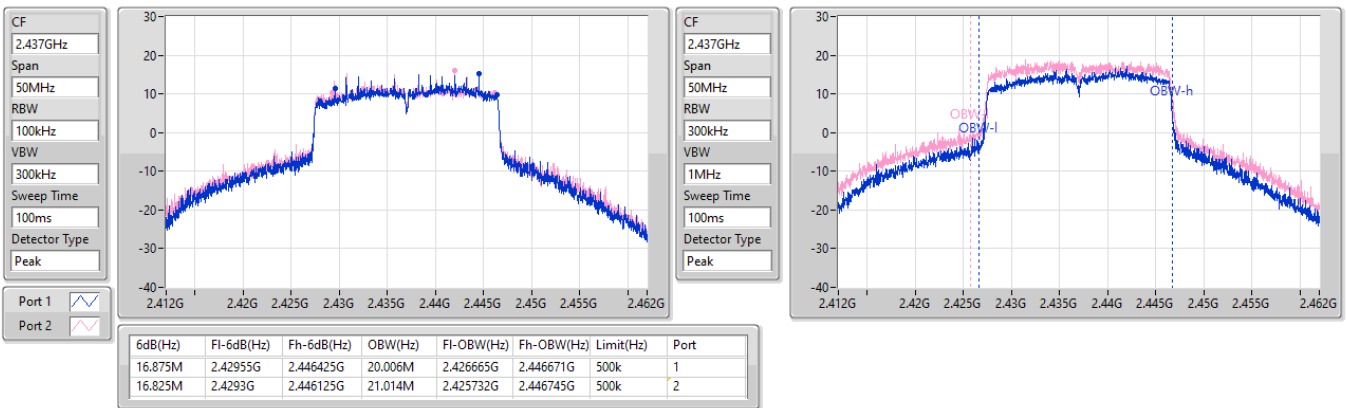

2.4-2.4835GHz_802.11ax HEW20_Nss1,(MCS0)_2TX

EBW

2462MHz

15/08/2023

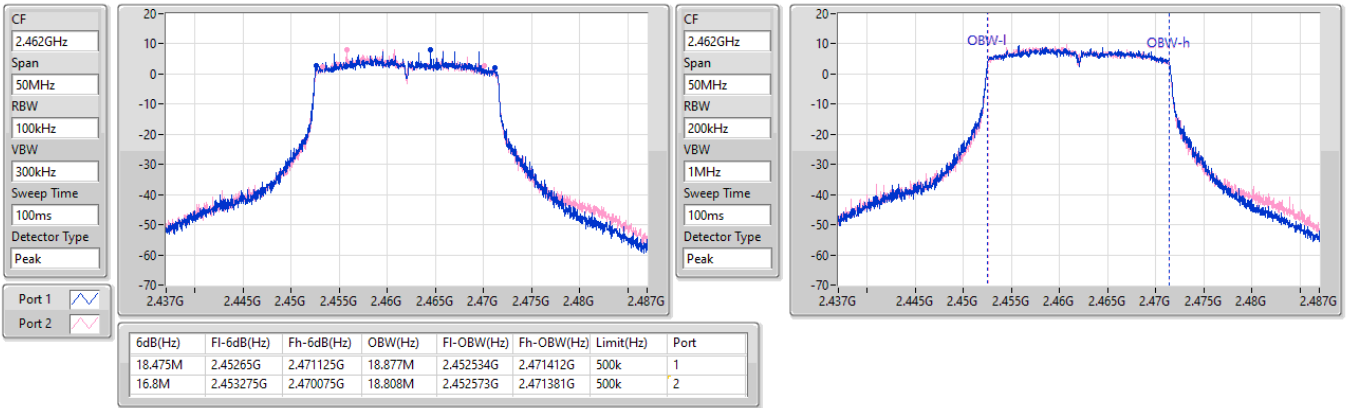

2.4-2.4835GHz_802.11ax HEW40_Nss1,(MCS0)_2TX

EBW

2422MHz

15/08/2023

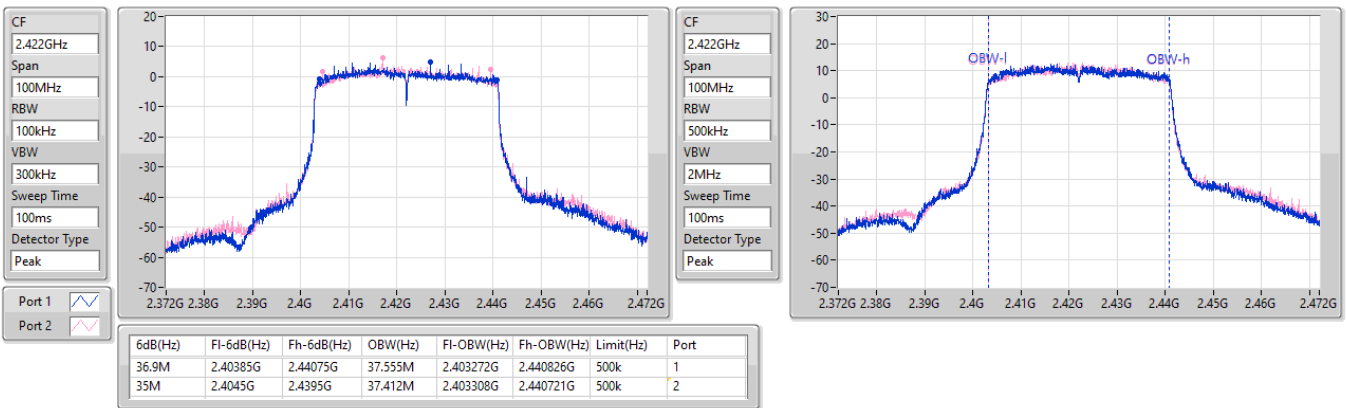

2.4-2.4835GHz_802.11ax HEW40_Nss1,(MCS0)_2TX

EBW

2437MHz

15/08/2023

CF
2.437GHz
Span
100MHz
RBW
100kHz
VBW
300kHz
Sweep Time
100ms
Detector Type
Peak

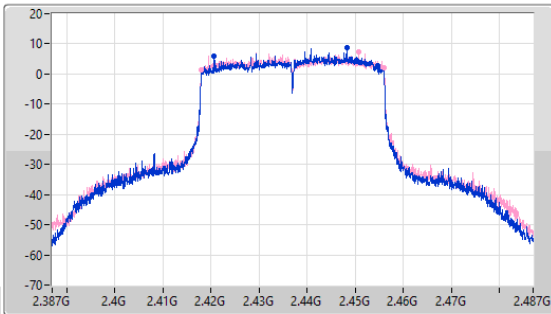

CF
2.437GHz
Span
100MHz
RBW
500kHz
VBW
2MHz
Sweep Time
100ms
Detector Type
Peak

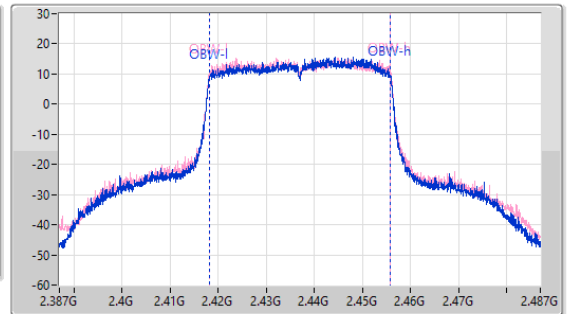

6dB(Hz)	Fl-6dB(Hz)	Fh-6dB(Hz)	OBW(Hz)	Fl-OBW(Hz)	Fh-OBW(Hz)	Limit(Hz)	Port
34.05M	2.4207G	2.45475G	37.555M	2.41825G	2.455805G	500k	1
38M	2.418G	2.456G	37.718M	2.418174G	2.455892G	500k	2

2.4-2.4835GHz_802.11ax HEW40_Nss1,(MCS0)_2TX

EBW

2452MHz

15/08/2023

CF
2.452GHz
Span
100MHz
RBW
100kHz
VBW
300kHz
Sweep Time
100ms
Detector Type
Peak

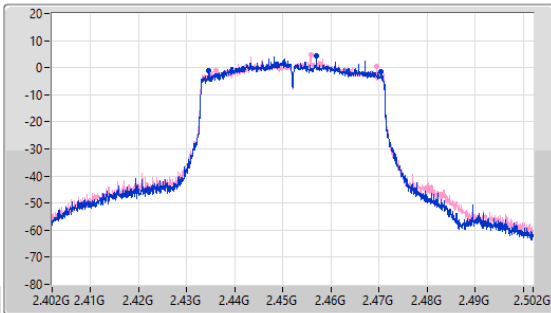

CF
2.452GHz
Span
100MHz
RBW
500kHz
VBW
2MHz
Sweep Time
100ms
Detector Type
Peak

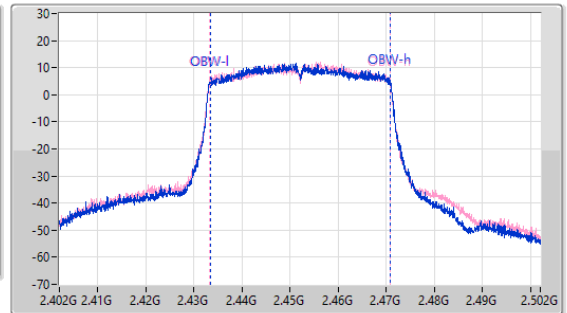

6dB(Hz)	Fl-6dB(Hz)	Fh-6dB(Hz)	OBW(Hz)	Fl-OBW(Hz)	Fh-OBW(Hz)	Limit(Hz)	Port
35.8M	2.43455G	2.47035G	37.403M	2.433324G	2.470727G	500k	1
33.45M	2.4361G	2.46955G	37.451M	2.433271G	2.470722G	500k	2



Summary

Mode	Total Power (dBm)	Total Power (W)
2.4-2.4835GHz	-	-
802.11b_Nss1,(1Mbps)_2TX	29.79	0.95280
802.11g_Nss1,(6Mbps)_2TX	29.86	0.96828
802.11ax HEW20_Nss1,(MCS0)_2TX	29.09	0.81096
802.11ax HEW20-BF_Nss1,(MCS0)_2TX	27.09	0.51168
802.11ax HEW40_Nss1,(MCS0)_2TX	25.15	0.32734
802.11ax HEW40-BF_Nss1,(MCS0)_2TX	25.15	0.32734



Result

Mode	Result	DG (dBi)	Port 1 (dBm)	Port 2 (dBm)	Total Power (dBm)	Power Limit (dBm)
802.11b_Nss1,(1Mbps)_2TX	-	-	-	-	-	-
2412MHz	Pass	5.99	24.21	24.34	27.29	30.00
2417MHz	Pass	5.99	24.09	24.21	27.16	30.00
2437MHz	Pass	5.99	26.7	26.86	29.79	30.00
2457MHz	Pass	5.99	24.48	24.49	27.50	30.00
2462MHz	Pass	5.99	24.59	24.52	27.57	30.00
802.11g_Nss1,(6Mbps)_2TX	-	-	-	-	-	-
2412MHz	Pass	5.99	20.86	20.75	23.82	30.00
2417MHz	Pass	5.99	23.14	23.45	26.31	30.00
2437MHz	Pass	5.99	26.73	26.97	29.86	30.00
2457MHz	Pass	5.99	23.48	23.63	26.57	30.00
2462MHz	Pass	5.99	20.54	20.73	23.65	30.00
802.11ax HEW20_Nss1,(MCS0)_2TX	-	-	-	-	-	-
2412MHz	Pass	5.99	19.95	20.01	22.99	30.00
2417MHz	Pass	5.99	22.91	22.87	25.90	30.00
2437MHz	Pass	5.99	25.92	26.23	29.09	30.00
2457MHz	Pass	5.99	23.65	23.62	26.65	30.00
2462MHz	Pass	5.99	18.32	18.5	21.42	30.00
802.11ax HEW40_Nss1,(MCS0)_2TX	-	-	-	-	-	-
2422MHz	Pass	5.99	18.99	19.2	22.11	30.00
2427MHz	Pass	5.99	20.45	20.48	23.48	30.00
2437MHz	Pass	5.99	22.02	22.26	25.15	30.00
2447MHz	Pass	5.99	19.19	19.37	22.29	30.00
2452MHz	Pass	5.99	17.82	17.97	20.91	30.00
802.11ax HEW20-BF_Nss1,(MCS0)_2TX	-	-	-	-	-	-
2412MHz	Pass	8.84	19.95	20.01	22.99	27.16
2417MHz	Pass	8.84	22.91	22.87	25.90	27.16
2437MHz	Pass	8.84	23.91	24.25	27.09	27.16
2457MHz	Pass	8.84	23.65	23.62	26.65	27.16
2462MHz	Pass	8.84	18.32	18.5	21.42	27.16
802.11ax HEW40-BF_Nss1,(MCS0)_2TX	-	-	-	-	-	-
2422MHz	Pass	8.84	18.99	19.2	22.11	27.16
2427MHz	Pass	8.84	20.45	20.48	23.48	27.16
2437MHz	Pass	8.84	22.02	22.26	25.15	27.16
2447MHz	Pass	8.84	19.19	19.37	22.29	27.16
2452MHz	Pass	8.84	17.82	17.97	20.91	27.16

DG = Directional Gain; Port X = Port X output power



Summary

Mode	PD (dBm/RBW)
2.4-2.4835GHz	-
802.11b_Nss1,(1Mbps)_2TX	4.09
802.11g_Nss1,(6Mbps)_2TX	1.75
802.11ax HEW20_Nss1,(MCS0)_2TX	1.32
802.11ax HEW40_Nss1,(MCS0)_2TX	-5.61

RBW = 3kHz;

Result

Mode	Result	DG (dBi)	Port 1 (dBm/RBW)	Port 2 (dBm/RBW)	PD (dBm/RBW)	PD Limit (dBm/RBW)
802.11b_Nss1,(1Mbps)_2TX	-	-	-	-	-	-
2412MHz	Pass	8.84	1.41	1.00	4.09	5.16
2437MHz	Pass	8.84	-0.49	0.80	3.21	5.16
2462MHz	Pass	8.84	0.46	0.04	3.26	5.16
802.11g_Nss1,(6Mbps)_2TX	-	-	-	-	-	-
2412MHz	Pass	8.84	-6.12	-5.42	-4.07	5.16
2437MHz	Pass	8.84	-0.69	-0.21	1.75	5.16
2462MHz	Pass	8.84	-5.07	-6.39	-3.56	5.16
802.11ax HEW20_Nss1,(MCS0)_2TX	-	-	-	-	-	-
2412MHz	Pass	8.84	-6.79	-6.51	-4.40	5.16
2437MHz	Pass	8.84	-0.86	-1.10	1.32	5.16
2462MHz	Pass	8.84	-8.76	-7.50	-5.11	5.16
802.11ax HEW40_Nss1,(MCS0)_2TX	-	-	-	-	-	-
2422MHz	Pass	8.84	-9.82	-9.78	-8.07	5.16
2437MHz	Pass	8.84	-7.50	-7.07	-5.61	5.16
2452MHz	Pass	8.84	-10.50	-10.29	-8.83	5.16

DG = Directional Gain; RBW = 3kHz;
 PD = trace bin-by-bin of each transmits port summing can be performed maximum power density; Port X = Port X Power Density;

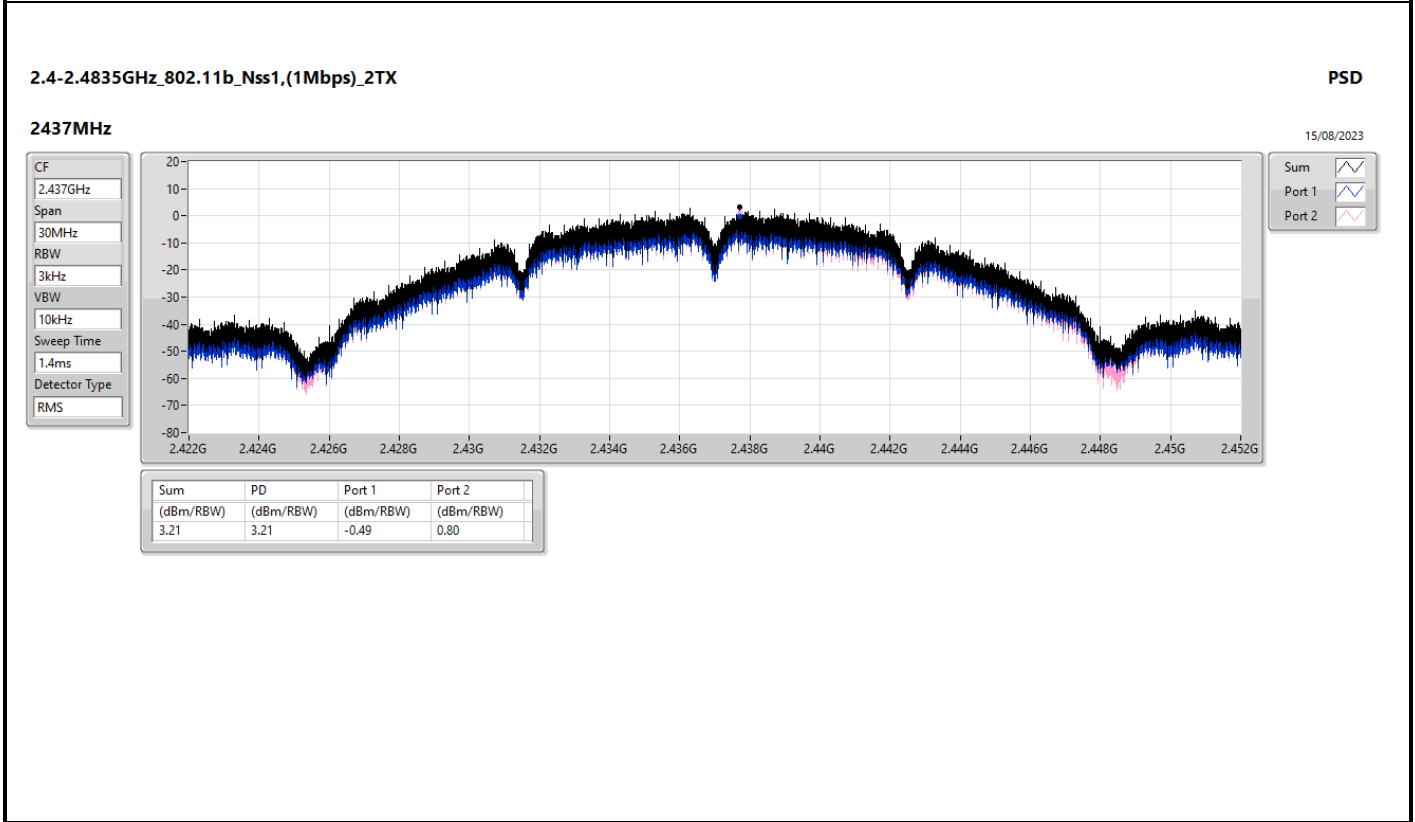
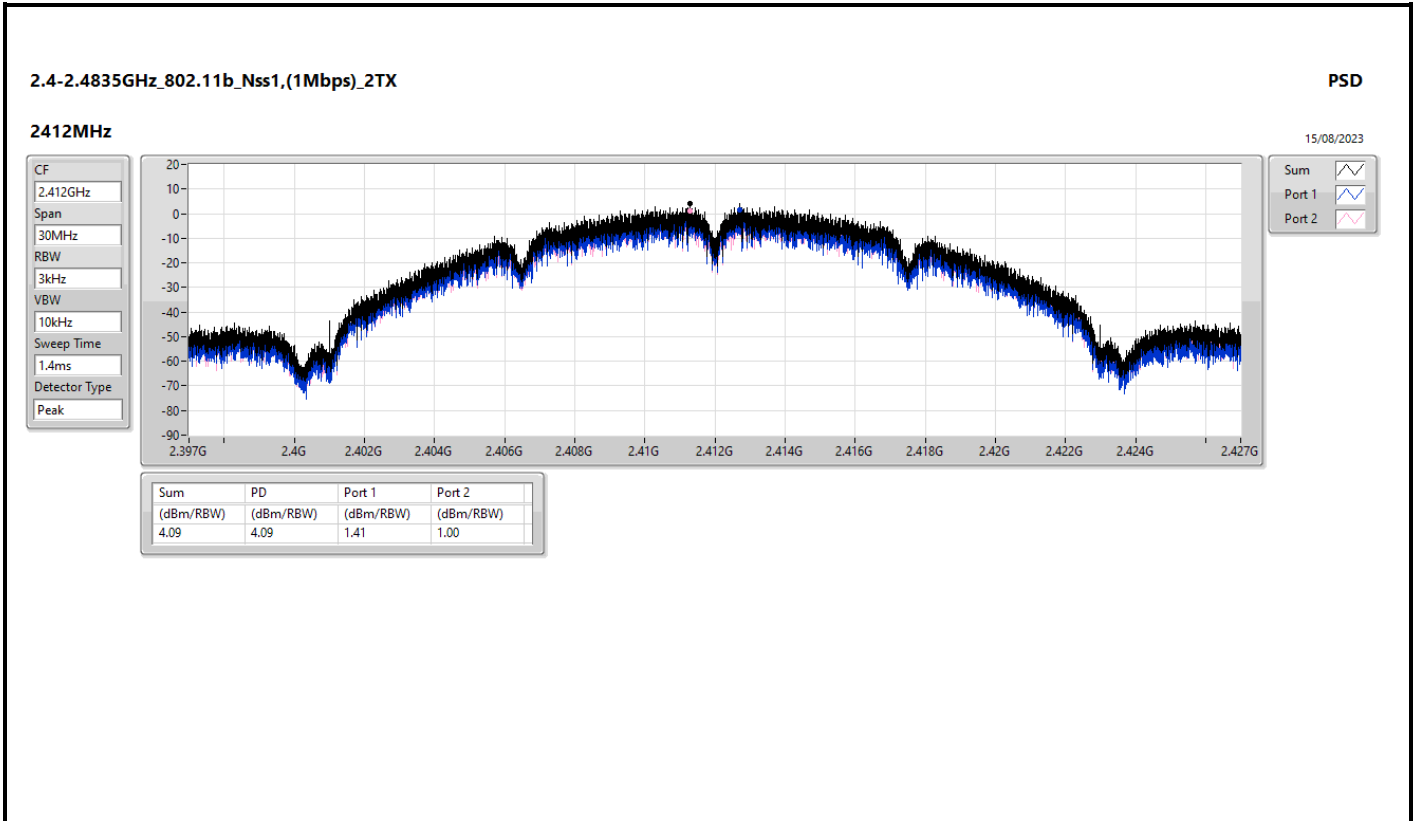

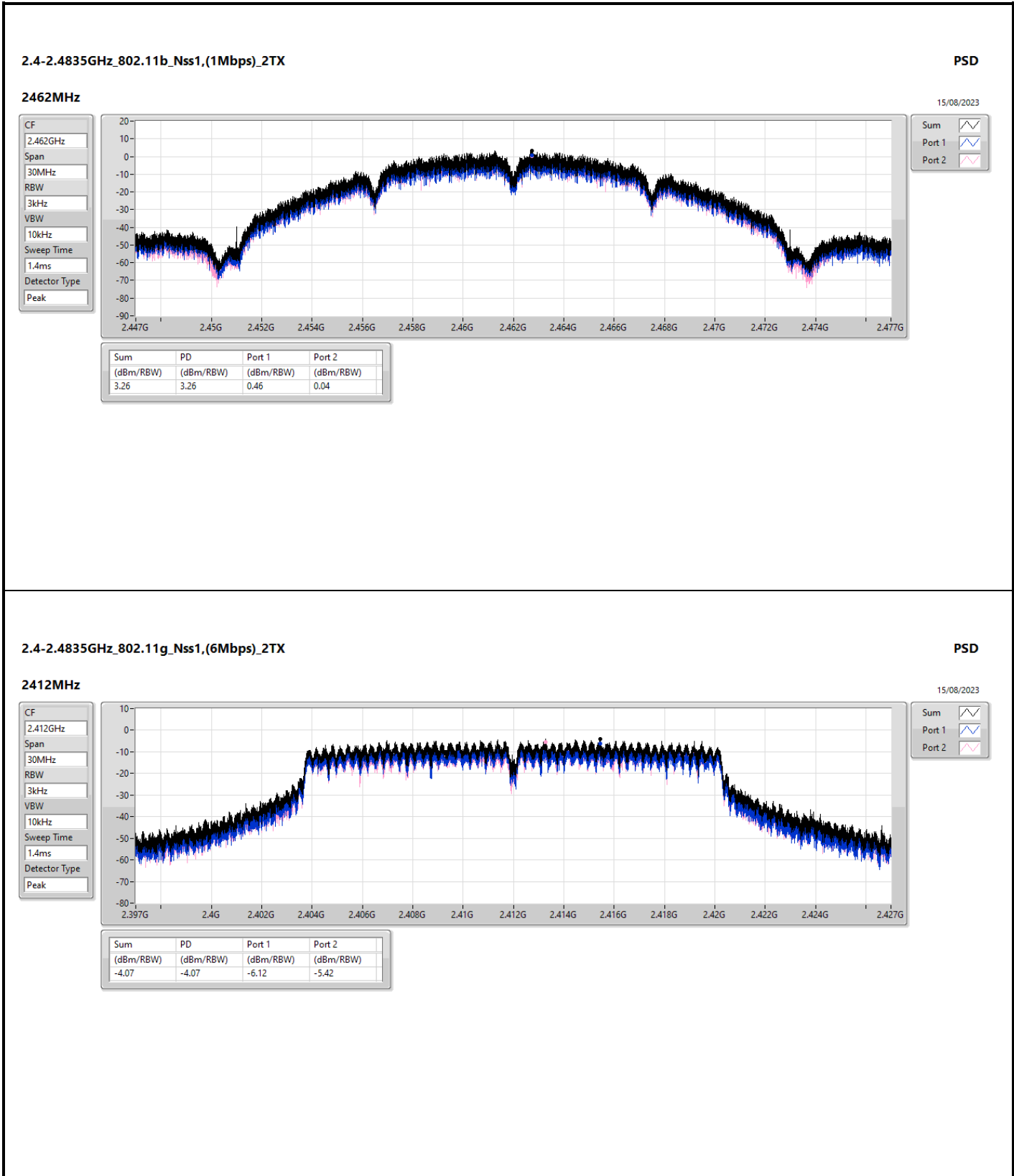

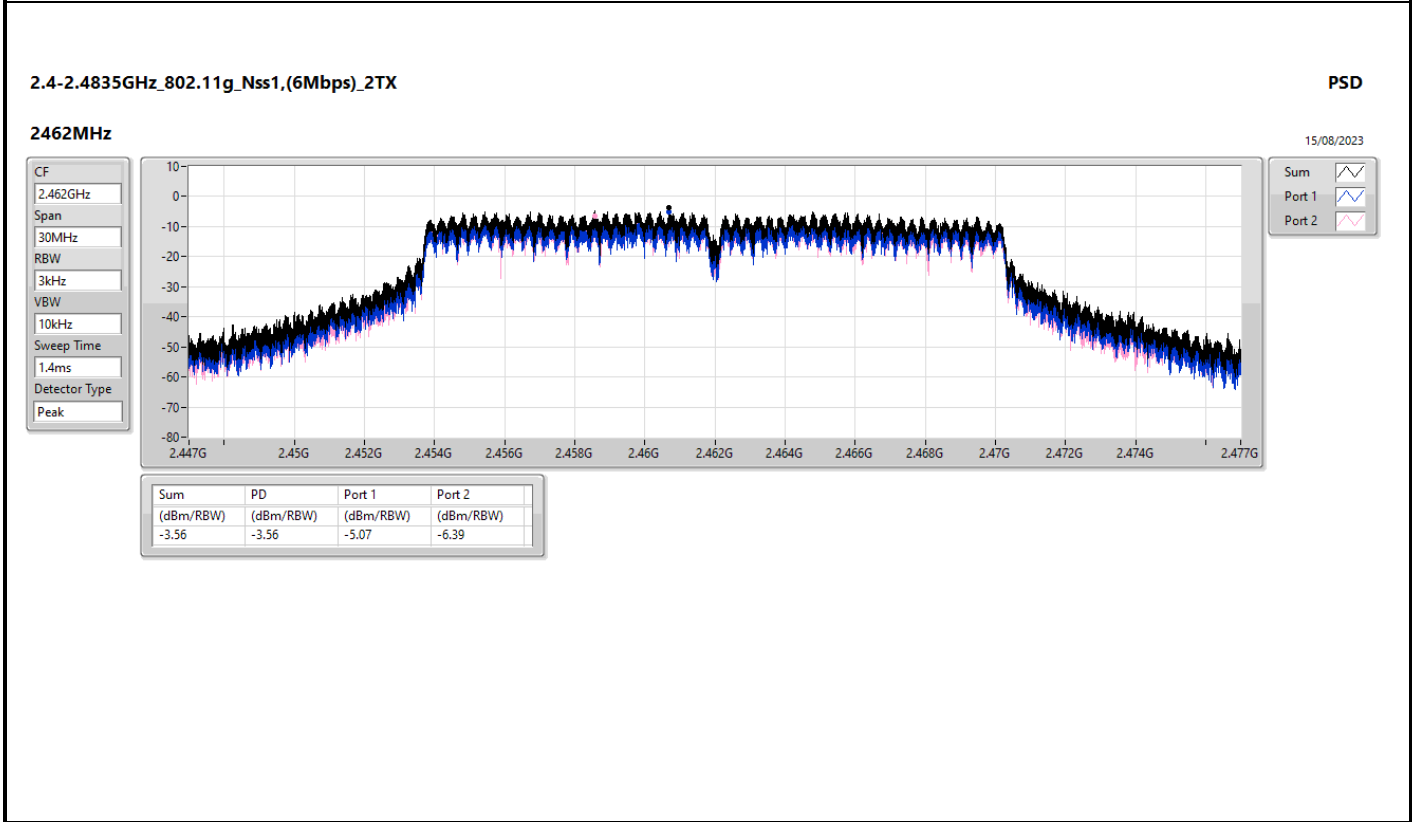
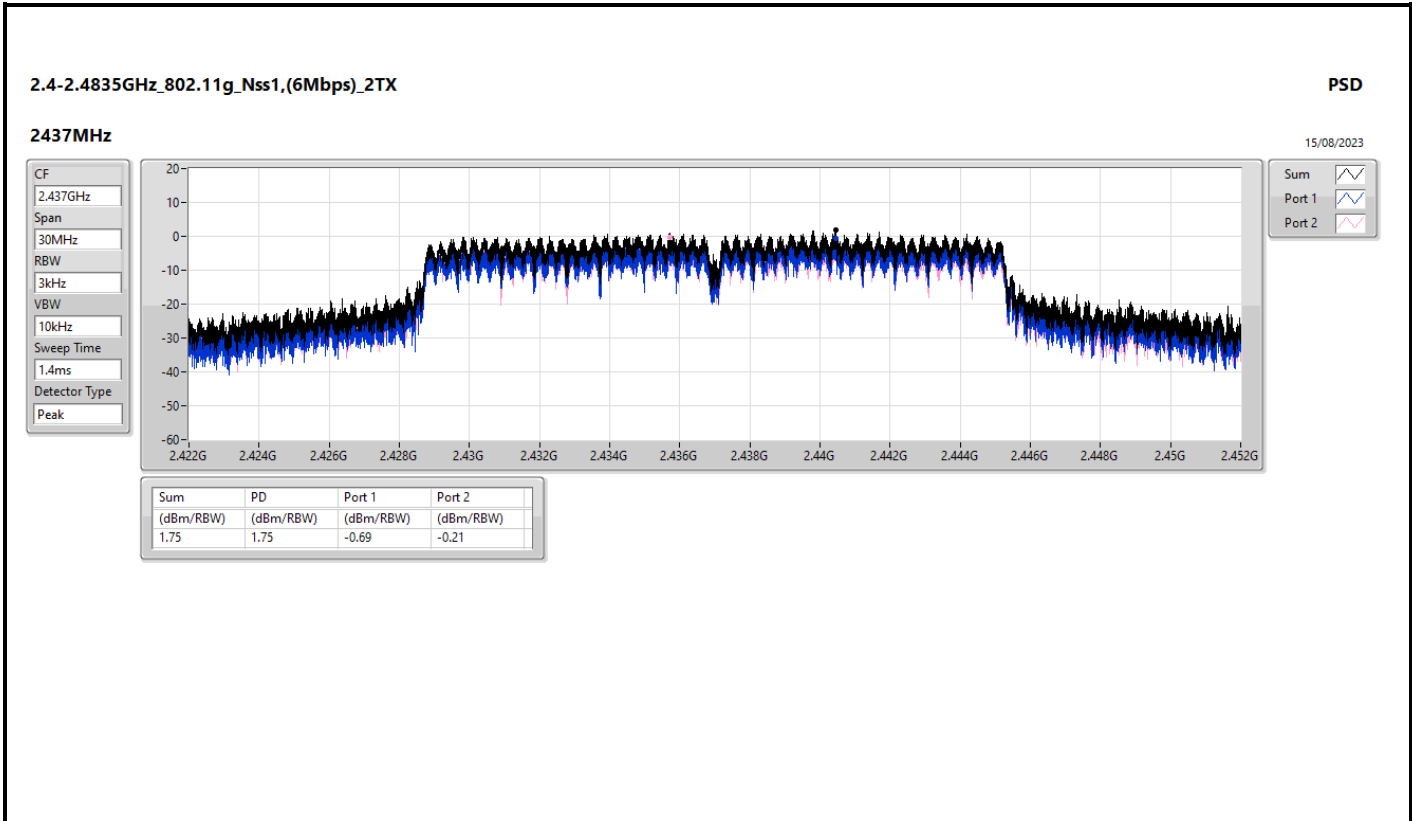

2.4-2.4835GHz_802.11ax HEW20_Nss1,(MCS0)_2TX

PSD

2412MHz

15/08/2023

CF
2.412GHz

Span
30MHz

RBW
3kHz

VBW
10kHz

Sweep Time
1.4ms

Detector Type
Peak

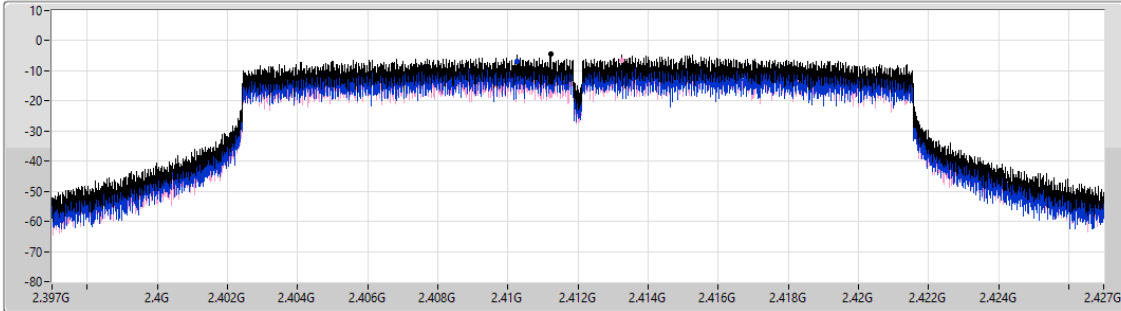

Sum 

Port 1 

Port 2 

Sum	PD	Port 1	Port 2
(dBm/RBW)	(dBm/RBW)	(dBm/RBW)	(dBm/RBW)
-4.40	-4.40	-6.79	-6.51

2.4-2.4835GHz_802.11ax HEW20_Nss1,(MCS0)_2TX

PSD

2437MHz

15/08/2023

CF
2.437GHz

Span
30MHz

RBW
3kHz

VBW
10kHz

Sweep Time
1.4ms

Detector Type
Peak

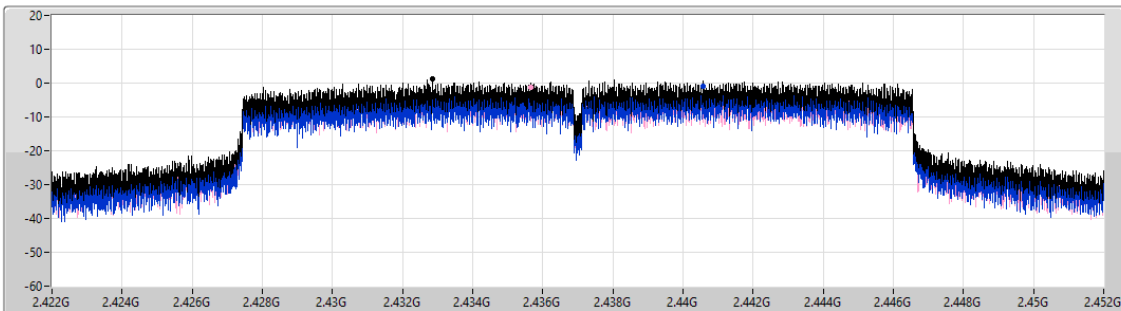

Sum 

Port 1 

Port 2 

Sum	PD	Port 1	Port 2
(dBm/RBW)	(dBm/RBW)	(dBm/RBW)	(dBm/RBW)
1.32	1.32	-0.86	-1.10

2.4-2.4835GHz_802.11ax HEW20_Nss1,(MCS0)_2TX

PSD

2462MHz

15/08/2023

CF
2.462GHz

Span
30MHz

RBW
3kHz

VBW
10kHz

Sweep Time
1.4ms

Detector Type
Peak

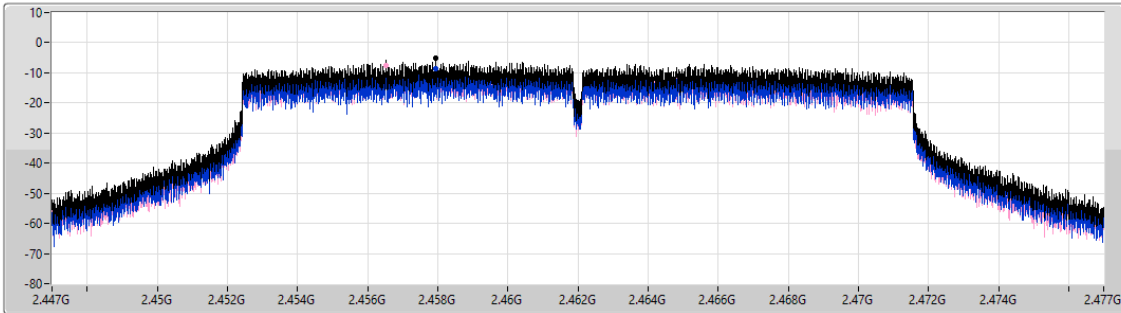

Sum 

Port 1 

Port 2 

Sum	PD	Port 1	Port 2
(dBm/RBW)	(dBm/RBW)	(dBm/RBW)	(dBm/RBW)
-5.11	-5.11	-8.76	-7.50

2.4-2.4835GHz_802.11ax HEW40_Nss1,(MCS0)_2TX

PSD

2422MHz

15/08/2023

CF
2.422GHz

Span
60MHz

RBW
3kHz

VBW
10kHz

Sweep Time
2.79ms

Detector Type
Peak

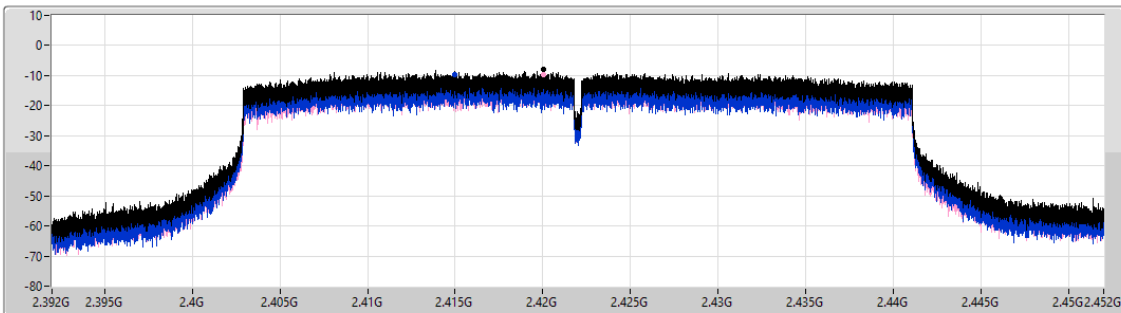

Sum 

Port 1 

Port 2 

Sum	PD	Port 1	Port 2
(dBm/RBW)	(dBm/RBW)	(dBm/RBW)	(dBm/RBW)
-8.07	-8.07	-9.82	-9.78

2.4-2.4835GHz_802.11ax HEW40_Nss1,(MCS0)_2TX

PSD

2437MHz

15/08/2023

CF
2.437GHz

Span
60MHz

RBW
3kHz

VBW
10kHz

Sweep Time
2.79ms

Detector Type
Peak

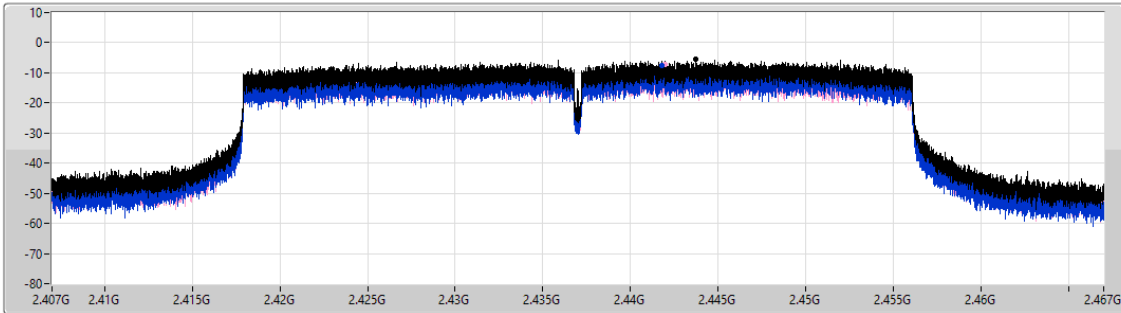

Sum 

Port 1 

Port 2 

Sum	PD	Port 1	Port 2
(dBm/RBW)	(dBm/RBW)	(dBm/RBW)	(dBm/RBW)
-5.61	-5.61	-7.50	-7.07

2.4-2.4835GHz_802.11ax HEW40_Nss1,(MCS0)_2TX

PSD

2452MHz

15/08/2023

CF
2.452GHz

Span
60MHz

RBW
3kHz

VBW
10kHz

Sweep Time
2.79ms

Detector Type
Peak

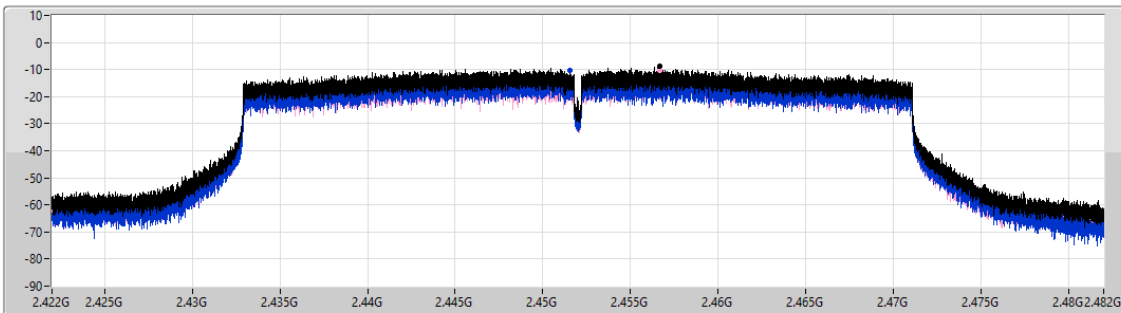

Sum 

Port 1 

Port 2 

Sum	PD	Port 1	Port 2
(dBm/RBW)	(dBm/RBW)	(dBm/RBW)	(dBm/RBW)
-8.83	-8.83	-10.50	-10.29



Summary

Mode	Result	Ref (Hz)	Ref (dBm)	Limit (dBm)	Freq (Hz)	Level (dBm)	Freq (Hz)	Level (dBm)	Freq (Hz)	Level (dBm)	Freq (Hz)	Level (dBm)	Freq (Hz)	Level (dBm)	Port
2.4-2.4835GHz	-	-	-	-	-	-	-	-	-	-	-	-	-	-	-
802.11b_Nss1,(1Mbps)_2TX	Pass	2.43557G	17.53	-12.47	2.127G	-53.59	2.39856G	-33.03	2.4G	-39.95	2.51414G	-51.37	7.23514G	-31.20	2
802.11g_Nss1,(6Mbps)_2TX	Pass	2.43574G	16.78	-13.22	2.03846G	-54.06	2.39976G	-28.19	2.4G	-27.17	2.51014G	-51.24	7.23795G	-38.41	2
802.11ax HEW20_Nss1,(MCS0)_2TX	Pass	2.44192G	16.51	-13.49	2.13166G	-53.47	2.4G	-27.02	2.4G	-27.67	2.50198G	-52.32	7.22671G	-39.81	2
802.11ax HEW40_Nss1,(MCS0)_2TX	Pass	2.44576G	8.66	-21.34	30M	-52.26	2.4G	-33.39	2.4G	-34.14	2.5003G	-53.87	21.49149G	-47.55	2



Result

Mode	Result	Ref (Hz)	Ref (dBm)	Limit (dBm)	Freq (Hz)	Level (dBm)	Freq (Hz)	Level (dBm)	Freq (Hz)	Level (dBm)	Freq (Hz)	Level (dBm)	Freq (Hz)	Level (dBm)	Port
802.11b_Nss1,(1Mbps)_2TX	-	-	-	-	-	-	-	-	-	-	-	-	-	-	-
2412MHz	Pass	2.43557G	17.53	-12.47	2.09205G	-53.67	2.39856G	-33.85	2.4G	-41.25	2.5003G	-51.59	7.23514G	-30.95	1
2412MHz	Pass	2.43557G	17.53	-12.47	2.127G	-53.59	2.39856G	-33.03	2.4G	-39.95	2.51414G	-51.37	7.23514G	-31.20	2
2437MHz	Pass	2.43557G	17.53	-12.47	1.79731G	-54.21	2.39976G	-49.06	2.4G	-50.79	2.52246G	-51.02	21.57795G	-46.79	1
2437MHz	Pass	2.43557G	17.53	-12.47	2.04895G	-53.98	2.39864G	-47.94	2.4G	-48.44	2.51062G	-51.64	21.50771G	-47.55	2
2462MHz	Pass	2.43557G	17.53	-12.47	1.89167G	-53.69	2.39264G	-51.36	2.4G	-54.24	2.5115G	-51.11	21.69314G	-47.21	1
2462MHz	Pass	2.43557G	17.53	-12.47	2.30991G	-53.65	2.4G	-50.50	2.4G	-53.39	2.50542G	-51.21	21.533G	-47.50	2
802.11g_Nss1,(6Mbps)_2TX	-	-	-	-	-	-	-	-	-	-	-	-	-	-	-
2412MHz	Pass	2.43574G	16.78	-13.22	1.83808G	-53.50	2.39992G	-28.66	2.4G	-28.20	2.50158G	-51.43	7.23795G	-37.29	1
2412MHz	Pass	2.43574G	16.78	-13.22	2.03846G	-54.06	2.39976G	-28.19	2.4G	-27.17	2.51014G	-51.24	7.23795G	-38.41	2
2437MHz	Pass	2.43574G	16.78	-13.22	1.74488G	-54.26	2.39968G	-42.01	2.4G	-42.16	2.5115G	-51.27	21.53862G	-47.75	1
2437MHz	Pass	2.43574G	16.78	-13.22	159.32M	-53.86	2.39704G	-41.39	2.4G	-41.64	2.50006G	-50.95	21.50771G	-46.45	2
2462MHz	Pass	2.43574G	16.78	-13.22	1.91963G	-54.02	2.39528G	-51.44	2.4G	-54.22	2.50918G	-51.65	21.95162G	-46.32	1
2462MHz	Pass	2.43574G	16.78	-13.22	1.89633G	-52.70	2.3956G	-51.11	2.4G	-52.43	2.51854G	-51.81	21.4459G	-46.11	2
802.11ax HEW20_Nss1,(MCS0)_2TX	-	-	-	-	-	-	-	-	-	-	-	-	-	-	-
2412MHz	Pass	2.44192G	16.51	-13.49	1.90332G	-53.15	2.39984G	-28.40	2.4G	-27.42	2.50998G	-51.38	7.23795G	-40.30	1
2412MHz	Pass	2.44192G	16.51	-13.49	2.13166G	-53.47	2.4G	-27.02	2.4G	-27.67	2.50198G	-52.32	7.22671G	-39.81	2
2437MHz	Pass	2.44192G	16.51	-13.49	1.86255G	-53.69	2.39872G	-45.19	2.4G	-45.40	2.50094G	-51.33	21.57233G	-46.48	1
2437MHz	Pass	2.44192G	16.51	-13.49	53.3M	-53.93	2.3996G	-41.95	2.4G	-43.77	2.50046G	-51.44	21.592G	-46.45	2
2462MHz	Pass	2.44192G	16.51	-13.49	2.30641G	-53.70	2.39128G	-50.60	2.4G	-54.53	2.50134G	-51.14	21.53581G	-47.43	1
2462MHz	Pass	2.44192G	16.51	-13.49	2.15147G	-53.04	2.39104G	-50.90	2.4G	-53.50	2.51806G	-51.23	21.4459G	-47.34	2
802.11ax HEW40_Nss1,(MCS0)_2TX	-	-	-	-	-	-	-	-	-	-	-	-	-	-	-
2422MHz	Pass	2.44576G	8.66	-21.34	32.29M	-53.39	2.39952G	-34.56	2.4G	-35.33	2.55934G	-54.11	7.24992G	-43.47	1
2422MHz	Pass	2.44576G	8.66	-21.34	30M	-53.57	2.4G	-34.03	2.4G	-34.73	2.5259G	-53.83	7.24712G	-44.72	2
2437MHz	Pass	2.44576G	8.66	-21.34	33.44M	-53.13	2.3984G	-33.99	2.4G	-34.07	2.5003G	-53.53	21.59526G	-46.52	1
2437MHz	Pass	2.44576G	8.66	-21.34	30M	-52.26	2.4G	-33.39	2.4G	-34.14	2.5003G	-53.87	21.49149G	-47.55	2
2452MHz	Pass	2.44576G	8.66	-21.34	102.14M	-53.12	2.39584G	-52.63	2.4G	-52.26	2.50654G	-54.35	21.48308G	-47.40	1
2452MHz	Pass	2.44576G	8.66	-21.34	1.62957G	-53.47	2.4G	-51.46	2.4G	-52.22	2.50046G	-54.17	21.57843G	-46.94	2

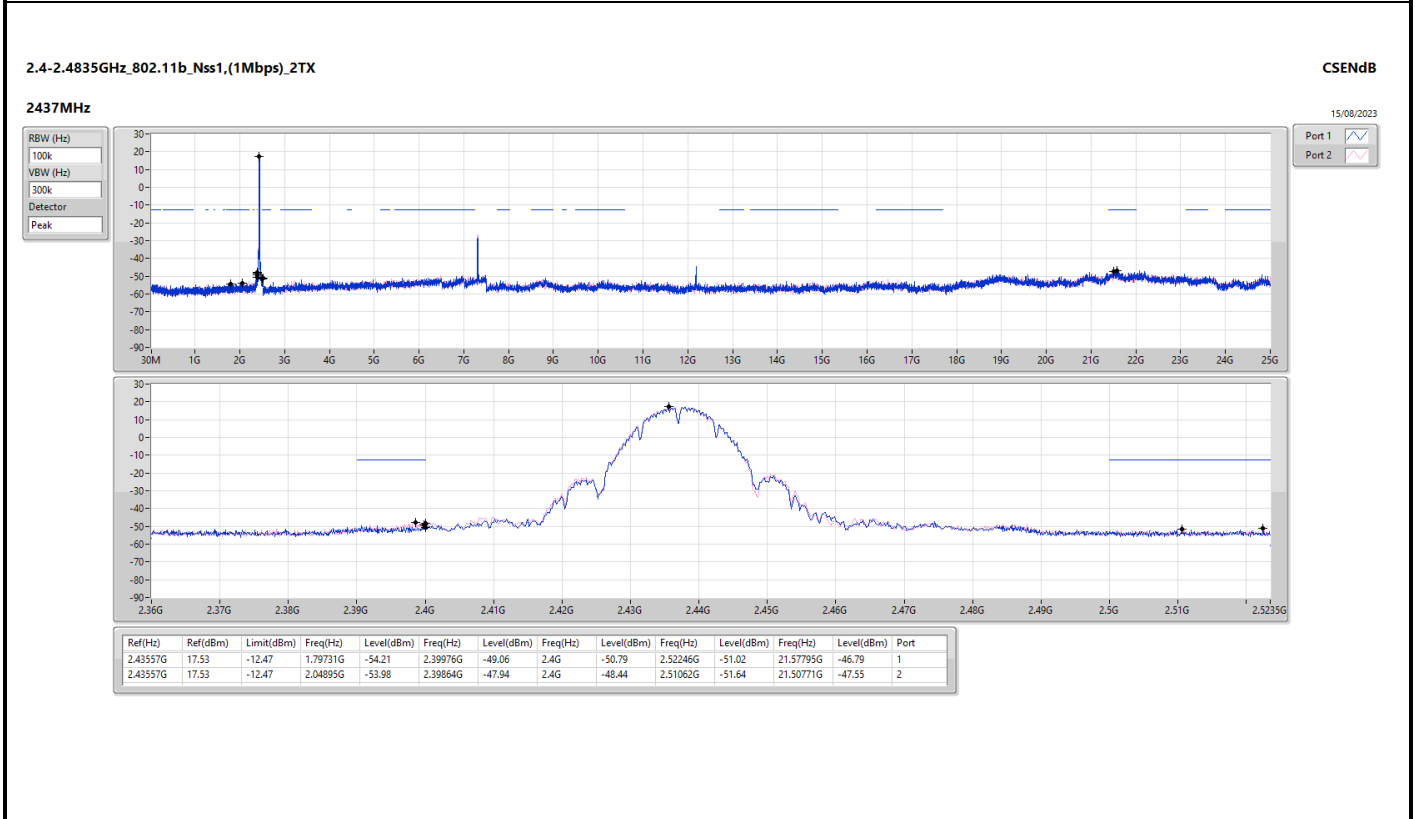
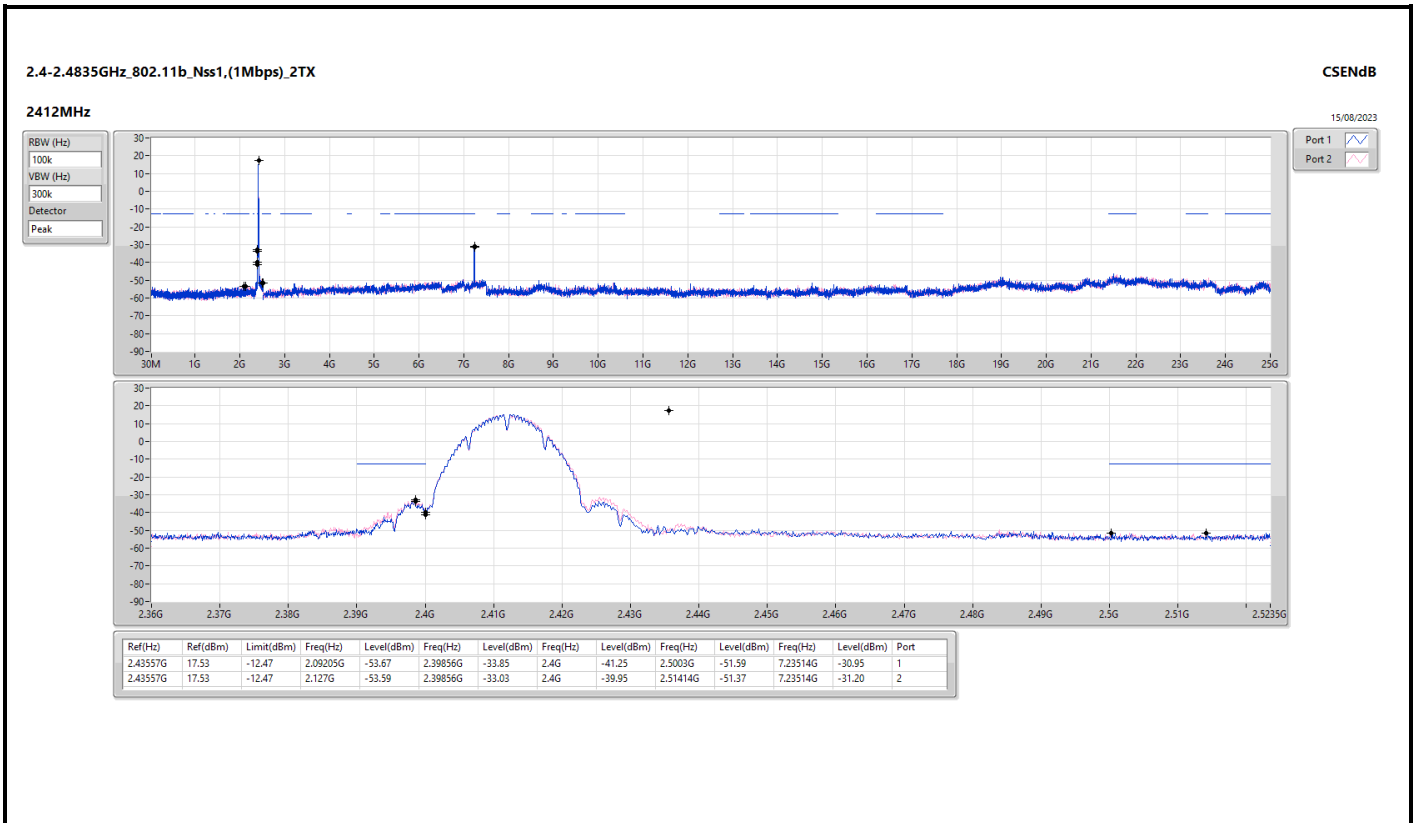

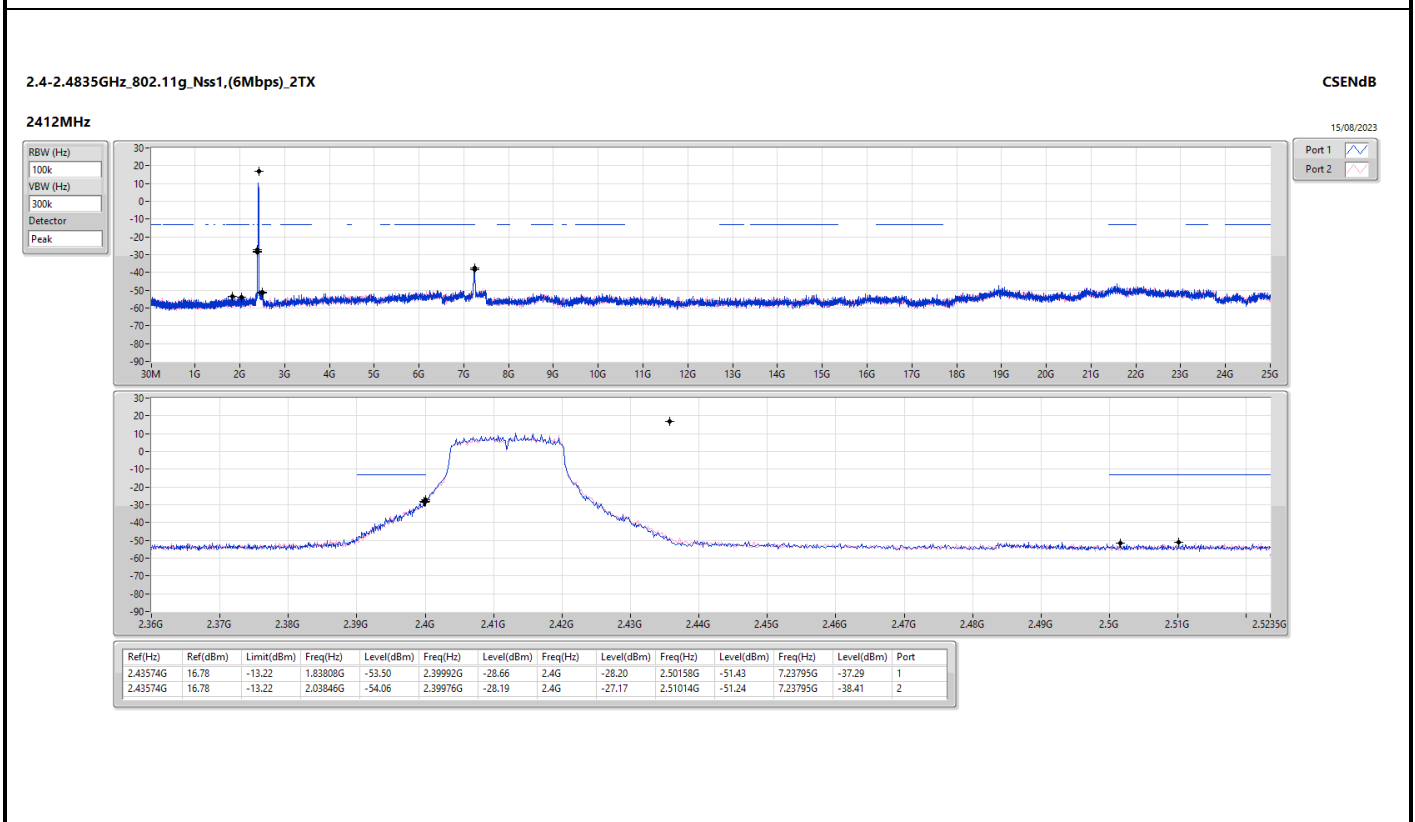
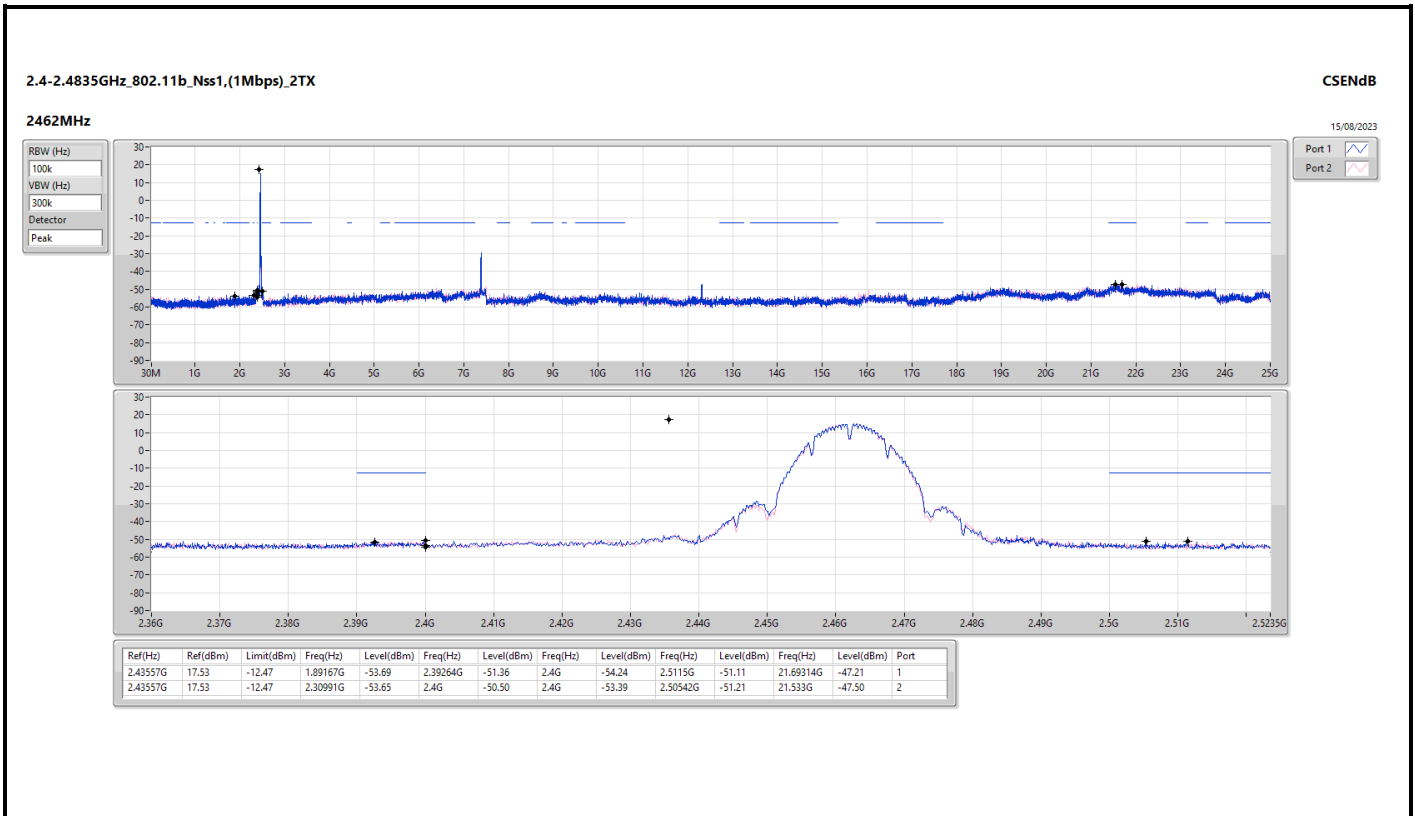

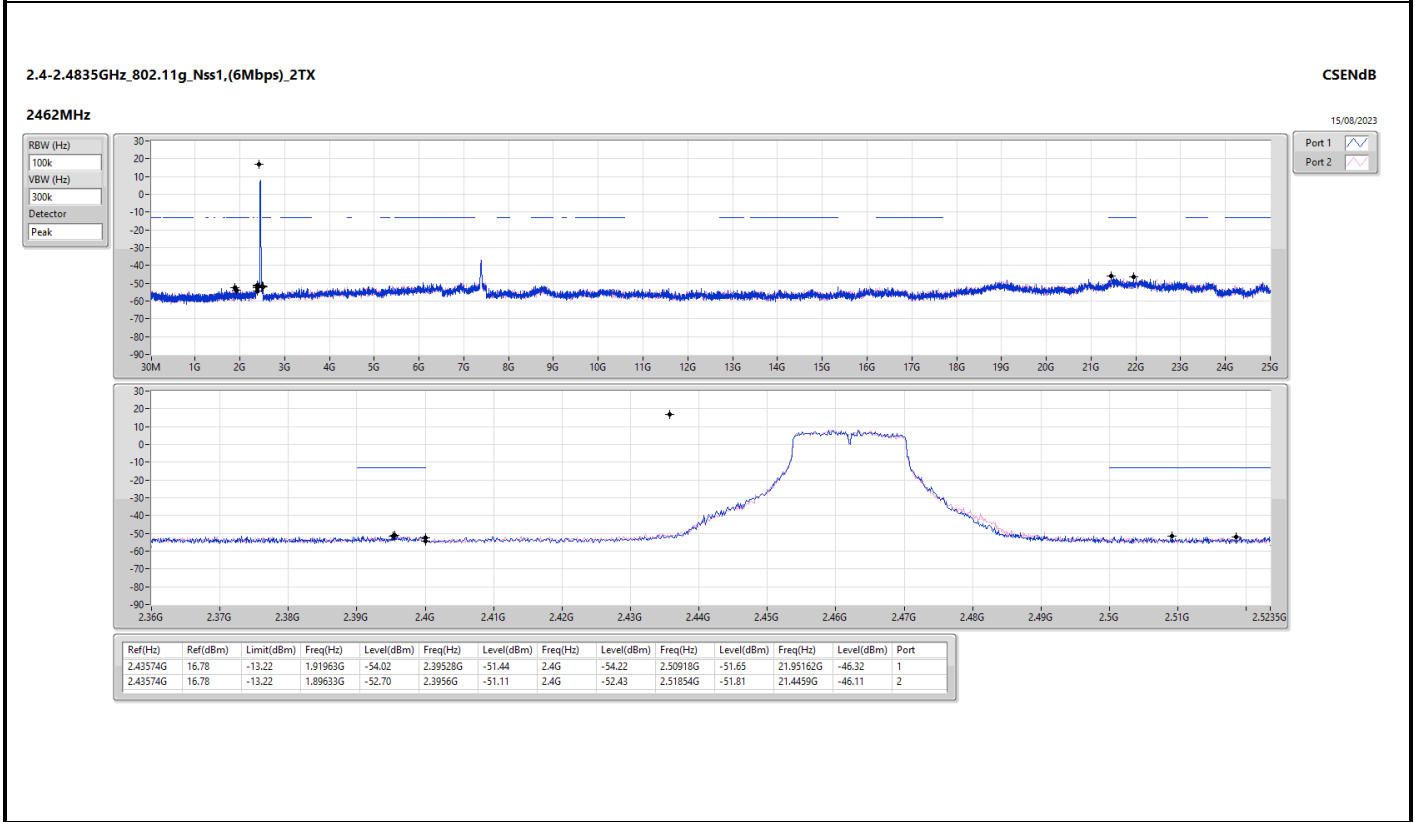
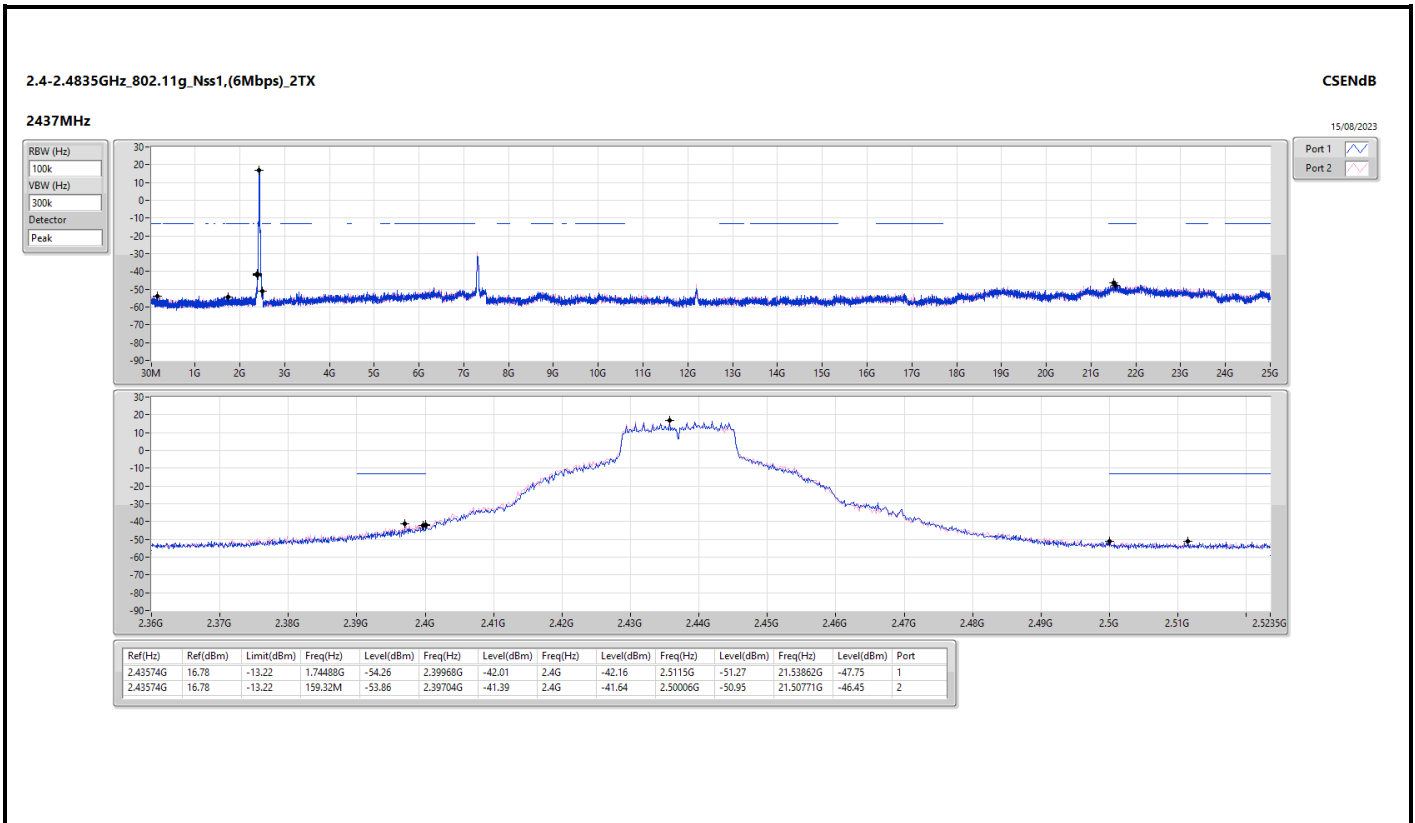

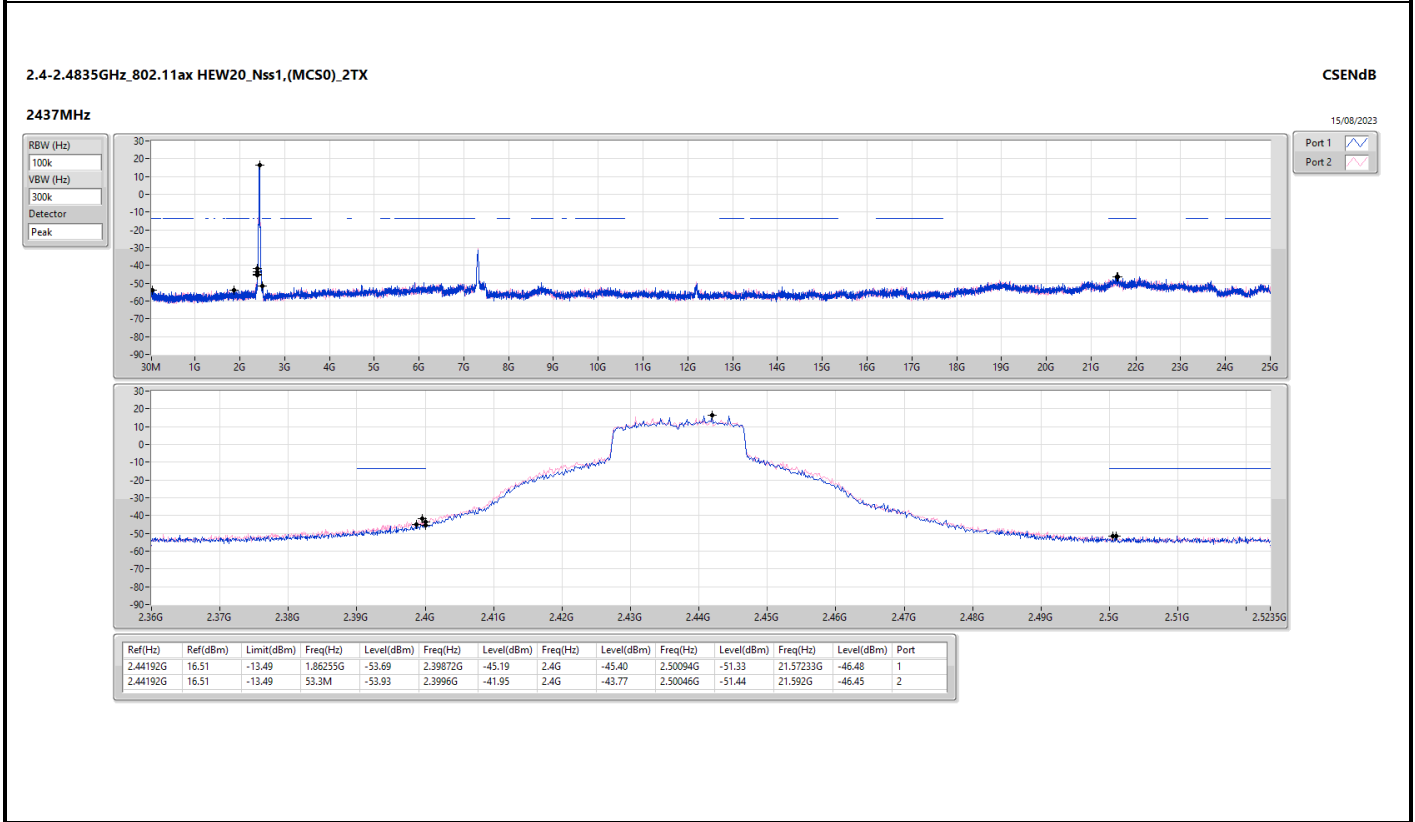
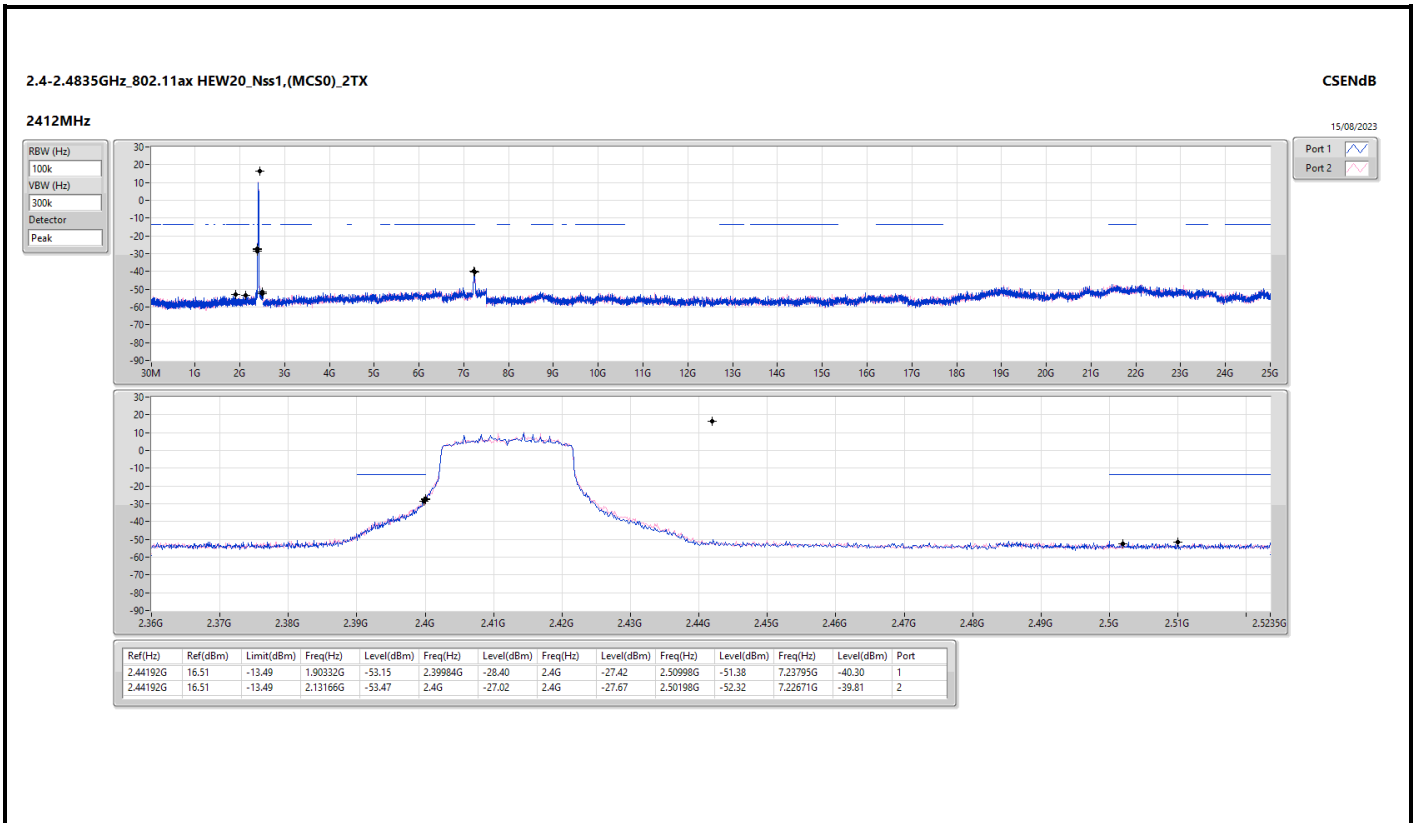

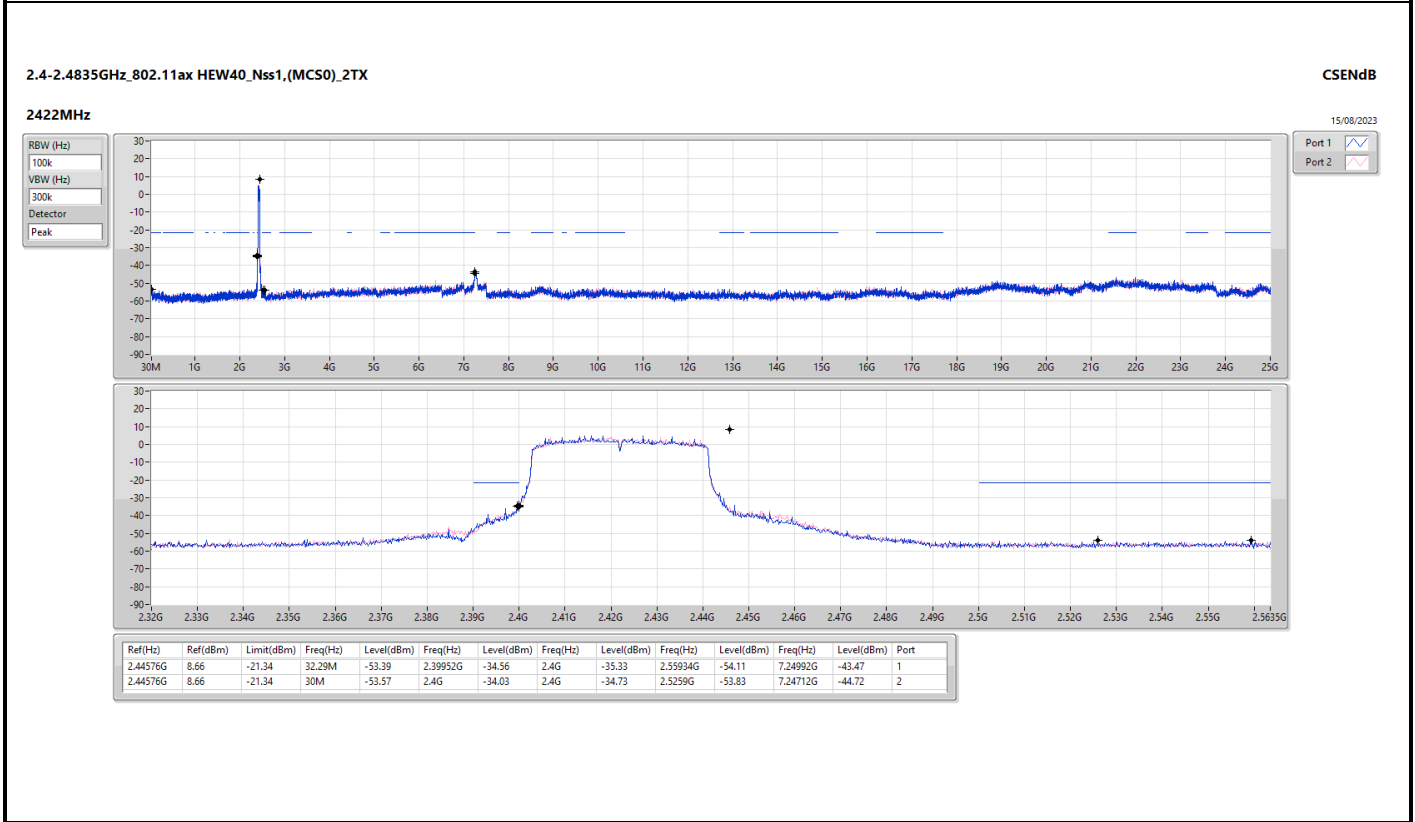
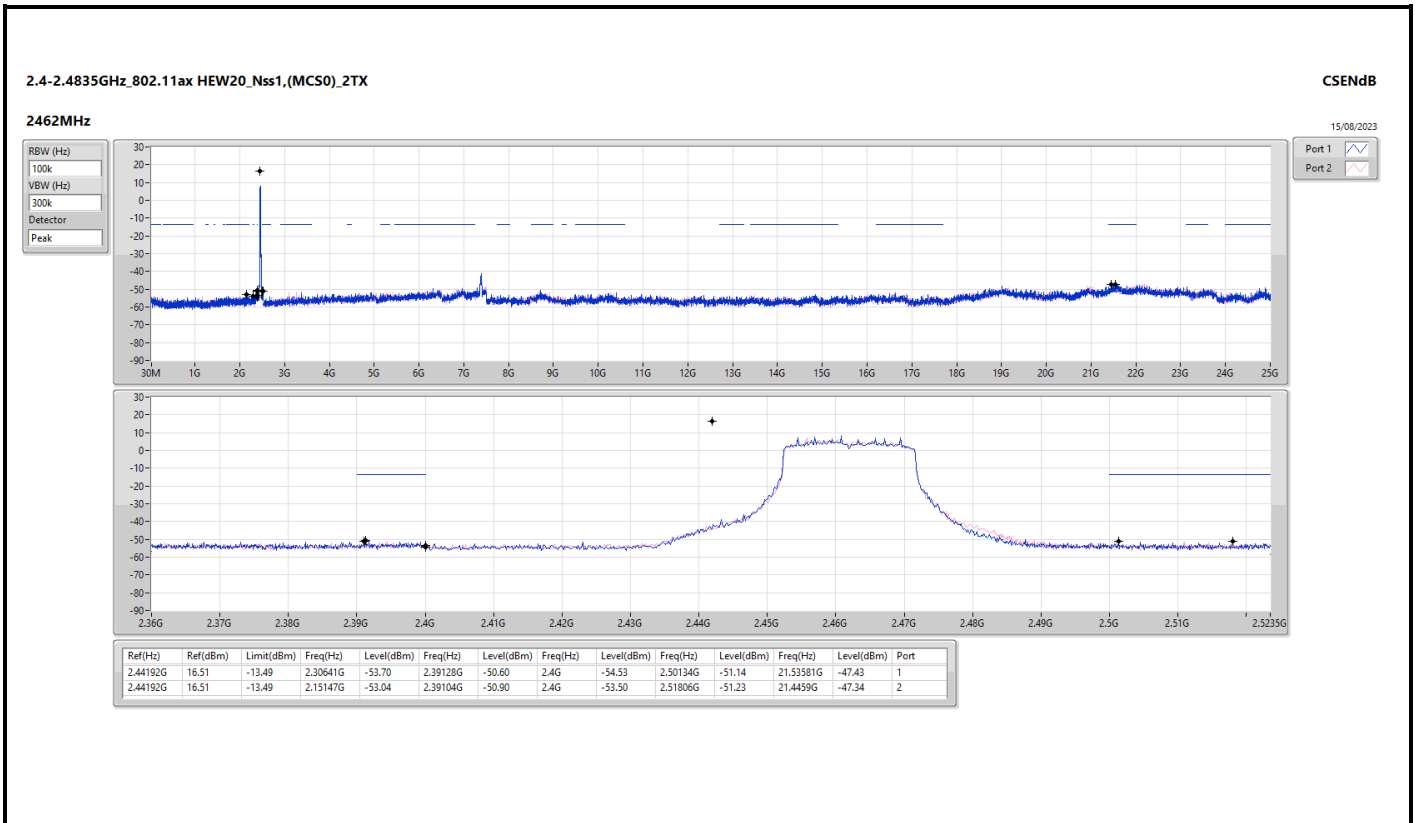

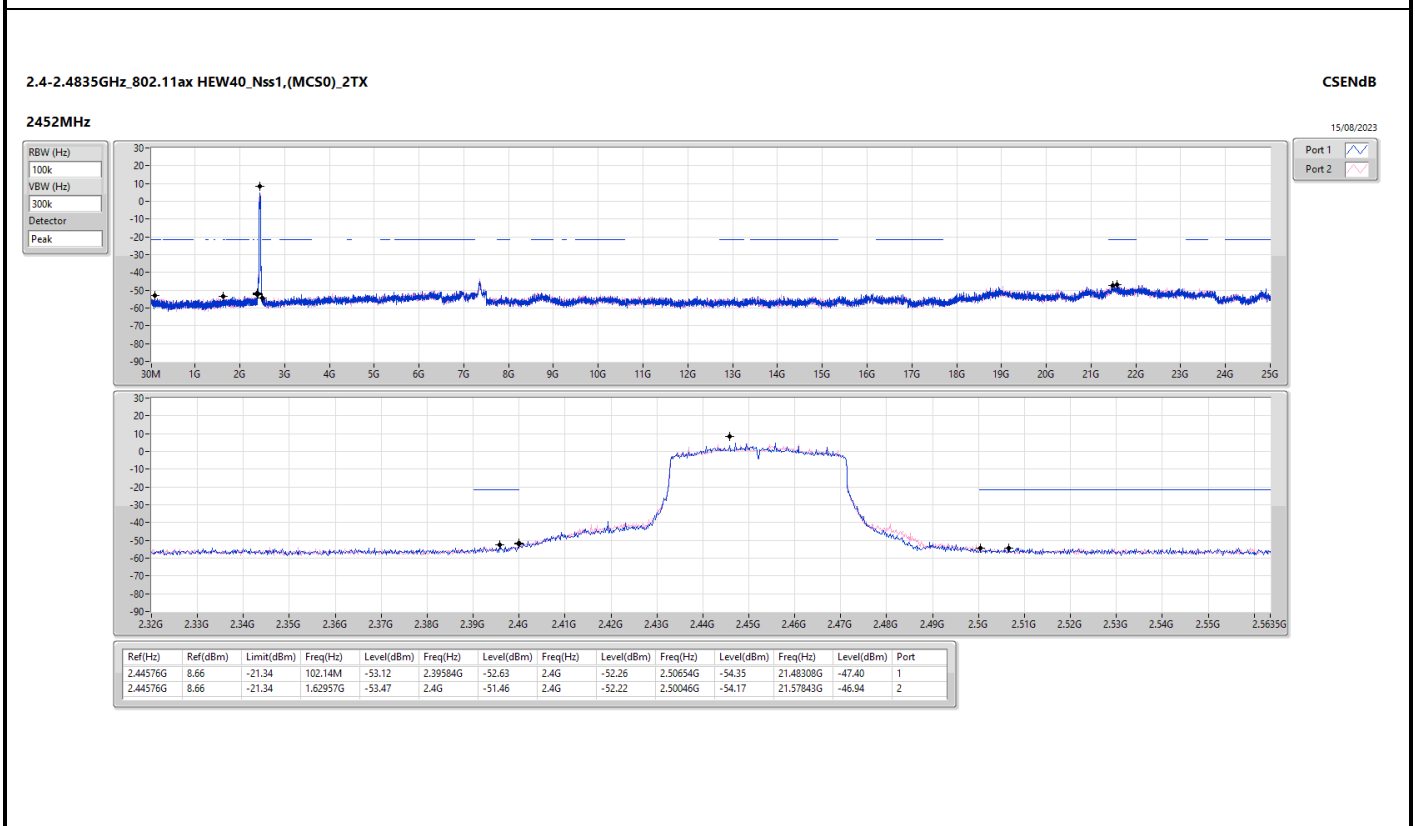
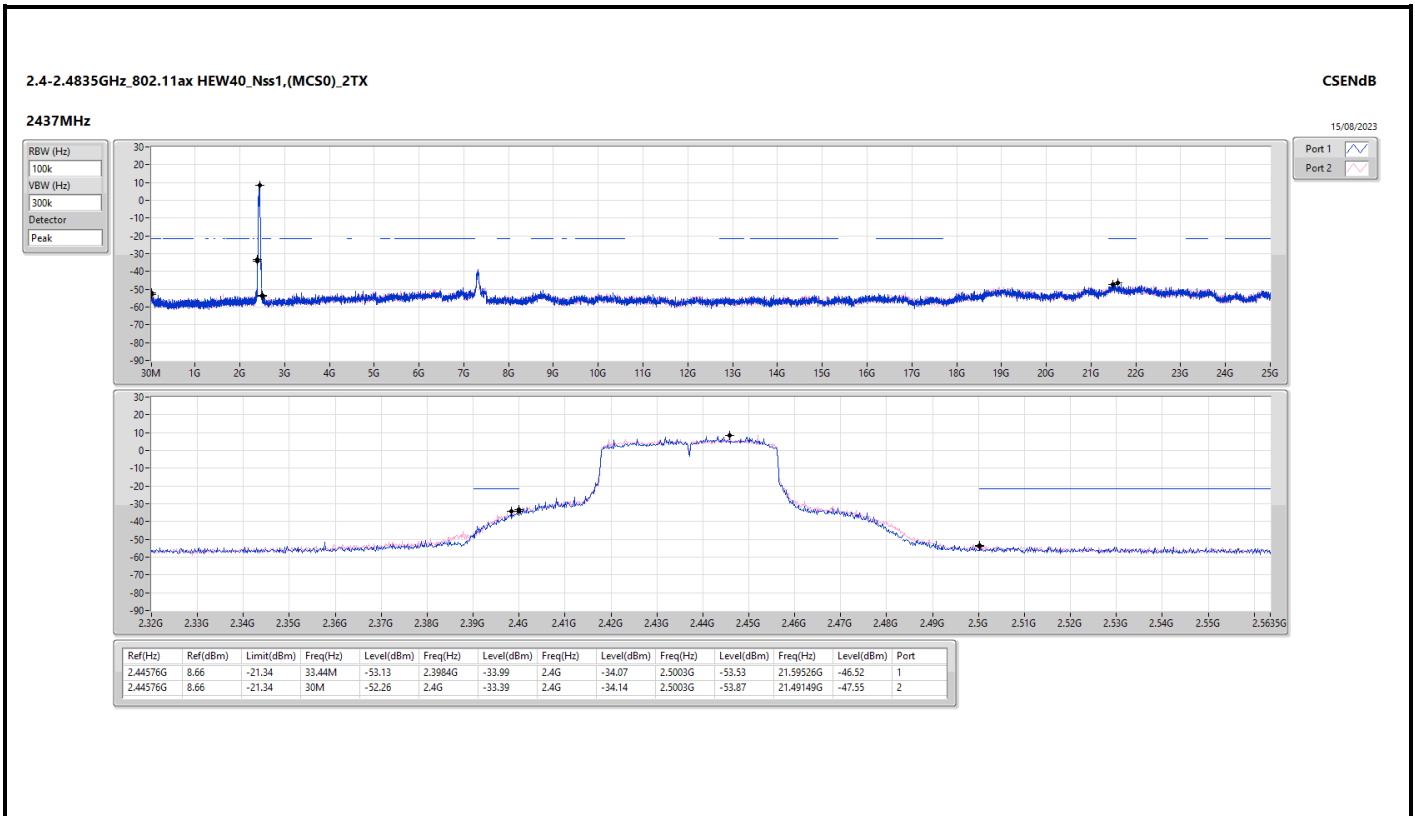



Summary

Mode	Result	Type	Freq (Hz)	Level (dBuV/m)	Limit (dBuV/m)	Margin (dB)	Condition
Mode 1	Pass	QP	36.40M	38.90	40.00	-1.10	Vertical

Mode 1

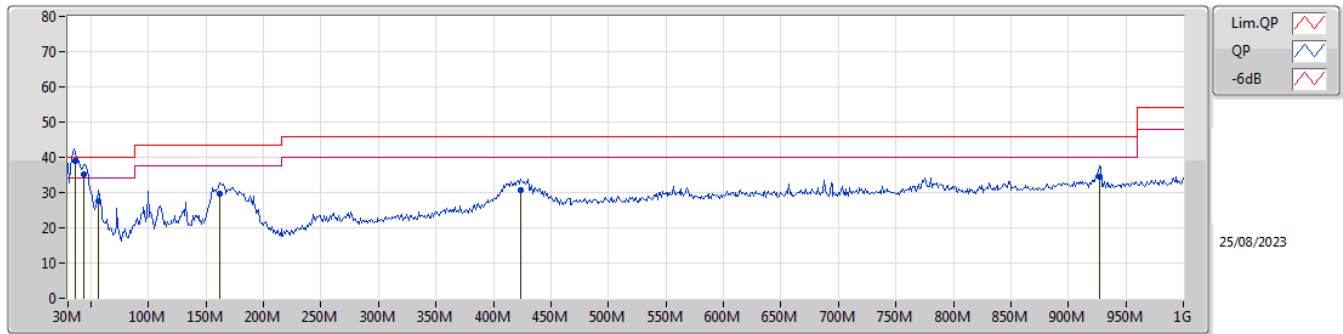

Type	Freq (Hz)	Level (dBuV/m)	Limit (dBuV/m)	Margin (dB)	Factor (dB/m)	Dist (m)	Condition	Azimuth (°)	Height (m)	Comment	Raw (dBuV/m)	AF (dB/m)	CL (dB)	PA (dB)
QP	36.40M	38.90	40.00	-1.10	-10.21	3	Vertical	254	1.00	"Worst"	49.11	20.87	1.00	32.08
QP	43.58M	35.04	40.00	-4.96	-13.71	3	Vertical	272	1.00	-	48.75	17.38	1.07	32.16
QP	56.19M	27.65	40.00	-12.35	-18.01	3	Vertical	178	1.00	-	45.66	13.11	1.10	32.22
QP	161.92M	29.81	43.50	-13.69	-14.21	3	Vertical	174	1.25	-	44.02	16.14	1.71	32.06
QP	423.82M	30.72	46.00	-15.28	-6.09	3	Vertical	281	1.25	-	36.81	22.53	2.85	31.47
QP	927.25M	34.55	46.00	-11.45	-0.05	3	Vertical	15	2.00	-	34.60	26.45	4.25	30.75

Mode 1

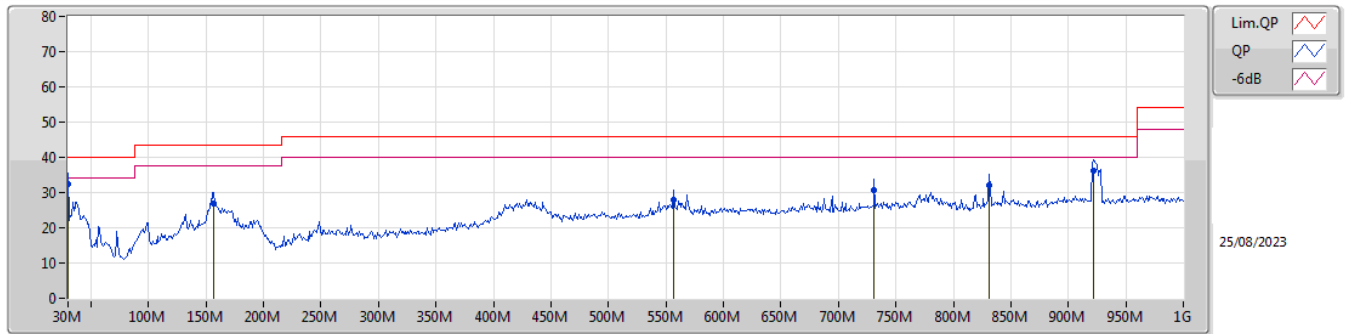

Type	Freq (Hz)	Level (dBuV/m)	Limit (dBuV/m)	Margin (dB)	Factor (dB/m)	Dist (m)	Condition	Azimuth (°)	Height (m)	Comment	Raw (dBuV/m)	AF (dB/m)	CL (dB)	PA (dB)
QP	30M	32.50	40.00	-7.50	-7.24	3	Horizontal	332	1.25	"Worst"	39.74	23.80	0.90	31.94
QP	157.07M	26.90	43.50	-16.60	-14.14	3	Horizontal	180	1.25	-	41.04	16.24	1.69	32.07
QP	556.71M	27.79	46.00	-18.21	-3.53	3	Horizontal	184	1.50	-	31.32	24.93	3.21	31.67
QP	731.31M	30.72	46.00	-15.28	-2.47	3	Horizontal	130	1.00	-	33.19	25.41	3.73	31.61
QP	831.22M	32.02	46.00	-13.98	-1.37	3	Horizontal	224	1.00	-	33.39	25.93	3.96	31.26
QP	922.4M	36.33	46.00	-9.67	-0.00	3	Horizontal	358	1.50	-	36.33	26.56	4.24	30.80



Summary

Mode	Result	Type	Freq (Hz)	Level (dBuV/m)	Limit (dBuV/m)	Margin (dB)	Dist (m)	Condition	Azimuth (°)	Height (m)	Comments
2.4-2.4835GHz	-	-	-	-	-	-	-	-	-	-	-
802.11b_Nss1,(1Mbps)_2TX	Pass	AV	2.4836G	53.99	54.00	-0.01	3	Vertical	7	1.75	-

2.4-2.4835GHz_802.11b_Nss1,(1Mbps)_2TX

2412MHz_TX

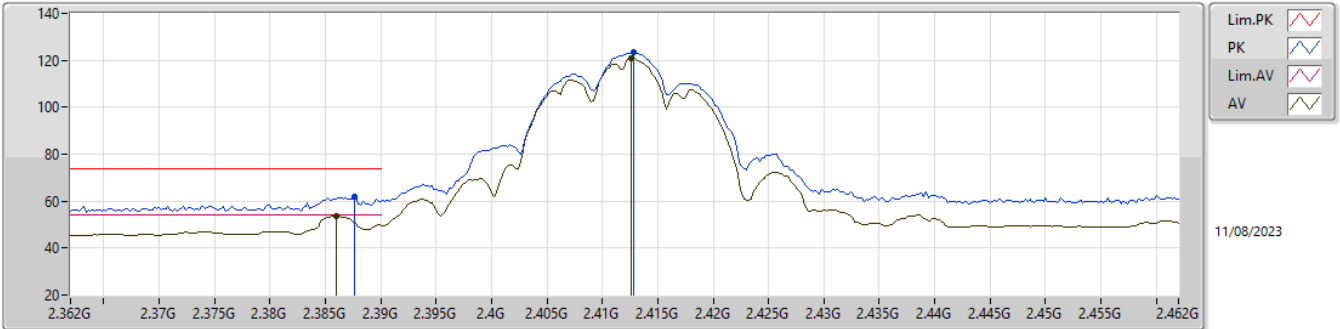

EUT_Y_2TX
Setting 24.5
04-M-M-2

Type	Freq (Hz)	Level (dBuV/m)	Limit (dBuV/m)	Margin (dB)	Raw (dBuV)	Dist (m)	Condition	Azimuth (°)	Height (m)	Comment	AF (dB)	CL (dB)	PA (dB)
PK	2.3876G	61.71	74.00	-12.29	30.89	3	Vertical	350	1.93	-	27.63	3.19	-
AV	2.386G	53.71	54.00	-0.29	22.90	3	Vertical	350	1.93	-	27.62	3.19	-
PK	2.4128G	123.35	Inf	-Inf	92.44	3	Vertical	350	1.93	-	27.70	3.21	-
AV	2.4126G	120.85	Inf	-Inf	89.94	3	Vertical	350	1.93	-	27.70	3.21	-

2.4-2.4835GHz_802.11b_Nss1,(1Mbps)_2TX

2412MHz_TX

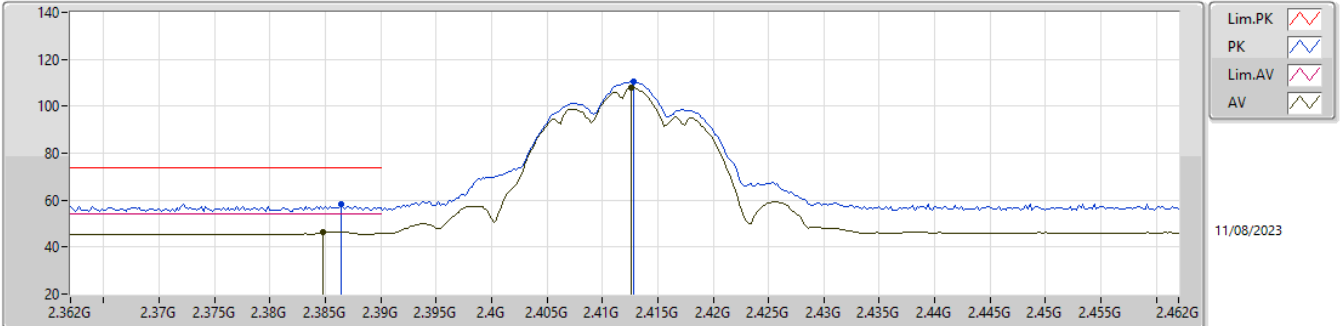

EUT_Y_2TX
 Setting 24.5
 04-M-M-2

Type	Freq (Hz)	Level (dBuV/m)	Limit (dBuV/m)	Margin (dB)	Raw (dBuV)	Dist (m)	Condition	Azimuth (°)	Height (m)	Comment	AF (dB)	CL (dB)	PA (dB)
PK	2.3864G	58.23	74.00	-15.77	27.42	3	Horizontal	40	1.02	-	27.62	3.19	-
AV	2.3848G	46.59	54.00	-7.41	15.79	3	Horizontal	40	1.02	-	27.61	3.19	-
PK	2.4128G	110.62	Inf	-Inf	79.71	3	Horizontal	40	1.02	-	27.70	3.21	-
AV	2.4126G	108.13	Inf	-Inf	77.22	3	Horizontal	40	1.02	-	27.70	3.21	-

2.4-2.4835GHz_802.11b_Nss1,(1Mbps)_2TX

2412MHz_TX

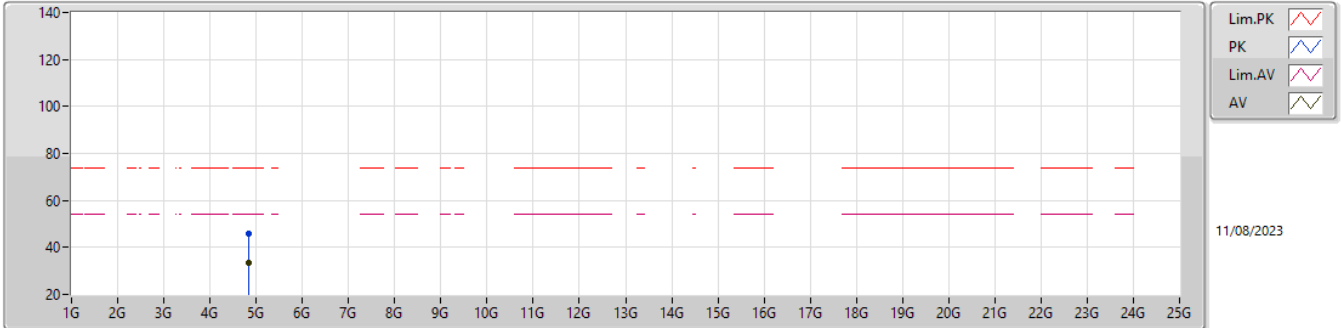

EUT_Y_2TX
 Setting 24.5
 04-M-M-2

Type	Freq (Hz)	Level (dBuV/m)	Limit (dBuV/m)	Margin (dB)	Raw (dBuV)	Dist (m)	Condition	Azimuth (°)	Height (m)	Comment	AF (dB)	CL (dB)	PA (dB)
PK	4.83348G	45.87	74.00	-28.13	40.50	3	Vertical	43	2.35	-	32.67	5.30	32.60
AV	4.82752G	33.21	54.00	-20.79	27.87	3	Vertical	43	2.35	-	32.66	5.30	32.62

2.4-2.4835GHz_802.11b_Nss1,(1Mbps)_2TX

2412MHz_TX

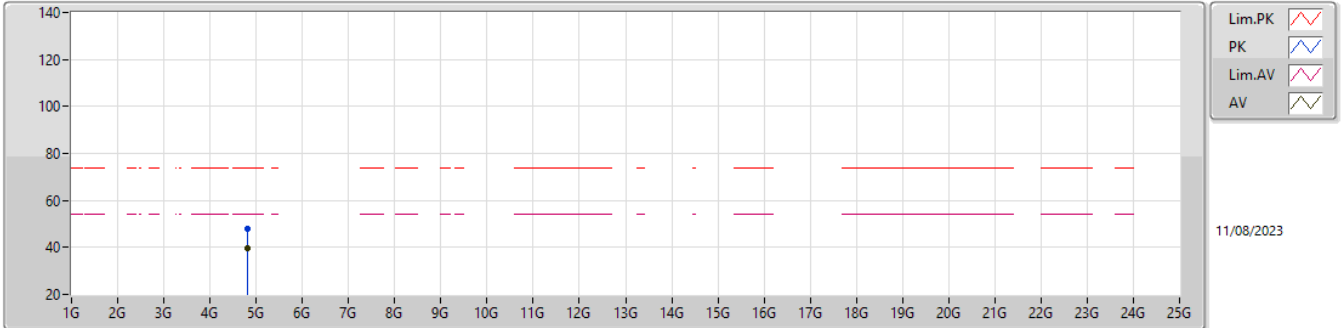

EUT_Y_2TX
 Setting 24.5
 04-M-M-2

Type	Freq	Level	Limit	Margin	Raw	Dist	Condition	Azimuth	Height	Comment	AF	CL	PA			
	(Hz)	(dBuV/m)	(dBuV/m)	(dB)	(dBuV)	(m)		(°)	(m)		(dB)	(dB)	(dB)			
PK	4.82416G	47.82	74.00	-26.18	42.49	3	Horizontal	54	1.96	-	32.65	5.30	32.62			
AV	4.8238G	39.89	54.00	-14.11	34.57	3	Horizontal	54	1.96	-	32.65	5.30	32.63			

2.4-2.4835GHz_802.11b_Nss1,(1Mbps)_2TX

2417MHz_TX

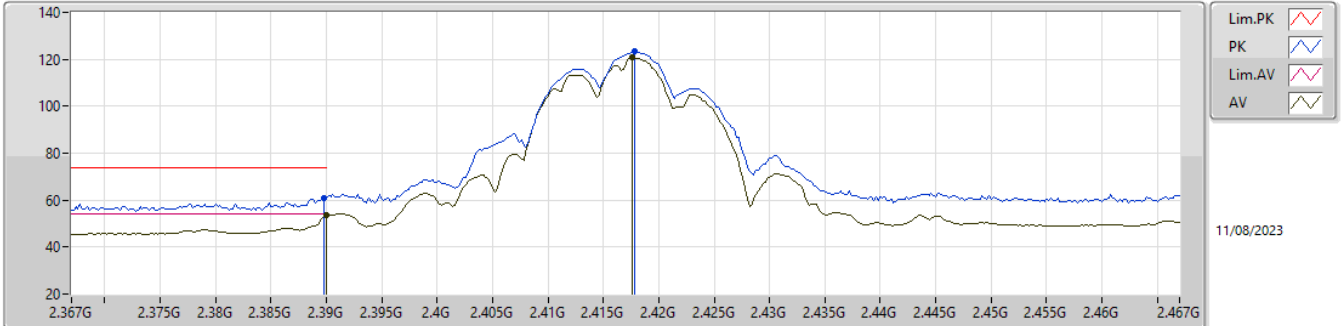

EUT_Y_2TX
 Setting 24.5
 04-M-M-2

Type	Freq (Hz)	Level (dBuV/m)	Limit (dBuV/m)	Margin (dB)	Raw (dBuV)	Dist (m)	Condition	Azimuth (°)	Height (m)	Comment	AF (dB)	CL (dB)	PA (dB)
PK	2.3898G	60.98	74.00	-13.02	30.15	3	Vertical	354	1.92	-	27.64	3.19	-
AV	2.39G	53.39	54.00	-0.61	22.55	3	Vertical	354	1.92	-	27.64	3.20	-
PK	2.4178G	123.26	Inf	-Inf	92.34	3	Vertical	354	1.92	-	27.70	3.22	-
AV	2.4176G	120.71	Inf	-Inf	89.79	3	Vertical	354	1.92	-	27.70	3.22	-

2.4-2.4835GHz_802.11b_Nss1,(1Mbps)_2TX

2417MHz_TX

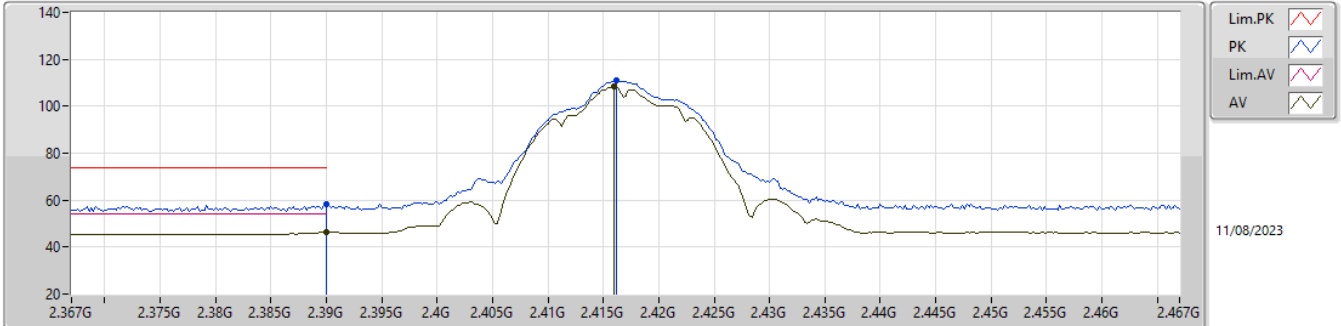

EUT_Y_2TX
 Setting 24.5
 04-M-M-2

Type	Freq (Hz)	Level (dBuV/m)	Limit (dBuV/m)	Margin (dB)	Raw (dBuV)	Dist (m)	Condition	Azimuth (°)	Height (m)	Comment	AF (dB)	CL (dB)	PA (dB)
PK	2.39G	58.05	74.00	-15.95	27.21	3	Horizontal	24	1.01	-	27.64	3.20	-
AV	2.39G	46.59	54.00	-7.41	15.75	3	Horizontal	24	1.01	-	27.64	3.20	-
PK	2.4162G	111.00	Inf	-Inf	80.08	3	Horizontal	24	1.01	-	27.70	3.22	-
AV	2.416G	108.52	Inf	-Inf	77.60	3	Horizontal	24	1.01	-	27.70	3.22	-

2.4-2.4835GHz_802.11b_Nss1,(1Mbps)_2TX

2437MHz_TX

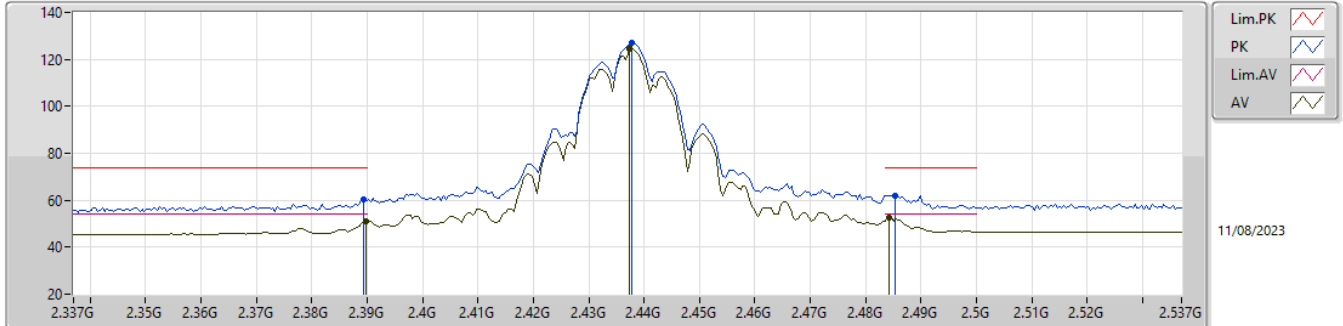

EUT_Y_2TX
Setting 27.5
04-M-M-2

Type	Freq (Hz)	Level (dBuV/m)	Limit (dBuV/m)	Margin (dB)	Raw (dBuV)	Dist (m)	Condition	Azimuth (°)	Height (m)	Comment	AF (dB)	CL (dB)	PA (dB)
PK	2.3894G	60.24	74.00	-13.76	29.41	3	Vertical	15	1.64	-	27.64	3.19	-
AV	2.3898G	50.92	54.00	-3.08	20.09	3	Vertical	15	1.64	-	27.64	3.19	-
PK	2.4378G	126.87	Inf	-Inf	95.93	3	Vertical	15	1.64	-	27.70	3.24	-
AV	2.4374G	124.33	Inf	-Inf	93.39	3	Vertical	15	1.64	-	27.70	3.24	-
PK	2.4854G	62.00	74.00	-12.00	30.87	3	Vertical	15	1.64	-	27.84	3.29	-
AV	2.4842G	52.49	54.00	-1.51	21.37	3	Vertical	15	1.64	-	27.84	3.28	-

2.4-2.4835GHz_802.11b_Nss1,(1Mbps)_2TX

2437MHz_TX

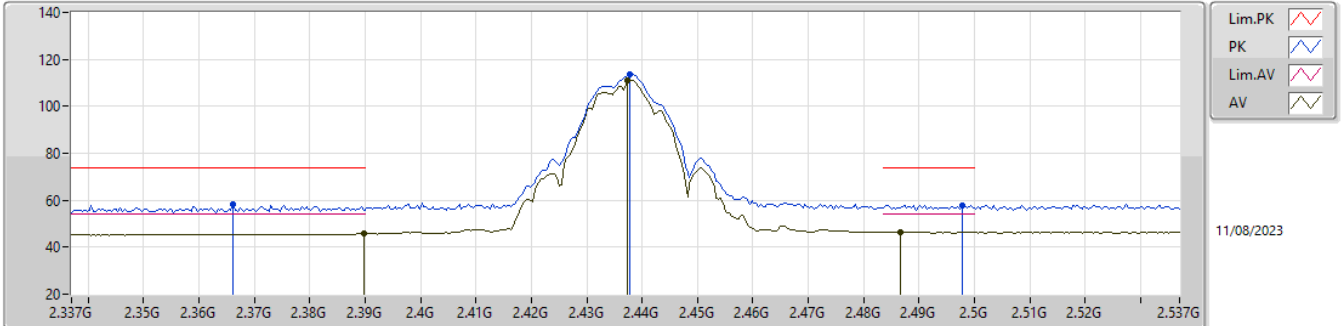

EUT_Y_2TX
 Setting 27.5
 04-M-M-2

Type	Freq (Hz)	Level (dBuV/m)	Limit (dBuV/m)	Margin (dB)	Raw (dBuV)	Dist (m)	Condition	Azimuth (°)	Height (m)	Comment	AF (dB)	CL (dB)	PA (dB)
PK	2.3662G	58.33	74.00	-15.67	27.65	3	Horizontal	17	1.64	-	27.50	3.18	-
AV	2.3898G	46.10	54.00	-7.90	15.27	3	Horizontal	17	1.64	-	27.64	3.19	-
PK	2.4378G	113.70	Inf	-Inf	82.76	3	Horizontal	17	1.64	-	27.70	3.24	-
AV	2.4374G	111.09	Inf	-Inf	80.15	3	Horizontal	17	1.64	-	27.70	3.24	-
PK	2.4978G	58.00	74.00	-16.00	26.81	3	Horizontal	17	1.64	-	27.89	3.30	-
AV	2.4866G	46.48	54.00	-7.52	15.34	3	Horizontal	17	1.64	-	27.85	3.29	-

2.4-2.4835GHz_802.11b_Nss1,(1Mbps)_2TX

2437MHz_TX

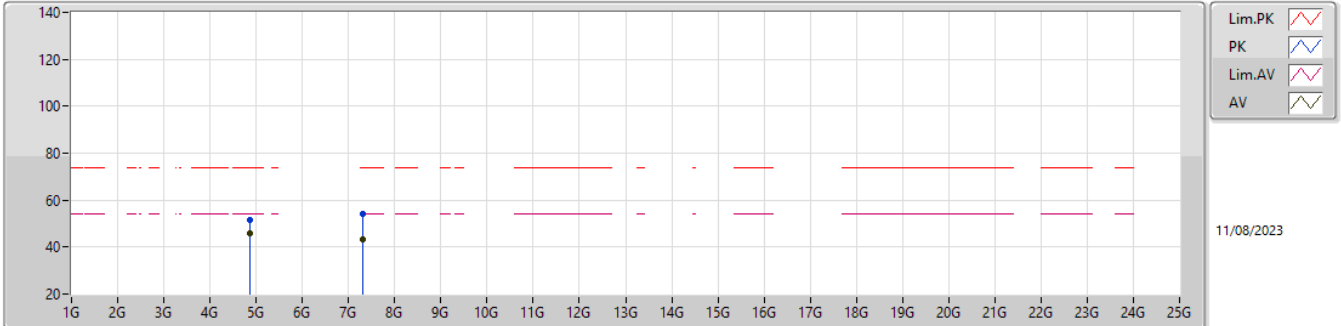

EUT_Y_2TX
 Setting 27.5
 04-M-M-2

Type	Freq (Hz)	Level (dBuV/m)	Limit (dBuV/m)	Margin (dB)	Raw (dBuV)	Dist (m)	Condition	Azimuth (°)	Height (m)	Comment	AF (dB)	CL (dB)	PA (dB)
PK	4.87408G	51.58	74.00	-22.42	46.04	3	Vertical	56	1.89	-	32.75	5.30	32.51
AV	4.87376G	45.75	54.00	-8.25	40.21	3	Vertical	56	1.89	-	32.75	5.30	32.51
PK	7.31136G	53.89	74.00	-20.11	43.37	3	Vertical	134	2.19	-	37.70	6.91	34.09
AV	7.3116G	43.34	54.00	-10.66	32.82	3	Vertical	134	2.19	-	37.70	6.91	34.09

2.4-2.4835GHz_802.11b_Nss1,(1Mbps)_2TX

2437MHz_TX

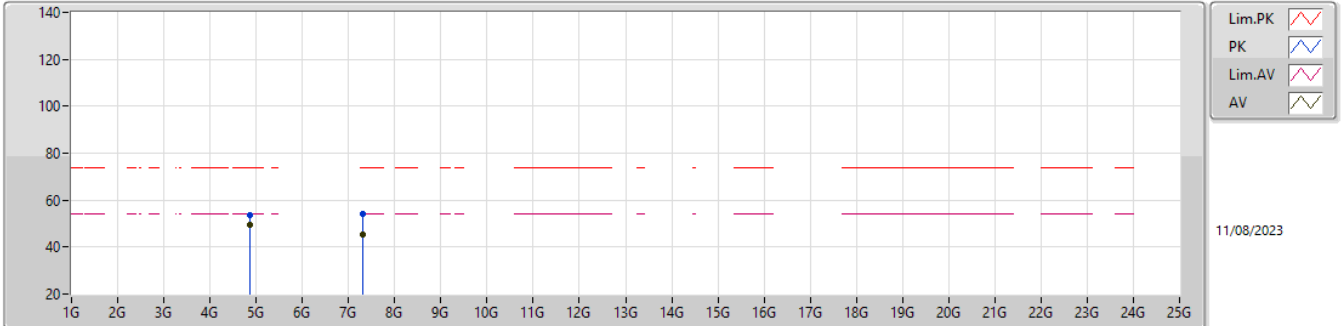

EUT_Y_2TX
 Setting 27.5
 04-M-M-2

Type	Freq (Hz)	Level (dBuV/m)	Limit (dBuV/m)	Margin (dB)	Raw (dBuV)	Dist (m)	Condition	Azimuth (°)	Height (m)	Comment	AF (dB)	CL (dB)	PA (dB)
PK	4.87412G	53.47	74.00	-20.53	47.93	3	Horizontal	146	1.67	-	32.75	5.30	32.51
AV	4.8738G	49.67	54.00	-4.33	44.13	3	Horizontal	146	1.67	-	32.75	5.30	32.51
PK	7.31204G	54.26	74.00	-19.74	43.74	3	Horizontal	223	1.70	-	37.70	6.91	34.09
AV	7.3116G	45.39	54.00	-8.61	34.87	3	Horizontal	223	1.70	-	37.70	6.91	34.09

2.4-2.4835GHz_802.11b_Nss1,(1Mbps)_2TX

2457MHz_TX

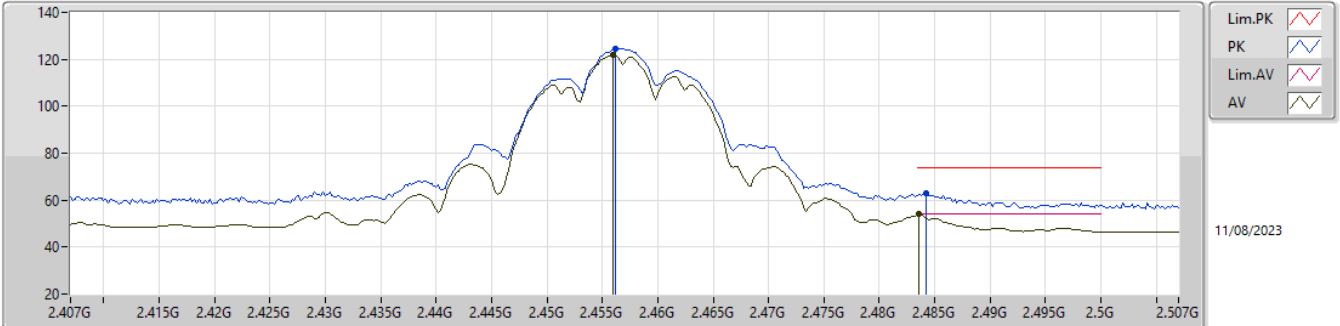

EUT_Y_2TX
Setting 25
04-M-M-2

Type	Freq (Hz)	Level (dBuV/m)	Limit (dBuV/m)	Margin (dB)	Raw (dBuV)	Dist (m)	Condition	Azimuth (°)	Height (m)	Comment	AF (dB)	CL (dB)	PA (dB)
PK	2.4562G	124.53	Inf	-Inf	93.55	3	Vertical	7	1.75	-	27.72	3.26	-
AV	2.456G	122.11	Inf	-Inf	91.13	3	Vertical	7	1.75	-	27.72	3.26	-
PK	2.4842G	62.88	74.00	-11.12	31.76	3	Vertical	7	1.75	-	27.84	3.28	-
AV	2.4836G	53.99	54.00	-0.01	22.88	3	Vertical	7	1.75	-	27.83	3.28	-

2.4-2.4835GHz_802.11b_Nss1,(1Mbps)_2TX

2457MHz_TX

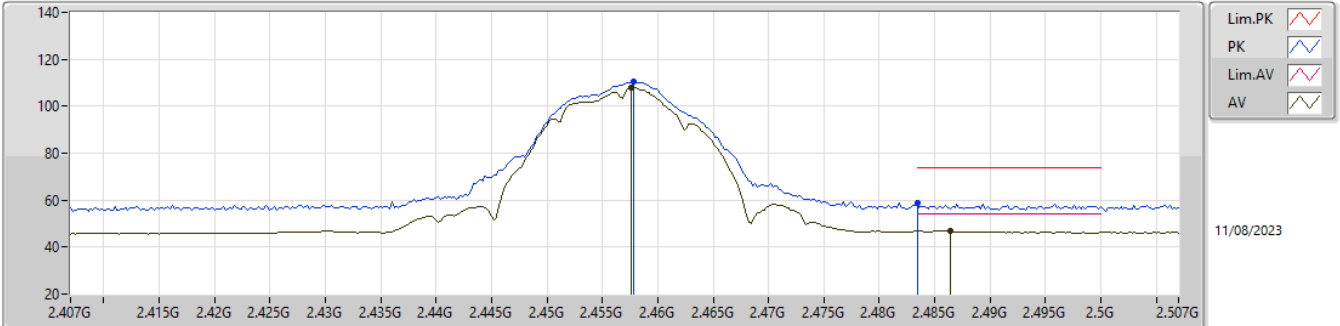

EUT_Y_2TX
Setting 25
04-M-M-2

Type	Freq (Hz)	Level (dBuV/m)	Limit (dBuV/m)	Margin (dB)	Raw (dBuV)	Dist (m)	Condition	Azimuth (°)	Height (m)	Comment	AF (dB)	CL (dB)	PA (dB)
PK	2.4578G	110.58	Inf	-Inf	79.59	3	Horizontal	19	1.62	-	27.73	3.26	-
AV	2.4576G	108.03	Inf	-Inf	77.04	3	Horizontal	19	1.62	-	27.73	3.26	-
PK	2.4835G	58.65	74.00	-15.35	27.54	3	Horizontal	19	1.62	-	27.83	3.28	-
AV	2.4864G	46.74	54.00	-7.26	15.60	3	Horizontal	19	1.62	-	27.85	3.29	-

2.4-2.4835GHz_802.11b_Nss1,(1Mbps)_2TX

2462MHz_TX

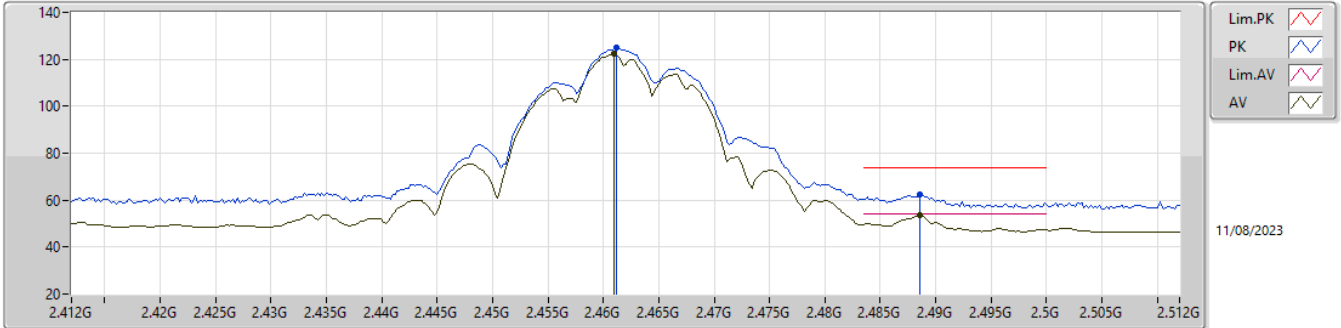

EUT_Y_2TX
 Setting 24.5
 04-M-M-2

Type	Freq (Hz)	Level (dBuV/m)	Limit (dBuV/m)	Margin (dB)	Raw (dBuV)	Dist (m)	Condition	Azimuth (°)	Height (m)	Comment	AF (dB)	CL (dB)	PA (dB)
PK	2.4612G	124.76	Inf	-Inf	93.76	3	Vertical	5	1.88	-	27.74	3.26	-
AV	2.461G	122.22	Inf	-Inf	91.22	3	Vertical	5	1.88	-	27.74	3.26	-
PK	2.4886G	62.66	74.00	-11.34	31.52	3	Vertical	5	1.88	-	27.85	3.29	-
AV	2.4886G	53.58	54.00	-0.42	22.44	3	Vertical	5	1.88	-	27.85	3.29	-

2.4-2.4835GHz_802.11b_Nss1,(1Mbps)_2TX

2462MHz_TX

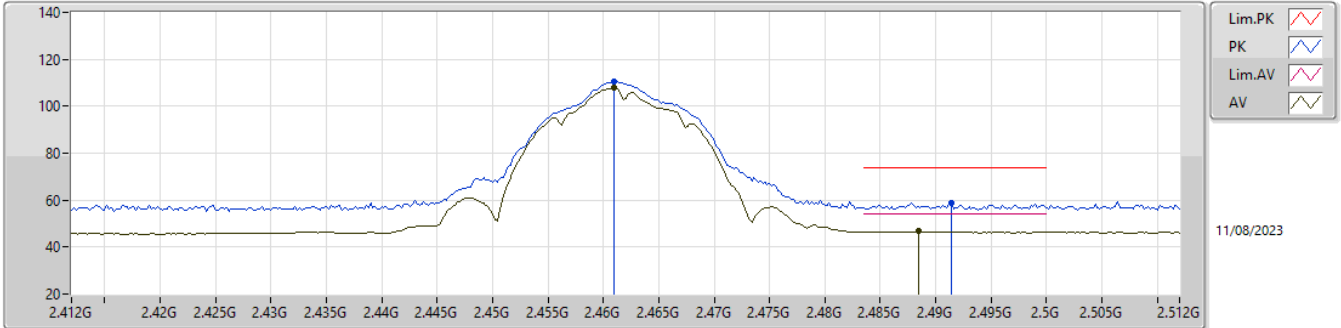

EUT_Y_2TX
 Setting 24.5
 04-M-M-2

Type	Freq (Hz)	Level (dBuV/m)	Limit (dBuV/m)	Margin (dB)	Raw (dBuV)	Dist (m)	Condition	Azimuth (°)	Height (m)	Comment	AF (dB)	CL (dB)	PA (dB)
PK	2.461G	110.46	Inf	-Inf	79.46	3	Horizontal	24	2.42	-	27.74	3.26	-
AV	2.461G	107.90	Inf	-Inf	76.90	3	Horizontal	24	2.42	-	27.74	3.26	-
PK	2.4914G	58.82	74.00	-15.18	27.66	3	Horizontal	24	2.42	-	27.87	3.29	-
AV	2.4884G	46.73	54.00	-7.27	15.59	3	Horizontal	24	2.42	-	27.85	3.29	-

2.4-2.4835GHz_802.11b_Nss1,(1Mbps)_2TX

2462MHz_TX

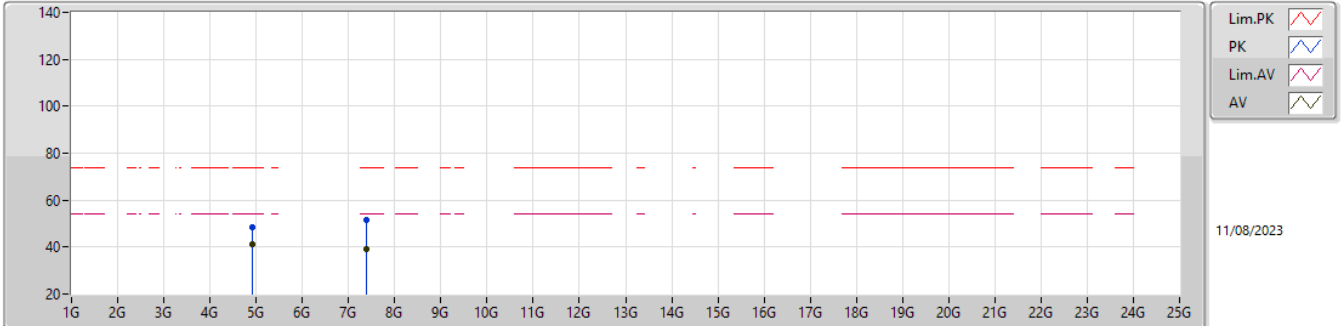

EUT_Y_2TX
 Setting 24.5
 04-M-M-2

Type	Freq (Hz)	Level (dBuV/m)	Limit (dBuV/m)	Margin (dB)	Raw (dBuV)	Dist (m)	Condition	Azimuth (°)	Height (m)	Comment	AF (dB)	CL (dB)	PA (dB)
PK	4.924G	48.49	74.00	-25.51	42.73	3	Vertical	16	1.85	-	32.85	5.30	32.39
AV	4.9238G	41.23	54.00	-12.77	35.47	3	Vertical	16	1.85	-	32.85	5.30	32.39
PK	7.38272G	51.44	74.00	-22.56	41.01	3	Vertical	1	1.27	-	37.57	6.98	34.12
AV	7.39328G	38.91	54.00	-15.09	28.52	3	Vertical	1	1.27	-	37.53	6.99	34.13

2.4-2.4835GHz_802.11b_Nss1,(1Mbps)_2TX

2462MHz_TX

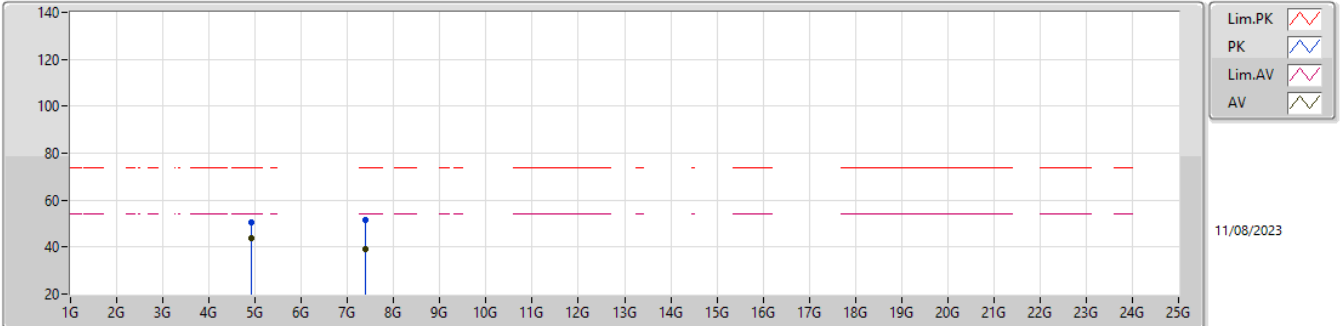

EUT_Y_2TX
 Setting 24.5
 04-M-M-2

Type	Freq (Hz)	Level (dBuV/m)	Limit (dBuV/m)	Margin (dB)	Raw (dBuV)	Dist (m)	Condition	Azimuth (°)	Height (m)	Comment	AF (dB)	CL (dB)	PA (dB)
PK	4.92388G	50.30	74.00	-23.70	44.54	3	Horizontal	334	1.94	-	32.85	5.30	32.39
AV	4.92376G	43.62	54.00	-10.38	37.86	3	Horizontal	334	1.94	-	32.85	5.30	32.39
PK	7.39108G	51.32	74.00	-22.68	40.92	3	Horizontal	292	2.34	-	37.54	6.99	34.13
AV	7.38324G	38.97	54.00	-15.03	28.54	3	Horizontal	292	2.34	-	37.57	6.98	34.12

2.4-2.4835GHz_802.11g_Nss1,(6Mbps)_2TX

2412MHz_TX

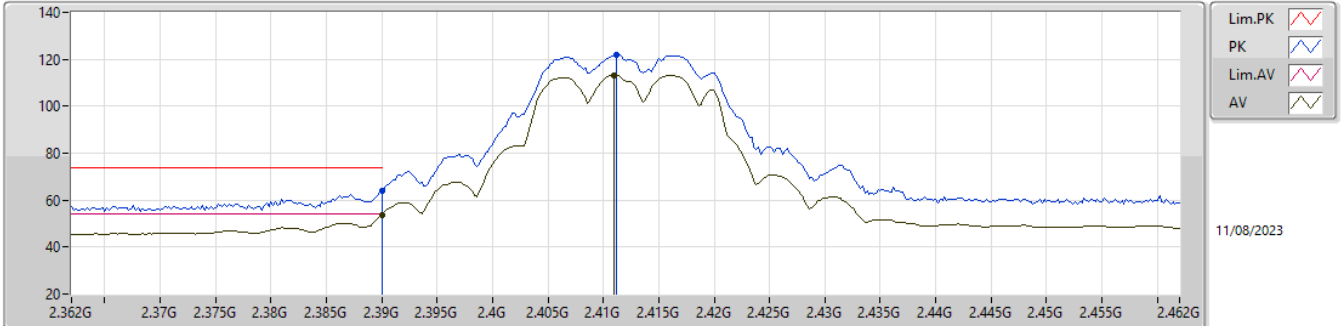

EUT_Y_2TX
Setting 21
04-M-M-2

Type	Freq (Hz)	Level (dBuV/m)	Limit (dBuV/m)	Margin (dB)	Raw (dBuV)	Dist (m)	Condition	Azimuth (°)	Height (m)	Comment	AF (dB)	CL (dB)	PA (dB)
PK	2.39G	64.19	74.00	-9.81	33.35	3	Vertical	15	1.42	-	27.64	3.20	-
AV	2.39G	53.71	54.00	-0.29	22.87	3	Vertical	15	1.42	-	27.64	3.20	-
PK	2.4112G	122.12	Inf	-Inf	91.21	3	Vertical	15	1.42	-	27.70	3.21	-
AV	2.411G	113.31	Inf	-Inf	82.40	3	Vertical	15	1.42	-	27.70	3.21	-

2.4-2.4835GHz_802.11g_Nss1,(6Mbps)_2TX

2412MHz_TX

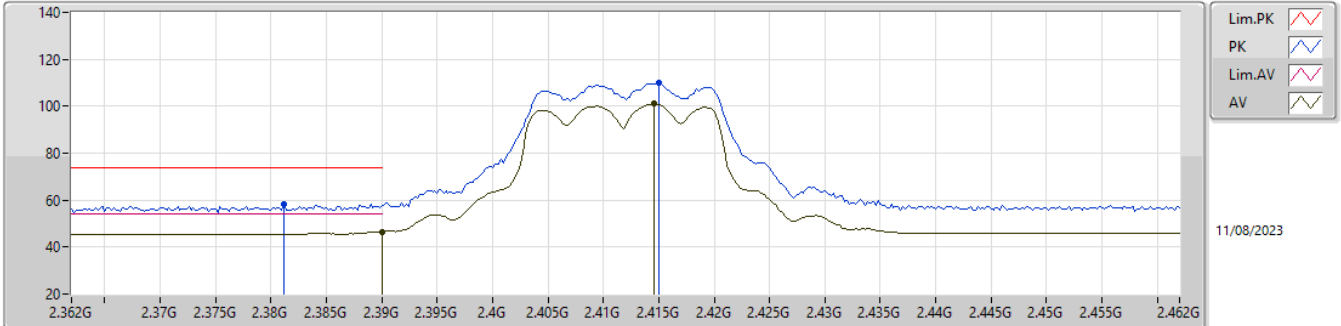

EUT_Y_2TX
Setting 21
04-M-M-2

Type	Freq (Hz)	Level (dBuV/m)	Limit (dBuV/m)	Margin (dB)	Raw (dBuV)	Dist (m)	Condition	Azimuth (°)	Height (m)	Comment	AF (dB)	CL (dB)	PA (dB)
PK	2.3812G	58.28	74.00	-15.72	27.50	3	Horizontal	31	1.00	-	27.59	3.19	-
AV	2.39G	46.59	54.00	-7.41	15.75	3	Horizontal	31	1.00	-	27.64	3.20	-
PK	2.415G	109.75	Inf	-Inf	78.84	3	Horizontal	31	1.00	-	27.70	3.21	-
AV	2.4146G	100.96	Inf	-Inf	70.05	3	Horizontal	31	1.00	-	27.70	3.21	-

2.4-2.4835GHz_802.11g_Nss1,(6Mbps)_2TX

2412MHz_TX

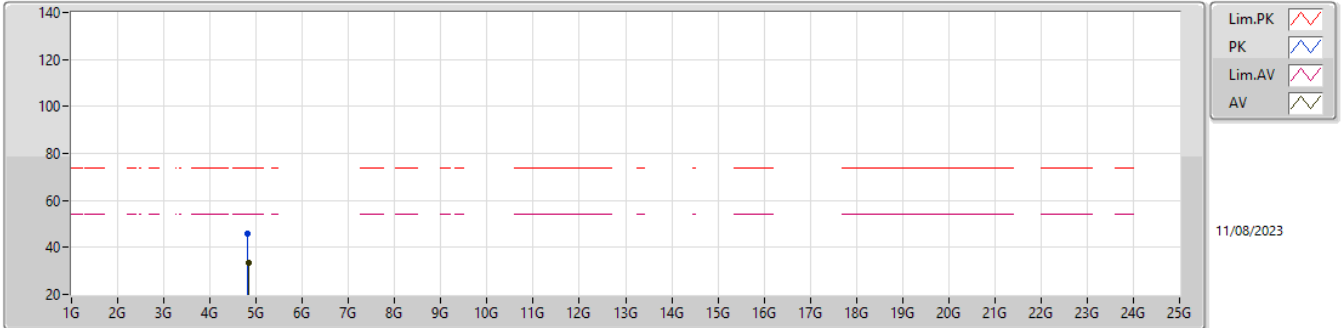

EUT_Y_2TX
Setting 21
04-M-M-2

Type	Freq	Level	Limit	Margin	Raw	Dist	Condition	Azimuth	Height	Comment	AF	CL	PA			
	(Hz)	(dBuV/m)	(dBuV/m)	(dB)	(dBuV)	(m)		(°)	(m)		(dB)	(dB)	(dB)			
PK	4.8172G	45.70	74.00	-28.30	40.41	3	Vertical	84	2.37	-	32.63	5.30	32.64			
AV	4.82652G	33.27	54.00	-20.73	27.94	3	Vertical	84	2.37	-	32.65	5.30	32.62			

2.4-2.4835GHz_802.11g_Nss1,(6Mbps)_2TX

2412MHz_TX

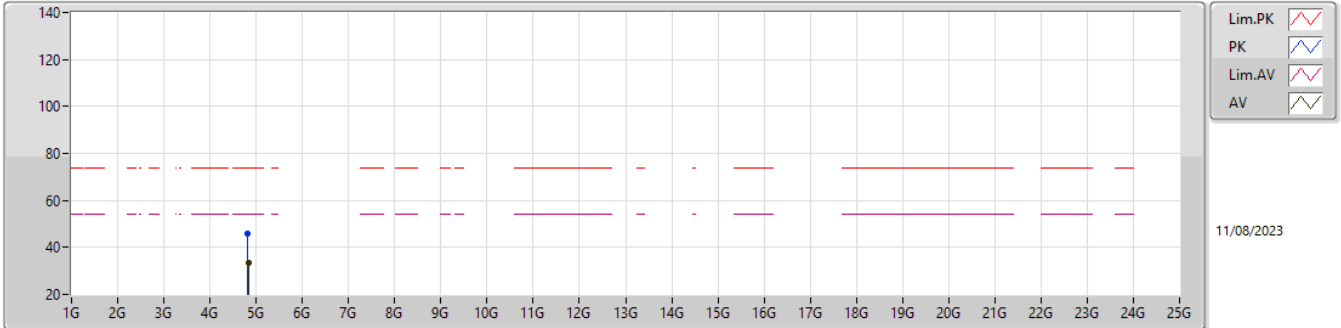

EUT_Y_2TX
Setting 21
04-M-M-2

Type	Freq (Hz)	Level (dBuV/m)	Limit (dBuV/m)	Margin (dB)	Raw (dBuV)	Dist (m)	Condition	Azimuth (°)	Height (m)	Comment	AF (dB)	CL (dB)	PA (dB)
PK	4.82448G	46.08	74.00	-27.92	40.75	3	Horizontal	199	2.79	-	32.65	5.30	32.62
AV	4.82672G	33.27	54.00	-20.73	27.94	3	Horizontal	199	2.79	-	32.65	5.30	32.62

2.4-2.4835GHz_802.11g_Nss1,(6Mbps)_2TX

2417MHz_TX

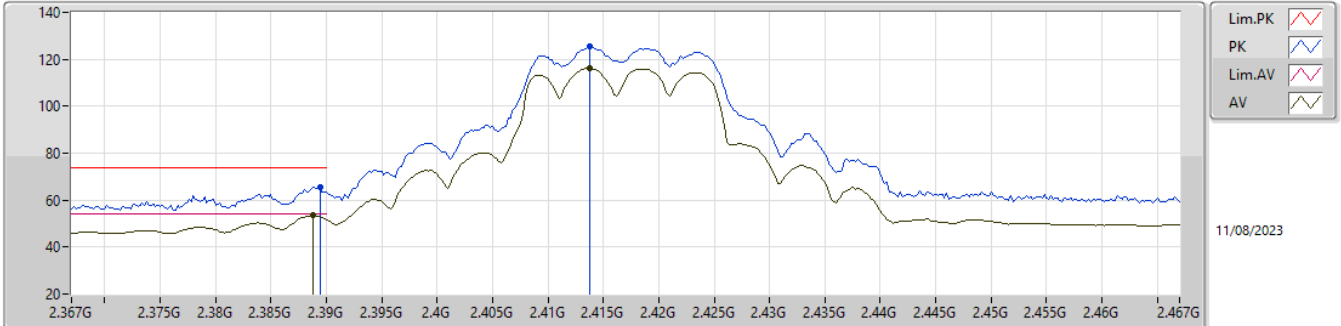

EUT_Y_2TX
 Setting 23.5
 04-M-M-2

Type	Freq (Hz)	Level (dBuV/m)	Limit (dBuV/m)	Margin (dB)	Raw (dBuV)	Dist (m)	Condition	Azimuth (°)	Height (m)	Comment	AF (dB)	CL (dB)	PA (dB)
PK	2.3894G	65.71	74.00	-8.29	34.88	3	Vertical	10	1.04	-	27.64	3.19	-
AV	2.3888G	53.38	54.00	-0.62	22.56	3	Vertical	10	1.04	-	27.63	3.19	-
PK	2.4138G	125.34	Inf	-Inf	94.43	3	Vertical	10	1.04	-	27.70	3.21	-
AV	2.4138G	116.08	Inf	-Inf	85.17	3	Vertical	10	1.04	-	27.70	3.21	-

2.4-2.4835GHz_802.11g_Nss1,(6Mbps)_2TX

2417MHz_TX

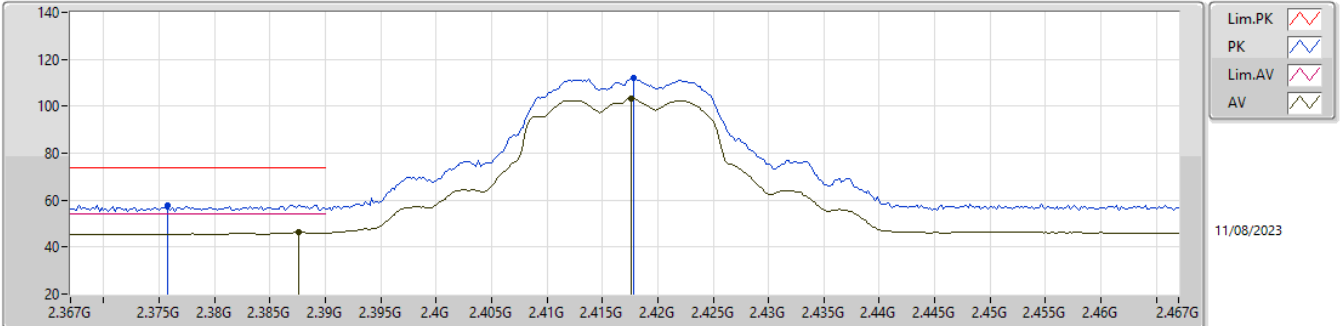

EUT_Y_2TX
 Setting 23.5
 04-M-M-2

Type	Freq (Hz)	Level (dBuV/m)	Limit (dBuV/m)	Margin (dB)	Raw (dBuV)	Dist (m)	Condition	Azimuth (°)	Height (m)	Comment	AF (dB)	CL (dB)	PA (dB)
PK	2.3758G	57.75	74.00	-16.25	27.01	3	Horizontal	23	1.00	-	27.55	3.19	-
AV	2.3876G	46.35	54.00	-7.65	15.53	3	Horizontal	23	1.00	-	27.63	3.19	-
PK	2.4178G	111.90	Inf	-Inf	80.98	3	Horizontal	23	1.00	-	27.70	3.22	-
AV	2.4176G	103.20	Inf	-Inf	72.28	3	Horizontal	23	1.00	-	27.70	3.22	-

2.4-2.4835GHz_802.11g_Nss1,(6Mbps)_2TX

2437MHz_TX

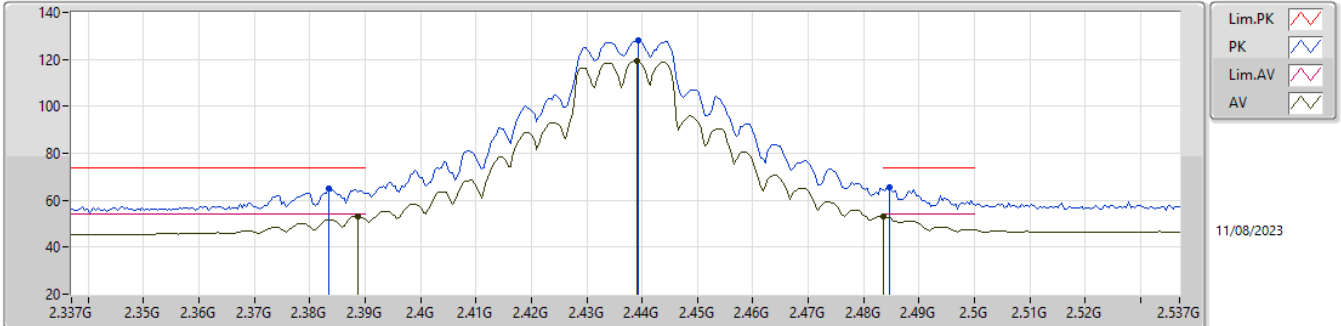

EUT_Y_2TX
Setting 27
04-M-M-2

Type	Freq (Hz)	Level (dBuV/m)	Limit (dBuV/m)	Margin (dB)	Raw (dBuV)	Dist (m)	Condition	Azimuth (°)	Height (m)	Comment	AF (dB)	CL (dB)	PA (dB)
PK	2.3834G	65.20	74.00	-8.80	34.41	3	Vertical	14	1.65	-	27.60	3.19	-
AV	2.3886G	53.17	54.00	-0.83	22.35	3	Vertical	14	1.65	-	27.63	3.19	-
PK	2.4394G	127.91	Inf	-Inf	96.97	3	Vertical	14	1.65	-	27.70	3.24	-
AV	2.439G	119.33	Inf	-Inf	88.39	3	Vertical	14	1.65	-	27.70	3.24	-
PK	2.4846G	65.68	74.00	-8.32	34.56	3	Vertical	14	1.65	-	27.84	3.28	-
AV	2.4835G	53.21	54.00	-0.79	22.10	3	Vertical	14	1.65	-	27.83	3.28	-

2.4-2.4835GHz_802.11g_Nss1,(6Mbps)_2TX

2437MHz_TX

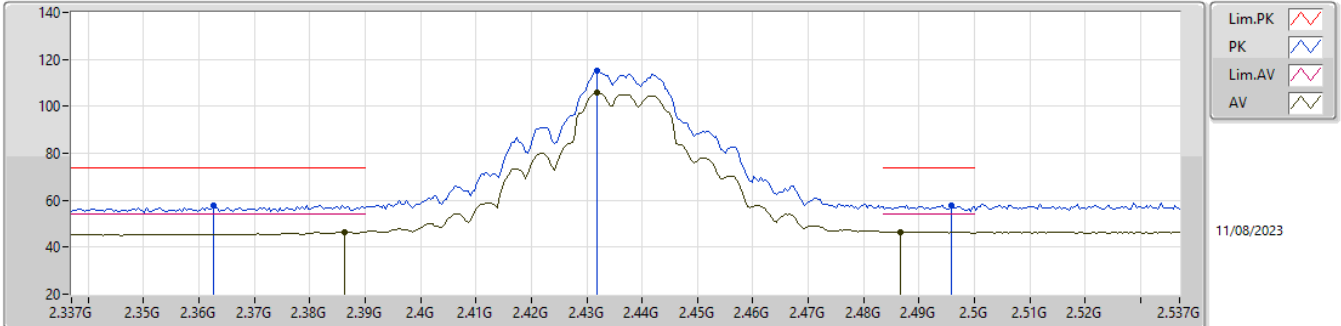

EUT_Y_2TX
Setting 27
04-M-M-2

Type	Freq (Hz)	Level (dBuV/m)	Limit (dBuV/m)	Margin (dB)	Raw (dBuV)	Dist (m)	Condition	Azimuth (°)	Height (m)	Comment	AF (dB)	CL (dB)	PA (dB)
PK	2.3626G	57.76	74.00	-16.24	27.10	3	Horizontal	32	1.00	-	27.48	3.18	-
AV	2.3862G	46.59	54.00	-7.41	15.78	3	Horizontal	32	1.00	-	27.62	3.19	-
PK	2.4318G	114.93	Inf	-Inf	84.00	3	Horizontal	32	1.00	-	27.70	3.23	-
AV	2.4318G	106.02	Inf	-Inf	75.09	3	Horizontal	32	1.00	-	27.70	3.23	-
PK	2.4958G	57.57	74.00	-16.43	26.39	3	Horizontal	32	1.00	-	27.88	3.30	-
AV	2.4866G	46.48	54.00	-7.52	15.34	3	Horizontal	32	1.00	-	27.85	3.29	-

2.4-2.4835GHz_802.11g_Nss1,(6Mbps)_2TX

2437MHz_TX

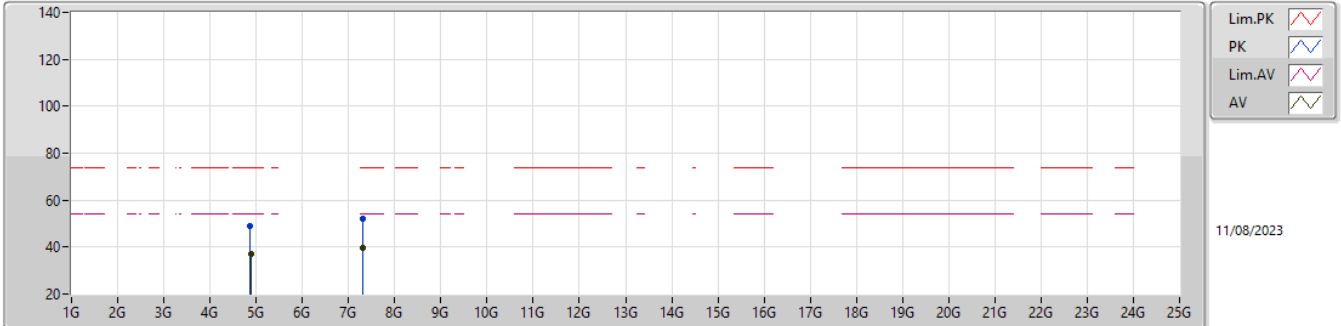

EUT_Y_2TX
Setting 27
04-M-M-2

Type	Freq (Hz)	Level (dBuV/m)	Limit (dBuV/m)	Margin (dB)	Raw (dBuV)	Dist (m)	Condition	Azimuth (°)	Height (m)	Comment	AF (dB)	CL (dB)	PA (dB)
PK	4.87616G	49.19	74.00	-24.81	43.64	3	Vertical	217	1.64	-	32.75	5.30	32.50
AV	4.87956G	36.86	54.00	-17.14	31.29	3	Vertical	217	1.64	-	32.76	5.30	32.49
PK	7.31228G	52.24	74.00	-21.76	41.72	3	Vertical	138	2.28	-	37.70	6.91	34.09
AV	7.31112G	39.58	54.00	-14.42	29.06	3	Vertical	138	2.28	-	37.70	6.91	34.09

2.4-2.4835GHz_802.11g_Nss1,(6Mbps)_2TX

2437MHz_TX

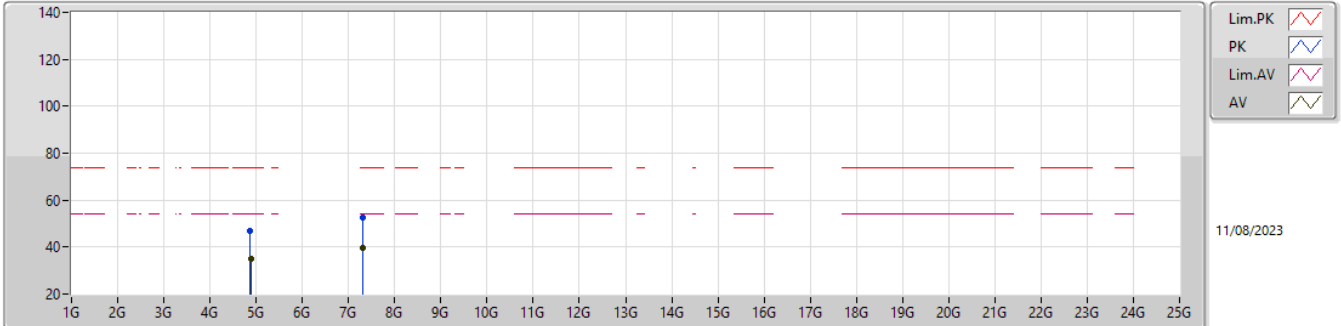

EUT_Y_2TX
 Setting 27
 04-M-M-2

Type	Freq (Hz)	Level (dBuV/m)	Limit (dBuV/m)	Margin (dB)	Raw (dBuV)	Dist (m)	Condition	Azimuth (°)	Height (m)	Comment	AF (dB)	CL (dB)	PA (dB)
PK	4.87028G	47.06	74.00	-26.94	41.54	3	Horizontal	181	1.36	-	32.74	5.30	32.52
AV	4.87972G	34.96	54.00	-19.04	29.39	3	Horizontal	181	1.36	-	32.76	5.30	32.49
PK	7.31108G	52.45	74.00	-21.55	41.93	3	Horizontal	43	2.01	-	37.70	6.91	34.09
AV	7.31044G	39.51	54.00	-14.49	28.99	3	Horizontal	43	2.01	-	37.70	6.91	34.09

2.4-2.4835GHz_802.11g_Nss1,(6Mbps)_2TX

2457MHz_TX

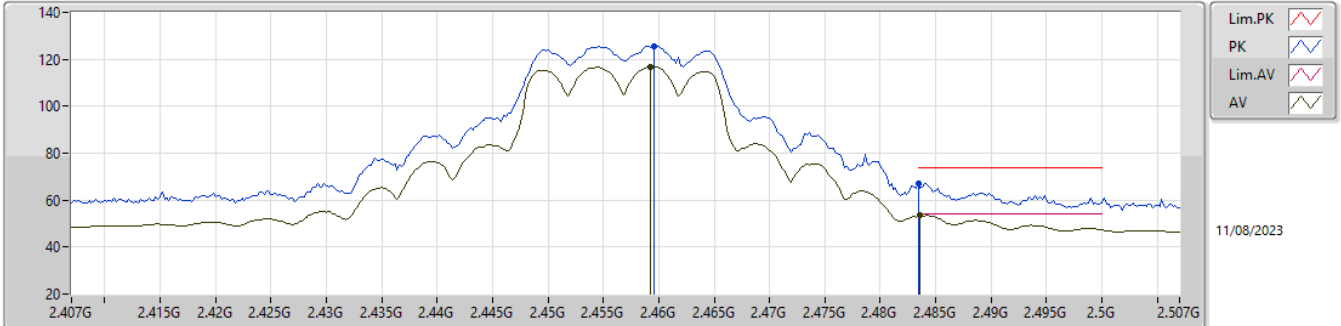

EUT_Y_2TX
Setting 24
04-M-M-2

Type	Freq (Hz)	Level (dBuV/m)	Limit (dBuV/m)	Margin (dB)	Raw (dBuV)	Dist (m)	Condition	Azimuth (°)	Height (m)	Comment	AF (dB)	CL (dB)	PA (dB)
PK	2.4596G	125.59	Inf	-Inf	94.59	3	Vertical	12	1.80	-	27.74	3.26	-
AV	2.4592G	116.83	Inf	-Inf	85.83	3	Vertical	12	1.80	-	27.74	3.26	-
PK	2.4835G	67.06	74.00	-6.94	35.95	3	Vertical	12	1.80	-	27.83	3.28	-
AV	2.4836G	53.55	54.00	-0.45	22.44	3	Vertical	12	1.80	-	27.83	3.28	-

2.4-2.4835GHz_802.11g_Nss1,(6Mbps)_2TX

2457MHz_TX

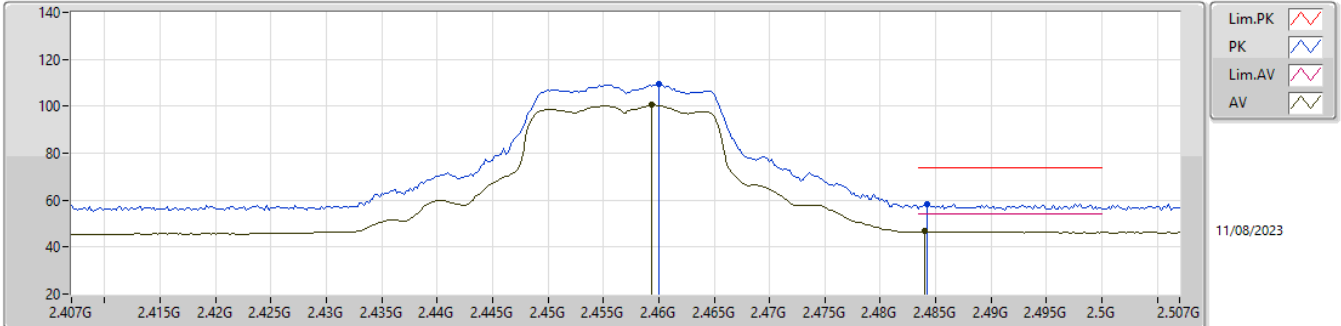

EUT_Y_2TX
Setting 24
04-M-M-2

Type	Freq (Hz)	Level (dBuV/m)	Limit (dBuV/m)	Margin (dB)	Raw (dBuV)	Dist (m)	Condition	Azimuth (°)	Height (m)	Comment	AF (dB)	CL (dB)	PA (dB)
PK	2.46G	109.48	Inf	-Inf	78.48	3	Horizontal	-0	1.80	-	27.74	3.26	-
AV	2.4594G	100.49	Inf	-Inf	69.49	3	Horizontal	-0	1.80	-	27.74	3.26	-
PK	2.4842G	58.47	74.00	-15.53	27.35	3	Horizontal	-0	1.80	-	27.84	3.28	-
AV	2.484G	46.72	54.00	-7.28	15.60	3	Horizontal	-0	1.80	-	27.84	3.28	-

2.4-2.4835GHz_802.11g_Nss1,(6Mbps)_2TX

2462MHz_TX

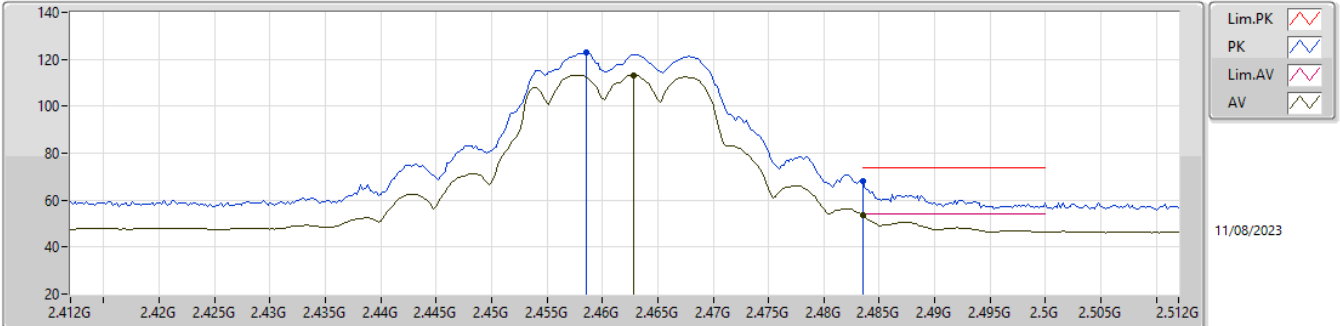

EUT_Y_2TX
 Setting 20.5
 04-M-M-2

Type	Freq (Hz)	Level (dBuV/m)	Limit (dBuV/m)	Margin (dB)	Raw (dBuV)	Dist (m)	Condition	Azimuth (°)	Height (m)	Comment	AF (dB)	CL (dB)	PA (dB)
PK	2.4586G	122.96	Inf	-Inf	91.97	3	Vertical	-0	1.79	-	27.73	3.26	-
AV	2.4628G	113.34	Inf	-Inf	82.33	3	Vertical	-0	1.79	-	27.75	3.26	-
PK	2.4835G	68.25	74.00	-5.75	37.14	3	Vertical	-0	1.79	-	27.83	3.28	-
AV	2.4835G	53.78	54.00	-0.22	22.67	3	Vertical	-0	1.79	-	27.83	3.28	-

2.4-2.4835GHz_802.11g_Nss1,(6Mbps)_2TX

2462MHz_TX

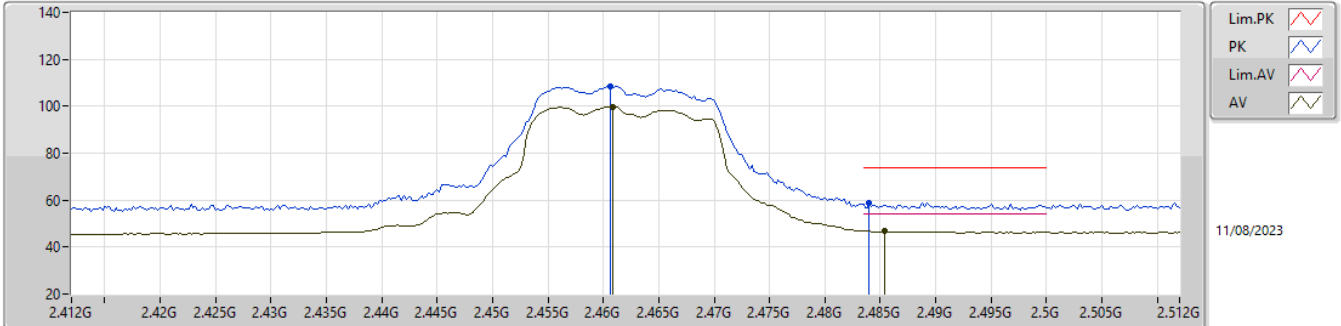

EUT_Y_2TX
 Setting 20.5
 04-M-M-2

Type	Freq (Hz)	Level (dBuV/m)	Limit (dBuV/m)	Margin (dB)	Raw (dBuV)	Dist (m)	Condition	Azimuth (°)	Height (m)	Comment	AF (dB)	CL (dB)	PA (dB)
PK	2.4606G	108.33	Inf	-Inf	77.33	3	Horizontal	20	1.61	-	27.74	3.26	-
AV	2.4608G	99.85	Inf	-Inf	68.85	3	Horizontal	20	1.61	-	27.74	3.26	-
PK	2.484G	58.91	74.00	-15.09	27.79	3	Horizontal	20	1.61	-	27.84	3.28	-
AV	2.4854G	46.73	54.00	-7.27	15.60	3	Horizontal	20	1.61	-	27.84	3.29	-

2.4-2.4835GHz_802.11g_Nss1,(6Mbps)_2TX

2462MHz_TX

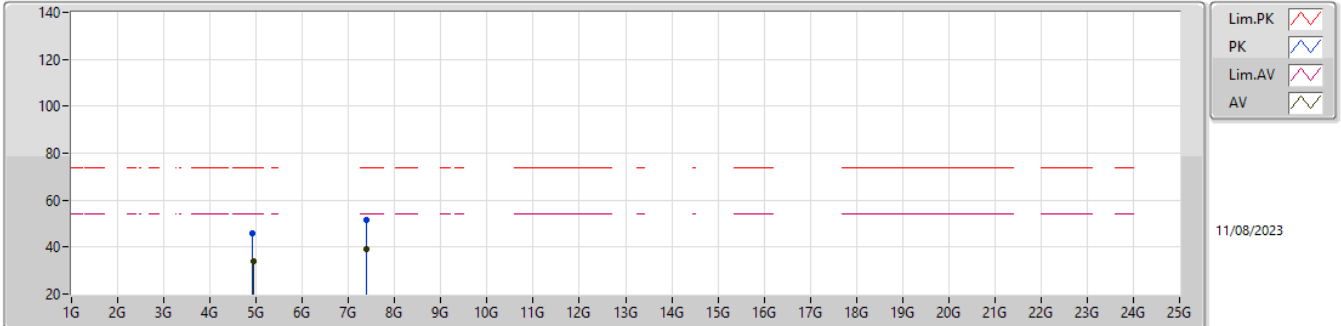

EUT_Y_2TX
Setting 20.5
04-M-M-2

Type	Freq (Hz)	Level (dBuV/m)	Limit (dBuV/m)	Margin (dB)	Raw (dBuV)	Dist (m)	Condition	Azimuth (°)	Height (m)	Comment	AF (dB)	CL (dB)	PA (dB)
PK	4.9172G	45.97	74.00	-28.03	40.25	3	Vertical	150	1.67	-	32.83	5.30	32.41
AV	4.93012G	33.74	54.00	-20.26	27.95	3	Vertical	150	1.67	-	32.86	5.30	32.37
PK	7.38676G	51.74	74.00	-22.26	41.32	3	Vertical	29	2.95	-	37.55	6.99	34.12
AV	7.39136G	38.91	54.00	-15.09	28.52	3	Vertical	29	2.95	-	37.53	6.99	34.13

2.4-2.4835GHz_802.11g_Nss1,(6Mbps)_2TX

2462MHz_TX

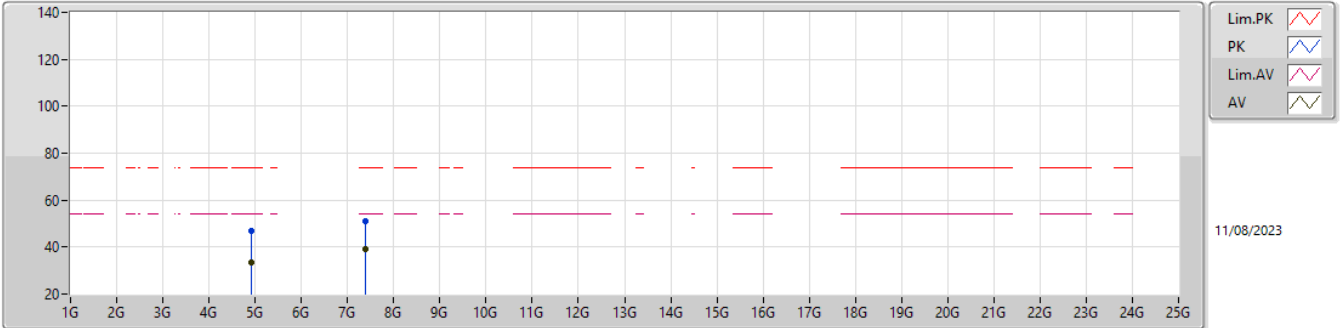

EUT_Y_2TX
 Setting 20.5
 04-M-M-2

Type	Freq (Hz)	Level (dBuV/m)	Limit (dBuV/m)	Margin (dB)	Raw (dBuV)	Dist (m)	Condition	Azimuth (°)	Height (m)	Comment	AF (dB)	CL (dB)	PA (dB)
PK	4.92568G	46.81	74.00	-27.19	41.05	3	Horizontal	175	2.29	-	32.85	5.30	32.39
AV	4.91768G	33.69	54.00	-20.31	27.95	3	Horizontal	175	2.29	-	32.84	5.30	32.40
PK	7.37732G	51.03	74.00	-22.97	40.58	3	Horizontal	73	1.25	-	37.59	6.98	34.12
AV	7.39268G	38.91	54.00	-15.09	28.52	3	Horizontal	73	1.25	-	37.53	6.99	34.13

2.4-2.4835GHz_802.11ax HEW20_Nss1,(MCS0)_2TX

2412MHz_TX

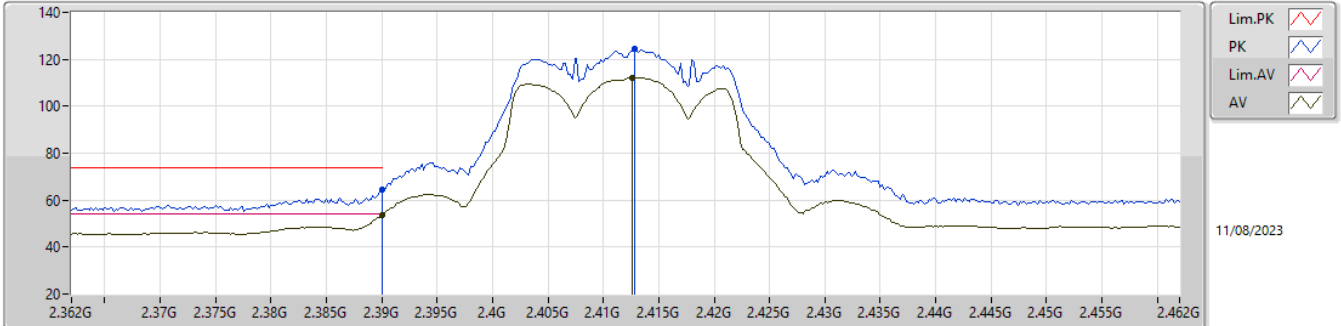

EUT_Y_2TX
 Setting 20.5
 04-M-M-2

Type	Freq (Hz)	Level (dBuV/m)	Limit (dBuV/m)	Margin (dB)	Raw (dBuV)	Dist (m)	Condition	Azimuth (°)	Height (m)	Comment	AF (dB)	CL (dB)	PA (dB)
PK	2.39G	64.28	74.00	-9.72	33.44	3	Vertical	-0	1.36	-	27.64	3.20	-
AV	2.39G	53.61	54.00	-0.39	22.77	3	Vertical	-0	1.36	-	27.64	3.20	-
PK	2.4128G	124.59	Inf	-Inf	93.68	3	Vertical	-0	1.36	-	27.70	3.21	-
AV	2.4126G	112.31	Inf	-Inf	81.40	3	Vertical	-0	1.36	-	27.70	3.21	-

2.4-2.4835GHz_802.11ax HEW20_Nss1,(MCS0)_2TX

2412MHz_TX

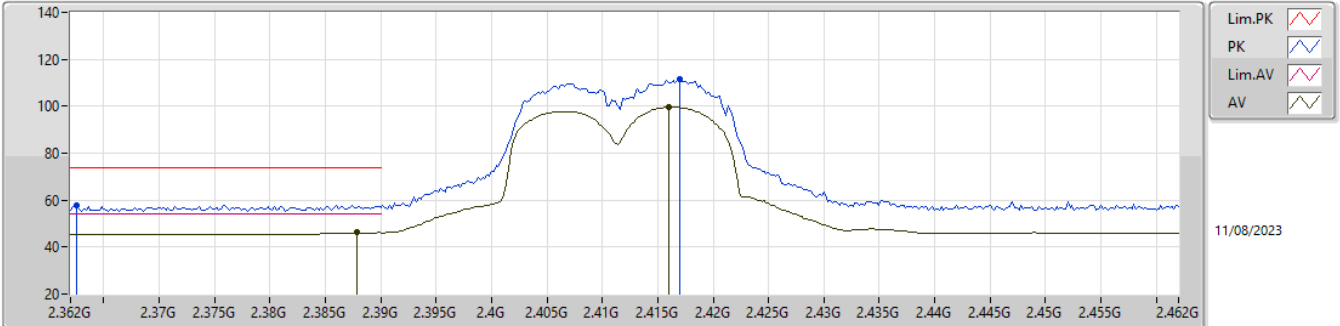

EUT_Y_2TX
 Setting 20.5
 04-M-M-2

Type	Freq (Hz)	Level (dBuV/m)	Limit (dBuV/m)	Margin (dB)	Raw (dBuV)	Dist (m)	Condition	Azimuth (°)	Height (m)	Comment	AF (dB)	CL (dB)	PA (dB)
PK	2.3626G	57.83	74.00	-16.17	27.17	3	Horizontal	36	1.00	-	27.48	3.18	-
AV	2.3878G	46.35	54.00	-7.65	15.53	3	Horizontal	36	1.00	-	27.63	3.19	-
PK	2.417G	111.78	Inf	-Inf	80.86	3	Horizontal	36	1.00	-	27.70	3.22	-
AV	2.416G	99.65	Inf	-Inf	68.73	3	Horizontal	36	1.00	-	27.70	3.22	-

2.4-2.4835GHz_802.11ax HEW20_Nss1,(MCS0)_2TX

2412MHz_TX

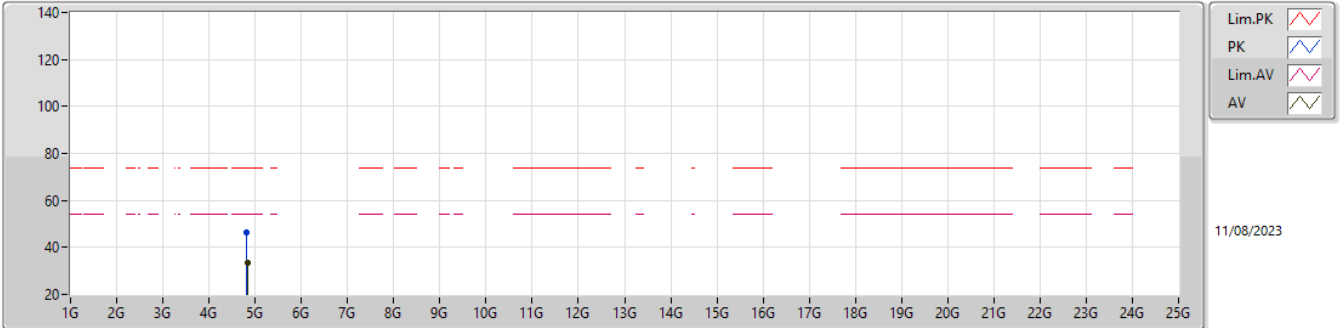

EUT_Y_2TX
 Setting 20.5
 04-M-M-2

Type	Freq	Level	Limit	Margin	Raw	Dist	Condition	Azimuth	Height	Comment	AF	CL	PA
	(Hz)	(dBuV/m)	(dBuV/m)	(dB)	(dBuV)	(m)		(°)	(m)		(dB)	(dB)	(dB)
PK	4.82392G	46.40	74.00	-27.60	41.08	3	Vertical	141	2.80	-	32.65	5.30	32.63
AV	4.83264G	33.32	54.00	-20.68	27.95	3	Vertical	141	2.80	-	32.67	5.30	32.60

2.4-2.4835GHz_802.11ax HEW20_Nss1,(MCS0)_2TX

2412MHz_TX

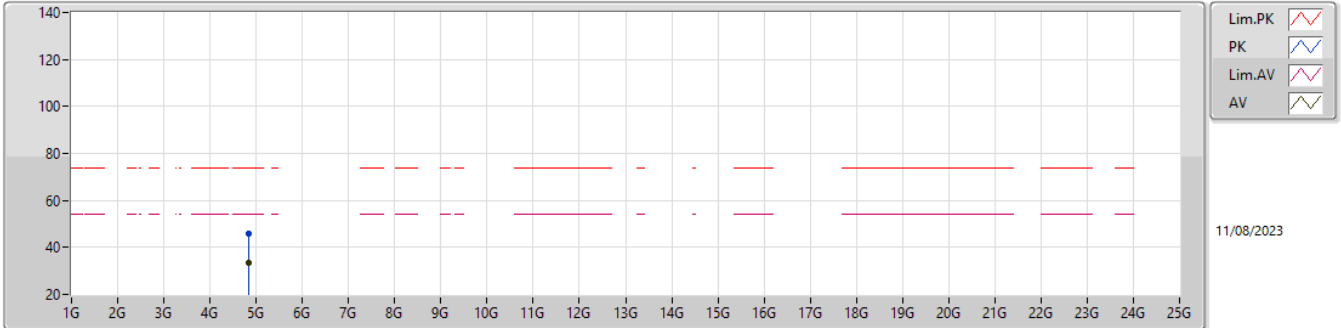

EUT_Y_2TX
 Setting 20.5
 04-M-M-2

Type	Freq (Hz)	Level (dBuV/m)	Limit (dBuV/m)	Margin (dB)	Raw (dBuV)	Dist (m)	Condition	Azimuth (°)	Height (m)	Comment	AF (dB)	CL (dB)	PA (dB)
PK	4.833G	45.74	74.00	-28.26	40.37	3	Horizontal	34	1.25	-	32.67	5.30	32.60
AV	4.834G	33.34	54.00	-20.66	27.97	3	Horizontal	34	1.25	-	32.67	5.30	32.60

2.4-2.4835GHz_802.11ax HEW20_Nss1,(MCS0)_2TX

2417MHz_TX

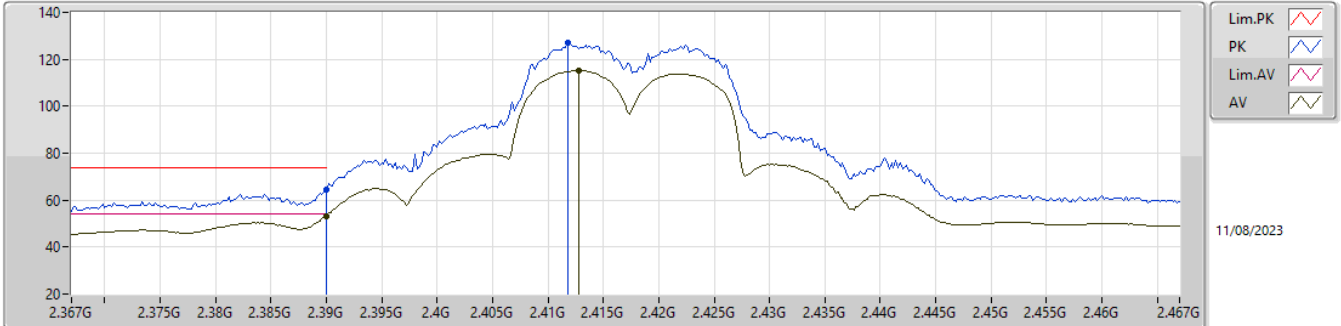

EUT_Y_2TX
 Setting 23.5
 04-M-M-2

Type	Freq (Hz)	Level (dBuV/m)	Limit (dBuV/m)	Margin (dB)	Raw (dBuV)	Dist (m)	Condition	Azimuth (°)	Height (m)	Comment	AF (dB)	CL (dB)	PA (dB)
PK	2.39G	64.50	74.00	-9.50	33.66	3	Vertical	-0	1.30	-	27.64	3.20	-
AV	2.39G	53.29	54.00	-0.71	22.45	3	Vertical	-0	1.30	-	27.64	3.20	-
PK	2.4118G	127.01	Inf	-Inf	96.10	3	Vertical	-0	1.30	-	27.70	3.21	-
AV	2.4128G	115.12	Inf	-Inf	84.21	3	Vertical	-0	1.30	-	27.70	3.21	-

2.4-2.4835GHz_802.11ax HEW20_Nss1,(MCS0)_2TX

2417MHz_TX

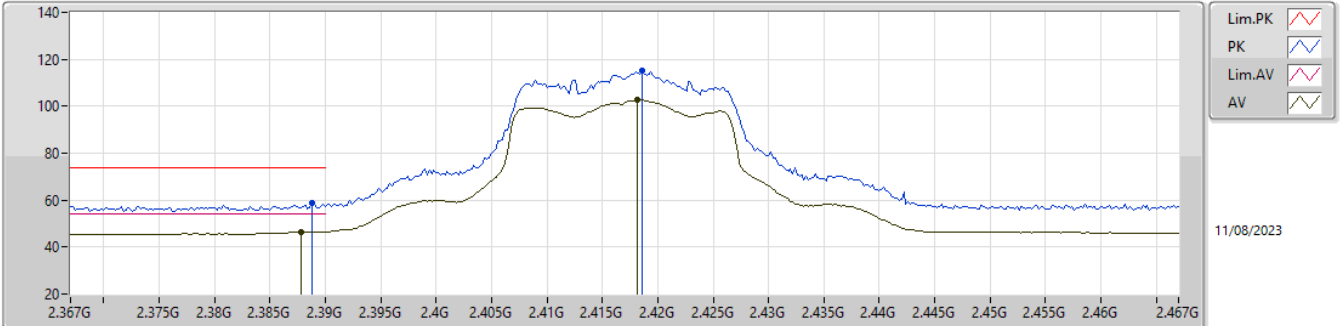

EUT_Y_2TX
Setting 23.5
04-M-M-2

Type	Freq (Hz)	Level (dBuV/m)	Limit (dBuV/m)	Margin (dB)	Raw (dBuV)	Dist (m)	Condition	Azimuth (°)	Height (m)	Comment	AF (dB)	CL (dB)	PA (dB)
PK	2.3888G	58.58	74.00	-15.42	27.76	3	Horizontal	23	1.00	-	27.63	3.19	-
AV	2.3878G	46.59	54.00	-7.41	15.77	3	Horizontal	23	1.00	-	27.63	3.19	-
PK	2.4186G	115.19	Inf	-Inf	84.27	3	Horizontal	23	1.00	-	27.70	3.22	-
AV	2.4182G	102.59	Inf	-Inf	71.67	3	Horizontal	23	1.00	-	27.70	3.22	-

2.4-2.4835GHz_802.11ax HEW20_Nss1,(MCS0)_2TX

2437MHz_TX

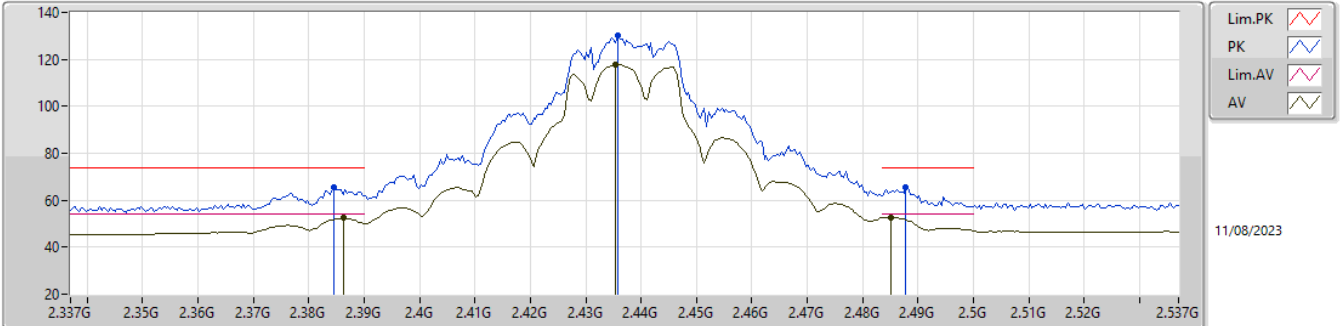

EUT_Y_2TX
 Setting 26.5
 04-M-M-2

Type	Freq (Hz)	Level (dBuV/m)	Limit (dBuV/m)	Margin (dB)	Raw (dBuV)	Dist (m)	Condition	Azimuth (°)	Height (m)	Comment	AF (dB)	CL (dB)	PA (dB)
PK	2.3846G	65.54	74.00	-8.46	34.74	3	Vertical	15	1.72	-	27.61	3.19	-
AV	2.3862G	52.37	54.00	-1.63	21.56	3	Vertical	15	1.72	-	27.62	3.19	-
PK	2.4358G	130.17	Inf	-Inf	99.23	3	Vertical	15	1.72	-	27.70	3.24	-
AV	2.4354G	118.00	Inf	-Inf	87.06	3	Vertical	15	1.72	-	27.70	3.24	-
PK	2.4878G	65.70	74.00	-8.30	34.56	3	Vertical	15	1.72	-	27.85	3.29	-
AV	2.485G	52.75	54.00	-1.25	21.62	3	Vertical	15	1.72	-	27.84	3.29	-

2.4-2.4835GHz_802.11ax HEW20_Nss1,(MCS0)_2TX

2437MHz_TX

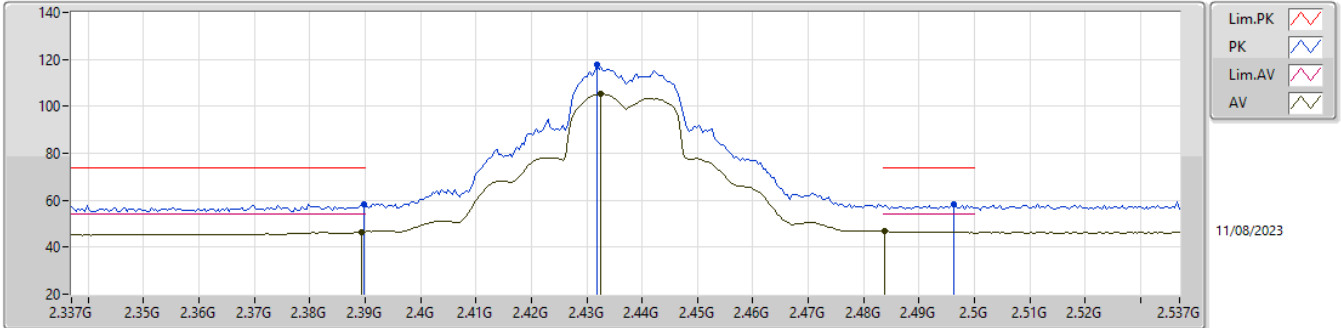

EUT_Y_2TX
 Setting 26.5
 04-M-M-2

Type	Freq (Hz)	Level (dBuV/m)	Limit (dBuV/m)	Margin (dB)	Raw (dBuV)	Dist (m)	Condition	Azimuth (°)	Height (m)	Comment	AF (dB)	CL (dB)	PA (dB)
PK	2.3898G	58.22	74.00	-15.78	27.39	3	Horizontal	27	1.01	-	27.64	3.19	-
AV	2.3894G	46.58	54.00	-7.42	15.75	3	Horizontal	27	1.01	-	27.64	3.19	-
PK	2.4318G	117.64	Inf	-Inf	86.71	3	Horizontal	27	1.01	-	27.70	3.23	-
AV	2.4326G	105.29	Inf	-Inf	74.36	3	Horizontal	27	1.01	-	27.70	3.23	-
PK	2.4962G	58.13	74.00	-15.87	26.95	3	Horizontal	27	1.01	-	27.88	3.30	-
AV	2.4838G	46.72	54.00	-7.28	15.60	3	Horizontal	27	1.01	-	27.84	3.28	-

2.4-2.4835GHz_802.11ax HEW20_Nss1,(MCS0)_2TX

2437MHz_TX

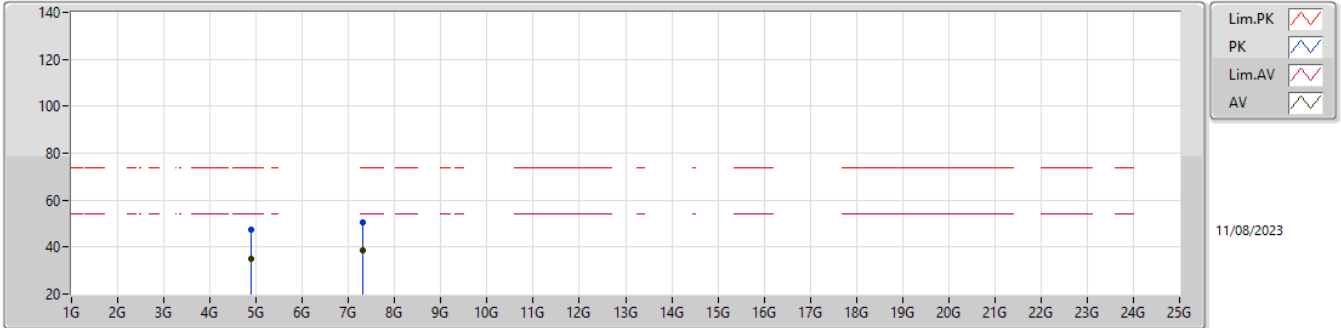

EUT_Y_2TX
Setting 26.5
04-M-M-2

Type	Freq (Hz)	Level (dBuV/m)	Limit (dBuV/m)	Margin (dB)	Raw (dBuV)	Dist (m)	Condition	Azimuth (°)	Height (m)	Comment	AF (dB)	CL (dB)	PA (dB)
PK	4.88072G	47.45	74.00	-26.55	41.88	3	Vertical	179	1.80	-	32.76	5.30	32.49
AV	4.87864G	34.96	54.00	-19.04	29.40	3	Vertical	179	1.80	-	32.76	5.30	32.50
PK	7.30776G	50.75	74.00	-23.25	40.23	3	Vertical	215	1.65	-	37.70	6.91	34.09
AV	7.311G	38.84	54.00	-15.16	28.32	3	Vertical	215	1.65	-	37.70	6.91	34.09

2.4-2.4835GHz_802.11ax HEW20_Nss1,(MCS0)_2TX

2437MHz_TX

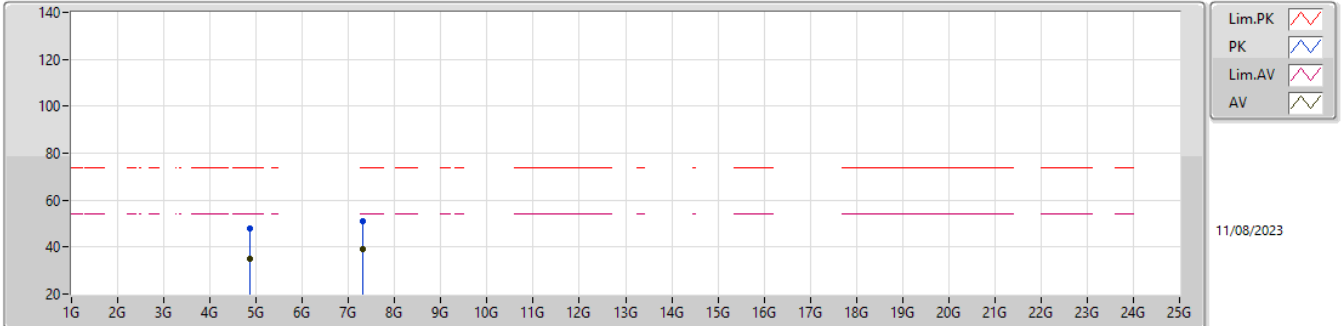

EUT_Y_2TX
 Setting 26.5
 04-M-M-2

Type	Freq (Hz)	Level (dBuV/m)	Limit (dBuV/m)	Margin (dB)	Raw (dBuV)	Dist (m)	Condition	Azimuth (°)	Height (m)	Comment	AF (dB)	CL (dB)	PA (dB)
PK	4.87596G	47.86	74.00	-26.14	42.31	3	Horizontal	332	1.73	-	32.75	5.30	32.50
AV	4.87652G	34.90	54.00	-19.10	29.35	3	Horizontal	332	1.73	-	32.75	5.30	32.50
PK	7.31532G	51.22	74.00	-22.78	40.70	3	Horizontal	330	2.50	-	37.70	6.92	34.10
AV	7.31272G	38.99	54.00	-15.01	28.48	3	Horizontal	330	2.50	-	37.70	6.91	34.10

2.4-2.4835GHz_802.11ax HEW20_Nss1,(MCS0)_2TX

2457MHz_TX

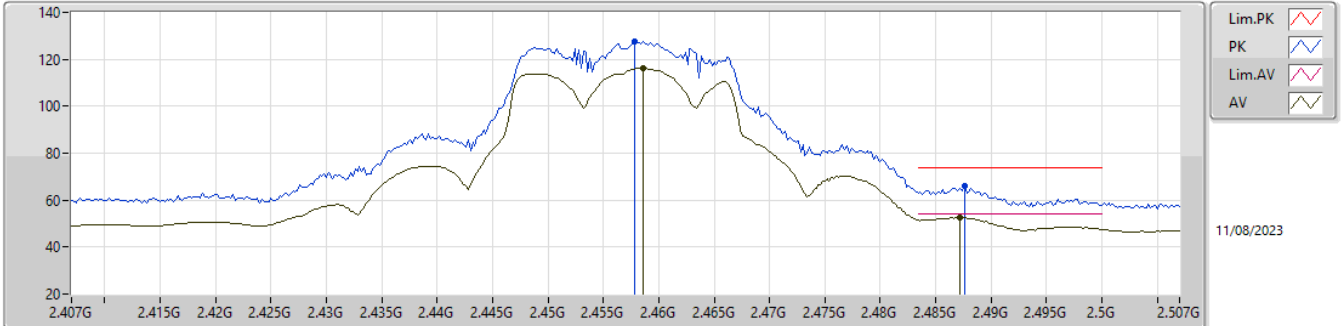

EUT_Y_2TX
Setting 24
04-M-M-2

Type	Freq (Hz)	Level (dBuV/m)	Limit (dBuV/m)	Margin (dB)	Raw (dBuV)	Dist (m)	Condition	Azimuth (°)	Height (m)	Comment	AF (dB)	CL (dB)	PA (dB)
PK	2.4578G	127.74	Inf	-Inf	96.75	3	Vertical	2	1.79	-	27.73	3.26	-
AV	2.4586G	116.22	Inf	-Inf	85.23	3	Vertical	2	1.79	-	27.73	3.26	-
PK	2.4876G	65.84	74.00	-8.16	34.70	3	Vertical	2	1.79	-	27.85	3.29	-
AV	2.4872G	52.63	54.00	-1.37	21.49	3	Vertical	2	1.79	-	27.85	3.29	-

2.4-2.4835GHz_802.11ax HEW20_Nss1,(MCS0)_2TX

2457MHz_TX

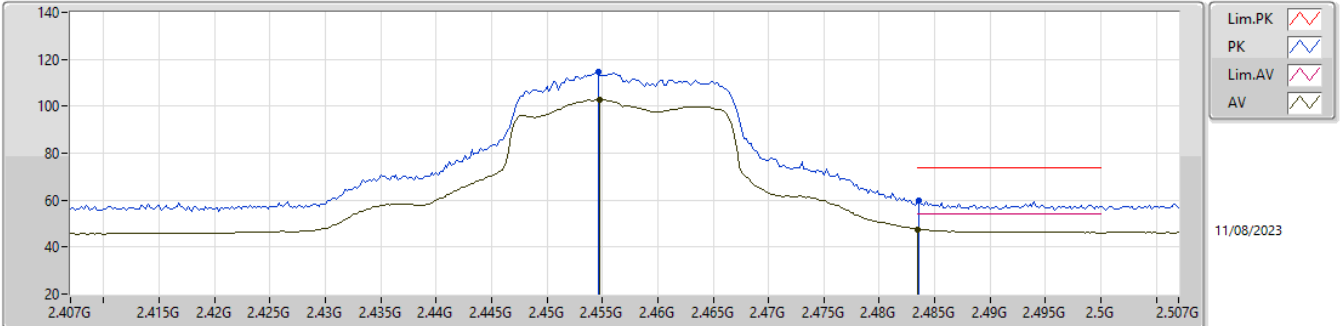

EUT_Y_2TX
Setting 24
04-M-M-2

Type	Freq (Hz)	Level (dBuV/m)	Limit (dBuV/m)	Margin (dB)	Raw (dBuV)	Dist (m)	Condition	Azimuth (°)	Height (m)	Comment	AF (dB)	CL (dB)	PA (dB)
PK	2.4546G	114.71	Inf	-Inf	83.74	3	Horizontal	21	1.59	-	27.72	3.25	-
AV	2.4548G	102.61	Inf	-Inf	71.64	3	Horizontal	21	1.59	-	27.72	3.25	-
PK	2.4836G	59.82	74.00	-14.18	28.71	3	Horizontal	21	1.59	-	27.83	3.28	-
AV	2.4835G	47.65	54.00	-6.35	16.54	3	Horizontal	21	1.59	-	27.83	3.28	-

2.4-2.4835GHz_802.11ax HEW20_Nss1,(MCS0)_2TX

2462MHz_TX

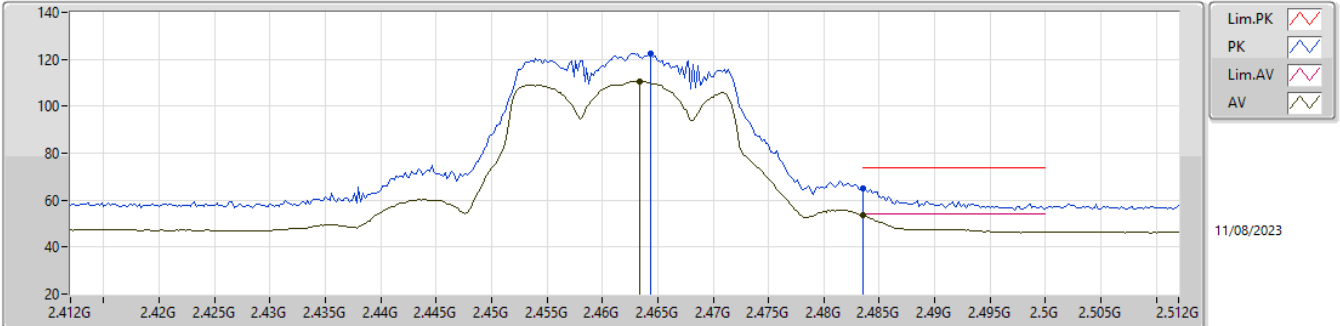

EUT_Y_2TX
Setting 18.5
04-M-M-2

Type	Freq (Hz)	Level (dBuV/m)	Limit (dBuV/m)	Margin (dB)	Raw (dBuV)	Dist (m)	Condition	Azimuth (°)	Height (m)	Comment	AF (dB)	CL (dB)	PA (dB)
PK	2.4644G	122.58	Inf	-Inf	91.56	3	Vertical	3	1.78	-	27.76	3.26	-
AV	2.4634G	110.75	Inf	-Inf	79.74	3	Vertical	3	1.78	-	27.75	3.26	-
PK	2.4835G	65.24	74.00	-8.76	34.13	3	Vertical	3	1.78	-	27.83	3.28	-
AV	2.4835G	53.67	54.00	-0.33	22.56	3	Vertical	3	1.78	-	27.83	3.28	-

2.4-2.4835GHz_802.11ax HEW20_Nss1,(MCS0)_2TX

2462MHz_TX

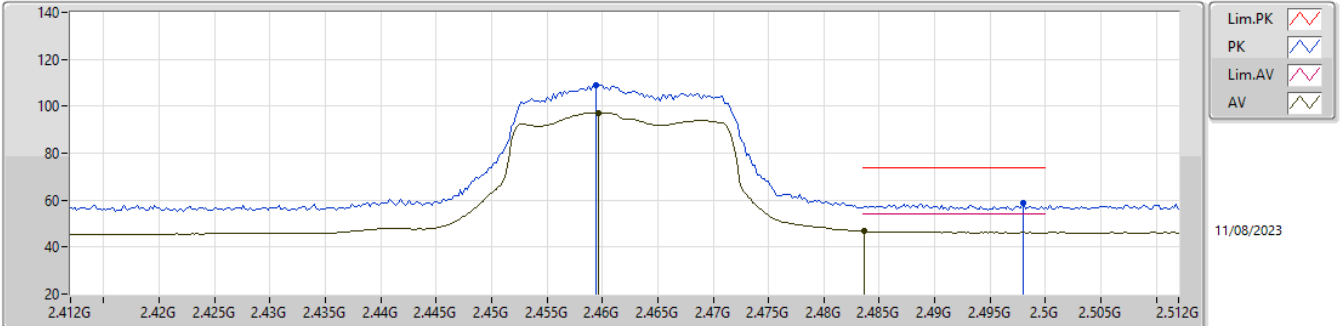

EUT_Y_2TX
 Setting 18.5
 04-M-M-2

Type	Freq (Hz)	Level (dBuV/m)	Limit (dBuV/m)	Margin (dB)	Raw (dBuV)	Dist (m)	Condition	Azimuth (°)	Height (m)	Comment	AF (dB)	CL (dB)	PA (dB)
PK	2.4594G	109.03	Inf	-Inf	78.03	3	Horizontal	19	1.60	-	27.74	3.26	-
AV	2.4596G	97.32	Inf	-Inf	66.32	3	Horizontal	19	1.60	-	27.74	3.26	-
PK	2.498G	58.72	74.00	-15.28	27.53	3	Horizontal	19	1.60	-	27.89	3.30	-
AV	2.4836G	46.71	54.00	-7.29	15.60	3	Horizontal	19	1.60	-	27.83	3.28	-

2.4-2.4835GHz_802.11ax HEW20_Nss1,(MCS0)_2TX

2462MHz_TX

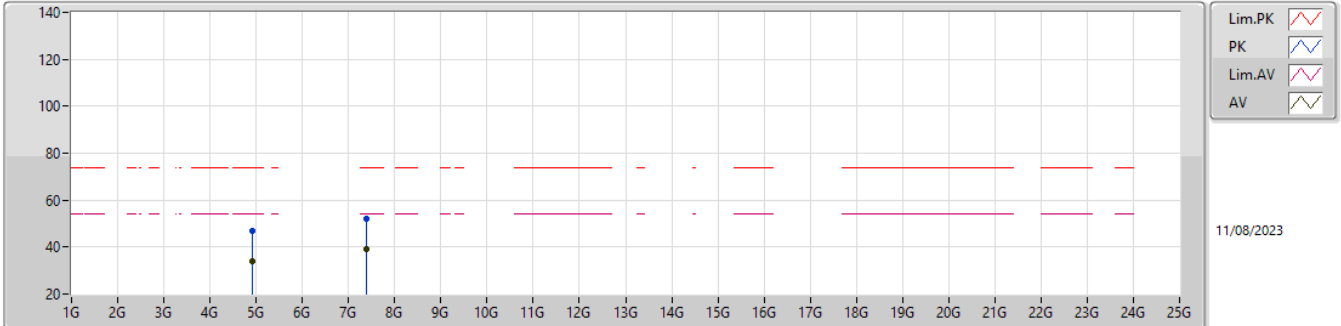

EUT_Y_2TX
 Setting 18.5
 04-M-M-2

Type	Freq (Hz)	Level (dBuV/m)	Limit (dBuV/m)	Margin (dB)	Raw (dBuV)	Dist (m)	Condition	Azimuth (°)	Height (m)	Comment	AF (dB)	CL (dB)	PA (dB)
PK	4.9178G	46.82	74.00	-27.18	41.08	3	Vertical	5	1.36	-	32.84	5.30	32.40
AV	4.91784G	33.77	54.00	-20.23	28.03	3	Vertical	5	1.36	-	32.84	5.30	32.40
PK	7.3952G	51.86	74.00	-22.14	41.47	3	Vertical	297	1.40	-	37.52	7.00	34.13
AV	7.39252G	38.99	54.00	-15.01	28.60	3	Vertical	297	1.40	-	37.53	6.99	34.13

2.4-2.4835GHz_802.11ax HEW20_Nss1,(MCS0)_2TX

2462MHz_TX

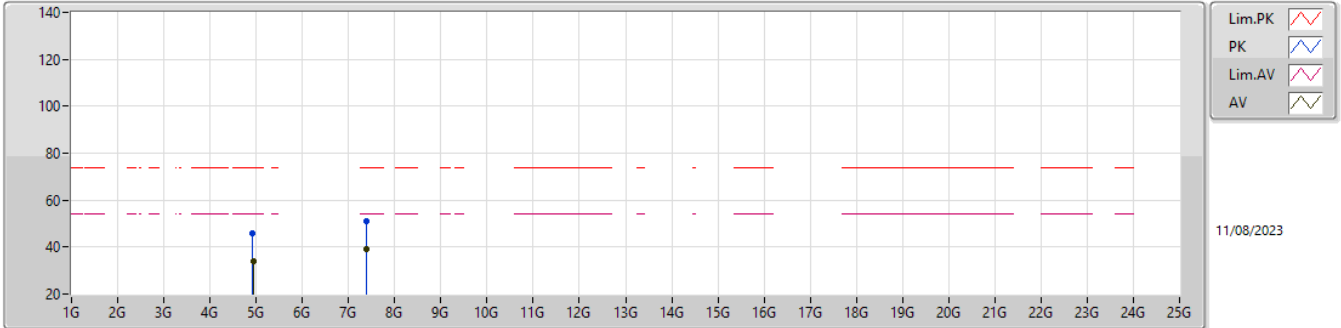

EUT_Y_2TX
 Setting 18.5
 04-M-M-2

Type	Freq (Hz)	Level (dBuV/m)	Limit (dBuV/m)	Margin (dB)	Raw (dBuV)	Dist (m)	Condition	Azimuth (°)	Height (m)	Comment	AF (dB)	CL (dB)	PA (dB)
PK	4.92284G	45.70	74.00	-28.30	39.94	3	Horizontal	190	1.71	-	32.85	5.30	32.39
AV	4.93316G	33.77	54.00	-20.23	27.97	3	Horizontal	190	1.71	-	32.87	5.30	32.37
PK	7.389G	51.25	74.00	-22.75	40.85	3	Horizontal	270	1.39	-	37.54	6.99	34.13
AV	7.39316G	38.99	54.00	-15.01	28.60	3	Horizontal	270	1.39	-	37.53	6.99	34.13

2.4-2.4835GHz_802.11ax HEW40_Nss1,(MCS0)_2TX

2422MHz_TX

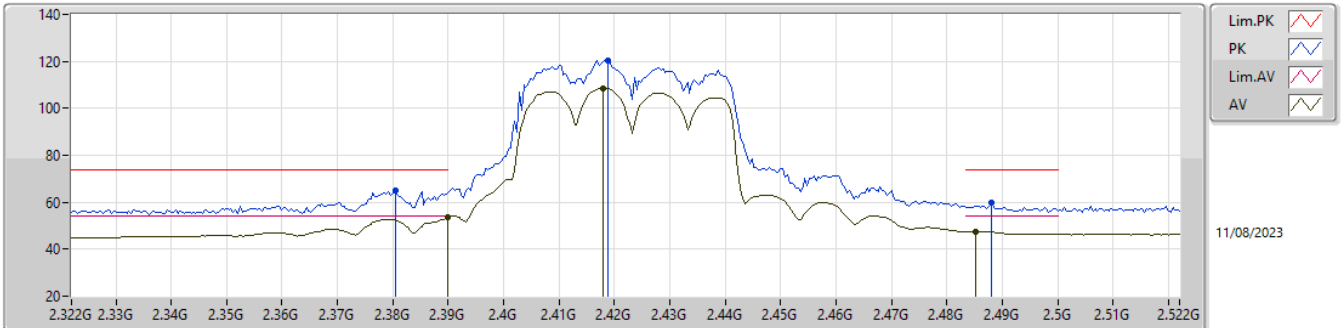

EUTY_2TX
 Setting 19.5
 04-M-M-2

Type	Freq (Hz)	Level (dBuV/m)	Limit (dBuV/m)	Margin (dB)	Raw (dBuV)	Dist (m)	Condition	Azimuth (°)	Height (m)	Comment	AF (dB)	CL (dB)	PA (dB)
PK	2.3804G	64.88	74.00	-9.12	34.11	3	Vertical	356	1.31	-	27.58	3.19	-
AV	2.39G	53.61	54.00	-0.39	22.77	3	Vertical	356	1.31	-	27.64	3.20	-
PK	2.4188G	120.43	Inf	-Inf	89.51	3	Vertical	356	1.31	-	27.70	3.22	-
AV	2.418G	108.42	Inf	-Inf	77.50	3	Vertical	356	1.31	-	27.70	3.22	-
PK	2.488G	59.57	74.00	-14.43	28.43	3	Vertical	356	1.31	-	27.85	3.29	-
AV	2.4852G	47.67	54.00	-6.33	16.54	3	Vertical	356	1.31	-	27.84	3.29	-

2.4-2.4835GHz_802.11ax HEW40_Nss1,(MCS0)_2TX

2422MHz_TX

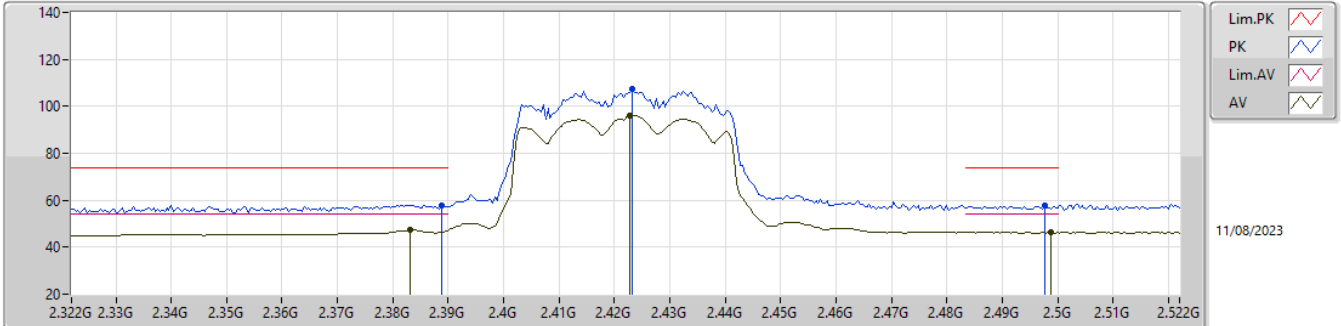

EUT_Y_2TX
 Setting 19.5
 04-M-M-2

Type	Freq (Hz)	Level (dBuV/m)	Limit (dBuV/m)	Margin (dB)	Raw (dBuV)	Dist (m)	Condition	Azimuth (°)	Height (m)	Comment	AF (dB)	CL (dB)	PA (dB)
PK	2.3888G	57.97	74.00	-16.03	27.15	3	Horizontal	32	1.43	-	27.63	3.19	-
AV	2.3832G	47.26	54.00	-6.74	16.47	3	Horizontal	32	1.43	-	27.60	3.19	-
PK	2.4232G	107.41	Inf	-Inf	76.49	3	Horizontal	32	1.43	-	27.70	3.22	-
AV	2.4228G	96.15	Inf	-Inf	65.23	3	Horizontal	32	1.43	-	27.70	3.22	-
PK	2.4976G	57.79	74.00	-16.21	26.60	3	Horizontal	32	1.43	-	27.89	3.30	-
AV	2.4988G	46.27	54.00	-7.73	15.07	3	Horizontal	32	1.43	-	27.90	3.30	-

2.4-2.4835GHz_802.11ax HEW40_Nss1,(MCS0)_2TX

2422MHz_TX

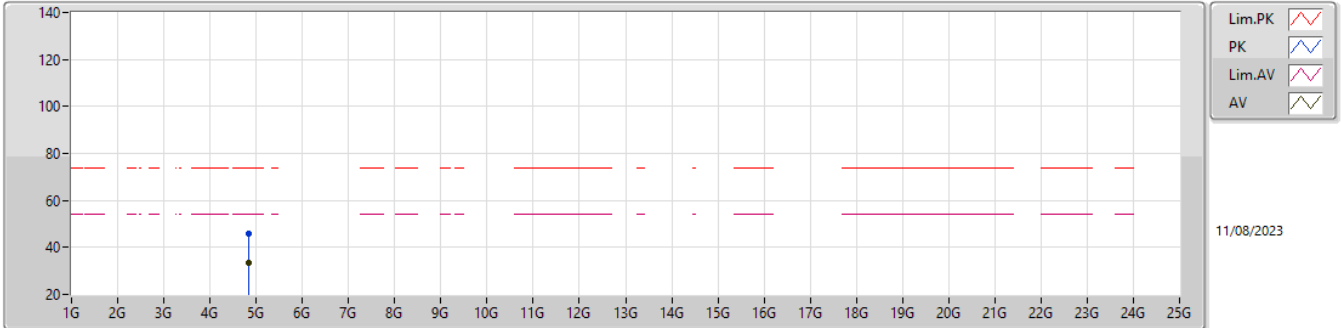

EUT_Y_2TX
 Setting 19.5
 04-M-M-2

Type	Freq (Hz)	Level (dBuV/m)	Limit (dBuV/m)	Margin (dB)	Raw (dBuV)	Dist (m)	Condition	Azimuth (°)	Height (m)	Comment	AF (dB)	CL (dB)	PA (dB)
PK	4.8472G	45.68	74.00	-28.32	40.26	3	Vertical	294	1.54	-	32.69	5.30	32.57
AV	4.8496G	33.38	54.00	-20.62	27.94	3	Vertical	294	1.54	-	32.70	5.30	32.56

2.4-2.4835GHz_802.11ax HEW40_Nss1,(MCS0)_2TX

2422MHz_TX

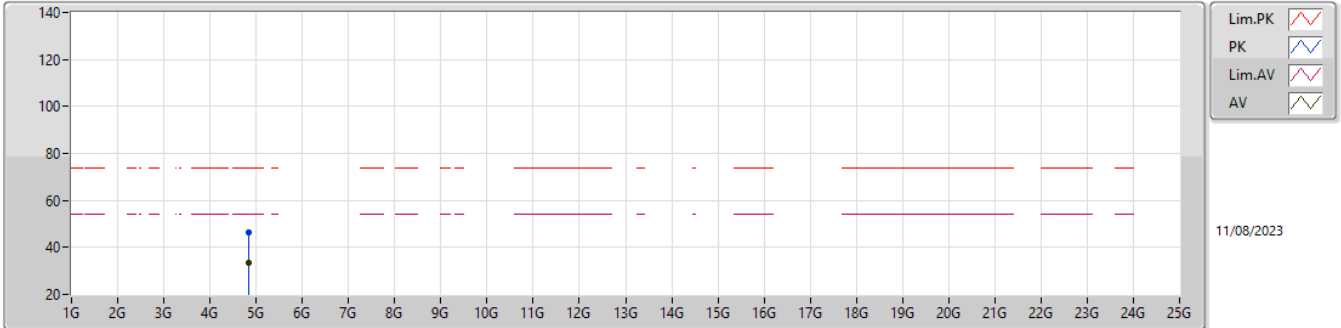

EUT_Y_2TX
 Setting 19.5
 04-M-M-2

Type	Freq (Hz)	Level (dBuV/m)	Limit (dBuV/m)	Margin (dB)	Raw (dBuV)	Dist (m)	Condition	Azimuth (°)	Height (m)	Comment	AF (dB)	CL (dB)	PA (dB)
PK	4.84604G	46.31	74.00	-27.69	40.89	3	Horizontal	17	2.58	-	32.69	5.30	32.57
AV	4.8496G	33.38	54.00	-20.62	27.94	3	Horizontal	17	2.58	-	32.70	5.30	32.56

2.4-2.4835GHz_802.11ax HEW40_Nss1,(MCS0)_2TX

2427MHz_TX

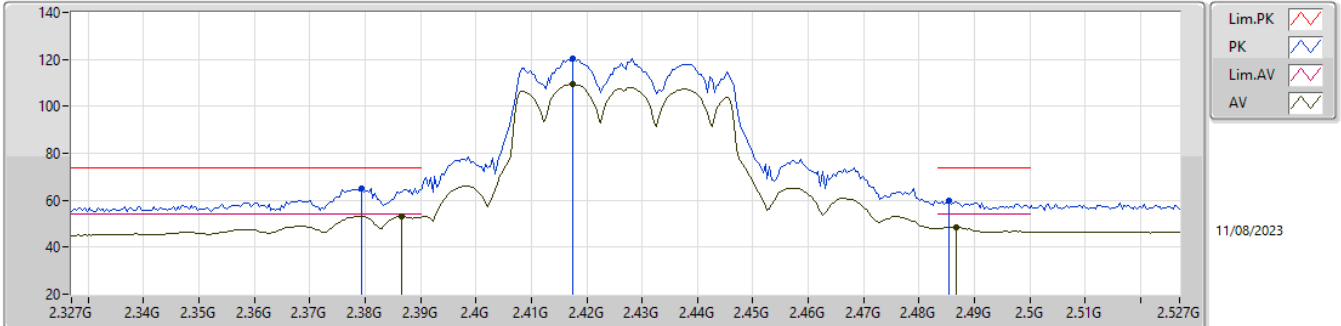

EUT_Y_2TX
Setting 21
04-M-M-2

Type	Freq (Hz)	Level (dBuV/m)	Limit (dBuV/m)	Margin (dB)	Raw (dBuV)	Dist (m)	Condition	Azimuth (°)	Height (m)	Comment	AF (dB)	CL (dB)	PA (dB)
PK	2.3794G	65.03	74.00	-8.97	34.26	3	Vertical	360	1.26	-	27.58	3.19	-
AV	2.3866G	53.28	54.00	-0.72	22.47	3	Vertical	360	1.26	-	27.62	3.19	-
PK	2.4174G	120.48	Inf	-Inf	89.56	3	Vertical	360	1.26	-	27.70	3.22	-
AV	2.4174G	109.44	Inf	-Inf	78.52	3	Vertical	360	1.26	-	27.70	3.22	-
PK	2.4854G	60.05	74.00	-13.95	28.92	3	Vertical	360	1.26	-	27.84	3.29	-
AV	2.4866G	48.32	54.00	-5.68	17.18	3	Vertical	360	1.26	-	27.85	3.29	-

2.4-2.4835GHz_802.11ax HEW40_Nss1,(MCS0)_2TX

2427MHz_TX

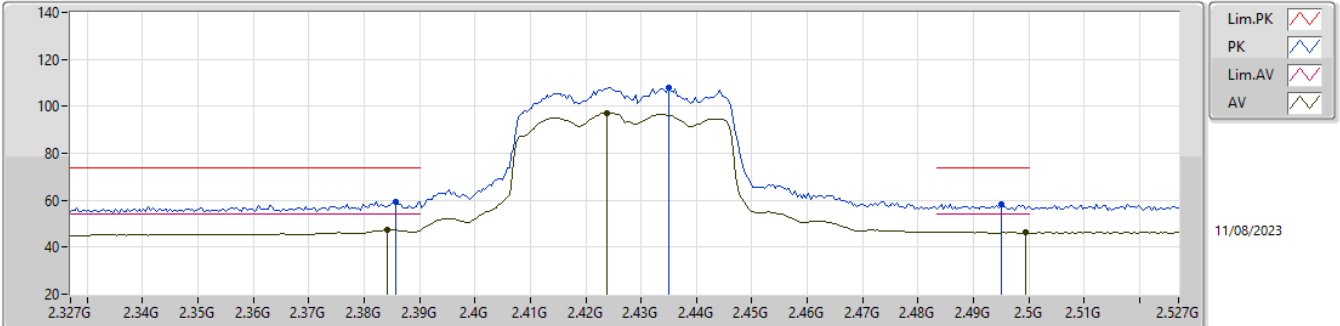

EUT_Y_2TX
Setting 21
04-M-M-2

Type	Freq (Hz)	Level (dBuV/m)	Limit (dBuV/m)	Margin (dB)	Raw (dBuV)	Dist (m)	Condition	Azimuth (°)	Height (m)	Comment	AF (dB)	CL (dB)	PA (dB)
PK	2.3858G	59.53	74.00	-14.47	28.73	3	Horizontal	21	1.40	-	27.61	3.19	-
AV	2.3842G	47.27	54.00	-6.73	16.47	3	Horizontal	21	1.40	-	27.61	3.19	-
PK	2.435G	108.14	Inf	-Inf	77.20	3	Horizontal	21	1.40	-	27.70	3.24	-
AV	2.4238G	97.16	Inf	-Inf	66.24	3	Horizontal	21	1.40	-	27.70	3.22	-
PK	2.495G	58.25	74.00	-15.75	27.08	3	Horizontal	21	1.40	-	27.88	3.29	-
AV	2.4994G	46.27	54.00	-7.73	15.07	3	Horizontal	21	1.40	-	27.90	3.30	-

2.4-2.4835GHz_802.11ax HEW40_Nss1,(MCS0)_2TX

2437MHz_TX

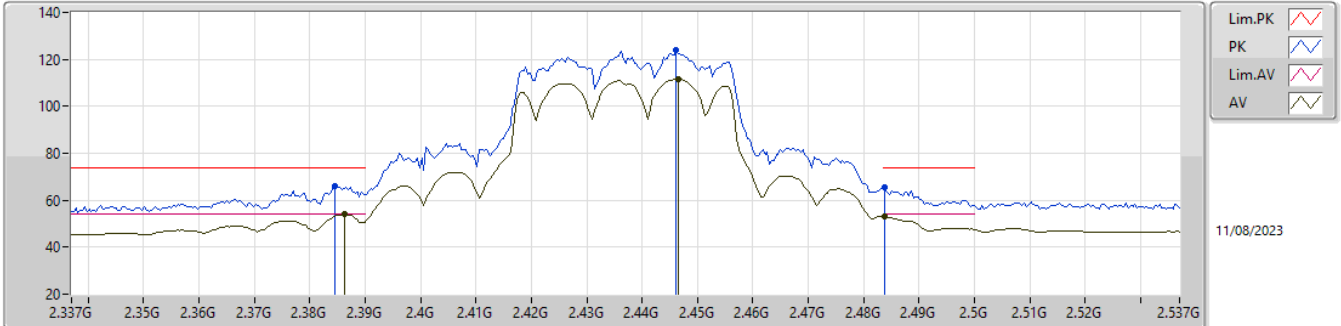

EUT_Y_2TX
 Setting 22.5
 04-M-M-2

Type	Freq (Hz)	Level (dBuV/m)	Limit (dBuV/m)	Margin (dB)	Raw (dBuV)	Dist (m)	Condition	Azimuth (°)	Height (m)	Comment	AF (dB)	CL (dB)	PA (dB)
PK	2.3846G	66.20	74.00	-7.80	35.40	3	Vertical	13	1.66	-	27.61	3.19	-
AV	2.3862G	53.92	54.00	-0.08	23.11	3	Vertical	13	1.66	-	27.62	3.19	-
PK	2.4462G	124.07	Inf	-Inf	93.12	3	Vertical	13	1.66	-	27.70	3.25	-
AV	2.4466G	111.50	Inf	-Inf	80.55	3	Vertical	13	1.66	-	27.70	3.25	-
PK	2.4838G	65.51	74.00	-8.49	34.39	3	Vertical	13	1.66	-	27.84	3.28	-
AV	2.4838G	52.98	54.00	-1.02	21.86	3	Vertical	13	1.66	-	27.84	3.28	-

2.4-2.4835GHz_802.11ax HEW40_Nss1,(MCS0)_2TX

2437MHz_TX

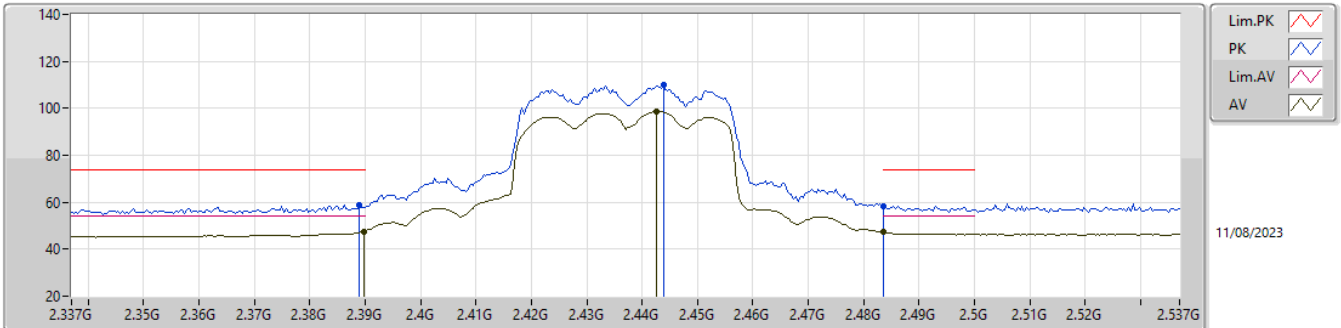

EUT_Y_2TX
 Setting 22.5
 04-M-M-2

Type	Freq (Hz)	Level (dBuV/m)	Limit (dBuV/m)	Margin (dB)	Raw (dBuV)	Dist (m)	Condition	Azimuth (°)	Height (m)	Comment	AF (dB)	CL (dB)	PA (dB)
PK	2.389G	58.98	74.00	-15.02	28.16	3	Horizontal	28	1.35	-	27.63	3.19	-
AV	2.3898G	47.47	54.00	-6.53	16.64	3	Horizontal	28	1.35	-	27.64	3.19	-
PK	2.4438G	109.88	Inf	-Inf	78.94	3	Horizontal	28	1.35	-	27.70	3.24	-
AV	2.4426G	98.47	Inf	-Inf	67.53	3	Horizontal	28	1.35	-	27.70	3.24	-
PK	2.4835G	58.52	74.00	-15.48	27.41	3	Horizontal	28	1.35	-	27.83	3.28	-
AV	2.4835G	47.19	54.00	-6.81	16.08	3	Horizontal	28	1.35	-	27.83	3.28	-

2.4-2.4835GHz_802.11ax HEW40_Nss1,(MCS0)_2TX

2437MHz_TX

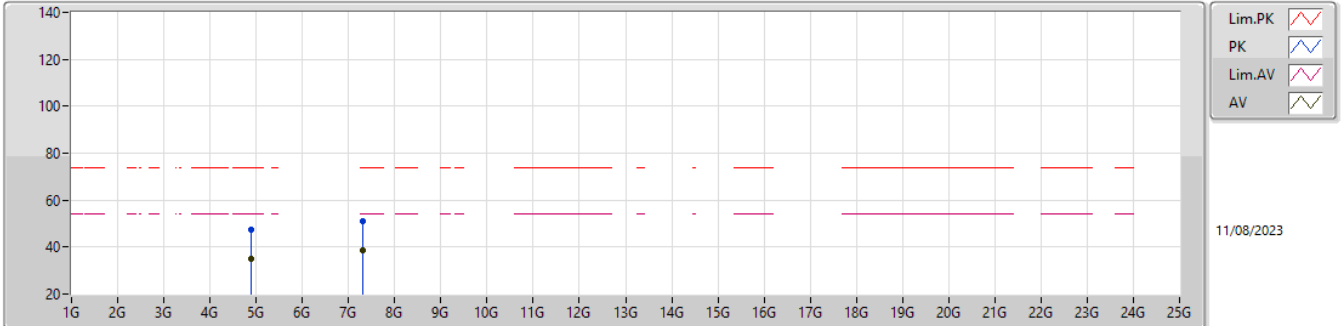

EUT_Y_2TX
 Setting 22.5
 04-M-M-2

Type	Freq (Hz)	Level (dBuV/m)	Limit (dBuV/m)	Margin (dB)	Raw (dBuV)	Dist (m)	Condition	Azimuth (°)	Height (m)	Comment	AF (dB)	CL (dB)	PA (dB)
PK	4.87968G	47.59	74.00	-26.41	42.02	3	Vertical	53	2.07	-	32.76	5.30	32.49
AV	4.87864G	34.89	54.00	-19.11	29.33	3	Vertical	53	2.07	-	32.76	5.30	32.50
PK	7.30368G	51.13	74.00	-22.87	40.62	3	Vertical	243	2.39	-	37.70	6.90	34.09
AV	7.32084G	38.80	54.00	-15.20	28.28	3	Vertical	243	2.39	-	37.70	6.92	34.10

2.4-2.4835GHz_802.11ax HEW40_Nss1,(MCS0)_2TX

2437MHz_TX

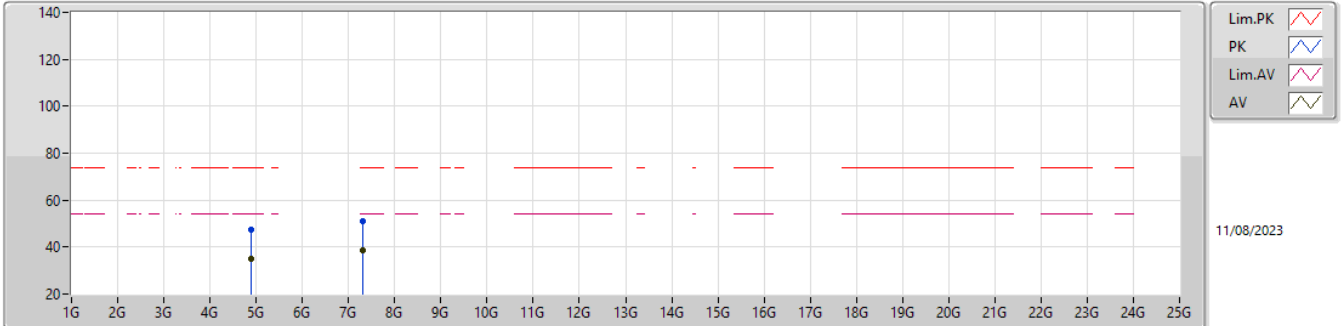

EUT_Y_2TX
 Setting 22.5
 04-M-M-2

Type	Freq (Hz)	Level (dBuV/m)	Limit (dBuV/m)	Margin (dB)	Raw (dBuV)	Dist (m)	Condition	Azimuth (°)	Height (m)	Comment	AF (dB)	CL (dB)	PA (dB)
PK	4.87864G	47.40	74.00	-26.60	41.84	3	Horizontal	126	2.92	-	32.76	5.30	32.50
AV	4.87868G	34.89	54.00	-19.11	29.33	3	Horizontal	126	2.92	-	32.76	5.30	32.50
PK	7.3156G	50.97	74.00	-23.03	40.45	3	Horizontal	327	1.19	-	37.70	6.92	34.10
AV	7.31912G	38.79	54.00	-15.21	28.27	3	Horizontal	327	1.19	-	37.70	6.92	34.10

2.4-2.4835GHz_802.11ax HEW40_Nss1,(MCS0)_2TX

2447MHz_TX

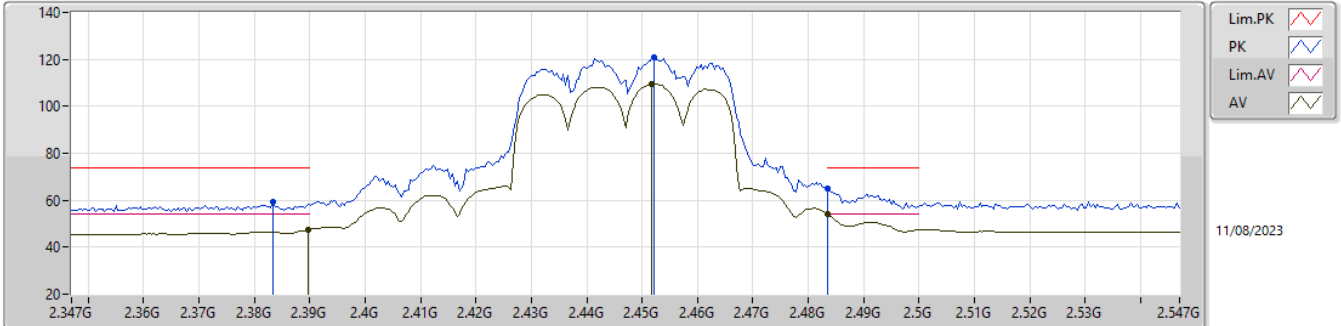

EUT_Y_2TX
 Setting 19.5
 04-M-M-2

Type	Freq (Hz)	Level (dBuV/m)	Limit (dBuV/m)	Margin (dB)	Raw (dBuV)	Dist (m)	Condition	Azimuth (°)	Height (m)	Comment	AF (dB)	CL (dB)	PA (dB)
PK	2.3834G	59.16	74.00	-14.84	28.37	3	Vertical	7	1.65	-	27.60	3.19	-
AV	2.3898G	47.47	54.00	-6.53	16.64	3	Vertical	7	1.65	-	27.64	3.19	-
PK	2.4522G	120.86	Inf	-Inf	89.90	3	Vertical	7	1.65	-	27.71	3.25	-
AV	2.4518G	109.31	Inf	-Inf	78.35	3	Vertical	7	1.65	-	27.71	3.25	-
PK	2.4835G	65.24	74.00	-8.76	34.13	3	Vertical	7	1.65	-	27.83	3.28	-
AV	2.4835G	53.89	54.00	-0.11	22.78	3	Vertical	7	1.65	-	27.83	3.28	-

2.4-2.4835GHz_802.11ax HEW40_Nss1,(MCS0)_2TX

2447MHz_TX

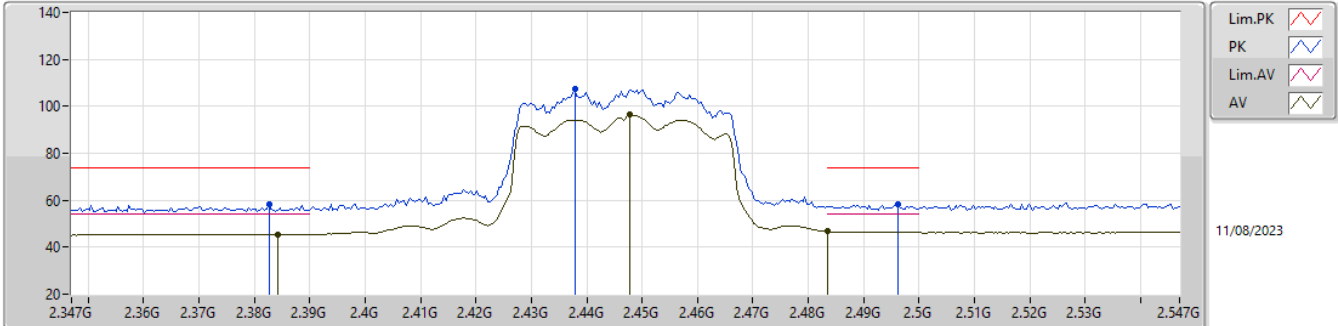

EUT_Y_2TX
Setting 19.5
04-M-M-2

Type	Freq (Hz)	Level (dBuV/m)	Limit (dBuV/m)	Margin (dB)	Raw (dBuV)	Dist (m)	Condition	Azimuth (°)	Height (m)	Comment	AF (dB)	CL (dB)	PA (dB)
PK	2.3826G	58.05	74.00	-15.95	27.26	3	Horizontal	26	1.17	-	27.60	3.19	-
AV	2.3842G	45.60	54.00	-8.40	14.80	3	Horizontal	26	1.17	-	27.61	3.19	-
PK	2.4378G	107.62	Inf	-Inf	76.68	3	Horizontal	26	1.17	-	27.70	3.24	-
AV	2.4478G	96.33	Inf	-Inf	65.38	3	Horizontal	26	1.17	-	27.70	3.25	-
PK	2.4962G	58.32	74.00	-15.68	27.14	3	Horizontal	26	1.17	-	27.88	3.30	-
AV	2.4835G	46.71	54.00	-7.29	15.60	3	Horizontal	26	1.17	-	27.83	3.28	-

2.4-2.4835GHz_802.11ax HEW40_Nss1,(MCS0)_2TX

2452MHz_TX

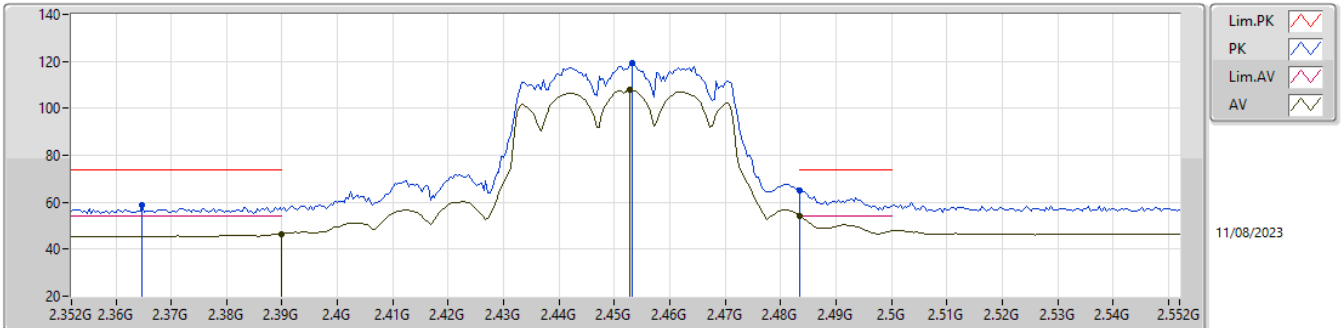

EUT_Y_2TX
Setting 18
04-M-M-2

Type	Freq (Hz)	Level (dBuV/m)	Limit (dBuV/m)	Margin (dB)	Raw (dBuV)	Dist (m)	Condition	Azimuth (°)	Height (m)	Comment	AF (dB)	CL (dB)	PA (dB)
PK	2.3648G	58.68	74.00	-15.32	28.01	3	Vertical	7	1.68	-	27.49	3.18	-
AV	2.39G	46.59	54.00	-7.41	15.75	3	Vertical	7	1.68	-	27.64	3.20	-
PK	2.4532G	119.12	Inf	-Inf	88.16	3	Vertical	7	1.68	-	27.71	3.25	-
AV	2.4528G	107.85	Inf	-Inf	76.89	3	Vertical	7	1.68	-	27.71	3.25	-
PK	2.4835G	64.92	74.00	-9.08	33.81	3	Vertical	7	1.68	-	27.83	3.28	-
AV	2.4835G	53.99	54.00	-0.01	22.88	3	Vertical	7	1.68	-	27.83	3.28	-

2.4-2.4835GHz_802.11ax HEW40_Nss1,(MCS0)_2TX

2452MHz_TX

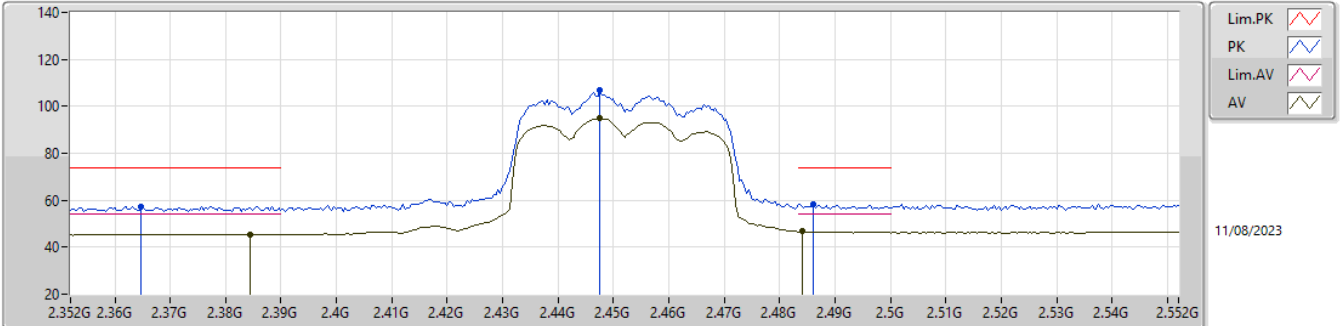

EUT_Y_2TX
Setting 18
04-M-M-2

Type	Freq (Hz)	Level (dBuV/m)	Limit (dBuV/m)	Margin (dB)	Raw (dBuV)	Dist (m)	Condition	Azimuth (°)	Height (m)	Comment	AF (dB)	CL (dB)	PA (dB)
PK	2.3648G	57.38	74.00	-16.62	26.71	3	Horizontal	30	1.17	-	27.49	3.18	-
AV	2.3844G	45.60	54.00	-8.40	14.80	3	Horizontal	30	1.17	-	27.61	3.19	-
PK	2.4476G	106.85	Inf	-Inf	75.90	3	Horizontal	30	1.17	-	27.70	3.25	-
AV	2.4476G	94.88	Inf	-Inf	63.93	3	Horizontal	30	1.17	-	27.70	3.25	-
PK	2.486G	58.22	74.00	-15.78	27.09	3	Horizontal	30	1.17	-	27.84	3.29	-
AV	2.484G	46.72	54.00	-7.28	15.60	3	Horizontal	30	1.17	-	27.84	3.28	-

2.4-2.4835GHz_802.11ax HEW40_Nss1,(MCS0)_2TX

2452MHz_TX

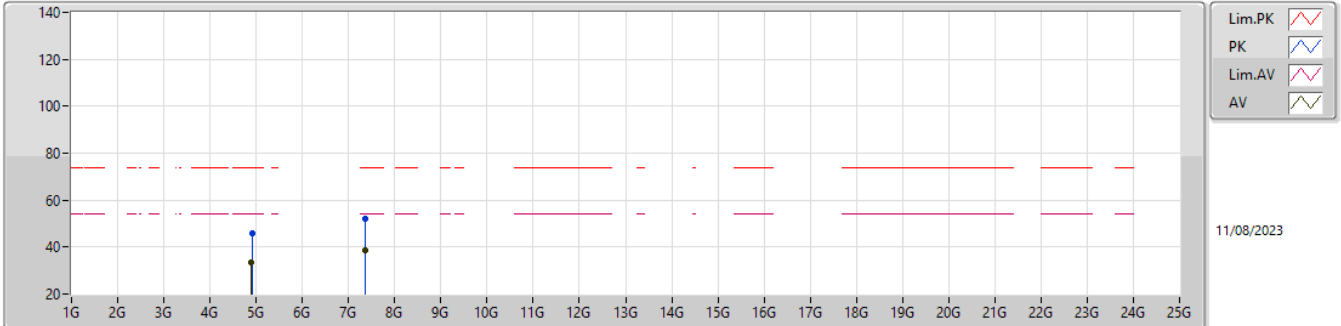

EUT_Y_2TX
Setting 18
04-M-M-2

Type	Freq (Hz)	Level (dBuV/m)	Limit (dBuV/m)	Margin (dB)	Raw (dBuV)	Dist (m)	Condition	Azimuth (°)	Height (m)	Comment	AF (dB)	CL (dB)	PA (dB)
PK	4.90672G	45.97	74.00	-28.03	40.29	3	Vertical	121	2.53	-	32.81	5.30	32.43
AV	4.89408G	33.65	54.00	-20.35	28.02	3	Vertical	121	2.53	-	32.79	5.30	32.46
PK	7.34968G	52.30	74.00	-21.70	41.76	3	Vertical	17	2.54	-	37.70	6.95	34.11
AV	7.34988G	38.85	54.00	-15.15	28.31	3	Vertical	17	2.54	-	37.70	6.95	34.11

2.4-2.4835GHz_802.11ax HEW40_Nss1,(MCS0)_2TX

2452MHz_TX

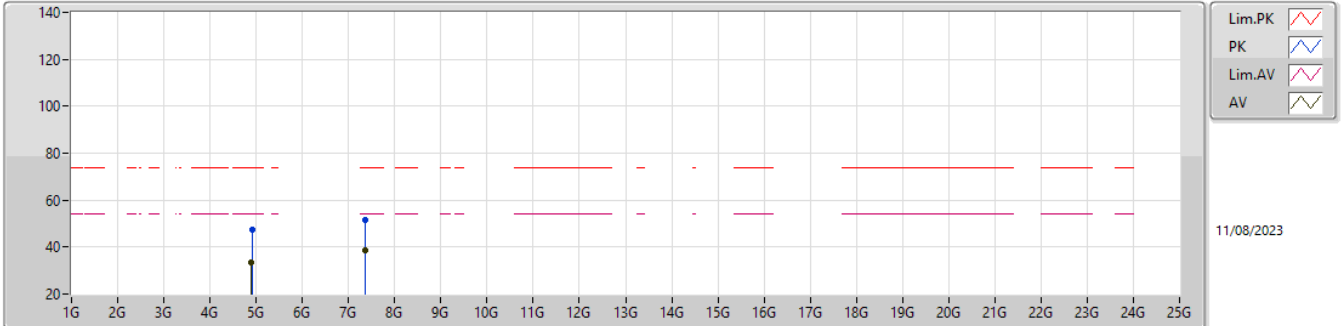

EUT_Y_2TX
Setting 18
04-M-M-2

Type	Freq (Hz)	Level (dBuV/m)	Limit (dBuV/m)	Margin (dB)	Raw (dBuV)	Dist (m)	Condition	Azimuth (°)	Height (m)	Comment	AF (dB)	CL (dB)	PA (dB)
PK	4.91352G	47.22	74.00	-26.78	41.50	3	Horizontal	263	1.43	-	32.83	5.30	32.41
AV	4.89412G	33.65	54.00	-20.35	28.02	3	Horizontal	263	1.43	-	32.79	5.30	32.46
PK	7.35524G	51.64	74.00	-22.36	41.11	3	Horizontal	314	1.45	-	37.68	6.96	34.11
AV	7.34984G	38.85	54.00	-15.15	28.31	3	Horizontal	314	1.45	-	37.70	6.95	34.11