

Vendor
(Arial Narrow)

MFG Factory (Arial Narrow, Point 4)

ACCTON

型號: WN3601A-EL(G730 US/TW/CN)

FIBEL3601C

SHIT KIT料號: PIBEL3601000E

ECN:MEMO

版本: R01

日期: 2002/03/07

BARCODE 型式:

HUB ADAPTER
 ACCTON ACCTON(電池包)
 NO BRAND ACCTON(紙盒包)
 OEM NO BRAND
 無 OEM
 無

UPC CODE 型式:

HUB ADAPTER
 ACCTON ACCTON
 OEM OEM
 無 無

UPC CODE:

BOX LABEL 型式:

HUB ADAPTER
 NO BRAND NO BRAND
 OEM OEM
 無 無

CARTON LABEL 製作:

ACCTON
 NO BRAND
 OEM
 無

Carton Number:

50 BOX of 1 Carton

FILE

Page 1 of 4

Design:Nina

PCBA
NIBEL3601000E

EPE FOAM
147070004900E

WHITE BOX
148020018200A

	料號	說明	數量
1	146000017200E	UL LABEL	1
2	146200003900E	EUM LABEL 30*5MM	2
3	146956-004	ACCLABEL 100*165MM	0.0017
4	147000005900E	CARTON 565*528*356MM	0.0017
5	148020018200A	WHITE BOX	0.0200
6	147070004900E	EPE FOAM(50PCS)	0.0200
7	147144-006	ANGLEBOARD	0.0006
8	147804-008	PALLET	0.00
9	246200000600A	MONTHLY LABEL	0.0017
10	NIBEL3601000E	PCBA	1
11			
12			
13			
14			
15			
16			
17			
18			
19			

LABEL 黏貼位置

BARCODE LABEL 30*5MM 146200003900E*1

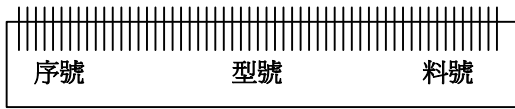

- P.S: 1. 流水號皆是以計總流水號從00001開始
 2. 型號 G730 XXXXXXXX (顯示客戶的型號)
 3. 料號 FIBEL3601XXXX
 4. TOYWXXXXXX 型號 料號
 5. 標碼面 TOYWXXXXXX

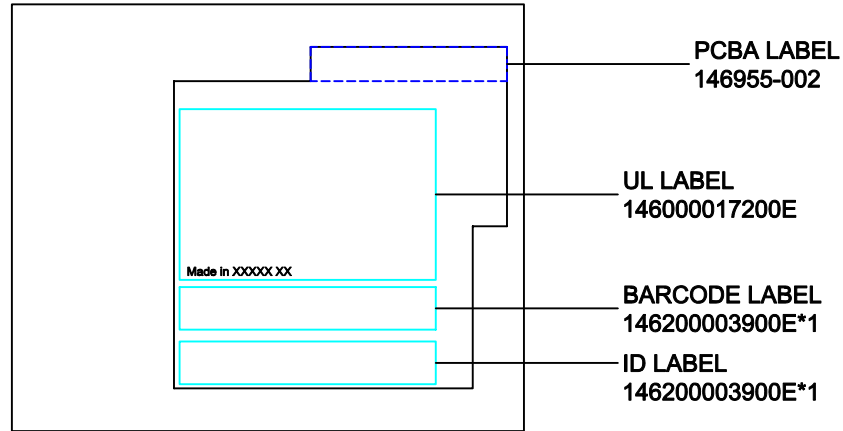
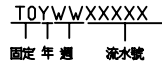

ID LABEL 30*5MM 146200003900E*1



- PS: 0030F1 XXXXXX
 固定 ID 流水號
 標碼出: 0030F1 XXXXXX
 文字面: 0030F1 XXXXXX

CARTON LABEL 146956-004

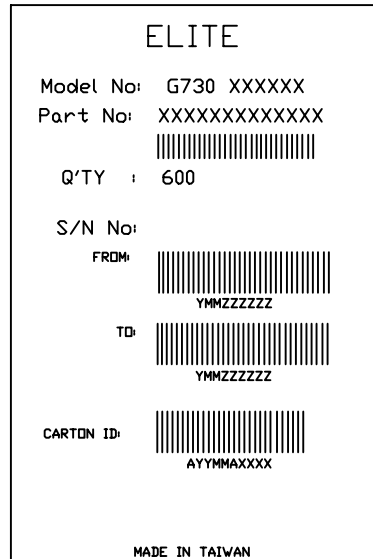

MODEL NO: 以客戶的名字為準 (G730 XXXXXX)
 S/N NO: 以包裝的號碼為主

YMMZZZZZZ

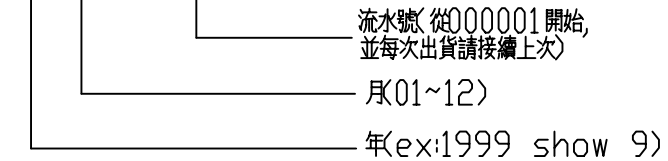

CARTON ID 流水號從A0001~Z9999採十進制
 月變流水號從A0001開始



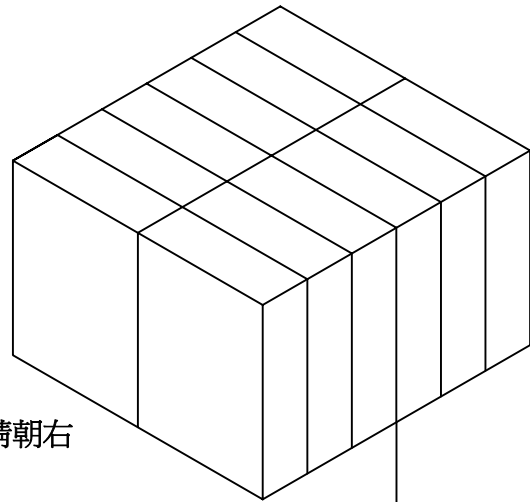

開口請朝右

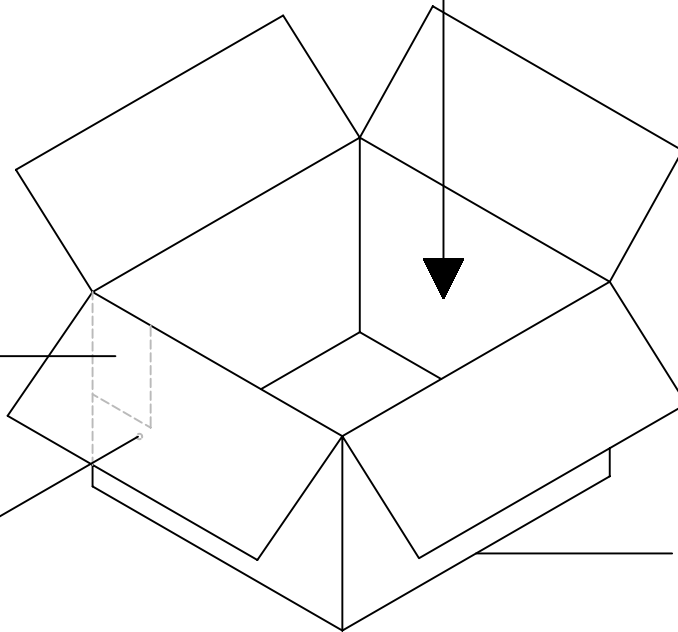

CARTON LABEL
146956-004

MONTHLY LABEL
1246200000600A

CARTON
147000005900E

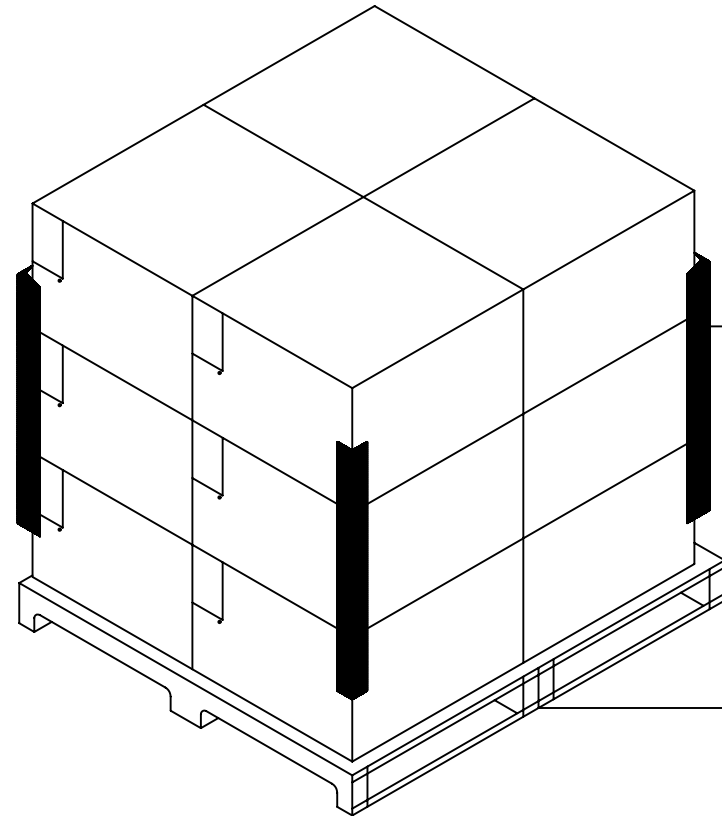

ANGLEBOARD
147144-006

PALLET
147804-008

FILE:

PAGE 3 OF 4

