



RADIO TEST REPORT

FCC ID : HEDEAP104
Equipment : Indoor Wall-Plate WiFi 6 Access Point
Brand Name : **E d g e - c o r e**
Model Name : EAP104
Applicant : Accton Technology Corp
No. 1, Creation Rd. III, Science-based Industrial
Park Hsin Chu 30077, Taiwan R.O.C.
Manufacturer (1) : Accton Technology Corp
No. 1, Creation Rd. III, Science-based Industrial
Park Hsin Chu 30077, Taiwan R.O.C.
Manufacturer (2) : Accton Technology Corporation Zhunan Factory
1F.& 5F, No. 1 , Keyi St., Zhunan Township, Miaoli
County 350 - TAIWAN
Standard : 47 CFR FCC Part 15.247

The product was received on Sep. 26, 2022, and testing was started from Sep. 27, 2022 and completed on Oct. 29, 2022. We, Sporton International Inc. Hsinchu Laboratory, would like to declare that the tested sample has been evaluated in accordance with the procedures given in ANSI C63.10-2013 and shown compliance with the applicable technical standards.

The test results in this report apply exclusively to the tested model / sample. Without written approval of Sporton International Inc. Hsinchu Laboratory, the test report shall not be reproduced except in full.

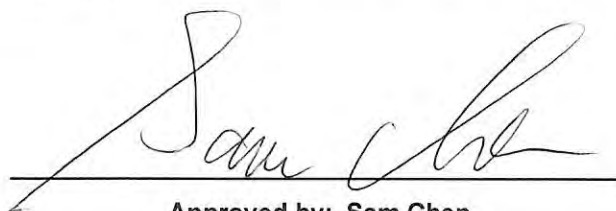

Approved by: Sam Chen

Sporton International Inc. Hsinchu Laboratory

No.8, Ln. 724, Bo'ai St., Zhubei City, Hsinchu County 302010, Taiwan (R.O.C.)



Table of Contents

History of this test report.....3

Summary of Test Result.....4

1 General Description5

1.1 Information.....5

1.2 Applicable Standards8

1.3 Testing Location Information8

1.4 Measurement Uncertainty8

2 Test Configuration of EUT9

2.1 Test Channel Mode9

2.2 The Worst Case Measurement Configuration9

2.3 EUT Operation during Test10

2.4 Accessories11

2.5 Support Equipment.....11

2.6 Test Setup Diagram13

3 Transmitter Test Result16

3.1 AC Power-line Conducted Emissions16

3.2 DTS Bandwidth.....18

3.3 Maximum Conducted Output Power19

3.4 Power Spectral Density22

3.5 Emissions in Non-restricted Frequency Bands24

3.6 Emissions in Restricted Frequency Bands.....25

4 Test Equipment and Calibration Data29

Appendix A. Test Results of AC Power-line Conducted Emissions

Appendix B. Test Results of DTS Bandwidth

Appendix C. Test Results of Maximum Conducted Output Power

Appendix D. Test Results of Power Spectral Density

Appendix E. Test Results of Emissions in Non-restricted Frequency Bands

Appendix F. Test Results of Emissions in Restricted Frequency Bands

Appendix G. Test Photos

Photographs of EUT v01



History of this test report

Report No.	Version	Description	Issued Date
FR292606AC	01	Initial issue of report	Dec. 06, 2022



Summary of Test Result

Report Clause	Ref Std. Clause	Test Items	Result (PASS/FAIL)	Remark
1.1.2	15.203	Antenna Requirement	PASS	-
3.1	15.207	AC Power-line Conducted Emissions	PASS	-
3.2	15.247(a)	DTS Bandwidth	PASS	-
3.3	15.247(b)	Maximum Conducted Output Power	PASS	-
3.4	15.247(e)	Power Spectral Density	PASS	-
3.5	15.247(d)	Emissions in Non-restricted Frequency Bands	PASS	-
3.6	15.247(d)	Emissions in Restricted Frequency Bands	PASS	-

Declaration of Conformity:

1. The test results with all measurement uncertainty excluded are presented in accordance with the regulation limits or requirements declared by manufacturers. It's means measurement values may risk exceeding the limit of regulation standards, if measurement uncertainty is include in test results.
2. The measurement uncertainty please refer to report "Measurement Uncertainty".

Comments and Explanations:

The declared of product specification for EUT presented in the report are provided by the manufacturer, and the manufacturer takes all the responsibilities for the accuracy of product specification.

Reviewed by: Sam Chen**Report Producer: Sophia Shiung**



1 General Description

1.1 Information

1.1.1 RF General Information

Frequency Range (MHz)	Bluetooth Mode	Ch. Frequency (MHz)	Channel Number
2400-2483.5	LE	2402-2480	0-39 [40]

Band	Mode	BWch (MHz)	Nant
2.4-2.4835GHz	BT-LE(1Mbps)	1.0	1TX
2.4-2.4835GHz	BT-LE(2Mbps)	2.0	1TX

Note:

- ♦ Bluetooth LE uses a GFSK modulation.
- ♦ BWch is the nominal channel bandwidth.

1.1.2 Antenna Information

Ant.	Port			Brand	Model Name	Antenna Type	Connector	Gain (dBi)
	WLAN 2.4GHz	WLAN 5GHz	Bluetooth					
1	1	-	-	Accton	EC-3-PB01-001	Dipole	I-PEX	3.94
2	2	-	-	Accton	EC-3-PB01-002	PIFA	I-PEX	3.11
3	-	1	-	Accton	EC-5-PB02-001	Monopole	I-PEX	5.21
4	-	2	-	Accton	EC-5-PB02-002	Monopole	I-PEX	5.11
5	-	-	1	Accton	EC-4-PB10-001	Dipole	I-PEX	4.22

Note 1: The above information was declared by manufacturer.



Note 2: Directional gain information

Type	Maximum Output Power	Power Spectral Density
Non-BF	Directional gain = Max.gain + array gain. For power measurements on IEEE 802.11 devices Array Gain = 0 dB (i.e., no array gain) for N ANT ≤ 4	$Directional\ iGain = 10 \cdot \log \left[\frac{\sum_{j=1}^{N_{SS}} \left\{ \sum_{k=1}^{N_{ANT}} g_{j,k} \right\}^2}{N_{ANT}} \right]$
BF	$Directional\ iGain = 10 \cdot \log \left[\frac{\sum_{j=1}^{N_{SS}} \left\{ \sum_{k=1}^{N_{ANT}} g_{j,k} \right\}^2}{N_{ANT}} \right]$	$Directional\ iGain = 10 \cdot \log \left[\frac{\sum_{j=1}^{N_{SS}} \left\{ \sum_{k=1}^{N_{ANT}} g_{j,k} \right\}^2}{N_{ANT}} \right]$

Ex.

Directional Gain (NSS1) formula :

$$Directional\ iGain = 10 \cdot \log \left[\frac{\sum_{j=1}^{N_{SS}} \left\{ \sum_{k=1}^{N_{ANT}} g_{j,k} \right\}^2}{N_{ANT}} \right]$$

$$NSS1(g1,1) = 10^{G1/20} ; NSS1(g1,2) = 10^{G2/20};$$

$$g_{j,k} = (NSS1(g1,1) + NSS1(g1,2))^2$$

$$DG = 10 \log[(NSS1(g1,1) + NSS1(g1,2))^2 / N_{ANT}] => 10 \log[(10^{G1/20} + 10^{G2/20})^2 / N_{ANT}]$$

Where ;

$$G1 = 10 ; G2 = 10$$

$$2.4G \quad G1 = 3.94 \text{ dBi}; G2 = 3.11 \text{ dBi}; \quad DG = 6.55 \text{ dBi}$$

$$5G \quad G1 = 5.21 \text{ dBi}; G2 = 5.11 \text{ dBi}; \quad DG = 8.16 \text{ dBi}$$

Note 3: **For WLAN 2.4GHz function:**

For IEEE 802.11 b/g/n/VHT/ax (2TX/2RX):

Port 1 and Port 2 can be used as transmitting/receiving antenna.

Port 1 and Port 2 could transmit/receive simultaneously.

For WLAN 5GHz function:

For IEEE 802.11a/n/ac/ax (2TX/2RX):

Port 1 and Port 2 can be used as transmitting/receiving antenna.

Port 1 and Port 2 could transmit/receive simultaneously.

For Bluetooth function (1TX/1RX):

Port 1 can be used as transmitting/receiving antenna.



1.1.3 Mode Test Duty Cycle

Mode	DC	DCF(dB)	T(s)	VBW(Hz) ≥ 1/T
BT-LE(1Mbps)	0.636	1.97	397.5u	3k
BT-LE(2Mbps)	0.34	4.69	212.5u	10k

Note:
♦ DC is Duty Cycle.
♦ DCF is Duty Cycle Factor.

1.1.4 EUT Operational Condition

EUT Power Type	From Power Adapter or PoE		
Function	<input checked="" type="checkbox"/> Point-to-multipoint	<input type="checkbox"/> Point-to-point	
Test Software Version	Btool V1.42.19		
Support Mode	<input checked="" type="checkbox"/> LE 1M PHY: 1 Mb/s		
	<input type="checkbox"/> LE Coded PHY (S=2): 500 Kb/s		
	<input type="checkbox"/> LE Coded PHY (S=8): 125 Kb/s		
	<input checked="" type="checkbox"/> LE 2M PHY: 2 Mb/s		

Note: The above information was declared by manufacturer.



1.2 Applicable Standards

According to the specifications of the manufacturer, the EUT must comply with the requirements of the following standards:

- ♦ 47 CFR FCC Part 15.247
- ♦ ANSI C63.10-2013

The following reference test guidance is not within the scope of accreditation of TAF.

- ♦ FCC KDB 558074 D01 v05r02
- ♦ FCC KDB 414788 D01 v01r01

1.3 Testing Location Information

Testing Location Information	
Test Lab. : Sporton International Inc. Hsinchu Laboratory	
Hsinchu (TAF: 3787)	ADD: No.8, Ln. 724, Bo'ai St., Zhubei City, Hsinchu County 302010, Taiwan (R.O.C.) TEL: 886-3-656-9065 FAX: 886-3-656-9085 Test site Designation No. TW3787 with FCC. Conformity Assessment Body Identifier (CABID) TW3787 with ISED.

Test Condition	Test Site No.	Test Engineer	Test Environment (°C / %)	Test Date
RF Conducted	TH03-CB	Owen Hsu	23.6~23.7 / 56~67	Oct. 01, 2022~ Oct. 29, 2022
Radiated < 1GHz	03CH06-CB	Stim Sung	23.5-24.5 / 45-55	Oct. 20, 2022~ Oct. 21, 2022
Radiated > 1GHz	03CH02-CB	Chris Lee	23~23.5 / 55~60	Sep. 27, 2022~ Oct. 28, 2022
AC Conduction	CO01-CB	Elvin Yeh	21~23 / 58-61	Oct. 24, 2022

1.4 Measurement Uncertainty

ISO/IEC 17025 requires that an estimate of the measurement uncertainties associated with the emissions test results be included in the report. The measurement uncertainties given below are based on a 95% confidence level (based on a coverage factor (k=2))

Test Items	Uncertainty	Remark
Conducted Emission (150kHz ~ 30MHz)	3.4 dB	Confidence levels of 95%
Radiated Emission (9kHz ~ 30MHz)	3.4 dB	Confidence levels of 95%
Radiated Emission (30MHz ~ 1,000MHz)	5.6 dB	Confidence levels of 95%
Radiated Emission (1GHz ~ 18GHz)	5.2 dB	Confidence levels of 95%
Radiated Emission (18GHz ~ 40GHz)	4.7 dB	Confidence levels of 95%
Conducted Emission	3.2 dB	Confidence levels of 95%
Output Power Measurement	0.8 dB	Confidence levels of 95%
Power Density Measurement	3.2 dB	Confidence levels of 95%
Bandwidth Measurement	2.0 %	Confidence levels of 95%



2 Test Configuration of EUT

2.1 Test Channel Mode

Mode	Power Setting
BT-LE(1Mbps)	-
2402MHz	Default
2440MHz	Default
2480MHz	Default
BT-LE(2Mbps)	-
2402MHz	Default
2440MHz	Default
2480MHz	Default

2.2 The Worst Case Measurement Configuration

The Worst Case Mode for Following Conformance Tests	
Tests Item	AC power-line conducted emissions
Condition	AC power-line conducted measurement for line and neutral Test Voltage: 120Vac / 60Hz
Operating Mode	Normal Link
1	EUT + Adapter
2	EUT + PoE

Mode 2 generated the worst test result, so it was recorded in this report.

The Worst Case Mode for Following Conformance Tests	
Tests Item	DTS Bandwidth Maximum Conducted Output Power Power Spectral Density Emissions in Non-restricted Frequency Bands
Test Condition	Conducted measurement at transmit chains



The Worst Case Mode for Following Conformance Tests	
Tests Item	Emissions in Restricted Frequency Bands
Test Condition	Radiated measurement If EUT consist of multiple antenna assembly (multiple antenna are used in EUT regardless of spatial multiplexing MIMO configuration), the radiated test should be performed with highest antenna gain of each antenna type.
Operating Mode < 1GHz	Normal Link
After evaluation, EUT in Z axis was the worst case at Radiated Emissions test, and it was tested and recorded in this report.	
1	Normal link: EUT in X axis + Adapter
2	Normal link: EUT in Y axis + Adapter
3	Normal link: EUT in Z axis + Adapter
Mode 1 has been evaluated to be the worst case among Mode 1~3, thus measurement for Mode 4 will follow this same test mode.	
4	Normal link: EUT in Z axis + PoE
Mode 3 generated the worst test result, so it was recorded in this report.	
Operating Mode > 1GHz	CTX
After evaluating, the worst case was found as below. So the measurement will follow this same test configuration.	
1	EUT in X axis

The Worst Case Mode for Following Conformance Tests	
Tests Item	Simultaneous Transmission Analysis - Co-location RF Exposure Evaluation
Operating Mode	
1	WLAN 2.4GHz + WLAN 5GHz + Bluetooth
Refer to Sporton Test Report No.: FA292606 for Co-location RF Exposure Evaluation.	

Note: The adapter and PoE were for measurement only and would not be marketed. Their information is showed as below:

Equipment	Brand	Model
Adapter	ITE	MU12AR120100-A1
PoE	PHIHONG	POEA30U-1ATE

2.3 EUT Operation during Test

For CTX Mode:

The EUT was programmed to be in continuously transmitting mode.

For Normal Link Mode:

During the test, the EUT operation to normal function.



2.4 Accessories

Others
Wall-mounted rack*1
RJ-45 cable*1 (Non-shielded, 0.05m)

2.5 Support Equipment

For AC Conduction:

Support Equipment				
No.	Equipment	Brand Name	Model Name	FCC ID
A	Pass-Thru NB	DELL	E6430	N/A
B	LAN1 NB	DELL	E6430	N/A
C	Device NB	DELL	E6430	N/A
D	Device	Accton	EAP104	N/A
E	2.4G NB	DELL	E6430	N/A
F	5G NB	DELL	E6430	N/A
G	iPad	Apple	A1430	N/A
H	PoE	PHIHONG	POEA30U-1ATE	N/A
I	LAN4 NB	DELL	E6430	N/A

For Radiated (below 1GHz):

Support Equipment				
No.	Equipment	Brand Name	Model Name	FCC ID
A	LAN1 NB	DELL	E4300	N/A
B	Pass-Thru NB	DELL	E4300	N/A
C	iPad	Apple	A1430	N/A
D	2.4G NB	DELL	E4300	N/A
E	5G NB	DELL	E4300	N/A
F	Adapter	ITE	MU12AR120100-A1	N/A

For Radiated (above 1GHz):

Support Equipment				
No.	Equipment	Brand Name	Model Name	FCC ID
A	NB	Lenovo	L440	N/A
B	Adapter	ITE	MU12AR120100-A1	N/A



For RF Conducted:

Support Equipment				
No.	Equipment	Brand Name	Model Name	FCC ID
A	NB	DELL	E4300	N/A
B	AC Adapter	ITE	MU12AR120100-A1	N/A

2.6 Test Setup Diagram

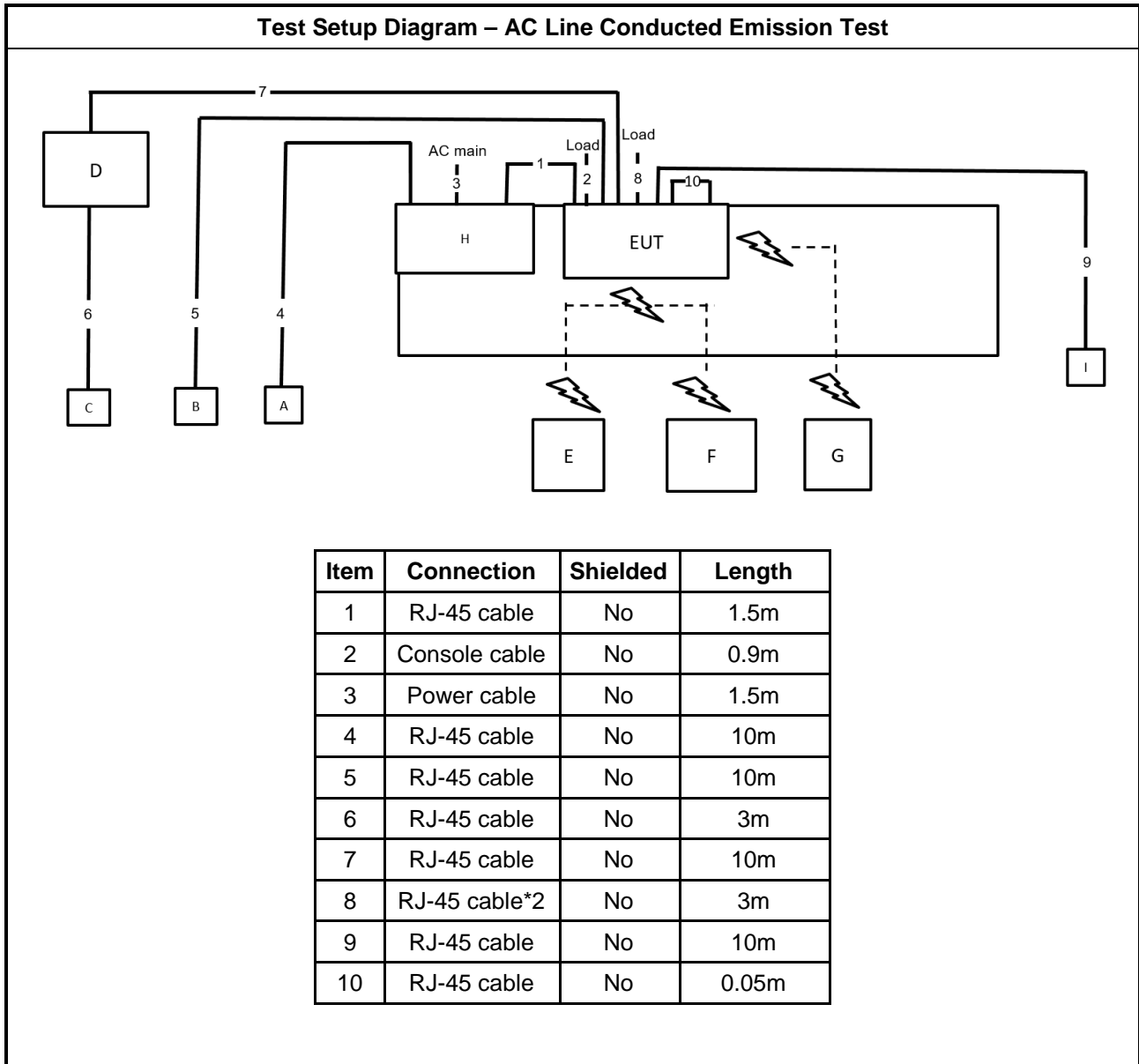

Test Setup Diagram - Radiated Test < 1GHz

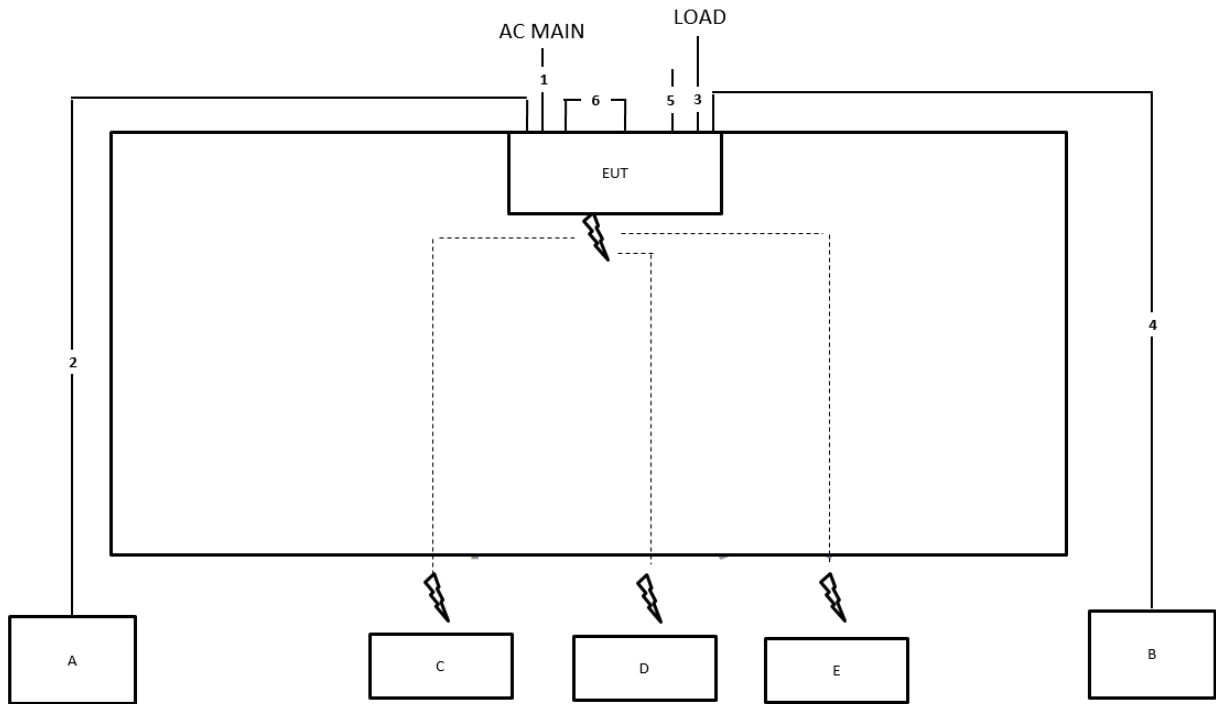

Item	Connection	Shielded	Length
1	Power cable	No	1.5m
2	RJ-45 cable	No	10m
3	RJ-45 cable*3	No	1.5m
4	RJ-45 cable	No	10m
5	Console cable	Yes	0.9m
6	RJ-45 cable	No	0.05m

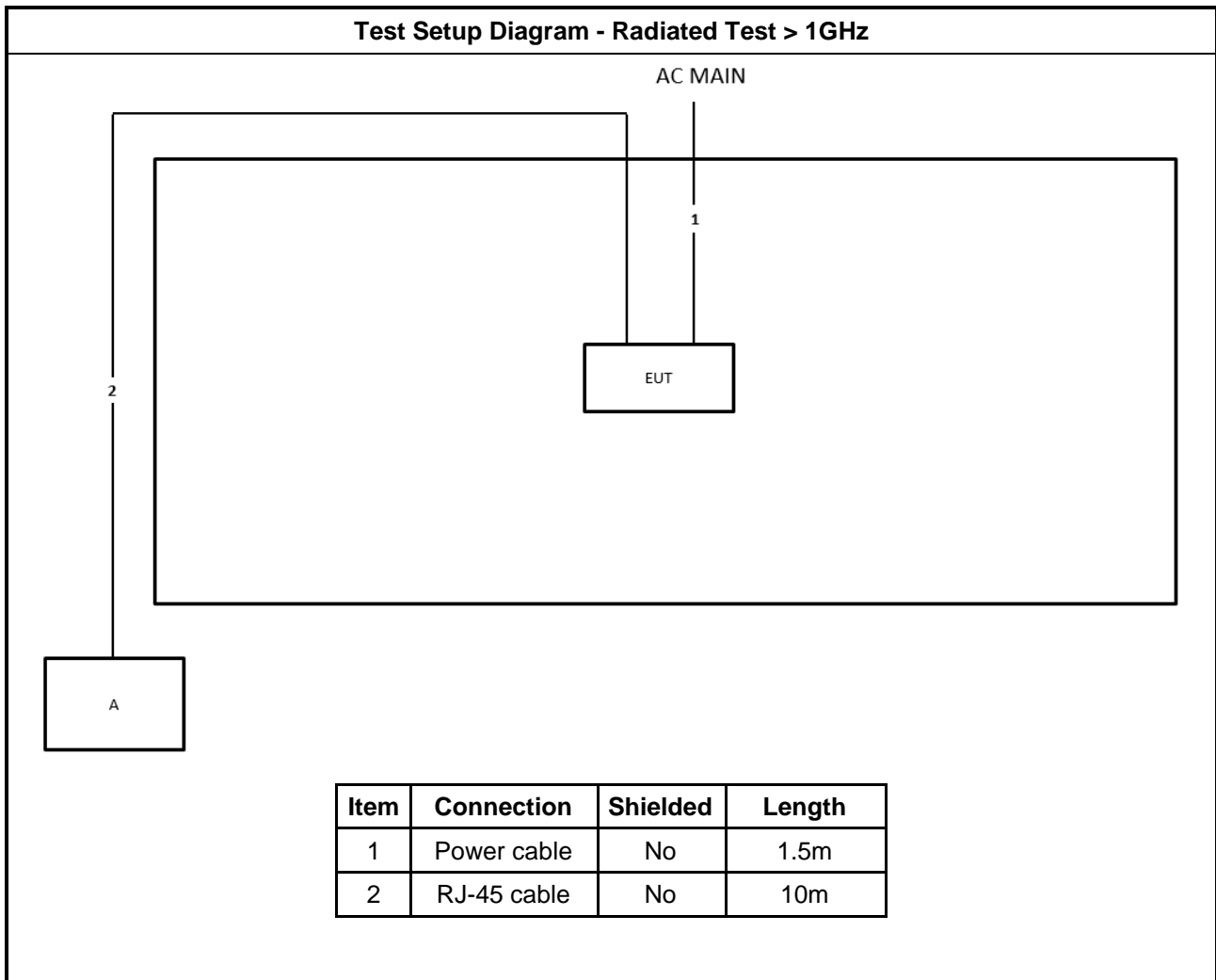



3 Transmitter Test Result

3.1 AC Power-line Conducted Emissions

3.1.1 AC Power-line Conducted Emissions Limit

AC Power-line Conducted Emissions Limit		
Frequency Emission (MHz)	Quasi-Peak	Average
0.15-0.5	66 - 56 *	56 - 46 *
0.5-5	56	46
5-30	60	50

Note 1: * Decreases with the logarithm of the frequency.

3.1.2 Measuring Instruments

Refer a test equipment and calibration data table in this test report.

3.1.3 Test Procedures

Test Method
▪ Refer as ANSI C63.10-2013, clause 6.2 for AC power-line conducted emissions.

3.1.4 Test Setup

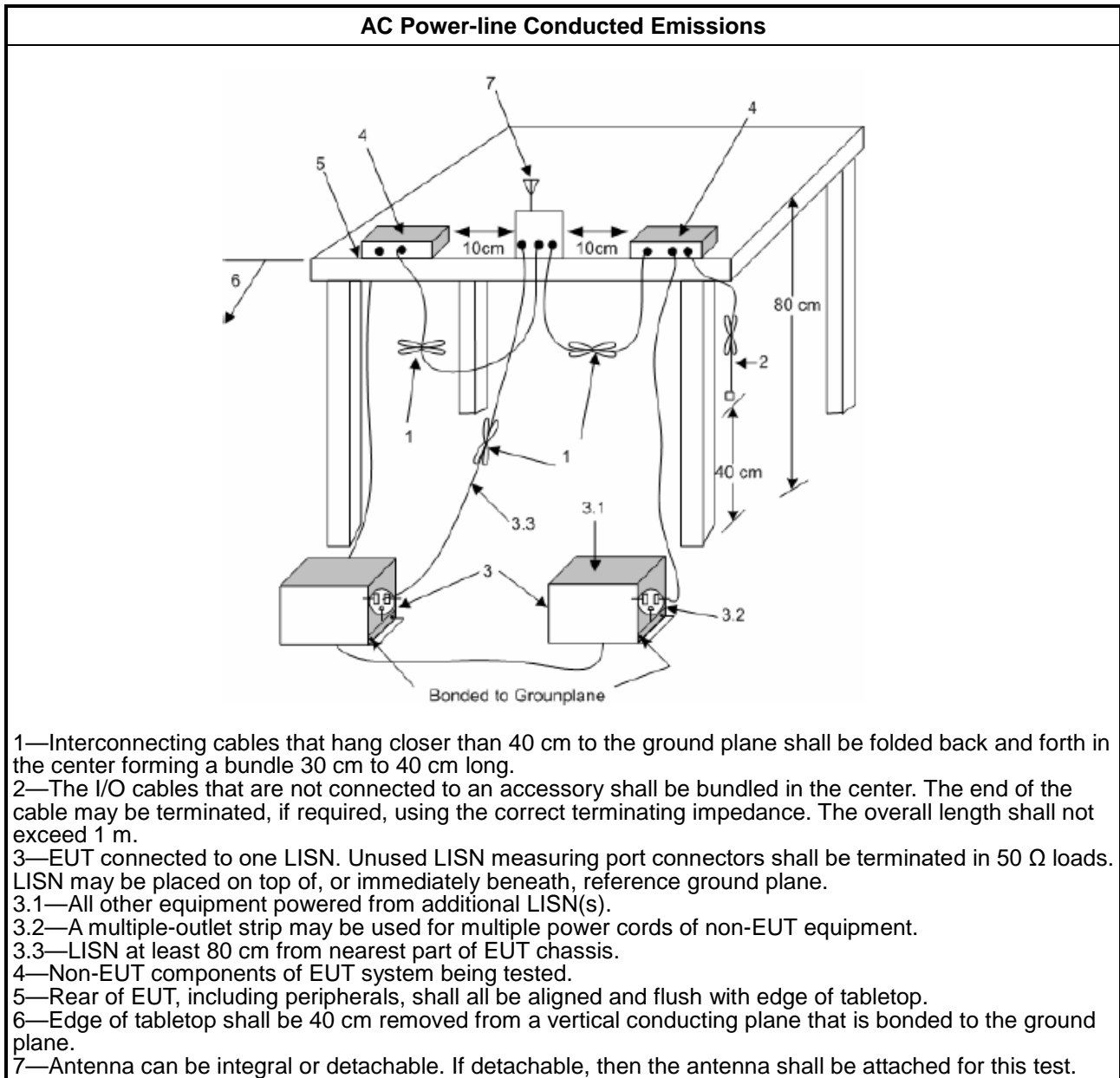

1.1.1. Measurement Results Calculation

The measured Level is calculated using:

- a. Corrected Reading: LISN Factor (LISN) + Attenuator (AT/AUX) + Cable Loss (CL) + Read Level (Raw) = Level
- b. Margin = -Limit + Level

3.1.5 Test Result of AC Power-line Conducted Emissions

Refer as Appendix A

3.2 DTS Bandwidth

3.2.1 6dB Bandwidth Limit

6dB Bandwidth Limit
Systems using digital modulation techniques:
<ul style="list-style-type: none"> ▪ 6 dB bandwidth \geq 500 kHz.

3.2.2 Measuring Instruments

Refer a test equipment and calibration data table in this test report.

3.2.3 Test Procedures

Test Method
<ul style="list-style-type: none"> ▪ For the emission bandwidth shall be measured using one of the options below:
<input checked="" type="checkbox"/> Refer as FCC KDB 558074, clause 8.2 & C63.10 clause 11.8.1 Option 1 for 6 dB bandwidth measurement.
<input type="checkbox"/> Refer as FCC KDB 558074, clause 8.2 & C63.10 clause 11.8.2 Option 2 for 6 dB bandwidth measurement.
<input type="checkbox"/> Refer as ANSI C63.10, clause 6.9.1 for occupied bandwidth testing.

3.2.4 Test Setup

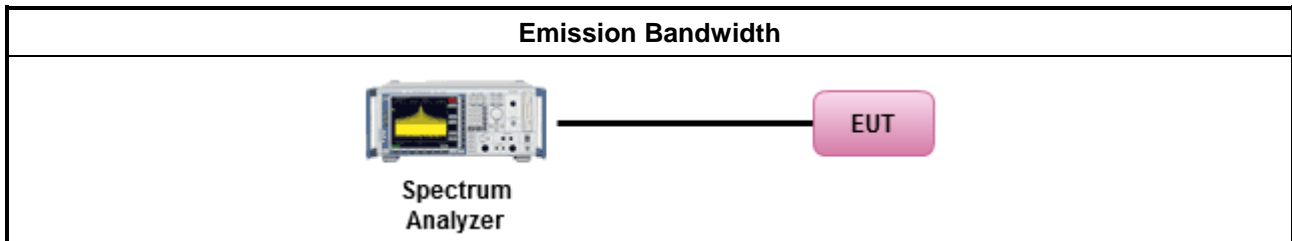

3.2.5 Test Result of Emission Bandwidth

Refer as Appendix B



3.3 Maximum Conducted Output Power

3.3.1 Maximum Conducted Output Power Limit

Maximum Conducted Output Power Limit	
	<ul style="list-style-type: none"> ▪ If $G_{TX} \leq 6$ dBi, then $P_{Out} \leq 30$ dBm (1 W)
	<ul style="list-style-type: none"> ▪ Point-to-multipoint systems (P2M): If $G_{TX} > 6$ dBi, then $P_{Out} = 30 - (G_{TX} - 6)$ dBm
	<ul style="list-style-type: none"> ▪ Point-to-point systems (P2P): If $G_{TX} > 6$ dBi, then $P_{Out} = 30 - (G_{TX} - 6)/3$ dBm
	<ul style="list-style-type: none"> ▪ Smart antenna system (SAS):
	<ul style="list-style-type: none"> - Single beam: If $G_{TX} > 6$ dBi, then $P_{Out} = 30 - (G_{TX} - 6)/3$ dBm
	<ul style="list-style-type: none"> - Overlap beam: If $G_{TX} > 6$ dBi, then $P_{Out} = 30 - (G_{TX} - 6)/3$ dBm
	<ul style="list-style-type: none"> - Aggregate power on all beams: If $G_{TX} > 6$ dBi, then $P_{Out} = 30 - (G_{TX} - 6)/3 + 8$ dB dBm
P_{Out} = maximum peak conducted output power or maximum conducted output power in dBm, G_{TX} = the maximum transmitting antenna directional gain in dBi.	

3.3.2 Measuring Instruments

Refer a test equipment and calibration data table in this test report.



3.3.3 Test Procedures

Test Method	
<ul style="list-style-type: none"> ▪ Maximum Peak Conducted Output Power 	
	<input type="checkbox"/> Refer as FCC KDB 558074, clause 8.3.1.1 & C63.10 clause 11.9.1.1 (RBW ≥ EBW method).
	<input type="checkbox"/> Refer as FCC KDB 558074, clause 8.3.1.3 & C63.10 clause 11.9.1.3 (peak power meter).
<ul style="list-style-type: none"> ▪ Maximum Conducted Output Power 	
[duty cycle ≥ 98% or external video / power trigger]	
	<input type="checkbox"/> Refer as FCC KDB 558074, clause 8.3.2.2 & C63.10 clause 11.9.2.2.2 Method AVGSA-1.
	<input type="checkbox"/> Refer as FCC KDB 558074, clause 8.3.2.2 & C63.10 clause 11.9.2.2.3 Method AVGSA-1A. (alternative)
duty cycle < 98% and average over on/off periods with duty factor	
	<input type="checkbox"/> Refer as FCC KDB 558074, clause 8.3.2.2 & C63.10 clause 11.9.2.2.4 Method AVGSA-2.
	<input type="checkbox"/> Refer as FCC KDB 558074, clause 8.3.2.2 & C63.10 clause 11.9.2.2.5 Method AVGSA-2A (alternative)
	<input type="checkbox"/> Refer as FCC KDB 558074, clause 8.3.2.2 & C63.10 clause 11.9.2.2.6 Method AVGSA-3
	<input type="checkbox"/> Refer as FCC KDB 558074, clause 8.3.2.2 & C63.10 clause 11.9.2.2.7 Method AVGSA-3A (alternative)
Measurement using a power meter (PM)	
	<input type="checkbox"/> Refer as FCC KDB 558074, clause 8.3.2.3 & C63.10 clause 11.9.2.3.1 Method AVGPM (using an RF average power meter).
	<input checked="" type="checkbox"/> Refer as FCC KDB 558074, clause 8.3.2.3 & C63.10 clause 11.9.2.3.2 Method AVGPM-G (using an gate RF average power meter).
<ul style="list-style-type: none"> ▪ For conducted measurement. 	
	<ul style="list-style-type: none"> ▪ If the EUT supports multiple transmit chains using options given below: Refer as FCC KDB 662911, In-band power measurements. Using the measure-and-sum approach, measured all transmit ports individually. Sum the power (in linear power units e.g., mW) of all ports for each individual sample and save them.
	<ul style="list-style-type: none"> ▪ If multiple transmit chains, EIRP calculation could be following as methods: $P_{total} = P_1 + P_2 + \dots + P_n$ (calculated in linear unit [mW] and transfer to log unit [dBm]) $EIRP_{total} = P_{total} + DG$

3.3.4 Test Setup

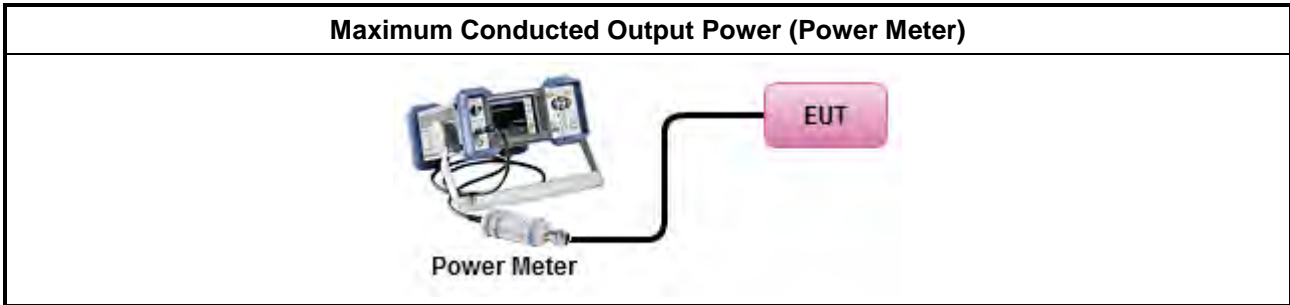

3.3.5 Test Result of Maximum Conducted Output Power

Refer as Appendix C



3.4 Power Spectral Density

3.4.1 Power Spectral Density Limit

Power Spectral Density Limit
<ul style="list-style-type: none"> Power Spectral Density (PSD) ≤ 8 dBm/3kHz

3.4.2 Measuring Instruments

Refer a test equipment and calibration data table in this test report.

3.4.3 Test Procedures

Test Method
<ul style="list-style-type: none"> Peak power spectral density procedures that the same method as used to determine the conducted output power. If maximum peak conducted output power was measured to demonstrate compliance to the output power limit, then the peak PSD procedure below (Method PKPSD) shall be used. If maximum conducted output power was measured to demonstrate compliance to the output power limit, then one of the average PSD procedures shall be used, as applicable based on the following criteria (the peak PSD procedure is also an acceptable option).
<input checked="" type="checkbox"/> Refer as FCC KDB 558074, clause 8.4 & C63.10 clause 11.10 Method Max. PSD. [duty cycle ≥ 98% or external video / power trigger]
<ul style="list-style-type: none"> For conducted measurement.
<ul style="list-style-type: none"> If The EUT supports multiple transmit chains using options given below: <ul style="list-style-type: none"> <input type="checkbox"/> Option 1: Measure and sum the spectra across the outputs. Refer as FCC KDB 662911, In-band power spectral density (PSD). Sample all transmit ports simultaneously using a spectrum analyzer for each transmit port. Where the trace bin-by-bin of each transmit port summing can be performed. (i.e., in the first spectral bin of output 1 is summed with that in the first spectral bin of output 2 and that from the first spectral bin of output 3, and so on up to the NTX output to obtain the value for the first frequency bin of the summed spectrum.). Add up the amplitude (power) values for the different transmit chains and use this as the new data trace. <input type="checkbox"/> Option 2: Measure and sum spectral maxima across the outputs. With this technique, spectra are measured at each output of the device at the required resolution bandwidth. The maximum value (peak) of each spectrum is determined. These maximum values are then summed mathematically in linear power units across the outputs. These operations shall be performed separately over frequency spans that have different out-of-band or spurious emission limits, <input type="checkbox"/> Option 3: Measure and add 10 log(N) dB, where N is the number of transmit chains. Refer as FCC KDB 662911, In-band power spectral density (PSD). Performed at each transmit chains and each transmit chains shall be compared with the limit have been reduced with 10 log(N). Or each transmit chains shall be add 10 log(N) to compared with the limit.

3.4.4 Test Setup

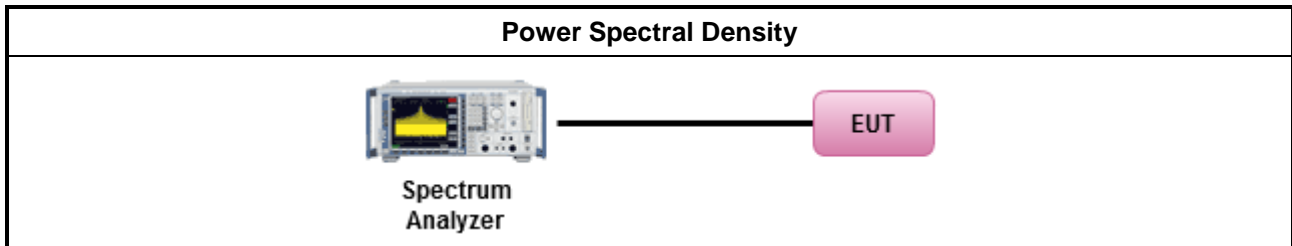

3.4.5 Test Result of Power Spectral Density

Refer as Appendix D

3.5 Emissions in Non-restricted Frequency Bands

3.5.1 Emissions in Non-restricted Frequency Bands Limit

Un-restricted Band Emissions Limit	
RF output power procedure	Limit (dBc)
Peak output power procedure	20
Average output power procedure	30

Note 1: If the peak output power procedure is used to measure the fundamental emission power to demonstrate compliance to requirements, then the peak conducted output power measured within any 100 kHz outside the authorized frequency band shall be attenuated by at least 20 dB relative to the maximum measured in-band peak PSD level.

Note 2: If the average output power procedure is used to measure the fundamental emission power to demonstrate compliance to requirements, then the power in any 100 kHz outside of the authorized frequency band shall be attenuated by at least 30 dB relative to the maximum measured in-band average PSD level.

3.5.2 Measuring Instruments

Refer a test equipment and calibration data table in this test report.

3.5.3 Test Procedures

Test Method
<ul style="list-style-type: none"> Refer as FCC KDB 558074, clause 8.5 for unwanted emissions into non-restricted bands.

3.5.4 Test Setup

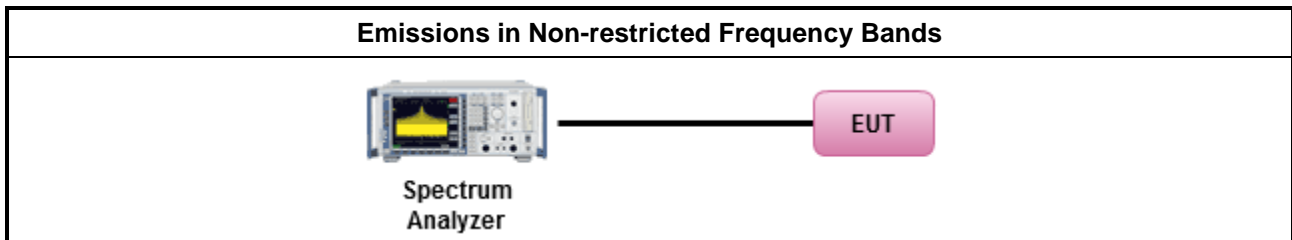

3.5.5 Test Result of Emissions in Non-restricted Frequency Bands

Refer as Appendix E



3.6 Emissions in Restricted Frequency Bands

3.6.1 Emissions in Restricted Frequency Bands Limit

Restricted Band Emissions Limit			
Frequency Range (MHz)	Field Strength (uV/m)	Field Strength (dBuV/m)	Measure Distance (m)
0.009~0.490	2400/F(kHz)	48.5 - 13.8	300
0.490~1.705	24000/F(kHz)	33.8 - 23	30
1.705~30.0	30	29	30
30~88	100	40	3
88~216	150	43.5	3
216~960	200	46	3
Above 960	500	54	3

Note 1: Test distance for frequencies at or above 30 MHz, measurements may be performed at a distance other than the limit distance provided they are not performed in the near field and the emissions to be measured can be detected by the measurement equipment. When performing measurements at a distance other than that specified, the results shall be extrapolated to the specified distance using an extrapolation factor of 20 dB/decade (inverse of linear distance for field-strength measurements, inverse of linear distance-squared for power-density measurements).

Note 2: Test distance for frequencies at below 30 MHz, measurements may be performed at a distance closer than the EUT limit distance; however, an attempt should be made to avoid making measurements in the near field. When performing measurements below 30 MHz at a closer distance than the limit distance, the results shall be extrapolated to the specified distance by either making measurements at a minimum of two or more distances on at least one radial to determine the proper extrapolation factor or by using the square of an inverse linear distance extrapolation factor (40 dB / decade). The test report shall specify the extrapolation method used to determine compliance of the EUT.

Note 3: Using the distance of 1m during the test for above 18 GHz, and the test value to correct for the distance factor at 3m.

3.6.2 Measuring Instruments

Refer a test equipment and calibration data table in this test report.



3.6.3 Test Procedures

Test Method	
<ul style="list-style-type: none"> ▪ The average emission levels shall be measured in [duty cycle ≥ 98 or duty factor]. 	
<ul style="list-style-type: none"> ▪ Refer as ANSI C63.10, clause 6.10.3 band-edge testing shall be performed at the lowest frequency channel and highest frequency channel within the allowed operating band. 	
<ul style="list-style-type: none"> ▪ For the transmitter unwanted emissions shall be measured using following options below: 	
	<ul style="list-style-type: none"> ▪ Refer as FCC KDB 558074, clause 8.6 for unwanted emissions into restricted bands.
	<input type="checkbox"/> Refer as FCC KDB 558074, clause 8.6 & C63.10 clause 11.12.2.5.1(trace averaging for duty cycle ≥98%).
	<input type="checkbox"/> Refer as FCC KDB 558074, clause 8.6 & C63.10 clause 11.12.2.5.2(trace averaging + duty factor).
	<input checked="" type="checkbox"/> Refer as FCC KDB 558074, clause 8.6 & C63.10 clause 11.12.2.5.3(Reduced VBW≥1/T).
	<input type="checkbox"/> Refer as ANSI C63.10, clause 11.12.2.5.3 (Reduced VBW). VBW ≥ 1/T, where T is pulse time.
	<input type="checkbox"/> Refer as ANSI C63.10, clause 7.5 average value of pulsed emissions.
	<input checked="" type="checkbox"/> Refer as FCC KDB 558074, clause 8.6 & C63.10 clause 11.12.2.4 measurement procedure peak limit.
<ul style="list-style-type: none"> ▪ For the transmitter band-edge emissions shall be measured using following options below: 	
	<ul style="list-style-type: none"> ▪ Refer as FCC KDB 558074 clause 8.7 & c63.10 clause 11.13.1, When the performing peak or average radiated measurements, emissions within 2 MHz of the authorized band edge may be measured using the marker-delta method described below.
	<ul style="list-style-type: none"> ▪ Refer as FCC KDB 558074, clause 8.7 (ANSI C63.10, clause 6.10.6) for marker-delta method for band-edge measurements.
	<ul style="list-style-type: none"> ▪ Refer as FCC KDB 558074, clause 8.7 for narrower resolution bandwidth (100kHz) using the band power and summing the spectral levels (i.e., 1 MHz).
	<ul style="list-style-type: none"> ▪ For conducted unwanted emissions into restricted bands (absolute emission limits). Devices with multiple transmit chains using options given below: (1) Measure and sum the spectra across the outputs or (2) Measure and add 10 log(N) dB
	<ul style="list-style-type: none"> ▪ For FCC KDB 662911 The methodology described here may overestimate array gain, thereby resulting in apparent failures to satisfy the out-of-band limits even if the device is actually compliant. In such cases, compliance may be demonstrated by performing radiated tests around the frequencies at which the apparent failures occurred.

3.6.4 Test Setup

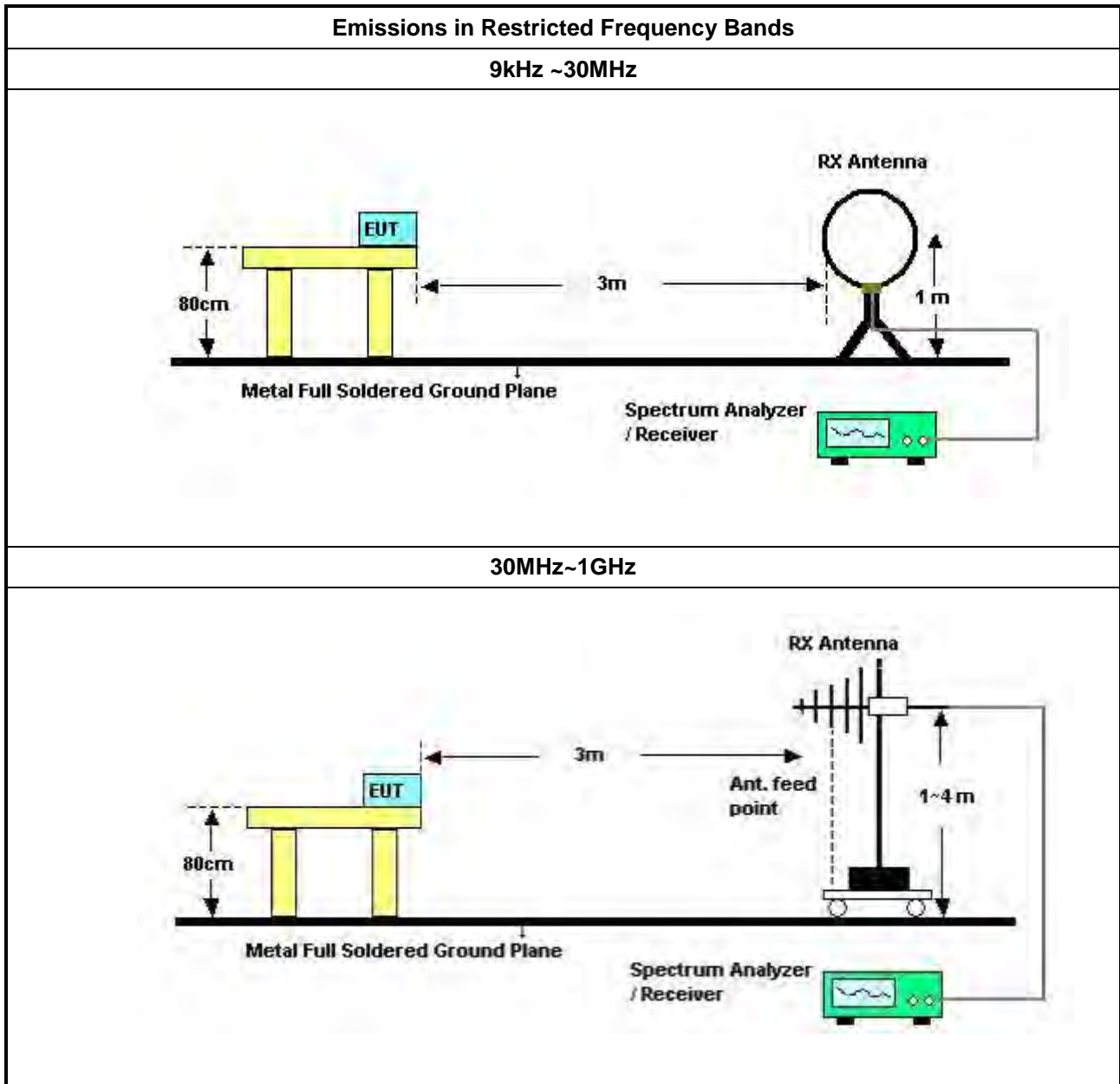

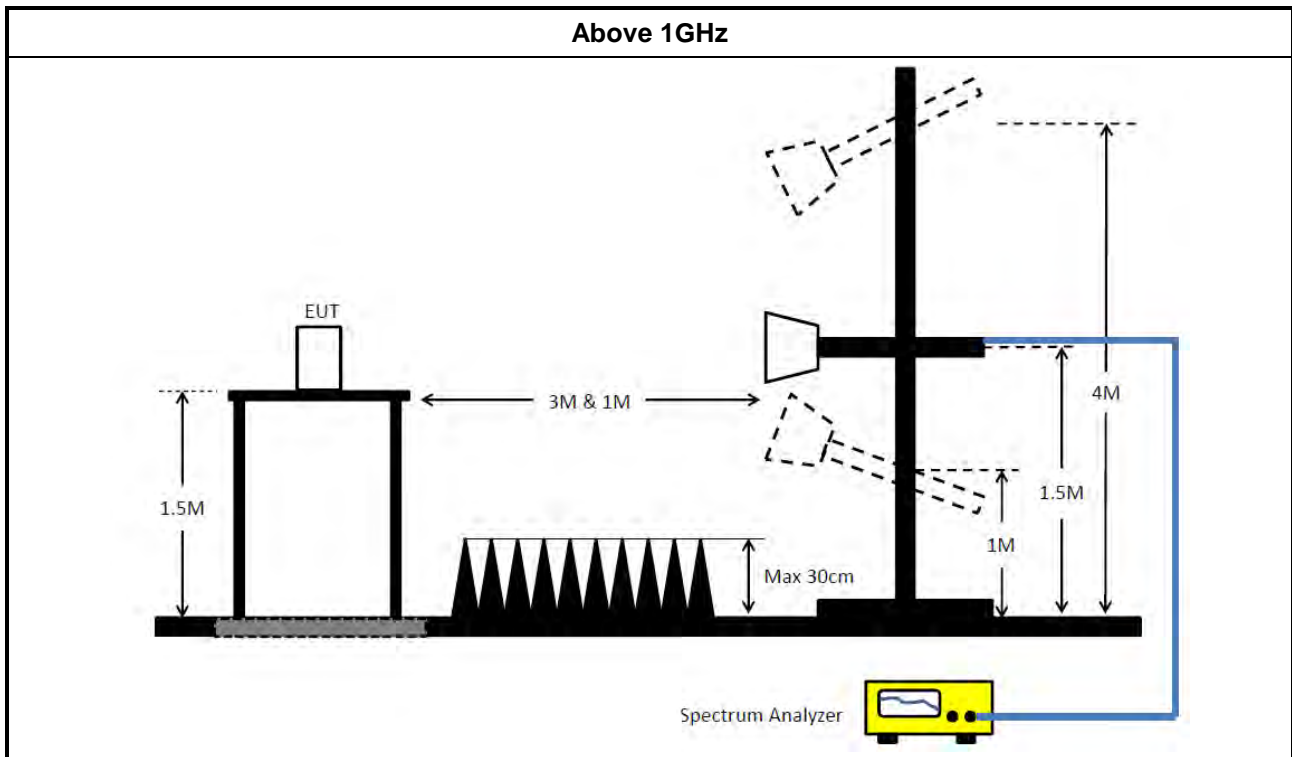

3.6.5 Measurement Results Calculation

The measured Level is calculated using:

Corrected Reading: Antenna factor (AF) + Cable loss (CL) + Read level (Raw) - Preamp factor (PA)(if applicable) = Level.

3.6.6 Emissions in Restricted Frequency Bands (Below 30MHz)

There is a comparison data of both open-field test site and alternative test site - semi-Anechoic chamber according to KDB414788 Radiated Test Site, and the result came out very similar.

All amplitude of spurious emissions that are attenuated by more than 20 dB below the permissible value has no need to be reported.

The radiated emissions were investigated from 9 kHz or the lowest frequency generated within the device, up to the 10th harmonic or 40 GHz, whichever is appropriate.

3.6.7 Test Result of Emissions in Restricted Frequency Bands

Refer as Appendix F



4 Test Equipment and Calibration Data

Instrument	Brand	Model No.	Serial No.	Characteristics	Calibration Date	Calibration Due Date	Remark
EMI Receiver	Agilent	N9038A	My52260123	9kHz ~ 8.4GHz	Feb. 22, 2022	Feb. 21, 2023	Conduction (CO01-CB)
LISN	F.C.C.	FCC-LISN-50-16-2	04083	150kHz ~ 100MHz	Feb. 09, 2022	Feb. 08, 2023	Conduction (CO01-CB)
LISN	Schwarzbeck	NSLK 8127	8127647	9kHz ~ 30MHz	Apr. 12, 2022	Apr. 11, 2023	Conduction (CO01-CB)
Pulse Limiter	Rohde & Schwarz	ESH3-Z2	100430	9kHz ~ 30MHz	Feb. 10, 2022	Feb. 09, 2023	Conduction (CO01-CB)
COND Cable	Woken	Cable	Low cable-CO01	9kHz ~ 30MHz	Oct. 18, 2022	Oct. 17, 2023	Conduction (CO01-CB)
Software	SPORTON	SENSE	V5.10	-	N.C.R.	N.C.R.	Conduction (CO01-CB)
Loop Antenna	Teseq	HLA 6120	24155	9kHz - 30 MHz	May 14, 2022	May 13, 2023	Radiation (03CH06-CB)
3m Semi Anechoic Chamber NSA	TDK	SAC-3M	03CH06-CB	30 MHz ~ 1 GHz	Aug. 04, 2022	Aug. 03, 2023	Radiation (03CH06-CB)
Bilog Antenna with 6 dB attenuator	TESEQ & EMCI	CBL6112D & N-6-06	37878 & AT-N0606	20MHz ~ 2GHz	Jul. 31, 2022	Jul. 30, 2023	Radiation (03CH06-CB)
Pre-Amplifier	Agilent	310N	187290	0.1MHz ~ 1GHz	Nov. 04, 2021	Nov. 03, 2022	Radiation (03CH06-CB)
Spectrum analyzer	R&S	FSP40	100080	9kHz~40GHz	Dec. 24, 2021	Dec. 23, 2022	Radiation (03CH06-CB)
EMI Test Receiver	R&S	ESCS	826547/017	9kHz ~ 2.75GHz	Jun. 17, 2022	Jun. 16, 2023	Radiation (03CH06-CB)
RF Cable-low	Woken	RG402	Low Cable-24+67	30MHz~1GHz	Oct. 03, 2022	Oct. 02, 2023	Radiation (03CH06-CB)
Test Software	SPORTON	SENSE	V5.10	-	N.C.R.	N.C.R.	Radiation (03CH06-CB)
3m Semi Anechoic Chamber VSWR	RIKEN	SAC-3M	03CH02-CB	1GHz ~18GHz	Mar. 26, 2022	Mar. 25, 2023	Radiation (03CH02-CB)
Horn Antenna	EMCO	3115	9610-4976	1GHz ~ 18GHz	Apr. 19, 2022	Apr. 18, 2023	Radiation (03CH02-CB)
Horn Antenna	Schwarzbeck	BBHA 9170	BBHA9170252	15GHz ~ 40GHz	Aug. 22, 2022	Aug. 21, 2023	Radiation (03CH02-CB)
Pre-Amplifier	Agilent	83017A	MY39501305	1GHz ~ 26.5GHz	Jul. 01, 2022	Jun. 30, 2023	Radiation (03CH02-CB)
Pre-Amplifier	MITEQ	TTA1840-35-H G	1864479	18GHz ~ 40GHz	Jul. 20, 2022	Jul. 19, 2023	Radiation (03CH02-CB)



Instrument	Brand	Model No.	Serial No.	Characteristics	Calibration Date	Calibration Due Date	Remark
Spectrum analyzer	R&S	FSP	100593	9kHz~40GHz	Apr. 08, 2022	Apr. 07, 2023	Radiation (03CH02-CB)
RF Cable-high	Woken	RG402	High Cable-18	1GHz ~ 18GHz	Oct. 04, 2021	Oct. 03, 2022	Radiation (03CH02-CB)
RF Cable-high	Woken	RG402	High Cable-18	1GHz ~ 18GHz	Oct. 03, 2022	Oct. 02, 2023	Radiation (03CH02-CB)
RF Cable-high	Woken	RG402	High Cable-18+19	1GHz ~ 18GHz	Oct. 04, 2021	Oct. 03, 2022	Radiation (03CH02-CB)
RF Cable-high	Woken	RG402	High Cable-18+19	1GHz ~ 18GHz	Oct. 03, 2022	Oct. 02, 2023	Radiation (03CH02-CB)
High Cable	Woken	WCA0929M	40G#5+7	1GHz ~ 40 GHz	Dec. 14, 2021	Dec. 13, 2022	Radiation (03CH02-CB)
High Cable	Woken	WCA0929M	40G#5	1GHz ~ 40 GHz	Dec. 08, 2021	Dec. 07, 2022	Radiation (03CH02-CB)
High Cable	Woken	WCA0929M	40G#7	1GHz ~ 40 GHz	Dec. 14, 2021	Dec. 13, 2022	Radiation (03CH02-CB)
Test Software	SPORTON	SENSE	V5.10	-	N.C.R.	N.C.R.	Radiation (03CH02-CB)
Spectrum analyzer	R&S	FSV40	101028	9kHz~40GHz	Jan. 07, 2022	Jan. 06, 2023	Conducted (TH03-CB)
Power Sensor	Anritsu	MA2411B	1531344	300MHz~40GHz	Jul. 31, 2022	Jul. 30, 2023	Conducted (TH03-CB)
Power Meter	Anritsu	ML2495A	1728002	300MHz~40GHz	Jul. 31, 2022	Jul. 30, 2023	Conducted (TH03-CB)
RF Cable-high	Woken	RG402	High Cable-11	1 GHz ~18 GHz	Oct. 04, 2021	Oct. 03, 2022	Conducted (TH03-CB)
RF Cable-high	Woken	RG402	High Cable-11	1 GHz ~18 GHz	Oct. 03, 2022	Oct. 02, 2023	Conducted (TH03-CB)
RF Cable-high	Woken	RG402	High Cable-12	1 GHz ~18 GHz	Oct. 04, 2021	Oct. 03, 2022	Conducted (TH03-CB)
RF Cable-high	Woken	RG402	High Cable-12	1 GHz ~18 GHz	Oct. 03, 2022	Oct. 02, 2023	Conducted (TH03-CB)
RF Cable-high	Woken	RG402	High Cable-13	1 GHz ~18 GHz	Oct. 04, 2021	Oct. 03, 2022	Conducted (TH03-CB)
RF Cable-high	Woken	RG402	High Cable-13	1 GHz ~18 GHz	Oct. 03, 2022	Oct. 02, 2023	Conducted (TH03-CB)
RF Cable-high	Woken	RG402	High Cable-14	1 GHz ~18 GHz	Oct. 04, 2021	Oct. 03, 2022	Conducted (TH03-CB)
RF Cable-high	Woken	RG402	High Cable-14	1 GHz ~18 GHz	Oct. 03, 2022	Oct. 02, 2023	Conducted (TH03-CB)
RF Cable-high	Woken	RG402	High Cable-15	1 GHz ~18 GHz	Oct. 04, 2021	Oct. 03, 2022	Conducted (TH03-CB)
RF Cable-high	Woken	RG402	High Cable-15	1 GHz ~18 GHz	Oct. 03, 2022	Oct. 02, 2023	Conducted (TH03-CB)
Switch	SPTCB	SP-SWI	SWI-03	1 GHz ~ 26.5 GHz	Dec. 13, 2021	Dec. 12, 2022	Conducted (TH03-CB)



Instrument	Brand	Model No.	Serial No.	Characteristics	Calibration Date	Calibration Due Date	Remark
Test Software	SPORTON	SENSE	V5.10	-	N.C.R.	N.C.R.	Conducted (TH03-CB)

Note: Calibration Interval of instruments listed above is one year.

NCR means Non-Calibration required.



Summary

Mode	Result	Type	Freq (Hz)	Level (dBuV)	Limit (dBuV)	Margin (dB)	Condition
Mode 2	Pass	QP	154.5k	61.46	65.75	-4.29	Line

Mode 2

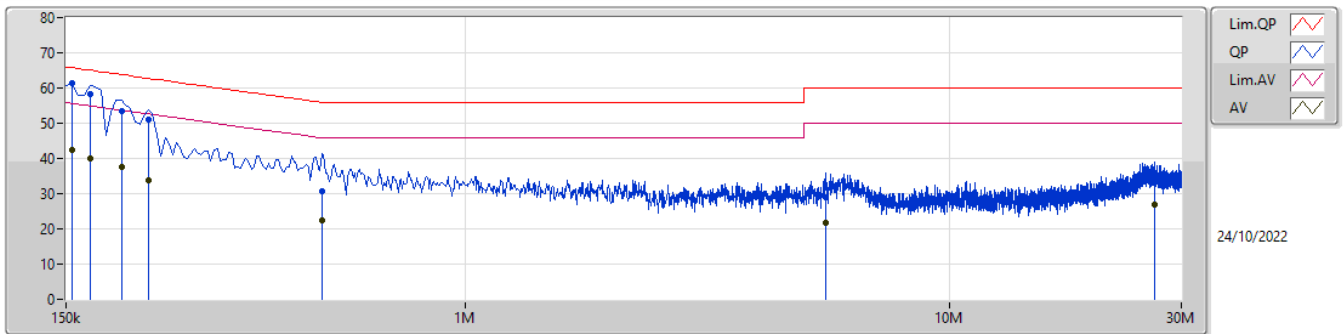

Type	Freq (Hz)	Level (dBuV)	Limit (dBuV)	Margin (dB)	Factor (dB)	Condition	Comment	Raw (dBuV)	LISN (dB)	CL (dB)	AT (dB)
QP	154.5k	61.46	65.75	-4.29	9.99	Line	"Worst"	51.47	0.06	0.04	9.89
AV	154.5k	42.54	55.75	-13.21	9.99	Line	-	32.55	0.06	0.04	9.89
QP	168k	58.29	65.06	-6.77	9.99	Line	-	48.30	0.06	0.04	9.89
AV	168k	39.97	55.06	-15.09	9.99	Line	-	29.98	0.06	0.04	9.89
QP	195k	53.30	63.82	-10.52	9.99	Line	-	43.31	0.06	0.04	9.89
AV	195k	37.52	53.82	-16.30	9.99	Line	-	27.53	0.06	0.04	9.89
QP	222k	51.01	62.75	-11.74	9.99	Line	-	41.02	0.06	0.04	9.89
AV	222k	33.93	52.75	-18.82	9.99	Line	-	23.94	0.06	0.04	9.89
QP	505.5k	30.83	56.00	-25.17	10.00	Line	-	20.83	0.06	0.05	9.89
AV	505.5k	22.50	46.00	-23.50	10.00	Line	-	12.50	0.06	0.05	9.89
QP	5.541M	29.10	60.00	-30.90	10.18	Line	-	18.92	0.16	0.12	9.90
AV	5.541M	21.67	50.00	-28.33	10.18	Line	-	11.49	0.16	0.12	9.90
QP	26.403M	33.24	60.00	-26.76	10.66	Line	-	22.58	0.37	0.30	9.99
AV	26.403M	26.82	50.00	-23.18	10.66	Line	-	16.16	0.37	0.30	9.99

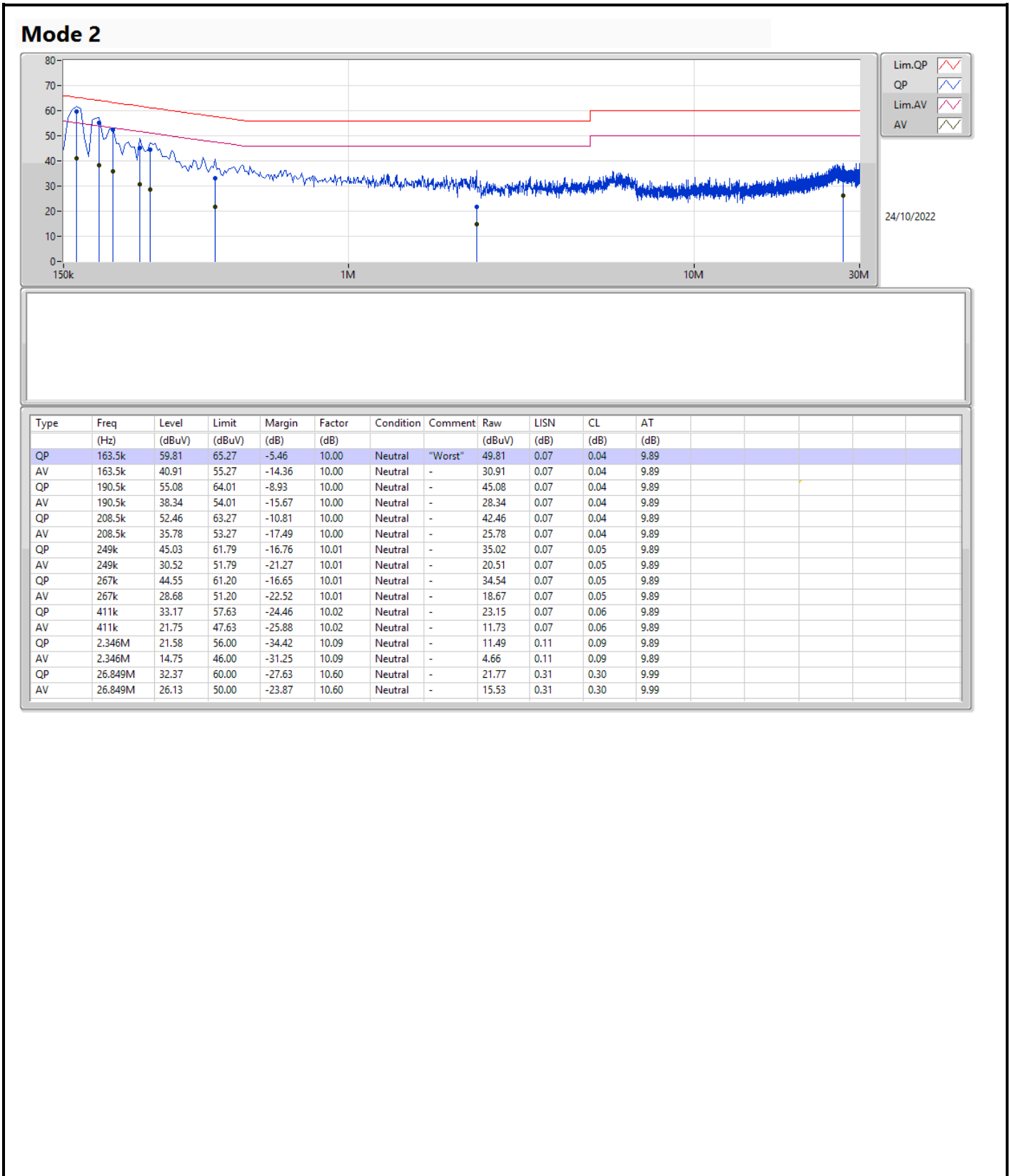



Summary

Mode	Max-N dB (Hz)	Max-OBW (Hz)	ITU-Code	Min-N dB (Hz)	Min-OBW (Hz)
2.4-2.4835GHz	-	-	-	-	-
BT-LE(1Mbps)	691.25k	1.073M	1M07F1D	666.25k	1.066M
BT-LE(2Mbps)	1.168M	2.054M	2M05F1D	1.155M	2.049M

Max-N dB = Maximum 6dB down bandwidth; Max-OBW = Maximum 99% occupied bandwidth;
Min-N dB = Minimum 6dB down bandwidth; Min-OBW = Minimum 99% occupied bandwidth



Result

Mode	Result	Limit (Hz)	Port 1-N dB (Hz)	Port 1-OBW (Hz)
BT-LE(1Mbps)	-	-	-	-
2402MHz	Pass	500k	691.25k	1.073M
2440MHz	Pass	500k	671.25k	1.068M
2480MHz	Pass	500k	666.25k	1.066M
BT-LE(2Mbps)	-	-	-	-
2402MHz	Pass	500k	1.165M	2.049M
2440MHz	Pass	500k	1.168M	2.054M
2480MHz	Pass	500k	1.155M	2.054M

Port X-N dB = Port X 6dB down bandwidth;
Port X-OBW = Port X 99% occupied bandwidth

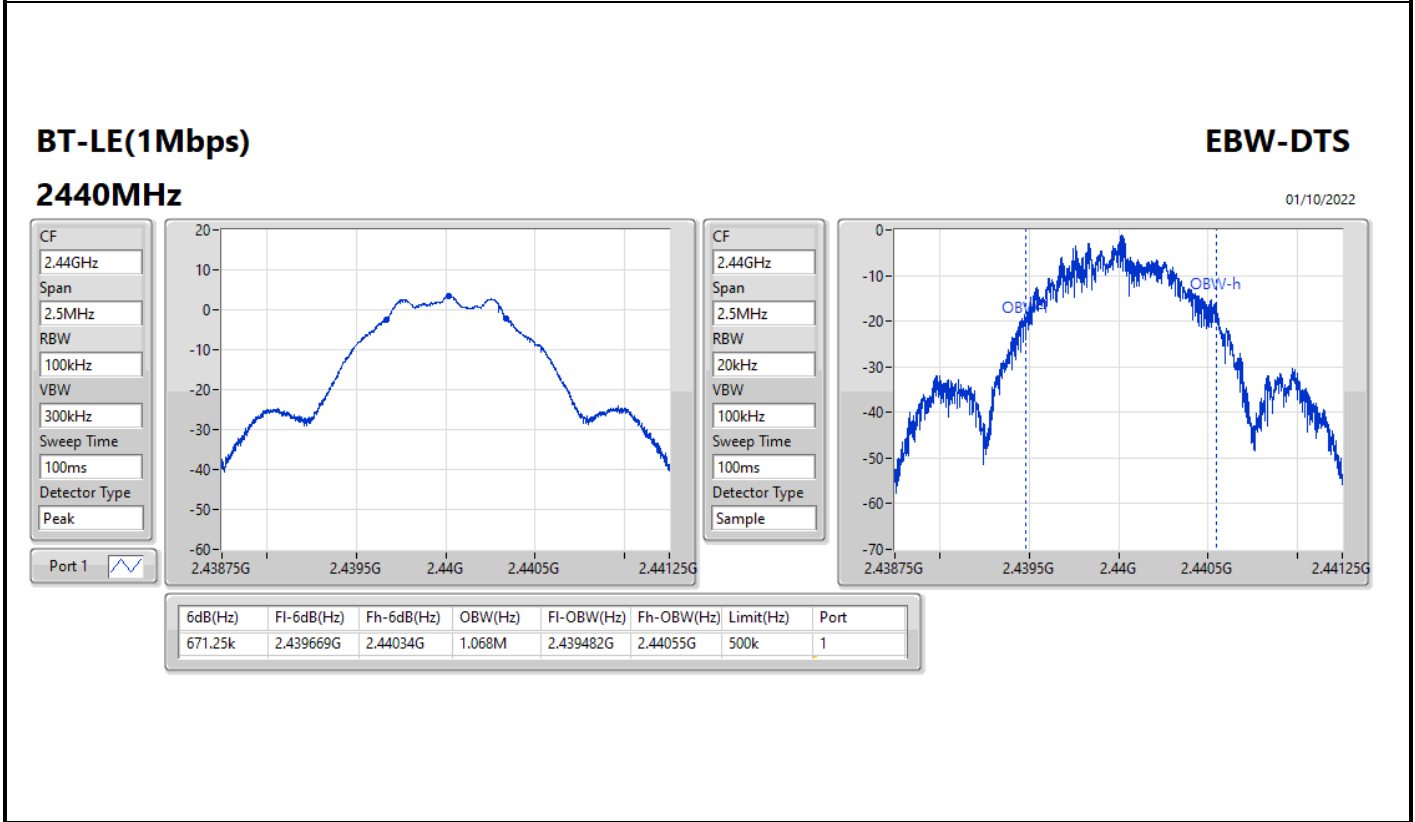
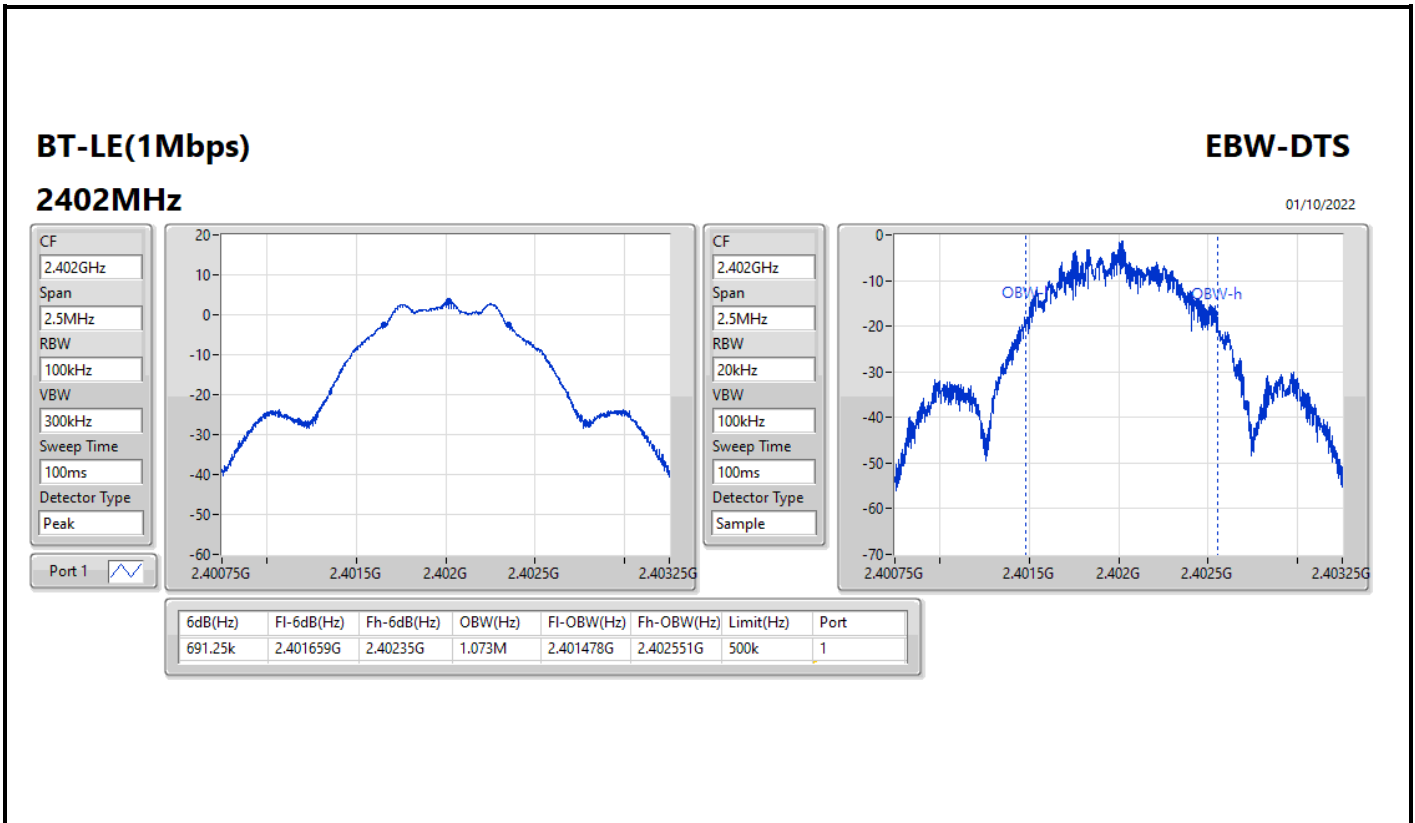

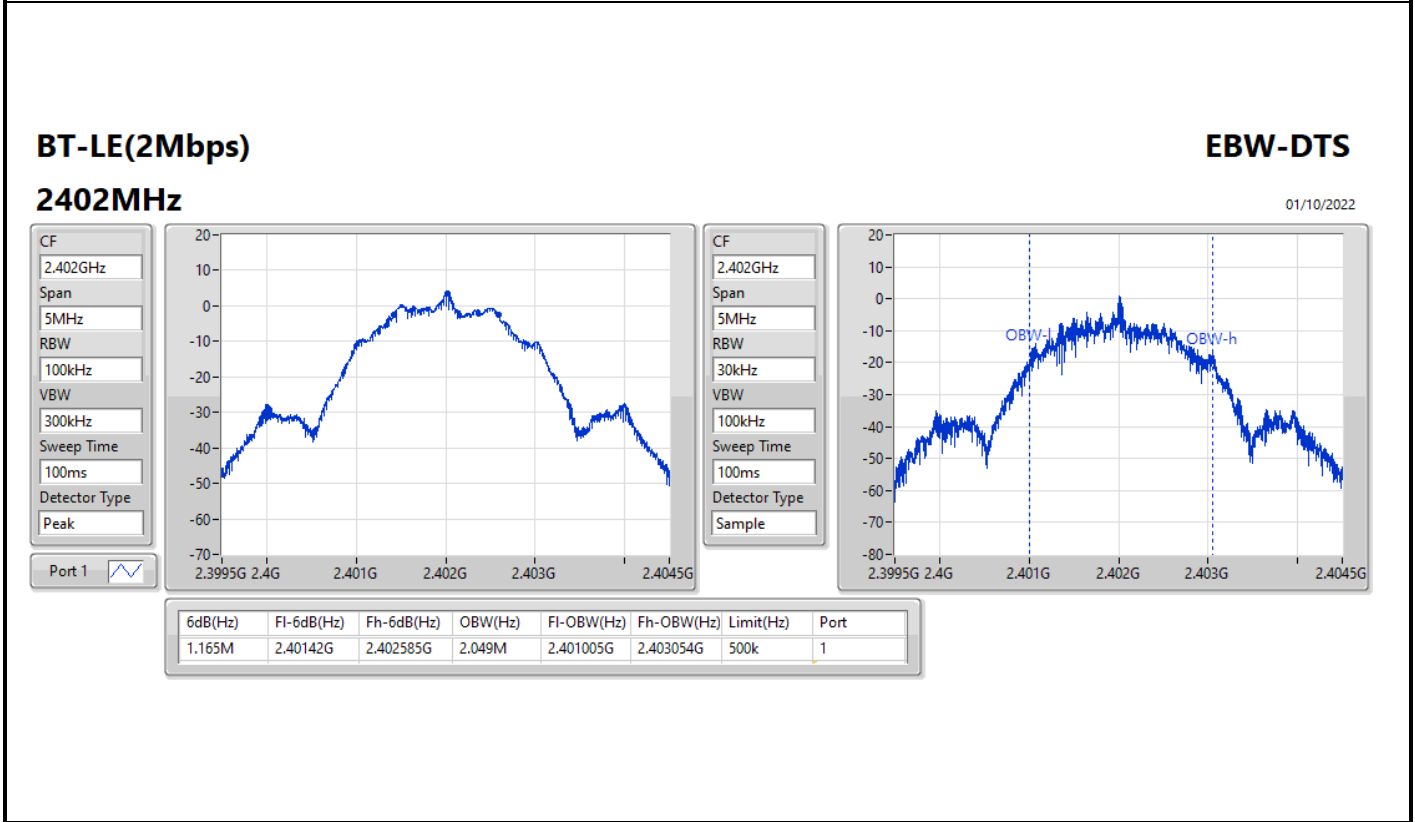
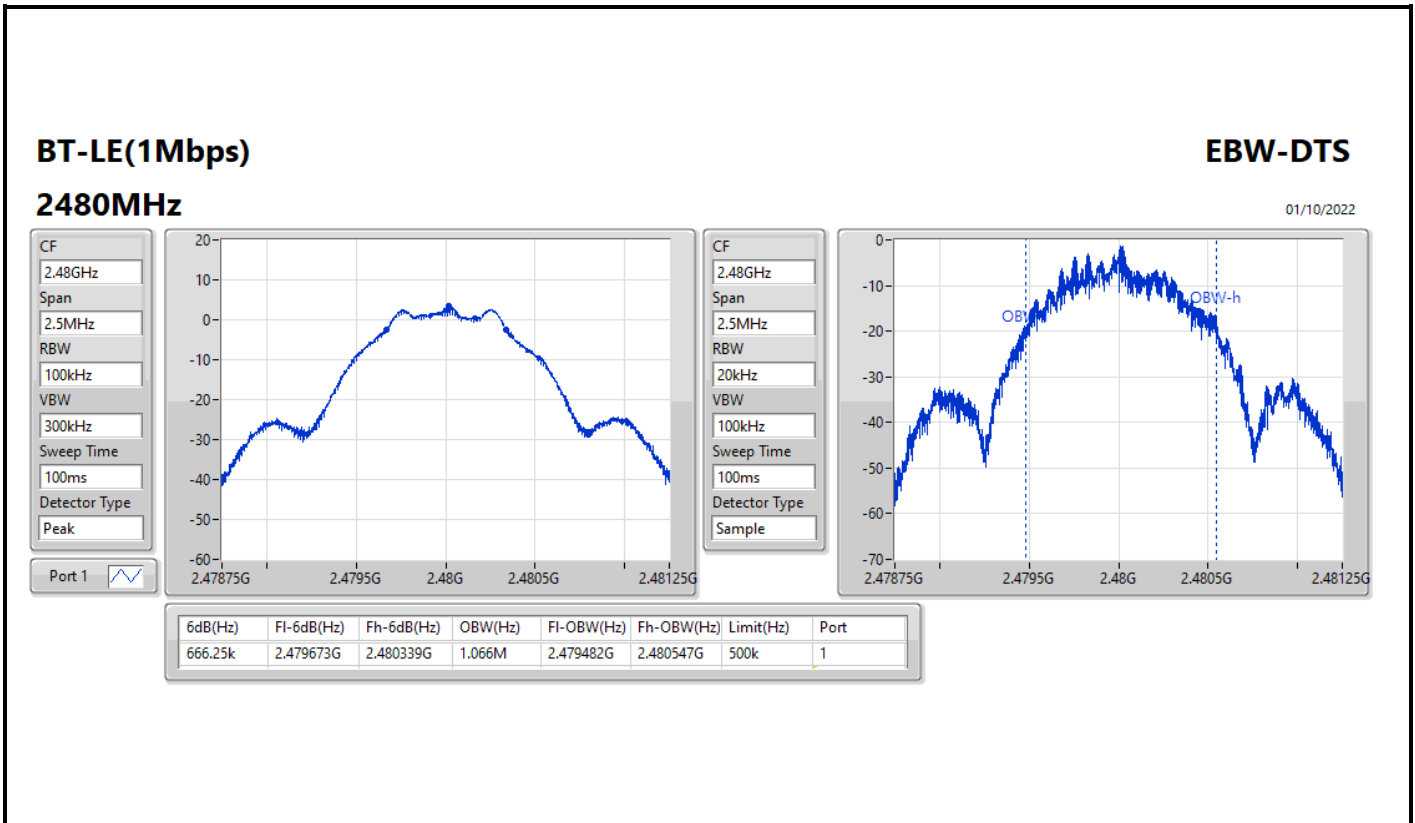

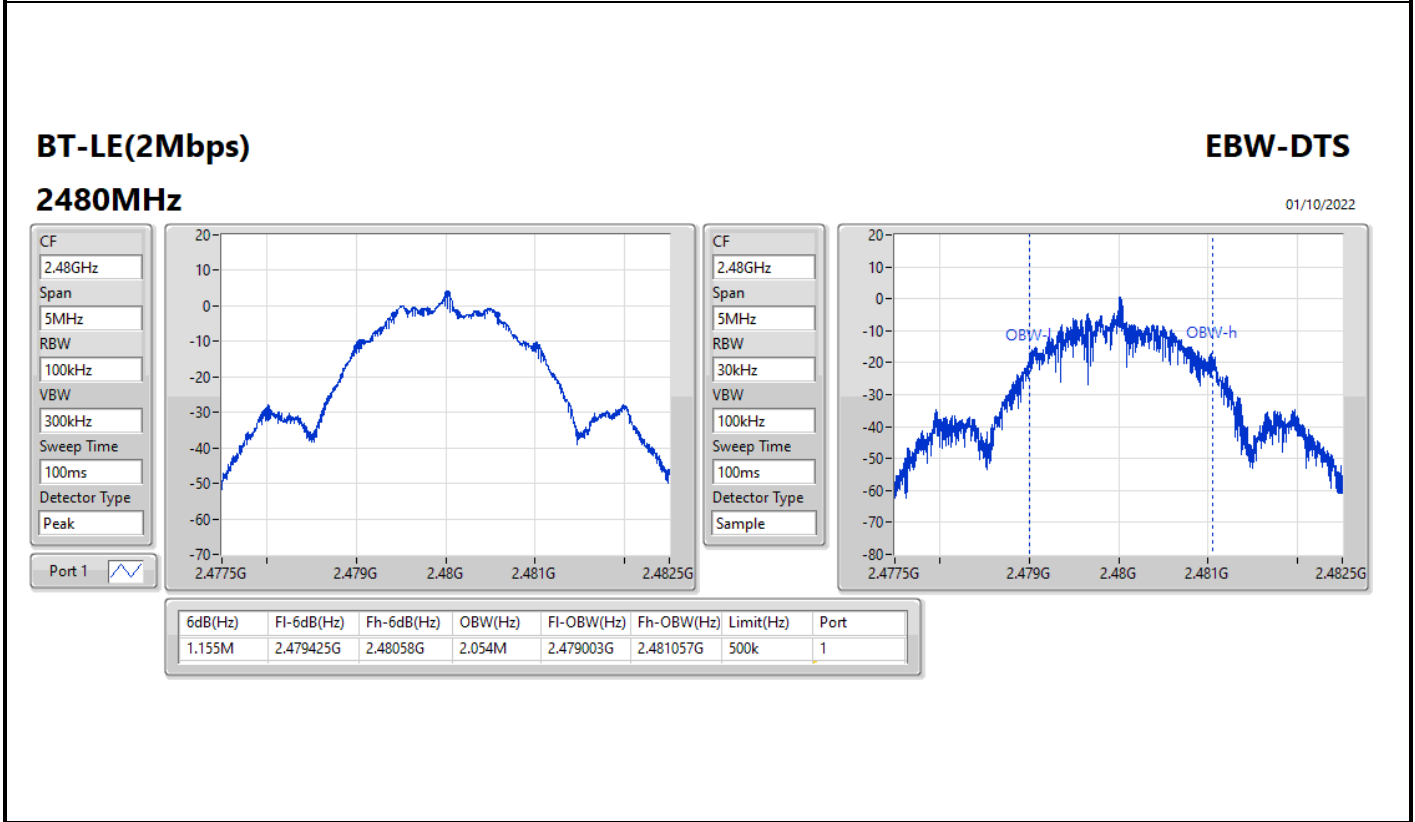
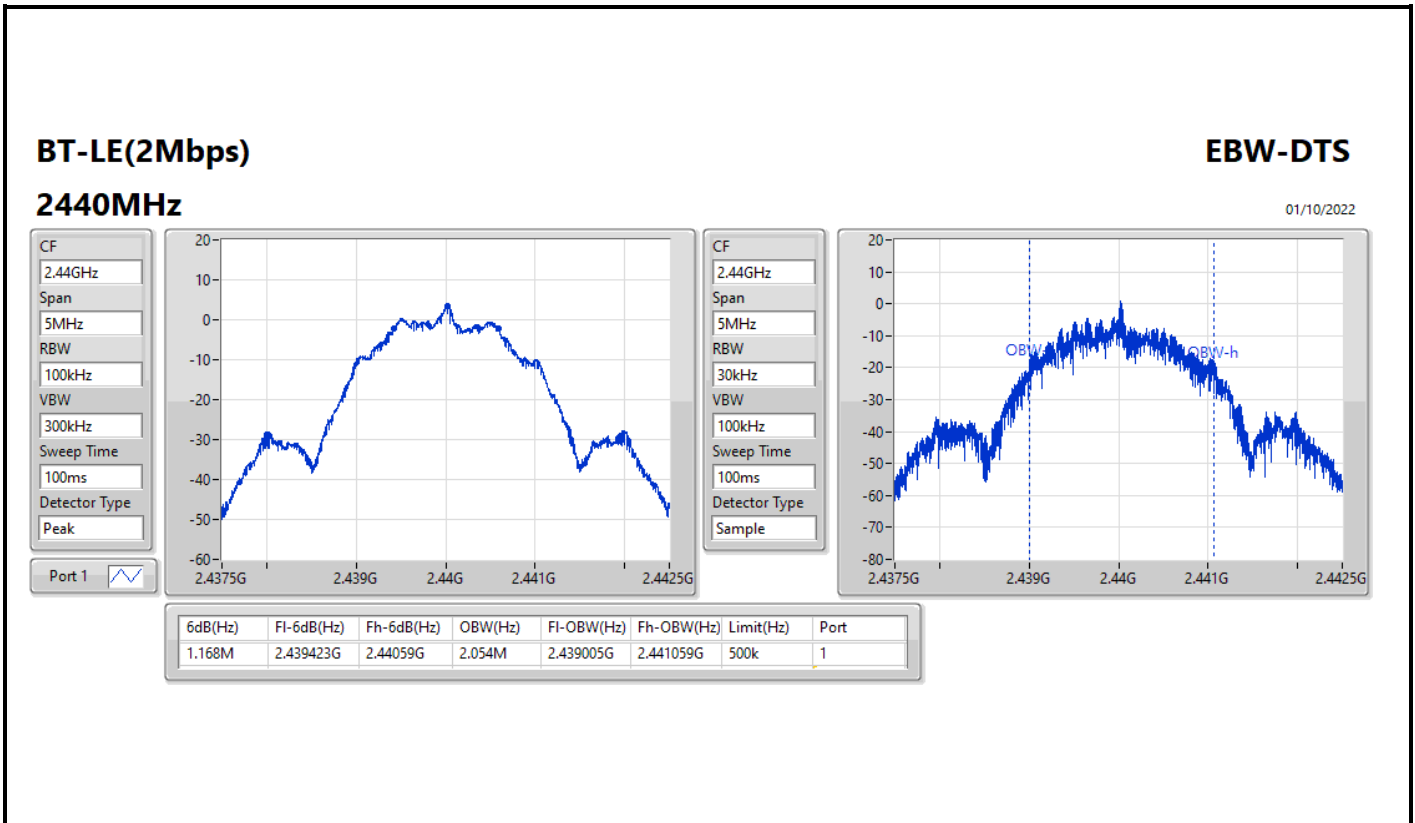



Summary

Mode	Power (dBm)	Power (W)
2.4-2.4835GHz	-	-
BT-LE(1Mbps)	3.22	0.00210
BT-LE(2Mbps)	3.11	0.00205



Result

Mode	Result	Gain (dBi)	Power (dBm)	Power Limit (dBm)
BT-LE(1Mbps)	-	-	-	-
2402MHz	Pass	4.22	3.22	30.00
2440MHz	Pass	4.22	3.12	30.00
2480MHz	Pass	4.22	2.94	30.00
BT-LE(2Mbps)	-	-	-	-
2402MHz	Pass	4.22	3.11	30.00
2440MHz	Pass	4.202	3.01	30.00
2480MHz	Pass	4.22	2.80	30.00

DG = Directional Gain; Port X = Port X output power



Summary

Mode	PD (dBm/RBW)
2.4-2.4835GHz	-
BT-LE(1Mbps)	-12.37
BT-LE(2Mbps)	-14.50

RBW = 3kHz;



Result

Mode	Result	Gain (dBi)	PD (dBm/RBW)	PD Limit (dBm/RBW)
BT-LE(1Mbps)	-	-	-	-
2402MHz	Pass	4.22	-13.09	8.00
2440MHz	Pass	4.22	-12.37	8.00
2480MHz	Pass	4.22	-12.73	8.00
BT-LE(2Mbps)	-	-	-	-
2402MHz	Pass	4.22	-15.21	8.00
2440MHz	Pass	4.22	-15.94	8.00
2480MHz	Pass	4.22	-14.50	8.00

DG = Directional Gain; RBW = 3kHz;
PD = trace bin-by-bin of each transmits port summing can be performed maximum power density; Port X = Port X Power Density;

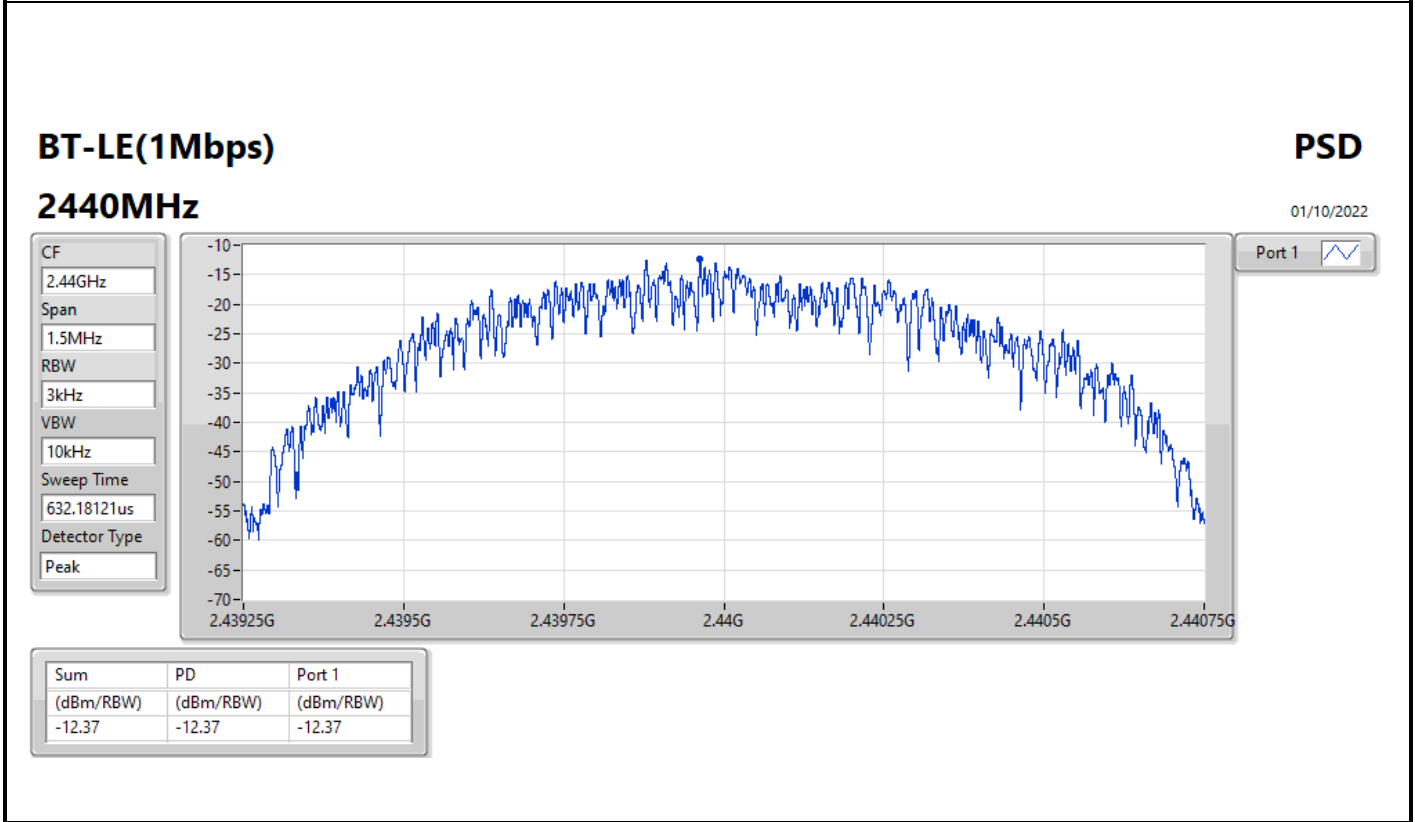
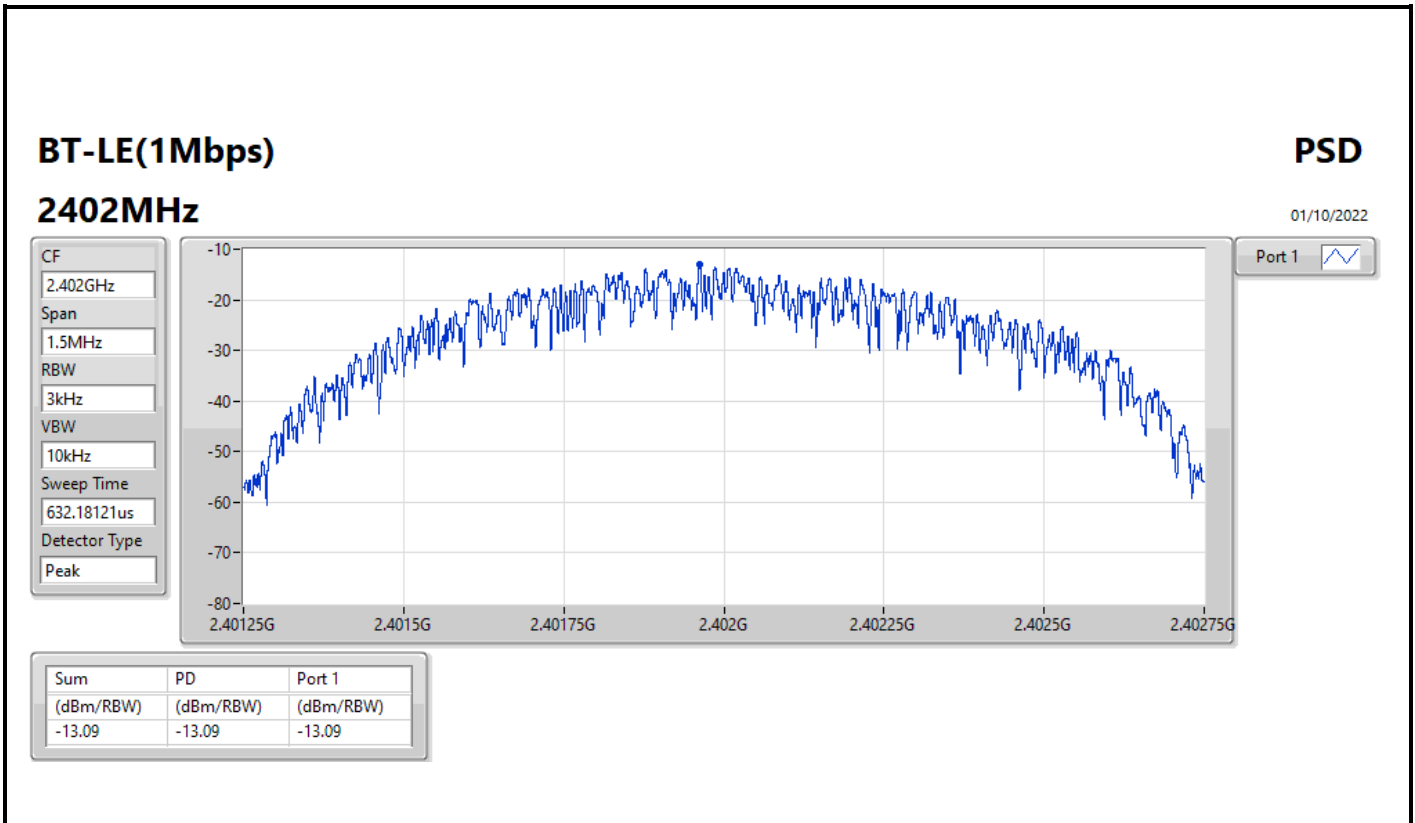

BT-LE(1Mbps)

PSD

2480MHz

01/10/2022

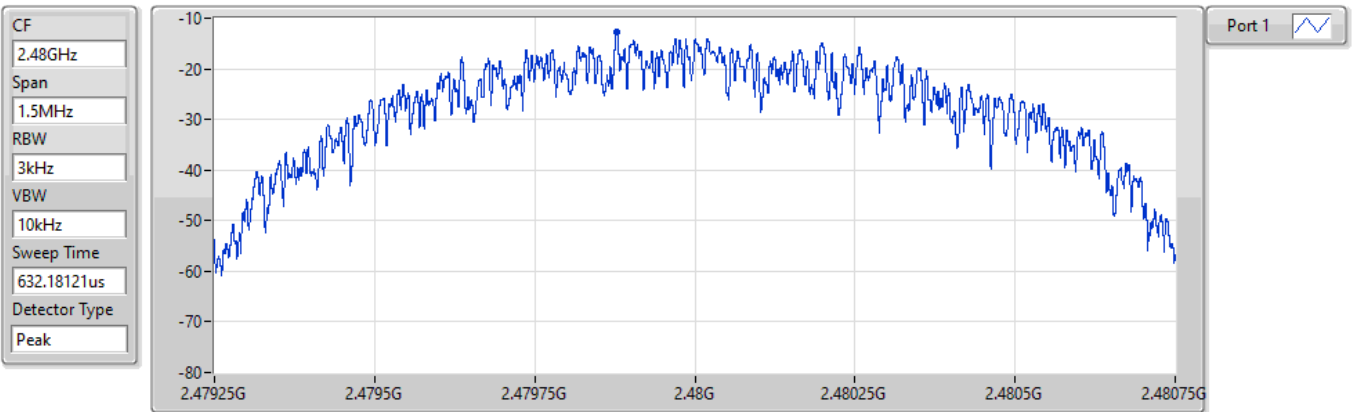

Sum	PD	Port 1
(dBm/RBW)	(dBm/RBW)	(dBm/RBW)
-12.73	-12.73	-12.73

BT-LE(2Mbps)

PSD

2402MHz

01/10/2022

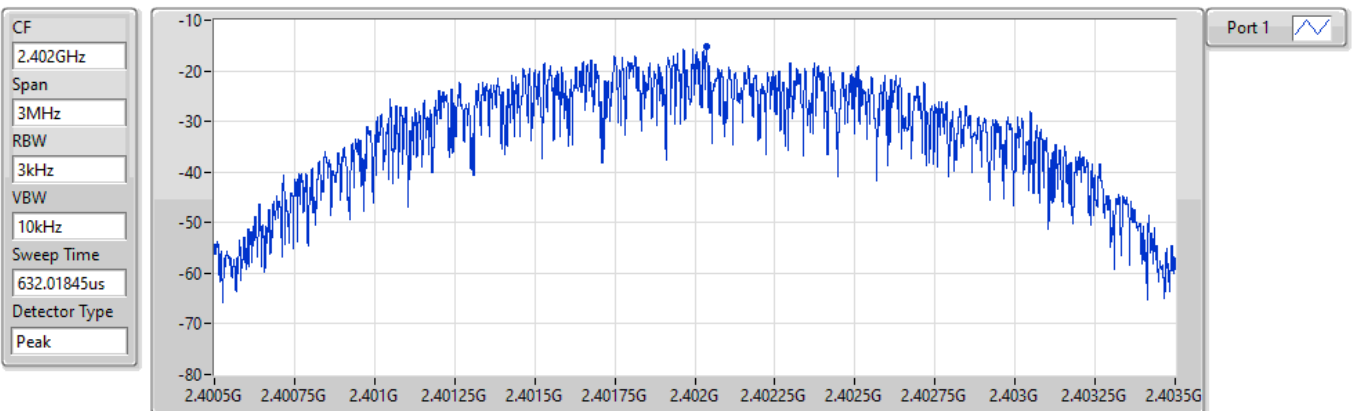

Sum	PD	Port 1
(dBm/RBW)	(dBm/RBW)	(dBm/RBW)
-15.21	-15.21	-15.21

BT-LE(2Mbps)

PSD

2440MHz

01/10/2022

CF
2.44GHz

Span
3MHz

RBW
3kHz

VBW
10kHz

Sweep Time
632.01845us

Detector Type
Peak

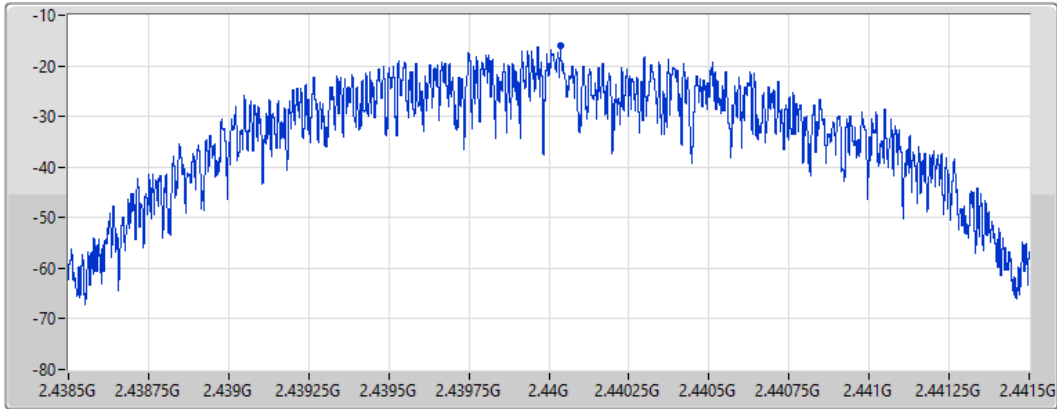

Port 1 

Sum	PD	Port 1
(dBm/RBW)	(dBm/RBW)	(dBm/RBW)
-15.94	-15.94	-15.94

BT-LE(2Mbps)

PSD

2480MHz

01/10/2022

CF
2.48GHz

Span
3MHz

RBW
3kHz

VBW
10kHz

Sweep Time
632.01845us

Detector Type
Peak

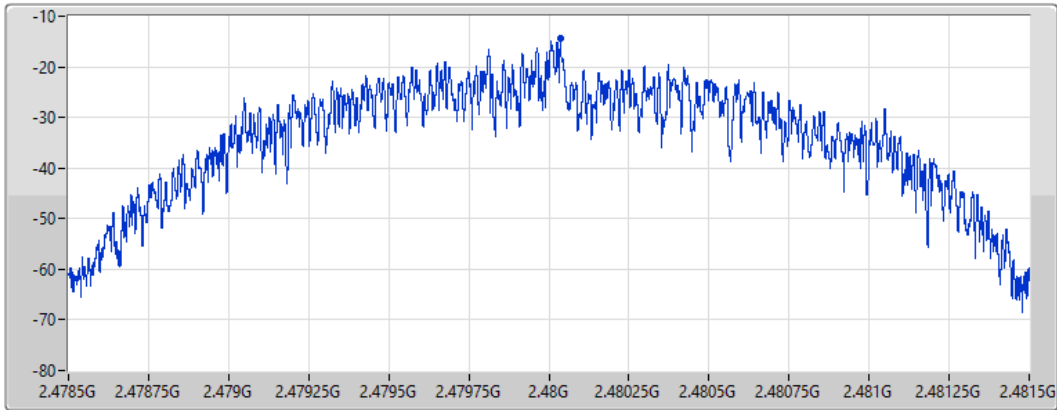

Port 1 

Sum	PD	Port 1
(dBm/RBW)	(dBm/RBW)	(dBm/RBW)
-14.50	-14.50	-14.50



Summary

Mode	Result	Ref (Hz)	Ref (dBm)	Limit (dBm)	Freq (Hz)	Level (dBm)	Freq (Hz)	Level (dBm)	Freq (Hz)	Level (dBm)	Freq (Hz)	Level (dBm)	Freq (Hz)	Level (dBm)	Port
2.4-2.4835GHz	-	-	-	-	-	-	-	-	-	-	-	-	-	-	-
BT-LE(1Mbps)	Pass	2.402G	3.26	-26.74	2.0275G	-52.02	2.4G	-42.66	2.4G	-42.18	2.49802G	-48.53	23.44493G	-44.18	1
BT-LE(2Mbps)	Pass	2.402G	3.53	-26.47	895.09M	-51.20	2.4G	-28.78	2.4G	-28.42	2.49807G	-50.34	24.5332G	-43.53	1



Result

Mode	Result	Ref (Hz)	Ref (dBm)	Limit (dBm)	Freq (Hz)	Level (dBm)	Freq (Hz)	Level (dBm)	Freq (Hz)	Level (dBm)	Freq (Hz)	Level (dBm)	Freq (Hz)	Level (dBm)	Port
BT-LE(1Mbps)	-	-	-	-	-	-	-	-	-	-	-	-	-	-	-
2402MHz	Pass	2.402G	3.26	-26.74	2.0275G	-52.02	2.4G	-42.66	2.4G	-42.18	2.49802G	-48.53	23.44493G	-44.18	1
2440MHz	Pass	2.402G	3.26	-26.74	1.81982G	-51.43	2.39934G	-51.64	2.4835G	-52.56	2.48405G	-50.73	16.27979G	-44.30	1
2480MHz	Pass	2.402G	3.26	-26.74	655.39M	-51.49	2.39018G	-51.21	2.4835G	-53.91	2.48666G	-49.38	15.04811G	-43.77	1
BT-LE(2Mbps)	-	-	-	-	-	-	-	-	-	-	-	-	-	-	-
2402MHz	Pass	2.402G	3.53	-26.47	895.09M	-51.20	2.4G	-28.78	2.4G	-28.42	2.49807G	-50.34	24.5332G	-43.53	1
2440MHz	Pass	2.402G	3.53	-26.47	673.02M	-52.29	2.39915G	-51.65	2.4G	-52.37	2.48622G	-49.47	24.85096G	-43.93	1
2480MHz	Pass	2.402G	3.53	-26.47	857.79M	-51.66	2.39625G	-51.06	2.4835G	-53.15	2.48396G	-49.77	23.50961G	-43.24	1

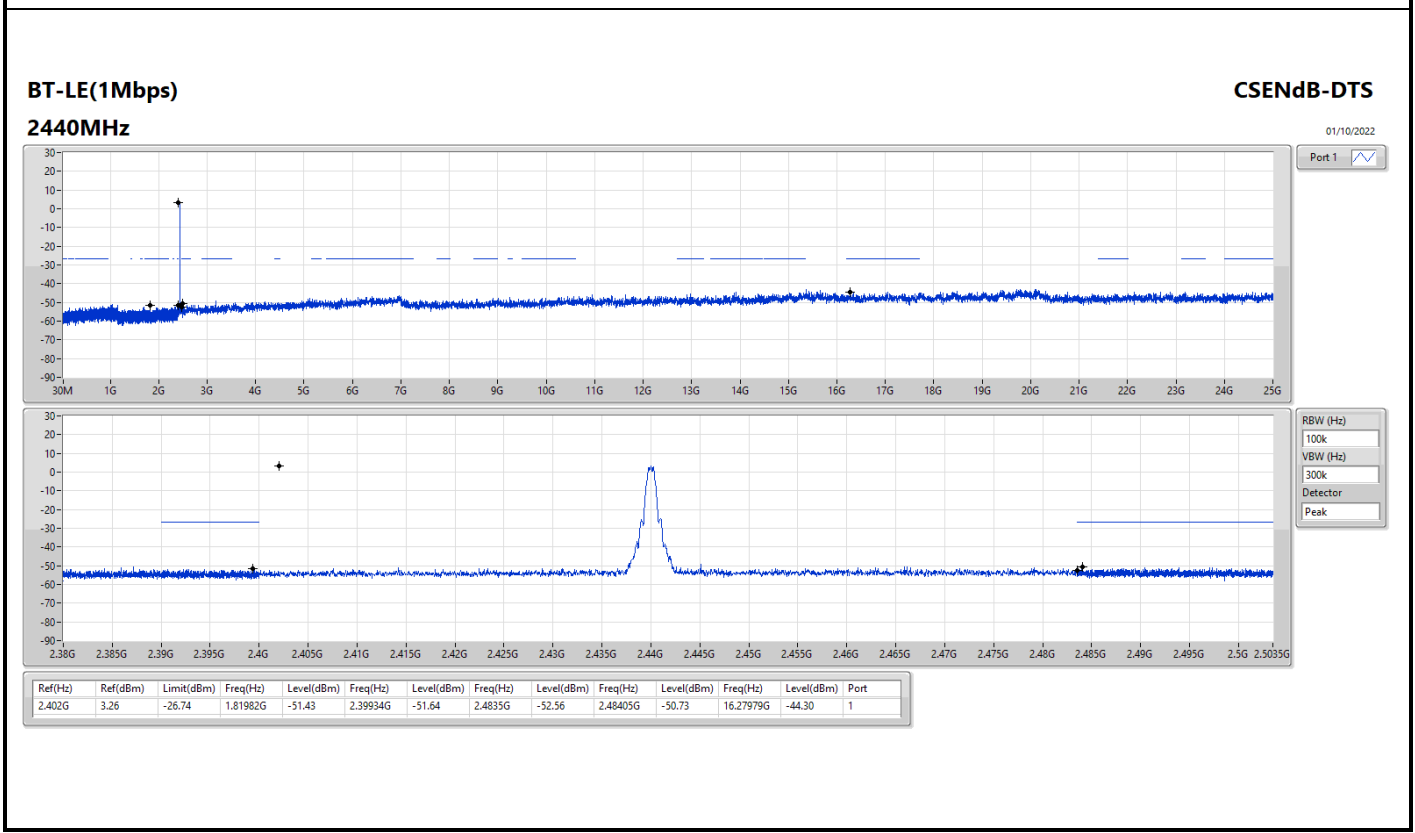
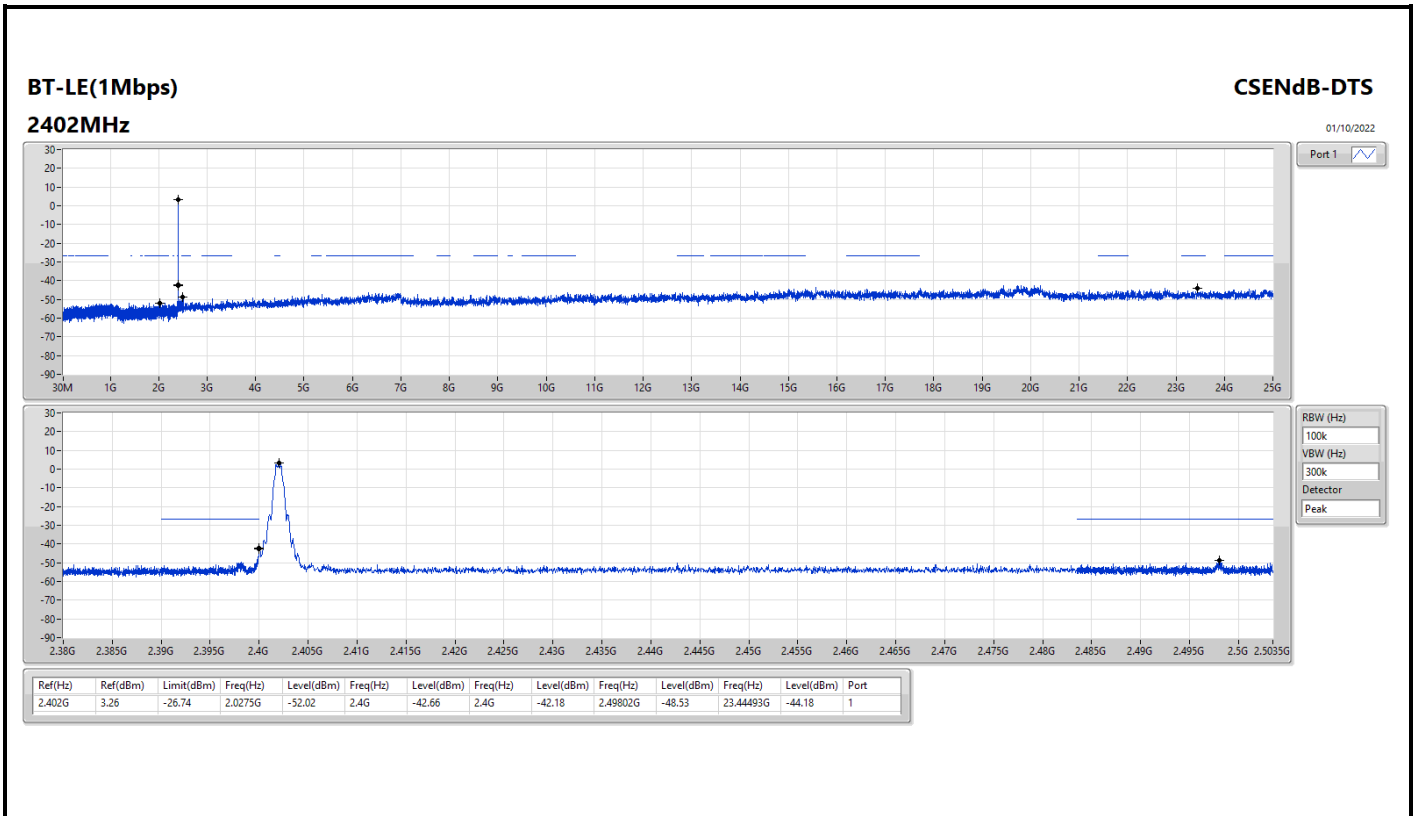

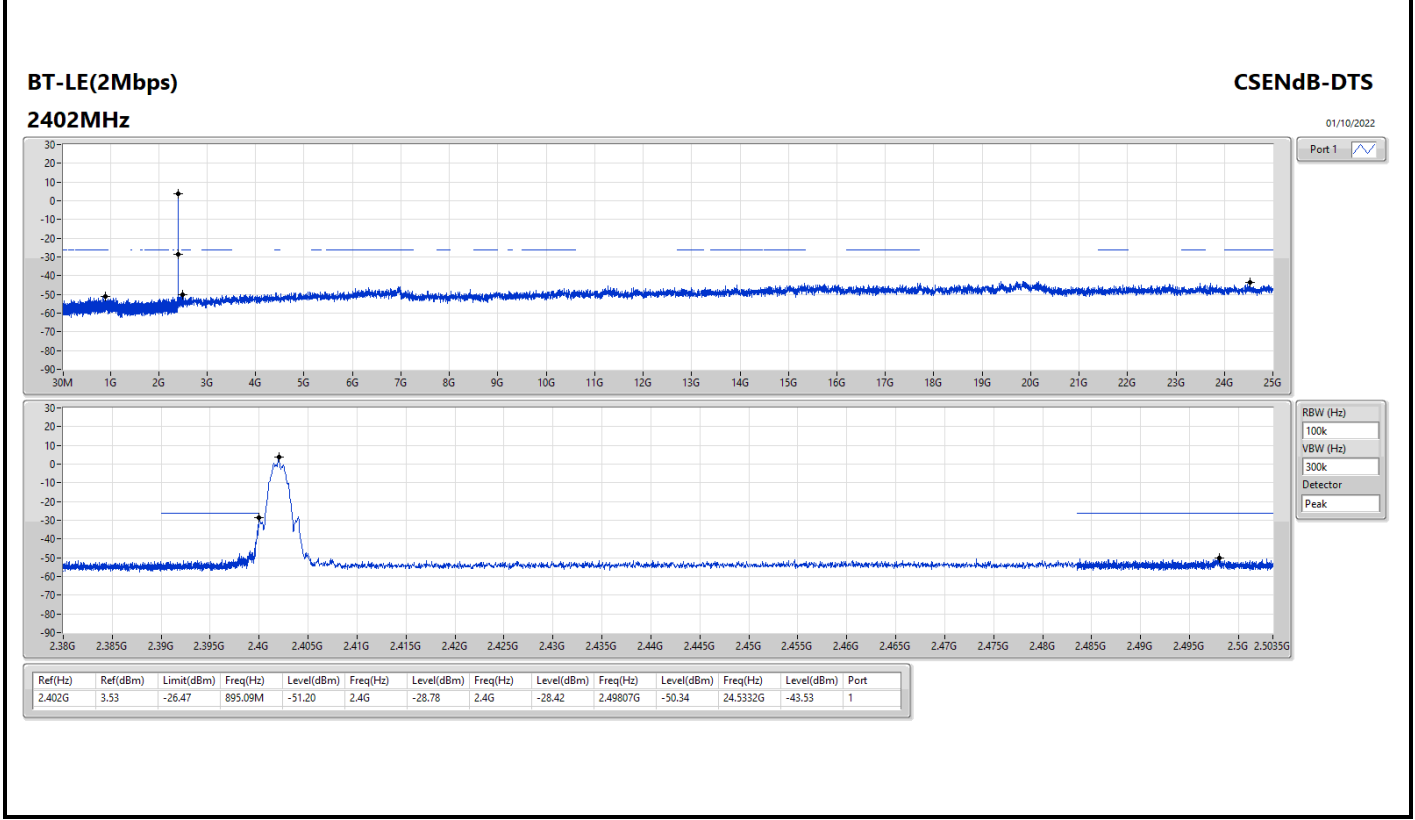
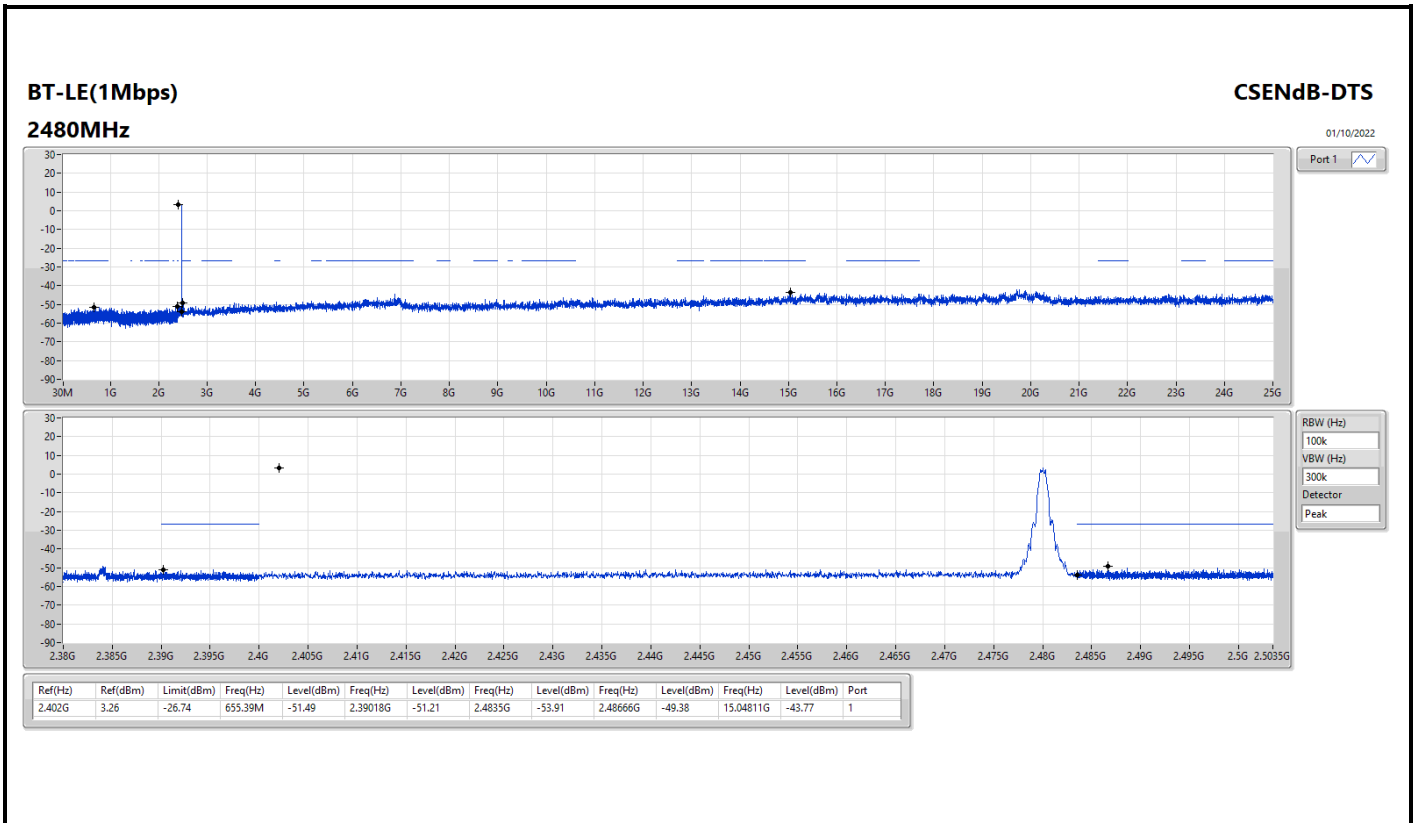

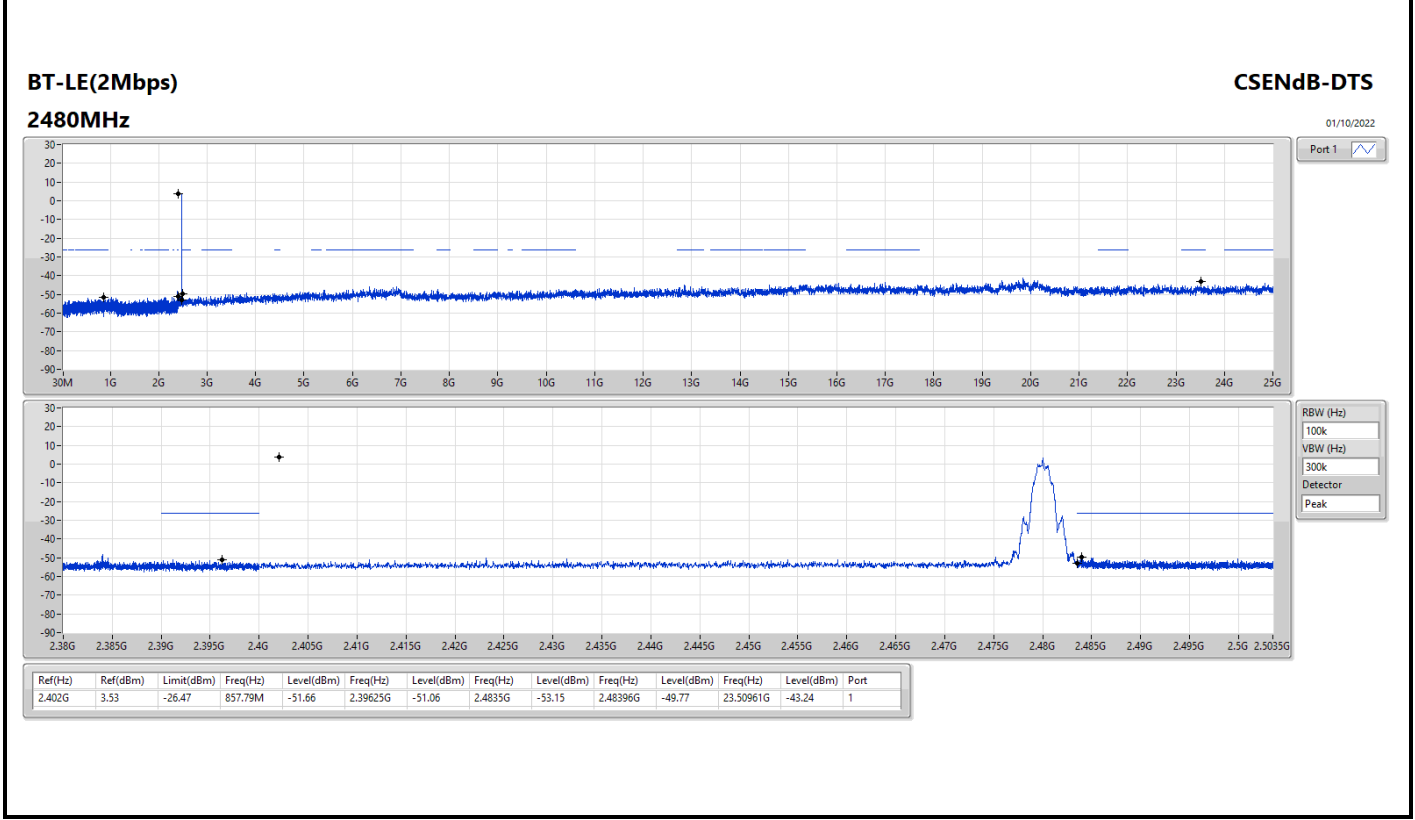
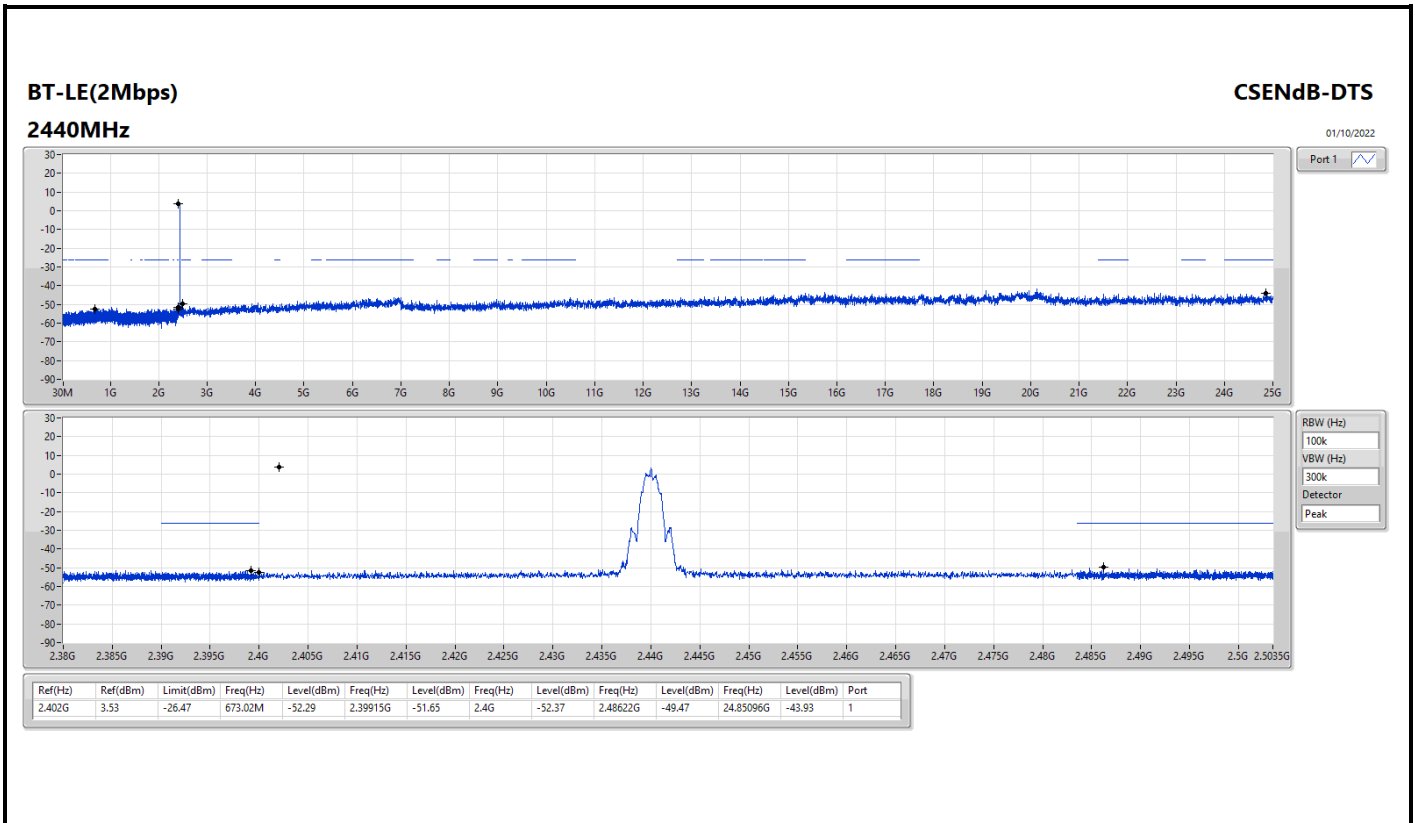



Summary

Mode	Result	Type	Freq (Hz)	Level (dBuV/m)	Limit (dBuV/m)	Margin (dB)	Condition
Mode 3	Pass	QP	44.55M	36.91	40.00	-3.09	Vertical

Mode 3



Type	Freq (Hz)	Level (dBuV/m)	Limit (dBuV/m)	Margin (dB)	Factor (dB/m)	Dist (m)	Condition	Azimuth (°)	Height (m)	Comment	Raw (dBuV/m)	AF (dB/m)	CL (dB)	PA (dB)
QP	37.76M	36.69	40.00	-3.31	-10.89	3	Vertical	191	1.00	-	47.58	20.43	1.14	32.46
QP	44.55M	36.91	40.00	-3.09	-14.49	3	Vertical	291	1.00	"Worst"	51.40	16.76	1.23	32.48
QP	61.04M	34.88	40.00	-5.12	-18.52	3	Vertical	0	1.50	-	53.40	12.44	1.50	32.46
QP	79.47M	36.28	40.00	-3.72	-17.81	3	Vertical	0	2.00	-	54.09	12.92	1.66	32.39
PK	115.36M	40.26	43.50	-3.24	-12.47	3	Vertical	224	1.00	-	52.73	17.90	2.02	32.39
PK	258.92M	40.87	46.00	-5.13	-9.65	3	Vertical	125	1.25	-	50.52	19.57	3.09	32.31

Mode 3

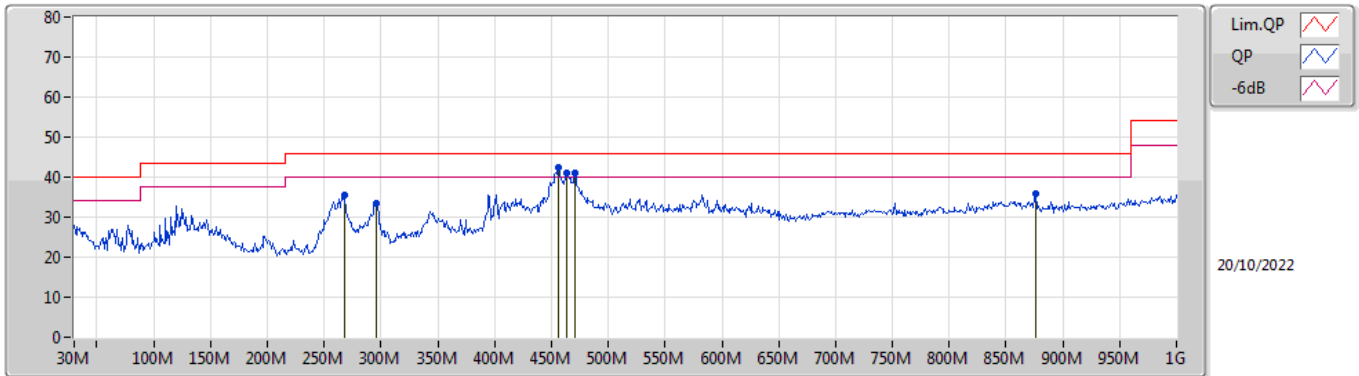

Type	Freq (Hz)	Level (dBuV/m)	Limit (dBuV/m)	Margin (dB)	Factor (dB/m)	Dist (m)	Condition	Azimuth (°)	Height (m)	Comment	Raw (dBuV/m)	AF (dB/m)	CL (dB)	PA (dB)
PK	267.65M	35.49	46.00	-10.51	-9.99	3	Horizontal	186	1.00	-	45.48	19.19	3.14	32.32
PK	295.78M	33.37	46.00	-12.63	-10.05	3	Horizontal	249	1.25	-	43.42	18.99	3.32	32.36
PK	455.83M	42.34	46.00	-3.66	-5.23	3	Horizontal	252	1.00	"Worst"	47.57	22.72	4.20	32.15
PK	463.59M	41.11	46.00	-4.89	-5.03	3	Horizontal	252	1.00	-	46.14	22.90	4.23	32.16
PK	470.38M	40.94	46.00	-5.06	-4.82	3	Horizontal	278	1.00	-	45.76	23.09	4.26	32.17
PK	875.84M	35.73	46.00	-10.27	0.68	3	Horizontal	181	1.00	-	35.05	26.31	5.92	31.55



Summary

Mode	Result	Type	Freq (Hz)	Level (dBuV/m)	Limit (dBuV/m)	Margin (dB)	Dist (m)	Condition	Azimuth (°)	Height (m)	Comments
2.4-2.4835GHz	-	-	-	-	-	-	-	-	-	-	-
BT-LE(2Mbps)	Pass	AV	2.4835G	47.64	54.00	-6.36	3	Horizontal	0	2.86	-

BT-LE(1Mbps)

2402MHz_TX

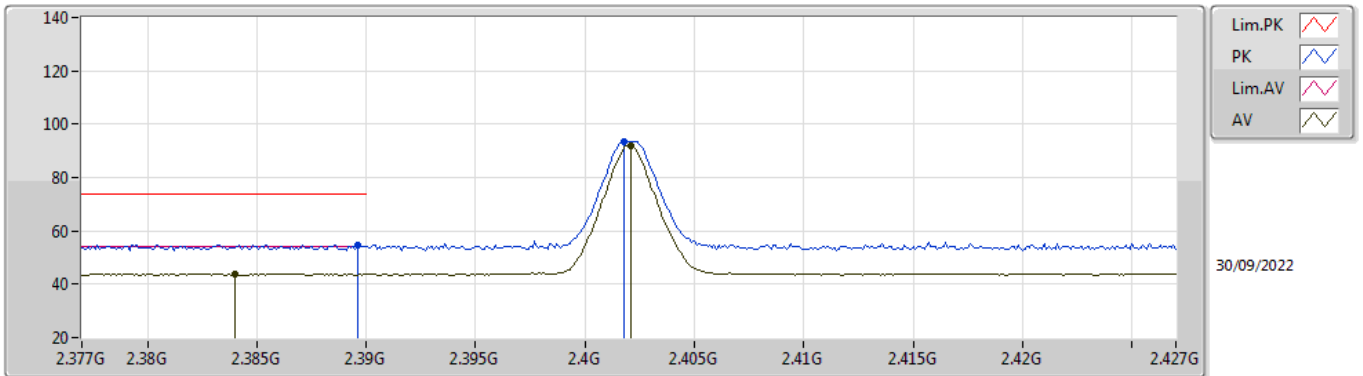

EUT_X_1TX
Setting Default
02-F-C-6

Type	Freq (Hz)	Level (dBuV/m)	Limit (dBuV/m)	Margin (dB)	Raw (dBuV)	Dist (m)	Condition	Azimuth (°)	Height (m)	Comment	AF (dB)	CL (dB)	PA (dB)
PK	2.3896G	54.87	74.00	-19.13	23.70	3	Vertical	9	2.59	-	28.38	2.79	-
AV	2.384G	44.03	54.00	-9.97	12.87	3	Vertical	9	2.59	-	28.37	2.79	-
PK	2.4018G	93.65	Inf	-Inf	62.45	3	Vertical	9	2.59	-	28.40	2.80	-
AV	2.4021G	92.14	Inf	-Inf	60.94	3	Vertical	9	2.59	-	28.40	2.80	-

BT-LE(1Mbps)

2402MHz_TX

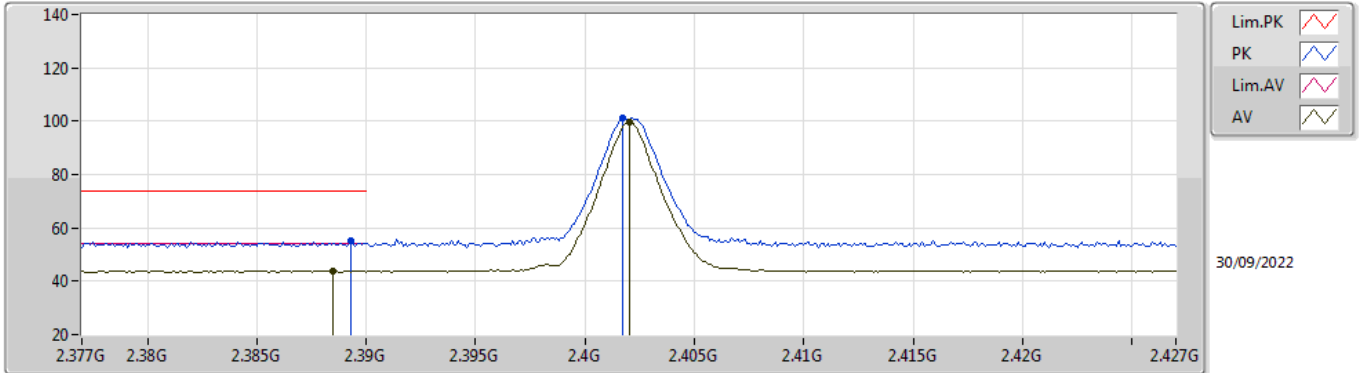

EUT X_1TX
Setting Default
02-F-C-6

Type	Freq (Hz)	Level (dBuV/m)	Limit (dBuV/m)	Margin (dB)	Raw (dBuV)	Dist (m)	Condition	Azimuth (°)	Height (m)	Comment	AF (dB)	CL (dB)	PA (dB)
PK	2.3893G	55.15	74.00	-18.85	23.98	3	Horizontal	356	3.00	-	28.38	2.79	-
AV	2.3885G	43.94	54.00	-10.06	12.77	3	Horizontal	356	3.00	-	28.38	2.79	-
PK	2.4017G	100.96	Inf	-Inf	69.76	3	Horizontal	356	3.00	-	28.40	2.80	-
AV	2.402G	99.46	Inf	-Inf	68.26	3	Horizontal	356	3.00	-	28.40	2.80	-

BT-LE(1Mbps)

2402MHz_TX

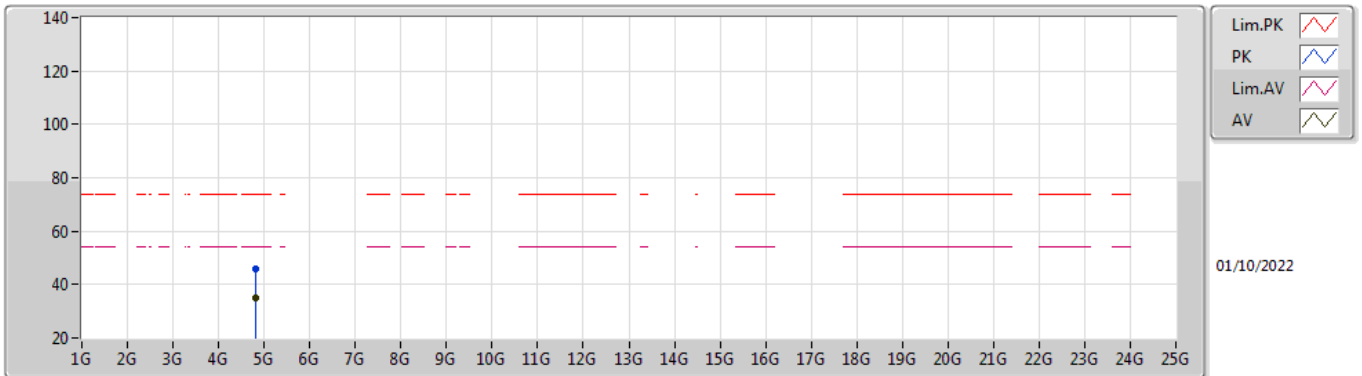

EUT X_1TX
Setting Default
02-F-C-6

Type	Freq (Hz)	Level (dBuV/m)	Limit (dBuV/m)	Margin (dB)	Raw (dBuV)	Dist (m)	Condition	Azimuth (°)	Height (m)	Comment	AF (dB)	CL (dB)	PA (dB)
PK	4.80328G	45.94	74.00	-28.06	38.83	3	Vertical	23	1.36	-	32.82	5.10	30.81
AV	4.8036G	34.78	54.00	-19.22	27.67	3	Vertical	23	1.36	-	32.82	5.10	30.81

BT-LE(1Mbps)

2402MHz_TX

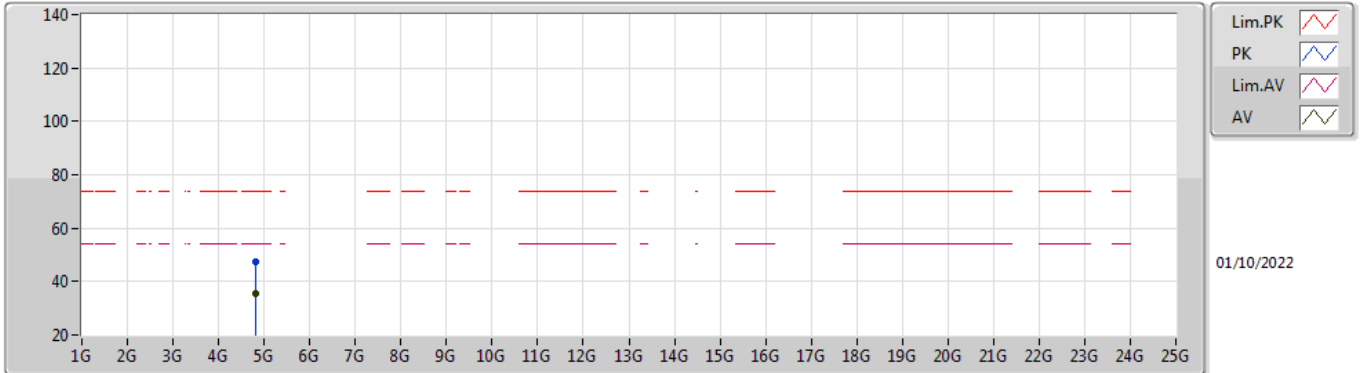

EUT_X_1TX
Setting Default
02-F-C-6

Type	Freq (Hz)	Level (dBuV/m)	Limit (dBuV/m)	Margin (dB)	Raw (dBuV)	Dist (m)	Condition	Azimuth (°)	Height (m)	Comment	AF (dB)	CL (dB)	PA (dB)
PK	4.80444G	47.24	74.00	-26.76	40.12	3	Horizontal	44	2.25	-	32.83	5.10	30.81
AV	4.80364G	35.41	54.00	-18.59	28.30	3	Horizontal	44	2.25	-	32.82	5.10	30.81

BT-LE(1Mbps)

2440MHz_TX

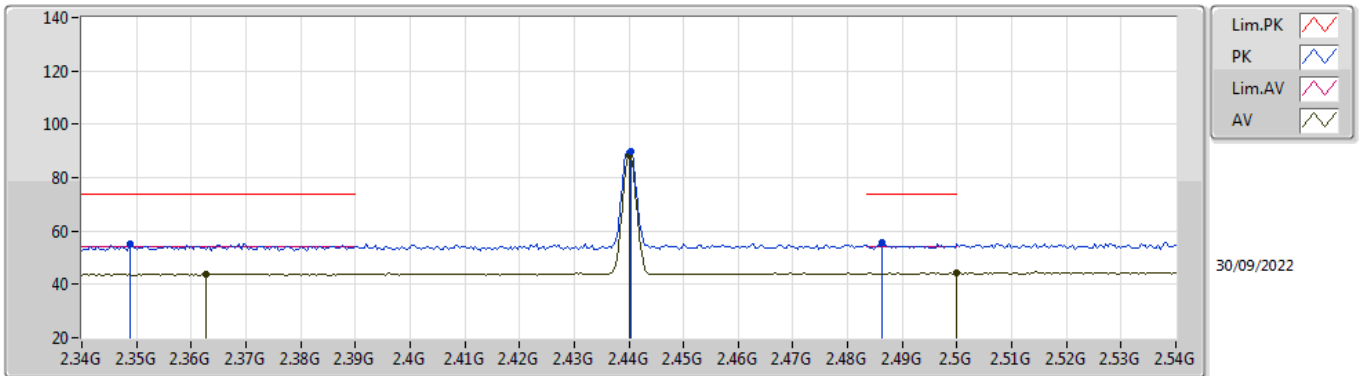

EUT_X_1TX
Setting Default
02-F-C-6

Type	Freq (Hz)	Level (dBuV/m)	Limit (dBuV/m)	Margin (dB)	Raw (dBuV)	Dist (m)	Condition	Azimuth (°)	Height (m)	Comment	AF (dB)	CL (dB)	PA (dB)
PK	2.3488G	55.06	74.00	-18.94	23.99	3	Vertical	186	1.81	-	28.30	2.77	-
AV	2.3628G	43.95	54.00	-10.05	12.84	3	Vertical	186	1.81	-	28.33	2.78	-
PK	2.4404G	89.97	Inf	-Inf	58.73	3	Vertical	186	1.81	-	28.40	2.84	-
AV	2.44G	88.50	Inf	-Inf	57.26	3	Vertical	186	1.81	-	28.40	2.84	-
PK	2.4864G	55.53	74.00	-18.47	24.09	3	Vertical	186	1.81	-	28.55	2.89	-
AV	2.5G	44.24	54.00	-9.76	12.74	3	Vertical	186	1.81	-	28.60	2.90	-

BT-LE(1Mbps)

2440MHz_TX

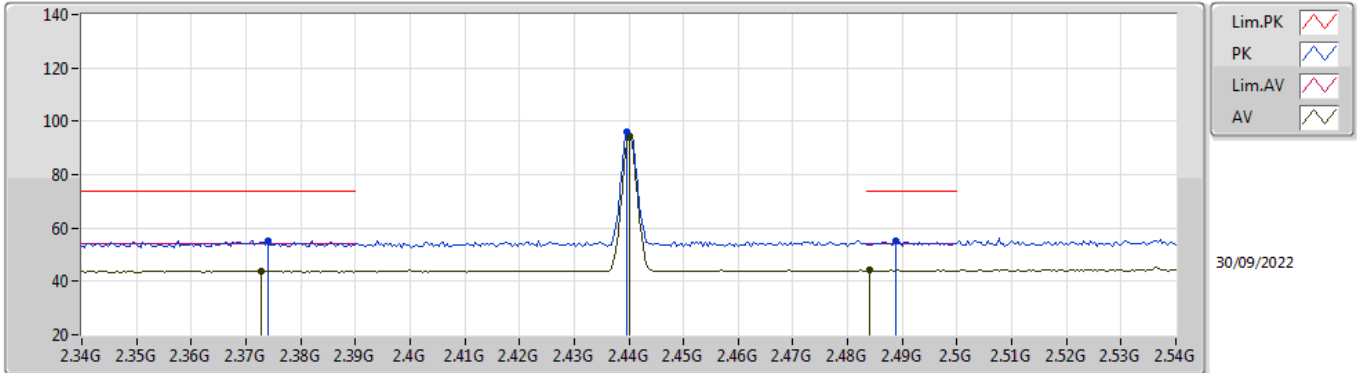

EUT_X_1TX
Setting Default
02-F-C-6

Type	Freq (Hz)	Level (dBuV/m)	Limit (dBuV/m)	Margin (dB)	Raw (dBuV)	Dist (m)	Condition	Azimuth (°)	Height (m)	Comment	AF (dB)	CL (dB)	PA (dB)
PK	2.374G	55.24	74.00	-18.76	24.10	3	Horizontal	42	2.46	-	28.35	2.79	-
AV	2.3728G	44.02	54.00	-9.98	12.88	3	Horizontal	42	2.46	-	28.35	2.79	-
PK	2.4396G	95.82	Inf	-Inf	64.58	3	Horizontal	42	2.46	-	28.40	2.84	-
AV	2.44G	94.38	Inf	-Inf	63.14	3	Horizontal	42	2.46	-	28.40	2.84	-
PK	2.4888G	55.16	74.00	-18.84	23.71	3	Horizontal	42	2.46	-	28.56	2.89	-
AV	2.484G	44.17	54.00	-9.83	12.75	3	Horizontal	42	2.46	-	28.54	2.88	-

BT-LE(1Mbps)

2440MHz_TX

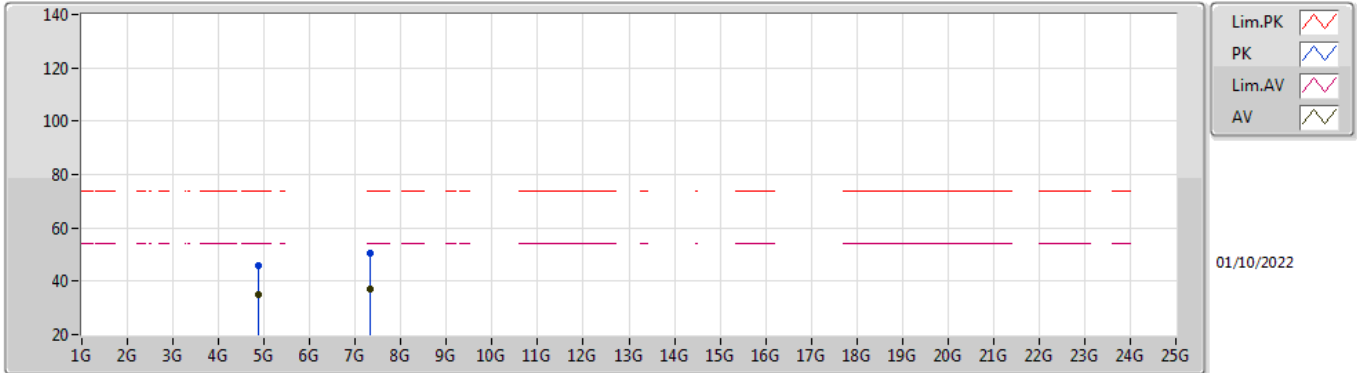

EUT_X_1TX
Setting Default
02-F-C-6

Type	Freq (Hz)	Level (dBuV/m)	Limit (dBuV/m)	Margin (dB)	Raw (dBuV)	Dist (m)	Condition	Azimuth (°)	Height (m)	Comment	AF (dB)	CL (dB)	PA (dB)
PK	4.8798G	45.96	74.00	-28.04	38.48	3	Vertical	19	1.30	-	33.16	5.10	30.78
AV	4.87952G	35.01	54.00	-18.99	27.53	3	Vertical	19	1.30	-	33.16	5.10	30.78
PK	7.32412G	50.42	74.00	-23.58	39.74	3	Vertical	206	1.80	-	36.45	6.16	31.93
AV	7.32628G	37.07	54.00	-16.93	26.39	3	Vertical	206	1.80	-	36.45	6.16	31.93

BT-LE(1Mbps)

2440MHz_TX

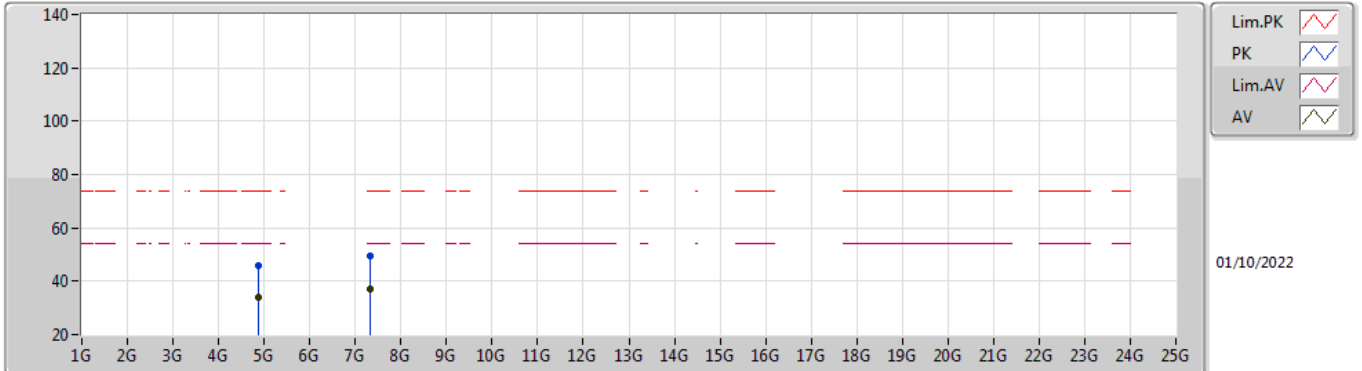

EUT_X_1TX
Setting Default
02-F-C-6

Type	Freq (Hz)	Level (dBuV/m)	Limit (dBuV/m)	Margin (dB)	Raw (dBuV)	Dist (m)	Condition	Azimuth (°)	Height (m)	Comment	AF (dB)	CL (dB)	PA (dB)
PK	4.87972G	45.86	74.00	-28.14	38.38	3	Horizontal	54	2.90	-	33.16	5.10	30.78
AV	4.88036G	33.88	54.00	-20.12	26.40	3	Horizontal	54	2.90	-	33.16	5.10	30.78
PK	7.31256G	49.67	74.00	-24.33	39.00	3	Horizontal	0	2.03	-	36.43	6.16	31.92
AV	7.32932G	36.93	54.00	-17.07	26.24	3	Horizontal	0	2.03	-	36.46	6.16	31.93

BT-LE(1Mbps)

2480MHz_TX

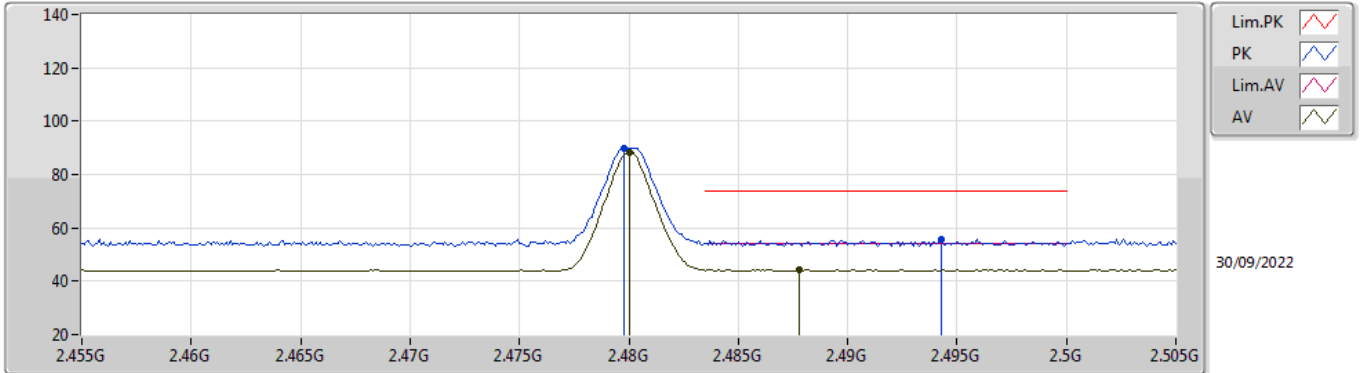

EUT_X_1TX
Setting Default
02-F-C-6

Type	Freq (Hz)	Level (dBuV/m)	Limit (dBuV/m)	Margin (dB)	Raw (dBuV)	Dist (m)	Condition	Azimuth (°)	Height (m)	Comment	AF (dB)	CL (dB)	PA (dB)
PK	2.4798G	89.98	Inf	-Inf	58.58	3	Vertical	187	3.00	-	28.52	2.88	-
AV	2.48G	88.53	Inf	-Inf	57.13	3	Vertical	187	3.00	-	28.52	2.88	-
PK	2.4943G	55.68	74.00	-18.32	24.21	3	Vertical	187	3.00	-	28.58	2.89	-
AV	2.4878G	44.34	54.00	-9.66	12.90	3	Vertical	187	3.00	-	28.55	2.89	-

BT-LE(1Mbps)

2480MHz_TX

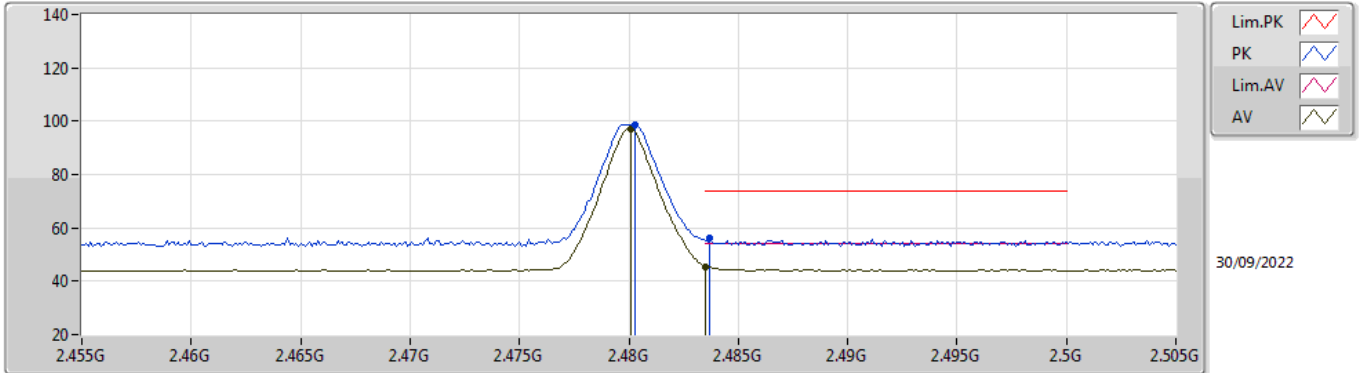

EUT_X_1TX
Setting Default
02-F-C-6

Type	Freq (Hz)	Level (dBuV/m)	Limit (dBuV/m)	Margin (dB)	Raw (dBuV)	Dist (m)	Condition	Azimuth (°)	Height (m)	Comment	AF (dB)	CL (dB)	PA (dB)
PK	2.4803G	98.62	Inf	-Inf	67.22	3	Horizontal	356	2.86	-	28.52	2.88	-
AV	2.4801G	97.22	Inf	-Inf	65.82	3	Horizontal	356	2.86	-	28.52	2.88	-
PK	2.4837G	56.06	74.00	-17.94	24.65	3	Horizontal	356	2.86	-	28.53	2.88	-
AV	2.4835G	45.51	54.00	-8.49	14.10	3	Horizontal	356	2.86	-	28.53	2.88	-

BT-LE(1Mbps)

2480MHz_TX

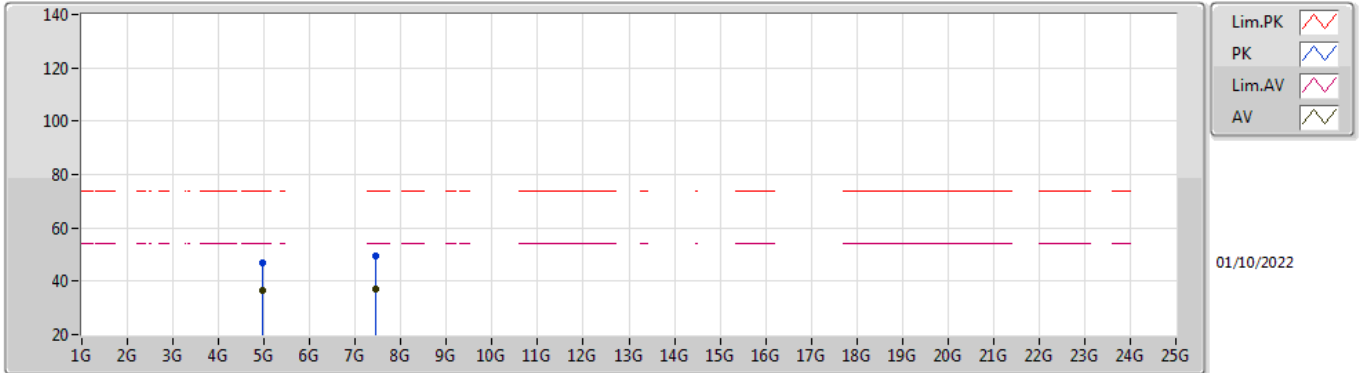

EUT_X_1TX
Setting Default
02-F-C-6

Type	Freq (Hz)	Level (dBuV/m)	Limit (dBuV/m)	Margin (dB)	Raw (dBuV)	Dist (m)	Condition	Azimuth (°)	Height (m)	Comment	AF (dB)	CL (dB)	PA (dB)
PK	4.96052G	46.67	74.00	-27.33	39.00	3	Vertical	62	2.08	-	33.32	5.10	30.75
AV	4.95968G	36.63	54.00	-17.37	28.96	3	Vertical	62	2.08	-	33.32	5.10	30.75
PK	7.43408G	49.32	74.00	-24.68	38.61	3	Vertical	60	1.80	-	36.50	6.20	31.99
AV	7.44472G	36.94	54.00	-17.06	26.24	3	Vertical	60	1.80	-	36.50	6.20	32.00

BT-LE(1Mbps)

2480MHz_TX

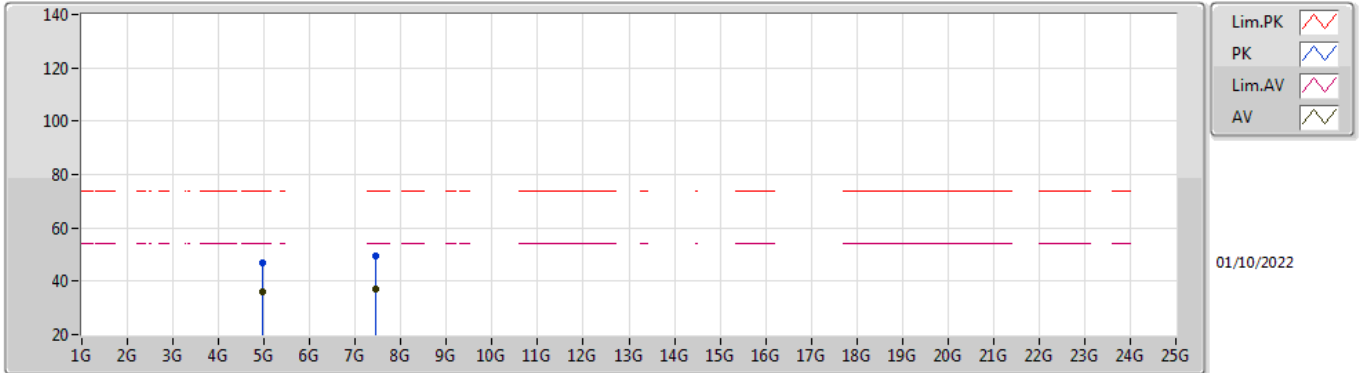

EUT_X_1TX
Setting Default
02-F-C-6

Type	Freq (Hz)	Level (dBuV/m)	Limit (dBuV/m)	Margin (dB)	Raw (dBuV)	Dist (m)	Condition	Azimuth (°)	Height (m)	Comment	AF (dB)	CL (dB)	PA (dB)
PK	4.96048G	46.93	74.00	-27.07	39.26	3	Horizontal	51	3.00	-	33.32	5.10	30.75
AV	4.9596G	36.17	54.00	-17.83	28.50	3	Horizontal	51	3.00	-	33.32	5.10	30.75
PK	7.43596G	49.62	74.00	-24.38	38.91	3	Horizontal	252	1.78	-	36.50	6.20	31.99
AV	7.443G	36.96	54.00	-17.04	26.26	3	Horizontal	252	1.78	-	36.50	6.20	32.00

BT-LE(2Mbps)

2402MHz_TX

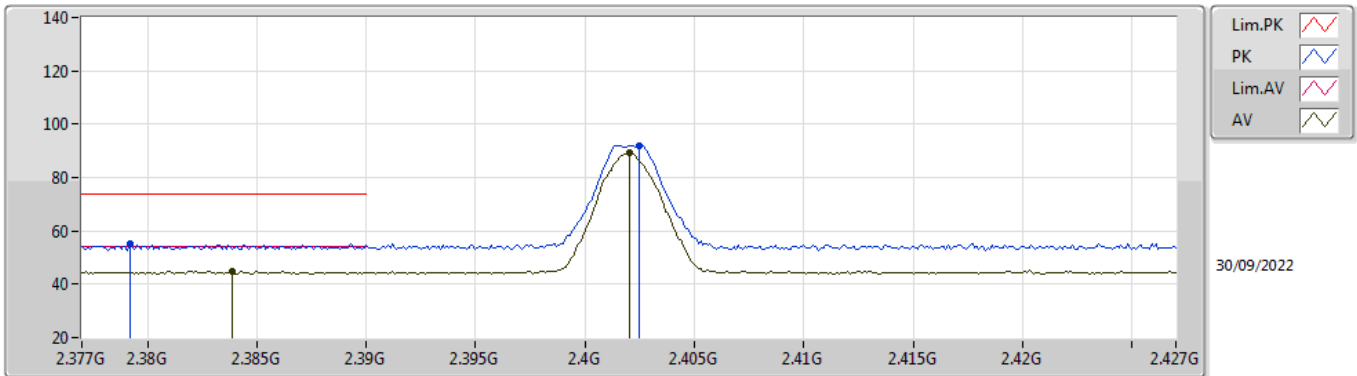

EUT X_1TX
Setting Default
02-F-C-6

Type	Freq (Hz)	Level (dBuV/m)	Limit (dBuV/m)	Margin (dB)	Raw (dBuV)	Dist (m)	Condition	Azimuth (°)	Height (m)	Comment	AF (dB)	CL (dB)	PA (dB)
PK	2.3792G	55.05	74.00	-18.95	23.90	3	Vertical	10	2.86	-	28.36	2.79	-
AV	2.3839G	44.78	54.00	-9.22	13.62	3	Vertical	10	2.86	-	28.37	2.79	-
PK	2.4025G	92.04	Inf	-Inf	60.84	3	Vertical	10	2.86	-	28.40	2.80	-
AV	2.402G	89.17	Inf	-Inf	57.97	3	Vertical	10	2.86	-	28.40	2.80	-

BT-LE(2Mbps)

2402MHz_TX

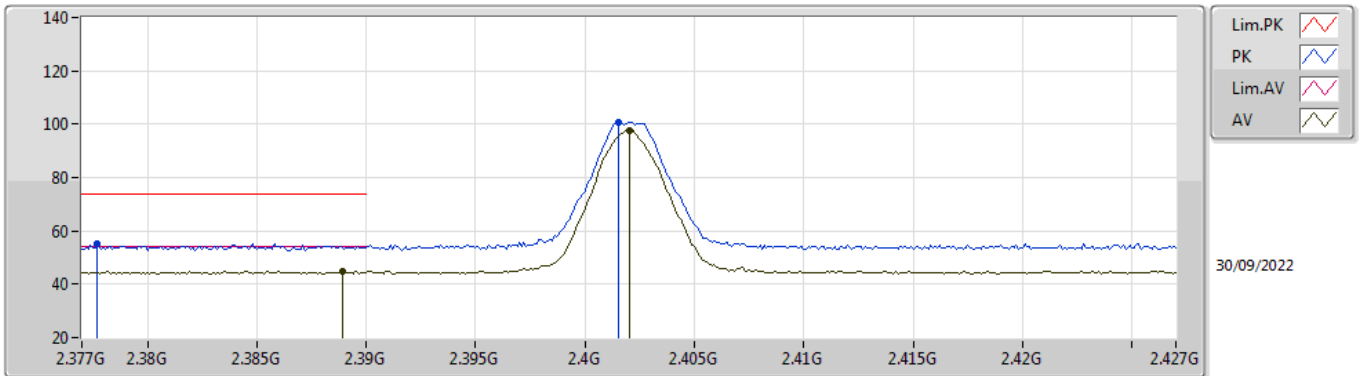

EUT_X_1TX
Setting Default
02-F-C-6

Type	Freq (Hz)	Level (dBuV/m)	Limit (dBuV/m)	Margin (dB)	Raw (dBuV)	Dist (m)	Condition	Azimuth (°)	Height (m)	Comment	AF (dB)	CL (dB)	PA (dB)
PK	2.3777G	55.18	74.00	-18.82	24.03	3	Horizontal	0	3.00	-	28.36	2.79	-
AV	2.3889G	44.87	54.00	-9.13	13.70	3	Horizontal	0	3.00	-	28.38	2.79	-
PK	2.4015G	100.50	Inf	-Inf	69.30	3	Horizontal	0	3.00	-	28.40	2.80	-
AV	2.402G	97.65	Inf	-Inf	66.45	3	Horizontal	0	3.00	-	28.40	2.80	-

BT-LE(2Mbps)

2402MHz_TX

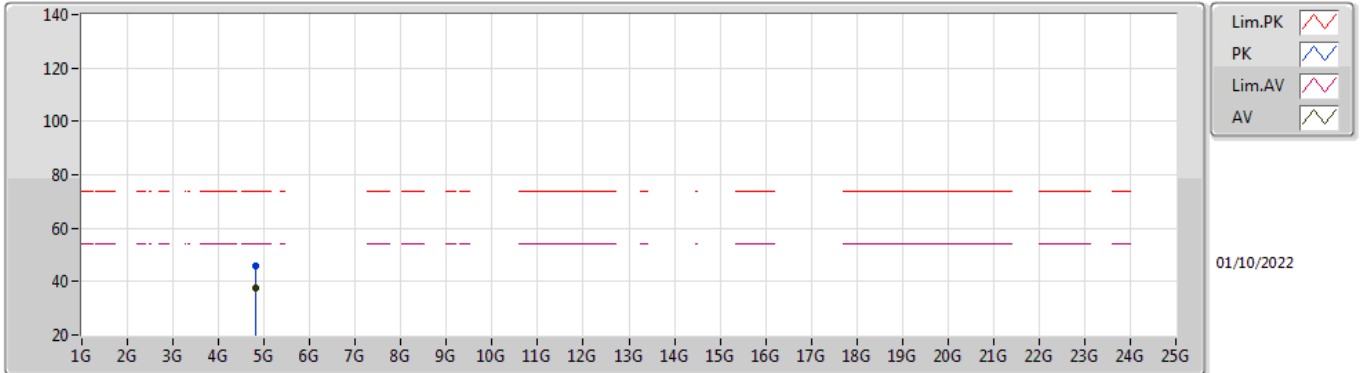

EUT X_1TX
Setting Default
02-F-C-6

Type	Freq (Hz)	Level (dBuV/m)	Limit (dBuV/m)	Margin (dB)	Raw (dBuV)	Dist (m)	Condition	Azimuth (°)	Height (m)	Comment	AF (dB)	CL (dB)	PA (dB)
PK	4.803G	45.76	74.00	-28.24	38.65	3	Vertical	24	1.78	-	32.82	5.10	30.81
AV	4.80408G	37.39	54.00	-16.61	30.28	3	Vertical	24	1.78	-	32.82	5.10	30.81

BT-LE(2Mbps)

2402MHz_TX

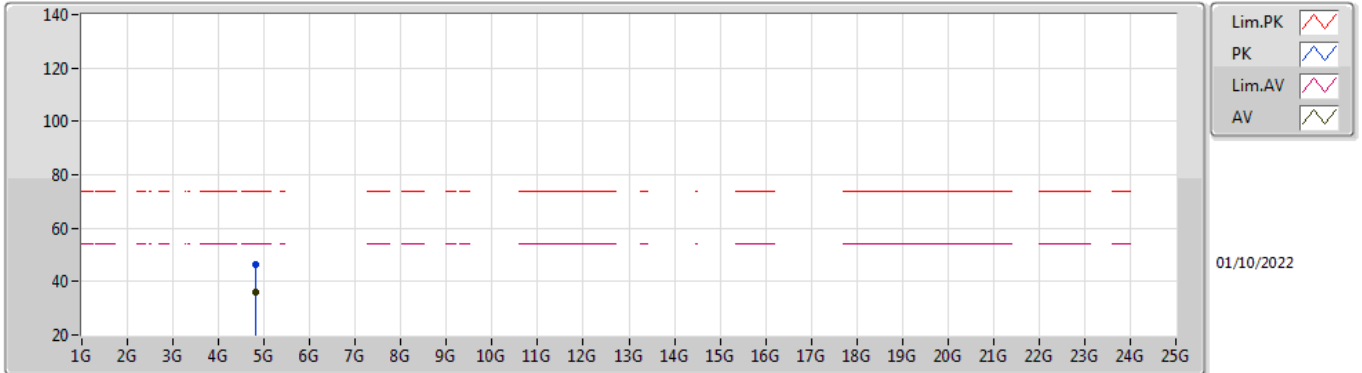

EUT X_1TX
Setting Default
02-F-C-6

Type	Freq (Hz)	Level (dBuV/m)	Limit (dBuV/m)	Margin (dB)	Raw (dBuV)	Dist (m)	Condition	Azimuth (°)	Height (m)	Comment	AF (dB)	CL (dB)	PA (dB)
PK	4.81028G	46.20	74.00	-27.80	39.05	3	Horizontal	43	2.37	-	32.86	5.10	30.81
AV	4.80308G	36.24	54.00	-17.76	29.13	3	Horizontal	43	2.37	-	32.82	5.10	30.81

BT-LE(2Mbps)

2440MHz_TX

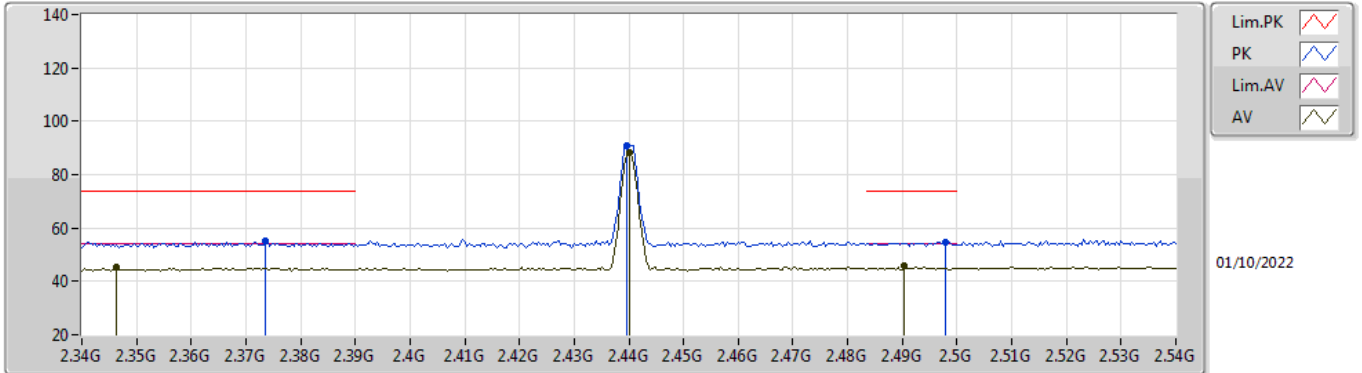

EUT_X_1TX
Setting Default
02-F-C-6

Type	Freq (Hz)	Level (dBuV/m)	Limit (dBuV/m)	Margin (dB)	Raw (dBuV)	Dist (m)	Condition	Azimuth (°)	Height (m)	Comment	AF (dB)	CL (dB)	PA (dB)
PK	2.3736G	55.34	74.00	-18.66	24.20	3	Vertical	0	2.06	-	28.35	2.79	-
AV	2.3464G	45.14	54.00	-8.86	14.08	3	Vertical	0	2.06	-	28.29	2.77	-
PK	2.4396G	91.03	Inf	-Inf	59.79	3	Vertical	0	2.06	-	28.40	2.84	-
AV	2.44G	88.26	Inf	-Inf	57.02	3	Vertical	0	2.06	-	28.40	2.84	-
PK	2.498G	54.84	74.00	-19.16	23.35	3	Vertical	0	2.06	-	28.59	2.90	-
AV	2.4904G	45.69	54.00	-8.31	14.24	3	Vertical	0	2.06	-	28.56	2.89	-

BT-LE(2Mbps)

2440MHz_TX

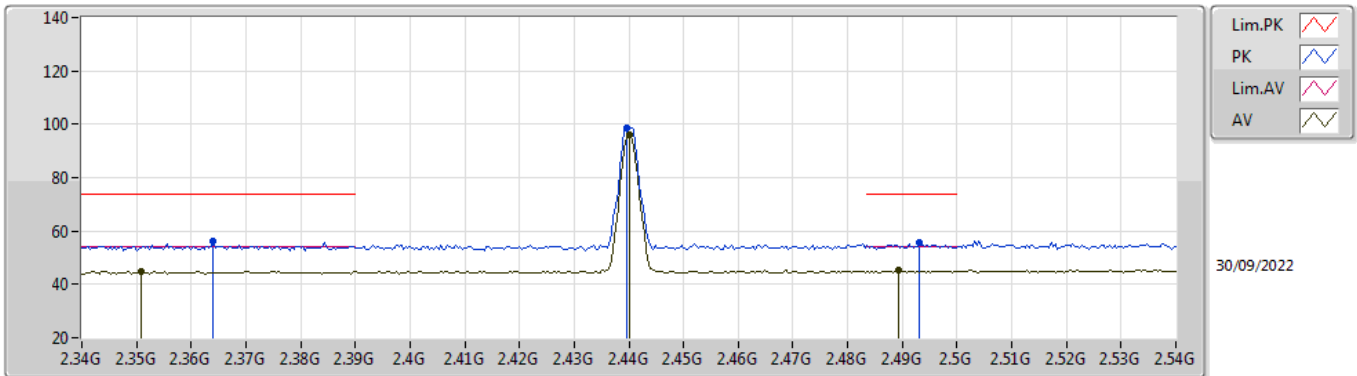

EUT_X_1TX
Setting Default
02-F-C-6

Type	Freq (Hz)	Level (dBuV/m)	Limit (dBuV/m)	Margin (dB)	Raw (dBuV)	Dist (m)	Condition	Azimuth (°)	Height (m)	Comment	AF (dB)	CL (dB)	PA (dB)
PK	2.364G	56.29	74.00	-17.71	25.18	3	Horizontal	360	2.63	-	28.33	2.78	-
AV	2.3508G	44.99	54.00	-9.01	13.91	3	Horizontal	360	2.63	-	28.30	2.78	-
PK	2.4396G	98.73	Inf	-Inf	67.49	3	Horizontal	360	2.63	-	28.40	2.84	-
AV	2.44G	95.92	Inf	-Inf	64.68	3	Horizontal	360	2.63	-	28.40	2.84	-
PK	2.4932G	55.74	74.00	-18.26	24.28	3	Horizontal	360	2.63	-	28.57	2.89	-
AV	2.4892G	45.15	54.00	-8.85	13.70	3	Horizontal	360	2.63	-	28.56	2.89	-

BT-LE(2Mbps)

2440MHz_TX

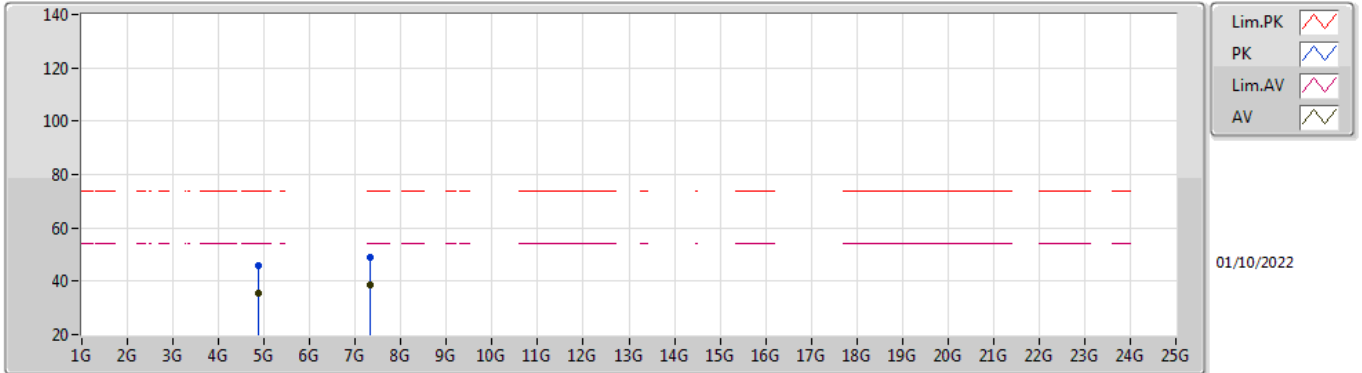

EUT_X_1TX
Setting Default
02-F-C-6

Type	Freq (Hz)	Level (dBuV/m)	Limit (dBuV/m)	Margin (dB)	Raw (dBuV)	Dist (m)	Condition	Azimuth (°)	Height (m)	Comment	AF (dB)	CL (dB)	PA (dB)
PK	4.88116G	46.07	74.00	-27.93	38.59	3	Vertical	0	2.98	-	33.16	5.10	30.78
AV	4.87992G	35.38	54.00	-18.62	27.90	3	Vertical	0	2.98	-	33.16	5.10	30.78
PK	7.32272G	49.06	74.00	-24.94	38.38	3	Vertical	254	2.55	-	36.45	6.16	31.93
AV	7.32272G	38.79	54.00	-15.21	28.11	3	Vertical	254	2.55	-	36.45	6.16	31.93

BT-LE(2Mbps)

2440MHz_TX

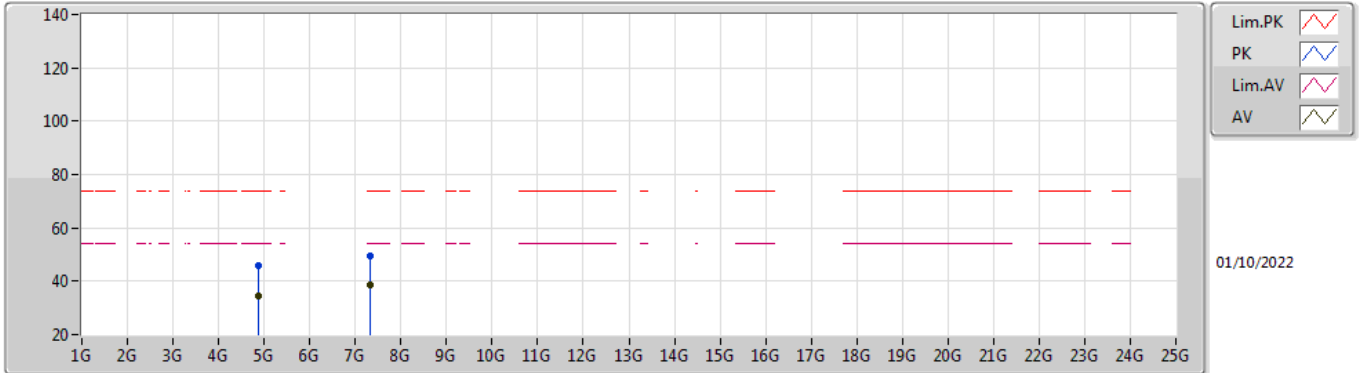

EUT_X_1TX
Setting Default
02-F-C-6

Type	Freq (Hz)	Level (dBuV/m)	Limit (dBuV/m)	Margin (dB)	Raw (dBuV)	Dist (m)	Condition	Azimuth (°)	Height (m)	Comment	AF (dB)	CL (dB)	PA (dB)
PK	4.87664G	45.74	74.00	-28.26	38.27	3	Horizontal	28	1.80	-	33.15	5.10	30.78
AV	4.88016G	34.63	54.00	-19.37	27.15	3	Horizontal	28	1.80	-	33.16	5.10	30.78
PK	7.3228G	49.26	74.00	-24.74	38.58	3	Horizontal	178	1.34	-	36.45	6.16	31.93
AV	7.31688G	38.77	54.00	-15.23	28.10	3	Horizontal	178	1.34	-	36.43	6.16	31.92

BT-LE(2Mbps)

2480MHz_TX

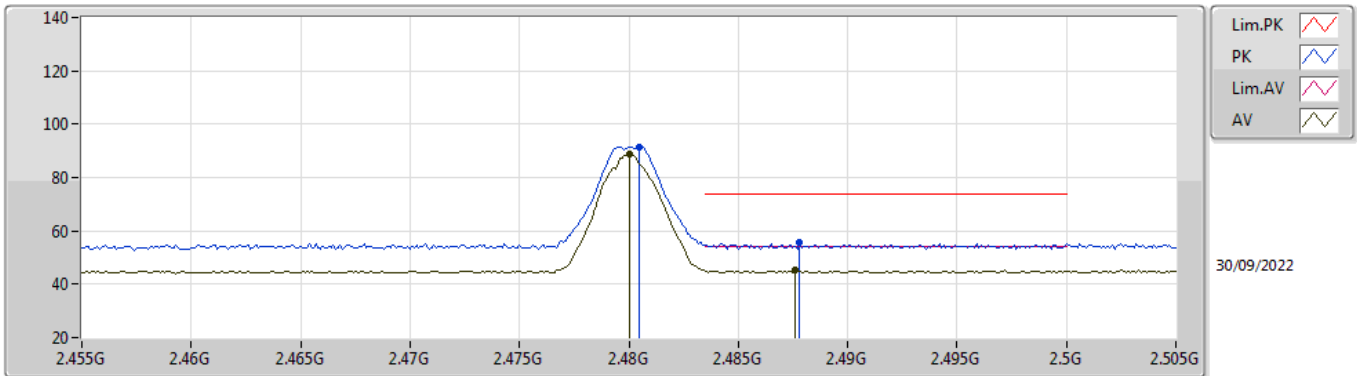

EUT_X_1TX
Setting Default
02-F-C-6

Type	Freq (Hz)	Level (dBuV/m)	Limit (dBuV/m)	Margin (dB)	Raw (dBuV)	Dist (m)	Condition	Azimuth (°)	Height (m)	Comment	AF (dB)	CL (dB)	PA (dB)
PK	2.4805G	91.40	Inf	-Inf	60.00	3	Vertical	0	2.70	-	28.52	2.88	-
AV	2.48G	88.57	Inf	-Inf	57.17	3	Vertical	0	2.70	-	28.52	2.88	-
PK	2.4878G	55.65	74.00	-18.35	24.21	3	Vertical	0	2.70	-	28.55	2.89	-
AV	2.4876G	45.17	54.00	-8.83	13.73	3	Vertical	0	2.70	-	28.55	2.89	-

BT-LE(2Mbps)

2480MHz_TX

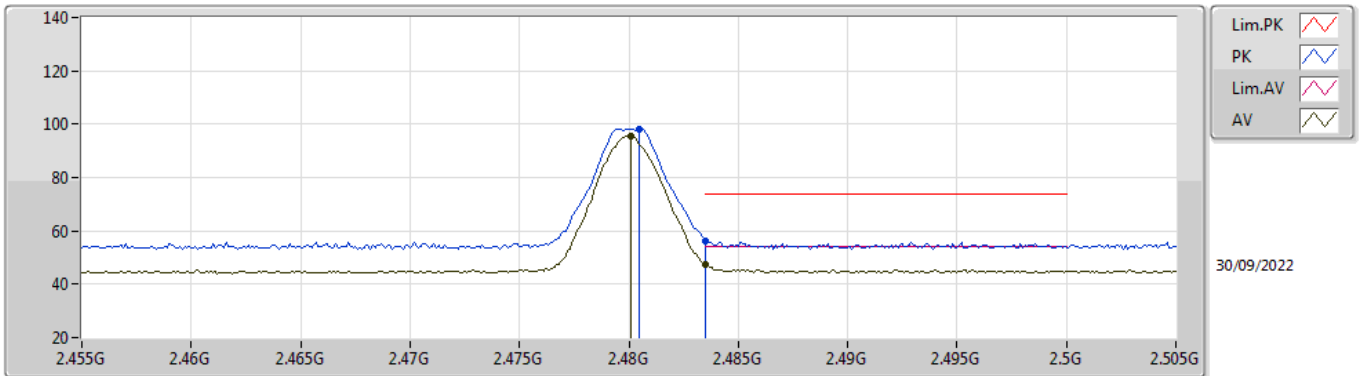

EUT_X_1TX
Setting Default
02-F-C-6

Type	Freq (Hz)	Level (dBuV/m)	Limit (dBuV/m)	Margin (dB)	Raw (dBuV)	Dist (m)	Condition	Azimuth (°)	Height (m)	Comment	AF (dB)	CL (dB)	PA (dB)
PK	2.4805G	98.32	Inf	-Inf	66.92	3	Horizontal	0	2.86	-	28.52	2.88	-
AV	2.4801G	95.61	Inf	-Inf	64.21	3	Horizontal	0	2.86	-	28.52	2.88	-
PK	2.4835G	56.41	74.00	-17.59	25.00	3	Horizontal	0	2.86	-	28.53	2.88	-
AV	2.4835G	47.64	54.00	-6.36	16.23	3	Horizontal	0	2.86	-	28.53	2.88	-

BT-LE(2Mbps)

2480MHz_TX

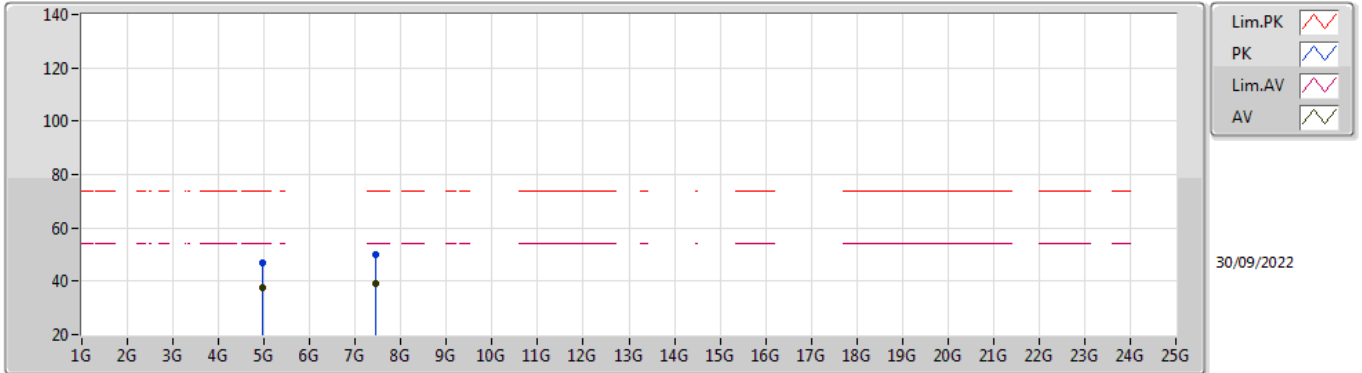

EUT_X_1TX
Setting Default
02-F-C-6

Type	Freq (Hz)	Level (dBuV/m)	Limit (dBuV/m)	Margin (dB)	Raw (dBuV)	Dist (m)	Condition	Azimuth (°)	Height (m)	Comment	AF (dB)	CL (dB)	PA (dB)
PK	4.95424G	46.78	74.00	-27.22	39.12	3	Vertical	28	1.00	-	33.31	5.10	30.75
AV	4.96008G	37.45	54.00	-16.55	29.78	3	Vertical	28	1.00	-	33.32	5.10	30.75
PK	7.43376G	50.05	74.00	-23.95	39.34	3	Vertical	336	1.50	-	36.50	6.20	31.99
AV	7.44984G	39.17	54.00	-14.83	28.47	3	Vertical	336	1.50	-	36.50	6.20	32.00

BT-LE(2Mbps)

2480MHz_TX

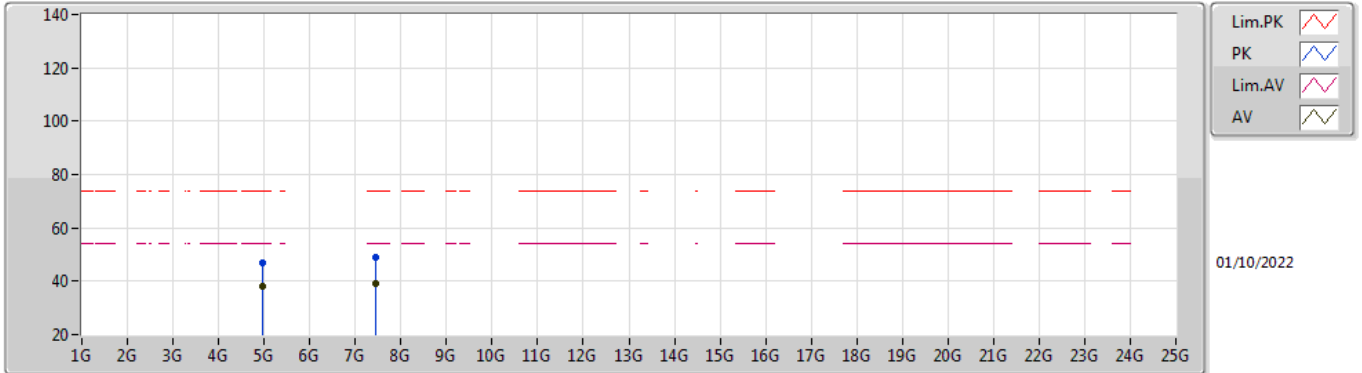

EUT_X_1TX
Setting Default
02-F-C-6

Type	Freq (Hz)	Level (dBuV/m)	Limit (dBuV/m)	Margin (dB)	Raw (dBuV)	Dist (m)	Condition	Azimuth (°)	Height (m)	Comment	AF (dB)	CL (dB)	PA (dB)
PK	4.96068G	46.95	74.00	-27.05	39.28	3	Horizontal	53	3.00	-	33.32	5.10	30.75
AV	4.96004G	38.16	54.00	-15.84	30.49	3	Horizontal	53	3.00	-	33.32	5.10	30.75
PK	7.4318G	49.19	74.00	-24.81	38.48	3	Horizontal	42	1.09	-	36.50	6.20	31.99
AV	7.4352G	38.99	54.00	-15.01	28.28	3	Horizontal	42	1.09	-	36.50	6.20	31.99