



SPORTON International Inc.

No. 52, Hwa Ya 1st Rd., Kwei-Shan Hsiang, TaoYuan Hsien, Taiwan, R.O.C.
Ph: 886-3-327-3456 / FAX: 886-3-327-0973 / www.sporton.com.tw

FCC Dynamic Frequency Selection Test Report

Applicant's company	Accton Technology Corporation
Applicant Address	No.1 Creation 3rd Rd., Science-based Industrial Park, Hsinchu 30077, Taiwan R.O.C.
FCC ID	HEDE21011
Manufacturer's company	Accton Technology Corporation
Manufacturer Address	No.1 Creation 3rd Rd., Science-based Industrial Park, Hsinchu 30077, Taiwan R.O.C.

Product Name	Draft 11n Dual band Wireless Access Point
Brand Name	SMC
Model Name	SMCE21011
Test Standard(s)	47 CFR FCC Part 15 Subpart E § 15.407
Test Freq. Range	5150~5350 / 5470~5725 MHz
Received Date	Mar. 01, 2009
Final Test Date	Mar. 24, 2009
Submission Type	Original Equipment
Operating Mode	Master



Statement

The test result in this report refers exclusively to the presented test model / sample.

Without written approval of SPORTON International Inc., the test report shall not be reproduced except in full. The measurements and test results shown in this test report were made in accordance with the procedures and found in compliance with the limit given in FCC OET Order 06-96A (2006) and 47 CFR FCC Part 15 Subpart E § 15.407. The test equipment used to perform the test is calibrated and traceable to NML/ROC.



Testing Laboratory
1190

Table of Contents

1. CERTIFICATE OF COMPLIANCE	1
2. SUMMARY OF THE TEST RESULT	2
3. GENERAL INFORMATION	3
3.1. Standard Requirement	3
3.2. Product Specification Table.....	3
3.3. Accessories.....	5
3.4. Manufacturer Statement.....	6
3.5. Table for DFS Band Carrier Frequencies	6
3.6. Antenna Information on DFS Band.....	7
4. DFS DETECTION THRESHOLDS AND RADAR TEST WAVEFORMS	8
4.1. Interference Threshold values, Master or Client incorporating In-Service Monitoring	8
4.2. DFS Response requirement values.....	8
4.3. Radar Test Waveforms Minimum Step.....	9
4.4. Short Pulse Radar Test Waveforms	9
4.5. Long Pulse Radar Test Waveform.....	10
4.6. Frequency Hopping Radar Test Waveform.....	13
4.7. Conducted Calibration Setup	15
4.8. Radar Waveform Calibration Procedure	15
4.9. Calibration Deviation.....	15
4.10. Radar Waveform Calibration Result	16
5. TEST SETUP AND TEST RESULT.....	22
5.1. Test setup	22
5.2. UNII Detection Bandwidth Measurement	28
5.3. Initial Channel Availability Check Time Measurement	47
5.4. Radar Burst at the Beginning of the Channel Availability Check Time Measurement	49
5.5. Radar Burst at the End of the Channel Availability Check Time Measurement	51
5.6. In-Service Monitoring for Channel Move Time, Channel Closing Transmission Time and Non-Occupancy Period Measurement	53
5.7. Statistical Performance Check Measurement	62
6. LIST OF MEASURING EQUIPMENTS	75
7. TEST LOCATION.....	76
8. TAF CERTIFICATE OF ACCREDITATION	77
APPENDIX A. PHOTOGRAPHS OF EUT.....	A1 ~ A18
APPENDIX B. ANTENNA SPECIFICATION	

History of This Test Report

Original Issue Date: Mar. 27, 2009

Report No.: FZ931603

- No additional attachment.
- Additional attachment were issued as following record:

Attachment No.	Issue Date	Description



1. CERTIFICATE OF COMPLIANCE

Product Name : Draff 11n Dual band Wireless Access Point
Brand Name : SMC
Model Name : SMCE21011
Applicant : Accton Technology Corporation
Test Rule Part(s) : 47 CFR FCC Part 15 Subpart E § 15.407

Sporton International as requested by the applicant to evaluate the EMC performance of the product sample received on Mar. 01, 2009 would like to declare that the tested sample has been evaluated and found to be in compliance with the tested rule parts. The data recorded as well as the test configuration specified is true and accurate for showing the sample's EMC nature.



Wayne Hsu
Wayne Hsu

SPORTON INTERNATIONAL INC.

2. SUMMARY OF THE TEST RESULT

Applied Standard: OET Order 06-96A (2006)			
Part	Appendix	Description of Test	Result
5.2	7.8.1	UNII Detection Bandwidth Measurement	Complies
5.3	7.8.2.1	Initial Channel Availability Check Time	Complies
5.4	7.8.2.2	Radar Burst at the Beginning of the Channel Availability Check Time	Complies
5.5	7.8.2.3	Radar Burst at the End of the Channel Availability Check Time	Complies
5.6	7.8.3	In-Service Monitoring for Channel Move Time, Channel Closing Transmission Time and Non-Occupancy Period	Complies
5.7	7.4	Statistical Performance Check	Complies

3. GENERAL INFORMATION

3.1. Standard Requirement

FCC 15.407: U-NII devices operating in the 5.25-5.35 GHz band and the 5.47-5.725 GHz band shall employ a TPC mechanism. The U-NII device is required to have the capability to operate at least 6 dB below the mean EIRP value of 30 dBm. A TPC mechanism is not required for systems with an e.i.r.p. of less than 500 mW.

U-NII devices operating in the 5.25-5.35 GHz and 5.47-5.725 GHz bands shall employ a DFS radar detection mechanism to detect the presence of radar systems and to avoid co-channel operation with radar systems.

3.2. Product Specification Table

Specification Items	Description
Product Type	WLAN (3TX, 3RX)
Radio Type	Intentional Transceiver
Power Type	From Power Adapter & From POE
Modulation	see the below table for draft n OFDM (BPSK / QPSK / 16QAM / 64QAM) for IEEE 802.11a
Data Rate (Mbps)	see the below table for draft n OFDM (6/9/12/18/24/36/48/54) for IEEE 802.11a
Operating Frequency Range	2400~2483.5 / 5150~5350 / 5470~5725 / 5725~5850 MHz
Channel Bandwidth	20/40 MHz operating channel bandwidth
DFS Function	5260~5320 MHz ; 5500~5700 MHz
Max. Con. Power (DFS band)	<Draft n>: Band 2: MCS0 (20MHz) : 20.94 dBm, MCS0 (40MHz) : 23.50 dBm Band 3: MCS0 (20MHz) : 22.49 dBm, MCS0 (40MHz) : 22.14 dBm <802.11a >: Band 2: 21.98 dBm ; Band 3: 22.88 dBm
Min. Con. Power (DFS band)	< Draft n >: Band 2: MCS0 (20MHz) : 14.94 dBm, MCS0 (40MHz) : 17.50 dBm Band 3: MCS0 (20MHz) : 16.49 dBm, MCS0 (40MHz) : 16.14 dBm <802.11a >: Draft n: Band 2: 15.98 dBm ; Band 3: 16.88 dBm
Max. EIRP Power (DFS band)	< Draft n >: Band 2: MCS0 (20MHz) : 25.94 dBm, MCS0 (40MHz) : 28.50 dBm Band 3: MCS0 (20MHz) : 27.49 dBm, MCS0 (40MHz) : 27.14 dBm <802.11a >: Band 2: 26.98 dBm ; Band 3: 27.88 dBm

Min. EIRP Power (DFS band)	<Draft n>: Band 2: MCS0 (20MHz) : 19.94 dBm, MCS0 (40MHz) : 22.50 dBm Band 3: MCS0 (20MHz) : 21.49 dBm, MCS0 (40MHz) : 21.14 dBm <802.11a>: Band 2: 20.98 dBm ; Band 3: 21.88 dBm
TPC Function	5260~5320 MHz ; 5500~5700 MHz
Operating Mode	Master
Communication Mode	IP based system
Power-on cycle	Draft n: Requires 41.4 seconds to complete its power-on cycle. 11a: Requires 42.7 seconds to complete its power-on cycle.
Uniform Spreading	For the 5250-5350 MHz and 5470-5725 MHz bands, the Master device provides, on aggregate, uniform loading of the spectrum across all devices by selecting an operating channel among the available channels using a random algorithm.
Firmware Version	IMAGE A_1.1.0.5DT1_Backup IMAGE B_1.1.0.5DT2_Active
Carrier Frequencies	Please refer to section 3.5
Antenna	Please refer to section 3.6

Antenna & Band width

Antenna	Three (TX)	
Band width Mode	20 MHz	40 MHz
802.11a	V	X
Draft n	V	V

Draft n spec

MCS Index	Nss	Modulation	R	NBPS	NCBPS		NDBPS		Datarate(Mbps)			
									800nsGI		400nsGI	
					20MHz	40MHz	20MHz	40MHz	20MHz	40MHz	20MHz	40MHz
0	1	BPSK	1/2	1	52	108	26	54	6.5	13.5	7.200	15
1	1	QPSK	1/2	2	104	216	52	108	13.0	27.0	14.400	30
2	1	QPSK	3/4	2	104	216	78	162	19.5	40.5	21.700	45
3	1	16-QAM	1/2	4	208	432	104	216	26.0	54.0	28.900	60
4	1	16-QAM	3/4	4	208	432	156	324	39.0	81.0	43.300	90
5	1	64-QAM	2/3	6	312	648	208	432	52.0	108.0	57.800	120
6	1	64-QAM	3/4	6	312	648	234	486	58.5	121.5	65.000	135
7	1	64-QAM	5/6	6	312	648	260	540	65.0	135.0	72.200	150
8	2	BPSK	1/2	1	104	216	52	108	13.0	27.0	14.444	30
9	2	QPSK	1/2	2	208	432	104	216	26.0	54.0	28.889	60
10	2	QPSK	3/4	2	208	432	156	324	39.0	81.0	43.333	90
11	2	16-QAM	1/2	4	416	864	208	432	52.0	108.0	57.778	120
12	2	16-QAM	3/4	4	416	864	312	648	78.0	162.0	86.667	180
13	2	64-QAM	2/3	6	624	1296	416	864	104.0	216.0	115.556	240
14	2	64-QAM	3/4	6	624	1296	468	972	117.0	243.0	130.000	270
15	2	64-QAM	5/6	6	624	1296	520	1080	130.0	270.0	144.444	300

Symbol	Explanation
NSS	Number of spatial streams
R	Code rate
NBPS	Number of coded bits per single carrier
NCBPS	Number of coded bits per symbol
NDBPS	Number of data bits per symbol
GI	guard interval

3.3. Accessories

Power	Brand	Model	Rating
Adapter	APD	DA-24F12	Input: 100-240VAC, 50-60Hz, 0.65A Output: 12VDC, 2A

3.4. Manufacturer Statement

Manufacturer statement confirming that information regarding the parameters of the detected *Radar Waveforms* are not available to the end user.

3.5. Table for DFS Band Carrier Frequencies

There are two bandwidth systems for draft n.

For both 20MHz bandwidth systems, use Channel 52, 56, 60, 64, 100, 104, 108, 112, 116, 120, 124, 128, 132, 136, 140.

For both 40MHz bandwidth systems, use Channel 54, 62, 102, 110, 118, 126, 134.

There is one bandwidth system for IEEE 802.11a.

Frequency Band	Channel No.	Frequency	Channel No.	Frequency
5250~5350 MHz Band 2 (DFS Band)	52	5260 MHz	60	5300 MHz
	54	5270 MHz	62	5310 MHz
	56	5280 MHz	64	5320 MHz
5470~5725 MHz Band 3 (DFS Band)	100	5500 MHz	120	5600 MHz
	102	5510 MHz	124	5620 MHz
	104	5520 MHz	126	5630 MHz
	108	5540 MHz	128	5640 MHz
	110	5550 MHz	132	5660 MHz
	112	5560 MHz	134	5670 MHz
	116	5580 MHz	136	5680 MHz
	118	5590 MHz	140	5700 MHz

3.6. Antenna Information on DFS Band

<For 5GHz Band>

Ant.	Brand	Model Name	Antenna Type	Connector	Gain (dBi)	Remark
A	LCT	FDE_ACBSMA-BGP	Dipole Antenna	Reversed-SMA	5.00	TX/RX
B	LCT	FDE_ACBSMA-BGP	Dipole Antenna	Reversed-SMA	5.00	TX/RX
C	LCT	FDE_ACBSMA-BGP	Dipole Antenna	Reversed-SMA	5.00	TX/RX

Note: The EUT has three Antennas (3TX/3RX).

For 802.11abgn Mode:

Ant. A, Ant. B and Ant. C will transmit and receive the same signal simultaneously.

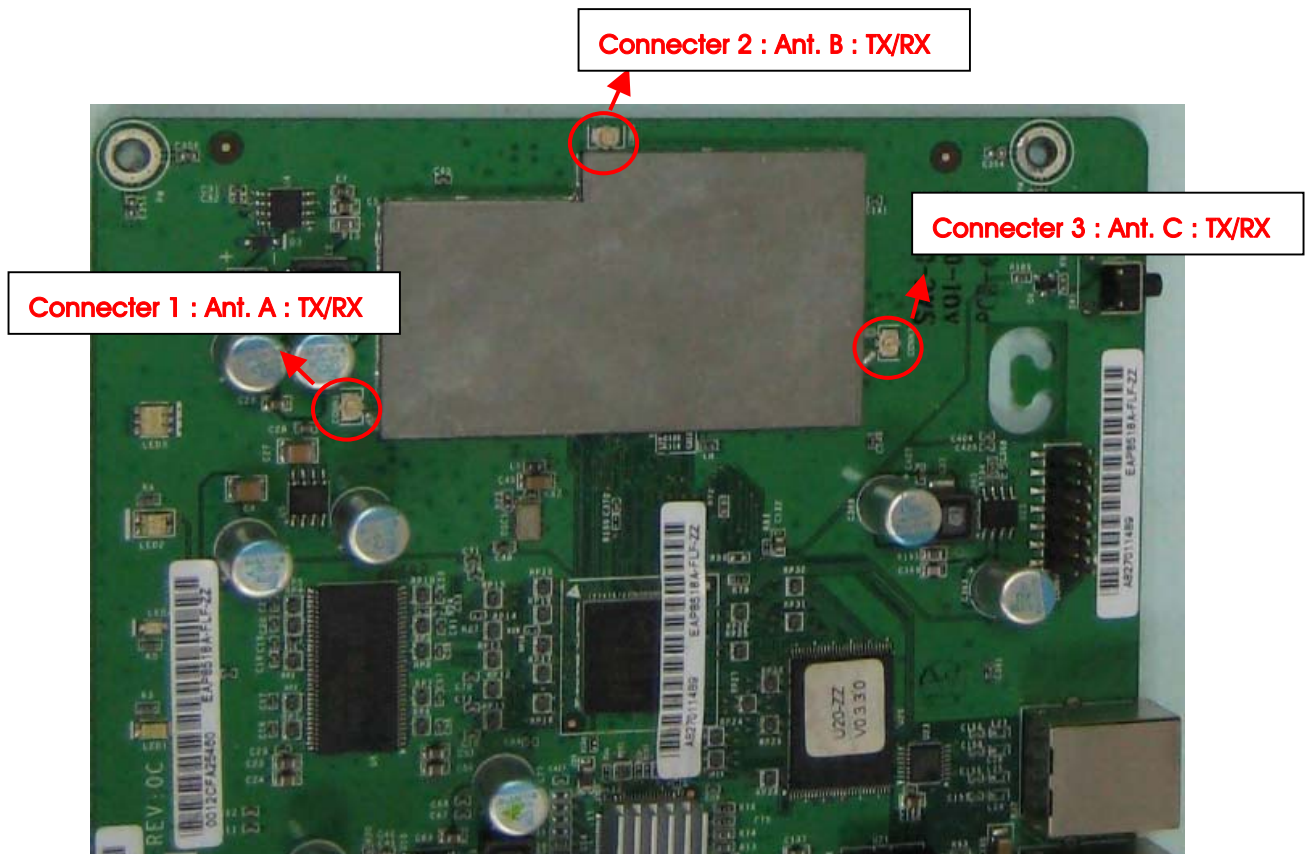

4. DFS DETECTION THRESHOLDS AND RADAR TEST WAVEFORMS

4.1. Interference Threshold values, Master or Client incorporating In-Service Monitoring

Maximum Transmit Power	Value (see note)
≥ 200 milliwatt	-64 dBm
< 200 milliwatt	-62 dBm

Note 1: This is the level at the input of the receiver assuming a 0 dBi receive antenna.

Note 2: Throughout these test procedures an additional 1 dB has been added to the amplitude of the test transmission waveforms to account for variations in measurement equipment. This will ensure that the test signal is at or above the detection threshold level to trigger a DFS response.

The radar *Detection Threshold*, lowest antenna gain is the parameter of Interference *radar DFS detection threshold*, The Interference *Detection Threshold* is the $(-64\text{dBm}) + 1\text{ dB} = -63\text{ dBm}$.

4.2. DFS Response requirement values

Parameter	Value
<i>Non-occupancy period</i>	Minimum 30 minutes
<i>Channel Availability Check Time</i>	60 seconds
<i>Channel Move Time</i>	10 seconds See Note 1.
<i>Channel Closing Transmission Time</i>	200 milliseconds + an aggregate of 60 milliseconds over remaining 10 second period. See Notes 1 and 2.
<i>U-NII Detection Bandwidth</i>	Minimum 80% of the 99% power bandwidth See Note 3.

Note 1: The instant that the *Channel Move Time* and the *Channel Closing Transmission Time* begins is as follows:

- For the Short pulse radar Test Signals this instant is the end of the *Burst*.
- For the Frequency Hopping radar Test Signal, this instant is the end of the last radar *Burst* generated.
- For the Long Pulse radar Test Signal this instant is the end of the 12 second period defining the radar transmission.

Note 2: The *Channel Closing Transmission Time* is comprised of 200 milliseconds starting at the beginning of the *Channel Move Time* plus any additional intermittent control signals required to facilitate *Channel* changes (an aggregate of 60 milliseconds) during the remainder of the 10 second period. The aggregate duration of control signals will not count quiet periods in between transmissions.

Note 3: During the *U-NII Detection Bandwidth* detection test, radar type 1 is used and for each frequency step the minimum percentage of detection is 90%. Measurements are performed with no data traffic.

4.3. Radar Test Waveforms Minimum Step

Step intervals of 0.1 microsecond for Pulse Width, 1 microsecond for PRI, 1 MHz for chirp width and 1 for the number of pulses will be utilized for the random determination of specific test waveforms.

4.4. Short Pulse Radar Test Waveforms

Radar Type	Pulse Width (μsec)	PRI (μsec)	Number of Pulses	Minimum Percentage of Successful Detection	Minimum Trials
1	1	1428	18	60%	30
2	1-5	150-230	23-29	60%	30
3	6-10	200-500	16-18	60%	30
4	11-20	200-500	12-16	60%	30
Aggregate (Radar Types 1-4)				80%	120

A minimum of 30 unique waveforms are required for each of the short pulse radar types 2 through 4. For short pulse radar type 1, the same waveform is used a minimum of 30 times. If more than 30 waveforms are used for short pulse radar types 2 through 4, then each additional waveform must also be unique and not repeated from the previous waveforms. The aggregate is the average of the percentage of successful detections of short pulse radar types 1-4.

FCC Radar Types (1~4) System Diagram

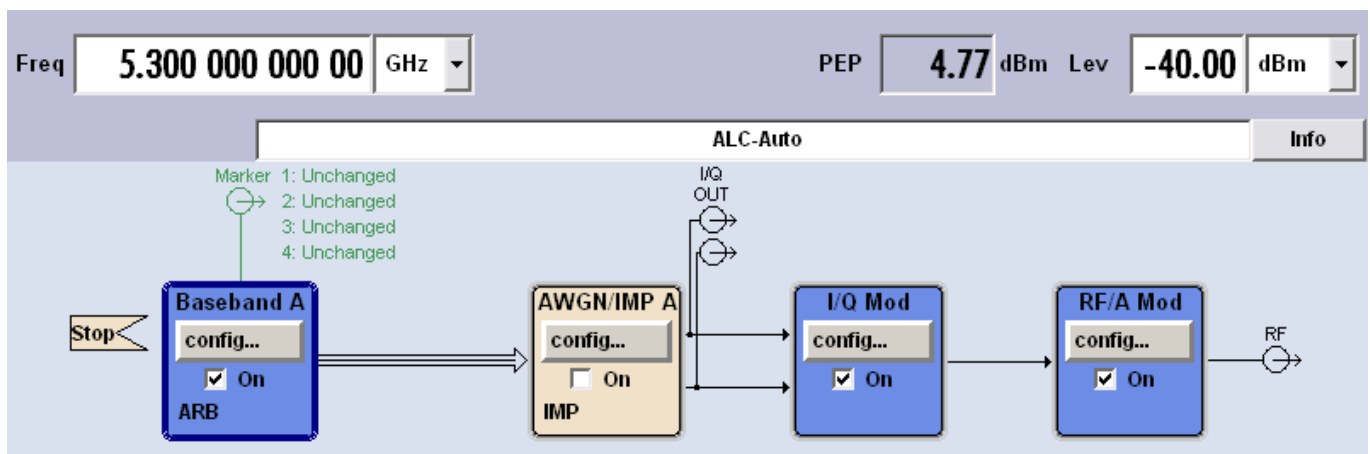

Used R&S SMU200A (Vector SG with one ARB) or SG + ARB

B11: Base-band Generator with ARB (16 M samples) and Digital Modulation

B13: Base-band Main Module

B106: frequency range (100 kHz to 6 GHz)

For selecting the waveform parameters from within the bounds of the signal type, system were random selection using uniform distribution.

4.5. Long Pulse Radar Test Waveform

Radar Type	Pulse Width (μsec)	Chirp Width (MHz)	PRI (μsec)	Number of Pulses per Burst	Number of Bursts	Minimum Percentage of Successful Detection	Minimum Trials
5	50-100	5-20	1000-2000	1-3	8-20	80%	30

The parameters for this waveform are randomly chosen. Thirty unique waveforms are required for the Long Pulse radar test signal. If more than 30 waveforms are used for the Long Pulse radar test signal, then each additional waveform must also be unique and not repeated from the previous waveforms. Each waveform is defined as follows:

- (1) The transmission period for the Long Pulse Radar test signal is 12 seconds.
- (2) There are a total of 8 to 20 Bursts in the 12 second period, with the number of Bursts being randomly chosen. This number is Burst_Count.
- (3) Each Burst consists of 1 to 3 pulses, with the number of pulses being randomly chosen. Each Burst within the 12 second sequence may have a different number of pulses.
- (4) The pulse width is between 50 and 100 microseconds, with the pulse width being randomly chosen. Each pulse within a Burst will have the same pulse width. Pulses in different Bursts may have different pulse widths.
- (5) Each pulse has a linear FM chirp between 5 and 20 MHz, with the chirp width being randomly chosen. Each pulse within a Burst will have the same chirp width. Pulses in different Bursts may have different chirp widths. The chirp is centered on the pulse. For example, with a radar frequency of 5300 MHz and a 20 MHz chirped signal, the chirp starts at 5290 MHz and ends at 5310 MHz.
- (6) If more than one pulse is present in a Burst, the time between the pulses will be between 1000 and 2000 microseconds, with the time being randomly chosen. If three pulses are present in a Burst, the time between the first and second pulses is chosen independently of the time between the second and third pulses.
- (7) The 12 second transmission period is divided into even intervals. The number of intervals is equal to Burst_Count. Each interval is of length $(12,000,000 / \text{Burst_Count})$ microseconds. Each interval contains one Burst. The start time for the Burst, relative to the beginning of the interval, is between 1 and $[(12,000,000 / \text{Burst_Count}) - (\text{Total Burst Length}) + (\text{One Random PRI Interval})]$ microseconds, with the start time being randomly chosen. The step interval for the start time is 1 microsecond. The start time for each Burst is chosen independently.

A representative example of a Long Pulse radar test waveform:

- (1) The total test signal length is 12 seconds.
- (2) 8 Bursts are randomly generated for the Burst_Count.
- (3) Burst 1 has 2 randomly generated pulses.
- (4) The pulse width (for both pulses) is randomly selected to be 75 microseconds.
- (5) The PRI is randomly selected to be at 1213 microseconds.

- (6) Bursts 2 through 8 are generated using steps 3 – 5.
- (7) Each Burst is contained in even intervals of 1,500,000 microseconds. The starting location for Pulse 1, Burst 1 is randomly generated (1 to 1,500,000 minus the total Burst 1 length + 1 random PRI interval) at the 325,001 microsecond step. Bursts 2 through 8 randomly fall in successive 1,500,000 microsecond intervals (i.e. Burst 2 falls in the 1,500,001 – 3,000,000 microsecond range).

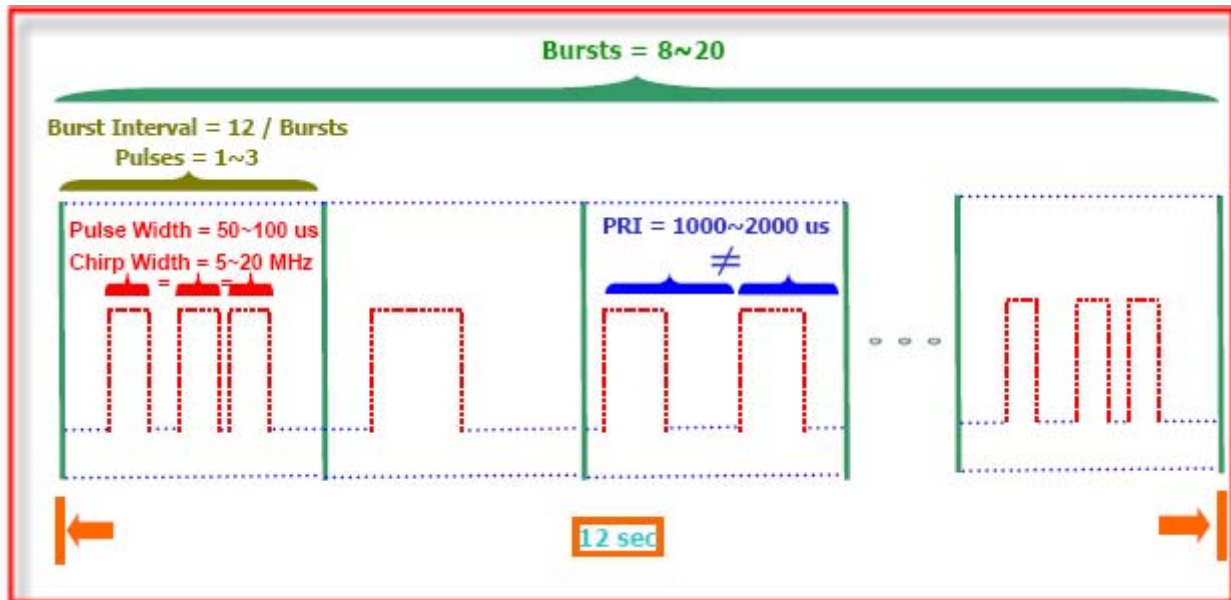

FCC Radar Types (5) System Diagram

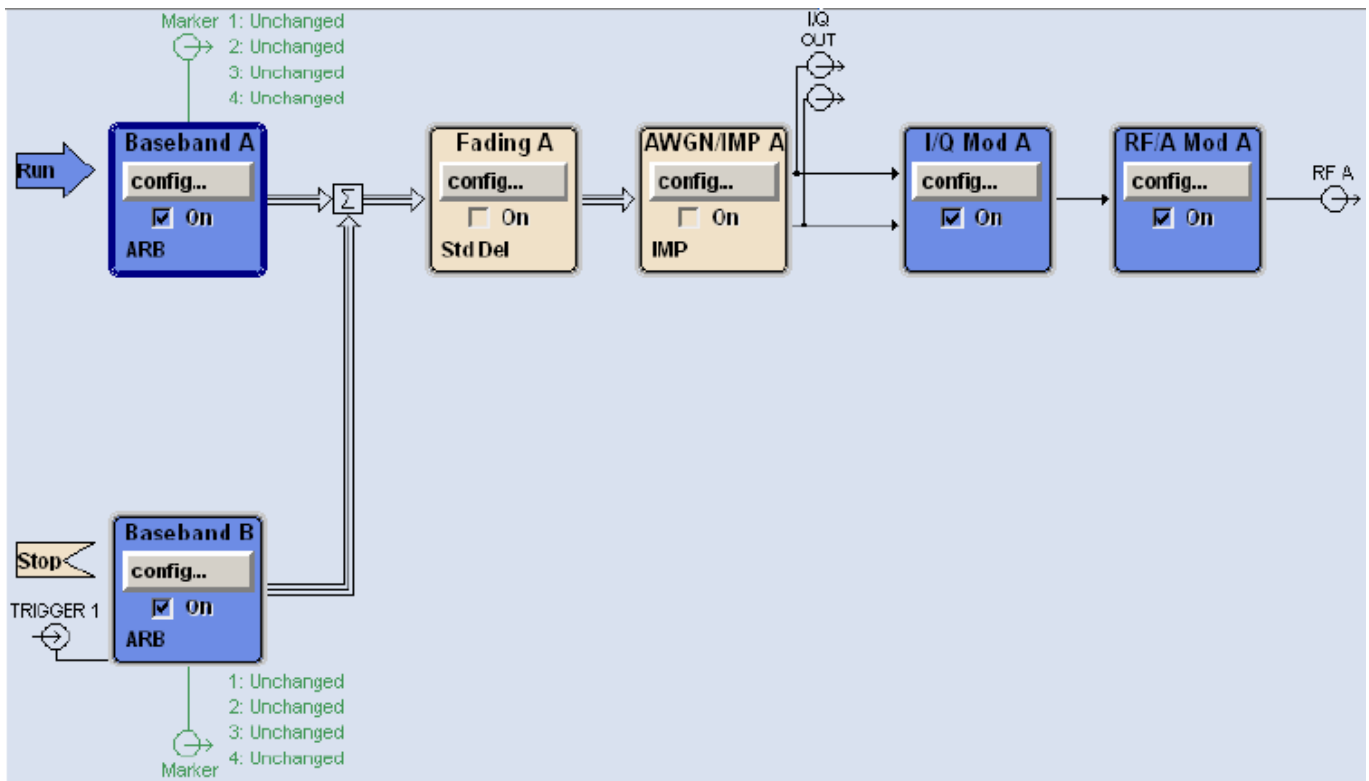

Used R&S SMU200A (Vector SG with two ARB)

Path A / Path B Two B11: Base-band Generator with ARB (16 M samples) and Digital Modulation

B13: Base-band Main Module

B106: frequency range (100 kHz to 6 GHz)

For selecting the waveform parameters from within the bounds of the signal type, system was random selection using uniform distribution.

4.6. Frequency Hopping Radar Test Waveform

Radar Type	Pulse Width (μsec)	PRI (μsec)	Pulses per Hop	Hopping Rate (kHz)	Hopping Sequence Length (msec)	Minimum Percentage of Successful Detection	Minimum Trials
6	1	333	9	0.333	300	70%	30

For the Frequency Hopping Radar Type, the same Burst parameters are used for each waveform. The hopping sequence is different for each waveform and a 100-length segment is selected from the hopping sequence defined by the following algorithm:

The first frequency in a hopping sequence is selected randomly from the group of 475 integer frequencies from 5250 – 5724 MHz. Next, the frequency that was just chosen is removed from the group and a frequency is randomly selected from the remaining 474 frequencies in the group. This process continues until all 475 frequencies are chosen for the set. For selection of a random frequency, the frequencies remaining within the group are always treated as equally likely.

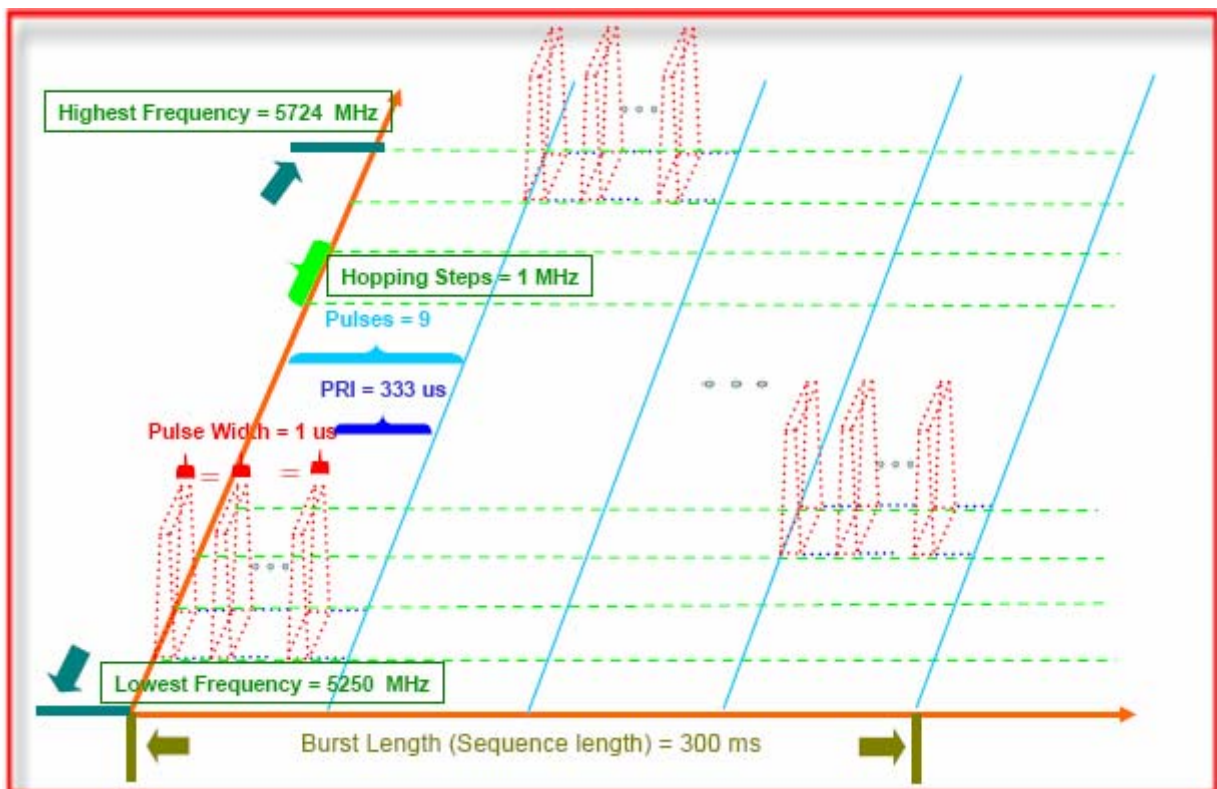

FCC Radar Types (6) System Diagram

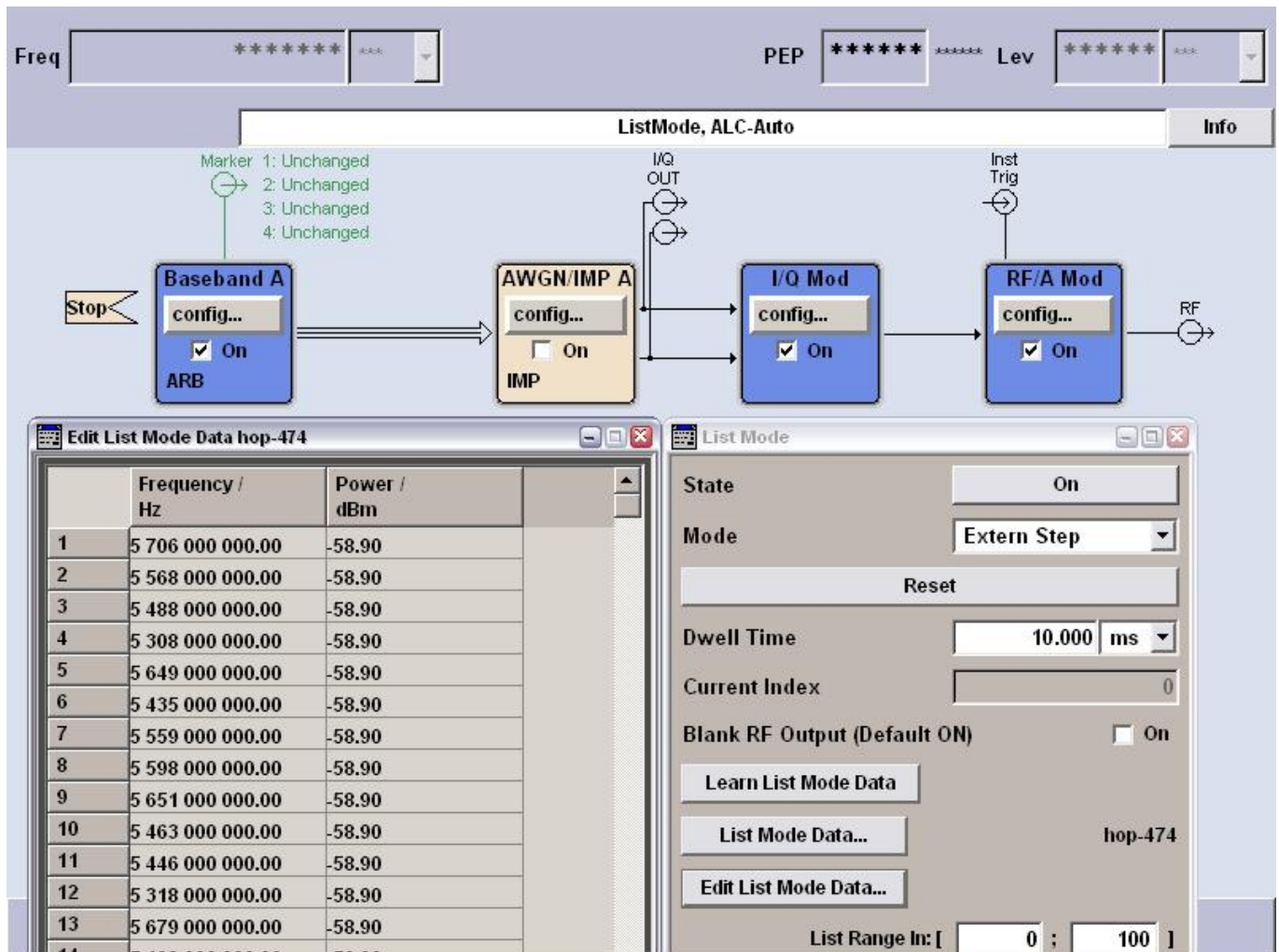

Used R&S SMU200A (Vector SG with one ARB)

B11: Base-band Generator with ARB (16 M samples) and Digital Modulation

B13: Base-band Main Module

B106: frequency range (100 kHz to 6 GHz)

For selecting the waveform parameters from within the bounds of the signal type, system were random selection using uniform distribution.

4.7. Conducted Calibration Setup

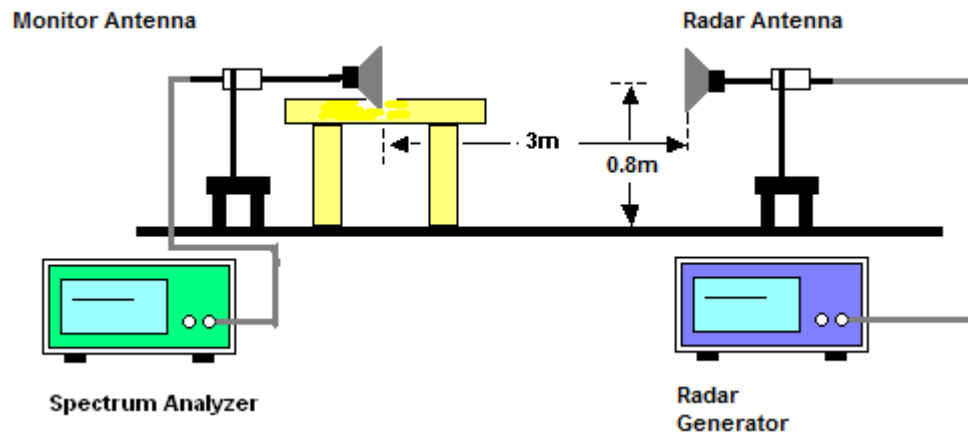

4.8. Radar Waveform Calibration Procedure

The Interference **Radar Detection Threshold Level** is $-64\text{dBm} + 1\text{ dB} = -63\text{ dBm}$ that had been taken into account the output power range and antenna gain. The above equipment setup was used to calibrate the conducted Radar Waveform. A vector signal generator was utilized to establish the test signal level for each radar type. During this process there were replace 50ohm terminal form Master and Client device and no transmissions by either the Master or Client Device. The spectrum analyzer was switched to the zero span (Time Domain) at the frequency of the Radar Waveform generator. Peak detection was used. The spectrum analyzer resolution bandwidth (RBW) and video bandwidth (VBW) were set to at least 3 MHz. The vector signal generator amplitude was set so that the power level measured at the spectrum analyzer was $-64\text{dBm} + 1\text{ dB} = -63\text{ dBm}$. Capture the spectrum analyzer plots on short pulse radar types, long pulse radar type and hopping radar waveform.

4.9. Calibration Deviation

There is no deviation with the original standard.

4.10. Radar Waveform Calibration Result

<For 20MHz>

Radar #1 DFS detection threshold level and the burst of pulses on the Channel frequency

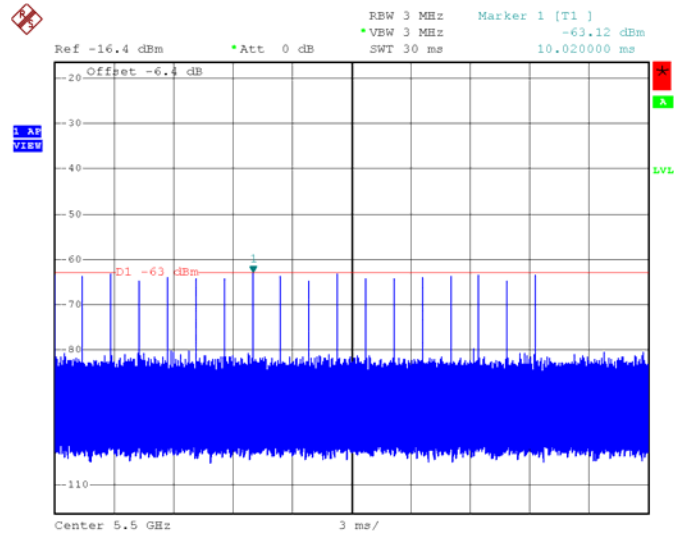

Date: 23.MAR.2009 19:30:48

Radar #2 DFS detection threshold level and the burst of pulses on the Channel frequency

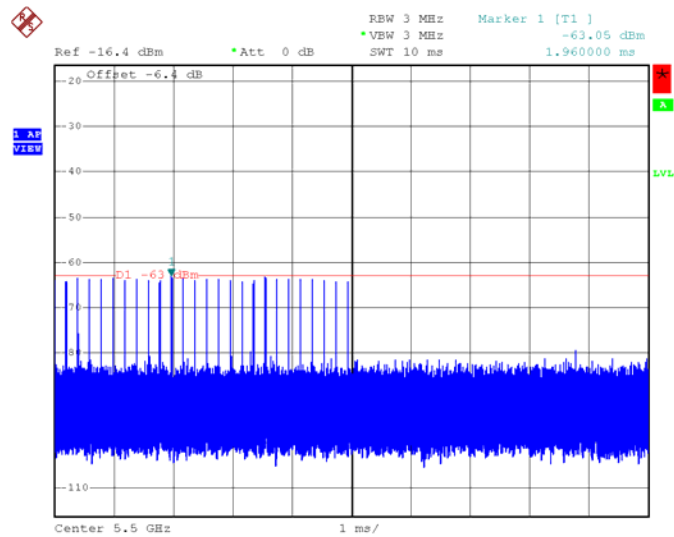

Date: 23.MAR.2009 19:35:11

Radar #3 DFS detection threshold level and the burst of pulses on the Channel frequency

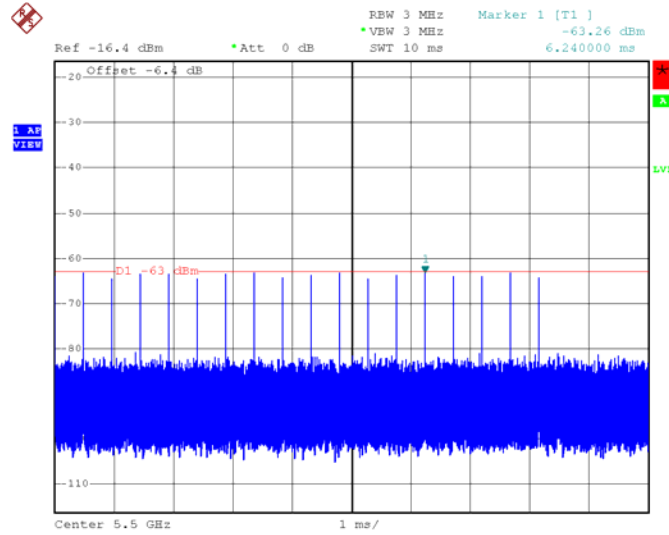

Date: 23.MAR.2009 19:39:30

Radar #4 DFS detection threshold level and the burst of pulses on the Channel frequency

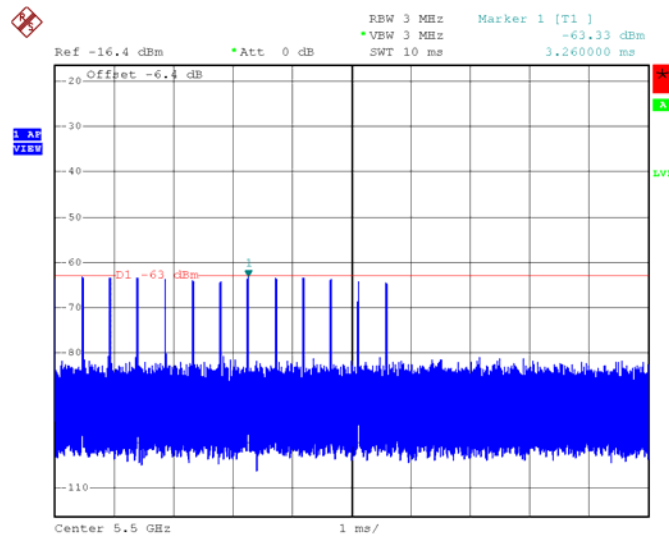

Date: 23.MAR.2009 19:43:02

Radar #5 DFS detection threshold level and 12sec long burst on the Channel frequency

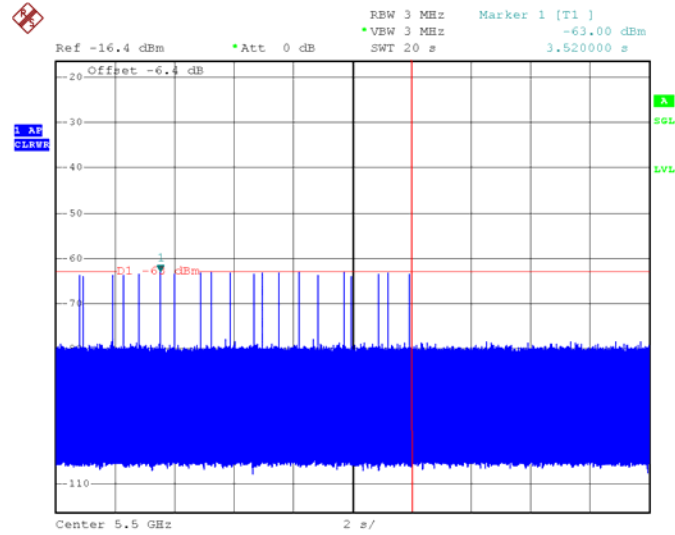

Date: 23.MAR.2009 19:46:25

Radar #6 DFS detection threshold level and a single hop (9 pulses) on the Channel frequency within UNII detection bandwidth.

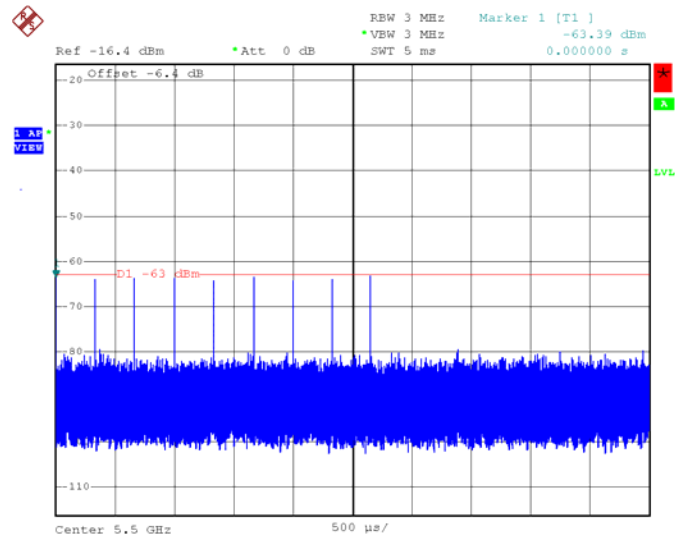

Date: 23.MAR.2009 19:48:11

<For 40MHz>

Radar #1 DFS detection threshold level and the burst of pulses on the Channel frequency

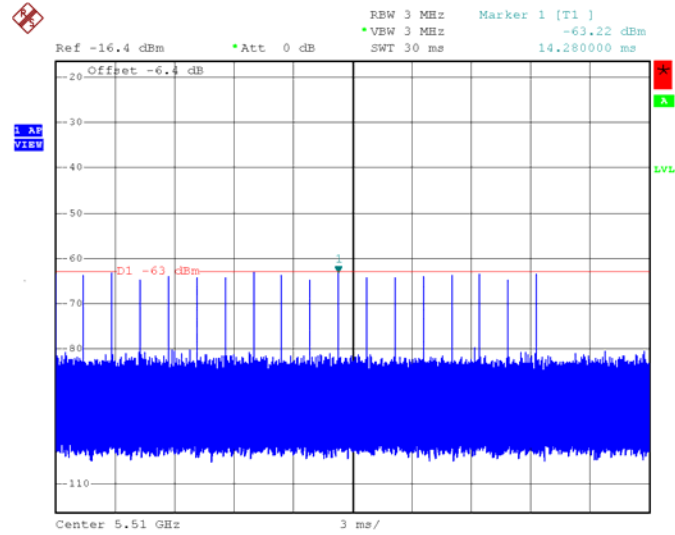

Date: 23.MAR.2009 19:51:47

Radar #2 DFS detection threshold level and the burst of pulses on the Channel frequency

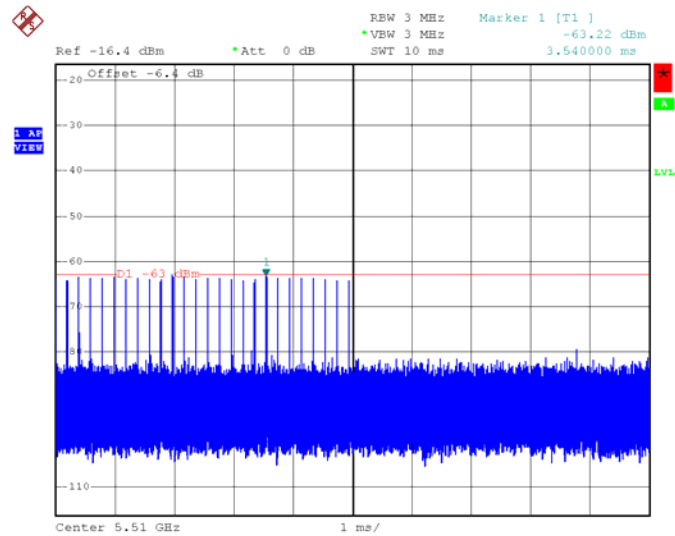

Date: 23.MAR.2009 19:56:10

Radar #3 DFS detection threshold level and the burst of pulses on the Channel frequency

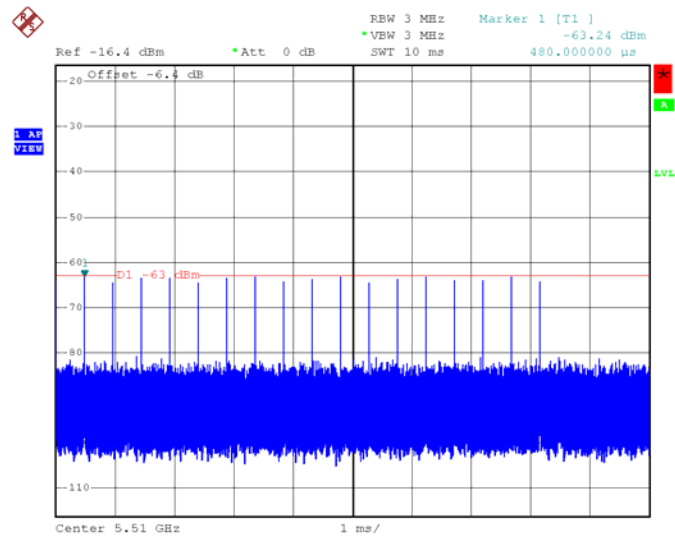

Date: 23.MAR.2009 20:01:49

Radar #4 DFS detection threshold level and the burst of pulses on the Channel frequency

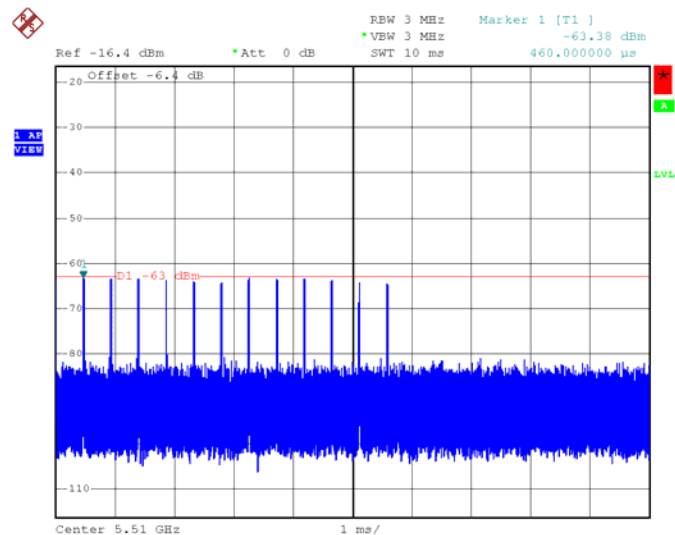

Date: 23.MAR.2009 20:05:04

Radar #5 DFS detection threshold level and 12sec long burst on the Channel frequency

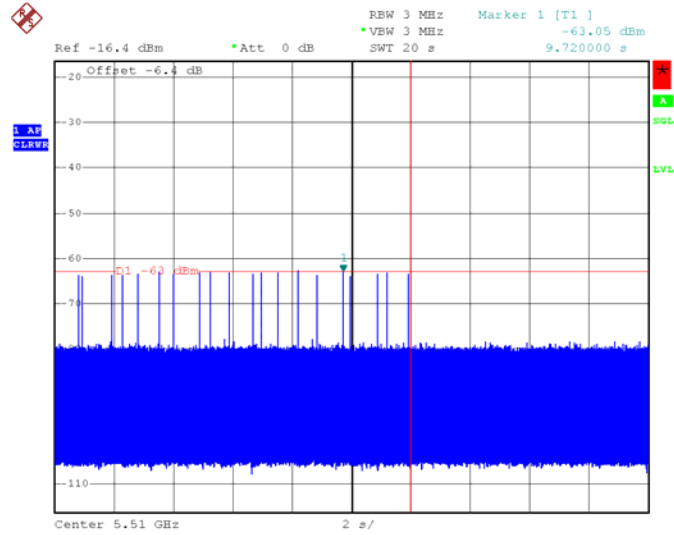

Date: 23.MAR.2009 20:07:49

Radar #6 DFS detection threshold level and a single hop (9 pulses) on the Channel frequency within UNII detection bandwidth.

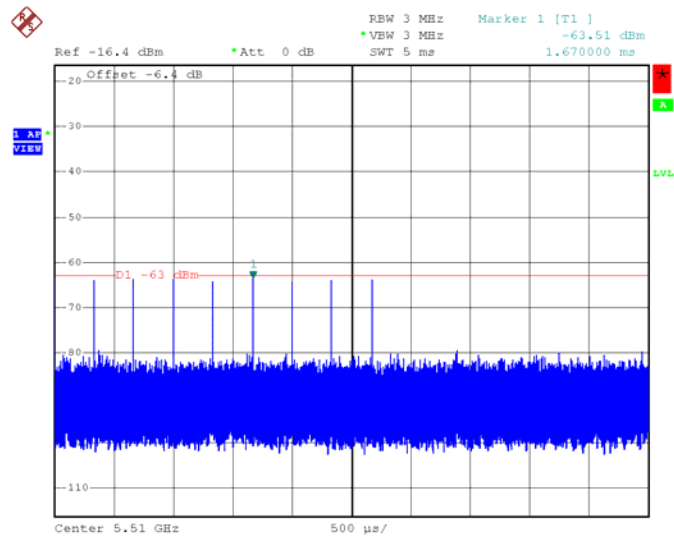

Date: 23.MAR.2009 20:11:58

5. TEST SETUP AND TEST RESULT

5.1. Test setup

5.1.1. Test Setup Diagram

Following is the test setup for generate the radar waveforms and used to monitor UNII device.

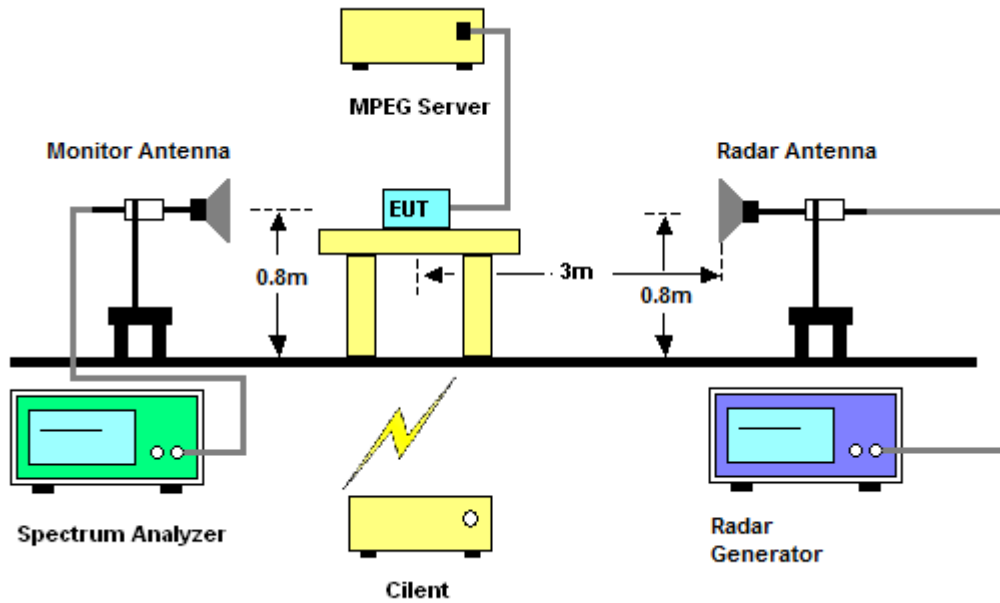

Master Data Traffic Plot (20 MHz)

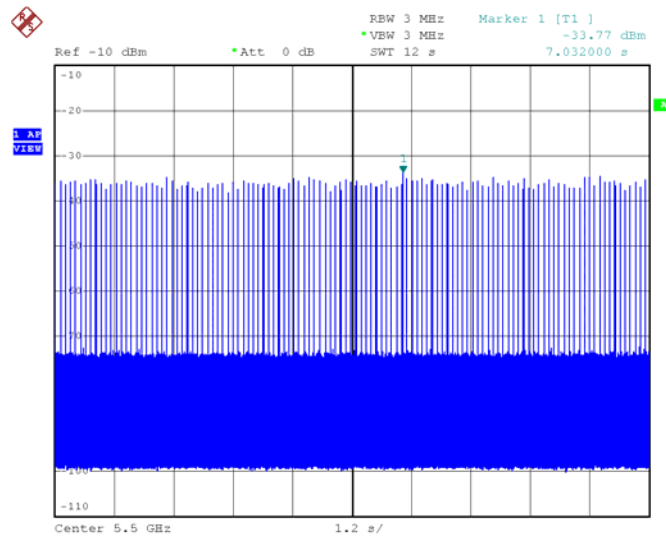

Date: 23.MAR.2009 20:13:27

Master Data Traffic Plot (40 MHz)

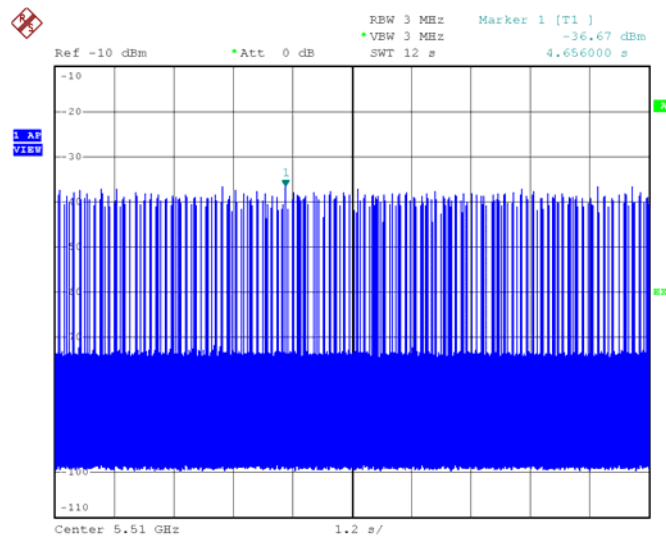

Date: 24.MAR.2009 20:08:08

Slave Data Traffic Plot (20 MHz)

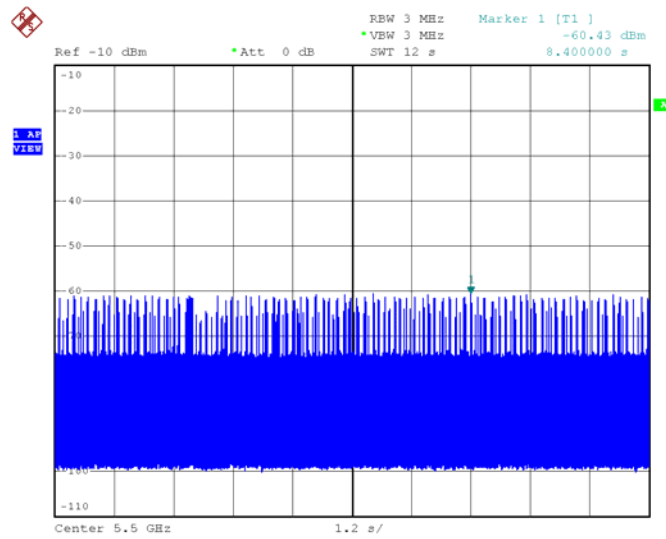

Date: 23.MAR.2009 21:32:23

Slave Data Traffic Plot (40MHz)

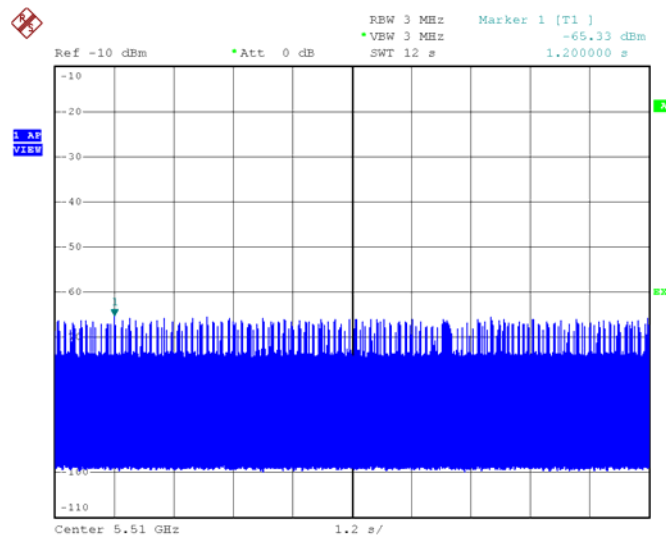

Date: 24.MAR.2009 20:05:46

Without Data Traffic Plot (Noise Plot) (20MHz)

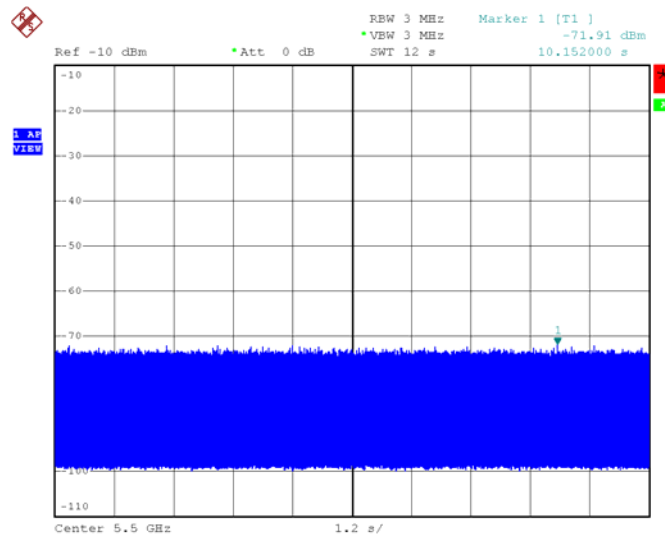

Date: 23.MAR.2009 21:23:13

Without Data Traffic Plot (Noise Plot) (40MHz)

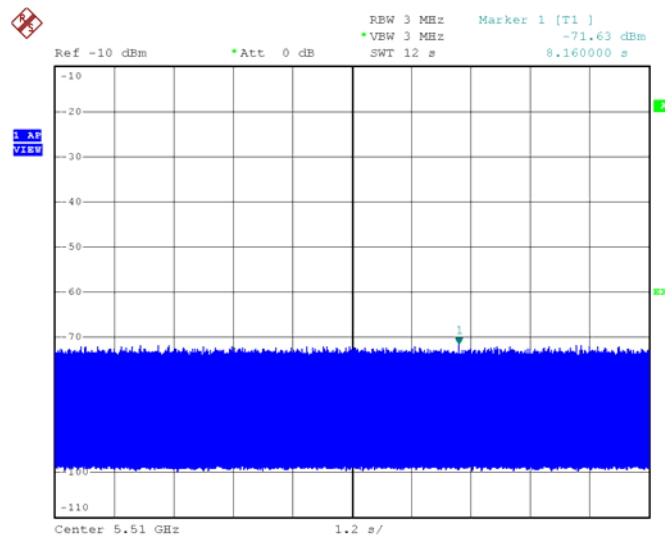

Date: 24.MAR.2009 20:40:07

5.1.2. Test Setup Photo

FRONT VIEW



SIDE VIEW



5.1.3. Supporting Units

Support Units	Brand	Model No.	Serial No.	FCC ID	Software Version
Notebook	DELL	D505	NB-D	E2K24GBRL	Win XP SP2
Notebook	DELL	D505	NB-F	E2K24GBRL	Win XP SP2
abgn Cardbus	Wistron	DNBA-81	-	Pending	STA6.0.3.120

5.1.4. Test Setup Operation

System testing was performed with the designated MPEG test file that streams full motion video from the Access Point to the Client in full motion video mode using the media player with the V2.61 Codec package.. This file is used by IP and Frame based systems for loading the test channel during the In-service compliance testing of the U-NII device.

The waveform parameters from within the bounds of the signal type are selected randomly using uniform distribution.

A spectrum analyzer is used as a monitor to verify that the EUT has vacated the Channel within the (Channel Closing Transmission Time and Channel Move Time, and does not transmit on a Channel during the Non-Occupancy Period after the detection and Channel move. It is also used to monitor EUT transmissions during the Channel Availability Check Time.

5.2. UNII Detection Bandwidth Measurement

5.2.1. Limit

Minimum 80% of the UNII 99% transmission power bandwidth. During the *U-NII Detection Bandwidth* detection test, radar type 1 is used and for each frequency step the minimum percentage of detection is 90 percent. Measurements are performed with no data traffic.

5.2.2. Test Procedures

1. Adjust the equipment to produce a single Burst of the Short Pulse Radar Type 1 at the center frequency of the EUT Operating Channel at the specified DFS Detection Threshold level.
2. The generating equipment is configured as shown in the Conducted Test Setup above section 4.1.1.
3. The EUT is set up as a stand-alone device (no associated Client and no traffic). Frame based systems will be set to a talk/listen ratio of 0%/100% during this test.
4. Generate single radar Burst, and note the response of the EUT. Repeat for a minimum of 10 trials. The EUT must detect the Radar Waveform using the specified U-NII Detection Bandwidth criterion.
5. Starting at the center frequency of the EUT operating Channel, increase the radar frequency in 1 MHz steps, repeating the above item 4 test sequence, until the detection rate falls below the U-NII Detection Bandwidth criterion. Record the highest frequency (denote as FH) at which detection is greater than or equal to the U-NII Detection Bandwidth criterion. Recording the detection rate at frequencies above FH is not required to demonstrate compliance.
6. Starting at the center frequency of the EUT operating Channel, decrease the radar frequency in 1 MHz steps, repeating the above item 4 test sequence, until the detection rate falls below the U-NII Detection Bandwidth criterion. Record the lowest frequency (denote as FL) at which detection is greater than or equal to the U-NII Detection Bandwidth criterion. Recording the detection rate at frequencies below FL is not required to demonstrate compliance.
7. The U-NII Detection Bandwidth is calculated as follows: $U\text{-NII Detection Bandwidth} = FH - FL$
8. The U-NII Detection Bandwidth must be at least 80% of the EUT transmitter 99% power, otherwise, the EUT does not comply with DFS requirements.

5.2.3. Test Deviation

There is no deviation with the original standard.

5.2.4. Test Result for UNII Detection Bandwidth

< Type 1 For 20MHz >

EUT Frequency=5500MHz											
Radar Frequency (MHz)	DFS Detection Trials (1 = Detection, 0 = No Detection)										Detection Rate (%)
	1	2	3	4	5	6	7	8	9	10	
5487	0	0	0	0	0	0	0	0	0	0	0%
5488	1	0	1	0	0	1	1	1	1	1	70%
5489 (FL)	1	1	1	1	1	1	1	1	1	1	100%
5490	1	1	1	1	1	1	1	1	1	1	100%
5491	1	1	1	1	1	1	1	1	1	1	100%
5492	1	1	1	1	1	1	1	1	1	1	100%
5493	1	1	1	1	1	1	1	1	1	1	100%
5494	1	1	1	1	1	1	1	1	1	1	100%
5495	1	1	1	1	1	1	1	1	1	1	100%
5496	1	1	1	1	1	1	1	1	1	1	100%
5497	1	1	1	1	1	1	1	1	1	1	100%
5498	1	1	1	1	1	1	1	1	1	1	100%
5499	1	1	1	1	1	1	1	1	1	1	100%
5500	1	1	1	1	1	1	1	1	1	1	100%
5501	1	1	1	1	1	1	1	1	1	1	100%
5502	1	1	1	1	1	1	1	1	1	1	100%
5503	1	1	1	1	1	1	1	1	1	1	100%
5504	1	1	1	1	1	1	1	1	1	1	100%
5505	1	1	1	1	1	1	1	1	1	1	100%
5506	1	1	1	1	1	1	1	1	1	1	100%
5507	1	1	1	1	1	1	1	1	1	1	100%
5508	1	1	1	1	1	1	1	1	1	1	100%
5509	1	1	1	1	1	1	1	1	1	1	100%
5510	1	1	1	1	1	1	1	1	1	1	100%
5511 (FH)	1	1	1	1	1	1	1	1	1	1	100%
5512	1	0	0	1	0	1	0	1	1	1	60%
5513	0	0	0	0	0	0	0	0	0	0	0%
Detection Bandwidth = FH-FL+1MHz = 5511MHz-5489MHz+1MHz = 23MHz											
EUT 99% Bandwidth = 17.76MHz (see note)											
UNII Detection Bandwidth Min. Limit (MHz): 17.76MHz x 80% = 14.20MHz											

Note: All UNII channels for this device have identical Channel bandwidths. Therefore, all DFS testing was done at 5500 MHz. The 99% channel bandwidth is 17.76MHz. (See the 99% BW section of the RF report for further measurement details).

< Type 2 For 20MHz >

EUT Frequency=5500MHz											
Radar Frequency (MHz)	DFS Detection Trials (1=Detection, 0= No Detection)										Detection Rate (%)
	1	2	3	4	5	6	7	8	9	10	
5487	0	0	0	0	0	0	0	0	0	0	0%
5488	0	0	0	0	0	0	0	0	0	0	0%
5489	0	0	0	0	0	0	0	0	0	0	0%
5490	0	0	1	1	1	0	0	0	0	0	30%
5491 (FL)	1	1	1	1	1	1	1	1	1	1	100%
5492	1	1	1	1	1	1	1	1	1	1	100%
5493	1	1	1	1	1	1	1	1	1	1	100%
5494	1	1	1	1	1	1	1	1	1	1	100%
5495	1	1	1	1	1	1	1	1	1	1	100%
5496	1	1	1	1	1	1	1	1	1	1	100%
5497	1	1	1	1	1	1	1	1	1	1	100%
5498	1	1	1	1	1	1	1	1	1	1	100%
5499	1	1	1	1	1	1	1	1	1	1	100%
5500	1	1	1	1	1	1	1	1	1	1	100%
5501	1	1	1	1	1	1	1	1	1	1	100%
5502	1	1	1	1	1	1	1	1	1	1	100%
5503	1	1	1	1	1	1	1	1	1	1	100%
5504	1	1	1	1	1	1	1	1	1	1	100%
5505	1	1	1	1	1	1	1	1	1	1	100%
5506	1	1	1	1	1	1	1	1	1	1	100%
5507	1	1	1	1	1	1	1	1	1	1	100%
5508	1	1	1	1	1	1	1	1	1	1	100%
5509 (FH)	1	1	1	1	1	1	1	1	1	1	100%
5510	0	1	0	1	0	1	0	1	0	1	50%
5511	0	1	0	0	0	1	0	0	0	0	20%
5512	0	0	0	0	0	0	0	0	0	0	0%
5513	0	0	0	0	0	0	0	0	0	0	0%
Detection Bandwidth = FH-FL+1MHz = 5509MHz-5491MHz+1MHz = 19MHz											
EUT 99% Bandwidth = 17.76MHz (see note)											
UNII Detection Bandwidth Min. Limit (MHz): 17.76MHz x 80% = 14.20MHz											

Note: All UNII channels for this device have identical Channel bandwidths. Therefore, all DFS testing was done at 5500 MHz. The 99% channel bandwidth is 17.76MHz. (See the 99% BW section of the RF report for further measurement details).

< Type 3 For 20MHz >

EUT Frequency=5500MHz											
Radar Frequency (MHz)	DFS Detection Trials (1=Detection, 0= No Detection)										Detection Rate (%)
	1	2	3	4	5	6	7	8	9	10	
5487	0	0	0	0	0	0	0	0	0	0	0%
5488	0	0	0	0	0	0	0	0	0	0	0%
5489	0	0	0	0	0	0	0	0	0	0	0%
5490	0	1	0	0	0	0	1	0	0	0	20%
5491 (FL)	1	1	1	1	1	1	1	1	1	1	100%
5492	1	1	1	1	1	1	1	1	1	1	100%
5493	1	1	1	1	1	1	1	1	1	1	100%
5494	1	1	1	1	1	1	1	1	1	1	100%
5495	1	1	1	1	1	1	1	1	1	1	100%
5496	1	1	1	1	1	1	1	1	1	1	100%
5497	1	1	1	1	1	1	1	1	1	1	100%
5498	1	1	1	1	1	1	1	1	1	1	100%
5499	1	1	1	1	1	1	1	1	1	1	100%
5500	1	1	1	1	1	1	1	1	1	1	100%
5501	1	1	1	1	1	1	1	1	1	1	100%
5502	1	1	1	1	1	1	1	1	1	1	100%
5503	1	1	1	1	1	1	1	1	1	1	100%
5504	1	1	1	1	1	1	1	1	1	1	100%
5505	1	1	1	1	1	1	1	1	1	1	100%
5506	1	1	1	1	1	1	1	1	1	1	100%
5507	1	1	1	1	1	1	1	1	1	1	100%
5508	1	1	1	1	1	1	1	1	1	1	100%
5509 (FH)	1	1	1	1	1	1	1	1	1	1	100%
5510	0	0	0	0	0	0	0	0	0	0	0%
5511	0	0	0	0	0	0	0	0	0	0	0%
5512	0	0	0	0	0	0	0	0	0	0	0%
5513	0	0	0	0	0	0	0	0	0	0	0%
Detection Bandwidth = FH-FL+1MHz = 5509MHz-5491MHz+1MHz = 19MHz											
EUT 99% Bandwidth = 17.76MHz (see note)											
UNII Detection Bandwidth Min. Limit (MHz): 17.76MHz x 80% = 14.20MHz											

Note: All UNII channels for this device have identical Channel bandwidths. Therefore, all DFS testing was done at 5500 MHz. The 99% channel bandwidth is 17.76MHz. (See the 99% BW section of the RF report for further measurement details).

< Type 4 For 20MHz >

EUT Frequency=5500MHz											
Radar Frequency (MHz)	DFS Detection Trials (1=Detection, 0= No Detection)										Detection Rate (%)
	1	2	3	4	5	6	7	8	9	10	
5487	0	0	0	0	0	0	0	0	0	0	0%
5488	0	0	0	0	0	0	0	0	0	0	0%
5489	0	0	0	0	0	0	0	0	0	0	0%
5490	0	0	0	0	0	0	0	0	0	0	0%
5491 (FL)	1	1	1	1	1	1	1	1	1	1	100%
5492	1	1	1	1	1	1	1	1	1	1	100%
5493	1	1	1	1	1	1	1	1	1	1	100%
5494	1	1	1	1	1	1	1	1	1	1	100%
5495	1	1	1	1	1	1	1	1	1	1	100%
5496	1	1	1	1	1	1	1	1	1	1	100%
5497	1	1	1	1	1	1	1	1	1	1	100%
5498	1	1	1	1	1	1	0	1	1	1	90%
5499	1	1	1	1	1	1	1	1	1	1	100%
5500	1	1	1	1	1	1	1	1	1	1	100%
5501	1	1	1	1	1	1	1	1	1	1	100%
5502	1	1	1	1	1	1	1	1	1	1	100%
5503	1	1	1	1	1	1	1	1	1	1	100%
5504	1	1	1	1	1	1	1	1	1	1	100%
5505	1	1	1	1	1	1	1	1	1	1	100%
5506	1	1	1	1	1	1	1	1	1	1	100%
5507	1	1	1	1	1	1	1	1	1	1	100%
5508	1	1	1	1	1	1	1	1	1	1	100%
5509 (FH)	1	1	1	1	1	1	1	0	1	1	90%
5510	0	0	0	0	0	0	0	0	0	0	0%
5511	0	0	0	0	0	0	0	0	0	0	0%
5512	0	0	0	0	0	0	0	0	0	0	0%
5513	0	0	0	0	0	0	0	0	0	0	0%
Detection Bandwidth = FH-FL+1MHz = 5509MHz-5491MHz+1MHz = 19MHz											
EUT 99% Bandwidth = 17.76MHz (see note)											
UNII Detection Bandwidth Min. Limit (MHz): 17.76MHz x 80% = 14.20MHz											

Note: All UNII channels for this device have identical Channel bandwidths. Therefore, all DFS testing was done at 5500 MHz. The 99% channel bandwidth is 17.76MHz. (See the 99% BW section of the RF report for further measurement details).

< Type 5 For 20MHz >

EUT Frequency=5500MHz											
Radar Frequency (MHz)	DFS Detection Trials (1=Detection, 0= No Detection)										Detection Rate (%)
	1	2	3	4	5	6	7	8	9	10	
5487	0	0	0	0	0	0	0	0	0	0	0%
5488	0	0	0	0	0	0	0	0	0	0	0%
5489	0	0	0	0	0	0	0	0	0	0	0%
5490	0	0	0	0	0	0	0	0	0	0	0%
5491	1	0	0	0	0	1	0	0	1	0	30%
5492 (FL)	1	1	0	1	1	1	1	1	1	1	90%
5493	1	1	1	1	1	1	1	1	1	1	100%
5494	1	1	1	1	1	1	1	1	1	1	100%
5495	1	1	1	1	1	1	1	1	1	1	100%
5496	1	1	1	1	1	1	1	1	1	1	100%
5497	1	1	1	1	1	1	1	1	1	1	100%
5498	1	1	1	1	1	1	1	1	1	1	100%
5499	1	1	1	1	1	1	1	1	1	1	100%
5500	1	1	1	1	1	1	1	1	1	1	100%
5501	1	1	1	1	1	1	1	1	1	1	100%
5502	1	1	1	1	1	1	1	1	1	1	100%
5503	1	1	1	1	1	1	1	1	1	1	100%
5504	1	1	1	1	1	1	1	1	1	1	100%
5505	1	1	1	1	1	1	1	1	1	1	100%
5506	1	1	1	1	1	1	1	1	1	1	100%
5507	1	1	1	1	1	1	1	1	1	1	100%
5508	1	1	1	1	1	1	1	1	1	1	100%
5509	1	1	1	1	1	1	1	1	1	1	100%
5510	1	1	1	1	1	1	1	1	1	1	100%
5511 (FH)	1	1	1	1	1	1	1	1	1	1	100%
5512	0	0	0	0	0	0	0	0	0	0	0%
5513	0	0	0	0	0	0	0	0	0	0	0%
Detection Bandwidth = FH-FL+1MHz = 5511MHz-5492MHz+1MHz = 20MHz											
EUT 99% Bandwidth = 17.76MHz (see note)											
UNII Detection Bandwidth Min. Limit (MHz): 17.76MHz x 80% = 14.20MHz											

Note: All UNII channels for this device have identical Channel bandwidths. Therefore, all DFS testing was done at 5500 MHz. The 99% channel bandwidth is 17.76MHz. (See the 99% BW section of the RF report for further measurement details).

< Type 6 For 20MHz >

EUT Frequency=5500MHz											
Radar Frequency (MHz)	DFS Detection Trials (1=Detection, 0= No Detection)										Detection Rate (%)
	1	2	3	4	5	6	7	8	9	10	
5487	0	0	0	0	0	0	0	0	0	0	0
5488	0	0	0	0	0	0	0	0	0	0	0
5489	1	1	0	1	0	0	1	1	1	1	70
5490 (FL)	1	1	1	1	1	1	1	1	1	1	100
5491	1	1	1	1	1	1	1	1	1	1	100
5492	1	1	1	1	1	1	1	1	1	1	100
5493	1	1	1	1	1	1	1	1	1	1	100
5494	1	1	1	1	1	1	1	1	1	1	100
5495	1	1	1	1	1	1	1	1	1	1	100
5496	1	1	1	1	1	1	1	1	1	1	100
5497	1	1	1	1	1	1	1	1	1	1	100
5498	1	1	1	1	1	1	1	1	1	1	100
5499	1	1	1	1	1	1	1	0	1	1	90
5500	1	0	1	1	1	1	1	1	1	1	90
5501	1	1	1	1	1	1	1	1	1	1	100
5502	1	1	1	1	1	1	1	1	1	1	100
5503	1	1	1	1	1	1	1	1	1	1	100
5504	1	1	1	1	1	1	1	1	1	1	100
5505	1	1	1	1	1	1	1	1	1	1	100
5506	1	1	1	1	1	1	1	1	1	1	100
5507	1	1	1	1	1	1	1	1	1	1	100
5508	1	1	1	1	1	1	1	1	1	1	100
5509	1	1	1	1	1	1	1	1	1	1	100
5510	1	1	1	1	1	1	1	1	1	1	100
5511 (FH)	1	1	0	1	1	1	1	1	1	1	90
5512	0	0	0	0	0	0	0	0	0	0	0
5513	0	0	0	0	0	0	0	0	0	0	0
Detection Bandwidth = FH-FL+1MHz = 5511MHz-5490MHz+1MHz = 22MHz											
EUT 99% Bandwidth = 17.76MHz (see note)											
UNII Detection Bandwidth Min. Limit (MHz): 17.76MHz x 80% = 14.20MHz											

Note: All UNII channels for this device have identical Channel bandwidths. Therefore, all DFS testing was done at 5500 MHz. The 99% channel bandwidth is 17.76MHz. (See the 99% BW section of the RF report for further measurement details).

<Type 1 For 40MHz>

EUT Frequency=5510MHz											
Radar Frequency (MHz)	DFS Detection Trials (1 =Detection, 0= No Detection)										Detection Rate (%)
	1	2	3	4	5	6	7	8	9	10	
5487	0	0	0	0	0	0	0	0	0	0	0%
5488 (FL)	1	1	1	1	1	1	1	1	1	1	100%
5489	1	1	1	1	1	1	1	1	1	1	100%
5490	1	1	1	1	1	1	1	1	1	1	100%
5491	1	1	1	1	1	1	1	1	1	1	100%
5492	1	1	1	1	1	1	1	1	1	1	100%
5493	1	1	1	1	1	1	1	1	1	1	100%
5494	1	1	1	1	1	1	1	1	1	1	100%
5495	1	1	1	1	1	1	1	1	1	1	100%
5496	1	1	1	1	1	1	1	1	1	1	100%
5497	1	1	1	1	1	1	1	1	1	1	100%
5498	1	1	1	1	1	1	1	1	1	1	100%
5499	1	1	1	1	1	1	1	1	1	1	100%
5500	1	1	1	1	1	1	1	1	1	1	100%
5501	1	1	1	1	1	1	1	1	1	1	100%
5502	1	1	1	1	1	1	1	1	1	1	100%
5503	1	1	1	1	1	1	1	1	1	1	100%
5504	1	1	1	1	1	1	1	1	1	1	100%
5505	1	1	1	1	1	1	1	1	1	1	100%
5506	1	1	1	1	1	1	1	1	1	1	100%
5507	1	1	1	1	1	1	1	1	1	1	100%
5508	1	1	1	1	1	1	1	1	1	1	100%
5509	1	1	1	1	1	1	1	1	1	1	100%
5510	1	1	1	1	1	1	1	1	1	1	100%
5511	1	1	1	1	1	1	1	1	1	1	100%
5512	1	1	1	1	1	1	1	1	1	1	100%
5513	1	1	1	1	1	1	1	1	1	1	100%
5514	1	1	1	1	1	1	1	1	1	1	100%
5515	1	1	1	1	1	1	1	1	1	1	100%
5516	1	1	1	1	1	1	1	1	1	1	100%
5517	1	1	1	1	1	1	1	1	1	1	100%
5518	1	1	1	1	1	1	1	1	1	1	100%
5519	1	1	1	1	1	1	1	1	1	1	100%
5520	1	1	1	1	1	1	1	1	1	1	100%

5521	1	1	1	1	1	1	1	1	1	1	100%
5522	1	1	1	1	1	1	1	1	1	1	100%
5523	1	1	1	1	1	1	1	1	1	1	100%
5524	1	1	1	1	1	1	1	1	1	1	100%
5525	1	1	1	1	1	1	1	1	1	1	100%
5526	1	1	1	1	1	1	1	1	1	1	100%
5527	1	1	1	1	1	1	1	1	1	1	100%
5528	1	1	1	1	1	1	1	1	1	1	100%
5529	1	1	1	1	1	1	1	1	1	1	100%
5530	1	1	1	1	1	1	1	1	1	1	100%
5531	1	1	1	1	1	1	1	1	1	1	100%
5532 (FH)	1	1	1	1	1	1	1	1	1	1	100%
5533	0	0	0	0	0	0	0	0	0	0	0%
Detection Bandwidth = FH-FL + 1MHz = 5532MHz-5488MHz + 1MHz = 45MHz											
EUT 99% Bandwidth = 36.16MHz (see note)											
UNII Detection Bandwidth Min. Limit (MHz): 36.16MHz x 80% = 28.93MHz											

Note: All UNII channels for this device have identical Channel bandwidths. Therefore, all DFS testing was done at 5510 MHz. The 99% channel bandwidth is 36.16MHz. (See the 99% BW section of the RF report for further measurement details).

<Type 2 For 40MHz>

EUT Frequency=5510MHz											
Radar Frequency (MHz)	DFS Detection Trials (1 =Detection, 0= No Detection)										Detection Rate (%)
	1	2	3	4	5	6	7	8	9	10	
5487	0	0	0	0	0	0	0	0	0	0	0%
5488	0	0	0	0	0	0	0	0	0	0	0%
5489	0	0	0	0	0	0	0	0	0	0	0%
5490	1	0	0	0	0	0	0	0	1	0	20%
5491 (FL)	1	1	1	1	1	1	1	1	1	1	100%
5492	1	1	1	1	1	1	1	1	1	1	100%
5493	1	1	1	1	1	1	1	1	1	1	100%
5494	1	1	1	1	1	1	1	1	1	1	100%
5495	1	1	1	1	1	1	1	1	1	1	100%
5496	1	1	1	1	1	1	1	1	1	1	100%
5497	1	1	1	1	1	1	1	1	1	1	100%
5498	1	1	1	1	1	1	1	1	1	1	100%
5499	1	1	1	1	1	1	1	1	1	1	100%
5500	1	1	1	1	1	1	1	1	1	1	100%
5501	1	1	1	1	1	1	1	1	1	1	100%
5502	1	1	1	1	1	1	1	1	1	1	100%
5503	1	1	1	1	1	1	1	1	1	1	100%
5504	1	1	1	1	1	1	1	1	1	1	100%
5505	1	1	1	1	1	1	1	1	1	1	100%
5506	1	1	1	1	1	1	1	1	1	1	100%
5507	1	1	1	1	1	1	1	1	1	1	100%
5508	1	1	1	1	1	1	1	1	1	1	100%
5509	1	1	1	1	1	1	1	1	1	1	100%
5510	1	1	1	1	1	1	1	1	1	1	100%
5511	1	1	1	1	1	1	1	1	1	1	100%
5512	1	1	1	1	1	1	1	1	1	1	100%
5513	1	1	1	1	1	1	1	1	1	1	100%
5514	1	1	1	1	1	1	1	1	1	1	100%
5515	1	1	1	1	1	1	1	1	1	1	100%
5516	1	1	1	1	1	1	1	1	1	1	100%
5517	1	1	1	1	1	1	1	1	1	1	100%
5518	1	1	1	1	1	1	1	1	1	1	100%
5519	1	1	1	1	1	1	1	1	1	1	100%
5520	1	1	1	1	1	1	1	1	1	1	100%

5521	1	1	1	1	1	1	1	1	1	1	100%
5522	1	1	1	1	1	1	1	1	1	1	100%
5523	1	1	1	1	1	1	1	1	1	1	100%
5524	1	1	1	1	1	1	1	1	1	1	100%
5525	1	1	1	1	1	1	1	1	1	1	100%
5526	1	1	1	1	1	1	1	1	1	1	100%
5527	1	1	1	1	1	1	1	1	1	1	100%
5528	1	1	1	1	1	1	1	1	1	1	100%
5529 (FH)	1	1	1	0	1	1	1	1	1	1	90%
5530	1	0	0	0	0	0	0	0	0	1	20%
5531	0	0	0	0	0	0	0	0	0	0	0%
5532	0	0	0	0	0	0	0	0	0	0	0%
5533	0	0	0	0	0	0	0	0	0	0	0%
Detection Bandwidth = FH-FL + 1MHz = 5529MHz-5491MHz + 1MHz = 39MHz											
EUT 99% Bandwidth = 36.16MHz (see note)											
UNII Detection Bandwidth Min. Limit (MHz): 36.16MHz x 80% = 28.93MHz											

Note: All UNII channels for this device have identical Channel bandwidths. Therefore, all DFS testing was done at 5510 MHz. The 99% channel bandwidth is 36.16MHz. (See the 99% BW section of the RF report for further measurement details).

<Type 3 For 40MHz>

EUT Frequency=5510MHz											
Radar Frequency (MHz)	DFS Detection Trials (1 =Detection, 0= No Detection)										Detection Rate (%)
	1	2	3	4	5	6	7	8	9	10	
5487	0	0	0	0	0	0	0	0	0	0	0%
5488	0	0	0	0	0	0	0	0	0	0	0%
5489	0	0	0	0	0	0	0	0	0	0	0%
5490	0	0	0	0	0	0	0	0	0	0	0%
5491 (FL)	1	1	1	1	1	1	1	1	1	1	100%
5492	1	1	1	1	1	1	1	1	1	1	100%
5493	1	1	1	1	1	1	1	1	1	1	100%
5494	1	1	1	1	1	1	1	1	1	1	100%
5495	1	1	1	1	1	1	1	1	1	1	100%
5496	1	1	1	1	1	1	1	1	1	1	100%
5497	1	1	1	1	1	1	1	1	1	1	100%
5498	1	1	1	1	1	1	1	1	1	1	100%
5499	1	1	1	1	1	1	1	1	1	1	100%
5500	1	1	1	1	1	1	1	1	1	1	100%
5501	1	1	1	1	1	1	1	1	1	1	100%
5502	1	1	1	1	1	1	1	1	1	1	100%
5503	1	1	1	1	1	1	1	1	1	1	100%
5504	1	1	1	1	1	1	1	1	1	1	100%
5505	1	1	1	1	1	1	1	1	1	1	100%
5506	1	1	1	1	1	1	1	1	1	1	100%
5507	1	1	1	1	1	1	1	1	1	1	100%
5508	1	1	1	1	1	1	1	1	1	1	100%
5509	1	1	1	1	1	1	1	1	1	1	100%
5510	1	1	1	1	1	1	1	1	1	1	100%
5511	1	1	1	1	1	1	1	1	1	1	100%
5512	1	1	1	1	1	1	1	1	1	1	100%
5513	1	1	1	1	1	1	1	1	1	1	100%
5514	1	1	1	1	1	1	1	1	1	1	100%
5515	1	1	1	1	1	1	1	1	1	1	100%
5516	1	1	1	1	1	1	1	1	1	1	100%
5517	1	1	1	1	1	1	1	1	1	1	100%
5518	1	1	1	1	1	1	1	1	1	1	100%
5519	1	1	1	1	1	1	1	1	1	1	100%
5520	1	1	1	1	1	1	1	1	1	1	100%

5521	1	1	1	1	1	1	1	1	1	1	100%
5522	1	1	1	1	1	1	1	1	1	1	100%
5523	1	1	1	1	1	1	1	1	1	1	100%
5524	1	1	1	1	1	1	1	1	1	1	100%
5525	1	1	1	1	1	1	1	1	1	1	100%
5526	1	1	1	1	1	1	1	1	1	1	100%
5527	1	1	1	1	1	1	1	1	1	1	100%
5528	1	1	1	1	1	1	1	1	1	1	100%
5529	1	1	1	1	1	1	1	1	1	1	100%
5530 (FH)	1	1	1	1	1	1	1	1	1	1	100%
5531	0	0	0	0	0	0	0	0	0	0	0%
5532	0	0	0	0	0	0	0	0	0	0	0%
5533	0	0	0	0	0	0	0	0	0	0	0%
Detection Bandwidth = FH-FL+1MHz = 5530MHz-5491MHz+1MHz = 39MHz											
EUT 99% Bandwidth = 36.16MHz (see note)											
UNII Detection Bandwidth Min. Limit (MHz): 36.16MHz x 80% = 28.93MHz											

Note: All UNII channels for this device have identical Channel bandwidths. Therefore, all DFS testing was done at 5510 MHz. The 99% channel bandwidth is 36.16MHz. (See the 99% BW section of the RF report for further measurement details).

<Type 4 For 40MHz>

EUT Frequency=5510MHz											
Radar Frequency (MHz)	DFS Detection Trials (1=Detection, 0= No Detection)										Detection Rate (%)
	1	2	3	4	5	6	7	8	9	10	
5487	0	0	0	0	0	0	0	0	0	0	0%
5488	0	0	0	0	0	0	0	0	0	0	0%
5489	0	0	0	0	0	0	0	0	0	0	0%
5490	0	0	0	0	0	0	0	0	0	0	0%
5491 (FL)	1	1	1	1	1	1	1	1	1	1	100%
5492	1	1	1	1	1	1	1	1	1	1	100%
5493	1	1	1	1	1	1	1	1	1	1	100%
5494	1	1	1	1	1	1	1	1	1	1	100%
5495	1	1	1	1	1	1	1	1	1	1	100%
5496	1	1	1	1	1	1	1	1	1	1	100%
5497	1	1	1	1	1	1	1	1	1	1	100%
5498	1	1	1	1	1	1	1	1	1	1	100%
5499	1	1	1	1	1	1	1	1	1	1	100%
5500	1	1	1	1	1	1	1	1	1	1	100%
5501	1	1	1	1	1	1	1	1	1	1	100%
5502	1	1	1	1	1	1	1	1	1	1	100%
5503	1	1	1	1	1	1	1	1	1	1	100%
5504	1	1	1	1	1	1	1	1	1	1	100%
5505	1	1	1	1	1	1	1	1	1	1	100%
5506	1	1	1	1	1	1	1	1	1	1	100%
5507	1	1	1	1	1	1	1	1	1	1	100%
5508	1	1	1	1	1	1	1	1	1	1	100%
5509	1	1	1	1	1	1	1	1	1	1	100%
5510	1	1	1	1	1	1	1	1	1	1	100%
5511	1	1	1	1	1	1	1	1	1	1	100%
5512	1	1	1	1	1	1	1	1	1	1	100%
5513	1	1	1	1	1	1	1	1	1	1	100%
5514	1	1	1	1	1	1	1	1	1	1	100%
5515	1	1	1	1	1	1	1	1	1	1	100%
5516	1	1	1	1	1	1	1	1	1	1	100%
5517	1	1	1	1	1	1	1	1	1	1	100%
5518	1	1	1	1	1	1	1	1	1	1	100%
5519	1	1	1	1	1	1	1	1	1	1	100%
5520	1	1	1	1	1	1	1	1	1	1	100%

5521	1	1	1	1	1	1	1	1	1	1	100%
5522	1	1	1	1	1	1	1	1	1	1	100%
5523	1	1	1	1	1	1	1	1	1	1	100%
5524	1	1	1	1	1	1	1	1	1	1	100%
5525	1	1	1	1	1	1	1	1	1	1	100%
5526	1	1	1	1	1	1	1	1	1	1	100%
5527	1	1	1	1	1	1	1	1	1	1	100%
5528	1	1	1	1	1	1	1	1	1	1	100%
5529 (FH)	1	1	1	1	1	1	1	1	1	1	100%
5530	0	0	0	0	0	0	0	0	0	0	0%
5531	0	0	0	0	0	0	0	0	0	0	0%
5532	0	0	0	0	0	0	0	0	0	0	0%
5533	0	0	0	0	0	0	0	0	0	0	0%
Detection Bandwidth = FH-FL + 1MHz = 5529MHz-5491MHz + 1MHz = 39MHz											
EUT 99% Bandwidth = 36.16MHz (see note)											
UNII Detection Bandwidth Min. Limit (MHz): 36.16MHz x 80% = 28.93MHz											

Note: All UNII channels for this device have identical Channel bandwidths. Therefore, all DFS testing was done at 5510 MHz. The 99% channel bandwidth is 36.16MHz. (See the 99% BW section of the RF report for further measurement details).

<Type 5 For 40MHz>

EUT Frequency=5510MHz											
Radar Frequency (MHz)	DFS Detection Trials (1=Detection, 0= No Detection)										Detection Rate (%)
	1	2	3	4	5	6	7	8	9	10	
5487	0	0	0	0	0	0	0	0	0	0	0%
5488	0	0	0	0	0	0	0	0	0	0	0%
5489	0	0	0	0	0	0	0	0	0	0	0%
5490 (FL)	1	1	1	1	1	1	1	1	1	1	100%
5491	1	1	1	1	1	1	1	1	1	1	100%
5492	1	1	1	1	1	1	1	1	1	1	100%
5493	1	1	1	1	1	1	1	1	1	1	100%
5494	1	1	1	1	1	1	1	1	1	1	100%
5495	1	1	1	1	1	1	1	1	1	1	100%
5496	1	1	1	1	1	1	1	1	1	1	100%
5497	1	1	1	1	1	1	1	1	1	1	100%
5498	1	1	1	1	1	1	1	1	1	1	100%
5499	1	1	1	1	1	1	1	1	1	1	100%
5500	1	1	1	1	1	1	1	1	1	1	100%
5501	1	1	1	1	1	1	1	1	1	1	100%
5502	1	1	1	1	1	1	1	1	1	1	100%
5503	1	1	1	1	1	1	1	1	1	1	100%
5504	1	1	1	1	1	1	1	1	1	1	100%
5505	1	1	1	1	1	1	1	1	1	1	100%
5506	1	1	1	1	1	1	1	1	1	1	100%
5507	1	1	1	1	1	1	1	1	1	1	100%
5508	1	1	1	1	1	1	1	1	1	1	100%
5509	1	1	1	1	1	1	1	1	1	1	100%
5510	1	1	1	1	1	1	1	1	1	1	100%
5511	1	1	1	1	1	1	1	1	1	1	100%
5512	1	1	1	1	1	1	1	1	1	1	100%
5513	1	1	1	1	1	1	1	1	1	1	100%
5514	1	1	1	1	1	1	1	1	1	1	100%
5515	1	1	1	1	1	1	1	1	1	1	100%
5516	1	1	1	1	1	1	1	1	1	1	100%
5517	1	1	1	1	1	1	1	1	1	1	100%
5518	1	1	1	1	1	1	1	1	1	1	100%
5519	1	1	1	1	1	1	1	1	1	1	100%
5520	1	1	1	1	1	1	1	1	1	1	100%

5521	1	1	1	1	1	1	1	1	1	1	100%
5522	1	1	1	1	1	1	1	1	1	1	100%
5523	1	1	1	1	1	1	1	1	1	1	100%
5524	1	1	1	1	1	1	1	1	1	1	100%
5525	1	1	1	1	1	1	1	1	1	1	100%
5526	1	1	1	1	1	1	1	1	1	1	100%
5527	1	1	1	1	1	1	1	1	1	1	100%
5528	1	1	1	1	1	1	1	1	1	1	100%
5529	1	1	1	1	1	1	1	1	1	1	100%
5530 (FH)	1	1	1	0	1	1	1	1	1	1	90%
5531	1	0	0	0	0	0	0	0	0	0	10%
5532	0	0	0	0	0	0	0	0	0	0	0%
5533	0	0	0	0	0	0	0	0	0	0	0%
Detection Bandwidth = FH-FL + 1MHz = 5530MHz-5490MHz + 1MHz = 41MHz											
EUT 99% Bandwidth = 36.16MHz (see note)											
UNII Detection Bandwidth Min. Limit (MHz): 36.16MHz x 80% = 28.93MHz											

Note: All UNII channels for this device have identical Channel bandwidths. Therefore, all DFS testing was done at 5510 MHz. The 99% channel bandwidth is 36.16MHz. (See the 99% BW section of the RF report for further measurement details).

<Type 6 For 40MHz>

EUT Frequency=5510MHz											
Radar Frequency (MHz)	DFS Detection Trials (1 =Detection, 0= No Detection)										Detection Rate (%)
	1	2	3	4	5	6	7	8	9	10	
5487	0	0	0	0	0	0	0	0	0	0	0%
5488	0	0	0	0	0	0	0	0	0	0	0%
5489	0	0	0	0	0	0	0	0	0	0	0%
5490	0	0	0	0	0	0	0	0	0	0	0%
5491 (FL)	1	1	1	1	1	1	1	1	1	1	100%
5492	1	1	1	1	1	1	1	1	1	1	100%
5493	1	1	1	1	1	1	1	1	1	1	100%
5494	1	1	1	1	1	1	1	1	1	1	100%
5495	1	1	1	1	1	1	1	1	1	1	100%
5496	1	1	1	1	1	1	1	1	1	1	100%
5497	1	1	1	1	1	1	1	1	1	1	100%
5498	1	1	1	1	1	1	1	1	1	1	100%
5499	1	1	1	1	1	1	1	1	1	1	100%
5500	1	1	1	1	1	1	1	1	1	1	100%
5501	1	1	1	1	1	1	1	1	1	1	100%
5502	1	1	1	1	1	1	1	1	1	1	100%
5503	1	1	1	1	1	1	1	1	1	1	100%
5504	1	1	1	1	1	1	1	1	1	1	100%
5505	1	1	1	1	1	1	1	1	1	1	100%
5506	1	1	1	1	1	1	1	1	1	1	100%
5507	1	1	1	1	1	1	1	1	1	1	100%
5508	1	1	1	1	1	1	1	1	1	1	100%
5509	1	1	1	1	1	1	1	1	1	1	100%
5510	1	1	1	1	1	1	1	1	1	1	100%
5511	1	1	1	1	1	1	1	1	1	1	100%
5512	1	1	1	1	1	1	1	1	1	1	100%
5513	1	1	1	1	1	1	1	1	1	1	100%
5514	1	1	1	1	1	1	1	1	1	1	100%
5515	1	1	1	1	1	1	1	1	1	1	100%
5516	1	1	1	1	1	1	1	1	1	1	100%
5517	1	1	1	1	1	1	1	1	1	1	100%
5518	1	1	1	1	1	1	1	1	1	1	100%
5519	1	1	1	1	1	1	1	1	1	1	100%
5520	1	1	1	1	1	1	1	1	1	1	100%

5521	1	1	1	1	1	1	1	1	1	1	100%
5522	1	1	1	1	1	1	1	1	1	1	100%
5523	1	1	1	1	1	1	1	1	1	1	100%
5524	1	1	1	1	1	1	1	1	1	1	100%
5525	1	1	1	1	1	1	1	1	1	1	100%
5526	1	1	1	1	1	1	1	1	1	1	100%
5527	1	1	1	1	1	1	1	1	1	1	100%
5528	1	1	1	1	1	1	1	1	1	1	100%
5529 (FH)	1	1	1	1	1	1	1	1	1	1	100%
5530	0	0	0	0	0	0	0	0	0	0	0%
5531	0	0	0	0	0	0	0	0	0	0	0%
5532	0	0	0	0	0	0	0	0	0	0	0%
5533	0	0	0	0	0	0	0	0	0	0	0%
Detection Bandwidth = FH-FL + 1MHz = 5529MHz-5491MHz + 1MHz = 39MHz											
EUT 99% Bandwidth = 36.16MHz (see note)											
UNII Detection Bandwidth Min. Limit (MHz): 36.16MHz x 80% = 28.93MHz											

Note: All UNII channels for this device have identical Channel bandwidths. Therefore, all DFS testing was done at 5510 MHz. The 99% channel bandwidth is 16.8MHz. (See the 99% BW section of the RF report for further measurement details).

5.3. Initial Channel Availability Check Time Measurement

5.3.1. Limit

The EUT shall perform a Channel Availability Check to ensure that there is no radar operating on the channel. After power-up sequence, receive at least 1 minute on the intended operating frequency.

5.3.2. Test Procedures

1. The U-NII devices will be powered on and be instructed to operate on the appropriate 5500MHz (for 20MHz), 5510MHz (for 40MHz). The spectrum analyzer will be set to zero span mode with a 3 MHz RBW and 3 MHz VBW on the *Channel* occupied by the radar (Chr) with a 200 seconds sweep time. The spectrum analyzer's sweep will be started at the same time power is applied to the U-NII device.
2. The EUT should not transmit any beacon or data transmissions until at least 1 minute after the completion of the power-on cycle. Measurement system showing its nominal noise floor is marker 1.

5.3.3. Test Deviation

There is no deviation with the original standard.

5.3.4. Test Result for Initial Channel Availability Check Time

<For 20MHz>

The EUT does not transmit any beacon or data transmissions until at least 1 minute after the completion of the power-on cycle (42.7 sec). The initial power up time of the EUT is indicated by marker 1 (42.7 sec). Initial beacons/data transmissions are indicated by marker 2 (102.7 sec).

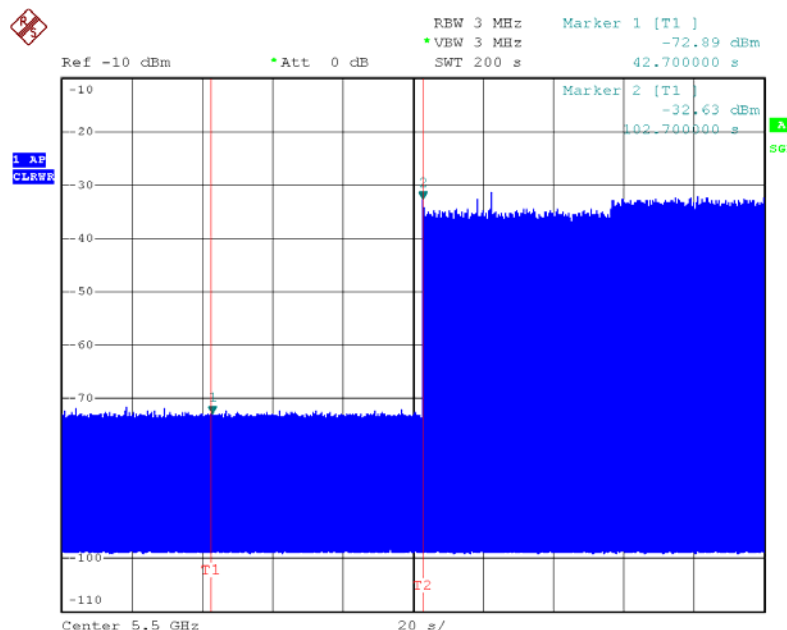

Date: 23.MAR.2009 20:26:22

<For 40MHz>

The EUT does not transmit any beacon or data transmissions until at least 1 minute after the completion of the power-on cycle (41.4 sec). The initial power up time of the EUT is indicated by marker 1 (41.4 sec). Initial beacons/data transmissions are indicated by marker 2 (101.4 sec).

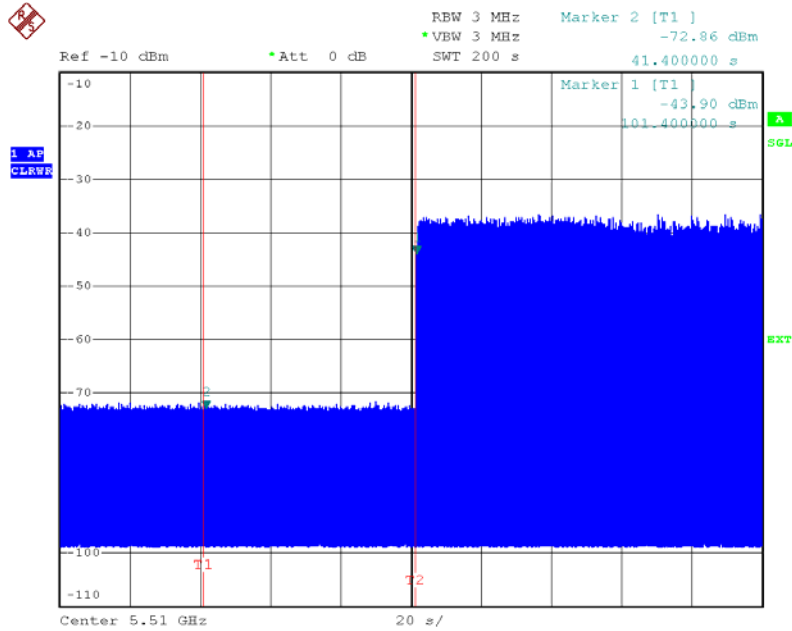

Date: 24.MAR.2009 20:16:20

5.4. Radar Burst at the Beginning of the Channel Availability Check Time Measurement

5.4.1. Limit

In beginning of the Channel Availability Check (CAC) Time, radar is detected on this channel, select another intended channel and perform a CAC on that channel.

5.4.2. Test Procedures

1. The steps below define the procedure to verify successful radar detection on the selected Channel during a period equal to the Channel Availability Check Time and avoidance of operation on that Channel when a radar Burst with a level equal to the DFS Detection Threshold + 1 dB occurs at the beginning of the Channel Availability Check Time.
2. The EUT is in completion power-up cycle (from T0 to T1). T1 denotes the instant when the EUT has completed its power-up sequence. The Channel Availability Check Time commences at instant T1 and will end no sooner than $T1 + 60$ seconds. A single Burst of short pulse of radar type 1 at DFS Detection Threshold + 1 dB will commence within a 6 second window starting at T1.
3. Visual indication on the EUT of successful detection of the radar Burst will be recorded and reported. Observation of emissions at 5500MHz (for 20MHz), 5510 (for 40MHz) will continue for 154.4 seconds (for 20MHz), 156.0 seconds (for 40MHz) after the radar Burst has been generated. Verify that during the 200 seconds measurement window no EUT transmissions occurred at 5500MHz (for 20MHz), 5510 (for 40MHz).

5.4.3. Test Deviation

There is no deviation with the original standard.

5.4.4. Results of Radar Burst at the Beginning of the Channel Availability Check Time

<For 20MHz>

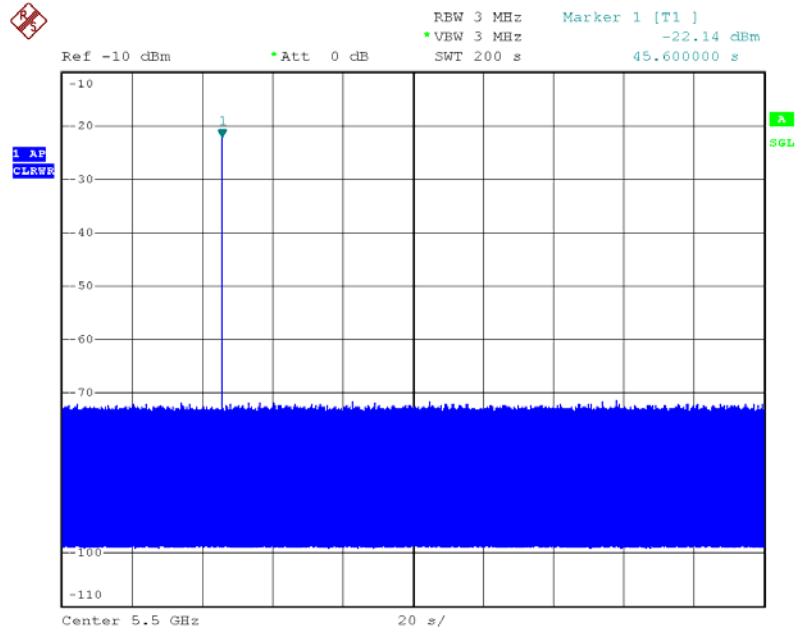

Date: 23.MAR.2009 21:09:32

<For 40MHz>

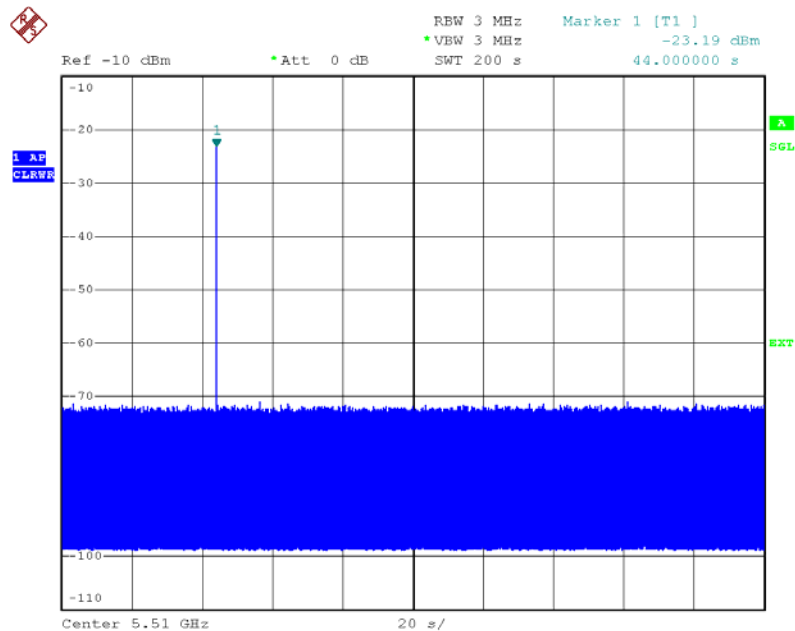

Date: 24.MAR.2009 20:31:59

5.5. Radar Burst at the End of the Channel Availability Check Time Measurement

5.5.1. Limit

In the end of Channel Availability Check (CAC) Time, radar is detected on this channel, select another intended channel and perform a CAC on that channel.

5.5.2. Test Procedures

1. The steps below define the procedure to verify successful radar detection on the selected Channel during a period equal to the Channel Availability Check Time and avoidance of operation on that Channel when a radar Burst with a level equal to the DFS Detection Threshold + 1 dB occurs at the end of the Channel Availability Check Time.
2. The EUT is powered on at T0. T1 denotes the instant when the EUT has completed its power-up sequence. The Channel Availability Check Time commences at instant T1 and will end no sooner than T1 + 60 seconds. A single Burst of short pulse of radar type 1 at DFS Detection Threshold + 1 dB will commence within a 6 second window starting at T1 + 54 seconds.
3. Visual indication on the EUT of successful detection of the radar Burst will be recorded and reported. Observation of emissions at 5500MHz (for 20MHz), 5510 (for 40MHz) will continue for 99.96 seconds (for 20MHz), 102.0 seconds (for 40MHz) after the radar Burst has been generated. Verify that during the 200 seconds measurement window no EUT transmissions occurred at 5500MHz (for 20MHz), 5510 (for 40MHz).

5.5.3. Test Deviation

There is no deviation with the original standard.

5.5.4. Results of Radar Burst at the end of the Channel Availability Check Time

<For 20MHz>

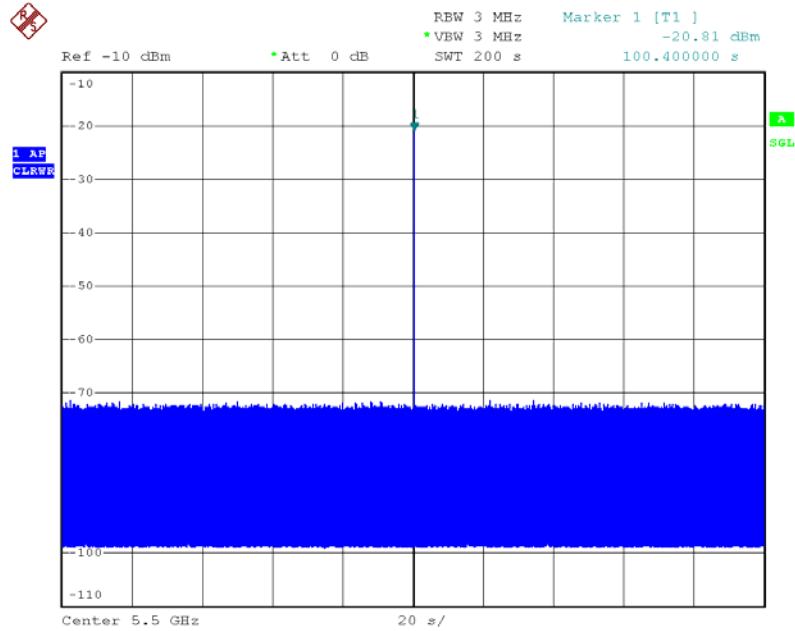

Date: 23.MAR.2009 21:22:13

<For 40MHz>

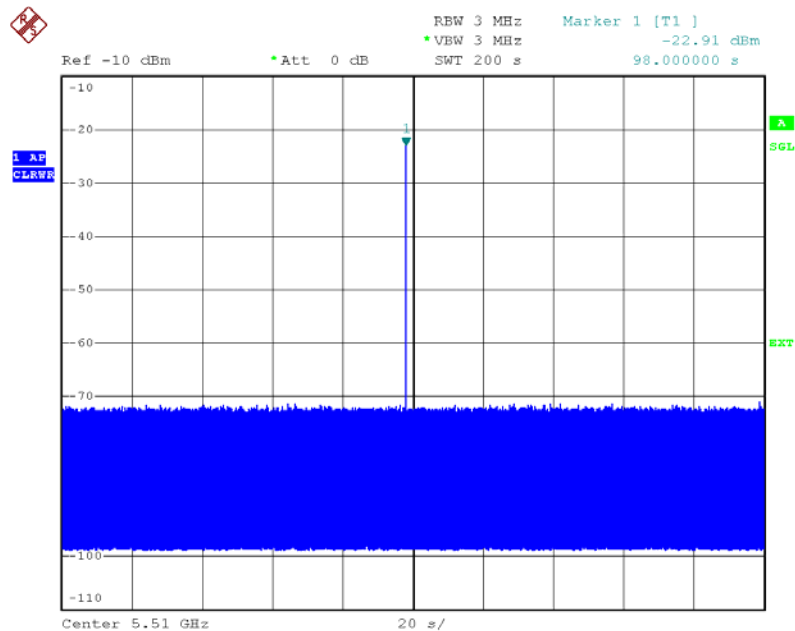

Date: 24.MAR.2009 20:39:12

5.6. In-Service Monitoring for Channel Move Time, Channel Closing Transmission Time and Non-Occupancy Period Measurement

5.6.1. Limit

The EUT has In-Service Monitoring function to continuously monitor the radar signals, If radar is detected, must leave the channel (Shutdown). The Channel Move Time to cease all transmissions on the current Channel upon detection of a Radar Waveform above the DFS Detection Threshold within 10 sec. The total duration of Channel Closing Transmission Time is 260ms, consisting of data signals and the aggregate of control signals, by a U-NII device during the Channel Move Time. The Non-Occupancy Period time is 30 minute during which a Channel will not be utilized after a Radar Waveform is detected on that Channel.

5.6.2. Test Procedures

1. When a radar Burst with a level equal to the DFS Detection Threshold + 1dB is generated on the Operating Channel of the U-NII device. A U-NII device operating as a Client Device will associate with the Master at Channel. Stream the MPEG test file from the Master Device to the Client Device on the selected Channel for the entire period of the test. At time T₀ the Radar Waveform generator sends a Burst of pulses for each of the radar types at Detection Threshold + 1dB.
2. Observe the transmissions of the EUT at the end of the radar Burst on the Operating Channel. Measure and record the transmissions from the EUT during the observation time (Channel Move Time). One 10 second plot been reported for the Short Pulse Radar Types 1-4 and one for the Long Pulse Radar Type test in a 22 second plot. The plot for the Short Pulse Radar Types start at the end of the radar burst. The *Channel Move Time* will be calculated based on the plot of the Short Pulse Radar Type. The Long Pulse Radar Type plot show the device ceased transmissions within the 10 second window after detection has occurred. The plot for the Long Pulse Radar Type should start at the beginning of the 12 second waveform.
3. Measurement of the aggregate duration of the Channel Closing Transmission Time method. With the spectrum analyzer set to zero span tuned to the center frequency of the EUT operating channel at the radar simulated frequency, peak detection, and max hold, the dwell time per bin is given by: **Dwell (2ms) = S (1 sec) / B (500)** ; where **Dwell** is the dwell time per spectrum analyzer sampling bin, **S** is the sweep time and **B** is the number of spectrum analyzer sampling bins. An upper bound of the aggregate duration of the intermittent control signals of *Channel Closing Transmission Time* is calculated by: **20MHz: C (6 ms) = N (3) X Dwell (2 ms)**, **40MHz: C (8 ms) = N (4) X Dwell (2 ms)**; where **C** is the Closing Time, **N** is the number of spectrum analyzer sampling bins (intermittent control signals) showing a U-NII transmission and **Dwell** is the dwell time per bin.
4. Measure the EUT for more than 30 minutes following the channel close/move time to verify that the EUT does not resume any transmissions on this Channel.

5.6.3. Test Deviation

There is no deviation with the original standard.

5.6.4. Result of Channel Move Time & Channel Closing Transmission Time & Non-Occupancy Period

<For 20MHz>

Parameter	Test Result		Limit
	Type 1	Type 5	
Test Channel (MHz)	5500	5500	$\geq 60s$
Channel Move Time (sec)	0.492	0	< 10s
Intermittent Control Signals(ms) (Note)	6	0	< 60ms
Non-Occupancy Period (min.)	≥ 30	-	≥ 30 min

Note: The Channel Closing Transmission Time is comprised of 200 milliseconds starting at the beginning of the Channel Move Time plus any additional intermittent control signals required to facilitate a Channel move (an aggregate of 60 milliseconds) during the remainder of the 10 second period. The aggregate duration of control signals will not count quiet periods in between transmissions.

<For 40MHz>

Parameter	Test Result		Limit
	Type 1	Type 5	
Test Channel (MHz)	5510	5510	$\geq 60s$
Channel Move Time (sec)	0.432	0	< 10s
Intermittent Control Signals(ms) (Note)	8	0	< 60ms
Non-Occupancy Period (min.)	≥ 30	-	≥ 30 min

Note: The Channel Closing Transmission Time is comprised of 200 milliseconds starting at the beginning of the Channel Move Time plus any additional intermittent control signals required to facilitate a Channel move (an aggregate of 60 milliseconds) during the remainder of the 10 second period. The aggregate duration of control signals will not count quiet periods in between transmissions.

5.6.5. Channel Move Time Plot

<For 20MHz>

Radar #1 Channel Move Time

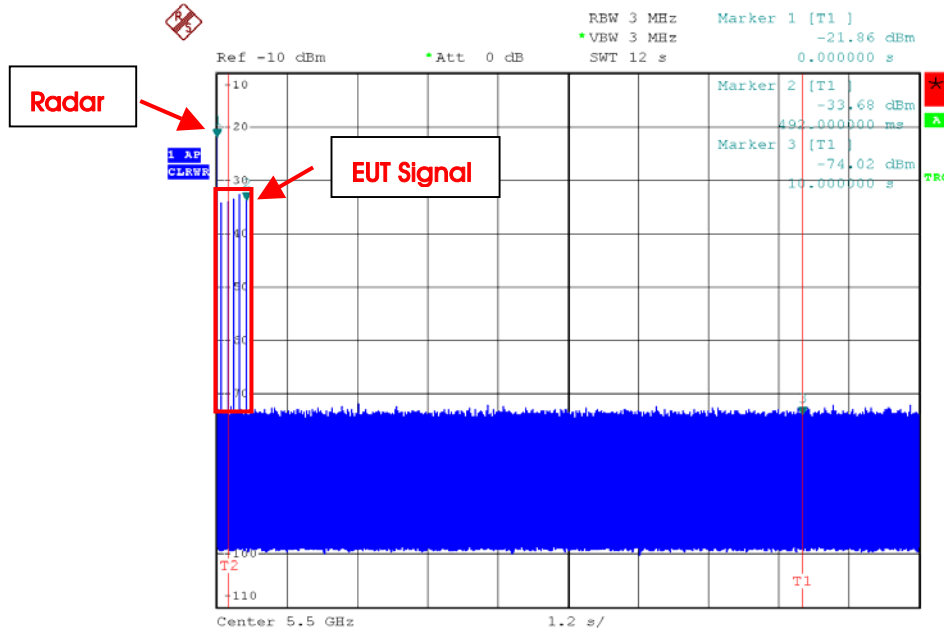

Date: 23.MAR.2009 21:56:48

Radar #5 Channel Move Time

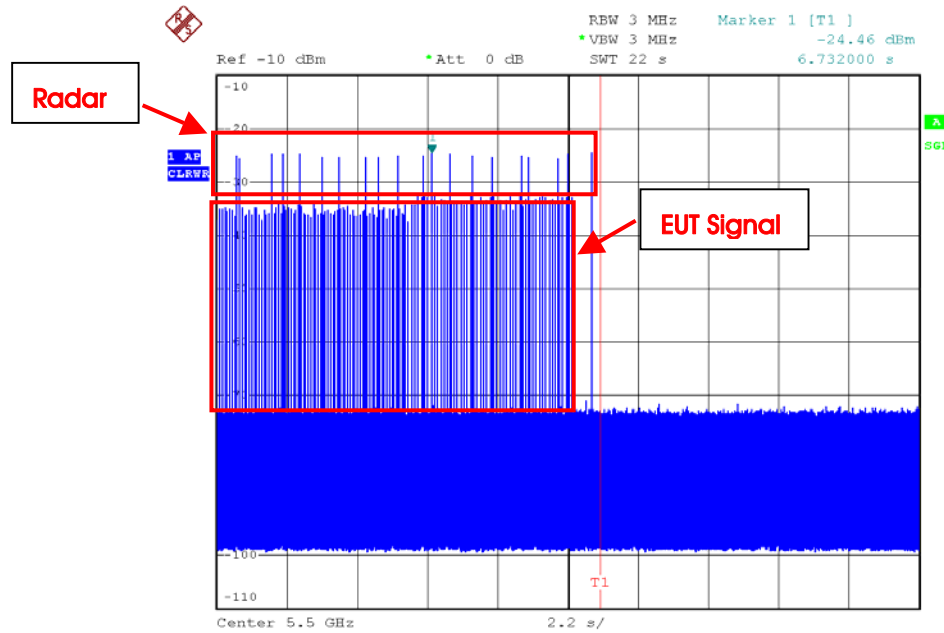

Date: 23.MAR.2009 21:46:59

<For 40MHz>

Radar #1 Channel Move Time

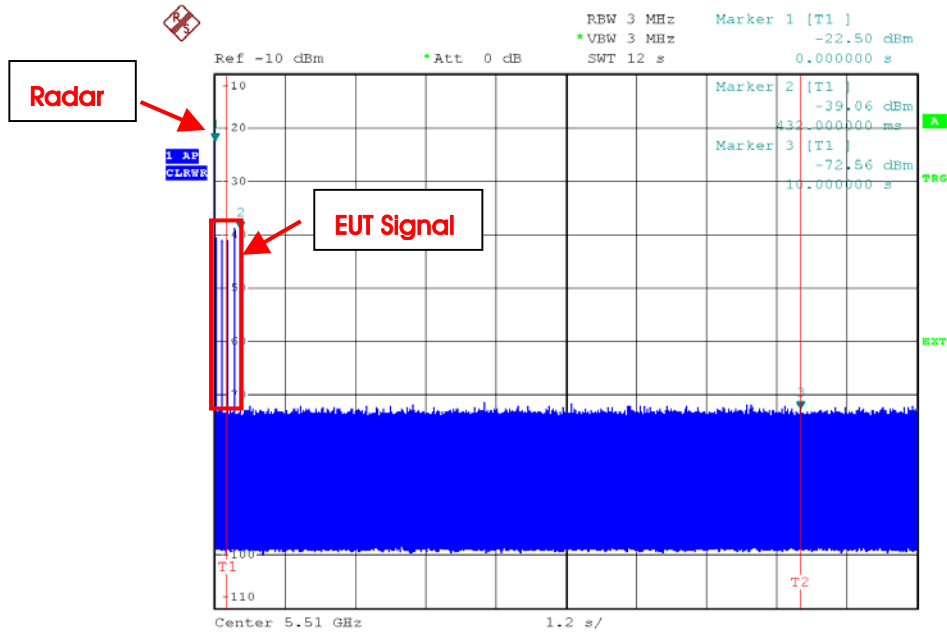

Date: 24.MAR.2009 20:47:14

Radar #5 Channel Move Time

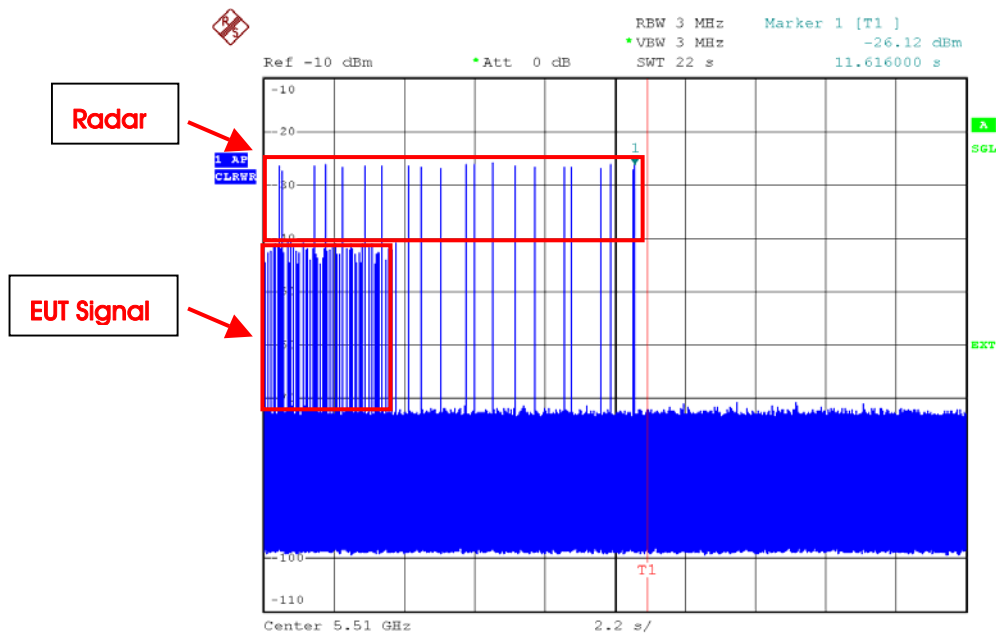

Date: 24.MAR.2009 21:09:15

5.6.6. Channel Closing Transmission Time Plot

<For 20MHz>

Radar #1 Channel Closing Transmission Time is comprised of 200 ms starting at the beginning of the Channel Move Time plus 30ms additional intermittent control signals

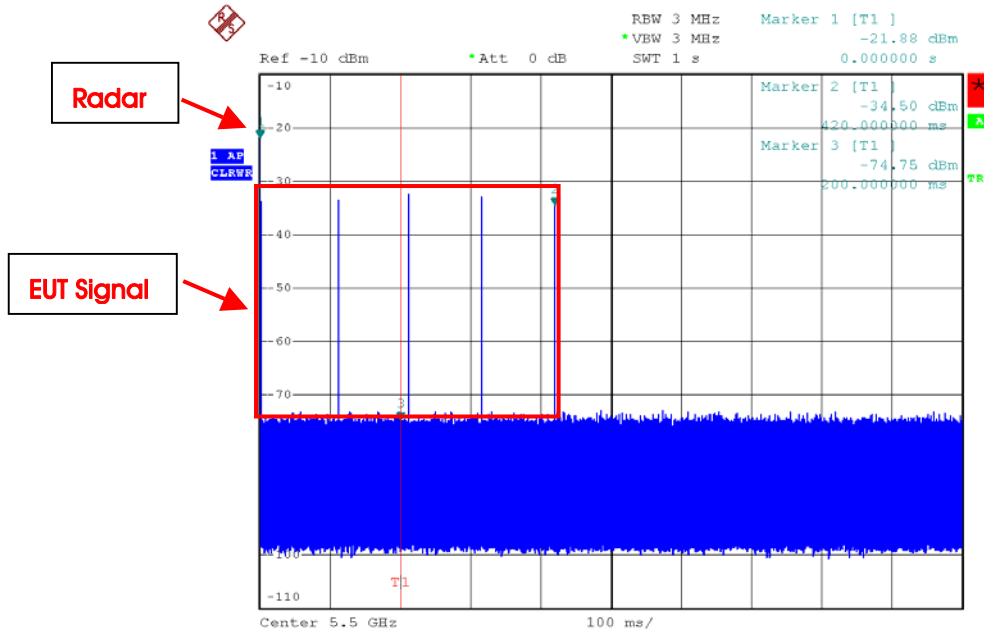

Date: 23.MAR.2009 21:54:31

Radar #5 Channel Closing Transmission Time is comprised of 200 ms starting at the beginning of the Channel Move Time plus 30ms additional intermittent control signals. EUT have 0 control pulse.

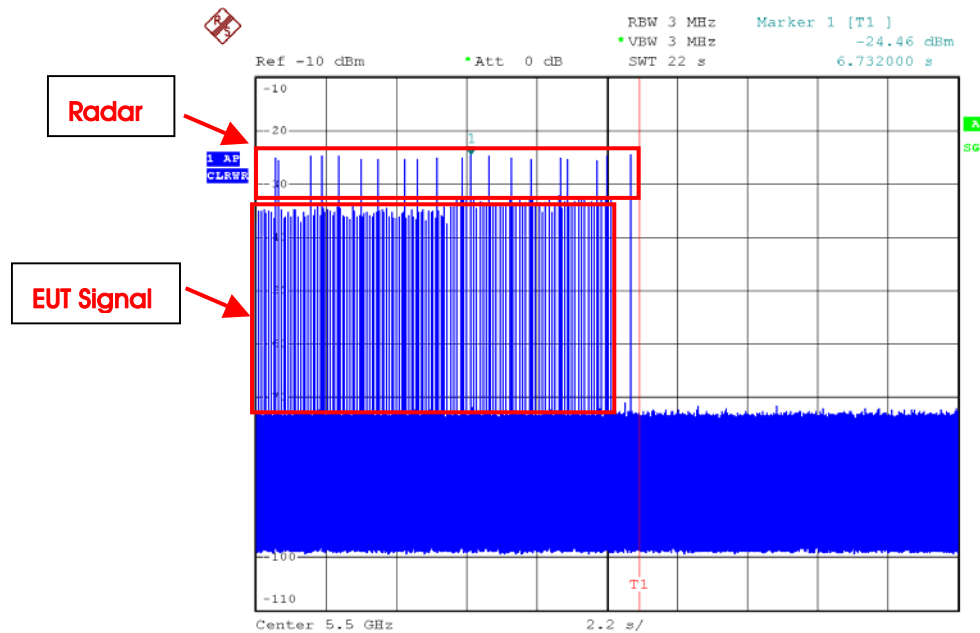

Date: 23.MAR.2009 21:46:59

<For 40MHz>

Radar #1 Channel Closing Transmission Time is comprised of 200 ms starting at the beginning of the Channel Move Time plus 30ms additional intermittent control signals

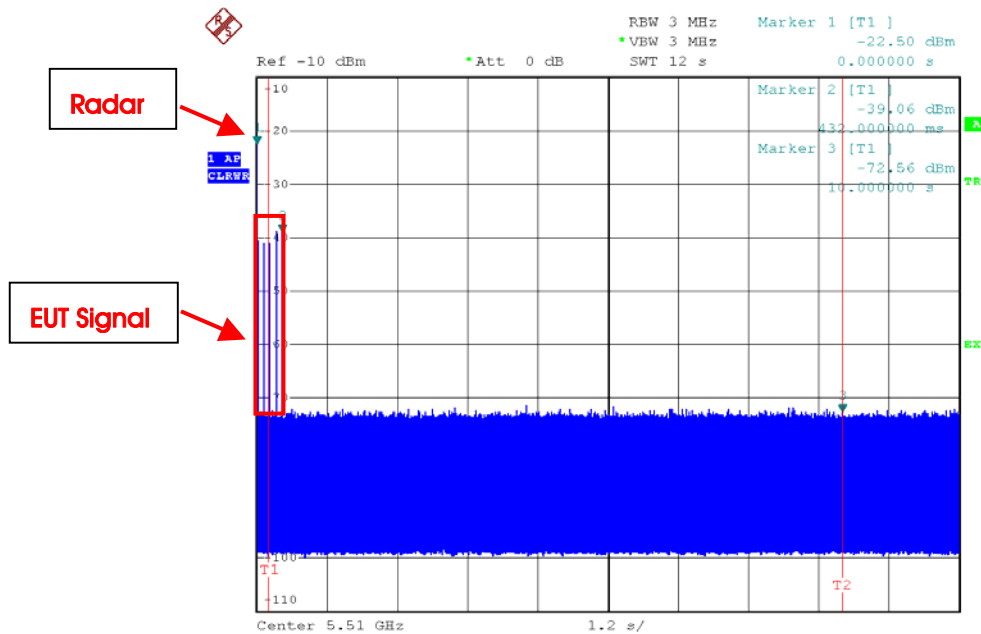

Date: 24.MAR.2009 20:47:14

Radar #5 Channel Closing Transmission Time is comprised of 200 ms starting at the beginning of the Channel Move Time plus 30ms additional intermittent control signals. EUT have 0 control pulse.

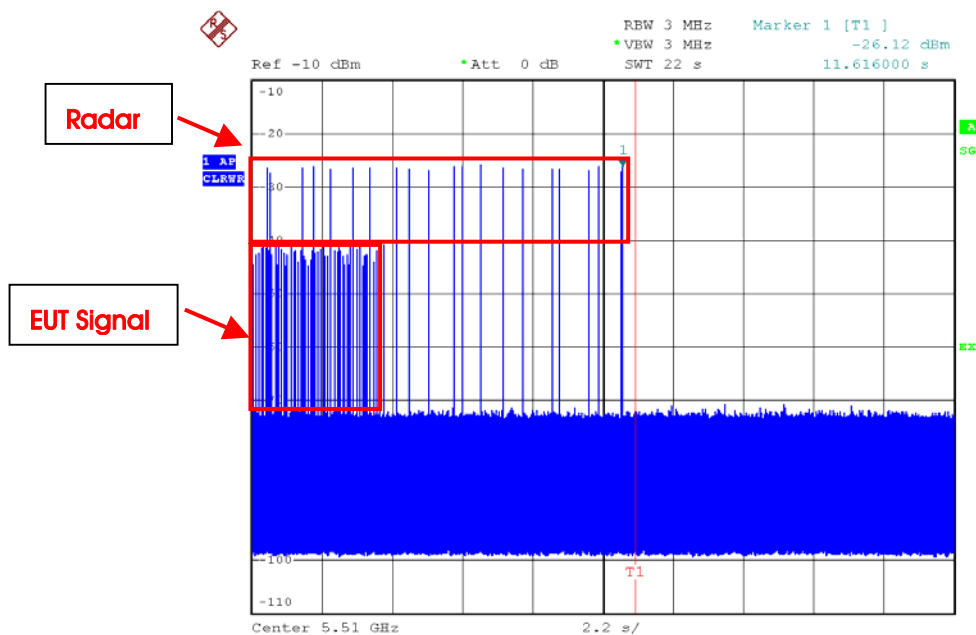

Date: 24.MAR.2009 21:09:15

Dwell is the dwell time per spectrum analyzer sampling bin.

S is the sweep time

B is the number of spectrum analyzer sampling bins

C is the intermittent control signals of Channel Closing Transmission Time

N is the number of spectrum analyzer sampling bins (intermittent control signals) showing a U-NII transmission

Dwell (2 ms) = S (1 sec) / B (500)

For 20MHz

Type 1: C (6 ms) = N (3) X Dwell (2 ms)

Type 5: C (0 ms) = N (0) X Dwell (44 ms)

For 40MHz

Type 1: C (8 ms) = N (4) X Dwell (2 ms)

Type 5: C (0 ms) = N (0) X Dwell (44 ms)

5.6.7. Non-Occupancy Period Plot

<For 20MHz>

Non-Occupancy Period

During the 30 minutes observation time, UUT did not make any transmissions on a channel after a radar signal was detected on that channel by either the Channel Availability Check or the In-Service Monitoring.

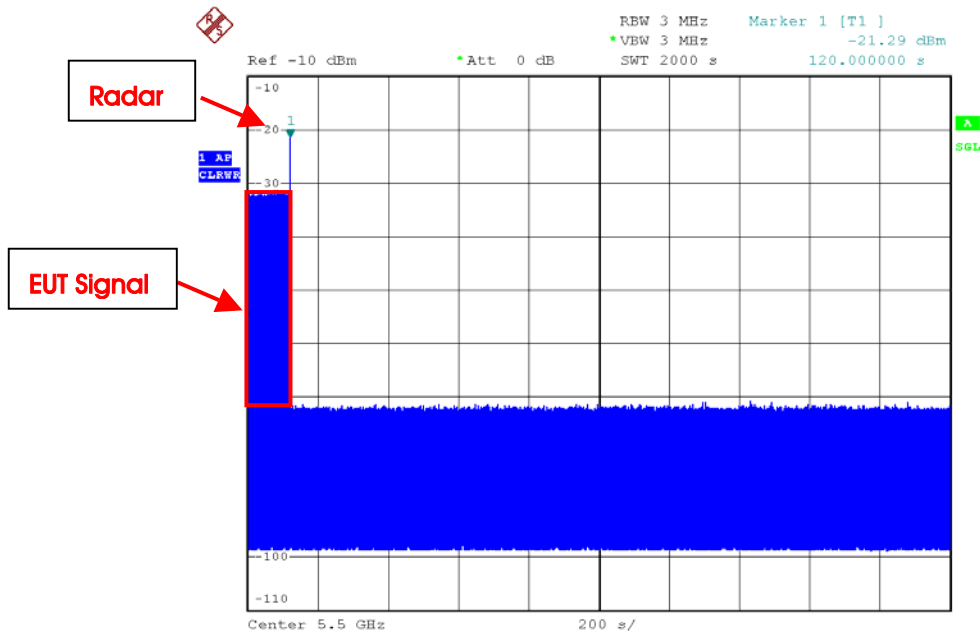

Date: 23.MAR.2009 22:33:41

<For 40MHz>

Non-Occupancy Period

During the 30 minutes observation time, UUT did not make any transmissions on a channel after a radar signal was detected on that channel by either the Channel Availability Check or the In-Service Monitoring.

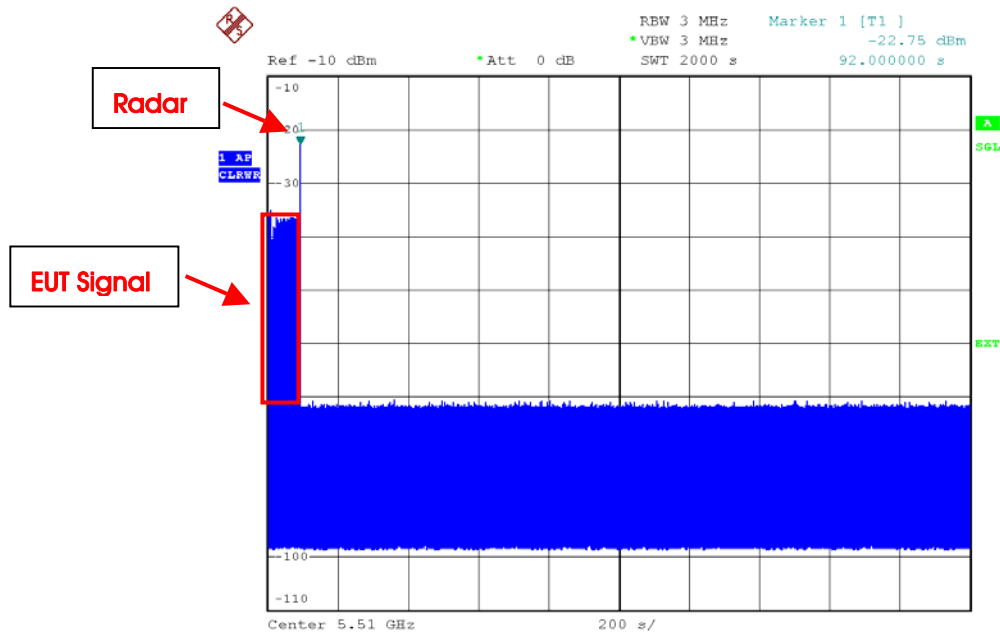

Date: 24.MAR.2009 22:04:44

5.7. Statistical Performance Check Measurement

5.7.1. Limit

The minimum percentage of successful detection requirements found in below table when a radar burst with a level equal to the DFS Detection Threshold + 1 dB is generated on the Operating Channel of the U-NII device (In- Service Monitoring).

Radar Type	Minimum Number of Trails	Detection Probability
1	30	Pd > 60%
2	30	Pd > 60%
3	30	Pd > 60%
4	30	Pd > 60%
Aggregate (Radar Types 1-4)	120	Pd > 80%
5	30	Pd > 80%
6	30	Pd > 70%

The percentage of successful detection is calculated by:

$$\frac{\text{TotalWaveformDetections}}{\text{TotalWaveformTrails}} \times 100 = \text{Probability of Detection Radar Waveform}$$

In addition an aggregate minimum percentage of successful detection across all Short Pulse Radar Types 1-4 is required and is calculated as follows:

$$\frac{Pd1 + Pd2 + Pd3 + Pd4}{4}$$

5.7.2. Test Procedures

1. Stream the MPEG test file from the Master Device to the Client Device on the test Channel for the entire period of the test.
2. At time T0 the Radar Waveform generator sends the individual waveform for each of the Radar Types 1-6, at levels equal to the DFS Detection Threshold + 1 dB, on the Operating Channel.
3. Observe the transmissions of the EUT at the end of the Burst on the Operating Channel for duration greater than 10 seconds for Short Pulse Radar Types 1-4 and 6 to ensure detection occurs.
4. Observe the transmissions of the EUT at the end of the Burst on the Operating Channel for duration greater than 22 seconds for Long Pulse Radar Type 5 to ensure detection occurs.
5. The device can utilize a test mode to demonstrate when detection occurs to prevent the need to reset the device between trial runs.
6. The Minimum number of trails, minimum percentage of successful detection and the average minimum percentage of successful detection are found in below table.

5.7.3. Test Deviation

There is no deviation with the original standard.

5.7.4. Test Result of Statistical Performance Check

<For 20MHz>

Type 1 Radar Statistical Performance

Trail #	Test Freq. (MHz)	Pulse Width (us)	PRI (us)	Pulses / Burst	1=Detection ; 0=No Detection
1	5492	1	1428	18	1
2	5493	1	1428	18	1
3	5494	1	1428	18	1
4	5495	1	1428	18	1
5	5496	1	1428	18	1
6	5497	1	1428	18	1
7	5498	1	1428	18	1
8	5499	1	1428	18	1
9	5500	1	1428	18	1
10	5501	1	1428	18	1
11	5502	1	1428	18	1
12	5503	1	1428	18	1
13	5504	1	1428	18	1
14	5505	1	1428	18	1
15	5506	1	1428	18	1
16	5507	1	1428	18	1
17	5508	1	1428	18	1
18	5507	1	1428	18	1
19	5506	1	1428	18	1
20	5505	1	1428	18	1
21	5504	1	1428	18	1
22	5503	1	1428	18	1
23	5502	1	1428	18	1
24	5501	1	1428	18	1
25	5500	1	1428	18	1
26	5499	1	1428	18	1
27	5498	1	1428	18	1
28	5497	1	1428	18	1
29	5496	1	1428	18	1
30	5495	1	1428	18	1
Detection Percentage (%)					100.00



Type 2 Radar Statistical Performance

Trail #	Test Freq. (MHz)	Pulse Width (us)	PRI (us)	Pulses / Burst	1 =Detection ; 0=No Detection
1	5492	2.6	221	23	1
2	5493	4.6	198	27	1
3	5494	1.1	184	29	1
4	5495	4.8	203	24	1
5	5496	2.4	162	25	1
6	5497	3.4	204	28	1
7	5498	2.3	170	27	1
8	5499	3.5	184	23	1
9	5500	4.9	150	27	1
10	5501	4.6	211	29	1
11	5502	2.9	158	23	1
12	5503	2.6	226	27	1
13	5504	1.6	204	26	1
14	5505	3.9	181	25	1
15	5506	4.6	202	24	1
16	5507	4.1	194	27	1
17	5508	2.3	193	28	1
18	5507	3.9	173	29	1
19	5506	4.3	188	23	1
20	5505	1.5	215	26	1
21	5504	4.9	227	27	1
22	5503	1.1	199	23	1
23	5502	4.5	155	29	1
24	5501	4.0	190	27	1
25	5500	2.4	151	23	1
26	5499	2.5	180	28	1
27	5498	2.5	228	23	1
28	5497	2.5	203	25	1
29	5496	1.5	188	25	1
30	5495	1.9	217	24	1
Detection Percentage (%)					100.00



Type 3 Radar Statistical Performance

Trail #	Test Freq. (MHz)	Pulse Width (us)	PRI (us)	Pulses / Burst	1=Detection ; 0=No Detection
1	5492	8.0	205	16	1
2	5493	6.7	382	18	1
3	5494	8.6	418	16	1
4	5495	9.4	351	17	1
5	5496	7.4	383	18	1
6	5497	9.8	232	16	1
7	5498	9.1	377	17	1
8	5499	9.6	457	16	1
9	5500	8.0	471	18	1
10	5501	9.0	304	18	1
11	5502	8.0	316	17	1
12	5503	9.8	325	16	1
13	5504	8.0	409	17	1
14	5505	9.9	200	17	1
15	5506	8.8	458	16	1
16	5507	8.0	232	18	1
17	5508	8.3	250	16	1
18	5507	8.7	270	16	1
19	5506	7.7	350	17	1
20	5505	7.1	230	16	1
21	5504	7.3	416	18	1
22	5503	7.6	498	18	1
23	5502	7.3	286	17	1
24	5501	7.3	287	16	1
25	5500	7.5	462	17	1
26	5499	6.2	300	17	0
27	5498	6.4	323	18	1
28	5497	7.1	420	16	1
29	5496	7.2	395	18	1
30	5495	8.4	377	16	1
Detection Percentage (%)					96.67

**Type 4 Radar Statistical Performance**

Trail #	Test Freq. (MHz)	Pulse Width (us)	PRI (us)	Pulses / Burst	1=Detection ; 0=No Detection
1	5492	18.0	242	15	1
2	5493	19.9	279	12	1
3	5494	12.9	487	14	1
4	5495	15.0	452	13	1
5	5496	16.3	230	12	1
6	5497	19.8	238	13	1
7	5498	18.2	420	16	1
8	5499	16.3	452	15	1
9	5500	14.2	495	12	0
10	5501	17.8	228	16	1
11	5502	19.1	211	16	1
12	5503	18.4	283	15	1
13	5504	11.8	411	12	1
14	5505	14.2	284	13	1
15	5506	13.9	202	12	1
16	5507	17.8	340	14	1
17	5508	15.6	290	16	1
18	5507	14.6	250	16	1
19	5506	14.4	484	15	1
20	5505	18.9	387	13	1
21	5504	11.1	348	15	1
22	5503	13.8	291	16	1
23	5502	14.3	295	12	1
24	5501	12.5	300	12	1
25	5500	12.5	322	14	1
26	5499	12.5	383	13	1
27	5498	15.7	322	16	1
28	5497	19.8	469	13	1
29	5496	18.6	406	15	1
30	5495	15.9	238	14	1
Detection Percentage (%)					96.67

Total Type 1~4 Radar Statistical Performance

Radar Type #	Detection Percentage (%)
1	100.00
2	100.00
3	96.67
4	96.67
Total 1~4	98.33

Type 5 Radar Statistical Performance

Trail #	1=Detection ; 0=No Detection	Trail #	1=Detection ; 0=No Detection	Trail #	1=Detection ; 0=No Detection
1	1	11	1	21	1
2	1	12	1	22	1
3	1	13	1	23	1
4	1	14	1	24	1
5	1	15	1	25	1
6	1	16	1	26	1
7	0	17	1	27	1
8	1	18	1	28	1
9	1	19	1	29	1
10	0	20	1	30	1
Detection Percentage (%)					93.33



Type 6 Radar Statistical Performance

Trail #	Test Freq. (MHz)	Pulses / Hop	Pulse Width (us)	PRI (us)	1=Detection ; 0=No Detection
1	5492	9	1	333	1
2	5493	9	1	333	1
3	5494	9	1	333	1
4	5495	9	1	333	1
5	5496	9	1	333	1
6	5497	9	1	333	0
7	5498	9	1	333	1
8	5499	9	1	333	1
9	5500	9	1	333	1
10	5501	9	1	333	1
11	5502	9	1	333	1
12	5503	9	1	333	1
13	5504	9	1	333	1
14	5505	9	1	333	1
15	5506	9	1	333	1
16	5507	9	1	333	1
17	5508	9	1	333	1
18	5507	9	1	333	1
19	5506	9	1	333	1
20	5505	9	1	333	1
21	5504	9	1	333	1
22	5503	9	1	333	1
23	5502	9	1	333	1
24	5501	9	1	333	1
25	5500	9	1	333	1
26	5499	9	1	333	1
27	5498	9	1	333	1
28	5497	9	1	333	1
29	5496	9	1	333	1
30	5495	9	1	333	1
Detection Percentage (%)					96.67



<For 40MHz>

Type 1 Radar Statistical Performance

Trail #	Test Freq. (MHz)	Pulse Width (us)	PRI (us)	Pulses / Burst	1=Detection ; 0=No Detection
1	5495	1	1428	18	1
2	5496	1	1428	18	1
3	5497	1	1428	18	1
4	5498	1	1428	18	1
5	5499	1	1428	18	1
6	5500	1	1428	18	1
7	5501	1	1428	18	1
8	5502	1	1428	18	1
9	5503	1	1428	18	1
10	5504	1	1428	18	1
11	5505	1	1428	18	1
12	5506	1	1428	18	1
13	5507	1	1428	18	1
14	5508	1	1428	18	1
15	5509	1	1428	18	1
16	5510	1	1428	18	1
17	5511	1	1428	18	1
18	5512	1	1428	18	1
19	5513	1	1428	18	1
20	5514	1	1428	18	1
21	5515	1	1428	18	1
22	5516	1	1428	18	1
23	5517	1	1428	18	1
24	5518	1	1428	18	1
25	5519	1	1428	18	1
26	5520	1	1428	18	1
27	5521	1	1428	18	1
28	5522	1	1428	18	1
29	5523	1	1428	18	1
30	5524	1	1428	18	1
Detection Percentage (%)					100.00



Type 2 Radar Statistical Performance

Trail #	Test Freq. (MHz)	Pulse Width (us)	PRI (us)	Pulses / Burst	1 =Detection ; 0=No Detection
1	5495	2.6	221	23	1
2	5496	4.6	198	27	1
3	5497	1.1	184	29	0
4	5498	4.8	203	24	1
5	5499	2.4	162	25	1
6	5500	3.4	204	28	1
7	5501	2.3	170	27	1
8	5502	3.5	184	23	1
9	5503	4.9	150	27	1
10	5504	4.6	211	29	1
11	5505	2.9	158	23	1
12	5506	2.6	226	27	1
13	5507	1.6	204	26	1
14	5508	3.9	181	25	0
15	5509	4.6	202	24	1
16	5510	4.1	194	27	1
17	5511	2.3	193	28	1
18	5512	3.9	173	29	1
19	5513	4.3	188	23	0
20	5514	1.5	215	26	1
21	5515	4.9	227	27	1
22	5516	1.1	199	23	1
23	5517	4.5	155	29	1
24	5518	4.0	190	27	1
25	5519	2.4	151	23	1
26	5520	2.5	180	28	1
27	5521	2.5	228	23	1
28	5522	2.5	203	25	1
29	5523	1.5	188	25	1
30	5524	1.9	217	24	1
Detection Percentage (%)					90.00



Type 3 Radar Statistical Performance

Trail #	Test Freq. (MHz)	Pulse Width (us)	PRI (us)	Pulses / Burst	1=Detection ; 0=No Detection
1	5495	8.0	205	16	1
2	5496	6.7	382	18	1
3	5497	8.6	418	16	1
4	5498	9.4	351	17	1
5	5499	7.4	383	18	1
6	5500	9.8	232	16	1
7	5501	9.1	377	17	0
8	5502	9.6	457	16	1
9	5503	8.0	471	18	1
10	5504	9.0	304	18	0
11	5505	8.0	316	17	1
12	5506	9.8	325	16	1
13	5507	8.0	409	17	1
14	5508	9.9	200	17	1
15	5509	8.8	458	16	1
16	5510	8.0	232	18	1
17	5511	8.3	250	16	1
18	5512	8.7	270	16	1
19	5513	7.7	350	17	1
20	5514	7.1	230	16	1
21	5515	7.3	416	18	1
22	5516	7.6	498	18	1
23	5517	7.3	286	17	1
24	5518	7.3	287	16	1
25	5519	7.5	462	17	1
26	5520	6.2	300	17	1
27	5521	6.4	323	18	1
28	5522	7.1	420	16	1
29	5523	7.2	395	18	0
30	5524	8.4	377	16	1
Detection Percentage (%)					90.00

**Type 4 Radar Statistical Performance**

<i>Trail #</i>	<i>Test Freq. (MHz)</i>	<i>Pulse Width (us)</i>	<i>PRI (us)</i>	<i>Pulses / Burst</i>	<i>1=Detection ; 0=No Detection</i>
1	5495	18.0	242	15	1
2	5496	19.9	279	12	1
3	5497	12.9	487	14	0
4	5498	15.0	452	13	1
5	5499	16.3	230	12	1
6	5500	19.8	238	13	1
7	5501	18.2	420	16	1
8	5502	16.3	452	15	1
9	5503	14.2	495	12	1
10	5504	17.8	228	16	1
11	5505	19.1	211	16	1
12	5506	18.4	283	15	1
13	5507	11.8	411	12	1
14	5508	14.2	284	13	0
15	5509	13.9	202	12	1
16	5510	17.8	340	14	1
17	5511	15.6	290	16	1
18	5512	14.6	250	16	1
19	5513	14.4	484	15	1
20	5514	18.9	387	13	1
21	5515	11.1	348	15	1
22	5516	13.8	291	16	1
23	5517	14.3	295	12	1
24	5518	12.5	300	12	1
25	5519	12.5	322	14	1
26	5520	12.5	383	13	1
27	5521	15.7	322	16	1
28	5522	19.8	469	13	1
29	5523	18.6	406	15	1
30	5524	15.9	238	14	1
Detection Percentage (%)					93.33

Total Type 1~4 Radar Statistical Performance

Radar Type #	Detection Percentage (%)
1	100.00
2	90.00
3	90.00
4	93.33
Total 1~4	93.33

Type 5 Radar Statistical Performance

Trail #	1=Detection ; 0=No Detection	Trail #	1=Detection ; 0=No Detection	Trail #	1=Detection ; 0=No Detection
1	1	11	1	21	1
2	1	12	1	22	1
3	1	13	1	23	1
4	1	14	1	24	1
5	1	15	1	25	1
6	1	16	1	26	1
7	1	17	1	27	1
8	0	18	1	28	1
9	1	19	1	29	1
10	0	20	1	30	1
Detection Percentage (%)					93.33



Type 6 Radar Statistical Performance

Trail #	Test Freq. (MHz)	Pulses / Hop	Pulse Width (us)	PRI (us)	1=Detection ; 0=No Detection
1	5495	9	1	333	1
2	5496	9	1	333	1
3	5497	9	1	333	1
4	5498	9	1	333	1
5	5499	9	1	333	1
6	5500	9	1	333	0
7	5501	9	1	333	1
8	5502	9	1	333	1
9	5503	9	1	333	1
10	5504	9	1	333	1
11	5505	9	1	333	1
12	5506	9	1	333	1
13	5507	9	1	333	1
14	5508	9	1	333	1
15	5509	9	1	333	0
16	5510	9	1	333	1
17	5511	9	1	333	1
18	5512	9	1	333	1
19	5513	9	1	333	1
20	5514	9	1	333	1
21	5515	9	1	333	1
22	5516	9	1	333	1
23	5517	9	1	333	1
24	5518	9	1	333	1
25	5519	9	1	333	1
26	5520	9	1	333	1
27	5521	9	1	333	1
28	5522	9	1	333	1
29	5523	9	1	333	1
30	5524	9	1	333	1
Detection Percentage (%)					93.33

6. LIST OF MEASURING EQUIPMENTS

Instrument	Manufacturer	Model No.	Serial No.	Characteristics	Calibration Date	Remark
Spectrum Analyzer	R&S	FSP30	100023	9kHz ~ 30GHz	Jan. 09, 2009	Conducted (TH01-HY)
RF CABLE-1m	Jye Bao	RG142	CB034-1m	20MHz ~ 7GHz	Dec. 01, 2008	Conducted (TH01-HY)
Vector Signal Generator	R&S	SMU200A	102098	100kHz ~ 6GHz	Dec. 14, 2008	Conducted (TH01-HY)
RF Power Divider	HP	11636A	102934	N/A	N/A	Conducted (TH01-HY)
RF Power Splitter	Anaren	44100	881840 / 881850	N/A	N/A	Conducted (TH01-HY)
RF Power Splitter	Anaren	42100	8817950 / 8817960	N/A	N/A	Conducted (TH01-HY)
RF Cable-0.5m	SUHNER	SUCOFLEX 106	TH01-HY -01~06	1GHz~26.5GHz	Feb. 03, 2009	Conducted (TH01-HY)

Note: Calibration Interval of instruments listed above is one year.

* Calibration Interval of instruments listed above is two year.

7. TEST LOCATION

SHIJR	ADD : 6Fl., No. 106, Sec. 1, Shintai 5th Rd., Shijr City, Taipei, Taiwan 221, R.O.C. TEL : 886-2-2696-2468 FAX : 886-2-2696-2255
HWA YA	ADD : No. 52, Hwa Ya 1st Rd., Kwei-Shan Hsiang, Tao Yuan Hsien, Taiwan, R.O.C. TEL : 886-3-327-3456 FAX : 886-3-318-0055
LINKOU	ADD : No. 30-2, Dingfu Tsuen, Linkou Shiang, Taipei, Taiwan 244, R.O.C TEL : 886-2-2601-1640 FAX : 886-2-2601-1695
DUNGHU	ADD : No. 3, Lane 238, Kangle St., Neihu Chiu, Taipei, Taiwan 114, R.O.C. TEL : 886-2-2631-4739 FAX : 886-2-2631-9740
JUNGHE	ADD : 7Fl., No. 758, Jungjeng Rd., Junghe City, Taipei, Taiwan 235, R.O.C. TEL : 886-2-8227-2020 FAX : 886-2-8227-2626
NEIHU	ADD : 4Fl., No. 339, Hsin Hu 2 nd Rd., Taipei 114, Taiwan, R.O.C. TEL : 886-2-2794-8886 FAX : 886-2-2794-9777
JHUBEI	ADD : No.8, Lane 724, Bo-ai St., Jhubei City, HsinChu County 302, Taiwan, R.O.C. TEL : 886-3-656-9065 FAX : 886-3-656-9085

8. TAF CERTIFICATE OF ACCREDITATION



Certificate No. : L1190-070110

財團法人全國認證基金會
Taiwan Accreditation Foundation

Certificate of Accreditation

This is to certify that

Sporton International Inc.

EMC & Wireless Communications Laboratory

No.52, Hwa Ya 1st Rd., Hwa Ya Technology Park, Kwei-Shan Hsiang, Tao Yuan Hsien,
Taiwan, R.O.C.

is accredited in respect of laboratory

Accreditation Criteria	: ISO/IEC 17025:2005
Accreditation Number	: 1190
Originally Accredited	: December 15, 2003
Effective Period	: January 10, 2007 to January 09, 2010
Accredited Scope	: Testing Field, see described in the Appendix
Specific Accreditation Program	: Accreditation Program for Designated Testing Laboratory for Commodities Inspection : Accreditation Program for Telecommunication Equipment Testing Laboratory



Jay-San Chen
President, Taiwan Accreditation Foundation
Date : January 10, 2007

P1, total 9 pages

The Appendix forms an integral part of this Certificate, which shall be invalid when used without the Appendix.