

FCC Test Report

Report No.: RF140402E02G-1

FCC ID: HEDAC866

Test Model: SF-AC866-1, SF-AC866

Series Model: ECWO4320, ECWO4320-C, ECWO4320-L, ECWO4324, ECWO4324-C, ECWO4324-L

Received Date: Mar. 19, 2015

Test Date: Mar. 19 to Apr. 09, 2015

Issued Date: Apr. 30, 2015

Applicant: Accton Technology Corporation

Address: No.1, Creation Rd. III, Science-based Industrial Park, Hsinchu, Taiwan, R.O.C.

Issued By: Bureau Veritas Consumer Products Services (H.K.) Ltd., Taoyuan Branch Hsin Chu Laboratory

Lab Address: No. 81-1, Lu Liao Keng, 9th Ling, Wu Lung Tsuen, Chiung Lin Hsiang, Hsin Chu Hsien 307, Taiwan R.O.C.

Test Location (1): No. 81-1, Lu Liao Keng, 9th Ling, Wu Lung Tsuen, Chiung Lin Hsiang, Hsin Chu Hsien 307, Taiwan R.O.C.

Test Location (2): No. 49, Ln. 206, Wende Rd., Shangshan Tsuen, Chiung Lin Hsiang, Hsin Chu Hsien 307, Taiwan R.O.C.



This report is for your exclusive use. Any copying or replication of this report to or for any other person or entity, or use of our name or trademark, is permitted only with our prior written permission. This report sets forth our findings solely with respect to the test samples identified herein. The results set forth in this report are not indicative or representative of the quality or characteristics of the lot from which a test sample was taken or any similar or identical product unless specifically and expressly noted. Our report includes all of the tests requested by you and the results thereof based upon the information that you provided to us. You have 60 days from date of issuance of this report to notify us of any material error or omission caused by our negligence, provided, however, that such notice shall be in writing and shall specifically address the issue you wish to raise. A failure to raise such issue within the prescribed time shall constitute your unqualified acceptance of the completeness of this report, the tests conducted and the correctness of the report contents. Unless specifically mentioned, the uncertainty of measurement has been explicitly taken into account to declare the compliance or non-compliance to the specification. The report must not be used by the client to claim product certification, approval, or endorsement by TAF or any government agencies.

Table of Contents

Release Control Record	4
1 Certificate of Conformity	5
2 Summary of Test Results	6
2.1 Measurement Uncertainty.....	6
2.2 Modification Record.....	6
3 General Information	7
3.1 General Description of EUT.....	7
3.2 Description of Test Modes.....	10
3.2.1 Test Mode Applicability and Tested Channel Detail.....	11
3.3 Duty Cycle of Test Single.....	14
3.4 Description of Support Units.....	16
3.4.1 Configuration of System under Test.....	17
3.5 General Description of Applied Standards.....	18
4 Test Types and Results	19
4.1 Radiated Emission and Bandedge Measurement.....	19
4.1.1 Limits of Radiated Emission and Bandedge Measurement.....	19
4.1.2 Test Instruments.....	20
4.1.3 Test Procedures.....	23
4.1.4 Deviation from Test Standard.....	23
4.1.5 Test Setup.....	24
4.1.6 EUT Operating Conditions.....	24
4.1.7 Test Results (Mode 1).....	25
4.1.8 Test Results (Mode 2).....	56
4.2 Conducted Emission Measurement.....	87
4.2.1 Limits of Conducted Emission Measurement.....	87
4.2.2 Test Instruments.....	87
4.2.3 Test Procedures.....	88
4.2.4 Deviation from Test Standard.....	88
4.2.5 Test Setup.....	88
4.2.6 EUT Operating Conditions.....	88
4.2.7 Test Results (Mode 1).....	89
4.2.8 Test Results (Mode 2).....	91
4.3 Transmit Power Measurement.....	93
4.3.1 Limits of Transmit Power Measurement.....	93
4.3.2 Test Setup.....	93
4.3.3 Test Instruments.....	93
4.3.4 Test Procedures.....	93
4.3.5 Deviation from Test Standard.....	93
4.3.6 EUT Operating Conditions.....	94
4.3.7 Test Results (Mode 1).....	95
4.3.8 Test Results (Mode 2).....	97
4.4 Peak Power Spectral Density Measurement.....	100
4.4.1 Limits of Peak Power Spectral Density Measurement.....	100
4.4.2 Test Setup.....	100
4.4.3 Test Instruments.....	100
4.4.4 Test Procedures.....	100
4.4.5 Deviation from Test Standard.....	101
4.4.6 EUT Operating Conditions.....	101
4.4.7 Test Results (Mode 1).....	102
4.4.8 Test Results (Mode 2).....	110
4.5 Frequency Stability Measurement.....	118
4.5.1 Limits of Frequency Stability Measurement.....	118
4.5.2 Test Setup.....	118

4.5.3	Test Instruments	118
4.5.4	Test Procedures.....	118
4.5.5	Deviation from Test Standard	118
4.5.6	EUT Operating Conditions.....	118
4.5.7	Test Results (Mode 1).....	119
4.5.8	Test Results (Mode 2).....	120
4.6	6dB Bandwidth Measurement.....	121
4.6.1	Limits of 6dB Bandwidth Measurement.....	121
4.6.2	Test Setup.....	121
4.6.3	Test Instruments	121
4.6.4	Test Procedures.....	121
4.6.5	Deviation from Test Standard	121
4.6.6	EUT Operating Conditions.....	121
4.6.7	Test Results (Mode 1).....	122
4.6.8	Test Results (Mode 2).....	126
5	Pictures of Test Arrangements.....	130
	Appendix – Information on the Testing Laboratories	131



Release Control Record

Issue No.	Description	Date Issued
RF140402E02G-1	Original release.	Apr. 30, 2015



1 Certificate of Conformity

Product: 5GHz Outdoor AP, 802.11ac Outdoor 5GHz Access Point

Brand: IgniteNet, Edge-CorE

Test Model: SF-AC866-1, SF-AC866

Series Model: ECWO4320, ECWO4320-C, ECWO4320-L, ECWO4324, ECWO4324-C, ECWO4324-L

Sample Status: ENGINEERING SAMPLE

Applicant: Accton Technology Corporation

Test Date: Mar. 19 to Apr. 09, 2015

Standards: 47 CFR FCC Part 15, Subpart E (Section 15.407)
ANSI C63.10:2009

The above equipment has been tested by **Bureau Veritas Consumer Products Services (H.K.) Ltd., Taoyuan Branch**, and found compliance with the requirement of the above standards. The test record, data evaluation & Equipment Under Test (EUT) configurations represented herein are true and accurate accounts of the measurements of the sample's EMC characteristics under the conditions specified in this report.

Prepared by : Phoenix Huang , **Date:** Apr. 30, 2015
Phoenix Huang / Specialist

Approved by : May Chen , **Date:** Apr. 30, 2015
May Chen / Manager

2 Summary of Test Results

47 CFR FCC Part 15, Subpart E (SECTION 15.407 Under New Rule)			
FCC Clause	Test Item	Result	Remarks
15.407(b)(6)	AC Power Conducted Emissions	PASS	Meet the requirement of limit. Minimum passing margin is -15.79dB at 0.15000MHz.
15.407(b)(1/2/3/4/6)	Radiated Emissions & Band Edge Measurement	PASS	Meet the requirement of limit. Minimum passing margin is -0.1dB at 5150.00MHz, 5715.00MHz, 5725.00MHz & 5860.00MHz.
15.407(a)(1/2/3)	Max Average Transmit Power	PASS	Meet the requirement of limit.
15.407(a)(1/2/3)	Peak Power Spectral Density	PASS	Meet the requirement of limit.
15.407(e)	6dB bandwidth	PASS	Meet the requirement of limit. (U-NII-3 Band only)
15.407(g)	Frequency Stability	PASS	Meet the requirement of limit.
15.203	Antenna Requirement	PASS	For External Antenna connector is RP-SMA not a standard connector. For Internal Antenna connector is MMCX not a standard connector.

2.1 Measurement Uncertainty

Where relevant, the following measurement uncertainty levels have been estimated for tests performed on the EUT as specified in CISPR 16-4-2:

Measurement	Frequency	Expanded Uncertainty (k=2) (±)
Conducted Emissions at mains ports	150kHz ~ 30MHz	2.86 dB
Radiated Emissions up to 1 GHz	30MHz ~ 1GHz	5.37 dB
Radiated Emissions above 1 GHz	1GHz ~ 6GHz	3.65 dB
	6GHz ~ 18GHz	3.88 dB
	18GHz ~ 40GHz	4.11 dB

2.2 Modification Record

There were no modifications required for compliance.

3 General Information

3.1 General Description of EUT

Product	5GHz Outdoor AP, 802.11ac Outdoor 5GHz Access Point
Brand	IgniteNet, Edge-CorE
Test Model	SF-AC866-1, SF-AC866
Series Model:	ECWO4320, ECWO4320-C, ECWO4320-L, ECWO4324, ECWO4324-C, ECWO4324-L
Status of EUT	ENGINEERING SAMPLE
Power Supply Rating	DC 24V from POE
Modulation Type	64QAM, 16QAM, QPSK, BPSK for OFDM 256QAM for OFDM in 11ac mode only
Modulation Technology	OFDM
Transfer Rate	802.11a: up to 54Mbps 802.11n : up to 300Mbps 802.11ac: up to 866.7Mbps
Operating Frequency	5.18GHz ~ 5.24GHz, 5.745GHz ~ 5.825GHz
Number of Channel	9 for 802.11a, 802.11n (HT20), 802.11ac (VHT20) 4 for 802.11n (HT40), 802.11ac (VHT40) 2 for 802.11ac (VHT80)
Output Power	Refer to Note
Antenna Type	Refer to Note
Antenna Connector	Refer to Note
Accessory Device	PoE × 1
Data Cable Supplied	NA

Note:

1. The EUT is a 5GHz WLAN device.
2. The maximum output power (mW) table as below table:

Modulation Mode	External antenna		Internal antenna	
	1Tx	2Tx	1Tx	2Tx
802.11a	265.461	-	137.721	-
802.11ac (VHT20)	240.436	283.351	142.561	130.78
802.11ac (VHT40)	209.411	265.659	83.56	105.454
802.11ac (VHT80)	87.297	77.763	15.311	24.755

3. The EUT has below model names, which are identical to each other in all aspects except for the followings:

Product Name	Brand Name	Model Name	Different
5GHz Outdoor AP	IgniteNet	SF-AC866	1. Internal antenna 1 2. Without mini USB port
	IgniteNet	SF-AC866-1	1. External antenna 1 2. Without mini USB port
802.11ac Outdoor 5GHz Access Point	Edge-corE	ECWO4320	1. Internal antenna 2 2. With mini USB port 3. Software: Fat
	Edge-corE	ECWO4320-C	1. Internal antenna 2 2. With mini USB port 3. Software: Fit
	Edge-corE	ECWO4320-L	1. Internal antenna 2 2. With mini USB port 3. Software: Fit
	Edge-corE	ECWO4324	1. External antenna 1 2. With mini USB port 3. Software: Fat
	Edge-corE	ECWO4324-C	1. External antenna 1 2. With mini USB port 3. Software: Fit
	Edge-corE	ECWO4324-L	1. External antenna 1 2. With mini USB port 3. Software: Fit

Note:

- From the above models, models: **SF-AC866-1**, **SF-AC866** were selected as representative model for the test and its data was recorded in this report.

4. The EUT must be supplied with a POE as following table:

Brand	Model No.	Spec.
LEI	NU24-F240100-I2	AC Input: 100-240V, 0.7A, 50/60Hz AC Input cable: 0.8m DC Output: 24V, 1A

5. The antennas provided to the EUT, please refer to the following table:

External antenna 1 (Single Band Ant.)

Brand Name: Cortec / Model Name: AN5000-0301RS

Transmitter Circuit	Antenna Type	Connector Type	Antenna Gain(dBi) <excluding cable loss>	Inside EUT		Outside EUT		Net. Gain (dBi)	Frequency range (MHz to MHz)
				Cable Loss (dB)	Cable Length (mm)	Cable Loss (dB)	Cable Length (mm)		
Chain (0)	Dipole	RP-SMA	2.7	1.2	250	2.9	500	-1.4	5150~5850
Chain (1)	Dipole	RP-SMA	2.7	1.2	250	2.9	500	-1.4	5150~5850

Internal antenna 1 (Single Band Ant.)

Brand Name: Accton / Model Name: 123800000297A

Transmitter Circuit	Antenna Type	Connector Type	Antenna Gain(dBi)	Frequency range (MHz to MHz)
Chain (0)	Patch Array	MMCX	13.81	5150~5850
Chain (1)	Patch Array	MMCX	13.72	5150~5850

Internal antenna 2 (Single Band Ant.)

Brand Name: NA / Model Name: NA

Transmitter Circuit	Antenna Type	Connector Type	Antenna Gain(dBi)	Frequency range (MHz to MHz)
Chain (0)	Patch Array	MMCX	8	5150~5850
Chain (1)	Patch Array	MMCX	8	5150~5850

Note:

1. For 802.11a mode will fix transmission on Chain (0)
2. From the above Internal antennas, **Internal antenna 1** max gain was selected as representative antenna test, its data was recorded in this report.

6. The EUT incorporates a MIMO function.

MODULATION MODE	DATA RATE (MCS)	TX & RX CONFIGURATION	
802.11a	6 ~ 54Mbps	1TX (fix Chain 0)	2RX
802.11n (HT20)	MCS 0~7	1TX (fix Chain 0)	2RX
	MCS 8~15*	2TX	2RX
802.11n (HT40)	MCS 0~7	1TX (fix Chain 0)	2RX
	MCS 8~15*	2TX	2RX
802.11ac (VHT20)	MCS0~8 Nss= 1	1TX (fix Chain 0)	2RX
	MCS0~8 Nss= 2*	2TX	2RX
802.11ac (VHT40)	MCS0~9 Nss= 1	1TX (fix Chain 0)	2RX
	MCS0~9 Nss= 2*	2TX	2RX
802.11ac (VHT80)	MCS0~9 Nss= 1	1TX (fix Chain 0)	2RX
	MCS0~9 Nss= 2*	2TX	2RX

Remark: “*” means the device operate with two spatial stream (Nss = 2) with different data, and two signals are not correlated.

Note: The modulation and bandwidth are similar for 802.11n mode for 20MHz (40MHz) and 802.11ac mode for 20MHz (40MHz), therefore investigated worst case to representative mode in test report. (Final test mode refer section 3.2.1)

7. The above EUT information is declared by manufacturer and for more detailed features description, please refer to the manufacturer's specifications or user's manual.

3.2 Description of Test Modes

FOR 5180 ~ 5240MHz

4 channels are provided for 802.11a, 802.11n (HT20), 802.11ac (VHT20):

Channel	Frequency	Channel	Frequency
36	5180 MHz	44	5220 MHz
40	5200 MHz	48	5240 MHz

2 channels are provided for 802.11n (HT40), 802.11ac (VHT40):

Channel	Frequency	Channel	Frequency
38	5190 MHz	46	5230 MHz

1 channel is provided for 802.11ac (VHT80):

Channel	Frequency
42	5210MHz

FOR 5745 ~ 5825MHz:

5 channels are provided for 802.11a, 802.11n (HT20), 802.11ac (VHT20):

Channel	Frequency	Channel	Frequency
149	5745MHz	161	5805MHz
153	5765MHz	165	5825MHz
157	5785MHz		

2 channels are provided for 802.11n (HT40), 802.11ac (VHT40):

Channel	Frequency	Channel	Frequency
151	5755MHz	159	5795MHz

1 channel is provided for 802.11ac (VHT80):

Channel	Frequency
155	5775MHz

3.2.1 Test Mode Applicability and Tested Channel Detail

EUT CONFIGURE MODE	APPLICABLE TO				DESCRIPTION
	RE≥1G	RE<1G	PLC	APCM	
1	√	√	√	√	With External Antenna
2	√	√	√	√	With Internal Antenna

Where **RE≥1G**: Radiated Emission above 1GHz **RE<1G**: Radiated Emission below 1GHz
PLC: Power Line Conducted Emission **APCM**: Antenna Port Conducted Measurement

Radiated Emission Test (Above 1GHz):

- Pre-Scan has been conducted to determine the worst-case mode from all possible combinations between available modulations, data rates and antenna ports (if EUT with antenna diversity architecture).
- Following channel(s) was (were) selected for the final test as listed below.

1TX Mode							
EUT CONFIGURE MODE	MODE	FREQ. BAND (MHz)	AVAILABLE CHANNEL	TESTED CHANNEL	MODULATION TECHNOLOGY	MODULATION TYPE	DATA RATE (Mbps)
1, 2	802.11a	5180-5240	36 to 48	36, 40, 48	OFDM	BPSK	6
	802.11ac (VHT20)		36 to 48	36, 40, 48	OFDM	BPSK	6.5
	802.11ac (VHT40)		38 to 46	38, 46	OFDM	BPSK	13.5
	802.11ac (VHT80)		42	42	OFDM	BPSK	29.3
	802.11a	5745-5825	149 to 165	149, 157, 165	OFDM	BPSK	6
	802.11ac (VHT20)		149 to 165	149, 157, 165	OFDM	BPSK	6.5
	802.11ac (VHT40)		151 to 159	151, 159	OFDM	BPSK	13.5
	802.11ac (VHT80)		155	155	OFDM	BPSK	29.3
2TX Mode							
EUT CONFIGURE MODE	MODE	FREQ. BAND (MHz)	AVAILABLE CHANNEL	TESTED CHANNEL	MODULATION TECHNOLOGY	MODULATION TYPE	DATA RATE (Mbps)
1, 2	802.11ac (VHT20)	5180-5240	36 to 48	36, 40, 48	OFDM	BPSK	13
	802.11ac (VHT40)		38 to 46	38, 46	OFDM	BPSK	27
	802.11ac (VHT80)		42	42	OFDM	BPSK	58.5
	802.11ac (VHT20)	5745-5825	149 to 165	149, 157, 165	OFDM	BPSK	13
	802.11ac (VHT40)		151 to 159	151, 159	OFDM	BPSK	27
	802.11ac (VHT80)		155	155	OFDM	BPSK	58.5

Radiated Emission Test (Below 1GHz):

- Pre-Scan has been conducted to determine the worst-case mode from all possible combinations between available modulations, data rates and antenna ports (if EUT with antenna diversity architecture).
- Following channel(s) was (were) selected for the final test as listed below.

2TX Mode							
EUT CONFIGURE MODE	MODE	FREQ. BAND (MHz)	AVAILABLE CHANNEL	TESTED CHANNEL	MODULATION TECHNOLOGY	MODULATION TYPE	DATA RATE (Mbps)
1	802.11ac (VHT20)	5180-5240	36 to 48	36, 40, 48	OFDM	BPSK	13
1TX Mode							
EUT CONFIGURE MODE	MODE	FREQ. BAND (MHz)	AVAILABLE CHANNEL	TESTED CHANNEL	MODULATION TECHNOLOGY	MODULATION TYPE	DATA RATE (Mbps)
2	802.11ac (VHT20)	5745-5825	149 to 165	157	OFDM	BPSK	6.5

Power Line Conducted Emission Test:

- Pre-Scan has been conducted to determine the worst-case mode from all possible combinations between available modulations, data rates and antenna ports (if EUT with antenna diversity architecture).
- Following channel(s) was (were) selected for the final test as listed below.

2TX Mode							
EUT CONFIGURE MODE	MODE	FREQ. BAND (MHz)	AVAILABLE CHANNEL	TESTED CHANNEL	MODULATION TECHNOLOGY	MODULATION TYPE	DATA RATE (Mbps)
1	802.11ac (VHT20)	5180-5240	36 to 48	36, 40, 48	OFDM	BPSK	13
1TX Mode							
EUT CONFIGURE MODE	MODE	FREQ. BAND (MHz)	AVAILABLE CHANNEL	TESTED CHANNEL	MODULATION TECHNOLOGY	MODULATION TYPE	DATA RATE (Mbps)
2	802.11ac (VHT20)	5745-5825	149 to 165	157	OFDM	BPSK	6.5

Antenna Port Conducted Measurement:

- This item includes all test value of each mode, but only includes spectrum plot of worst value of each mode.
- Pre-Scan has been conducted to determine the worst-case mode from all possible combinations between available modulations, data rates and antenna ports (if EUT with antenna diversity architecture).
- Following channel(s) was (were) selected for the final test as listed below.

1TX Mode							
EUT CONFIGURE MODE	MODE	FREQ. BAND (MHz)	AVAILABLE CHANNEL	TESTED CHANNEL	MODULATION TECHNOLOGY	MODULATION TYPE	DATA RATE (Mbps)
1, 2	802.11a	5180-5240	36 to 48	36, 40, 48	OFDM	BPSK	6
	802.11ac (VHT20)		36 to 48	36, 40, 48	OFDM	BPSK	6.5
	802.11ac (VHT40)		38 to 46	38, 46	OFDM	BPSK	13.5
	802.11ac (VHT80)		42	42	OFDM	BPSK	29.3
	802.11a	5745-5825	149 to 165	149, 157, 165	OFDM	BPSK	6
	802.11ac (VHT20)		149 to 165	149, 157, 165	OFDM	BPSK	6.5
	802.11ac (VHT40)		151 to 159	151, 159	OFDM	BPSK	13.5
	802.11ac (VHT80)		155	155	OFDM	BPSK	29.3
2TX Mode							
EUT CONFIGURE MODE	MODE	FREQ. BAND (MHz)	AVAILABLE CHANNEL	TESTED CHANNEL	MODULATION TECHNOLOGY	MODULATION TYPE	DATA RATE (Mbps)
1, 2	802.11ac (VHT20)	5180-5240	36 to 48	36, 40, 48	OFDM	BPSK	13
	802.11ac (VHT40)		38 to 46	38, 46	OFDM	BPSK	27
	802.11ac (VHT80)		42	42	OFDM	BPSK	58.5
	802.11ac (VHT20)	5745-5825	149 to 165	149, 157, 165	OFDM	BPSK	13
	802.11ac (VHT40)		151 to 159	151, 159	OFDM	BPSK	27
	802.11ac (VHT80)		155	155	OFDM	BPSK	58.5

Test Condition:

APPLICABLE TO	ENVIRONMENTAL CONDITIONS	INPUT POWER	TESTED BY
RE≥1G	22deg. C, 68%RH	120Vac, 60Hz	Tim Ho
	25deg. C, 68%RH	120Vac, 60Hz	Robert Cheng
	22deg. C, 68%RH	120Vac, 60Hz	Weiwei Lo
	26deg. C, 70%RH	120Vac, 60Hz	Tim Ho
	25deg. C, 73%RH	120Vac, 60Hz	Robert Cheng
	26deg. C, 70%RH	120Vac, 60Hz	
RE<1G	23deg. C, 68%RH	120Vac, 60Hz	Robert Cheng
PLC	28deg. C, 72%RH	120Vac, 60Hz	Wythe Lin
APCM	25deg. C, 60%RH	120Vac, 60Hz	Anderson Chen
			Garry Cheng

3.3 Duty Cycle of Test Single

Duty cycle of test signal is 100 %, duty factor is not required.

1TX Mode

802.11a

802.11ac (VHT20)

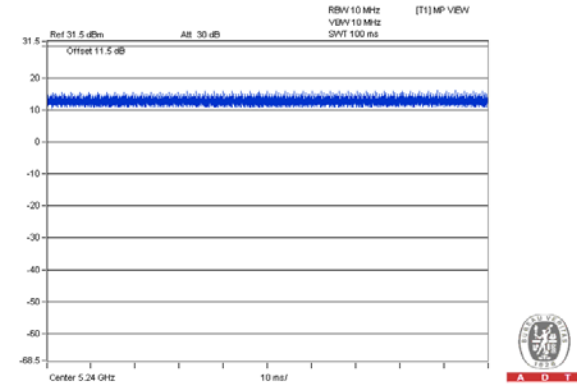
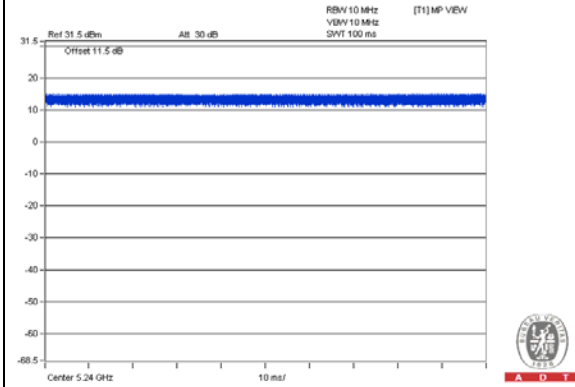

802.11ac (VHT40)

802.11ac (VHT80)

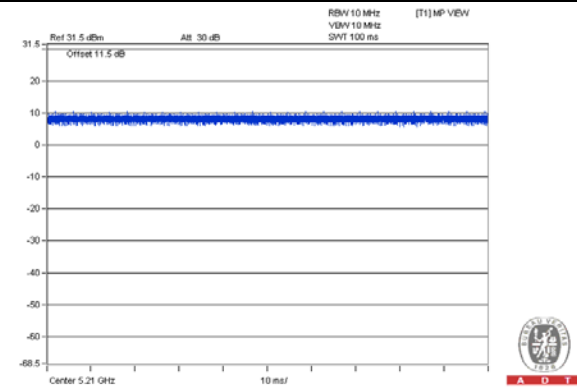
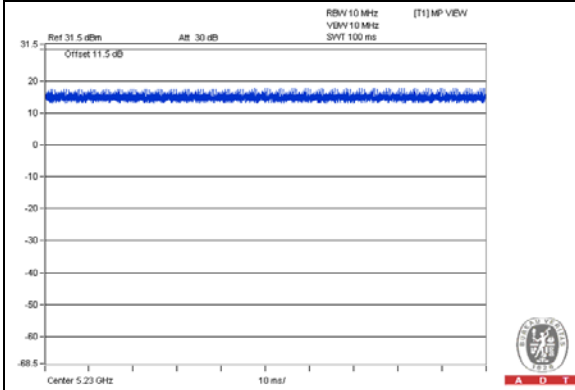

2TX Mode

802.11ac (VHT20)

802.11ac (VHT40)

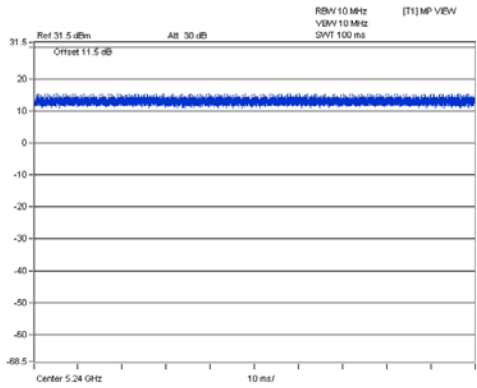

A D T

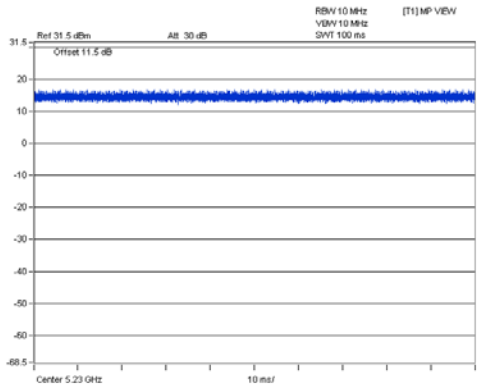

A D T

802.11ac (VHT80)

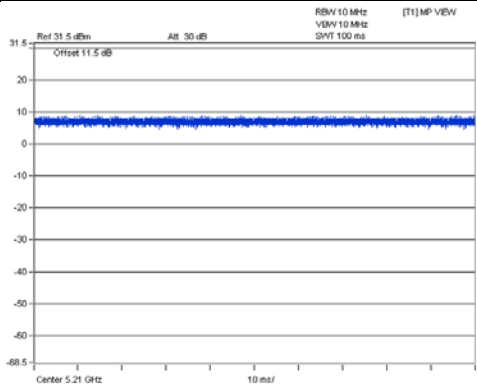

A D T

3.4 Description of Support Units

The EUT has been tested as an independent unit together with other necessary accessories or support units. The following support units or accessories were used to form a representative test configuration during the tests.

ID	Product	Brand	Model No.	Serial No.	FCC ID	Remarks
A.	NOTEBOOK COMPUTER	DELL	PP32LA	DSL32S	FCC DoC	Provided by Lab
B.	NOTEBOOK COMPUTER	DELL	E5440	6FC7F12	FCC DoC	Provided by Lab

Note:

1. All power cords of the above support units are non-shielded (1.8m).

ID	Descriptions	Qty.	Length (m)	Shielding (Yes/No)	Cores (Qty.)	Remarks
1.	RJ45	1	10	No	0	Provided by Lab
2.	RJ45	1	1.5	No	0	Provided by Lab
3.	AC	1	0.8	No	0	Supplied by Client
4.	Earth Line	1	1.5	No	0	Provided by Lab

3.4.1 Configuration of System under Test

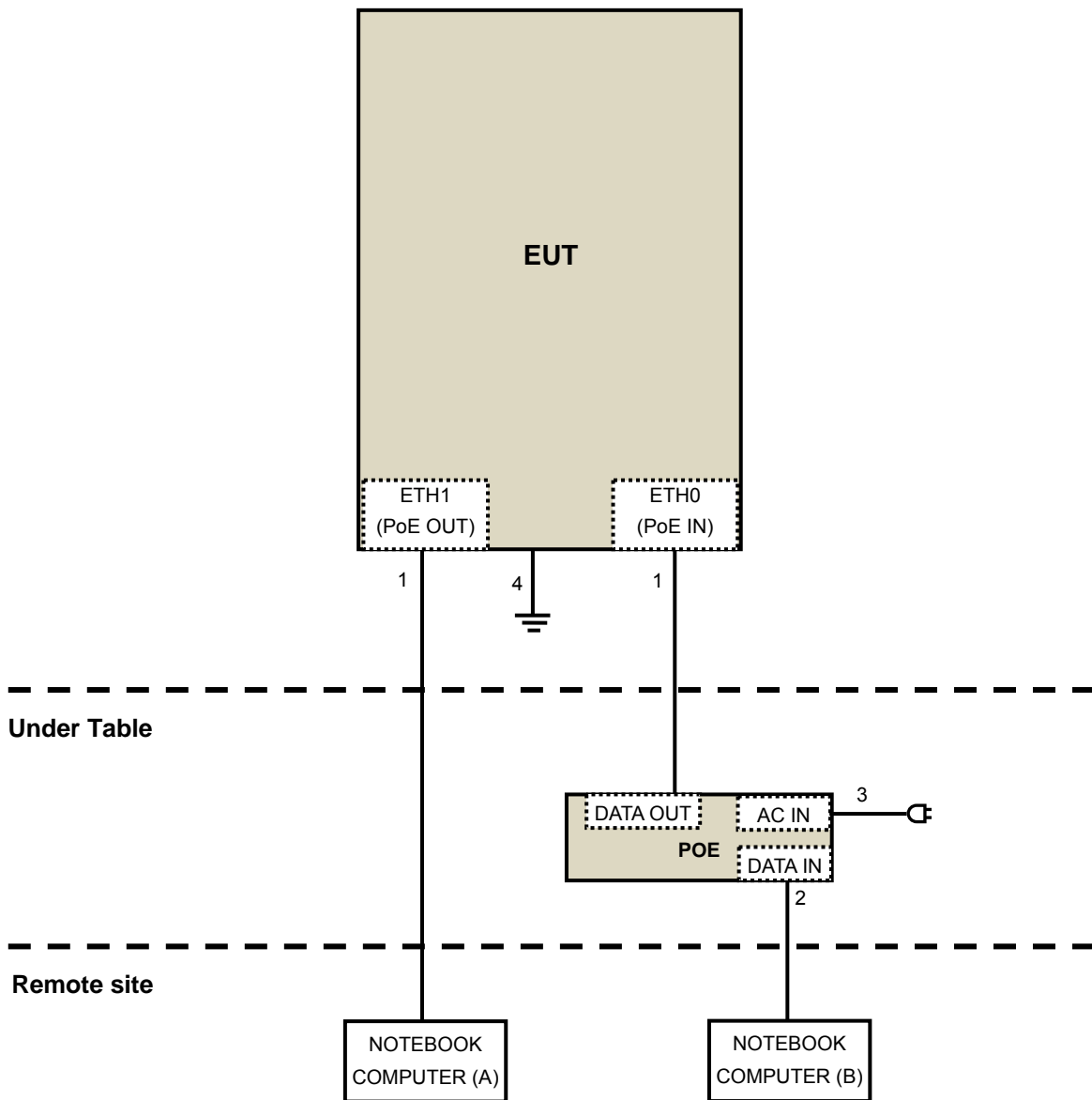

3.5 General Description of Applied Standards

The EUT is a RF Product. According to the specifications of the manufacturer, it must comply with the requirements of the following standards:

FCC Part 15, Subpart E (15.407)
789033 D02 General UNII Test Procedures New Rules v01
662911 D01 Multiple Transmitter Output v02r01
ANSI C63.10-2009

All test items have been performed and recorded as per the above standards.

Note: The EUT has been verified to comply with the requirements of FCC Part 15, Subpart B, Class B (DoC).
The test report has been issued separately.

4 Test Types and Results

4.1 Radiated Emission and Bandedge Measurement

4.1.1 Limits of Radiated Emission and Bandedge Measurement

Radiated emissions which fall in the restricted bands must comply with the radiated emission limits specified as below table.

Frequencies (MHz)	Field Strength (microvolts/meter)	Measurement Distance (meters)
0.009 ~ 0.490	2400/F(kHz)	300
0.490 ~ 1.705	24000/F(kHz)	30
1.705 ~ 30.0	30	30
30 ~ 88	100	3
88 ~ 216	150	3
216 ~ 960	200	3
Above 960	500	3

NOTE:

1. The lower limit shall apply at the transition frequencies.
2. Emission level (dBuV/m) = 20 log Emission level (uV/m).
3. For frequencies above 1000MHz, the field strength limits are based on average detector, however, the peak field strength of any emission shall not exceed the maximum permitted average limits, specified above by more than 20dB under any condition of modulation.

LIMITS OF UNWANTED EMISSION OUT OF THE RESTRICTED BANDS

APPLICABLE TO	LIMIT	
789033 D02 General UNII Test Procedures New Rules v01	FIELD STRENGTH AT 3m	
	PK:74 (dBuV/m)	AV:54 (dBuV/m)
APPLICABLE TO	EIRP LIMIT	EQUIVALENT FIELD STRENGTH AT 3m
15.407(b)(1)	PK:-27 (dBm/MHz)	PK:68.2(dBuV/m)
15.407(b)(2)		
15.407(b)(3)		
15.407(b)(4)	PK:-27 (dBm/MHz) ^{*1} PK:-17 (dBm/MHz) ^{*2}	PK:68.2(dBuV/m) ^{*1} PK:78.2 (dBuV/m) ^{*2}

NOTE: ^{*1} beyond 10MHz of the band edge ^{*2} within 10 MHz of band edge

The following formula is used to convert the equipment isotropic radiated power (eirp) to field strength:

$$E = \frac{1000000\sqrt{30P}}{3} \mu\text{V/m, where P is the eirp (Watts).$$

4.1.2 Test Instruments

For Mode 2_Above 1GHz (U-NII Band 1):

DESCRIPTION & MANUFACTURER	MODEL NO.	SERIAL NO.	CALIBRATED DATE	CALIBRATED UNTIL
MXE EMI Receiver Agilent	N9038A	MY51210105	July 21, 2014	July 20, 2015
Pre-Amplifier Mini-Circuits	ZFL-1000VH2 B	AMP-ZFL-03	Nov. 12, 2014	Nov. 11, 2015
Trilog Broadband Antenna SCHWARZBECK	VULB 9168	9168-360	Feb. 06, 2015	Feb. 05, 2016
RF Cable	NA	CHGCAB_001	Oct. 04, 2014	Oct. 03, 2015
Horn_Antenna AISI	AIH.8018	0000320091110	Aug. 27, 2014	Aug. 26, 2015
Pre-Amplifier Agilent	8449B	3008A02578	June 24, 2014	June 23, 2015
RF Cable	NA	131205 131214 SNMY23684/4	Jan. 16, 2015	Jan. 15, 2016
Spectrum Analyzer R&S	FSV40	100964	July 05, 2014	July 04, 2015
Pre-Amplifier EMCI	EMC184045	980143	Jan. 16, 2015	Jan. 15, 2016
Horn_Antenna SCHWARZBECK	BBHA 9170	9170-424	Aug. 26, 2014	Aug. 25, 2015
RF Cable	NA	RF104-121 RF104-204	Dec. 11, 2014	Dec. 10, 2015
Antenna Tower & Turn Table CT	NA	NA	NA	NA
SPECTRUM ANALYZER R&S	FSP 40	100060	May 08, 2014	May 07, 2015
Power meter Anritsu	ML2495A	1014008	Apr. 30, 2014	Apr. 29, 2015
Power sensor Anritsu	MA2411B	0917122	Apr. 30, 2014	Apr. 29, 2015
Temperature & Humidity Chamber GIANTFORCE	GTH-150-40-S P-AR	MAA0812-008	Jan. 12, 2015	Jan. 11, 2016

Note:

1. The calibration interval of the above test instruments is 12 months and the calibrations are traceable to NML/ROC and NIST/USA.
2. The horn antenna, preamplifier (model: 8449B) are used only for the measurement of emission frequency above 1GHz if tested.
3. The test was performed in 966 Chamber No. G.
4. The FCC Site Registration No. is 966073.
5. The VCCI Site Registration No. is G-137.
6. The CANADA Site Registration No. is IC 7450H-2.
7. Tested Date: Mar. 19, 2015

For Mode 2_Above 1GHz (U-NII Band 3) & Mode 1_Above 1GHz:

DESCRIPTION & MANUFACTURER	MODEL NO.	SERIAL NO.	CALIBRATED DATE	CALIBRATED UNTIL
MXE EMI Receiver Agilent	N9038A	MY50010156	Aug. 11, 2014	Aug. 10, 2015
Pre-Amplifier Mini-Circuits	ZFL-1000VH2 B	AMP-ZFL-04	Nov. 12, 2014	Nov. 11, 2015
Trilog Broadband Antenna SCHWARZBECK	VULB 9168	9168-361	Feb. 06, 2015	Feb. 05, 2016
RF Cable	NA	CHHCAB_001	Oct. 05, 2014	Oct. 04, 2015
Horn_Antenna AISI	AIH.8018	0000220091110	Aug. 26, 2014	Aug. 25, 2015
Pre-Amplifier Agilent	8449B	300801923	Oct. 28, 2014	Oct. 27, 2015
RF Cable	NA	131206 131213 131215 SNMY23685/4	Jan. 16, 2015	Jan. 15, 2016
Spectrum Analyzer R&S	FSV40	100964	July 05, 2014	July 04, 2015
Pre-Amplifier SPACEK LABS	SLKKa-48-6	9K16	Dec. 12, 2014	Dec. 11, 2015
Horn_Antenna SCHWARZBECK	BBHA 9170	9170-424	Aug. 26, 2014	Aug. 25, 2015
RF Cable	NA	329751/4 RF104-204	Dec. 11, 2014	Dec. 10, 2015
Software	ADT_Radiated _V8.7.07	NA	NA	NA
Antenna Tower & Turn Table CT	NA	NA	NA	NA
SPECTRUM ANALYZER R&S	FSP 40	100060	May 08, 2014	May 07, 2015
Power meter Anritsu	ML2495A	1014008	Apr. 30, 2014	Apr. 29, 2015
Power sensor Anritsu	MA2411B	0917122	Apr. 30, 2014	Apr. 29, 2015
Temperature & Humidity Chamber GIANTFORCE	GTH-150-40-S P-AR	MAA0812-008	Jan. 12, 2015	Jan. 11, 2016

Note:

1. The calibration interval of the above test instruments is 12 months and the calibrations are traceable to NML/ROC and NIST/USA.
2. The horn antenna, preamplifier (model: 8449B) are used only for the measurement of emission frequency above 1GHz if tested.
- 3 The test was performed in 966 Chamber No. H.
4. The FCC Site Registration No. is 797305.
- 5 The CANADA Site Registration No. is IC 7450H-3.
- 6 Tested Date: Mar. 19 to Apr. 09, 2015

For Below 1GHz test

DESCRIPTION & MANUFACTURER	MODEL NO.	SERIAL NO.	CALIBRATED DATE	CALIBRATED UNTIL
MXE EMI Receiver Agilent	N9038A	MY51210105	July 21, 2014	July 20, 2015
Pre-Amplifier Mini-Circuits	ZFL-1000VH2 B	AMP-ZFL-03	Nov. 12, 2014	Nov. 11, 2015
Trilog Broadband Antenna SCHWARZBECK	VULB 9168	9168-360	Feb. 06, 2015	Feb. 05, 2016
RF Cable	NA	CHGCAB_001	Oct. 04, 2014	Oct. 03, 2015
Horn_Antenna AISI	AIH.8018	0000320091110	Aug. 27, 2014	Aug. 26, 2015
Pre-Amplifier Agilent	8449B	3008A02578	June 24, 2014	June 23, 2015
RF Cable	NA	131205 131214 SNMY23684/4	Jan. 16, 2015	Jan. 15, 2016
Spectrum Analyzer R&S	FSV40	100964	July 05, 2014	July 04, 2015
Pre-Amplifier EMCI	EMC184045	980143	Jan. 16, 2015	Jan. 15, 2016
Horn_Antenna SCHWARZBECK	BBHA 9170	9170-424	Aug. 26, 2014	Aug. 25, 2015
RF Cable	NA	RF104-121 RF104-204	Dec. 11, 2014	Dec. 10, 2015
Antenna Tower & Turn Table CT	NA	NA	NA	NA

Note:

1. The calibration interval of the above test instruments is 12 months and the calibrations are traceable to NML/ROC and NIST/USA.
2. The horn antenna, preamplifier (model: 8449B) are used only for the measurement of emission frequency above 1GHz if tested.
- 3 The test was performed in 966 Chamber No. G.
4. The FCC Site Registration No. is 966073.
- 5 The VCCI Site Registration No. is G-137.
- 6 The CANADA Site Registration No. is IC 7450H-2.
- 7 Tested Date: Mar. 19, 2015

4.1.3 Test Procedures

- a. The EUT was placed on the top of a rotating table 0.8 meters above the ground at 3 meter chamber room for test. The table was rotated 360 degrees to determine the position of the highest radiation.
- b. The EUT was set 3 meters away from the interference-receiving antenna, which was mounted on the top of a variable-height antenna tower.
- c. The height of antenna is varied from one meter to four meters above the ground to determine the maximum value of the field strength. Both horizontal and vertical polarizations of the antenna are set to make the measurement.
- d. For each suspected emission, the EUT was arranged to its worst case and then the antenna was tuned to heights from 1 meter to 4 meters and the rotatable table was turned from 0 degrees to 360 degrees to find the maximum reading.
- e. The test-receiver system was set to quasi-peak detect function and specified bandwidth with maximum hold mode when the test frequency is below 1 GHz.
- f. The test-receiver system was set to peak and average detect function and specified bandwidth with maximum hold mode when the test frequency is above 1 GHz. If the peak reading value also meets average limit, measurement with the average detector is unnecessary.

Note:

1. The resolution bandwidth and video bandwidth of test receiver/spectrum analyzer is 120kHz for Quasi-peak detection (QP) at frequency below 1GHz.
2. The resolution bandwidth of test receiver/spectrum analyzer is 1 MHz and the video bandwidth is 3 MHz for Peak detection (PK) at frequency above 1GHz.
3. The resolution bandwidth of test receiver/spectrum analyzer is 1MHz and the video bandwidth is 3MHz for RMS Average (Duty cycle < 98%) for Average detection (AV) at frequency above 1GHz, then the measurement results was added to a correction factor ($10 \log(1/\text{duty cycle})$).
4. The resolution bandwidth of test receiver/spectrum analyzer is 1MHz and the video bandwidth is 10Hz (Duty cycle $\geq 98\%$) for Average detection (AV) at frequency above 1GHz.
5. All modes of operation were investigated and the worst-case emissions are reported.

4.1.4 Deviation from Test Standard

No deviation.

4.1.5 Test Setup

<Frequency Range below 1GHz>

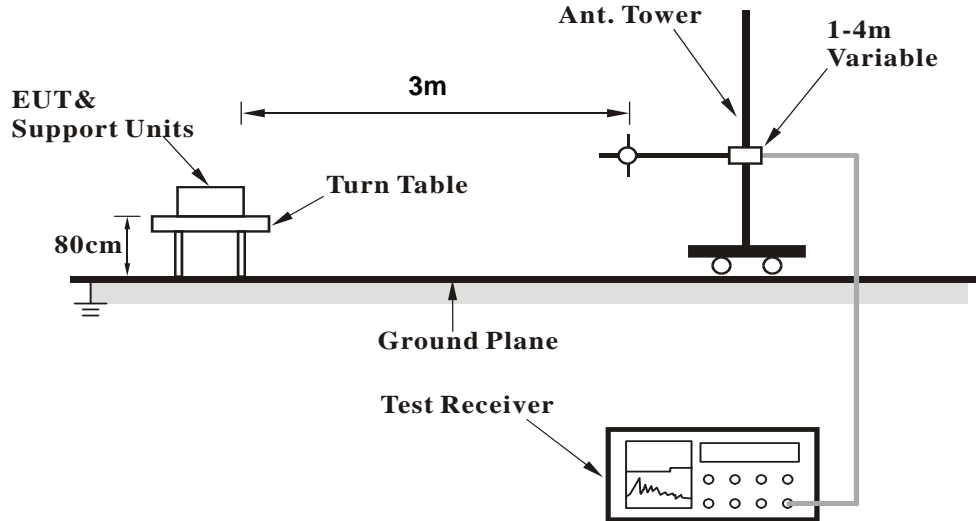

<Frequency Range above 1GHz>

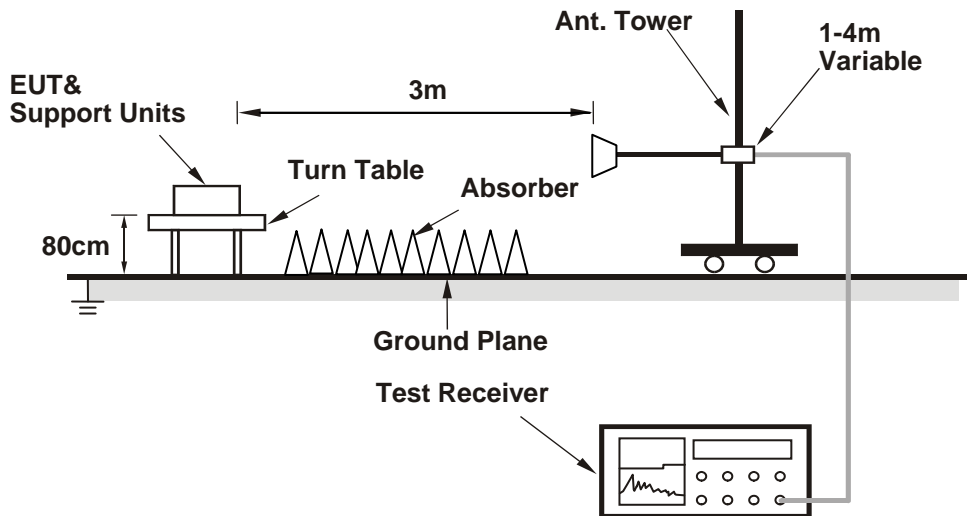

For the actual test configuration, please refer to the attached file (Test Setup Photo).

4.1.6 EUT Operating Conditions

1. Connect the EUT with the support unit A (Notebook computer) which is placed in remote site.
2. The communication partner run test program "MP_TEST.exe" to enable EUT under transmission/receiving condition continuously at specific channel frequency.

4.1.7 Test Results (Mode 1)

1TX Mode

Above 1GHz Data

802.11a

CHANNEL	TX Channel 36	DETECTOR FUNCTION	Peak (PK)
FREQUENCY RANGE	1GHz ~ 40GHz		Average (AV)

ANTENNA POLARITY & TEST DISTANCE: HORIZONTAL AT 3 M

NO.	FREQ. (MHz)	EMISSION LEVEL (dBuV/m)	LIMIT (dBuV/m)	MARGIN (dB)	ANTENNA HEIGHT (m)	TABLE ANGLE (Degree)	RAW VALUE (dBuV)	CORRECTION FACTOR (dB/m)
1	5150.00	58.3 PK	74.0	-15.7	1.01 H	261	51.70	6.60
2	5150.00	46.2 AV	54.0	-7.8	1.01 H	261	39.60	6.60
3	*5180.00	104.5 PK			1.00 H	245	97.71	6.79
4	*5180.00	94.8 AV			1.00 H	245	88.01	6.79
5	#10360.00	55.1 PK	74.0	-18.9	1.00 H	62	41.24	13.86
6	#10360.00	41.4 AV	54.0	-12.6	1.00 H	62	27.54	13.86
7	15540.00	58.5 PK	74.0	-15.5	1.00 H	269	39.35	19.15
8	15540.00	45.9 AV	54.0	-8.1	1.00 H	269	26.75	19.15

ANTENNA POLARITY & TEST DISTANCE: VERTICAL AT 3 M

NO.	FREQ. (MHz)	EMISSION LEVEL (dBuV/m)	LIMIT (dBuV/m)	MARGIN (dB)	ANTENNA HEIGHT (m)	TABLE ANGLE (Degree)	RAW VALUE (dBuV)	CORRECTION FACTOR (dB/m)
1	5150.00	69.5 PK	74.0	-4.5	1.00 V	17	62.90	6.60
2	5150.00	52.2 AV	54.0	-1.8	1.00 V	17	45.60	6.60
3	*5180.00	113.6 PK			1.00 V	17	106.81	6.79
4	*5180.00	104.4 AV			1.00 V	17	97.61	6.79
5	#10360.00	54.7 PK	74.0	-19.3	1.00 V	170	40.84	13.86
6	#10360.00	40.7 AV	54.0	-13.3	1.00 V	170	26.84	13.86
7	15540.00	58.5 PK	74.0	-15.5	1.00 V	117	39.35	19.15
8	15540.00	46.5 AV	54.0	-7.5	1.00 V	117	27.35	19.15

REMARKS:

1. Emission Level(dBuV/m) = Raw Value(dBuV) + Correction Factor(dB/m)
2. Correction Factor(dB/m) = Antenna Factor(dB/m) + Cable Factor(dB) – Pre-Amplifier Factor(dB)
3. The other emission levels were very low against the limit.
4. Margin value = Emission Level – Limit value
5. " * ": Fundamental frequency.
6. " # ": The radiated frequency is out of the restricted band.

CHANNEL	TX Channel 40	DETECTOR FUNCTION	Peak (PK)
FREQUENCY RANGE	1GHz ~ 40GHz		Average (AV)

ANTENNA POLARITY & TEST DISTANCE: HORIZONTAL AT 3 M

NO.	FREQ. (MHz)	EMISSION LEVEL (dBuV/m)	LIMIT (dBuV/m)	MARGIN (dB)	ANTENNA HEIGHT (m)	TABLE ANGLE (Degree)	RAW VALUE (dBuV)	CORRECTION FACTOR (dB/m)
1	*5200.00	105.0 PK			1.03 H	240	98.10	6.90
2	*5200.00	95.0 AV			1.03 H	240	88.10	6.90
3	#10400.00	54.3 PK	74.0	-19.7	1.02 H	95	40.42	13.88
4	#10400.00	40.7 AV	54.0	-13.3	1.02 H	95	26.82	13.88
5	15600.00	58.6 PK	74.0	-15.4	1.00 H	275	39.95	18.65
6	15600.00	46.0 AV	54.0	-8.0	1.00 H	275	27.35	18.65

ANTENNA POLARITY & TEST DISTANCE: VERTICAL AT 3 M

NO.	FREQ. (MHz)	EMISSION LEVEL (dBuV/m)	LIMIT (dBuV/m)	MARGIN (dB)	ANTENNA HEIGHT (m)	TABLE ANGLE (Degree)	RAW VALUE (dBuV)	CORRECTION FACTOR (dB/m)
1	*5200.00	112.4 PK			1.09 V	15	105.50	6.90
2	*5200.00	103.9 AV			1.09 V	15	97.00	6.90
3	#10400.00	54.6 PK	74.0	-19.4	1.00 V	158	40.72	13.88
4	#10400.00	40.6 AV	54.0	-13.4	1.00 V	158	26.72	13.88
5	15600.00	59.1 PK	74.0	-14.9	1.00 V	118	40.45	18.65
6	15600.00	46.7 AV	54.0	-7.3	1.00 V	118	28.05	18.65

REMARKS:

1. Emission Level(dBuV/m) = Raw Value(dBuV) + Correction Factor(dB/m)
2. Correction Factor(dB/m) = Antenna Factor(dB/m) + Cable Factor(dB) – Pre-Amplifier Factor(dB)
3. The other emission levels were very low against the limit.
4. Margin value = Emission Level – Limit value
5. " * ": Fundamental frequency.
6. " # ": The radiated frequency is out of the restricted band.

CHANNEL	TX Channel 48	DETECTOR FUNCTION	Peak (PK)
FREQUENCY RANGE	1GHz ~ 40GHz		Average (AV)

ANTENNA POLARITY & TEST DISTANCE: HORIZONTAL AT 3 M

NO.	FREQ. (MHz)	EMISSION LEVEL (dBuV/m)	LIMIT (dBuV/m)	MARGIN (dB)	ANTENNA HEIGHT (m)	TABLE ANGLE (Degree)	RAW VALUE (dBuV)	CORRECTION FACTOR (dB/m)
1	*5240.00	104.1 PK			1.00 H	231	97.14	6.96
2	*5240.00	94.2 AV			1.00 H	231	87.24	6.96
3	5350.00	50.0 PK	74.0	-24.0	1.11 H	51	42.82	7.18
4	5350.00	37.9 AV	54.0	-16.1	1.11 H	51	30.72	7.18
5	#10480.00	54.8 PK	74.0	-19.2	1.02 H	95	41.14	13.66
6	#10480.00	41.8 AV	54.0	-12.2	1.02 H	95	28.14	13.66
7	15720.00	58.6 PK	74.0	-15.4	1.00 H	272	39.42	19.18
8	15720.00	46.3 AV	54.0	-7.7	1.00 H	272	27.12	19.18

ANTENNA POLARITY & TEST DISTANCE: VERTICAL AT 3 M

NO.	FREQ. (MHz)	EMISSION LEVEL (dBuV/m)	LIMIT (dBuV/m)	MARGIN (dB)	ANTENNA HEIGHT (m)	TABLE ANGLE (Degree)	RAW VALUE (dBuV)	CORRECTION FACTOR (dB/m)
1	*5240.00	111.9 PK			1.09 V	15	104.94	6.96
2	*5240.00	103.7 AV			1.09 V	15	96.74	6.96
3	5350.00	53.8 PK	74.0	-20.2	1.09 V	15	46.62	7.18
4	5350.00	42.2 AV	54.0	-11.8	1.09 V	15	35.02	7.18
5	#10480.00	54.5 PK	74.0	-19.5	1.00 V	171	40.84	13.66
6	#10480.00	40.9 AV	54.0	-13.1	1.00 V	171	27.24	13.66
7	15720.00	59.3 PK	74.0	-14.7	1.00 V	137	40.12	19.18
8	15720.00	47.0 AV	54.0	-7.0	1.00 V	137	27.82	19.18

REMARKS:

1. Emission Level(dBuV/m) = Raw Value(dBuV) + Correction Factor(dB/m)
2. Correction Factor(dB/m) = Antenna Factor(dB/m) + Cable Factor(dB) – Pre-Amplifier Factor(dB)
3. The other emission levels were very low against the limit.
4. Margin value = Emission Level – Limit value
5. " * ": Fundamental frequency.
6. " # ": The radiated frequency is out of the restricted band.

CHANNEL	TX Channel 149	DETECTOR FUNCTION	Peak (PK)
FREQUENCY RANGE	1GHz ~ 40GHz		Average (AV)

ANTENNA POLARITY & TEST DISTANCE: HORIZONTAL AT 3 M

NO.	FREQ. (MHz)	EMISSION LEVEL (dBuV/m)	LIMIT (dBuV/m)	MARGIN (dB)	ANTENNA HEIGHT (m)	TABLE ANGLE (Degree)	RAW VALUE (dBuV)	CORRECTION FACTOR (dB/m)
1	#5715.00	53.8 PK	74.0	-20.2	1.00 H	54	45.88	7.92
2	#5715.00	40.5 AV	54.0	-13.5	1.00 H	54	32.58	7.92
3	#5725.00	65.1 PK	78.2	-13.1	1.00 H	70	57.16	7.94
4	*5745.00	100.9 PK			1.00 H	57	92.92	7.98
5	*5745.00	92.1 AV			1.00 H	57	84.12	7.98
6	11490.00	54.9 PK	74.0	-19.1	1.05 H	48	40.86	14.04
7	11490.00	41.4 AV	54.0	-12.6	1.05 H	48	27.36	14.04
8	#17235.00	60.8 PK	74.0	-13.2	1.00 H	179	37.06	23.74
9	#17235.00	48.4 AV	54.0	-5.6	1.00 H	179	24.66	23.74

ANTENNA POLARITY & TEST DISTANCE: VERTICAL AT 3 M

NO.	FREQ. (MHz)	EMISSION LEVEL (dBuV/m)	LIMIT (dBuV/m)	MARGIN (dB)	ANTENNA HEIGHT (m)	TABLE ANGLE (Degree)	RAW VALUE (dBuV)	CORRECTION FACTOR (dB/m)
1	#5715.00	63.2 PK	74.0	-10.8	1.12 V	262	55.28	7.92
2	#5715.00	48.9 AV	54.0	-5.1	1.12 V	262	40.98	7.92
3	#5725.00	73.2 PK	78.2	-5.0	1.12 V	262	65.26	7.94
4	*5745.00	110.3 PK			1.12 V	262	102.32	7.98
5	*5745.00	101.1 AV			1.12 V	262	93.12	7.98
6	11490.00	53.8 PK	74.0	-20.2	1.00 V	53	39.76	14.04
7	11490.00	40.8 AV	54.0	-13.2	1.00 V	53	26.76	14.04
8	#17235.00	59.8 PK	74.0	-14.2	1.00 V	198	36.06	23.74
9	#17235.00	49.1 AV	54.0	-4.9	1.00 V	198	25.36	23.74

REMARKS:

1. Emission Level(dBuV/m) = Raw Value(dBuV) + Correction Factor(dB/m)
2. Correction Factor(dB/m) = Antenna Factor(dB/m) + Cable Factor(dB) – Pre-Amplifier Factor(dB)
3. The other emission levels were very low against the limit.
4. Margin value = Emission Level – Limit value
5. " * ": Fundamental frequency.
6. " # ": The radiated frequency is out of the restricted band.

CHANNEL	TX Channel 157	DETECTOR FUNCTION	Peak (PK)
FREQUENCY RANGE	1GHz ~ 40GHz		Average (AV)

ANTENNA POLARITY & TEST DISTANCE: HORIZONTAL AT 3 M

NO.	FREQ. (MHz)	EMISSION LEVEL (dBuV/m)	LIMIT (dBuV/m)	MARGIN (dB)	ANTENNA HEIGHT (m)	TABLE ANGLE (Degree)	RAW VALUE (dBuV)	CORRECTION FACTOR (dB/m)
1	*5785.00	100.6 PK			1.00 H	45	92.55	8.05
2	*5785.00	92.0 AV			1.00 H	45	83.95	8.05
3	11570.00	55.1 PK	74.0	-18.9	1.07 H	41	40.89	14.21
4	11570.00	41.8 AV	54.0	-12.2	1.07 H	41	27.59	14.21
5	#17355.00	61.0 PK	74.0	-13.0	1.00 H	174	36.85	24.15
6	#17355.00	48.9 AV	54.0	-5.1	1.00 H	174	24.75	24.15

ANTENNA POLARITY & TEST DISTANCE: VERTICAL AT 3 M

NO.	FREQ. (MHz)	EMISSION LEVEL (dBuV/m)	LIMIT (dBuV/m)	MARGIN (dB)	ANTENNA HEIGHT (m)	TABLE ANGLE (Degree)	RAW VALUE (dBuV)	CORRECTION FACTOR (dB/m)
1	*5785.00	109.7 PK			1.11 V	271	101.65	8.05
2	*5785.00	101.3 AV			1.11 V	271	93.25	8.05
3	11570.00	53.7 PK	74.0	-20.3	1.00 V	50	39.49	14.21
4	11570.00	40.6 AV	54.0	-13.4	1.00 V	50	26.39	14.21
5	#17355.00	60.1 PK	74.0	-13.9	1.00 V	200	35.95	24.15
6	#17355.00	49.4 AV	54.0	-4.6	1.00 V	200	25.25	24.15

REMARKS:

1. Emission Level(dBuV/m) = Raw Value(dBuV) + Correction Factor(dB/m)
2. Correction Factor(dB/m) = Antenna Factor(dB/m) + Cable Factor(dB) – Pre-Amplifier Factor(dB)
3. The other emission levels were very low against the limit.
4. Margin value = Emission Level – Limit value
5. " * ": Fundamental frequency.
6. " # ": The radiated frequency is out of the restricted band.

CHANNEL	TX Channel 165	DETECTOR FUNCTION	Peak (PK)
FREQUENCY RANGE	1GHz ~ 40GHz		Average (AV)

ANTENNA POLARITY & TEST DISTANCE: HORIZONTAL AT 3 M

NO.	FREQ. (MHz)	EMISSION LEVEL (dBuV/m)	LIMIT (dBuV/m)	MARGIN (dB)	ANTENNA HEIGHT (m)	TABLE ANGLE (Degree)	RAW VALUE (dBuV)	CORRECTION FACTOR (dB/m)
1	*5825.00	100.5 PK			1.00 H	59	92.45	8.05
2	*5825.00	91.9 AV			1.00 H	59	83.85	8.05
3	#5850.00	64.8 PK	78.2	-13.4	1.00 H	73	56.76	8.04
4	#5860.00	53.5 PK	74.0	-20.5	1.00 H	47	45.47	8.03
5	#5860.00	40.4 AV	54.0	-13.6	1.00 H	47	32.37	8.03
6	11650.00	54.7 PK	74.0	-19.3	1.02 H	47	40.25	14.45
7	11650.00	41.1 AV	54.0	-12.9	1.02 H	47	26.65	14.45
8	#17475.00	60.4 PK	74.0	-13.6	1.00 H	161	36.18	24.22
9	#17475.00	48.0 AV	54.0	-6.0	1.00 H	161	23.78	24.22

ANTENNA POLARITY & TEST DISTANCE: VERTICAL AT 3 M

NO.	FREQ. (MHz)	EMISSION LEVEL (dBuV/m)	LIMIT (dBuV/m)	MARGIN (dB)	ANTENNA HEIGHT (m)	TABLE ANGLE (Degree)	RAW VALUE (dBuV)	CORRECTION FACTOR (dB/m)
1	*5825.00	110.8 PK			1.12 V	262	102.75	8.05
2	*5825.00	101.5 AV			1.12 V	262	93.45	8.05
3	#5850.00	66.4 PK	78.2	-11.8	1.12 V	262	58.36	8.04
4	#5860.00	58.9 PK	74.0	-15.1	1.12 V	262	50.87	8.03
5	#5860.00	45.6 AV	54.0	-8.4	1.12 V	262	37.57	8.03
6	11650.00	53.4 PK	74.0	-20.6	1.00 V	41	38.95	14.45
7	11650.00	40.6 AV	54.0	-13.4	1.00 V	41	26.15	14.45
8	#17475.00	59.4 PK	74.0	-14.6	1.00 V	199	35.18	24.22
9	#17475.00	49.0 AV	54.0	-5.0	1.00 V	199	24.78	24.22

REMARKS:

1. Emission Level(dBuV/m) = Raw Value(dBuV) + Correction Factor(dB/m)
2. Correction Factor(dB/m) = Antenna Factor(dB/m) + Cable Factor(dB) – Pre-Amplifier Factor(dB)
3. The other emission levels were very low against the limit.
4. Margin value = Emission Level – Limit value
5. " * ": Fundamental frequency.
6. " # ": The radiated frequency is out of the restricted band.

802.11ac (VHT20)

CHANNEL	TX Channel 36	DETECTOR FUNCTION	Peak (PK)
FREQUENCY RANGE	1GHz ~ 40GHz		Average (AV)

ANTENNA POLARITY & TEST DISTANCE: HORIZONTAL AT 3 M

NO.	FREQ. (MHz)	EMISSION LEVEL (dBuV/m)	LIMIT (dBuV/m)	MARGIN (dB)	ANTENNA HEIGHT (m)	TABLE ANGLE (Degree)	RAW VALUE (dBuV)	CORRECTION FACTOR (dB/m)
1	5150.00	57.2 PK	74.0	-16.8	1.06 H	258	50.60	6.60
2	5150.00	45.4 AV	54.0	-8.6	1.06 H	258	38.80	6.60
3	*5180.00	104.9 PK			1.05 H	246	98.11	6.79
4	*5180.00	95.0 AV			1.05 H	246	88.21	6.79
5	#10360.00	53.9 PK	74.0	-20.1	1.00 H	87	40.04	13.86
6	#10360.00	40.5 AV	54.0	-13.5	1.00 H	87	26.64	13.86
7	15540.00	58.2 PK	74.0	-15.8	1.00 H	275	39.05	19.15
8	15540.00	46.1 AV	54.0	-7.9	1.00 H	275	26.95	19.15

ANTENNA POLARITY & TEST DISTANCE: VERTICAL AT 3 M

NO.	FREQ. (MHz)	EMISSION LEVEL (dBuV/m)	LIMIT (dBuV/m)	MARGIN (dB)	ANTENNA HEIGHT (m)	TABLE ANGLE (Degree)	RAW VALUE (dBuV)	CORRECTION FACTOR (dB/m)
1	5150.00	69.1 PK	74.0	-4.9	1.00 V	24	62.50	6.60
2	5150.00	51.9 AV	54.0	-2.1	1.00 V	24	45.30	6.60
3	*5180.00	113.5 PK			1.00 V	0	106.71	6.79
4	*5180.00	104.5 AV			1.00 V	0	97.71	6.79
5	#10360.00	55.1 PK	74.0	-18.9	1.00 V	180	41.24	13.86
6	#10360.00	40.8 AV	54.0	-13.2	1.00 V	180	26.94	13.86
7	15540.00	58.6 PK	74.0	-15.4	1.00 V	131	39.45	19.15
8	15540.00	46.5 AV	54.0	-7.5	1.00 V	131	27.35	19.15

REMARKS:

1. Emission Level(dBuV/m) = Raw Value(dBuV) + Correction Factor(dB/m)
2. Correction Factor(dB/m) = Antenna Factor(dB/m) + Cable Factor(dB) – Pre-Amplifier Factor(dB)
3. The other emission levels were very low against the limit.
4. Margin value = Emission Level – Limit value
5. " * ": Fundamental frequency.
6. " # ": The radiated frequency is out of the restricted band.

CHANNEL	TX Channel 40	DETECTOR FUNCTION	Peak (PK)
FREQUENCY RANGE	1GHz ~ 40GHz		Average (AV)

ANTENNA POLARITY & TEST DISTANCE: HORIZONTAL AT 3 M

NO.	FREQ. (MHz)	EMISSION LEVEL (dBuV/m)	LIMIT (dBuV/m)	MARGIN (dB)	ANTENNA HEIGHT (m)	TABLE ANGLE (Degree)	RAW VALUE (dBuV)	CORRECTION FACTOR (dB/m)
1	*5200.00	104.1 PK			1.00 H	251	97.20	6.90
2	*5200.00	94.4 AV			1.00 H	251	87.50	6.90
3	#10400.00	54.6 PK	74.0	-19.4	1.00 H	86	40.72	13.88
4	#10400.00	41.5 AV	54.0	-12.5	1.00 H	86	27.62	13.88
5	15600.00	58.4 PK	74.0	-15.6	1.01 H	277	39.75	18.65
6	15600.00	46.2 AV	54.0	-7.8	1.01 H	277	27.55	18.65

ANTENNA POLARITY & TEST DISTANCE: VERTICAL AT 3 M

NO.	FREQ. (MHz)	EMISSION LEVEL (dBuV/m)	LIMIT (dBuV/m)	MARGIN (dB)	ANTENNA HEIGHT (m)	TABLE ANGLE (Degree)	RAW VALUE (dBuV)	CORRECTION FACTOR (dB/m)
1	*5200.00	112.2 PK			1.03 V	19	105.30	6.90
2	*5200.00	103.7 AV			1.03 V	19	96.80	6.90
3	#10400.00	54.1 PK	74.0	-19.9	1.00 V	179	40.22	13.88
4	#10400.00	40.1 AV	54.0	-13.9	1.00 V	179	26.22	13.88
5	15600.00	59.0 PK	74.0	-15.0	1.00 V	116	40.35	18.65
6	15600.00	47.0 AV	54.0	-7.0	1.00 V	116	28.35	18.65

REMARKS:

1. Emission Level(dBuV/m) = Raw Value(dBuV) + Correction Factor(dB/m)
2. Correction Factor(dB/m) = Antenna Factor(dB/m) + Cable Factor(dB) – Pre-Amplifier Factor(dB)
3. The other emission levels were very low against the limit.
4. Margin value = Emission Level – Limit value
5. " * ": Fundamental frequency.
6. " # ": The radiated frequency is out of the restricted band.

CHANNEL	TX Channel 48	DETECTOR FUNCTION	Peak (PK)
FREQUENCY RANGE	1GHz ~ 40GHz		Average (AV)

ANTENNA POLARITY & TEST DISTANCE: HORIZONTAL AT 3 M

NO.	FREQ. (MHz)	EMISSION LEVEL (dBuV/m)	LIMIT (dBuV/m)	MARGIN (dB)	ANTENNA HEIGHT (m)	TABLE ANGLE (Degree)	RAW VALUE (dBuV)	CORRECTION FACTOR (dB/m)
1	*5240.00	104.5 PK			1.00 H	238	97.54	6.96
2	*5240.00	94.1 AV			1.00 H	238	87.14	6.96
3	5350.00	49.5 PK	74.0	-24.5	1.10 H	60	42.32	7.18
4	5350.00	37.6 AV	54.0	-16.4	1.10 H	60	30.42	7.18
5	#10480.00	54.8 PK	74.0	-19.2	1.00 H	94	41.14	13.66
6	#10480.00	41.6 AV	54.0	-12.4	1.00 H	94	27.94	13.66
7	15720.00	58.1 PK	74.0	-15.9	1.00 H	291	38.92	19.18
8	15720.00	46.2 AV	54.0	-7.8	1.00 H	291	27.02	19.18

ANTENNA POLARITY & TEST DISTANCE: VERTICAL AT 3 M

NO.	FREQ. (MHz)	EMISSION LEVEL (dBuV/m)	LIMIT (dBuV/m)	MARGIN (dB)	ANTENNA HEIGHT (m)	TABLE ANGLE (Degree)	RAW VALUE (dBuV)	CORRECTION FACTOR (dB/m)
1	*5240.00	111.4 PK			1.05 V	15	104.44	6.96
2	*5240.00	103.2 AV			1.05 V	15	96.24	6.96
3	5350.00	54.3 PK	74.0	-19.7	1.05 V	15	47.12	7.18
4	5350.00	42.5 AV	54.0	-11.5	1.05 V	15	35.32	7.18
5	#10480.00	54.4 PK	74.0	-19.6	1.00 V	190	40.74	13.66
6	#10480.00	40.6 AV	54.0	-13.4	1.00 V	190	26.94	13.66
7	15720.00	59.5 PK	74.0	-14.5	1.00 V	125	40.32	19.18
8	15720.00	47.6 AV	54.0	-6.4	1.00 V	125	28.42	19.18

REMARKS:

1. Emission Level(dBuV/m) = Raw Value(dBuV) + Correction Factor(dB/m)
2. Correction Factor(dB/m) = Antenna Factor(dB/m) + Cable Factor(dB) – Pre-Amplifier Factor(dB)
3. The other emission levels were very low against the limit.
4. Margin value = Emission Level – Limit value
5. " * ": Fundamental frequency.
6. " # ": The radiated frequency is out of the restricted band.

CHANNEL	TX Channel 149	DETECTOR FUNCTION	Peak (PK)
FREQUENCY RANGE	1GHz ~ 40GHz		Average (AV)

ANTENNA POLARITY & TEST DISTANCE: HORIZONTAL AT 3 M

NO.	FREQ. (MHz)	EMISSION LEVEL (dBuV/m)	LIMIT (dBuV/m)	MARGIN (dB)	ANTENNA HEIGHT (m)	TABLE ANGLE (Degree)	RAW VALUE (dBuV)	CORRECTION FACTOR (dB/m)
1	#5715.00	54.1 PK	74.0	-19.9	1.00 H	25	46.18	7.92
2	#5715.00	40.8 AV	54.0	-13.2	1.00 H	25	32.88	7.92
3	#5725.00	65.8 PK	78.2	-12.4	1.00 H	80	57.86	7.94
4	*5745.00	100.3 PK			1.00 H	72	92.32	7.98
5	*5745.00	91.8 AV			1.00 H	72	83.82	7.98
6	11490.00	55.1 PK	74.0	-18.9	1.01 H	34	41.06	14.04
7	11490.00	41.8 AV	54.0	-12.2	1.01 H	34	27.76	14.04
8	#17235.00	61.0 PK	74.0	-13.0	1.00 H	180	37.26	23.74
9	#17235.00	48.3 AV	54.0	-5.7	1.00 H	180	24.56	23.74

ANTENNA POLARITY & TEST DISTANCE: VERTICAL AT 3 M

NO.	FREQ. (MHz)	EMISSION LEVEL (dBuV/m)	LIMIT (dBuV/m)	MARGIN (dB)	ANTENNA HEIGHT (m)	TABLE ANGLE (Degree)	RAW VALUE (dBuV)	CORRECTION FACTOR (dB/m)
1	#5715.00	63.1 PK	74.0	-10.9	1.03 V	271	55.18	7.92
2	#5715.00	48.8 AV	54.0	-5.2	1.03 V	271	40.88	7.92
3	#5725.00	72.5 PK	78.2	-5.7	1.13 V	265	64.56	7.94
4	*5745.00	110.5 PK			1.14 V	273	102.52	7.98
5	*5745.00	101.2 AV			1.14 V	273	93.22	7.98
6	11490.00	54.4 PK	74.0	-19.6	1.00 V	44	40.36	14.04
7	11490.00	41.2 AV	54.0	-12.8	1.00 V	44	27.16	14.04
8	#17235.00	59.4 PK	74.0	-14.6	1.00 V	178	35.66	23.74
9	#17235.00	49.0 AV	54.0	-5.0	1.00 V	178	25.26	23.74

REMARKS:

1. Emission Level(dBuV/m) = Raw Value(dBuV) + Correction Factor(dB/m)
2. Correction Factor(dB/m) = Antenna Factor(dB/m) + Cable Factor(dB) – Pre-Amplifier Factor(dB)
3. The other emission levels were very low against the limit.
4. Margin value = Emission Level – Limit value
5. " * ": Fundamental frequency.
6. " # ": The radiated frequency is out of the restricted band.

CHANNEL	TX Channel 157	DETECTOR FUNCTION	Peak (PK)
FREQUENCY RANGE	1GHz ~ 40GHz		Average (AV)

ANTENNA POLARITY & TEST DISTANCE: HORIZONTAL AT 3 M

NO.	FREQ. (MHz)	EMISSION LEVEL (dBuV/m)	LIMIT (dBuV/m)	MARGIN (dB)	ANTENNA HEIGHT (m)	TABLE ANGLE (Degree)	RAW VALUE (dBuV)	CORRECTION FACTOR (dB/m)
1	*5785.00	100.9 PK			1.00 H	45	92.85	8.05
2	*5785.00	92.0 AV			1.00 H	45	83.95	8.05
3	11570.00	54.6 PK	74.0	-19.4	1.00 H	61	40.39	14.21
4	11570.00	41.4 AV	54.0	-12.6	1.00 H	61	27.19	14.21
5	#17355.00	60.6 PK	74.0	-13.4	1.00 H	176	36.45	24.15
6	#17355.00	48.5 AV	54.0	-5.5	1.00 H	176	24.35	24.15

ANTENNA POLARITY & TEST DISTANCE: VERTICAL AT 3 M

NO.	FREQ. (MHz)	EMISSION LEVEL (dBuV/m)	LIMIT (dBuV/m)	MARGIN (dB)	ANTENNA HEIGHT (m)	TABLE ANGLE (Degree)	RAW VALUE (dBuV)	CORRECTION FACTOR (dB/m)
1	*5785.00	109.9 PK			1.13 V	259	101.85	8.05
2	*5785.00	101.2 AV			1.13 V	259	93.15	8.05
3	11570.00	53.5 PK	74.0	-20.5	1.00 V	36	39.29	14.21
4	11570.00	40.6 AV	54.0	-13.4	1.00 V	36	26.39	14.21
5	#17355.00	59.7 PK	74.0	-14.3	1.00 V	193	35.55	24.15
6	#17355.00	49.3 AV	54.0	-4.7	1.00 V	193	25.15	24.15

REMARKS:

1. Emission Level(dBuV/m) = Raw Value(dBuV) + Correction Factor(dB/m)
2. Correction Factor(dB/m) = Antenna Factor(dB/m) + Cable Factor(dB) – Pre-Amplifier Factor(dB)
3. The other emission levels were very low against the limit.
4. Margin value = Emission Level – Limit value
5. " * ": Fundamental frequency.
6. " # ": The radiated frequency is out of the restricted band.

CHANNEL	TX Channel 165	DETECTOR FUNCTION	Peak (PK)
FREQUENCY RANGE	1GHz ~ 40GHz		Average (AV)

ANTENNA POLARITY & TEST DISTANCE: HORIZONTAL AT 3 M

NO.	FREQ. (MHz)	EMISSION LEVEL (dBuV/m)	LIMIT (dBuV/m)	MARGIN (dB)	ANTENNA HEIGHT (m)	TABLE ANGLE (Degree)	RAW VALUE (dBuV)	CORRECTION FACTOR (dB/m)
1	*5825.00	101.0 PK			1.00 H	44	92.95	8.05
2	*5825.00	92.2 AV			1.00 H	44	84.15	8.05
3	#5850.00	52.1 PK	78.2	-26.1	1.00 H	59	44.06	8.04
4	#5860.00	52.8 PK	74.0	-21.2	1.00 H	53	44.77	8.03
5	#5860.00	39.7 AV	54.0	-14.3	1.00 H	53	31.67	8.03
6	11650.00	54.8 PK	74.0	-19.2	1.00 H	33	40.35	14.45
7	11650.00	41.6 AV	54.0	-12.4	1.00 H	33	27.15	14.45
8	#17475.00	60.9 PK	74.0	-13.1	1.00 H	191	36.68	24.22
9	#17475.00	48.7 AV	54.0	-5.3	1.00 H	191	24.48	24.22

ANTENNA POLARITY & TEST DISTANCE: VERTICAL AT 3 M

NO.	FREQ. (MHz)	EMISSION LEVEL (dBuV/m)	LIMIT (dBuV/m)	MARGIN (dB)	ANTENNA HEIGHT (m)	TABLE ANGLE (Degree)	RAW VALUE (dBuV)	CORRECTION FACTOR (dB/m)
1	*5825.00	109.5 PK			1.00 V	264	101.45	8.05
2	*5825.00	100.3 AV			1.00 V	264	92.25	8.05
3	#5850.00	65.8 PK	78.2	-12.4	1.08 V	255	57.76	8.04
4	#5860.00	58.9 PK	74.0	-15.1	1.08 V	265	50.87	8.03
5	#5860.00	45.6 AV	54.0	-8.4	1.08 V	265	37.57	8.03
6	11650.00	53.4 PK	74.0	-20.6	1.00 V	42	38.95	14.45
7	11650.00	40.3 AV	54.0	-13.7	1.00 V	42	25.85	14.45
8	#17475.00	58.8 PK	74.0	-15.2	1.00 V	214	34.58	24.22
9	#17475.00	48.3 AV	54.0	-5.7	1.00 V	214	24.08	24.22

REMARKS:

1. Emission Level(dBuV/m) = Raw Value(dBuV) + Correction Factor(dB/m)
2. Correction Factor(dB/m) = Antenna Factor(dB/m) + Cable Factor(dB) – Pre-Amplifier Factor(dB)
3. The other emission levels were very low against the limit.
4. Margin value = Emission Level – Limit value
5. " * ": Fundamental frequency.
6. " # ": The radiated frequency is out of the restricted band.

802.11ac (VHT40)

CHANNEL	TX Channel 38	DETECTOR FUNCTION	Peak (PK)
FREQUENCY RANGE	1GHz ~ 40GHz		Average (AV)

ANTENNA POLARITY & TEST DISTANCE: HORIZONTAL AT 3 M								
NO.	FREQ. (MHz)	EMISSION LEVEL (dBuV/m)	LIMIT (dBuV/m)	MARGIN (dB)	ANTENNA HEIGHT (m)	TABLE ANGLE (Degree)	RAW VALUE (dBuV)	CORRECTION FACTOR (dB/m)
1	5150.00	58.1 PK	74.0	-15.9	1.02 H	255	51.50	6.60
2	5150.00	46.0 AV	54.0	-8.0	1.02 H	255	39.40	6.60
3	*5190.00	94.1 PK			1.00 H	239	87.26	6.84
4	*5190.00	85.6 AV			1.00 H	239	78.76	6.84
5	#10380.00	54.7 PK	74.0	-19.3	1.00 H	78	40.83	13.87
6	#10380.00	41.4 AV	54.0	-12.6	1.00 H	78	27.53	13.87
7	15570.00	58.9 PK	74.0	-15.1	1.00 H	263	40.00	18.90
8	15570.00	46.4 AV	54.0	-7.6	1.00 H	263	27.50	18.90

ANTENNA POLARITY & TEST DISTANCE: VERTICAL AT 3 M								
NO.	FREQ. (MHz)	EMISSION LEVEL (dBuV/m)	LIMIT (dBuV/m)	MARGIN (dB)	ANTENNA HEIGHT (m)	TABLE ANGLE (Degree)	RAW VALUE (dBuV)	CORRECTION FACTOR (dB/m)
1	5150.00	66.9 PK	74.0	-7.1	1.00 V	17	60.30	6.60
2	5150.00	53.6 AV	54.0	-0.4	1.00 V	17	47.00	6.60
3	*5190.00	103.7 PK			1.09 V	13	96.86	6.84
4	*5190.00	94.8 AV			1.09 V	13	87.96	6.84
5	#10380.00	54.4 PK	74.0	-19.6	1.00 V	180	40.53	13.87
6	#10380.00	40.9 AV	54.0	-13.1	1.00 V	180	27.03	13.87
7	15570.00	58.8 PK	74.0	-15.2	1.00 V	89	39.90	18.90
8	15570.00	46.9 AV	54.0	-7.1	1.00 V	89	28.00	18.90

REMARKS:

1. Emission Level(dBuV/m) = Raw Value(dBuV) + Correction Factor(dB/m)
2. Correction Factor(dB/m) = Antenna Factor(dB/m) + Cable Factor(dB) – Pre-Amplifier Factor(dB)
3. The other emission levels were very low against the limit.
4. Margin value = Emission Level – Limit value
5. " * ": Fundamental frequency.
6. " # ": The radiated frequency is out of the restricted band.

CHANNEL	TX Channel 46	DETECTOR FUNCTION	Peak (PK)
FREQUENCY RANGE	1GHz ~ 40GHz		Average (AV)

ANTENNA POLARITY & TEST DISTANCE: HORIZONTAL AT 3 M

NO.	FREQ. (MHz)	EMISSION LEVEL (dBuV/m)	LIMIT (dBuV/m)	MARGIN (dB)	ANTENNA HEIGHT (m)	TABLE ANGLE (Degree)	RAW VALUE (dBuV)	CORRECTION FACTOR (dB/m)
1	*5230.00	99.5 PK			1.00 H	216	92.55	6.95
2	*5230.00	88.4 AV			1.00 H	216	81.45	6.95
3	5350.00	48.7 PK	74.0	-25.3	1.11 H	63	41.52	7.18
4	5350.00	36.8 AV	54.0	-17.2	1.11 H	63	29.62	7.18
5	#10460.00	55.2 PK	74.0	-18.8	1.00 H	85	41.49	13.71
6	#10460.00	41.7 AV	54.0	-12.3	1.00 H	85	27.99	13.71
7	15690.00	58.0 PK	74.0	-16.0	1.00 H	286	38.94	19.06
8	15690.00	45.9 AV	54.0	-8.1	1.00 H	286	26.84	19.06

ANTENNA POLARITY & TEST DISTANCE: VERTICAL AT 3 M

NO.	FREQ. (MHz)	EMISSION LEVEL (dBuV/m)	LIMIT (dBuV/m)	MARGIN (dB)	ANTENNA HEIGHT (m)	TABLE ANGLE (Degree)	RAW VALUE (dBuV)	CORRECTION FACTOR (dB/m)
1	*5230.00	108.1 PK			1.00 V	13	101.15	6.95
2	*5230.00	97.9 AV			1.00 V	13	90.95	6.95
3	5350.00	54.9 PK	74.0	-19.1	1.00 V	13	47.72	7.18
4	5350.00	42.6 AV	54.0	-11.4	1.00 V	13	35.42	7.18
5	#10460.00	54.8 PK	74.0	-19.2	1.00 V	196	41.09	13.71
6	#10460.00	40.7 AV	54.0	-13.3	1.00 V	196	26.99	13.71
7	15690.00	59.1 PK	74.0	-14.9	1.01 V	130	40.04	19.06
8	15690.00	47.0 AV	54.0	-7.0	1.01 V	130	27.94	19.06

REMARKS:

1. Emission Level(dBuV/m) = Raw Value(dBuV) + Correction Factor(dB/m)
2. Correction Factor(dB/m) = Antenna Factor(dB/m) + Cable Factor(dB) – Pre-Amplifier Factor(dB)
3. The other emission levels were very low against the limit.
4. Margin value = Emission Level – Limit value
5. " * ": Fundamental frequency.
6. " # ": The radiated frequency is out of the restricted band.

CHANNEL	TX Channel 151	DETECTOR FUNCTION	Peak (PK)
FREQUENCY RANGE	1GHz ~ 40GHz		Average (AV)

ANTENNA POLARITY & TEST DISTANCE: HORIZONTAL AT 3 M

NO.	FREQ. (MHz)	EMISSION LEVEL (dBuV/m)	LIMIT (dBuV/m)	MARGIN (dB)	ANTENNA HEIGHT (m)	TABLE ANGLE (Degree)	RAW VALUE (dBuV)	CORRECTION FACTOR (dB/m)
1	#5715.00	57.6 PK	74.0	-16.4	1.00 H	47	49.68	7.92
2	#5715.00	45.6 AV	54.0	-8.4	1.00 H	47	37.68	7.92
3	#5725.00	64.0 PK	78.2	-14.2	1.00 H	50	56.06	7.94
4	*5755.00	96.8 PK			1.00 H	30	88.81	7.99
5	*5755.00	87.4 AV			1.00 H	30	79.41	7.99
6	11510.00	54.4 PK	74.0	-19.6	1.02 H	46	40.38	14.02
7	11510.00	40.9 AV	54.0	-13.1	1.02 H	46	26.88	14.02
8	#17265.00	61.0 PK	74.0	-13.0	1.00 H	182	37.47	23.53
9	#17265.00	48.7 AV	54.0	-5.3	1.00 H	182	25.17	23.53

ANTENNA POLARITY & TEST DISTANCE: VERTICAL AT 3 M

NO.	FREQ. (MHz)	EMISSION LEVEL (dBuV/m)	LIMIT (dBuV/m)	MARGIN (dB)	ANTENNA HEIGHT (m)	TABLE ANGLE (Degree)	RAW VALUE (dBuV)	CORRECTION FACTOR (dB/m)
1	#5715.00	67.8 PK	74.0	-6.2	1.13 V	261	59.88	7.92
2	#5715.00	53.2 AV	54.0	-0.8	1.13 V	261	45.28	7.92
3	#5725.00	70.1 PK	78.2	-8.1	1.13 V	261	62.16	7.94
4	*5755.00	106.3 PK			1.13 V	261	98.31	7.99
5	*5755.00	96.7 AV			1.13 V	261	88.71	7.99
6	11510.00	53.9 PK	74.0	-20.1	1.00 V	61	39.88	14.02
7	11510.00	41.0 AV	54.0	-13.0	1.00 V	61	26.98	14.02
8	#17265.00	58.8 PK	74.0	-15.2	1.00 V	185	35.27	23.53
9	#17265.00	48.1 AV	54.0	-5.9	1.00 V	185	24.57	23.53

REMARKS:

1. Emission Level(dBuV/m) = Raw Value(dBuV) + Correction Factor(dB/m)
2. Correction Factor(dB/m) = Antenna Factor(dB/m) + Cable Factor(dB) – Pre-Amplifier Factor(dB)
3. The other emission levels were very low against the limit.
4. Margin value = Emission Level – Limit value
5. " * ": Fundamental frequency.
6. " # ": The radiated frequency is out of the restricted band.

CHANNEL	TX Channel 159	DETECTOR FUNCTION	Peak (PK)
FREQUENCY RANGE	1GHz ~ 40GHz		Average (AV)

ANTENNA POLARITY & TEST DISTANCE: HORIZONTAL AT 3 M

NO.	FREQ. (MHz)	EMISSION LEVEL (dBuV/m)	LIMIT (dBuV/m)	MARGIN (dB)	ANTENNA HEIGHT (m)	TABLE ANGLE (Degree)	RAW VALUE (dBuV)	CORRECTION FACTOR (dB/m)
1	*5795.00	98.1 PK			1.00 H	42	90.03	8.07
2	*5795.00	89.8 AV			1.00 H	42	81.73	8.07
3	#5850.00	53.0 PK	78.2	-25.2	1.00 H	39	44.96	8.04
4	#5860.00	52.6 PK	74.0	-21.4	1.00 H	54	44.57	8.03
5	#5860.00	39.8 AV	54.0	-14.2	1.00 H	54	31.77	8.03
6	11590.00	54.3 PK	74.0	-19.7	1.00 H	50	40.01	14.29
7	11590.00	41.0 AV	54.0	-13.0	1.00 H	50	26.71	14.29
8	#17385.00	60.5 PK	74.0	-13.5	1.00 H	193	35.89	24.61
9	#17385.00	48.7 AV	54.0	-5.3	1.00 H	193	24.09	24.61

ANTENNA POLARITY & TEST DISTANCE: VERTICAL AT 3 M

NO.	FREQ. (MHz)	EMISSION LEVEL (dBuV/m)	LIMIT (dBuV/m)	MARGIN (dB)	ANTENNA HEIGHT (m)	TABLE ANGLE (Degree)	RAW VALUE (dBuV)	CORRECTION FACTOR (dB/m)
1	*5795.00	107.8 PK			1.11 V	262	99.73	8.07
2	*5795.00	98.2 AV			1.11 V	262	90.13	8.07
3	#5850.00	61.2 PK	78.2	-17.0	1.11 V	262	53.16	8.04
4	#5860.00	57.9 PK	74.0	-16.1	1.10 V	262	49.87	8.03
5	#5860.00	45.7 AV	54.0	-8.3	1.10 V	262	37.67	8.03
6	11590.00	53.7 PK	74.0	-20.3	1.00 V	54	39.41	14.29
7	11590.00	40.5 AV	54.0	-13.5	1.00 V	54	26.21	14.29
8	#17385.00	59.8 PK	74.0	-14.2	1.00 V	200	35.19	24.61
9	#17385.00	49.2 AV	54.0	-4.8	1.00 V	200	24.59	24.61

REMARKS:

1. Emission Level(dBuV/m) = Raw Value(dBuV) + Correction Factor(dB/m)
2. Correction Factor(dB/m) = Antenna Factor(dB/m) + Cable Factor(dB) – Pre-Amplifier Factor(dB)
3. The other emission levels were very low against the limit.
4. Margin value = Emission Level – Limit value
5. " * ": Fundamental frequency.
6. " # ": The radiated frequency is out of the restricted band.

802.11ac (VHT80)

CHANNEL	TX Channel 42	DETECTOR FUNCTION	Peak (PK)
FREQUENCY RANGE	1GHz ~ 40GHz		Average (AV)

ANTENNA POLARITY & TEST DISTANCE: HORIZONTAL AT 3 M

NO.	FREQ. (MHz)	EMISSION LEVEL (dBuV/m)	LIMIT (dBuV/m)	MARGIN (dB)	ANTENNA HEIGHT (m)	TABLE ANGLE (Degree)	RAW VALUE (dBuV)	CORRECTION FACTOR (dB/m)
1	5150.00	57.9 PK	74.0	-16.1	1.04 H	255	51.30	6.60
2	5150.00	45.7 AV	54.0	-8.3	1.04 H	255	39.10	6.60
3	*5210.00	92.0 PK			1.00 H	214	85.09	6.91
4	*5210.00	83.1 AV			1.00 H	214	76.19	6.91
5	5350.00	49.6 PK	74.0	-24.4	1.08 H	46	42.42	7.18
6	5350.00	37.7 AV	54.0	-16.3	1.08 H	46	30.52	7.18
7	#10420.00	53.9 PK	74.0	-20.1	1.00 H	66	40.09	13.81
8	#10420.00	40.9 AV	54.0	-13.1	1.00 H	66	27.09	13.81
9	15630.00	58.6 PK	74.0	-15.4	1.00 H	286	39.81	18.79
10	15630.00	46.4 AV	54.0	-7.6	1.00 H	286	27.61	18.79

ANTENNA POLARITY & TEST DISTANCE: VERTICAL AT 3 M

NO.	FREQ. (MHz)	EMISSION LEVEL (dBuV/m)	LIMIT (dBuV/m)	MARGIN (dB)	ANTENNA HEIGHT (m)	TABLE ANGLE (Degree)	RAW VALUE (dBuV)	CORRECTION FACTOR (dB/m)
1	5150.00	67.5 PK	74.0	-6.5	1.00 V	16	60.90	6.60
2	5150.00	53.9 AV	54.0	-0.1	1.00 V	16	47.30	6.60
3	*5210.00	101.8 PK			1.00 V	16	94.89	6.91
4	*5210.00	92.4 AV			1.00 V	16	85.49	6.91
5	5350.00	55.2 PK	74.0	-18.8	1.00 V	16	48.02	7.18
6	5350.00	42.6 AV	54.0	-11.4	1.00 V	16	35.42	7.18
7	#10420.00	55.1 PK	74.0	-18.9	1.00 V	181	41.29	13.81
8	#10420.00	40.9 AV	54.0	-13.1	1.00 V	181	27.09	13.81
9	15630.00	58.7 PK	74.0	-15.3	1.00 V	126	39.91	18.79
10	15630.00	47.2 AV	54.0	-6.8	1.00 V	126	28.41	18.79

REMARKS:

- Emission Level(dBuV/m) = Raw Value(dBuV) + Correction Factor(dB/m)
- Correction Factor(dB/m) = Antenna Factor(dB/m) + Cable Factor(dB) – Pre-Amplifier Factor(dB)
- The other emission levels were very low against the limit.
- Margin value = Emission Level – Limit value
- " * ": Fundamental frequency.
- " # ": The radiated frequency is out of the restricted band.

CHANNEL	TX Channel 155	DETECTOR FUNCTION	Peak (PK)
FREQUENCY RANGE	1GHz ~ 40GHz		Average (AV)

ANTENNA POLARITY & TEST DISTANCE: HORIZONTAL AT 3 M

NO.	FREQ. (MHz)	EMISSION LEVEL (dBuV/m)	LIMIT (dBuV/m)	MARGIN (dB)	ANTENNA HEIGHT (m)	TABLE ANGLE (Degree)	RAW VALUE (dBuV)	CORRECTION FACTOR (dB/m)
1	#5715.00	58.6 PK	74.0	-15.4	1.00 H	34	50.68	7.92
2	#5715.00	45.9 AV	54.0	-8.1	1.00 H	34	37.98	7.92
3	#5725.00	59.6 PK	78.2	-18.6	1.00 H	36	51.66	7.94
4	*5775.00	92.1 PK			1.00 H	24	84.07	8.03
5	*5775.00	82.3 AV			1.00 H	24	74.27	8.03
6	#5850.00	52.6 PK	78.2	-25.6	1.00 H	39	44.56	8.04
7	#5860.00	52.5 PK	74.0	-21.5	1.00 H	16	44.47	8.03
8	#5860.00	39.6 AV	54.0	-14.4	1.00 H	16	31.57	8.03
9	11550.00	55.2 PK	74.0	-18.8	1.01 H	64	41.05	14.15
10	11550.00	41.8 AV	54.0	-12.2	1.01 H	64	27.65	14.15
11	#17325.00	61.3 PK	74.0	-12.7	1.00 H	191	37.62	23.68
12	#17325.00	48.9 AV	54.0	-5.1	1.00 H	191	25.22	23.68

ANTENNA POLARITY & TEST DISTANCE: VERTICAL AT 3 M

NO.	FREQ. (MHz)	EMISSION LEVEL (dBuV/m)	LIMIT (dBuV/m)	MARGIN (dB)	ANTENNA HEIGHT (m)	TABLE ANGLE (Degree)	RAW VALUE (dBuV)	CORRECTION FACTOR (dB/m)
1	#5715.00	67.9 PK	74.0	-6.1	1.14 V	261	59.98	7.92
2	#5715.00	53.8 AV	54.0	-0.2	1.14 V	261	45.88	7.92
3	#5725.00	68.9 PK	78.2	-9.3	1.14 V	261	60.96	7.94
4	*5775.00	101.2 PK			1.22 V	261	93.17	8.03
5	*5775.00	91.4 AV			1.22 V	261	83.37	8.03
6	#5850.00	61.5 PK	78.2	-16.7	1.14 V	261	53.46	8.04
7	#5860.00	59.8 PK	74.0	-14.2	1.14 V	261	51.77	8.03
8	#5860.00	47.4 AV	54.0	-6.6	1.14 V	261	39.37	8.03
9	11550.00	53.2 PK	74.0	-20.8	1.00 V	26	39.05	14.15
10	11550.00	40.8 AV	54.0	-13.2	1.00 V	26	26.65	14.15
11	#17325.00	60.1 PK	74.0	-13.9	1.00 V	189	36.42	23.68
12	#17325.00	49.5 AV	54.0	-4.5	1.00 V	189	25.82	23.68

REMARKS:

1. Emission Level(dBuV/m) = Raw Value(dBuV) + Correction Factor(dB/m)
2. Correction Factor(dB/m) = Antenna Factor(dB/m) + Cable Factor(dB) – Pre-Amplifier Factor(dB)
3. The other emission levels were very low against the limit.
4. Margin value = Emission Level – Limit value
5. " * ": Fundamental frequency.
6. " # ": The radiated frequency is out of the restricted band.

2TX Mode
Above 1GHz Data
802.11ac (VHT20)

CHANNEL	TX Channel 36	DETECTOR FUNCTION	Peak (PK)
FREQUENCY RANGE	1GHz ~ 40GHz		Average (AV)

ANTENNA POLARITY & TEST DISTANCE: HORIZONTAL AT 3 M

NO.	FREQ. (MHz)	EMISSION LEVEL (dBuV/m)	LIMIT (dBuV/m)	MARGIN (dB)	ANTENNA HEIGHT (m)	TABLE ANGLE (Degree)	RAW VALUE (dBuV)	CORRECTION FACTOR (dB/m)
1	5150.00	58.2 PK	74.0	-15.8	1.00 H	264	51.60	6.60
2	5150.00	46.1 AV	54.0	-7.9	1.00 H	264	39.50	6.60
3	*5180.00	104.2 PK			1.00 H	244	97.41	6.79
4	*5180.00	95.1 AV			1.00 H	244	88.31	6.79
5	#10360.00	54.7 PK	74.0	-19.3	1.00 H	66	40.84	13.86
6	#10360.00	41.0 AV	54.0	-13.0	1.00 H	66	27.14	13.86
7	15540.00	58.0 PK	74.0	-16.0	1.00 H	280	38.85	19.15
8	15540.00	45.9 AV	54.0	-8.1	1.00 H	280	26.75	19.15

ANTENNA POLARITY & TEST DISTANCE: VERTICAL AT 3 M

NO.	FREQ. (MHz)	EMISSION LEVEL (dBuV/m)	LIMIT (dBuV/m)	MARGIN (dB)	ANTENNA HEIGHT (m)	TABLE ANGLE (Degree)	RAW VALUE (dBuV)	CORRECTION FACTOR (dB/m)
1	5150.00	69.5 PK	74.0	-4.5	1.00 V	31	62.90	6.60
2	5150.00	53.4 AV	54.0	-0.6	1.00 V	31	46.80	6.60
3	*5180.00	113.3 PK			1.00 V	0	106.51	6.79
4	*5180.00	104.6 AV			1.00 V	0	97.81	6.79
5	#10360.00	54.8 PK	74.0	-19.2	1.00 V	168	40.94	13.86
6	#10360.00	40.6 AV	54.0	-13.4	1.00 V	168	26.74	13.86
7	15540.00	58.4 PK	74.0	-15.6	1.00 V	109	39.25	19.15
8	15540.00	46.2 AV	54.0	-7.8	1.00 V	109	27.05	19.15

REMARKS:

- Emission Level(dBuV/m) = Raw Value(dBuV) + Correction Factor(dB/m)
- Correction Factor(dB/m) = Antenna Factor(dB/m) + Cable Factor(dB) – Pre-Amplifier Factor(dB)
- The other emission levels were very low against the limit.
- Margin value = Emission Level – Limit value
- " * ": Fundamental frequency.
- " # ": The radiated frequency is out of the restricted band.

CHANNEL	TX Channel 40	DETECTOR FUNCTION	Peak (PK)
FREQUENCY RANGE	1GHz ~ 40GHz		Average (AV)

ANTENNA POLARITY & TEST DISTANCE: HORIZONTAL AT 3 M

NO.	FREQ. (MHz)	EMISSION LEVEL (dBuV/m)	LIMIT (dBuV/m)	MARGIN (dB)	ANTENNA HEIGHT (m)	TABLE ANGLE (Degree)	RAW VALUE (dBuV)	CORRECTION FACTOR (dB/m)
1	*5200.00	103.4 PK			1.03 H	240	96.50	6.90
2	*5200.00	97.5 AV			1.03 H	240	90.60	6.90
3	#10400.00	54.9 PK	74.0	-19.1	1.00 H	35	41.02	13.88
4	#10400.00	41.1 AV	54.0	-12.9	1.00 H	35	27.22	13.88
5	15600.00	58.1 PK	74.0	-15.9	1.00 H	273	39.45	18.65
6	15600.00	46.1 AV	54.0	-7.9	1.00 H	273	27.45	18.65

ANTENNA POLARITY & TEST DISTANCE: VERTICAL AT 3 M

NO.	FREQ. (MHz)	EMISSION LEVEL (dBuV/m)	LIMIT (dBuV/m)	MARGIN (dB)	ANTENNA HEIGHT (m)	TABLE ANGLE (Degree)	RAW VALUE (dBuV)	CORRECTION FACTOR (dB/m)
1	*5200.00	112.3 PK			1.08 V	14	105.40	6.90
2	*5200.00	106.2 AV			1.08 V	14	99.30	6.90
3	#10400.00	54.3 PK	74.0	-19.7	1.00 V	152	40.42	13.88
4	#10400.00	40.1 AV	54.0	-13.9	1.00 V	152	26.22	13.88
5	15600.00	57.3 PK	74.0	-16.7	1.00 V	100	38.65	18.65
6	15600.00	45.9 AV	54.0	-8.1	1.00 V	100	27.25	18.65

REMARKS:

1. Emission Level(dBuV/m) = Raw Value(dBuV) + Correction Factor(dB/m)
2. Correction Factor(dB/m) = Antenna Factor(dB/m) + Cable Factor(dB) – Pre-Amplifier Factor(dB)
3. The other emission levels were very low against the limit.
4. Margin value = Emission Level – Limit value
5. " * ": Fundamental frequency.
6. " # ": The radiated frequency is out of the restricted band.

CHANNEL	TX Channel 48	DETECTOR FUNCTION	Peak (PK)
FREQUENCY RANGE	1GHz ~ 40GHz		Average (AV)

ANTENNA POLARITY & TEST DISTANCE: HORIZONTAL AT 3 M

NO.	FREQ. (MHz)	EMISSION LEVEL (dBuV/m)	LIMIT (dBuV/m)	MARGIN (dB)	ANTENNA HEIGHT (m)	TABLE ANGLE (Degree)	RAW VALUE (dBuV)	CORRECTION FACTOR (dB/m)
1	*5240.00	103.3 PK			1.00 H	251	96.34	6.96
2	*5240.00	97.4 AV			1.00 H	251	90.44	6.96
3	5350.00	49.3 PK	74.0	-24.7	1.09 H	49	42.12	7.18
4	5350.00	37.4 AV	54.0	-16.6	1.09 H	49	30.22	7.18
5	#10480.00	54.7 PK	74.0	-19.3	1.00 H	69	41.04	13.66
6	#10480.00	40.8 AV	54.0	-13.2	1.00 H	69	27.14	13.66
7	15720.00	57.7 PK	74.0	-16.3	1.00 H	256	38.52	19.18
8	15720.00	45.1 AV	54.0	-8.9	1.00 H	256	25.92	19.18

ANTENNA POLARITY & TEST DISTANCE: VERTICAL AT 3 M

NO.	FREQ. (MHz)	EMISSION LEVEL (dBuV/m)	LIMIT (dBuV/m)	MARGIN (dB)	ANTENNA HEIGHT (m)	TABLE ANGLE (Degree)	RAW VALUE (dBuV)	CORRECTION FACTOR (dB/m)
1	*5240.00	112.8 PK			1.11 V	0	105.84	6.96
2	*5240.00	106.5 AV			1.11 V	0	99.54	6.96
3	5350.00	56.8 PK	74.0	-17.2	1.06 V	16	49.62	7.18
4	5350.00	46.7 AV	54.0	-7.3	1.06 V	16	39.52	7.18
5	#10480.00	54.4 PK	74.0	-19.6	1.00 V	157	40.74	13.66
6	#10480.00	40.2 AV	54.0	-13.8	1.00 V	157	26.54	13.66
7	15720.00	58.0 PK	74.0	-16.0	1.00 V	102	38.82	19.18
8	15720.00	46.3 AV	54.0	-7.7	1.00 V	102	27.12	19.18

REMARKS:

1. Emission Level(dBuV/m) = Raw Value(dBuV) + Correction Factor(dB/m)
2. Correction Factor(dB/m) = Antenna Factor(dB/m) + Cable Factor(dB) – Pre-Amplifier Factor(dB)
3. The other emission levels were very low against the limit.
4. Margin value = Emission Level – Limit value
5. " * ": Fundamental frequency.
6. " # ": The radiated frequency is out of the restricted band.

CHANNEL	TX Channel 149	DETECTOR FUNCTION	Peak (PK)
FREQUENCY RANGE	1GHz ~ 40GHz		Average (AV)

ANTENNA POLARITY & TEST DISTANCE: HORIZONTAL AT 3 M

NO.	FREQ. (MHz)	EMISSION LEVEL (dBuV/m)	LIMIT (dBuV/m)	MARGIN (dB)	ANTENNA HEIGHT (m)	TABLE ANGLE (Degree)	RAW VALUE (dBuV)	CORRECTION FACTOR (dB/m)
1	#5715.00	56.4 PK	74.0	-17.6	1.03 H	221	48.48	7.92
2	#5715.00	45.6 AV	54.0	-8.4	1.03 H	221	37.68	7.92
3	#5725.00	65.8 PK	78.2	-12.4	1.03 H	221	57.86	7.94
4	*5745.00	100.9 PK			1.03 H	221	92.92	7.98
5	*5745.00	94.7 AV			1.03 H	221	86.72	7.98
6	11490.00	55.0 PK	74.0	-19.0	1.03 H	63	40.96	14.04
7	11490.00	41.4 AV	54.0	-12.6	1.03 H	63	27.36	14.04
8	#17235.00	57.9 PK	74.0	-16.1	1.00 H	268	34.16	23.74
9	#17235.00	45.5 AV	54.0	-8.5	1.00 H	268	21.76	23.74

ANTENNA POLARITY & TEST DISTANCE: VERTICAL AT 3 M

NO.	FREQ. (MHz)	EMISSION LEVEL (dBuV/m)	LIMIT (dBuV/m)	MARGIN (dB)	ANTENNA HEIGHT (m)	TABLE ANGLE (Degree)	RAW VALUE (dBuV)	CORRECTION FACTOR (dB/m)
1	#5715.00	66.4 PK	74.0	-7.6	1.08 V	254	58.48	7.92
2	#5715.00	52.8 AV	54.0	-1.2	1.08 V	254	44.88	7.92
3	#5725.00	75.8 PK	78.2	-2.4	1.14 V	264	67.86	7.94
4	*5745.00	112.0 PK			1.17 V	272	104.02	7.98
5	*5745.00	103.4 AV			1.17 V	272	95.42	7.98
6	11490.00	53.4 PK	74.0	-20.6	1.05 V	58	39.36	14.04
7	11490.00	40.4 AV	54.0	-13.6	1.05 V	58	26.36	14.04
8	#17235.00	59.2 PK	74.0	-14.8	1.00 V	204	35.46	23.74
9	#17235.00	48.9 AV	54.0	-5.1	1.00 V	204	25.16	23.74

REMARKS:

1. Emission Level(dBuV/m) = Raw Value(dBuV) + Correction Factor(dB/m)
2. Correction Factor(dB/m) = Antenna Factor(dB/m) + Cable Factor(dB) – Pre-Amplifier Factor(dB)
3. The other emission levels were very low against the limit.
4. Margin value = Emission Level – Limit value
5. " * ": Fundamental frequency.
6. " # ": The radiated frequency is out of the restricted band.

CHANNEL	TX Channel 157	DETECTOR FUNCTION	Peak (PK)
FREQUENCY RANGE	1GHz ~ 40GHz		Average (AV)

ANTENNA POLARITY & TEST DISTANCE: HORIZONTAL AT 3 M

NO.	FREQ. (MHz)	EMISSION LEVEL (dBuV/m)	LIMIT (dBuV/m)	MARGIN (dB)	ANTENNA HEIGHT (m)	TABLE ANGLE (Degree)	RAW VALUE (dBuV)	CORRECTION FACTOR (dB/m)
1	*5785.00	101.3 PK			1.02 H	235	93.25	8.05
2	*5785.00	95.2 AV			1.02 H	235	87.15	8.05
3	11570.00	54.0 PK	74.0	-20.0	1.06 H	60	39.79	14.21
4	11570.00	40.1 AV	54.0	-13.9	1.06 H	60	25.89	14.21
5	#17355.00	57.4 PK	74.0	-16.6	1.08 H	261	33.25	24.15
6	#17355.00	45.5 AV	54.0	-8.5	1.08 H	261	21.35	24.15

ANTENNA POLARITY & TEST DISTANCE: VERTICAL AT 3 M

NO.	FREQ. (MHz)	EMISSION LEVEL (dBuV/m)	LIMIT (dBuV/m)	MARGIN (dB)	ANTENNA HEIGHT (m)	TABLE ANGLE (Degree)	RAW VALUE (dBuV)	CORRECTION FACTOR (dB/m)
1	*5785.00	113.2 PK			1.08 V	14	105.15	8.05
2	*5785.00	104.7 AV			1.08 V	14	96.65	8.05
3	11570.00	52.4 PK	74.0	-21.6	1.00 V	50	38.19	14.21
4	11570.00	39.7 AV	54.0	-14.3	1.00 V	50	25.49	14.21
5	#17355.00	59.2 PK	74.0	-14.8	1.00 V	193	35.05	24.15
6	#17355.00	48.8 AV	54.0	-5.2	1.00 V	193	24.65	24.15

REMARKS:

1. Emission Level(dBuV/m) = Raw Value(dBuV) + Correction Factor(dB/m)
2. Correction Factor(dB/m) = Antenna Factor(dB/m) + Cable Factor(dB) – Pre-Amplifier Factor(dB)
3. The other emission levels were very low against the limit.
4. Margin value = Emission Level – Limit value
5. " * ": Fundamental frequency.
6. " # ": The radiated frequency is out of the restricted band.

CHANNEL	TX Channel 165	DETECTOR FUNCTION	Peak (PK)
FREQUENCY RANGE	1GHz ~ 40GHz		Average (AV)

ANTENNA POLARITY & TEST DISTANCE: HORIZONTAL AT 3 M

NO.	FREQ. (MHz)	EMISSION LEVEL (dBuV/m)	LIMIT (dBuV/m)	MARGIN (dB)	ANTENNA HEIGHT (m)	TABLE ANGLE (Degree)	RAW VALUE (dBuV)	CORRECTION FACTOR (dB/m)
1	*5825.00	100.5 PK			1.06 H	221	92.45	8.05
2	*5825.00	94.3 AV			1.06 H	221	86.25	8.05
3	#5850.00	56.4 PK	78.2	-21.8	1.06 H	221	48.36	8.04
4	#5860.00	52.2 PK	74.0	-21.8	1.06 H	221	44.17	8.03
5	#5860.00	40.3 AV	54.0	-13.7	1.06 H	221	32.27	8.03
6	11650.00	53.6 PK	74.0	-20.4	1.00 H	71	39.15	14.45
7	11650.00	40.4 AV	54.0	-13.6	1.00 H	71	25.95	14.45
8	#17475.00	56.9 PK	74.0	-17.1	1.06 H	269	32.68	24.22
9	#17475.00	45.4 AV	54.0	-8.6	1.06 H	269	21.18	24.22

ANTENNA POLARITY & TEST DISTANCE: VERTICAL AT 3 M

NO.	FREQ. (MHz)	EMISSION LEVEL (dBuV/m)	LIMIT (dBuV/m)	MARGIN (dB)	ANTENNA HEIGHT (m)	TABLE ANGLE (Degree)	RAW VALUE (dBuV)	CORRECTION FACTOR (dB/m)
1	*5825.00	112.4 PK			1.02 V	256	104.35	8.05
2	*5825.00	103.3 AV			1.02 V	256	95.25	8.05
3	#5850.00	66.8 PK	78.2	-11.4	1.06 V	257	58.76	8.04
4	#5860.00	60.1 PK	74.0	-13.9	1.08 V	245	52.07	8.03
5	#5860.00	47.5 AV	54.0	-6.5	1.08 V	245	39.47	8.03
6	11650.00	52.3 PK	74.0	-21.7	1.00 V	50	37.85	14.45
7	11650.00	39.6 AV	54.0	-14.4	1.00 V	50	25.15	14.45
8	#17475.00	58.9 PK	74.0	-15.1	1.05 V	194	34.68	24.22
9	#17475.00	48.4 AV	54.0	-5.6	1.05 V	194	24.18	24.22

REMARKS:

1. Emission Level(dBuV/m) = Raw Value(dBuV) + Correction Factor(dB/m)
2. Correction Factor(dB/m) = Antenna Factor(dB/m) + Cable Factor(dB) – Pre-Amplifier Factor(dB)
3. The other emission levels were very low against the limit.
4. Margin value = Emission Level – Limit value
5. " * ": Fundamental frequency.
6. " # ": The radiated frequency is out of the restricted band.

802.11ac (VHT40)

CHANNEL	TX Channel 38	DETECTOR FUNCTION	Peak (PK)
FREQUENCY RANGE	1GHz ~ 40GHz		Average (AV)

ANTENNA POLARITY & TEST DISTANCE: HORIZONTAL AT 3 M								
NO.	FREQ. (MHz)	EMISSION LEVEL (dBuV/m)	LIMIT (dBuV/m)	MARGIN (dB)	ANTENNA HEIGHT (m)	TABLE ANGLE (Degree)	RAW VALUE (dBuV)	CORRECTION FACTOR (dB/m)
1	5150.00	58.1 PK	74.0	-15.9	1.00 H	249	51.50	6.60
2	5150.00	46.3 AV	54.0	-7.7	1.00 H	249	39.70	6.60
3	*5190.00	94.2 PK			1.05 H	231	87.36	6.84
4	*5190.00	85.1 AV			1.05 H	231	78.26	6.84
5	#10380.00	54.6 PK	74.0	-19.4	1.00 H	73	40.73	13.87
6	#10380.00	41.4 AV	54.0	-12.6	1.00 H	73	27.53	13.87
7	15570.00	58.0 PK	74.0	-16.0	1.00 H	266	39.10	18.90
8	15570.00	45.9 AV	54.0	-8.1	1.00 H	266	27.00	18.90

ANTENNA POLARITY & TEST DISTANCE: VERTICAL AT 3 M								
NO.	FREQ. (MHz)	EMISSION LEVEL (dBuV/m)	LIMIT (dBuV/m)	MARGIN (dB)	ANTENNA HEIGHT (m)	TABLE ANGLE (Degree)	RAW VALUE (dBuV)	CORRECTION FACTOR (dB/m)
1	5150.00	66.7 PK	74.0	-7.3	1.00 V	15	60.10	6.60
2	5150.00	53.9 AV	54.0	-0.1	1.00 V	15	47.30	6.60
3	*5190.00	103.5 PK			1.12 V	0	96.66	6.84
4	*5190.00	94.8 AV			1.12 V	0	87.96	6.84
5	#10380.00	54.8 PK	74.0	-19.2	1.00 V	160	40.93	13.87
6	#10380.00	40.5 AV	54.0	-13.5	1.00 V	160	26.63	13.87
7	15570.00	58.0 PK	74.0	-16.0	1.00 V	125	39.10	18.90
8	15570.00	45.8 AV	54.0	-8.2	1.00 V	125	26.90	18.90

REMARKS:

1. Emission Level(dBuV/m) = Raw Value(dBuV) + Correction Factor(dB/m)
2. Correction Factor(dB/m) = Antenna Factor(dB/m) + Cable Factor(dB) – Pre-Amplifier Factor(dB)
3. The other emission levels were very low against the limit.
4. Margin value = Emission Level – Limit value
5. " * ": Fundamental frequency.
6. " # ": The radiated frequency is out of the restricted band.

CHANNEL	TX Channel 46	DETECTOR FUNCTION	Peak (PK)
FREQUENCY RANGE	1GHz ~ 40GHz		Average (AV)

ANTENNA POLARITY & TEST DISTANCE: HORIZONTAL AT 3 M

NO.	FREQ. (MHz)	EMISSION LEVEL (dBuV/m)	LIMIT (dBuV/m)	MARGIN (dB)	ANTENNA HEIGHT (m)	TABLE ANGLE (Degree)	RAW VALUE (dBuV)	CORRECTION FACTOR (dB/m)
1	*5230.00	101.1 PK			1.00 H	253	94.15	6.95
2	*5230.00	91.3 AV			1.00 H	253	84.35	6.95
3	5390.00	50.2 PK	74.0	-23.8	1.07 H	38	42.90	7.30
4	5390.00	37.9 AV	54.0	-16.1	1.07 H	38	30.60	7.30
5	#10460.00	54.8 PK	74.0	-19.2	1.00 H	61	41.09	13.71
6	#10460.00	41.2 AV	54.0	-12.8	1.00 H	61	27.49	13.71
7	15690.00	58.8 PK	74.0	-15.2	1.00 H	248	39.74	19.06
8	15690.00	46.2 AV	54.0	-7.8	1.00 H	248	27.14	19.06

ANTENNA POLARITY & TEST DISTANCE: VERTICAL AT 3 M

NO.	FREQ. (MHz)	EMISSION LEVEL (dBuV/m)	LIMIT (dBuV/m)	MARGIN (dB)	ANTENNA HEIGHT (m)	TABLE ANGLE (Degree)	RAW VALUE (dBuV)	CORRECTION FACTOR (dB/m)
1	*5230.00	110.3 PK			1.00 V	26	103.35	6.95
2	*5230.00	100.5 AV			1.00 V	26	93.55	6.95
3	5390.00	58.2 PK	74.0	-15.8	1.00 V	17	50.90	7.30
4	5390.00	46.9 AV	54.0	-7.1	1.00 V	17	39.60	7.30
5	#10460.00	54.0 PK	74.0	-20.0	1.00 V	182	40.29	13.71
6	#10460.00	40.0 AV	54.0	-14.0	1.00 V	182	26.29	13.71
7	15690.00	58.9 PK	74.0	-15.1	1.00 V	104	39.84	19.06
8	15690.00	46.8 AV	54.0	-7.2	1.00 V	104	27.74	19.06

REMARKS:

1. Emission Level(dBuV/m) = Raw Value(dBuV) + Correction Factor(dB/m)
2. Correction Factor(dB/m) = Antenna Factor(dB/m) + Cable Factor(dB) – Pre-Amplifier Factor(dB)
3. The other emission levels were very low against the limit.
4. Margin value = Emission Level – Limit value
5. " * ": Fundamental frequency.
6. " # ": The radiated frequency is out of the restricted band.

CHANNEL	TX Channel 151	DETECTOR FUNCTION	Peak (PK)
FREQUENCY RANGE	1GHz ~ 40GHz		Average (AV)

ANTENNA POLARITY & TEST DISTANCE: HORIZONTAL AT 3 M

NO.	FREQ. (MHz)	EMISSION LEVEL (dBuV/m)	LIMIT (dBuV/m)	MARGIN (dB)	ANTENNA HEIGHT (m)	TABLE ANGLE (Degree)	RAW VALUE (dBuV)	CORRECTION FACTOR (dB/m)
1	#5715.00	59.3 PK	68.2	-8.9	1.08 H	216	51.38	7.92
2	#5725.00	61.4 PK	78.2	-16.8	1.08 H	216	53.46	7.94
3	*5755.00	98.4 PK			1.08 H	216	90.41	7.99
4	*5755.00	90.2 AV			1.08 H	216	82.21	7.99
5	11510.00	54.5 PK	74.0	-19.5	1.00 H	53	40.48	14.02
6	11510.00	40.8 AV	54.0	-13.2	1.00 H	53	26.78	14.02
7	#17265.00	58.6 PK	74.0	-15.4	1.10 H	236	35.07	23.53
8	#17265.00	46.1 AV	54.0	-7.9	1.10 H	236	22.57	23.53

ANTENNA POLARITY & TEST DISTANCE: VERTICAL AT 3 M

NO.	FREQ. (MHz)	EMISSION LEVEL (dBuV/m)	LIMIT (dBuV/m)	MARGIN (dB)	ANTENNA HEIGHT (m)	TABLE ANGLE (Degree)	RAW VALUE (dBuV)	CORRECTION FACTOR (dB/m)
1	#5715.00	67.6 PK	68.2	-0.6	1.13 V	249	59.68	7.92
2	#5725.00	69.6 PK	78.2	-8.6	1.13 V	276	61.66	7.94
3	*5755.00	107.8 PK			1.13 V	246	99.81	7.99
4	*5755.00	98.7 AV			1.13 V	246	90.71	7.99
5	11510.00	51.9 PK	74.0	-22.1	1.00 V	56	37.88	14.02
6	11510.00	39.4 AV	54.0	-14.6	1.00 V	56	25.38	14.02
7	#17265.00	57.4 PK	74.0	-16.6	1.03 V	203	33.87	23.53
8	#17265.00	47.2 AV	54.0	-6.8	1.03 V	203	23.67	23.53

REMARKS:

1. Emission Level(dBuV/m) = Raw Value(dBuV) + Correction Factor(dB/m)
2. Correction Factor(dB/m) = Antenna Factor(dB/m) + Cable Factor(dB) – Pre-Amplifier Factor(dB)
3. The other emission levels were very low against the limit.
4. Margin value = Emission Level – Limit value
5. " * ": Fundamental frequency.
6. " # ": The radiated frequency is out of the restricted band.

CHANNEL	TX Channel 159	DETECTOR FUNCTION	Peak (PK)
FREQUENCY RANGE	1GHz ~ 40GHz		Average (AV)

ANTENNA POLARITY & TEST DISTANCE: HORIZONTAL AT 3 M

NO.	FREQ. (MHz)	EMISSION LEVEL (dBuV/m)	LIMIT (dBuV/m)	MARGIN (dB)	ANTENNA HEIGHT (m)	TABLE ANGLE (Degree)	RAW VALUE (dBuV)	CORRECTION FACTOR (dB/m)
1	*5795.00	97.9 PK			1.05 H	201	89.83	8.07
2	*5795.00	90.0 AV			1.05 H	201	81.93	8.07
3	#5850.00	55.4 PK	78.2	-22.8	1.05 H	201	47.36	8.04
4	#5860.00	50.6 PK	74.0	-23.4	1.05 H	201	42.57	8.03
5	#5860.00	40.3 AV	54.0	-13.7	1.05 H	201	32.27	8.03
6	11590.00	55.0 PK	74.0	-19.0	1.03 H	36	40.71	14.29
7	11590.00	41.5 AV	54.0	-12.5	1.03 H	36	27.21	14.29
8	#17385.00	59.3 PK	74.0	-14.7	1.10 H	238	34.69	24.61
9	#17385.00	46.6 AV	54.0	-7.4	1.10 H	238	21.99	24.61

ANTENNA POLARITY & TEST DISTANCE: VERTICAL AT 3 M

NO.	FREQ. (MHz)	EMISSION LEVEL (dBuV/m)	LIMIT (dBuV/m)	MARGIN (dB)	ANTENNA HEIGHT (m)	TABLE ANGLE (Degree)	RAW VALUE (dBuV)	CORRECTION FACTOR (dB/m)
1	*5795.00	108.2 PK			1.07 V	246	100.13	8.07
2	*5795.00	98.8 AV			1.07 V	246	90.73	8.07
3	#5850.00	63.5 PK	78.2	-14.7	1.07 V	258	55.46	8.04
4	#5860.00	59.8 PK	74.0	-14.2	1.12 V	264	51.77	8.03
5	#5860.00	47.5 AV	54.0	-6.5	1.12 V	264	39.47	8.03
6	11590.00	52.6 PK	74.0	-21.4	1.00 V	42	38.31	14.29
7	11590.00	40.0 AV	54.0	-14.0	1.00 V	42	25.71	14.29
8	#17385.00	58.3 PK	74.0	-15.7	1.02 V	200	33.69	24.61
9	#17385.00	47.6 AV	54.0	-6.4	1.02 V	200	22.99	24.61

REMARKS:

1. Emission Level(dBuV/m) = Raw Value(dBuV) + Correction Factor(dB/m)
2. Correction Factor(dB/m) = Antenna Factor(dB/m) + Cable Factor(dB) – Pre-Amplifier Factor(dB)
3. The other emission levels were very low against the limit.
4. Margin value = Emission Level – Limit value
5. " * ": Fundamental frequency.
6. " # ": The radiated frequency is out of the restricted band.

802.11ac (VHT80)

CHANNEL	TX Channel 42	DETECTOR FUNCTION	Peak (PK)
FREQUENCY RANGE	1GHz ~ 40GHz		Average (AV)

ANTENNA POLARITY & TEST DISTANCE: HORIZONTAL AT 3 M

NO.	FREQ. (MHz)	EMISSION LEVEL (dBuV/m)	LIMIT (dBuV/m)	MARGIN (dB)	ANTENNA HEIGHT (m)	TABLE ANGLE (Degree)	RAW VALUE (dBuV)	CORRECTION FACTOR (dB/m)
1	5150.00	57.0 PK	74.0	-17.0	1.00 H	262	50.40	6.60
2	5150.00	45.1 AV	54.0	-8.9	1.00 H	262	38.50	6.60
3	*5210.00	92.1 PK			1.00 H	231	85.19	6.91
4	*5210.00	83.1 AV			1.00 H	231	76.19	6.91
5	5370.00	48.1 PK	74.0	-25.9	1.07 H	38	40.85	7.25
6	5370.00	35.2 AV	54.0	-18.8	1.07 H	38	27.95	7.25
7	#10420.00	55.2 PK	74.0	-18.8	1.00 H	44	41.39	13.81
8	#10420.00	41.3 AV	54.0	-12.7	1.00 H	44	27.49	13.81
9	15630.00	58.4 PK	74.0	-15.6	1.00 H	263	39.61	18.79
10	15630.00	45.8 AV	54.0	-8.2	1.00 H	263	27.01	18.79

ANTENNA POLARITY & TEST DISTANCE: VERTICAL AT 3 M

NO.	FREQ. (MHz)	EMISSION LEVEL (dBuV/m)	LIMIT (dBuV/m)	MARGIN (dB)	ANTENNA HEIGHT (m)	TABLE ANGLE (Degree)	RAW VALUE (dBuV)	CORRECTION FACTOR (dB/m)
1	5150.00	67.2 PK	74.0	-6.8	1.00 V	14	60.60	6.60
2	5150.00	53.6 AV	54.0	-0.4	1.00 V	14	47.00	6.60
3	*5210.00	101.4 PK			1.00 V	0	94.49	6.91
4	*5210.00	92.1 AV			1.00 V	0	85.19	6.91
5	5370.00	54.2 PK	74.0	-19.8	1.04 V	11	46.95	7.25
6	5370.00	42.3 AV	54.0	-11.7	1.04 V	11	35.05	7.25
7	#10420.00	54.2 PK	74.0	-19.8	1.00 V	183	40.39	13.81
8	#10420.00	40.3 AV	54.0	-13.7	1.00 V	183	26.49	13.81
9	15630.00	58.8 PK	74.0	-15.2	1.00 V	95	40.01	18.79
10	15630.00	46.9 AV	54.0	-7.1	1.00 V	95	28.11	18.79

REMARKS:

1. Emission Level(dBuV/m) = Raw Value(dBuV) + Correction Factor(dB/m)
2. Correction Factor(dB/m) = Antenna Factor(dB/m) + Cable Factor(dB) – Pre-Amplifier Factor(dB)
3. The other emission levels were very low against the limit.
4. Margin value = Emission Level – Limit value
5. " * ": Fundamental frequency.
6. " # ": The radiated frequency is out of the restricted band.

CHANNEL	TX Channel 155	DETECTOR FUNCTION	Peak (PK)
FREQUENCY RANGE	1GHz ~ 40GHz		Average (AV)

ANTENNA POLARITY & TEST DISTANCE: HORIZONTAL AT 3 M

NO.	FREQ. (MHz)	EMISSION LEVEL (dBuV/m)	LIMIT (dBuV/m)	MARGIN (dB)	ANTENNA HEIGHT (m)	TABLE ANGLE (Degree)	RAW VALUE (dBuV)	CORRECTION FACTOR (dB/m)
1	#5715.00	59.4 PK	74.0	-14.6	1.05 H	204	51.48	7.92
2	#5715.00	44.8 AV	54.0	-9.2	1.05 H	204	36.88	7.92
3	#5725.00	60.2 PK	78.2	-18.0	1.05 H	204	52.26	7.94
4	*5775.00	92.0 PK			1.05 H	204	83.97	8.03
5	*5775.00	82.0 AV			1.05 H	204	73.97	8.03
6	#5850.00	52.4 PK	78.2	-25.8	1.05 H	204	44.36	8.04
7	11550.00	54.5 PK	74.0	-19.5	1.00 H	36	40.35	14.15
8	11550.00	40.9 AV	54.0	-13.1	1.00 H	36	26.75	14.15
9	#17325.00	58.4 PK	74.0	-15.6	1.03 H	258	34.72	23.68
10	#17325.00	46.1 AV	54.0	-7.9	1.03 H	258	22.42	23.68

ANTENNA POLARITY & TEST DISTANCE: VERTICAL AT 3 M

NO.	FREQ. (MHz)	EMISSION LEVEL (dBuV/m)	LIMIT (dBuV/m)	MARGIN (dB)	ANTENNA HEIGHT (m)	TABLE ANGLE (Degree)	RAW VALUE (dBuV)	CORRECTION FACTOR (dB/m)
1	#5715.00	67.4 PK	74.0	-6.6	1.07 V	238	59.48	7.92
2	#5715.00	53.3 AV	54.0	-0.7	1.07 V	238	45.38	7.92
3	#5725.00	69.0 PK	78.2	-9.2	1.09 V	264	61.06	7.94
4	*5775.00	101.2 PK			1.23 V	264	93.17	8.03
5	*5775.00	91.9 AV			1.23 V	264	83.87	8.03
6	#5850.00	61.7 PK	78.2	-16.5	1.01 V	258	53.66	8.04
7	11550.00	51.1 PK	74.0	-22.9	1.00 V	44	36.95	14.15
8	11550.00	38.2 AV	54.0	-15.8	1.00 V	44	24.05	14.15
9	#17325.00	56.2 PK	74.0	-17.8	1.00 V	204	32.52	23.68
10	#17325.00	46.6 AV	54.0	-7.4	1.00 V	204	22.92	23.68

REMARKS:

1. Emission Level(dBuV/m) = Raw Value(dBuV) + Correction Factor(dB/m)
2. Correction Factor(dB/m) = Antenna Factor(dB/m) + Cable Factor(dB) – Pre-Amplifier Factor(dB)
3. The other emission levels were very low against the limit.
4. Margin value = Emission Level – Limit value
5. " * ": Fundamental frequency.
6. " # ": The radiated frequency is out of the restricted band.

2TX Mode

Below 1GHz Data

802.11ac (VHT20)

CHANNEL	TX Channel 40	DETECTOR FUNCTION	Quasi-Peak (QP)
FREQUENCY RANGE	Below 1GHz		

ANTENNA POLARITY & TEST DISTANCE: HORIZONTAL AT 3 M

NO.	FREQ. (MHz)	EMISSION LEVEL (dBuV/m)	LIMIT (dBuV/m)	MARGIN (dB)	ANTENNA HEIGHT (m)	TABLE ANGLE (Degree)	RAW VALUE (dBuV)	CORRECTION FACTOR (dB/m)
1	125.11	33.1 QP	43.5	-10.4	1.06 H	198	47.92	-14.85
2	175.11	34.3 QP	43.5	-9.2	1.48 H	217	48.14	-13.86
3	249.54	42.2 QP	46.0	-3.8	1.36 H	228	56.25	-14.02
4	374.71	37.6 QP	46.0	-8.4	1.19 H	274	47.57	-9.98
5	500.11	35.4 QP	46.0	-10.6	1.21 H	194	42.26	-6.83
6	749.82	38.5 QP	46.0	-7.5	1.06 H	271	39.73	-1.21

ANTENNA POLARITY & TEST DISTANCE: VERTICAL AT 3 M

NO.	FREQ. (MHz)	EMISSION LEVEL (dBuV/m)	LIMIT (dBuV/m)	MARGIN (dB)	ANTENNA HEIGHT (m)	TABLE ANGLE (Degree)	RAW VALUE (dBuV)	CORRECTION FACTOR (dB/m)
1	34.41	36.1 QP	40.0	-4.0	1.48 V	214	50.17	-14.12
2	66.53	33.4 QP	40.0	-6.6	1.65 V	231	47.99	-14.55
3	209.76	36.5 QP	43.5	-7.0	1.36 V	194	52.49	-16.03
4	249.76	37.0 QP	46.0	-9.0	1.49 V	225	51.05	-14.02
5	400.11	38.5 QP	46.0	-7.5	1.06 V	207	47.87	-9.39
6	424.45	41.4 QP	46.0	-4.6	1.44 V	263	49.89	-8.51

REMARKS:

1. Emission Level(dBuV/m) = Raw Value(dBuV) + Correction Factor(dB/m)
2. Correction Factor(dB/m) = Antenna Factor(dB/m) + Cable Factor(dB) – Pre-Amplifier Factor(dB)
3. The other emission levels were very low against the limit.
4. Margin value = Emission Level – Limit value

4.1.8 Test Results (Mode 2)

1TX Mode

Above 1GHz Data

802.11a

CHANNEL	TX Channel 36	DETECTOR FUNCTION	Peak (PK)
FREQUENCY RANGE	1GHz ~ 40GHz		Average (AV)

ANTENNA POLARITY & TEST DISTANCE: HORIZONTAL AT 3 M

NO.	FREQ. (MHz)	EMISSION LEVEL (dBuV/m)	LIMIT (dBuV/m)	MARGIN (dB)	ANTENNA HEIGHT (m)	TABLE ANGLE (Degree)	RAW VALUE (dBuV)	CORRECTION FACTOR (dB/m)
1	5106.00	51.3 PK	74.0	-22.7	1.01 H	167	47.87	3.43
2	5106.00	40.9 AV	54.0	-13.1	1.01 H	167	37.47	3.43
3	5150.00	62.1 PK	74.0	-11.9	1.08 H	183	58.47	3.63
4	5150.00	46.7 AV	54.0	-7.3	1.08 H	183	43.07	3.63
5	*5180.00	109.8 PK			1.00 H	328	106.03	3.77
6	*5180.00	99.5 AV			1.00 H	328	95.73	3.77
7	#10360.00	56.2 PK	74.0	-17.8	1.00 H	68	46.83	9.37
8	#10360.00	42.3 AV	54.0	-11.7	1.00 H	68	32.93	9.37
9	15540.00	62.0 PK	74.0	-12.0	1.03 H	195	47.59	14.41
10	15540.00	48.8 AV	54.0	-5.2	1.03 H	195	34.39	14.41

ANTENNA POLARITY & TEST DISTANCE: VERTICAL AT 3 M

NO.	FREQ. (MHz)	EMISSION LEVEL (dBuV/m)	LIMIT (dBuV/m)	MARGIN (dB)	ANTENNA HEIGHT (m)	TABLE ANGLE (Degree)	RAW VALUE (dBuV)	CORRECTION FACTOR (dB/m)
1	5106.00	63.4 PK	74.0	-10.6	1.05 V	360	59.97	3.43
2	5106.00	51.2 AV	54.0	-2.8	1.05 V	360	47.77	3.43
3	5120.00	61.4 PK	74.0	-12.6	1.03 V	360	57.90	3.50
4	5120.00	48.6 AV	54.0	-5.4	1.03 V	360	45.10	3.50
5	5150.00	69.9 PK	74.0	-4.1	1.14 V	360	66.27	3.63
6	5150.00	53.3 AV	54.0	-0.7	1.14 V	360	49.67	3.63
7	*5180.00	120.7 PK			1.13 V	360	116.93	3.77
8	*5180.00	111.7 AV			1.13 V	360	107.93	3.77
9	5440.00	58.9 PK	74.0	-15.1	1.32 V	360	54.58	4.32
10	5440.00	46.5 AV	54.0	-7.5	1.32 V	360	42.18	4.32
11	#10360.00	54.3 PK	74.0	-19.7	1.00 V	24	44.93	9.37
12	#10360.00	41.2 AV	54.0	-12.8	1.00 V	24	31.83	9.37
13	15540.00	60.0 PK	74.0	-14.0	1.00 V	219	45.59	14.41
14	15540.00	49.4 AV	54.0	-4.6	1.00 V	219	34.99	14.41

REMARKS:

1. Emission Level(dBuV/m) = Raw Value(dBuV) + Correction Factor(dB/m)
2. Correction Factor(dB/m) = Antenna Factor(dB/m) + Cable Factor(dB) – Pre-Amplifier Factor(dB)
3. The other emission levels were very low against the limit.
4. Margin value = Emission Level – Limit value
5. " * ": Fundamental frequency.
6. " # ": The radiated frequency is out of the restricted band.

CHANNEL	TX Channel 40	DETECTOR FUNCTION	Peak (PK)
FREQUENCY RANGE	1GHz ~ 40GHz		Average (AV)

ANTENNA POLARITY & TEST DISTANCE: HORIZONTAL AT 3 M

NO.	FREQ. (MHz)	EMISSION LEVEL (dBuV/m)	LIMIT (dBuV/m)	MARGIN (dB)	ANTENNA HEIGHT (m)	TABLE ANGLE (Degree)	RAW VALUE (dBuV)	CORRECTION FACTOR (dB/m)
1	*5200.00	108.6 PK			1.00 H	328	104.74	3.86
2	*5200.00	98.2 AV			1.00 H	328	94.34	3.86
3	5360.00	51.6 PK	74.0	-22.4	1.03 H	182	47.47	4.13
4	5360.00	41.1 AV	54.0	-12.9	1.03 H	182	36.97	4.13
5	#10400.00	55.7 PK	74.0	-18.3	1.00 H	68	46.28	9.42
6	#10400.00	42.0 AV	54.0	-12.0	1.00 H	68	32.58	9.42
7	15600.00	61.7 PK	74.0	-12.3	1.09 H	207	47.01	14.69
8	15600.00	48.3 AV	54.0	-5.7	1.09 H	207	33.61	14.69

ANTENNA POLARITY & TEST DISTANCE: VERTICAL AT 3 M

NO.	FREQ. (MHz)	EMISSION LEVEL (dBuV/m)	LIMIT (dBuV/m)	MARGIN (dB)	ANTENNA HEIGHT (m)	TABLE ANGLE (Degree)	RAW VALUE (dBuV)	CORRECTION FACTOR (dB/m)
1	5000.00	56.7 PK	74.0	-17.3	1.08 V	358	53.65	3.05
2	5000.00	43.7 AV	54.0	-10.3	1.08 V	358	40.65	3.05
3	5120.00	57.8 PK	74.0	-16.2	1.15 V	360	54.30	3.50
4	5120.00	48.7 AV	54.0	-5.3	1.15 V	360	45.20	3.50
5	*5200.00	119.7 PK			1.12 V	360	115.84	3.86
6	*5200.00	110.8 AV			1.12 V	360	106.94	3.86
7	5360.00	62.0 PK	74.0	-12.0	1.31 V	358	57.87	4.13
8	5360.00	53.1 AV	54.0	-0.9	1.31 V	358	48.97	4.13
9	#10400.00	54.0 PK	74.0	-20.0	1.08 V	2	44.58	9.42
10	#10400.00	41.2 AV	54.0	-12.8	1.08 V	2	31.78	9.42
11	15600.00	59.2 PK	74.0	-14.8	1.00 V	210	44.51	14.69
12	15600.00	48.8 AV	54.0	-5.2	1.00 V	210	34.11	14.69

REMARKS:

1. Emission Level(dBuV/m) = Raw Value(dBuV) + Correction Factor(dB/m)
2. Correction Factor(dB/m) = Antenna Factor(dB/m) + Cable Factor(dB) – Pre-Amplifier Factor(dB)
3. The other emission levels were very low against the limit.
4. Margin value = Emission Level – Limit value
5. " * ": Fundamental frequency.
6. " # ": The radiated frequency is out of the restricted band.

CHANNEL	TX Channel 48	DETECTOR FUNCTION	Peak (PK)
FREQUENCY RANGE	1GHz ~ 40GHz		Average (AV)

ANTENNA POLARITY & TEST DISTANCE: HORIZONTAL AT 3 M

NO.	FREQ. (MHz)	EMISSION LEVEL (dBuV/m)	LIMIT (dBuV/m)	MARGIN (dB)	ANTENNA HEIGHT (m)	TABLE ANGLE (Degree)	RAW VALUE (dBuV)	CORRECTION FACTOR (dB/m)
1	*5240.00	103.2 PK			1.00 H	333	99.32	3.88
2	*5240.00	93.1 AV			1.00 H	333	89.22	3.88
3	5400.00	51.3 PK	74.0	-22.7	1.05 H	154	47.00	4.30
4	5400.00	40.6 AV	54.0	-13.4	1.05 H	154	36.30	4.30
5	#10480.00	56.2 PK	74.0	-17.8	1.00 H	69	46.60	9.60
6	#10480.00	42.3 AV	54.0	-11.7	1.00 H	69	32.70	9.60
7	15720.00	62.9 PK	74.0	-11.1	1.00 H	204	48.75	14.15
8	15720.00	49.3 AV	54.0	-4.7	1.00 H	204	35.15	14.15

ANTENNA POLARITY & TEST DISTANCE: VERTICAL AT 3 M

NO.	FREQ. (MHz)	EMISSION LEVEL (dBuV/m)	LIMIT (dBuV/m)	MARGIN (dB)	ANTENNA HEIGHT (m)	TABLE ANGLE (Degree)	RAW VALUE (dBuV)	CORRECTION FACTOR (dB/m)
1	5120.00	59.4 PK	74.0	-14.6	1.15 V	360	55.90	3.50
2	5120.00	47.2 AV	54.0	-6.8	1.15 V	360	43.70	3.50
3	*5240.00	114.2 PK			1.23 V	357	110.32	3.88
4	*5240.00	105.3 AV			1.23 V	357	101.42	3.88
5	5400.00	63.7 PK	74.0	-10.3	1.29 V	357	59.40	4.30
6	5400.00	53.5 AV	54.0	-0.5	1.29 V	357	49.20	4.30
7	#10480.00	54.2 PK	74.0	-19.8	1.00 V	0	44.60	9.60
8	#10480.00	41.2 AV	54.0	-12.8	1.00 V	0	31.60	9.60
9	15720.00	59.0 PK	74.0	-15.0	1.00 V	194	44.85	14.15
10	15720.00	48.7 AV	54.0	-5.3	1.00 V	194	34.55	14.15

REMARKS:

1. Emission Level(dBuV/m) = Raw Value(dBuV) + Correction Factor(dB/m)
2. Correction Factor(dB/m) = Antenna Factor(dB/m) + Cable Factor(dB) – Pre-Amplifier Factor(dB)
3. The other emission levels were very low against the limit.
4. Margin value = Emission Level – Limit value
5. " * ": Fundamental frequency.
6. " # ": The radiated frequency is out of the restricted band.

CHANNEL	TX Channel 149	DETECTOR FUNCTION	Peak (PK)
FREQUENCY RANGE	1GHz ~ 40GHz		Average (AV)

ANTENNA POLARITY & TEST DISTANCE: HORIZONTAL AT 3 M

NO.	FREQ. (MHz)	EMISSION LEVEL (dBuV/m)	LIMIT (dBuV/m)	MARGIN (dB)	ANTENNA HEIGHT (m)	TABLE ANGLE (Degree)	RAW VALUE (dBuV)	CORRECTION FACTOR (dB/m)
1	#5715.00	59.2 PK	68.2	-9.0	2.02 H	121	17.32	41.88
2	#5725.00	70.0 PK	78.2	-8.2	1.97 H	116	28.09	41.91
3	*5745.00	110.1 PK			1.12 H	312	68.17	41.93
4	*5745.00	100.4 AV			1.12 H	312	58.47	41.93
5	#5905.00	56.5 PK	68.2	-11.7	2.02 H	113	14.25	42.25
6	11490.00	55.3 PK	74.0	-18.7	1.00 H	59	7.55	47.75
7	11490.00	41.8 AV	54.0	-12.2	1.00 H	59	-5.95	47.75
8	#17235.00	61.6 PK	68.2	-6.6	1.00 H	205	5.85	55.75

ANTENNA POLARITY & TEST DISTANCE: VERTICAL AT 3 M

NO.	FREQ. (MHz)	EMISSION LEVEL (dBuV/m)	LIMIT (dBuV/m)	MARGIN (dB)	ANTENNA HEIGHT (m)	TABLE ANGLE (Degree)	RAW VALUE (dBuV)	CORRECTION FACTOR (dB/m)
1	#5715.00	68.1 PK	68.2	-0.1	1.20 V	360	26.22	41.88
2	#5725.00	76.4 PK	78.2	-1.8	1.20 V	360	34.49	41.91
3	*5745.00	122.4 PK			1.30 V	360	80.47	41.93
4	*5745.00	113.1 AV			1.30 V	360	71.17	41.93
5	#5905.00	65.1 PK	68.2	-3.1	1.27 V	360	22.85	42.25
6	11490.00	54.2 PK	74.0	-19.8	1.00 V	32	6.45	47.75
7	11490.00	41.4 AV	54.0	-12.6	1.00 V	32	-6.35	47.75
8	#17235.00	60.0 PK	68.2	-8.2	1.00 V	212	4.25	55.75

REMARKS:

1. Emission Level(dBuV/m) = Raw Value(dBuV) + Correction Factor(dB/m)
2. Correction Factor(dB/m) = Antenna Factor(dB/m) + Cable Factor(dB) – Pre-Amplifier Factor(dB)
3. The other emission levels were very low against the limit.
4. Margin value = Emission Level – Limit value
5. " * ": Fundamental frequency.
6. " # ": The radiated frequency is out of the restricted band.

CHANNEL	TX Channel 157	DETECTOR FUNCTION	Peak (PK)
FREQUENCY RANGE	1GHz ~ 40GHz		Average (AV)

ANTENNA POLARITY & TEST DISTANCE: HORIZONTAL AT 3 M

NO.	FREQ. (MHz)	EMISSION LEVEL (dBuV/m)	LIMIT (dBuV/m)	MARGIN (dB)	ANTENNA HEIGHT (m)	TABLE ANGLE (Degree)	RAW VALUE (dBuV)	CORRECTION FACTOR (dB/m)
1	#5698.00	58.6 PK	68.2	-9.6	1.08 H	350	16.73	41.87
2	*5785.00	117.1 PK			1.03 H	341	75.10	42.00
3	*5785.00	106.5 AV			1.03 H	341	64.50	42.00
4	#5865.00	56.9 PK	68.2	-11.3	1.07 H	353	14.74	42.16
5	#5944.00	56.7 PK	68.2	-11.5	1.09 H	331	14.42	42.28
6	11570.00	56.0 PK	74.0	-18.0	1.00 H	68	8.21	47.79
7	11570.00	42.3 AV	54.0	-11.7	1.00 H	68	-5.49	47.79
8	#17355.00	62.4 PK	68.2	-5.8	1.00 H	201	6.46	55.94

ANTENNA POLARITY & TEST DISTANCE: VERTICAL AT 3 M

NO.	FREQ. (MHz)	EMISSION LEVEL (dBuV/m)	LIMIT (dBuV/m)	MARGIN (dB)	ANTENNA HEIGHT (m)	TABLE ANGLE (Degree)	RAW VALUE (dBuV)	CORRECTION FACTOR (dB/m)
1	#5698.00	67.3 PK	68.2	-0.9	1.21 V	355	25.43	41.87
2	*5785.00	128.1 PK			1.19 V	360	86.10	42.00
3	*5785.00	118.9 AV			1.19 V	360	76.90	42.00
4	#5865.00	67.2 PK	68.2	-1.0	1.27 V	360	25.04	42.16
5	#5944.00	65.2 PK	68.2	-3.0	1.25 V	360	22.92	42.28
6	11570.00	53.8 PK	74.0	-20.2	1.00 V	40	6.01	47.79
7	11570.00	40.8 AV	54.0	-13.2	1.00 V	40	-6.99	47.79
8	#17355.00	60.3 PK	68.2	-7.9	1.00 V	204	4.36	55.94

REMARKS:

1. Emission Level(dBuV/m) = Raw Value(dBuV) + Correction Factor(dB/m)
2. Correction Factor(dB/m) = Antenna Factor(dB/m) + Cable Factor(dB) – Pre-Amplifier Factor(dB)
3. The other emission levels were very low against the limit.
4. Margin value = Emission Level – Limit value
5. " * ": Fundamental frequency.
6. " # ": The radiated frequency is out of the restricted band.

CHANNEL	TX Channel 165	DETECTOR FUNCTION	Peak (PK)
FREQUENCY RANGE	1GHz ~ 40GHz		Average (AV)

ANTENNA POLARITY & TEST DISTANCE: HORIZONTAL AT 3 M

NO.	FREQ. (MHz)	EMISSION LEVEL (dBuV/m)	LIMIT (dBuV/m)	MARGIN (dB)	ANTENNA HEIGHT (m)	TABLE ANGLE (Degree)	RAW VALUE (dBuV)	CORRECTION FACTOR (dB/m)
1	*5825.00	111.3 PK			1.11 H	324	69.23	42.07
2	*5825.00	102.6 AV			1.11 H	324	60.53	42.07
3	#5850.00	69.4 PK	78.2	-8.8	1.89 H	102	27.27	42.13
4	#5860.00	59.1 PK	68.2	-9.1	1.99 H	108	16.94	42.16
5	#5985.00	56.7 PK	68.2	-11.5	1.96 H	112	14.41	42.29
6	11650.00	55.2 PK	74.0	-18.8	1.00 H	53	7.35	47.85
7	11650.00	41.7 AV	54.0	-12.3	1.00 H	53	-6.15	47.85
8	#17475.00	61.2 PK	68.2	-7.0	1.00 H	218	5.05	56.15

ANTENNA POLARITY & TEST DISTANCE: VERTICAL AT 3 M

NO.	FREQ. (MHz)	EMISSION LEVEL (dBuV/m)	LIMIT (dBuV/m)	MARGIN (dB)	ANTENNA HEIGHT (m)	TABLE ANGLE (Degree)	RAW VALUE (dBuV)	CORRECTION FACTOR (dB/m)
1	*5825.00	124.6 PK			1.18 V	360	82.53	42.07
2	*5825.00	115.4 AV			1.18 V	360	73.33	42.07
3	#5850.00	77.1 PK	78.2	-1.1	1.18 V	360	34.97	42.13
4	#5860.00	66.8 PK	68.2	-1.4	1.18 V	360	24.64	42.16
5	#5985.00	65.5 PK	68.2	-2.7	1.22 V	360	23.21	42.29
6	11650.00	54.0 PK	74.0	-20.0	1.00 V	26	6.15	47.85
7	11650.00	41.1 AV	54.0	-12.9	1.00 V	26	-6.75	47.85
8	#17475.00	60.1 PK	68.2	-8.1	1.00 V	212	3.95	56.15

REMARKS:

1. Emission Level(dBuV/m) = Raw Value(dBuV) + Correction Factor(dB/m)
2. Correction Factor(dB/m) = Antenna Factor(dB/m) + Cable Factor(dB) – Pre-Amplifier Factor(dB)
3. The other emission levels were very low against the limit.
4. Margin value = Emission Level – Limit value
5. " * ": Fundamental frequency.
6. " # ": The radiated frequency is out of the restricted band.

802.11ac (VHT20)

CHANNEL	TX Channel 36	DETECTOR FUNCTION	Peak (PK)
FREQUENCY RANGE	1GHz ~ 40GHz		Average (AV)

ANTENNA POLARITY & TEST DISTANCE: HORIZONTAL AT 3 M								
NO.	FREQ. (MHz)	EMISSION LEVEL (dBuV/m)	LIMIT (dBuV/m)	MARGIN (dB)	ANTENNA HEIGHT (m)	TABLE ANGLE (Degree)	RAW VALUE (dBuV)	CORRECTION FACTOR (dB/m)
1	5120.00	51.1 PK	74.0	-22.9	1.00 H	105	47.56	3.50
2	5120.00	51.4 AV	54.0	-2.6	1.00 H	105	47.90	3.50
3	5150.00	62.4 PK	74.0	-11.6	1.12 H	182	58.77	3.63
4	5150.00	47.2 AV	54.0	-6.8	1.12 H	182	43.57	3.63
5	*5180.00	109.2 PK			1.06 H	331	105.43	3.77
6	*5180.00	99.2 AV			1.06 H	331	95.43	3.77
7	#10360.00	54.9 PK	74.0	-19.1	1.00 H	79	45.53	9.37
8	#10360.00	41.4 AV	54.0	-12.6	1.00 H	79	32.03	9.37
9	15540.00	62.3 PK	74.0	-11.7	1.03 H	188	47.89	14.41
10	15540.00	48.8 AV	54.0	-5.2	1.03 H	188	34.39	14.41

ANTENNA POLARITY & TEST DISTANCE: VERTICAL AT 3 M								
NO.	FREQ. (MHz)	EMISSION LEVEL (dBuV/m)	LIMIT (dBuV/m)	MARGIN (dB)	ANTENNA HEIGHT (m)	TABLE ANGLE (Degree)	RAW VALUE (dBuV)	CORRECTION FACTOR (dB/m)
1	5120.00	61.1 PK	74.0	-12.9	1.14 V	360	57.60	3.50
2	5120.00	48.7 AV	54.0	-5.3	1.14 V	360	45.20	3.50
3	5150.00	72.4 PK	74.0	-1.6	1.38 V	360	68.77	3.63
4	5150.00	53.1 AV	54.0	-0.9	1.38 V	360	49.47	3.63
5	*5180.00	121.0 PK			1.36 V	360	117.23	3.77
6	*5180.00	111.3 AV			1.36 V	360	107.53	3.77
7	5440.00	59.7 PK	74.0	-14.3	1.05 V	360	55.38	4.32
8	5440.00	46.7 AV	54.0	-7.3	1.05 V	360	42.38	4.32
9	#10360.00	53.9 PK	74.0	-20.1	1.07 V	22	44.53	9.37
10	#10360.00	40.8 AV	54.0	-13.2	1.07 V	22	31.43	9.37
11	15540.00	59.8 PK	74.0	-14.2	1.05 V	193	45.39	14.41
12	15540.00	49.6 AV	54.0	-4.4	1.05 V	193	35.19	14.41

REMARKS:

1. Emission Level(dBuV/m) = Raw Value(dBuV) + Correction Factor(dB/m)
2. Correction Factor(dB/m) = Antenna Factor(dB/m) + Cable Factor(dB) – Pre-Amplifier Factor(dB)
3. The other emission levels were very low against the limit.
4. Margin value = Emission Level – Limit value
5. " * ": Fundamental frequency.
6. " # ": The radiated frequency is out of the restricted band.

CHANNEL	TX Channel 40	DETECTOR FUNCTION	Peak (PK)
FREQUENCY RANGE	1GHz ~ 40GHz		Average (AV)

ANTENNA POLARITY & TEST DISTANCE: HORIZONTAL AT 3 M

NO.	FREQ. (MHz)	EMISSION LEVEL (dBuV/m)	LIMIT (dBuV/m)	MARGIN (dB)	ANTENNA HEIGHT (m)	TABLE ANGLE (Degree)	RAW VALUE (dBuV)	CORRECTION FACTOR (dB/m)
1	5120.00	51.2 PK	74.0	-22.8	1.00 H	156	47.70	3.50
2	5120.00	41.0 AV	54.0	-13.0	1.00 H	156	37.50	3.50
3	*5200.00	108.5 PK			1.04 H	338	104.64	3.86
4	*5200.00	98.1 AV			1.04 H	338	94.24	3.86
5	5360.00	51.8 PK	74.0	-22.2	1.00 H	175	47.67	4.13
6	5360.00	41.3 AV	54.0	-12.7	1.00 H	175	37.17	4.13
7	#10400.00	55.8 PK	74.0	-18.2	1.00 H	63	46.38	9.42
8	#10400.00	41.9 AV	54.0	-12.1	1.00 H	63	32.48	9.42
9	15600.00	62.0 PK	74.0	-12.0	1.08 H	202	47.31	14.69
10	15600.00	48.4 AV	54.0	-5.6	1.08 H	202	33.71	14.69

ANTENNA POLARITY & TEST DISTANCE: VERTICAL AT 3 M

NO.	FREQ. (MHz)	EMISSION LEVEL (dBuV/m)	LIMIT (dBuV/m)	MARGIN (dB)	ANTENNA HEIGHT (m)	TABLE ANGLE (Degree)	RAW VALUE (dBuV)	CORRECTION FACTOR (dB/m)
1	5120.00	64.8 PK	74.0	-9.2	1.04 V	357	61.30	3.50
2	5120.00	53.6 AV	54.0	-0.4	1.04 V	357	50.10	3.50
3	*5200.00	119.0 PK			1.09 V	359	115.14	3.86
4	*5200.00	110.4 AV			1.09 V	359	106.54	3.86
5	5360.00	63.2 PK	74.0	-10.8	1.31 V	360	59.07	4.13
6	5360.00	51.7 AV	54.0	-2.3	1.31 V	360	47.57	4.13
7	#10400.00	54.9 PK	74.0	-19.1	1.01 V	23	45.48	9.42
8	#10400.00	41.5 AV	54.0	-12.5	1.01 V	23	32.08	9.42
9	15600.00	60.0 PK	74.0	-14.0	1.00 V	209	45.31	14.69
10	15600.00	49.5 AV	54.0	-4.5	1.00 V	209	34.81	14.69

REMARKS:

1. Emission Level(dBuV/m) = Raw Value(dBuV) + Correction Factor(dB/m)
2. Correction Factor(dB/m) = Antenna Factor(dB/m) + Cable Factor(dB) – Pre-Amplifier Factor(dB)
3. The other emission levels were very low against the limit.
4. Margin value = Emission Level – Limit value
5. " * ": Fundamental frequency.
6. " # ": The radiated frequency is out of the restricted band.

CHANNEL	TX Channel 48	DETECTOR FUNCTION	Peak (PK)
FREQUENCY RANGE	1GHz ~ 40GHz		Average (AV)

ANTENNA POLARITY & TEST DISTANCE: HORIZONTAL AT 3 M

NO.	FREQ. (MHz)	EMISSION LEVEL (dBuV/m)	LIMIT (dBuV/m)	MARGIN (dB)	ANTENNA HEIGHT (m)	TABLE ANGLE (Degree)	RAW VALUE (dBuV)	CORRECTION FACTOR (dB/m)
1	*5240.00	103.5 PK			1.02 H	314	99.62	3.88
2	*5240.00	93.5 AV			1.02 H	314	89.62	3.88
3	5400.00	51.6 PK	74.0	-22.4	1.01 H	180	47.30	4.30
4	5400.00	41.3 AV	54.0	-12.7	1.01 H	180	37.00	4.30
5	#10480.00	55.1 PK	74.0	-18.9	1.00 H	73	45.50	9.60
6	#10480.00	41.3 AV	54.0	-12.7	1.00 H	73	31.70	9.60
7	15720.00	62.4 PK	74.0	-11.6	1.05 H	215	48.25	14.15
8	15720.00	48.7 AV	54.0	-5.3	1.05 H	215	34.55	14.15

ANTENNA POLARITY & TEST DISTANCE: VERTICAL AT 3 M

NO.	FREQ. (MHz)	EMISSION LEVEL (dBuV/m)	LIMIT (dBuV/m)	MARGIN (dB)	ANTENNA HEIGHT (m)	TABLE ANGLE (Degree)	RAW VALUE (dBuV)	CORRECTION FACTOR (dB/m)
1	*5240.00	114.1 PK			1.29 V	360	110.22	3.88
2	*5240.00	105.2 AV			1.29 V	360	101.32	3.88
3	5400.00	62.3 PK	74.0	-11.7	1.18 V	357	58.00	4.30
4	5400.00	53.1 AV	54.0	-0.9	1.18 V	357	48.80	4.30
5	#10480.00	54.5 PK	74.0	-19.5	1.04 V	21	44.90	9.60
6	#10480.00	41.2 AV	54.0	-12.8	1.04 V	21	31.60	9.60
7	15720.00	60.0 PK	74.0	-14.0	1.00 V	217	45.85	14.15
8	15720.00	49.5 AV	54.0	-4.5	1.00 V	217	35.35	14.15

REMARKS:

1. Emission Level(dBuV/m) = Raw Value(dBuV) + Correction Factor(dB/m)
2. Correction Factor(dB/m) = Antenna Factor(dB/m) + Cable Factor(dB) – Pre-Amplifier Factor(dB)
3. The other emission levels were very low against the limit.
4. Margin value = Emission Level – Limit value
5. " * ": Fundamental frequency.
6. " # ": The radiated frequency is out of the restricted band.

CHANNEL	TX Channel 149	DETECTOR FUNCTION	Peak (PK)
FREQUENCY RANGE	1GHz ~ 40GHz		Average (AV)

ANTENNA POLARITY & TEST DISTANCE: HORIZONTAL AT 3 M

NO.	FREQ. (MHz)	EMISSION LEVEL (dBuV/m)	LIMIT (dBuV/m)	MARGIN (dB)	ANTENNA HEIGHT (m)	TABLE ANGLE (Degree)	RAW VALUE (dBuV)	CORRECTION FACTOR (dB/m)
1	#5715.00	59.5 PK	68.2	-8.7	1.11 H	341	17.62	41.88
2	#5725.00	70.0 PK	78.2	-8.2	1.11 H	341	28.09	41.91
3	*5745.00	111.2 PK			1.11 H	341	69.27	41.93
4	*5745.00	100.1 AV			1.11 H	341	58.17	41.93
5	#5905.00	56.8 PK	68.2	-11.4	1.04 H	324	14.55	42.25
6	11490.00	55.8 PK	74.0	-18.2	1.00 H	79	8.05	47.75
7	11490.00	42.3 AV	54.0	-11.7	1.00 H	79	-5.45	47.75
8	#17235.00	61.7 PK	68.2	-6.5	1.00 H	201	5.95	55.75

ANTENNA POLARITY & TEST DISTANCE: VERTICAL AT 3 M

NO.	FREQ. (MHz)	EMISSION LEVEL (dBuV/m)	LIMIT (dBuV/m)	MARGIN (dB)	ANTENNA HEIGHT (m)	TABLE ANGLE (Degree)	RAW VALUE (dBuV)	CORRECTION FACTOR (dB/m)
1	#5715.00	68.1 PK	68.2	-0.1	1.14 V	360	26.22	41.88
2	#5725.00	78.1 PK	78.2	-0.1	1.18 V	360	36.19	41.91
3	*5745.00	122.1 PK			1.21 V	360	80.17	41.93
4	*5745.00	112.5 AV			1.21 V	360	70.57	41.93
5	#5905.00	65.6 PK	68.2	-2.6	1.29 V	355	23.35	42.25
6	11490.00	54.2 PK	74.0	-19.8	1.00 V	34	6.45	47.75
7	11490.00	40.8 AV	54.0	-13.2	1.00 V	34	-6.95	47.75
8	#17235.00	59.9 PK	68.2	-8.3	1.00 V	206	4.15	55.75

REMARKS:

1. Emission Level(dBuV/m) = Raw Value(dBuV) + Correction Factor(dB/m)
2. Correction Factor(dB/m) = Antenna Factor(dB/m) + Cable Factor(dB) – Pre-Amplifier Factor(dB)
3. The other emission levels were very low against the limit.
4. Margin value = Emission Level – Limit value
5. " * ": Fundamental frequency.
6. " # ": The radiated frequency is out of the restricted band.

CHANNEL	TX Channel 157	DETECTOR FUNCTION	Peak (PK)
FREQUENCY RANGE	1GHz ~ 40GHz		Average (AV)

ANTENNA POLARITY & TEST DISTANCE: HORIZONTAL AT 3 M

NO.	FREQ. (MHz)	EMISSION LEVEL (dBuV/m)	LIMIT (dBuV/m)	MARGIN (dB)	ANTENNA HEIGHT (m)	TABLE ANGLE (Degree)	RAW VALUE (dBuV)	CORRECTION FACTOR (dB/m)
1	#5698.00	58.0 PK	68.2	-10.2	1.05 H	316	16.13	41.87
2	*5785.00	115.7 PK			1.04 H	321	73.70	42.00
3	*5785.00	106.3 AV			1.04 H	321	64.30	42.00
4	#5865.00	57.7 PK	68.2	-10.5	1.00 H	319	15.54	42.16
5	#5944.00	57.2 PK	68.2	-11.0	1.09 H	320	14.92	42.28
6	11570.00	55.9 PK	74.0	-18.1	1.00 H	62	8.11	47.79
7	11570.00	42.4 AV	54.0	-11.6	1.00 H	62	-5.39	47.79
8	#17355.00	61.9 PK	68.2	-6.3	1.04 H	203	5.96	55.94

ANTENNA POLARITY & TEST DISTANCE: VERTICAL AT 3 M

NO.	FREQ. (MHz)	EMISSION LEVEL (dBuV/m)	LIMIT (dBuV/m)	MARGIN (dB)	ANTENNA HEIGHT (m)	TABLE ANGLE (Degree)	RAW VALUE (dBuV)	CORRECTION FACTOR (dB/m)
1	#5698.00	67.6 PK	68.2	-0.6	1.22 V	344	25.73	41.87
2	*5785.00	128.0 PK			1.14 V	348	86.00	42.00
3	*5785.00	118.9 AV			1.14 V	348	76.90	42.00
4	#5865.00	66.9 PK	68.2	-1.3	1.29 V	360	24.74	42.16
5	#5944.00	65.0 PK	68.2	-3.2	1.17 V	360	22.72	42.28
6	11570.00	54.8 PK	74.0	-19.2	1.01 V	28	7.01	47.79
7	11570.00	41.6 AV	54.0	-12.4	1.01 V	28	-6.19	47.79
8	#17355.00	59.9 PK	68.2	-8.3	1.00 V	207	3.96	55.94

REMARKS:

1. Emission Level(dBuV/m) = Raw Value(dBuV) + Correction Factor(dB/m)
2. Correction Factor(dB/m) = Antenna Factor(dB/m) + Cable Factor(dB) – Pre-Amplifier Factor(dB)
3. The other emission levels were very low against the limit.
4. Margin value = Emission Level – Limit value
5. " * ": Fundamental frequency.
6. " # ": The radiated frequency is out of the restricted band.

CHANNEL	TX Channel 165	DETECTOR FUNCTION	Peak (PK)
FREQUENCY RANGE	1GHz ~ 40GHz		Average (AV)

ANTENNA POLARITY & TEST DISTANCE: HORIZONTAL AT 3 M

NO.	FREQ. (MHz)	EMISSION LEVEL (dBuV/m)	LIMIT (dBuV/m)	MARGIN (dB)	ANTENNA HEIGHT (m)	TABLE ANGLE (Degree)	RAW VALUE (dBuV)	CORRECTION FACTOR (dB/m)
1	*5825.00	111.3 PK			1.04 H	337	69.23	42.07
2	*5825.00	102.1 AV			1.04 H	337	60.03	42.07
3	#5850.00	69.6 PK	78.2	-8.6	1.04 H	337	27.47	42.13
4	#5860.00	58.8 PK	68.2	-9.4	1.04 H	337	16.64	42.16
5	11650.00	55.1 PK	74.0	-18.9	1.00 H	50	7.25	47.85
6	11650.00	41.4 AV	54.0	-12.6	1.00 H	50	-6.45	47.85
7	#17475.00	61.6 PK	68.2	-6.6	1.03 H	195	5.45	56.15

ANTENNA POLARITY & TEST DISTANCE: VERTICAL AT 3 M

NO.	FREQ. (MHz)	EMISSION LEVEL (dBuV/m)	LIMIT (dBuV/m)	MARGIN (dB)	ANTENNA HEIGHT (m)	TABLE ANGLE (Degree)	RAW VALUE (dBuV)	CORRECTION FACTOR (dB/m)
1	*5825.00	123.4 PK			1.27 V	360	81.33	42.07
2	*5825.00	114.1 AV			1.27 V	360	72.03	42.07
3	#5850.00	77.1 PK	78.2	-1.1	1.27 V	360	34.97	42.13
4	#5860.00	68.1 PK	68.2	-0.1	1.28 V	359	25.94	42.16
5	#5985.00	65.3 PK	68.2	-2.9	1.26 V	358	23.01	42.29
6	11650.00	54.2 PK	74.0	-19.8	1.00 V	35	6.35	47.85
7	11650.00	40.9 AV	54.0	-13.1	1.00 V	35	-6.95	47.85
8	#17475.00	60.3 PK	68.2	-7.9	1.00 V	208	4.15	56.15

REMARKS:

1. Emission Level(dBuV/m) = Raw Value(dBuV) + Correction Factor(dB/m)
2. Correction Factor(dB/m) = Antenna Factor(dB/m) + Cable Factor(dB) – Pre-Amplifier Factor(dB)
3. The other emission levels were very low against the limit.
4. Margin value = Emission Level – Limit value
5. " * ": Fundamental frequency.
6. " # ": The radiated frequency is out of the restricted band.

802.11ac (VHT40)

CHANNEL	TX Channel 38	DETECTOR FUNCTION	Peak (PK)
FREQUENCY RANGE	1GHz ~ 40GHz		Average (AV)

ANTENNA POLARITY & TEST DISTANCE: HORIZONTAL AT 3 M

NO.	FREQ. (MHz)	EMISSION LEVEL (dBuV/m)	LIMIT (dBuV/m)	MARGIN (dB)	ANTENNA HEIGHT (m)	TABLE ANGLE (Degree)	RAW VALUE (dBuV)	CORRECTION FACTOR (dB/m)
1	5150.00	62.4 PK	74.0	-11.6	1.10 H	169	58.77	3.63
2	5150.00	47.0 AV	54.0	-7.0	1.10 H	169	43.37	3.63
3	*5190.00	101.6 PK			1.00 H	327	97.78	3.82
4	*5190.00	92.1 AV			1.00 H	327	88.28	3.82
5	#10380.00	55.5 PK	74.0	-18.5	1.00 H	81	46.10	9.40
6	#10380.00	41.8 AV	54.0	-12.2	1.00 H	81	32.40	9.40
7	15570.00	62.5 PK	74.0	-11.5	1.05 H	203	47.95	14.55
8	15570.00	49.0 AV	54.0	-5.0	1.05 H	203	34.45	14.55

ANTENNA POLARITY & TEST DISTANCE: VERTICAL AT 3 M

NO.	FREQ. (MHz)	EMISSION LEVEL (dBuV/m)	LIMIT (dBuV/m)	MARGIN (dB)	ANTENNA HEIGHT (m)	TABLE ANGLE (Degree)	RAW VALUE (dBuV)	CORRECTION FACTOR (dB/m)
1	5150.00	67.9 PK	74.0	-6.1	1.14 V	360	64.27	3.63
2	5150.00	53.9 AV	54.0	-0.1	1.14 V	360	50.27	3.63
3	*5190.00	113.7 PK			1.13 V	360	109.88	3.82
4	*5190.00	104.0 AV			1.13 V	360	100.18	3.82
5	#10380.00	54.5 PK	74.0	-19.5	1.06 V	20	45.10	9.40
6	#10380.00	41.1 AV	54.0	-12.9	1.06 V	20	31.70	9.40
7	15570.00	59.0 PK	74.0	-15.0	1.00 V	191	44.45	14.55
8	15570.00	48.8 AV	54.0	-5.2	1.00 V	191	34.25	14.55

REMARKS:

- Emission Level(dBuV/m) = Raw Value(dBuV) + Correction Factor(dB/m)
- Correction Factor(dB/m) = Antenna Factor(dB/m) + Cable Factor(dB) – Pre-Amplifier Factor(dB)
- The other emission levels were very low against the limit.
- Margin value = Emission Level – Limit value
- " * ": Fundamental frequency.
- " # ": The radiated frequency is out of the restricted band.

CHANNEL	TX Channel 46	DETECTOR FUNCTION	Peak (PK)
FREQUENCY RANGE	1GHz ~ 40GHz		Average (AV)

ANTENNA POLARITY & TEST DISTANCE: HORIZONTAL AT 3 M

NO.	FREQ. (MHz)	EMISSION LEVEL (dBuV/m)	LIMIT (dBuV/m)	MARGIN (dB)	ANTENNA HEIGHT (m)	TABLE ANGLE (Degree)	RAW VALUE (dBuV)	CORRECTION FACTOR (dB/m)
1	5150.00	62.1 PK	74.0	-11.9	1.05 H	187	58.47	3.63
2	5150.00	46.8 AV	54.0	-7.2	1.05 H	187	43.17	3.63
3	*5230.00	103.9 PK			1.01 H	343	100.04	3.86
4	*5230.00	94.5 AV			1.01 H	343	90.64	3.86
5	5390.00	51.1 PK	74.0	-22.9	1.04 H	163	46.84	4.26
6	5390.00	40.9 AV	54.0	-13.1	1.04 H	163	36.64	4.26
7	#10460.00	55.2 PK	74.0	-18.8	1.00 H	76	45.64	9.56
8	#10460.00	41.7 AV	54.0	-12.3	1.00 H	76	32.14	9.56
9	15690.00	62.5 PK	74.0	-11.5	1.07 H	186	48.33	14.17
10	15690.00	49.0 AV	54.0	-5.0	1.07 H	186	34.83	14.17

ANTENNA POLARITY & TEST DISTANCE: VERTICAL AT 3 M

NO.	FREQ. (MHz)	EMISSION LEVEL (dBuV/m)	LIMIT (dBuV/m)	MARGIN (dB)	ANTENNA HEIGHT (m)	TABLE ANGLE (Degree)	RAW VALUE (dBuV)	CORRECTION FACTOR (dB/m)
1	5150.00	72.6 PK	74.0	-1.4	1.38 V	360	68.97	3.63
2	5150.00	52.7 AV	54.0	-1.3	1.38 V	360	49.07	3.63
3	*5230.00	115.9 PK			1.17 V	360	112.04	3.86
4	*5230.00	106.4 AV			1.17 V	360	102.54	3.86
5	5390.00	61.0 PK	74.0	-13.0	1.18 V	4	56.74	4.26
6	5390.00	52.8 AV	54.0	-1.2	1.18 V	4	48.54	4.26
7	#10460.00	54.2 PK	74.0	-19.8	1.09 V	11	44.64	9.56
8	#10460.00	41.0 AV	54.0	-13.0	1.09 V	11	31.44	9.56
9	15690.00	59.6 PK	74.0	-14.4	1.05 V	195	45.43	14.17
10	15690.00	49.5 AV	54.0	-4.5	1.05 V	195	35.33	14.17

REMARKS:

1. Emission Level(dBuV/m) = Raw Value(dBuV) + Correction Factor(dB/m)
2. Correction Factor(dB/m) = Antenna Factor(dB/m) + Cable Factor(dB) – Pre-Amplifier Factor(dB)
3. The other emission levels were very low against the limit.
4. Margin value = Emission Level – Limit value
5. " * ": Fundamental frequency.
6. " # ": The radiated frequency is out of the restricted band.

CHANNEL	TX Channel 151	DETECTOR FUNCTION	Peak (PK)
FREQUENCY RANGE	1GHz ~ 40GHz		Average (AV)

ANTENNA POLARITY & TEST DISTANCE: HORIZONTAL AT 3 M

NO.	FREQ. (MHz)	EMISSION LEVEL (dBuV/m)	LIMIT (dBuV/m)	MARGIN (dB)	ANTENNA HEIGHT (m)	TABLE ANGLE (Degree)	RAW VALUE (dBuV)	CORRECTION FACTOR (dB/m)
1	#5715.00	57.1 PK	68.2	-11.1	1.08 H	328	15.22	41.88
2	#5725.00	58.3 PK	78.2	-19.9	1.08 H	328	16.39	41.91
3	*5755.00	101.4 PK			1.08 H	328	59.45	41.95
4	*5755.00	91.2 AV			1.08 H	328	49.25	41.95
5	11510.00	55.3 PK	74.0	-18.7	1.00 H	50	7.54	47.76
6	11510.00	41.6 AV	54.0	-12.4	1.00 H	50	-6.16	47.76
7	#17265.00	61.4 PK	68.2	-6.8	1.05 H	205	5.58	55.82

ANTENNA POLARITY & TEST DISTANCE: VERTICAL AT 3 M

NO.	FREQ. (MHz)	EMISSION LEVEL (dBuV/m)	LIMIT (dBuV/m)	MARGIN (dB)	ANTENNA HEIGHT (m)	TABLE ANGLE (Degree)	RAW VALUE (dBuV)	CORRECTION FACTOR (dB/m)
1	#5715.00	68.1 PK	68.2	-0.1	1.21 V	360	26.22	41.88
2	#5725.00	72.1 PK	78.2	-6.1	1.21 V	360	30.19	41.91
3	*5755.00	115.7 PK			1.29 V	352	73.75	41.95
4	*5755.00	106.3 AV			1.29 V	352	64.35	41.95
5	11510.00	54.7 PK	74.0	-19.3	1.00 V	35	6.94	47.76
6	11510.00	41.6 AV	54.0	-12.4	1.00 V	35	-6.16	47.76
7	#17265.00	60.5 PK	68.2	-7.7	1.00 V	232	4.68	55.82

REMARKS:

1. Emission Level(dBuV/m) = Raw Value(dBuV) + Correction Factor(dB/m)
2. Correction Factor(dB/m) = Antenna Factor(dB/m) + Cable Factor(dB) – Pre-Amplifier Factor(dB)
3. The other emission levels were very low against the limit.
4. Margin value = Emission Level – Limit value
5. " * ": Fundamental frequency.
6. " # ": The radiated frequency is out of the restricted band.

CHANNEL	TX Channel 159	DETECTOR FUNCTION	Peak (PK)
FREQUENCY RANGE	1GHz ~ 40GHz		Average (AV)

ANTENNA POLARITY & TEST DISTANCE: HORIZONTAL AT 3 M

NO.	FREQ. (MHz)	EMISSION LEVEL (dBuV/m)	LIMIT (dBuV/m)	MARGIN (dB)	ANTENNA HEIGHT (m)	TABLE ANGLE (Degree)	RAW VALUE (dBuV)	CORRECTION FACTOR (dB/m)
1	*5795.00	108.7 PK			1.16 H	309	66.69	42.01
2	*5795.00	98.6 AV			1.16 H	309	56.59	42.01
3	#5850.00	69.9 PK	78.2	-8.3	1.16 H	309	27.77	42.13
4	#5860.00	59.6 PK	68.2	-8.6	1.16 H	309	17.44	42.16
5	11590.00	55.4 PK	74.0	-18.6	1.00 H	60	7.59	47.81
6	11590.00	42.0 AV	54.0	-12.0	1.00 H	60	-5.81	47.81
7	#17385.00	62.3 PK	68.2	-5.9	1.00 H	187	6.33	55.97

ANTENNA POLARITY & TEST DISTANCE: VERTICAL AT 3 M

NO.	FREQ. (MHz)	EMISSION LEVEL (dBuV/m)	LIMIT (dBuV/m)	MARGIN (dB)	ANTENNA HEIGHT (m)	TABLE ANGLE (Degree)	RAW VALUE (dBuV)	CORRECTION FACTOR (dB/m)
1	*5795.00	121.4 PK			1.28 V	360	79.39	42.01
2	*5795.00	111.9 AV			1.28 V	360	69.89	42.01
3	#5850.00	73.2 PK	78.2	-5.0	1.28 V	360	31.07	42.13
4	#5860.00	67.7 PK	68.2	-0.5	1.28 V	360	25.54	42.16
5	11590.00	54.4 PK	74.0	-19.6	1.00 V	17	6.59	47.81
6	11590.00	41.6 AV	54.0	-12.4	1.00 V	17	-6.21	47.81
7	#17385.00	60.5 PK	68.2	-7.7	1.00 V	210	4.53	55.97

REMARKS:

- Emission Level(dBuV/m) = Raw Value(dBuV) + Correction Factor(dB/m)
- Correction Factor(dB/m) = Antenna Factor(dB/m) + Cable Factor(dB) – Pre-Amplifier Factor(dB)
- The other emission levels were very low against the limit.
- Margin value = Emission Level – Limit value
- " * ": Fundamental frequency.
- " # ": The radiated frequency is out of the restricted band.

802.11ac (VHT80)

CHANNEL	TX Channel 42	DETECTOR FUNCTION	Peak (PK)
FREQUENCY RANGE	1GHz ~ 40GHz		Average (AV)

ANTENNA POLARITY & TEST DISTANCE: HORIZONTAL AT 3 M

NO.	FREQ. (MHz)	EMISSION LEVEL (dBuV/m)	LIMIT (dBuV/m)	MARGIN (dB)	ANTENNA HEIGHT (m)	TABLE ANGLE (Degree)	RAW VALUE (dBuV)	CORRECTION FACTOR (dB/m)
1	5150.00	61.5 PK	74.0	-12.5	1.12 H	178	57.87	3.63
2	5150.00	46.4 AV	54.0	-7.6	1.12 H	178	42.77	3.63
3	*5210.00	98.4 PK			1.01 H	337	94.55	3.85
4	*5210.00	87.1 AV			1.01 H	337	83.25	3.85
5	5370.00	51.0 PK	74.0	-23.0	1.00 H	164	46.82	4.18
6	5370.00	40.5 AV	54.0	-13.5	1.00 H	164	36.32	4.18
7	#10420.00	55.7 PK	74.0	-18.3	1.01 H	56	46.24	9.46
8	#10420.00	41.9 AV	54.0	-12.1	1.01 H	56	32.44	9.46
9	15630.00	62.1 PK	74.0	-11.9	1.00 H	214	47.58	14.52
10	15630.00	48.7 AV	54.0	-5.3	1.00 H	214	34.18	14.52

ANTENNA POLARITY & TEST DISTANCE: VERTICAL AT 3 M

NO.	FREQ. (MHz)	EMISSION LEVEL (dBuV/m)	LIMIT (dBuV/m)	MARGIN (dB)	ANTENNA HEIGHT (m)	TABLE ANGLE (Degree)	RAW VALUE (dBuV)	CORRECTION FACTOR (dB/m)
1	5150.00	68.0 PK	74.0	-6.0	1.14 V	360	64.37	3.63
2	5150.00	53.9 AV	54.0	-0.1	1.14 V	360	50.27	3.63
3	*5210.00	110.2 PK			1.35 V	360	106.35	3.85
4	*5210.00	99.7 AV			1.35 V	360	95.85	3.85
5	5370.00	58.2 PK	74.0	-15.8	1.00 V	174	54.02	4.18
6	5370.00	48.4 AV	54.0	-5.6	1.00 V	174	44.22	4.18
7	#10420.00	54.1 PK	74.0	-19.9	1.10 V	17	44.64	9.46
8	#10420.00	40.9 AV	54.0	-13.1	1.10 V	17	31.44	9.46
9	15630.00	59.6 PK	74.0	-14.4	1.06 V	214	45.08	14.52
10	15630.00	49.3 AV	54.0	-4.7	1.06 V	214	34.78	14.52

REMARKS:

1. Emission Level(dBuV/m) = Raw Value(dBuV) + Correction Factor(dB/m)
2. Correction Factor(dB/m) = Antenna Factor(dB/m) + Cable Factor(dB) – Pre-Amplifier Factor(dB)
3. The other emission levels were very low against the limit.
4. Margin value = Emission Level – Limit value
5. " * ": Fundamental frequency.
6. " # ": The radiated frequency is out of the restricted band.

CHANNEL	TX Channel 155	DETECTOR FUNCTION	Peak (PK)
FREQUENCY RANGE	1GHz ~ 40GHz		Average (AV)

ANTENNA POLARITY & TEST DISTANCE: HORIZONTAL AT 3 M

NO.	FREQ. (MHz)	EMISSION LEVEL (dBuV/m)	LIMIT (dBuV/m)	MARGIN (dB)	ANTENNA HEIGHT (m)	TABLE ANGLE (Degree)	RAW VALUE (dBuV)	CORRECTION FACTOR (dB/m)
1	#5715.00	56.6 PK	68.2	-11.6	1.07 H	315	14.72	41.88
2	#5725.00	58.7 PK	78.2	-19.5	1.07 H	315	16.79	41.91
3	*5775.00	98.9 PK			1.07 H	315	56.93	41.97
4	*5775.00	89.2 AV			1.07 H	315	47.23	41.97
5	#5850.00	58.0 PK	78.2	-20.2	1.07 H	315	15.87	42.13
6	#5860.00	56.9 PK	68.2	-11.3	1.07 H	315	14.74	42.16
7	11550.00	54.9 PK	74.0	-19.1	1.00 H	56	7.12	47.78
8	11550.00	41.5 AV	54.0	-12.5	1.00 H	56	-6.28	47.78
9	#17325.00	61.7 PK	68.2	-6.5	1.02 H	213	5.77	55.93

ANTENNA POLARITY & TEST DISTANCE: VERTICAL AT 3 M

NO.	FREQ. (MHz)	EMISSION LEVEL (dBuV/m)	LIMIT (dBuV/m)	MARGIN (dB)	ANTENNA HEIGHT (m)	TABLE ANGLE (Degree)	RAW VALUE (dBuV)	CORRECTION FACTOR (dB/m)
1	#5715.00	67.7 PK	68.2	-0.5	1.32 V	360	25.82	41.88
2	#5725.00	67.8 PK	78.2	-10.4	1.33 V	360	25.89	41.91
3	*5775.00	111.4 PK			1.29 V	360	69.43	41.97
4	*5775.00	102.7 AV			1.29 V	360	60.73	41.97
5	#5850.00	64.2 PK	78.2	-14.0	1.32 V	360	22.07	42.13
6	#5860.00	62.4 PK	68.2	-5.8	1.32 V	360	20.24	42.16
7	11550.00	54.5 PK	74.0	-19.5	1.00 V	28	6.72	47.78
8	11550.00	41.5 AV	54.0	-12.5	1.00 V	28	-6.28	47.78
9	#17325.00	60.2 PK	68.2	-8.0	1.00 V	227	4.27	55.93

REMARKS:

1. Emission Level(dBuV/m) = Raw Value(dBuV) + Correction Factor(dB/m)
2. Correction Factor(dB/m) = Antenna Factor(dB/m) + Cable Factor(dB) – Pre-Amplifier Factor(dB)
3. The other emission levels were very low against the limit.
4. Margin value = Emission Level – Limit value
5. " * ": Fundamental frequency.
6. " # ": The radiated frequency is out of the restricted band.

2TX Mode
Above 1GHz Data
802.11ac (VHT20)

CHANNEL	TX Channel 36	DETECTOR FUNCTION	Peak (PK)
FREQUENCY RANGE	1GHz ~ 40GHz		Average (AV)

ANTENNA POLARITY & TEST DISTANCE: HORIZONTAL AT 3 M

NO.	FREQ. (MHz)	EMISSION LEVEL (dBuV/m)	LIMIT (dBuV/m)	MARGIN (dB)	ANTENNA HEIGHT (m)	TABLE ANGLE (Degree)	RAW VALUE (dBuV)	CORRECTION FACTOR (dB/m)
1	5120.00	51.7 PK	74.0	-22.3	1.00 H	169	48.20	3.50
2	5120.00	41.3 AV	54.0	-12.7	1.00 H	169	37.80	3.50
3	5150.00	68.4 PK	74.0	-5.6	1.02 H	175	64.77	3.63
4	5150.00	51.4 AV	54.0	-2.6	1.02 H	175	47.77	3.63
5	*5180.00	119.3 PK			1.01 H	168	115.53	3.77
6	*5180.00	109.8 AV			1.01 H	168	106.03	3.77
7	5440.00	51.5 PK	74.0	-22.5	1.01 H	164	47.18	4.32
8	5440.00	40.9 AV	54.0	-13.1	1.01 H	164	36.58	4.32
9	#10360.00	56.4 PK	74.0	-17.6	1.00 H	75	47.03	9.37
10	#10360.00	42.4 AV	54.0	-11.6	1.00 H	75	33.03	9.37
11	15540.00	62.3 PK	74.0	-11.7	1.06 H	181	47.89	14.41
12	15540.00	49.2 AV	54.0	-4.8	1.06 H	181	34.79	14.41

ANTENNA POLARITY & TEST DISTANCE: VERTICAL AT 3 M

NO.	FREQ. (MHz)	EMISSION LEVEL (dBuV/m)	LIMIT (dBuV/m)	MARGIN (dB)	ANTENNA HEIGHT (m)	TABLE ANGLE (Degree)	RAW VALUE (dBuV)	CORRECTION FACTOR (dB/m)
1	5120.00	59.8 PK	74.0	-14.2	1.16 V	360	56.30	3.50
2	5120.00	47.7 AV	54.0	-6.3	1.16 V	360	44.20	3.50
3	5150.00	71.6 PK	74.0	-2.4	1.42 V	360	67.97	3.63
4	5150.00	52.5 AV	54.0	-1.5	1.42 V	360	48.87	3.63
5	*5180.00	121.4 PK			1.35 V	351	117.63	3.77
6	*5180.00	111.6 AV			1.35 V	351	107.83	3.77
7	5440.00	59.8 PK	74.0	-14.2	1.06 V	360	55.48	4.32
8	5440.00	47.0 AV	54.0	-7.0	1.06 V	360	42.68	4.32
9	#10360.00	54.0 PK	74.0	-20.0	1.01 V	11	44.63	9.37
10	#10360.00	40.9 AV	54.0	-13.1	1.01 V	11	31.53	9.37
11	15540.00	60.1 PK	74.0	-13.9	1.00 V	214	45.69	14.41
12	15540.00	49.5 AV	54.0	-4.5	1.00 V	214	35.09	14.41

REMARKS:

1. Emission Level(dBuV/m) = Raw Value(dBuV) + Correction Factor(dB/m)
2. Correction Factor(dB/m) = Antenna Factor(dB/m) + Cable Factor(dB) – Pre-Amplifier Factor(dB)
3. The other emission levels were very low against the limit.
4. Margin value = Emission Level – Limit value
5. " * ": Fundamental frequency.
6. " # ": The radiated frequency is out of the restricted band.

CHANNEL	TX Channel 40	DETECTOR FUNCTION	Peak (PK)
FREQUENCY RANGE	1GHz ~ 40GHz		Average (AV)

ANTENNA POLARITY & TEST DISTANCE: HORIZONTAL AT 3 M

NO.	FREQ. (MHz)	EMISSION LEVEL (dBuV/m)	LIMIT (dBuV/m)	MARGIN (dB)	ANTENNA HEIGHT (m)	TABLE ANGLE (Degree)	RAW VALUE (dBuV)	CORRECTION FACTOR (dB/m)
1	5120.00	51.4 PK	74.0	-22.6	1.00 H	163	47.90	3.50
2	5120.00	41.4 AV	54.0	-12.6	1.00 H	163	37.90	3.50
3	*5200.00	118.1 PK			1.04 H	169	114.24	3.86
4	*5200.00	108.1 AV			1.04 H	169	104.24	3.86
5	5360.00	51.4 PK	74.0	-22.6	1.00 H	160	47.27	4.13
6	5360.00	41.2 AV	54.0	-12.8	1.00 H	160	37.07	4.13
7	#10400.00	55.7 PK	74.0	-18.3	1.00 H	79	46.28	9.42
8	#10400.00	42.0 AV	54.0	-12.0	1.00 H	79	32.58	9.42
9	15600.00	62.3 PK	74.0	-11.7	1.00 H	190	47.61	14.69
10	15600.00	49.3 AV	54.0	-4.7	1.00 H	190	34.61	14.69

ANTENNA POLARITY & TEST DISTANCE: VERTICAL AT 3 M

NO.	FREQ. (MHz)	EMISSION LEVEL (dBuV/m)	LIMIT (dBuV/m)	MARGIN (dB)	ANTENNA HEIGHT (m)	TABLE ANGLE (Degree)	RAW VALUE (dBuV)	CORRECTION FACTOR (dB/m)
1	5120.00	62.3 PK	74.0	-11.7	1.00 V	182	58.80	3.50
2	5120.00	53.2 AV	54.0	-0.8	1.00 V	182	49.70	3.50
3	*5200.00	120.1 PK			1.08 V	177	116.24	3.86
4	*5200.00	110.4 AV			1.08 V	177	106.54	3.86
5	5360.00	62.0 PK	74.0	-12.0	1.00 V	179	57.87	4.13
6	5360.00	53.1 AV	54.0	-0.9	1.00 V	179	48.97	4.13
7	#10400.00	54.3 PK	74.0	-19.7	1.00 V	17	44.88	9.42
8	#10400.00	41.1 AV	54.0	-12.9	1.00 V	17	31.68	9.42
9	15600.00	59.9 PK	74.0	-14.1	1.00 V	227	45.21	14.69
10	15600.00	49.4 AV	54.0	-4.6	1.00 V	227	34.71	14.69

REMARKS:

1. Emission Level(dBuV/m) = Raw Value(dBuV) + Correction Factor(dB/m)
2. Correction Factor(dB/m) = Antenna Factor(dB/m) + Cable Factor(dB) – Pre-Amplifier Factor(dB)
3. The other emission levels were very low against the limit.
4. Margin value = Emission Level – Limit value
5. " * ": Fundamental frequency.
6. " # ": The radiated frequency is out of the restricted band.

CHANNEL	TX Channel 48	DETECTOR FUNCTION	Peak (PK)
FREQUENCY RANGE	1GHz ~ 40GHz		Average (AV)

ANTENNA POLARITY & TEST DISTANCE: HORIZONTAL AT 3 M

NO.	FREQ. (MHz)	EMISSION LEVEL (dBuV/m)	LIMIT (dBuV/m)	MARGIN (dB)	ANTENNA HEIGHT (m)	TABLE ANGLE (Degree)	RAW VALUE (dBuV)	CORRECTION FACTOR (dB/m)
1	*5240.00	113.1 PK			1.01 H	168	109.22	3.88
2	*5240.00	103.2 AV			1.01 H	168	99.32	3.88
3	5400.00	51.5 PK	74.0	-22.5	1.07 H	182	47.20	4.30
4	5400.00	41.2 AV	54.0	-12.8	1.07 H	182	36.90	4.30
5	#10480.00	55.6 PK	74.0	-18.4	1.00 H	81	46.00	9.60
6	#10480.00	41.9 AV	54.0	-12.1	1.00 H	81	32.30	9.60
7	15720.00	61.7 PK	74.0	-12.3	1.05 H	186	47.55	14.15
8	15720.00	48.3 AV	54.0	-5.7	1.05 H	186	34.15	14.15

ANTENNA POLARITY & TEST DISTANCE: VERTICAL AT 3 M

NO.	FREQ. (MHz)	EMISSION LEVEL (dBuV/m)	LIMIT (dBuV/m)	MARGIN (dB)	ANTENNA HEIGHT (m)	TABLE ANGLE (Degree)	RAW VALUE (dBuV)	CORRECTION FACTOR (dB/m)
1	*5240.00	114.9 PK			1.00 V	177	111.02	3.88
2	*5240.00	105.4 AV			1.00 V	177	101.52	3.88
3	5400.00	60.2 PK	74.0	-13.8	1.00 V	176	55.90	4.30
4	5400.00	53.4 AV	54.0	-0.6	1.00 V	176	49.10	4.30
5	#10480.00	53.6 PK	74.0	-20.4	1.03 V	12	44.00	9.60
6	#10480.00	40.7 AV	54.0	-13.3	1.03 V	12	31.10	9.60
7	15720.00	59.5 PK	74.0	-14.5	1.00 V	215	45.35	14.15
8	15720.00	49.2 AV	54.0	-4.8	1.00 V	215	35.05	14.15

REMARKS:

1. Emission Level(dBuV/m) = Raw Value(dBuV) + Correction Factor(dB/m)
2. Correction Factor(dB/m) = Antenna Factor(dB/m) + Cable Factor(dB) – Pre-Amplifier Factor(dB)
3. The other emission levels were very low against the limit.
4. Margin value = Emission Level – Limit value
5. " * ": Fundamental frequency.
6. " # ": The radiated frequency is out of the restricted band.

CHANNEL	TX Channel 149	DETECTOR FUNCTION	Peak (PK)
FREQUENCY RANGE	1GHz ~ 40GHz		Average (AV)

ANTENNA POLARITY & TEST DISTANCE: HORIZONTAL AT 3 M

NO.	FREQ. (MHz)	EMISSION LEVEL (dBuV/m)	LIMIT (dBuV/m)	MARGIN (dB)	ANTENNA HEIGHT (m)	TABLE ANGLE (Degree)	RAW VALUE (dBuV)	CORRECTION FACTOR (dB/m)
1	#5659.00	59.8 PK	68.2	-8.4	1.14 H	347	17.95	41.85
2	#5715.00	59.4 PK	68.2	-8.8	1.08 H	353	17.52	41.88
3	#5725.00	72.4 PK	78.2	-5.8	1.01 H	208	30.49	41.91
4	*5745.00	119.4 PK			1.11 H	328	77.47	41.93
5	*5745.00	110.1 AV			1.11 H	328	68.17	41.93
6	#5905.00	56.3 PK	68.2	-11.9	1.09 H	326	14.05	42.25
7	11490.00	55.5 PK	74.0	-18.5	1.00 H	62	7.75	47.75
8	11490.00	42.3 AV	54.0	-11.7	1.00 H	62	-5.45	47.75
9	#17235.00	61.5 PK	68.2	-6.7	1.00 H	195	5.75	55.75

ANTENNA POLARITY & TEST DISTANCE: VERTICAL AT 3 M

NO.	FREQ. (MHz)	EMISSION LEVEL (dBuV/m)	LIMIT (dBuV/m)	MARGIN (dB)	ANTENNA HEIGHT (m)	TABLE ANGLE (Degree)	RAW VALUE (dBuV)	CORRECTION FACTOR (dB/m)
1	#5659.00	63.3 PK	68.2	-4.9	1.21 V	360	21.45	41.85
2	#5715.00	61.0 PK	68.2	-7.2	1.33 V	360	19.12	41.88
3	#5725.00	77.2 PK	78.2	-1.0	1.18 V	360	35.29	41.91
4	*5745.00	121.7 PK			1.25 V	360	79.77	41.93
5	*5745.00	112.6 AV			1.25 V	360	70.67	41.93
6	#5905.00	61.2 PK	68.2	-7.0	1.27 V	360	18.95	42.25
7	11490.00	54.2 PK	74.0	-19.8	1.00 V	34	6.45	47.75
8	11490.00	41.2 AV	54.0	-12.8	1.00 V	34	-6.55	47.75
9	#17235.00	59.9 PK	68.2	-8.3	1.00 V	211	4.15	55.75

REMARKS:

1. Emission Level(dBuV/m) = Raw Value(dBuV) + Correction Factor(dB/m)
2. Correction Factor(dB/m) = Antenna Factor(dB/m) + Cable Factor(dB) – Pre-Amplifier Factor(dB)
3. The other emission levels were very low against the limit.
4. Margin value = Emission Level – Limit value
5. " * ": Fundamental frequency.
6. " # ": The radiated frequency is out of the restricted band.

CHANNEL	TX Channel 157	DETECTOR FUNCTION	Peak (PK)
FREQUENCY RANGE	1GHz ~ 40GHz		Average (AV)

ANTENNA POLARITY & TEST DISTANCE: HORIZONTAL AT 3 M

NO.	FREQ. (MHz)	EMISSION LEVEL (dBuV/m)	LIMIT (dBuV/m)	MARGIN (dB)	ANTENNA HEIGHT (m)	TABLE ANGLE (Degree)	RAW VALUE (dBuV)	CORRECTION FACTOR (dB/m)
1	#5697.00	65.4 PK	68.2	-2.8	1.08 H	320	23.53	41.87
2	*5785.00	125.6 PK			1.06 H	348	83.60	42.00
3	*5785.00	116.1 AV			1.06 H	348	74.10	42.00
4	#5864.00	60.1 PK	68.2	-8.1	1.00 H	331	17.94	42.16
5	#5945.00	59.8 PK	68.2	-8.4	1.07 H	334	17.52	42.28
6	11570.00	56.3 PK	74.0	-17.7	1.03 H	65	8.51	47.79
7	11570.00	42.7 AV	54.0	-11.3	1.03 H	65	-5.09	47.79
8	#17355.00	61.9 PK	68.2	-6.3	1.00 H	207	5.96	55.94

ANTENNA POLARITY & TEST DISTANCE: VERTICAL AT 3 M

NO.	FREQ. (MHz)	EMISSION LEVEL (dBuV/m)	LIMIT (dBuV/m)	MARGIN (dB)	ANTENNA HEIGHT (m)	TABLE ANGLE (Degree)	RAW VALUE (dBuV)	CORRECTION FACTOR (dB/m)
1	#5697.00	67.4 PK	68.2	-0.8	1.20 V	360	25.53	41.87
2	*5785.00	127.4 PK			1.15 V	360	85.40	42.00
3	*5785.00	118.5 AV			1.15 V	360	76.50	42.00
4	#5864.00	63.9 PK	68.2	-4.3	1.37 V	360	21.74	42.16
5	#5945.00	62.3 PK	68.2	-5.9	1.38 V	360	20.02	42.28
6	11570.00	53.7 PK	74.0	-20.3	1.00 V	35	5.91	47.79
7	11570.00	40.5 AV	54.0	-13.5	1.00 V	35	-7.29	47.79
8	#17355.00	60.6 PK	68.2	-7.6	1.00 V	201	4.66	55.94

REMARKS:

1. Emission Level(dBuV/m) = Raw Value(dBuV) + Correction Factor(dB/m)
2. Correction Factor(dB/m) = Antenna Factor(dB/m) + Cable Factor(dB) – Pre-Amplifier Factor(dB)
3. The other emission levels were very low against the limit.
4. Margin value = Emission Level – Limit value
5. " * ": Fundamental frequency.
6. " # ": The radiated frequency is out of the restricted band.

CHANNEL	TX Channel 165	DETECTOR FUNCTION	Peak (PK)
FREQUENCY RANGE	1GHz ~ 40GHz		Average (AV)

ANTENNA POLARITY & TEST DISTANCE: HORIZONTAL AT 3 M

NO.	FREQ. (MHz)	EMISSION LEVEL (dBuV/m)	LIMIT (dBuV/m)	MARGIN (dB)	ANTENNA HEIGHT (m)	TABLE ANGLE (Degree)	RAW VALUE (dBuV)	CORRECTION FACTOR (dB/m)
1	*5825.00	121.1 PK			1.07 H	333	79.03	42.07
2	*5825.00	112.5 AV			1.07 H	333	70.43	42.07
3	#5850.00	69.3 PK	78.2	-8.9	1.06 H	327	27.17	42.13
4	#5860.00	59.1 PK	68.2	-9.1	1.06 H	346	16.94	42.16
5	#5905.00	65.2 PK	68.2	-3.0	1.00 H	346	22.95	42.25
6	#5985.00	60.2 PK	68.2	-8.0	1.11 H	335	17.91	42.29
7	11650.00	55.0 PK	74.0	-19.0	1.00 H	62	7.15	47.85
8	11650.00	41.3 AV	54.0	-12.7	1.00 H	62	-6.55	47.85
9	#17475.00	61.3 PK	68.2	-6.9	1.00 H	218	5.15	56.15

ANTENNA POLARITY & TEST DISTANCE: VERTICAL AT 3 M

NO.	FREQ. (MHz)	EMISSION LEVEL (dBuV/m)	LIMIT (dBuV/m)	MARGIN (dB)	ANTENNA HEIGHT (m)	TABLE ANGLE (Degree)	RAW VALUE (dBuV)	CORRECTION FACTOR (dB/m)
1	*5825.00	124.5 PK			1.17 V	353	82.43	42.07
2	*5825.00	115.0 AV			1.17 V	353	72.93	42.07
3	#5850.00	75.2 PK	78.2	-3.0	1.28 V	360	33.07	42.13
4	#5860.00	60.3 PK	68.2	-7.9	1.30 V	360	18.14	42.16
5	#5905.00	67.8 PK	68.2	-0.4	1.37 V	360	25.55	42.25
6	#5985.00	63.6 PK	68.2	-4.6	1.35 V	359	21.31	42.29
7	11650.00	53.5 PK	74.0	-20.5	1.00 V	11	5.65	47.85
8	11650.00	40.7 AV	54.0	-13.3	1.00 V	11	-7.15	47.85
9	#17475.00	59.9 PK	68.2	-8.3	1.00 V	213	3.75	56.15

REMARKS:

1. Emission Level(dBuV/m) = Raw Value(dBuV) + Correction Factor(dB/m)
2. Correction Factor(dB/m) = Antenna Factor(dB/m) + Cable Factor(dB) – Pre-Amplifier Factor(dB)
3. The other emission levels were very low against the limit.
4. Margin value = Emission Level – Limit value
5. " * ": Fundamental frequency.
6. " # ": The radiated frequency is out of the restricted band.

802.11ac (VHT40)

CHANNEL	TX Channel 38	DETECTOR FUNCTION	Peak (PK)
FREQUENCY RANGE	1GHz ~ 40GHz		Average (AV)

ANTENNA POLARITY & TEST DISTANCE: HORIZONTAL AT 3 M								
NO.	FREQ. (MHz)	EMISSION LEVEL (dBuV/m)	LIMIT (dBuV/m)	MARGIN (dB)	ANTENNA HEIGHT (m)	TABLE ANGLE (Degree)	RAW VALUE (dBuV)	CORRECTION FACTOR (dB/m)
1	5150.00	68.1 PK	74.0	-5.9	1.04 H	164	64.47	3.63
2	5150.00	51.4 AV	54.0	-2.6	1.04 H	164	47.77	3.63
3	*5190.00	111.8 PK			1.00 H	166	107.98	3.82
4	*5190.00	101.9 AV			1.00 H	166	98.08	3.82
5	#10380.00	56.2 PK	74.0	-17.8	1.00 H	56	46.80	9.40
6	#10380.00	42.3 AV	54.0	-11.7	1.00 H	56	32.90	9.40
7	15570.00	61.9 PK	74.0	-12.1	1.00 H	182	47.35	14.55
8	15570.00	48.5 AV	54.0	-5.5	1.00 H	182	33.95	14.55

ANTENNA POLARITY & TEST DISTANCE: VERTICAL AT 3 M								
NO.	FREQ. (MHz)	EMISSION LEVEL (dBuV/m)	LIMIT (dBuV/m)	MARGIN (dB)	ANTENNA HEIGHT (m)	TABLE ANGLE (Degree)	RAW VALUE (dBuV)	CORRECTION FACTOR (dB/m)
1	5150.00	66.7 PK	74.0	-7.3	1.05 V	343	63.07	3.63
2	5150.00	53.0 AV	54.0	-1.0	1.05 V	343	49.37	3.63
3	*5190.00	113.9 PK			1.15 V	360	110.08	3.82
4	*5190.00	104.0 AV			1.15 V	360	100.18	3.82
5	#10380.00	53.8 PK	74.0	-20.2	1.00 V	26	44.40	9.40
6	#10380.00	40.9 AV	54.0	-13.1	1.00 V	26	31.50	9.40
7	15570.00	59.6 PK	74.0	-14.4	1.00 V	212	45.05	14.55
8	15570.00	49.0 AV	54.0	-5.0	1.00 V	212	34.45	14.55

REMARKS:

1. Emission Level(dBuV/m) = Raw Value(dBuV) + Correction Factor(dB/m)
2. Correction Factor(dB/m) = Antenna Factor(dB/m) + Cable Factor(dB) – Pre-Amplifier Factor(dB)
3. The other emission levels were very low against the limit.
4. Margin value = Emission Level – Limit value
5. " * ": Fundamental frequency.
6. " # ": The radiated frequency is out of the restricted band.

CHANNEL	TX Channel 46	DETECTOR FUNCTION	Peak (PK)
FREQUENCY RANGE	1GHz ~ 40GHz		Average (AV)

ANTENNA POLARITY & TEST DISTANCE: HORIZONTAL AT 3 M

NO.	FREQ. (MHz)	EMISSION LEVEL (dBuV/m)	LIMIT (dBuV/m)	MARGIN (dB)	ANTENNA HEIGHT (m)	TABLE ANGLE (Degree)	RAW VALUE (dBuV)	CORRECTION FACTOR (dB/m)
1	*5230.00	115.1 PK			1.05 H	170	111.24	3.86
2	*5230.00	105.4 AV			1.05 H	170	101.54	3.86
3	5390.00	67.5 PK	74.0	-6.5	1.00 H	183	63.24	4.26
4	5390.00	50.9 AV	54.0	-3.1	1.00 H	183	46.64	4.26
5	#10460.00	55.9 PK	74.0	-18.1	1.00 H	76	46.34	9.56
6	#10460.00	42.0 AV	54.0	-12.0	1.00 H	76	32.44	9.56
7	15690.00	61.9 PK	74.0	-12.1	1.08 H	206	47.73	14.17
8	15690.00	48.8 AV	54.0	-5.2	1.08 H	206	34.63	14.17

ANTENNA POLARITY & TEST DISTANCE: VERTICAL AT 3 M

NO.	FREQ. (MHz)	EMISSION LEVEL (dBuV/m)	LIMIT (dBuV/m)	MARGIN (dB)	ANTENNA HEIGHT (m)	TABLE ANGLE (Degree)	RAW VALUE (dBuV)	CORRECTION FACTOR (dB/m)
1	*5230.00	117.2 PK			1.14 V	357	113.34	3.86
2	*5230.00	107.7 AV			1.14 V	357	103.84	3.86
3	5390.00	60.9 PK	74.0	-13.1	1.01 V	180	56.64	4.26
4	5390.00	53.3 AV	54.0	-0.7	1.01 V	180	49.04	4.26
5	#10460.00	54.6 PK	74.0	-19.4	1.00 V	28	45.04	9.56
6	#10460.00	41.5 AV	54.0	-12.5	1.00 V	28	31.94	9.56
7	15690.00	60.1 PK	74.0	-13.9	1.00 V	205	45.93	14.17
8	15690.00	49.5 AV	54.0	-4.5	1.00 V	205	35.33	14.17

REMARKS:

1. Emission Level(dBuV/m) = Raw Value(dBuV) + Correction Factor(dB/m)
2. Correction Factor(dB/m) = Antenna Factor(dB/m) + Cable Factor(dB) – Pre-Amplifier Factor(dB)
3. The other emission levels were very low against the limit.
4. Margin value = Emission Level – Limit value
5. " * ": Fundamental frequency.
6. " # ": The radiated frequency is out of the restricted band.

CHANNEL	TX Channel 151	DETECTOR FUNCTION	Peak (PK)
FREQUENCY RANGE	1GHz ~ 40GHz		Average (AV)

ANTENNA POLARITY & TEST DISTANCE: HORIZONTAL AT 3 M

NO.	FREQ. (MHz)	EMISSION LEVEL (dBuV/m)	LIMIT (dBuV/m)	MARGIN (dB)	ANTENNA HEIGHT (m)	TABLE ANGLE (Degree)	RAW VALUE (dBuV)	CORRECTION FACTOR (dB/m)
1	#5715.00	65.1 PK	68.2	-3.1	1.11 H	324	23.22	41.88
2	#5725.00	65.5 PK	78.2	-12.7	1.12 H	334	23.59	41.91
3	*5755.00	113.1 PK			1.12 H	325	71.15	41.95
4	*5755.00	103.8 AV			1.12 H	325	61.85	41.95
5	#5915.00	59.4 PK	68.2	-8.8	1.06 H	323	17.14	42.26
6	11510.00	55.2 PK	74.0	-18.8	1.00 H	60	7.44	47.76
7	11510.00	41.8 AV	54.0	-12.2	1.00 H	60	-5.96	47.76
8	#17265.00	61.3 PK	68.2	-6.9	1.02 H	210	5.48	55.82

ANTENNA POLARITY & TEST DISTANCE: VERTICAL AT 3 M

NO.	FREQ. (MHz)	EMISSION LEVEL (dBuV/m)	LIMIT (dBuV/m)	MARGIN (dB)	ANTENNA HEIGHT (m)	TABLE ANGLE (Degree)	RAW VALUE (dBuV)	CORRECTION FACTOR (dB/m)
1	#5715.00	67.9 PK	68.2	-0.3	1.20 V	360	26.02	41.88
2	#5725.00	75.2 PK	78.2	-3.0	1.20 V	360	33.29	41.91
3	*5755.00	115.3 PK			1.25 V	342	73.35	41.95
4	*5755.00	106.0 AV			1.25 V	342	64.05	41.95
5	#5915.00	60.6 PK	68.2	-7.6	1.28 V	357	18.34	42.26
6	11510.00	54.4 PK	74.0	-19.6	1.00 V	28	6.64	47.76
7	11510.00	41.3 AV	54.0	-12.7	1.00 V	28	-6.46	47.76
8	#17265.00	60.4 PK	68.2	-7.8	1.00 V	238	4.58	55.82

REMARKS:

1. Emission Level(dBuV/m) = Raw Value(dBuV) + Correction Factor(dB/m)
2. Correction Factor(dB/m) = Antenna Factor(dB/m) + Cable Factor(dB) – Pre-Amplifier Factor(dB)
3. The other emission levels were very low against the limit.
4. Margin value = Emission Level – Limit value
5. " * ": Fundamental frequency.
6. " # ": The radiated frequency is out of the restricted band.

CHANNEL	TX Channel 159	DETECTOR FUNCTION	Peak (PK)
FREQUENCY RANGE	1GHz ~ 40GHz		Average (AV)

ANTENNA POLARITY & TEST DISTANCE: HORIZONTAL AT 3 M

NO.	FREQ. (MHz)	EMISSION LEVEL (dBuV/m)	LIMIT (dBuV/m)	MARGIN (dB)	ANTENNA HEIGHT (m)	TABLE ANGLE (Degree)	RAW VALUE (dBuV)	CORRECTION FACTOR (dB/m)
1	*5795.00	119.2 PK			1.03 H	323	77.19	42.01
2	*5795.00	109.8 AV			1.03 H	323	67.79	42.01
3	#5850.00	70.6 PK	78.2	-7.6	1.16 H	317	28.47	42.13
4	#5860.00	64.7 PK	68.2	-3.5	1.13 H	309	22.54	42.16
5	11590.00	55.8 PK	74.0	-18.2	1.00 H	70	7.99	47.81
6	11590.00	42.5 AV	54.0	-11.5	1.00 H	70	-5.31	47.81
7	#17385.00	62.1 PK	68.2	-6.1	1.00 H	201	6.13	55.97

ANTENNA POLARITY & TEST DISTANCE: VERTICAL AT 3 M

NO.	FREQ. (MHz)	EMISSION LEVEL (dBuV/m)	LIMIT (dBuV/m)	MARGIN (dB)	ANTENNA HEIGHT (m)	TABLE ANGLE (Degree)	RAW VALUE (dBuV)	CORRECTION FACTOR (dB/m)
1	*5795.00	121.6 PK			1.26 V	351	79.59	42.01
2	*5795.00	112.0 AV			1.26 V	351	69.99	42.01
3	#5850.00	73.4 PK	78.2	-4.8	1.30 V	360	31.27	42.13
4	#5860.00	67.9 PK	68.2	-0.3	1.36 V	360	25.74	42.16
5	#5955.00	62.3 PK	68.2	-5.9	1.37 V	356	20.03	42.27
6	11590.00	54.7 PK	74.0	-19.3	1.00 V	21	6.89	47.81
7	11590.00	41.7 AV	54.0	-12.3	1.00 V	21	-6.11	47.81
8	#17385.00	60.4 PK	68.2	-7.8	1.00 V	197	4.43	55.97

REMARKS:

1. Emission Level(dBuV/m) = Raw Value(dBuV) + Correction Factor(dB/m)
2. Correction Factor(dB/m) = Antenna Factor(dB/m) + Cable Factor(dB) – Pre-Amplifier Factor(dB)
3. The other emission levels were very low against the limit.
4. Margin value = Emission Level – Limit value
5. " * ": Fundamental frequency.
6. " # ": The radiated frequency is out of the restricted band.

802.11ac (VHT80)

CHANNEL	TX Channel 42	DETECTOR FUNCTION	Peak (PK)
FREQUENCY RANGE	1GHz ~ 40GHz		Average (AV)

ANTENNA POLARITY & TEST DISTANCE: HORIZONTAL AT 3 M

NO.	FREQ. (MHz)	EMISSION LEVEL (dBuV/m)	LIMIT (dBuV/m)	MARGIN (dB)	ANTENNA HEIGHT (m)	TABLE ANGLE (Degree)	RAW VALUE (dBuV)	CORRECTION FACTOR (dB/m)
1	5150.00	68.5 PK	74.0	-5.5	1.01 H	165	64.87	3.63
2	5150.00	51.5 AV	54.0	-2.5	1.01 H	165	47.87	3.63
3	*5210.00	108.3 PK			1.02 H	168	104.45	3.85
4	*5210.00	98.4 AV			1.02 H	168	94.55	3.85
5	5370.00	51.5 PK	74.0	-22.5	1.00 H	178	47.32	4.18
6	5370.00	40.9 AV	54.0	-13.1	1.00 H	178	36.72	4.18
7	#10420.00	56.5 PK	74.0	-17.5	1.00 H	73	47.04	9.46
8	#10420.00	42.4 AV	54.0	-11.6	1.00 H	73	32.94	9.46
9	15630.00	62.7 PK	74.0	-11.3	1.00 H	207	48.18	14.52
10	15630.00	49.2 AV	54.0	-4.8	1.00 H	207	34.68	14.52

ANTENNA POLARITY & TEST DISTANCE: VERTICAL AT 3 M

NO.	FREQ. (MHz)	EMISSION LEVEL (dBuV/m)	LIMIT (dBuV/m)	MARGIN (dB)	ANTENNA HEIGHT (m)	TABLE ANGLE (Degree)	RAW VALUE (dBuV)	CORRECTION FACTOR (dB/m)
1	5150.00	65.8 PK	74.0	-8.2	1.13 V	348	62.17	3.63
2	5150.00	53.0 AV	54.0	-1.0	1.13 V	348	49.37	3.63
3	*5210.00	110.7 PK			1.32 V	338	106.85	3.85
4	*5210.00	100.6 AV			1.32 V	338	96.75	3.85
5	5370.00	57.3 PK	74.0	-16.7	1.00 V	159	53.12	4.18
6	5370.00	47.7 AV	54.0	-6.3	1.00 V	159	43.52	4.18
7	#10420.00	54.4 PK	74.0	-19.6	1.00 V	32	44.94	9.46
8	#10420.00	41.3 AV	54.0	-12.7	1.00 V	32	31.84	9.46
9	15630.00	59.5 PK	74.0	-14.5	1.00 V	228	44.98	14.52
10	15630.00	49.0 AV	54.0	-5.0	1.00 V	228	34.48	14.52

REMARKS:

1. Emission Level(dBuV/m) = Raw Value(dBuV) + Correction Factor(dB/m)
2. Correction Factor(dB/m) = Antenna Factor(dB/m) + Cable Factor(dB) – Pre-Amplifier Factor(dB)
3. The other emission levels were very low against the limit.
4. Margin value = Emission Level – Limit value
5. " * ": Fundamental frequency.
6. " # ": The radiated frequency is out of the restricted band.

CHANNEL	TX Channel 155	DETECTOR FUNCTION	Peak (PK)
FREQUENCY RANGE	1GHz ~ 40GHz		Average (AV)

ANTENNA POLARITY & TEST DISTANCE: HORIZONTAL AT 3 M

NO.	FREQ. (MHz)	EMISSION LEVEL (dBuV/m)	LIMIT (dBuV/m)	MARGIN (dB)	ANTENNA HEIGHT (m)	TABLE ANGLE (Degree)	RAW VALUE (dBuV)	CORRECTION FACTOR (dB/m)
1	#5715.00	64.8 PK	68.2	-3.4	1.09 H	327	22.92	41.88
2	#5725.00	65.2 PK	78.2	-13.0	1.07 H	317	23.29	41.91
3	*5775.00	109.2 PK			1.11 H	319	67.23	41.97
4	*5775.00	99.6 AV			1.11 H	319	57.63	41.97
5	#5850.00	60.9 PK	78.2	-17.3	1.09 H	330	18.77	42.13
6	#5860.00	59.5 PK	68.2	-8.7	1.10 H	303	17.34	42.16
7	11550.00	55.0 PK	74.0	-19.0	1.00 H	68	7.22	47.78
8	11550.00	41.6 AV	54.0	-12.4	1.00 H	68	-6.18	47.78
9	#17325.00	62.0 PK	68.2	-6.2	1.00 H	209	6.07	55.93

ANTENNA POLARITY & TEST DISTANCE: VERTICAL AT 3 M

NO.	FREQ. (MHz)	EMISSION LEVEL (dBuV/m)	LIMIT (dBuV/m)	MARGIN (dB)	ANTENNA HEIGHT (m)	TABLE ANGLE (Degree)	RAW VALUE (dBuV)	CORRECTION FACTOR (dB/m)
1	#5715.00	66.7 PK	68.2	-1.5	1.26 V	356	24.82	41.88
2	#5725.00	67.9 PK	78.2	-10.3	1.27 V	353	25.99	41.91
3	*5775.00	111.3 PK			1.31 V	355	69.33	41.97
4	*5775.00	102.4 AV			1.31 V	355	60.43	41.97
5	#5850.00	64.3 PK	78.2	-13.9	1.29 V	360	22.17	42.13
6	#5860.00	62.1 PK	68.2	-6.1	1.38 V	350	19.94	42.16
7	11550.00	54.5 PK	74.0	-19.5	1.05 V	34	6.72	47.78
8	11550.00	41.3 AV	54.0	-12.7	1.05 V	34	-6.48	47.78
9	#17325.00	60.8 PK	68.2	-7.4	1.00 V	235	4.87	55.93

REMARKS:

1. Emission Level(dBuV/m) = Raw Value(dBuV) + Correction Factor(dB/m)
2. Correction Factor(dB/m) = Antenna Factor(dB/m) + Cable Factor(dB) – Pre-Amplifier Factor(dB)
3. The other emission levels were very low against the limit.
4. Margin value = Emission Level – Limit value
5. " * ": Fundamental frequency.
6. " # ": The radiated frequency is out of the restricted band.

1TX Mode

Below 1GHz Data

802.11ac (VHT20)

CHANNEL	TX Channel 157	DETECTOR FUNCTION	Quasi-Peak (QP)
FREQUENCY RANGE	Below 1GHz		

ANTENNA POLARITY & TEST DISTANCE: HORIZONTAL AT 3 M

NO.	FREQ. (MHz)	EMISSION LEVEL (dBuV/m)	LIMIT (dBuV/m)	MARGIN (dB)	ANTENNA HEIGHT (m)	TABLE ANGLE (Degree)	RAW VALUE (dBuV)	CORRECTION FACTOR (dB/m)
1	125.34	33.1 QP	43.5	-10.4	1.54 H	175	47.98	-14.87
2	175.24	34.2 QP	43.5	-9.3	1.34 H	175	48.08	-13.87
3	249.64	42.1 QP	46.0	-3.9	1.64 H	175	56.16	-14.02
4	374.42	37.5 QP	46.0	-8.6	1.34 H	201	47.43	-9.98
5	500.21	35.2 QP	46.0	-10.8	1.34 H	100	42.03	-6.82
6	749.24	38.3 QP	46.0	-7.7	1.45 H	164	39.56	-1.22

ANTENNA POLARITY & TEST DISTANCE: VERTICAL AT 3 M

NO.	FREQ. (MHz)	EMISSION LEVEL (dBuV/m)	LIMIT (dBuV/m)	MARGIN (dB)	ANTENNA HEIGHT (m)	TABLE ANGLE (Degree)	RAW VALUE (dBuV)	CORRECTION FACTOR (dB/m)
1	34.66	36.1 QP	40.0	-3.9	2.00 V	0	50.21	-14.12
2	66.33	33.4 QP	40.0	-6.6	2.00 V	335	47.92	-14.48
3	209.89	37.0 QP	43.5	-6.5	1.50 V	358	52.99	-16.03
4	250.00	38.0 QP	46.0	-8.0	2.00 V	336	52.00	-14.01
5	400.01	38.7 QP	46.0	-7.3	1.50 V	360	48.08	-9.39
6	424.98	41.4 QP	46.0	-4.6	1.00 V	305	49.87	-8.50

REMARKS:

1. Emission Level(dBuV/m) = Raw Value(dBuV) + Correction Factor(dB/m)
2. Correction Factor(dB/m) = Antenna Factor(dB/m) + Cable Factor(dB) – Pre-Amplifier Factor(dB)
3. The other emission levels were very low against the limit.
4. Margin value = Emission Level – Limit value

4.2 Conducted Emission Measurement

4.2.1 Limits of Conducted Emission Measurement

Frequency (MHz)	Conducted Limit (dBuV)	
	Quasi-peak	Average
0.15 - 0.5	66 - 56	56 - 46
0.50 - 5.0	56	46
5.0 - 30.0	60	50

Note: 1. The lower limit shall apply at the transition frequencies.

2. The limit decreases in line with the logarithm of the frequency in the range of 0.15 to 0.50MHz.

4.2.2 Test Instruments

DESCRIPTION & MANUFACTURER	MODEL NO.	SERIAL NO.	CALIBRATED DATE	CALIBRATED UNTIL
Test Receiver ROHDE & SCHWARZ	ESCS 30	100375	Apr. 29, 2014	Apr. 28, 2015
Line-Impedance Stabilization Network (for EUT) SCHWARZBECK	NSLK-8127	8127-522	Sep. 15, 2014	Sep. 14, 2015
Line-Impedance Stabilization Network (for Peripheral) ROHDE & SCHWARZ	ENV216	100071	Nov. 10, 2014	Nov. 09, 2015
RF Cable (JYEBAO)	5D-FB	COCCAB-001	Mar. 09, 2015	Mar. 08, 2016
50 ohms Terminator	N/A	EMC-03	Sep. 22, 2014	Sep. 21, 2015
50 ohms Terminator	N/A	EMC-02	Sep. 30, 2014	Sep. 29, 2015
Software ADT	BV ADT_Cond_V7.3.7. 3	NA	NA	NA

Note:

1. The calibration interval of the above test instruments is 12 months and the calibrations are traceable to NML/ROC and NIST/USA.
2. The test was performed in Shielded Room No. C.
3. The VCCI Con C Registration No. is C-3611.
4. Tested Date: Mar. 20, 2015

4.2.3 Test Procedures

- a. The EUT was placed 0.4 meters from the conducting wall of the shielded room with EUT being connected to the power mains through a line impedance stabilization network (LISN). Other support units were connected to the power mains through another LISN. The two LISNs provide 50 ohm/ 50uH of coupling impedance for the measuring instrument.
- b. Both lines of the power mains connected to the EUT were checked for maximum conducted interference.
- c. The frequency range from 150kHz to 30MHz was searched. Emission levels under (Limit - 20dB) was not recorded.

NOTE: The resolution bandwidth and video bandwidth of test receiver is 9kHz for quasi-peak detection (QP) and average detection (AV) at frequency 0.15MHz-30MHz.

4.2.4 Deviation from Test Standard

No deviation.

4.2.5 Test Setup

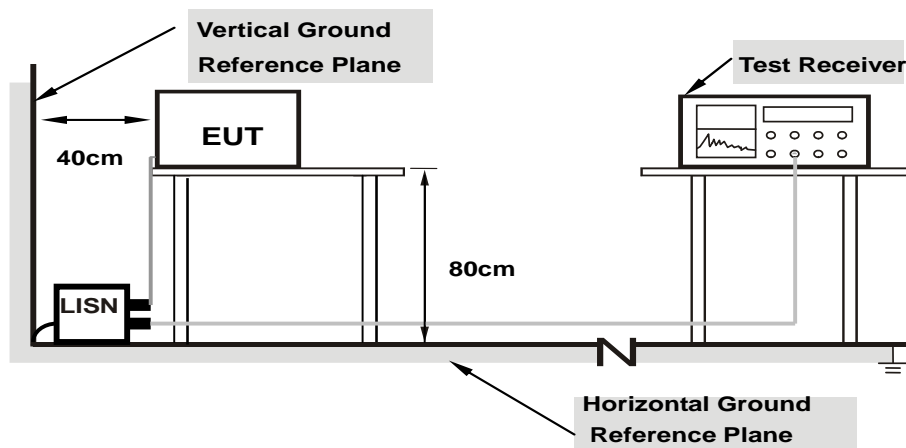

Note: 1.Support units were connected to second LISN.

For the actual test configuration, please refer to the attached file (Test Setup Photo).

4.2.6 EUT Operating Conditions

Same as 4.1.6.

4.2.7 Test Results (Mode 1)

Phase	Line (L)	Detector Function	Quasi-Peak (QP) / Average (AV)
-------	----------	-------------------	--------------------------------

No	Freq. [MHz]	Corr. Factor	Reading Value [dB (uV)]		Emission Level [dB (uV)]		Limit [dB (uV)]		Margin (dB)	
		(dB)	Q.P.	AV.	Q.P.	AV.	Q.P.	AV.	Q.P.	AV.
	1	0.15000	0.08	50.13	31.25	50.21	31.33	66.00	56.00	-15.79
2	0.16550	0.08	48.23	36.99	48.31	37.07	65.18	55.18	-16.87	-18.11
3	0.22812	0.09	40.35	30.11	40.44	30.20	62.52	52.52	-22.08	-22.32
4	0.30234	0.10	36.15	30.26	36.25	30.36	60.18	50.18	-23.93	-19.82
5	2.23438	0.18	23.86	20.47	24.04	20.65	56.00	46.00	-31.96	-25.35
6	24.18750	0.79	30.12	22.54	30.91	23.33	60.00	50.00	-29.09	-26.67

REMARKS:

1. Q.P. and AV. are abbreviations of quasi-peak and average individually.
2. The emission levels of other frequencies were very low against the limit.
3. Margin value = Emission Level – Limit value
4. Correction Factor = Insertion loss + Cable loss
5. Emission Level = Correction Factor + Reading Value

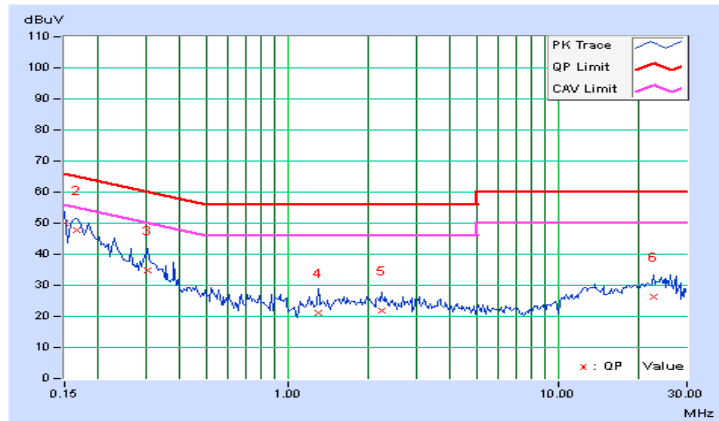

Phase	Neutral (N)	Detector Function	Quasi-Peak (QP) / Average (AV)
-------	-------------	-------------------	--------------------------------

No	Freq. [MHz]	Corr.	Reading Value		Emission Level		Limit		Margin	
		Factor	[dB (uV)]		[dB (uV)]		[dB (uV)]		(dB)	
		(dB)	Q.P.	AV.	Q.P.	AV.	Q.P.	AV.	Q.P.	AV.
1	0.15000	0.08	46.73	31.52	46.81	31.60	66.00	56.00	-19.19	-24.40
2	0.16953	0.08	42.36	28.65	42.44	28.73	64.98	54.98	-22.54	-26.25
3	0.20469	0.08	41.53	26.95	41.61	27.03	63.42	53.42	-21.81	-26.39
4	0.93125	0.13	31.49	23.89	31.62	24.02	56.00	46.00	-24.38	-21.98
5	4.62891	0.25	23.69	18.47	23.94	18.72	56.00	46.00	-32.06	-27.28
6	25.87500	0.88	28.46	22.69	29.34	23.57	60.00	50.00	-30.66	-26.43

REMARKS:

1. Q.P. and AV. are abbreviations of quasi-peak and average individually.
2. The emission levels of other frequencies were very low against the limit.
3. Margin value = Emission Level – Limit value
4. Correction Factor = Insertion loss + Cable loss
5. Emission Level = Correction Factor + Reading Value

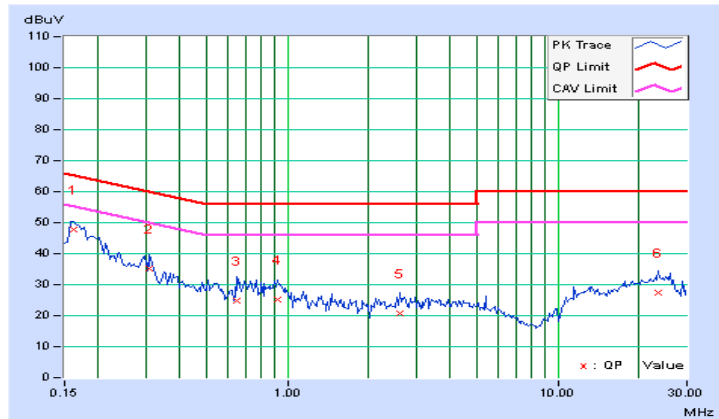

4.2.8 Test Results (Mode 2)

Phase	Line (L)	Detector Function	Quasi-Peak (QP) / Average (AV)
-------	----------	-------------------	--------------------------------

No	Freq. [MHz]	Corr.	Reading Value		Emission Level		Limit		Margin	
		Factor	[dB (uV)]		[dB (uV)]		[dB (uV)]		(dB)	
	(dB)	Q.P.	AV.	Q.P.	AV.	Q.P.	AV.	Q.P.	AV.	
1	0.15000	0.08	49.80	29.54	49.88	29.62	66.00	56.00	-16.12	-26.38
2	0.16562	0.08	47.82	35.22	47.90	35.30	65.18	55.18	-17.27	-19.87
3	0.30234	0.10	34.90	25.72	35.00	25.82	60.18	50.18	-25.18	-24.36
4	1.29688	0.14	21.10	13.56	21.24	13.70	56.00	46.00	-34.76	-32.30
5	2.23438	0.18	21.56	15.92	21.74	16.10	56.00	46.00	-34.26	-29.90
6	22.51563	0.76	25.44	20.72	26.20	21.48	60.00	50.00	-33.80	-28.52

REMARKS:

1. Q.P. and AV. are abbreviations of quasi-peak and average individually.
2. The emission levels of other frequencies were very low against the limit.
3. Margin value = Emission Level – Limit value
4. Correction Factor = Insertion loss + Cable loss
5. Emission Level = Correction Factor + Reading Value

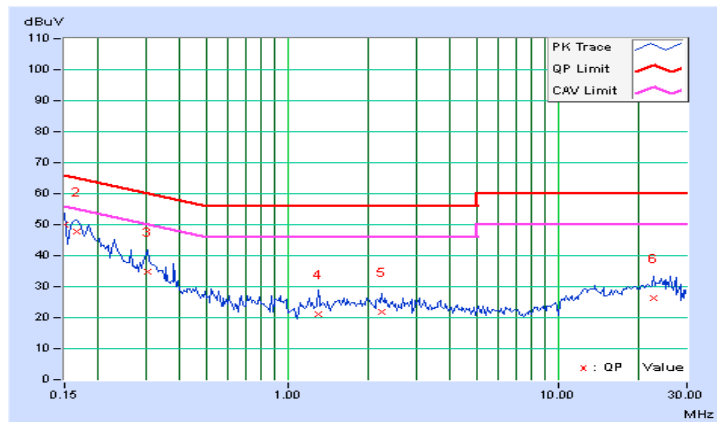

Phase	Neutral (N)	Detector Function	Quasi-Peak (QP) / Average (AV)
-------	-------------	-------------------	--------------------------------

No	Freq. [MHz]	Corr.	Reading Value		Emission Level		Limit		Margin	
		Factor	[dB (uV)]		[dB (uV)]		[dB (uV)]		(dB)	
		(dB)	Q.P.	AV.	Q.P.	AV.	Q.P.	AV.	Q.P.	AV.
1	0.16172	0.08	47.86	34.34	47.94	34.42	65.38	55.38	-17.44	-20.96
2	0.30625	0.09	35.04	25.54	35.13	25.63	60.07	50.07	-24.94	-24.44
3	0.65000	0.11	24.60	17.80	24.71	17.91	56.00	46.00	-31.29	-28.09
4	0.91953	0.13	24.90	20.16	25.03	20.29	56.00	46.00	-30.97	-25.71
5	2.60547	0.19	20.40	14.96	20.59	15.15	56.00	46.00	-35.41	-30.85
6	23.47266	0.82	26.68	21.94	27.50	22.76	60.00	50.00	-32.50	-27.24

REMARKS:

1. Q.P. and AV. are abbreviations of quasi-peak and average individually.
2. The emission levels of other frequencies were very low against the limit.
3. Margin value = Emission Level – Limit value
4. Correction Factor = Insertion loss + Cable loss
5. Emission Level = Correction Factor + Reading Value

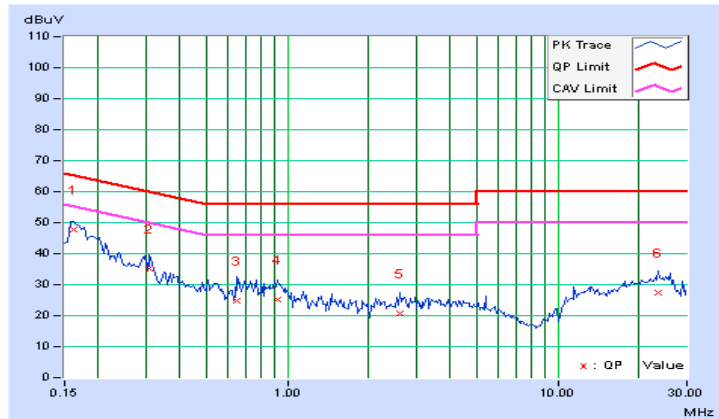

4.3 Transmit Power Measurement

4.3.1 Limits of Transmit Power Measurement

Operation Band	EUT Category		LIMIT
U-NII-1		Outdoor Access Point	1 Watt (30 dBm) (Max. e.i.r.p \leq 125mW(21 dBm) at any elevation angle above 30 degrees as measured from the horizon)
		Fixed point-to-point Access Point	1 Watt (30 dBm)
	√	Indoor Access Point	1 Watt (30 dBm)
		Mobile and Portable client device	250mW (24 dBm)
U-NII-2A			250mW (24 dBm) or 11 dBm+10 log B*
U-NII-2C			250mW (24 dBm) or 11 dBm+10 log B*
U-NII-3	√		1 Watt (30 dBm)

*B is the 26 dB emission bandwidth in megahertz

Per KDB 662911 Method of conducted output power measurement on IEEE 802.11 devices,

Array Gain = 0 dB (i.e., no array gain) for $N_{ANT} \leq 4$;

Array Gain = 0 dB (i.e., no array gain) for channel widths ≥ 40 MHz for any N_{ANT} ;

Array Gain = $5 \log(N_{ANT}/N_{SS})$ dB or 3 dB, whichever is less for 20-MHz channel widths with $N_{ANT} \geq 5$.

For power measurements on all other devices: Array Gain = $10 \log(N_{ANT}/N_{SS})$ dB.

4.3.2 Test Setup

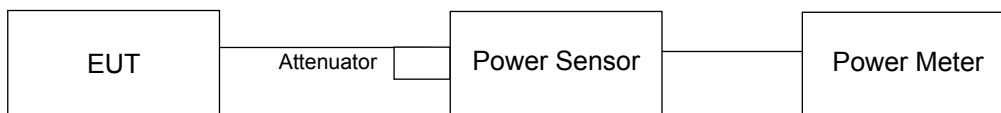

4.3.3 Test Instruments

Refer to section 4.1.2 to get information of above instrument.

4.3.4 Test Procedures

Method PM is used to perform output power measurement, trigger and gating function of wide band power meter is enabled to measure max output power of TX on burst. Duty factor is not added to measured value.

4.3.5 Deviation from Test Standard

No deviation.

4.3.6 EUT Operating Conditions

The software provided by client to enable the EUT under transmission condition continuously at lowest, middle and highest channel frequencies individually.

4.3.7 Test Results (Mode 1)

1TX Mode

802.11a

Chan.	Chan. Freq. (MHz)	Average Power (mW)	Average Power (dBm)	Limit (dBm)	Pass / Fail
36	5180	232.274	23.66	30	Pass
40	5200	265.461	24.24	30	Pass
48	5240	209.894	23.22	30	Pass
149	5745	240.436	23.81	30	Pass
157	5785	171.002	22.33	30	Pass
165	5825	215.774	23.34	30	Pass

802.11ac (VHT20)

Chan.	Chan. Freq. (MHz)	Average Power (mW)	Average Power (dBm)	Limit (dBm)	Pass / Fail
36	5180	240.436	23.81	30	Pass
40	5200	228.034	23.58	30	Pass
48	5240	209.894	23.22	30	Pass
149	5745	185.78	22.69	30	Pass
157	5785	202.302	23.06	30	Pass
165	5825	217.27	23.37	30	Pass

802.11ac (VHT40)

Chan.	Chan. Freq. (MHz)	Average Power (mW)	Average Power (dBm)	Limit (dBm)	Pass / Fail
38	5190	89.743	19.53	30	Pass
46	5230	209.411	23.21	30	Pass
151	5755	143.549	21.57	30	Pass
159	5795	171.002	22.33	30	Pass

802.11ac (VHT80)

Chan.	Chan. Freq. (MHz)	Average Power (mW)	Average Power (dBm)	Limit (dBm)	Pass / Fail
42	5210	55.208	17.42	30	Pass
155	5775	87.297	19.41	30	Pass

2TX Mode
802.11ac (VHT20)

Chan.	Chan. Freq. (MHz)	Average Power (dBm)		Total Power (mW)	Total Power (dBm)	Limit (dBm)	Pass / Fail
		Chain 0	Chain 1				
36	5180	20.03	19.76	195.317	22.91	30	Pass
40	5200	21.35	21.67	283.351	24.52	30	Pass
48	5240	20.63	20.23	221.05	23.44	30	Pass
149	5745	20.30	17.37	161.728	22.09	30	Pass
157	5785	20.60	17.42	170.023	22.31	30	Pass
165	5825	21.09	17.40	183.483	22.64	30	Pass

802.11ac (VHT40)

Chan.	Chan. Freq. (MHz)	Average Power (dBm)		Total Power (mW)	Total Power (dBm)	Limit (dBm)	Pass / Fail
		Chain 0	Chain 1				
38	5190	16.33	15.42	77.788	18.91	30	Pass
46	5230	21.07	21.39	265.659	24.24	30	Pass
151	5755	19.55	17.22	142.88	21.55	30	Pass
159	5795	20.52	17.05	163.419	22.13	30	Pass

802.11ac (VHT80)

Chan.	Chan. Freq. (MHz)	Average Power (dBm)		Total Power (mW)	Total Power (dBm)	Limit (dBm)	Pass / Fail
		Chain 0	Chain 1				
42	5210	14.40	13.28	48.823	16.89	30	Pass
155	5775	15.75	16.04	77.763	18.91	30	Pass

4.3.8 Test Results (Mode 2)

1TX Mode

802.11a

Chan.	Chan. Freq. (MHz)	Average Power (mW)	Average Power (dBm)	Limit (dBm)	Pass / Fail
36	5180	66.374	18.22	22.19	Pass
40	5200	41.21	16.15	22.19	Pass
48	5240	10.069	10.03	22.19	Pass
149	5745	42.364	16.27	22.19	Pass
157	5785	137.721	21.39	22.19	Pass
165	5825	90.157	19.55	22.19	Pass

Note: The directional gain is 13.81dBi > 6dBi, therefore the limit needs to reduce, so the power limit shall be reduced to $30-(13.81-6) = 22.19$ dBm.

802.11ac (VHT20)

Chan.	Chan. Freq. (MHz)	Average Power (mW)	Average Power (dBm)	Limit (dBm)	Pass / Fail
36	5180	65.917	18.19	22.19	Pass
40	5200	44.771	16.51	22.19	Pass
48	5240	10.399	10.17	22.19	Pass
149	5745	40.272	16.05	22.19	Pass
157	5785	142.561	21.54	22.19	Pass
165	5825	68.391	18.35	22.19	Pass

Note: The directional gain is 13.81dBi > 6dBi, therefore the limit needs to reduce, so the power limit shall be reduced to $30-(13.81-6) = 22.19$ dBm.

802.11ac (VHT40)

Chan.	Chan. Freq. (MHz)	Average Power (mW)	Average Power (dBm)	Limit (dBm)	Pass / Fail
38	5190	24.378	13.87	22.19	Pass
46	5230	36.475	15.62	22.19	Pass
151	5755	23.174	13.65	22.19	Pass
159	5795	83.56	19.22	22.19	Pass

Note: The directional gain is 13.81dBi > 6dBi, therefore the limit needs to reduce, so the power limit shall be reduced to $30-(13.81-6) = 22.19\text{dBm}$.

802.11ac (VHT80)

Chan.	Chan. Freq. (MHz)	Average Power (dBm)	Power (mW)	Limit (dBm)	Pass / Fail
42	5210	13.49	11.30	22.19	Pass
155	5775	15.311	11.85	22.19	Pass

Note: The directional gain is 13.81dBi > 6dBi, therefore the limit needs to reduce, so the power limit shall be reduced to $30-(13.81-6) = 22.19\text{dBm}$.

2TX Mode
802.11ac (VHT20)

Chan.	Chan. Freq. (MHz)	Average Power (dBm)		Total Power (mW)	Total Power (dBm)	Limit (dBm)	Pass / Fail
		Chain 0	Chain 1				
36	5180	18.19	18.12	130.78	21.17	22.19	Pass
40	5200	15.51	15.45	70.638	18.49	22.19	Pass
48	5240	10.68	10.37	22.584	13.54	22.19	Pass
149	5745	13.38	12.52	39.642	15.98	22.19	Pass
157	5785	17.32	17.86	115.045	20.61	22.19	Pass
165	5825	16.54	16.30	87.74	19.43	22.19	Pass

Note: The directional gain is 13.81dBi > 6dBi, therefore the limit needs to reduce, so the power limit shall be reduced to $30-(13.81-6) = 22.19\text{dBm}$.

802.11ac (VHT40)

Chan.	Chan. Freq. (MHz)	Average Power (dBm)		Total Power (mW)	Total Power (dBm)	Limit (dBm)	Pass / Fail
		Chain 0	Chain 1				
38	5190	13.29	13.82	45.429	16.57	22.19	Pass
46	5230	14.74	14.76	59.708	17.76	22.19	Pass
151	5755	13.47	12.87	41.597	16.19	22.19	Pass
159	5795	17.57	16.84	105.454	20.23	22.19	Pass

Note: The directional gain is 13.81dBi > 6dBi, therefore the limit needs to reduce, so the power limit shall be reduced to $30-(13.81-6) = 22.19\text{dBm}$.

802.11ac (VHT80)

Chan.	Chan. Freq. (MHz)	Average Power (dBm)		Total Power (mW)	Total Power (dBm)	Limit (dBm)	Pass / Fail
		Chain 0	Chain 1				
42	5210	9.98	8.54	17.099	12.33	22.19	Pass
155	5775	10.82	11.03	24.755	13.94	22.19	Pass

Note: The directional gain is 13.81dBi > 6dBi, therefore the limit needs to reduce, so the power limit shall be reduced to $30-(13.81-6) = 22.19\text{dBm}$.

4.4 Peak Power Spectral Density Measurement

4.4.1 Limits of Peak Power Spectral Density Measurement

Operation Band	EUT Category		LIMIT
U-NII-1		Outdoor Access Point	17dBm/ MHz
		Fixed point-to-point Access Point	
	√	Indoor Access Point	
		Mobile and Portable client device	11dBm/ MHz
U-NII-2A			11dBm/ MHz
U-NII-2C			11dBm/ MHz
U-NII-3		√	30dBm/ MHz

4.4.2 Test Setup

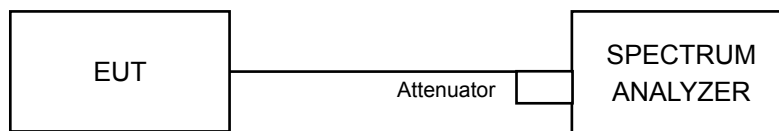

4.4.3 Test Instruments

Refer to section 4.1.2 to get information of above instrument.

4.4.4 Test Procedures

For U-NII-1:

- Set span to encompass the entire emission bandwidth (EBW) of the signal.
- Set RBW = 1MHz, Set VBW ≥ 3 MHz, Detector = RMS
- Sweep time = auto, trigger set to “free run”.
- Trace average at least 100 traces in power averaging mode.
- Record the max value and for duty cycle of test signal is < 98% add 10 log (1/duty cycle)
- Record the max value

For U-NII-3:

- Set span to encompass the entire emission bandwidth (EBW) of the signal.
- Set RBW = 300 kHz, Set VBW ≥ 1 MHz, Detector = RMS
- Use the peak marker function to determine the maximum power level in any 300 kHz band segment within the fundamental EBW.
- Scale the observed power level to an equivalent value in 500 kHz by adjusting (reducing) the measured power by a bandwidth correction factor (BWCF) where $BWCF = 10\log(500\text{ kHz}/300\text{kHz})$
- Sweep time = auto, trigger set to “free run”.
- Trace average at least 100 traces in power averaging mode.
- Record the max value and for duty cycle of test signal is < 98% add 10 log (1/duty cycle)

4.4.5 Deviation from Test Standard

No deviation.

4.4.6 EUT Operating Conditions

Same as Item 4.3.6.

4.4.7 Test Results (Mode 1)

For U-NII-1:

1TX Mode

802.11a

Chan.	Chan. Freq. (MHz)	PSD (dBm)	MAX. Limit (dBm)	Pass / Fail
36	5180	9.06	17	Pass
40	5200	8.95	17	Pass
48	5240	9.06	17	Pass

802.11ac (VHT20)

Chan.	Chan. Freq. (MHz)	PSD (dBm)	MAX. Limit (dBm)	Pass / Fail
36	5180	9.52	17	Pass
40	5200	9.48	17	Pass
48	5240	8.74	17	Pass

802.11ac (VHT40)

Chan.	Chan. Freq. (MHz)	PSD (dBm)	MAX. Limit (dBm)	Pass / Fail
38	5190	2.30	17	Pass
46	5230	5.73	17	Pass

802.11ac (VHT80)

Chan.	Chan. Freq. (MHz)	PSD (dBm)	MAX. Limit (dBm)	Pass / Fail
42	5210	-1.26	17	Pass

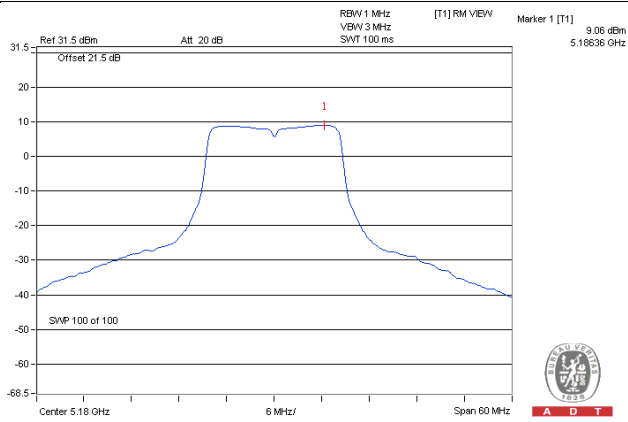
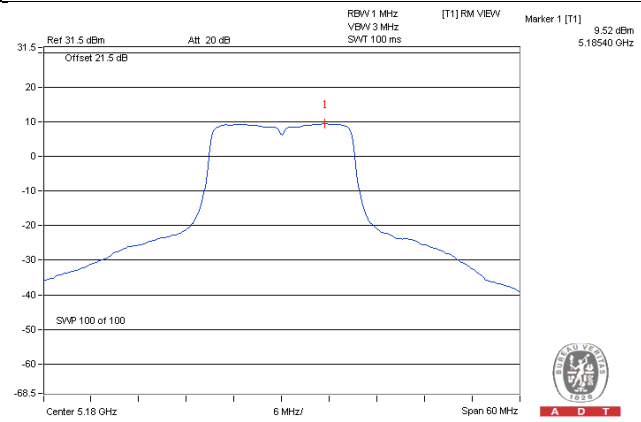
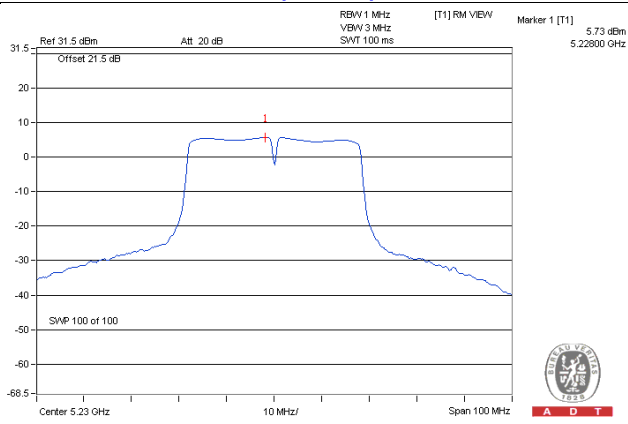
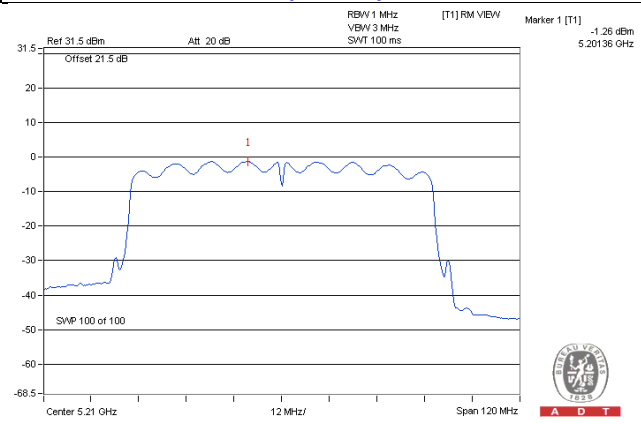
Spectrum Plot of Worst Value**802.11a / CH36****802.11ac (VHT20) / CH36****802.11ac (VHT40) / CH46****802.11ac (VHT80) / CH42**

2TX Mode
802.11ac (VHT20)

Chan.	Chan. Freq. (MHz)	PSD (dBm)		Total Power Density (dBm)	MAX. Limit (dBm)	Pass / Fail
		Chain 0	Chain 1			
36	5180	5.46	4.95	8.22	17	Pass
40	5200	7.20	6.82	10.02	17	Pass
48	5240	6.88	6.80	9.85	17	Pass

Note: 1. Method a) of power density measurement of KDB 662911 is using for calculating total power density. Total power density is summing entire spectra across corresponding frequency bins on the various outputs by computer.

802.11ac (VHT40)

Chan.	Chan. Freq. (MHz)	PSD (dBm)		Total Power Density (dBm)	MAX. Limit (dBm)	Pass / Fail
		Chain 0	Chain 1			
38	5190	-0.95	-0.68	2.20	17	Pass
46	5230	3.66	3.51	6.60	17	Pass

Note: 1. Method a) of power density measurement of KDB 662911 is using for calculating total power density. Total power density is summing entire spectra across corresponding frequency bins on the various outputs by computer.

802.11ac (VHT80)

Chan.	Chan. Freq. (MHz)	PSD (dBm)		Total Power Density (dBm)	MAX. Limit (dBm)	Pass / Fail
		Chain 0	Chain 1			
42	5210	-4.65	-6.01	-2.27	17	Pass

Note: 1. Method a) of power density measurement of KDB 662911 is using for calculating total power density. Total power density is summing entire spectra across corresponding frequency bins on the various outputs by computer.

Spectrum Plot of Worst Value

802.11ac (VHT20)_Chain 0 / CH40

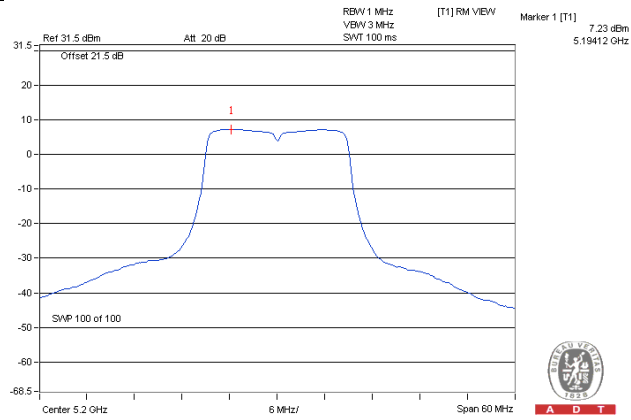

802.11ac (VHT40)_Chain 0 / CH46

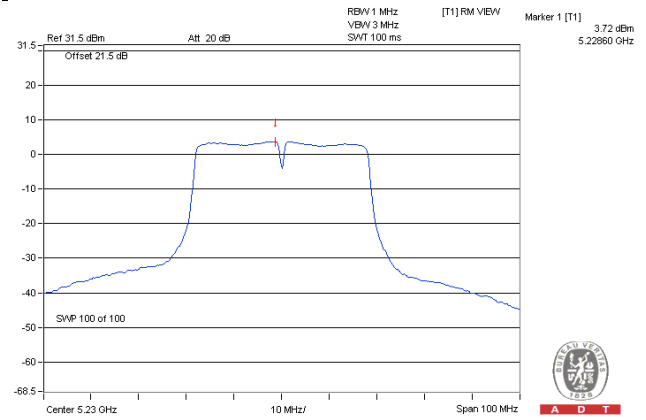

802.11ac (VHT80)_Chain 0 / CH42

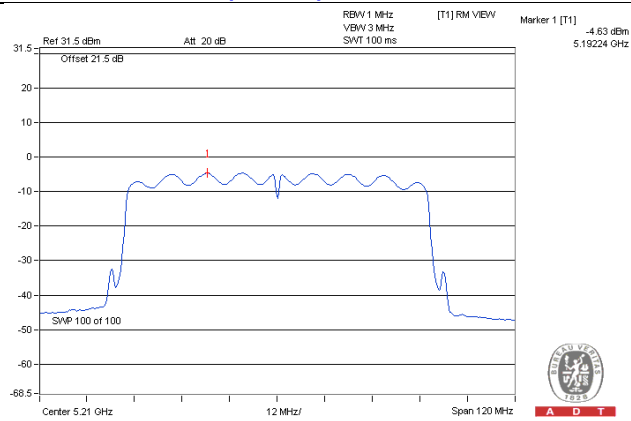

For U-NII-3:
1TX Mode
802.11a

Chan.	Chan. Freq. (MHz)	PSD		Total PSD (dBm/500kHz)	Limit (dBm/500kHz)	Pass /Fail
		(dBm/300kHz)	(dBm/500kHz)			
149	5745	1.43	3.65	3.65	30	Pass
157	5785	1.57	3.79	3.79	30	Pass
165	5825	1.89	4.11	4.11	30	Pass

802.11ac (VHT20)

Chan.	Chan. Freq. (MHz)	PSD		Total PSD (dBm/500kHz)	Limit (dBm/500kHz)	Pass /Fail
		(dBm/300kHz)	(dBm/500kHz)			
149	5745	0.43	2.65	2.65	30	Pass
157	5785	0.65	2.87	2.87	30	Pass
165	5825	1.13	3.35	3.35	30	Pass

802.11ac (VHT40)

Chan.	Chan. Freq. (MHz)	PSD		Total PSD (dBm/500kHz)	Limit (dBm/500kHz)	Pass /Fail
		(dBm/300kHz)	(dBm/500kHz)			
151	5755	-3.83	-1.61	-1.61	30	Pass
159	5795	-2.91	-0.69	-0.69	30	Pass

802.11ac (VHT80)

Chan.	Chan. Freq. (MHz)	PSD		Total PSD (dBm/500kHz)	Limit (dBm/500kHz)	Pass /Fail
		(dBm/300kHz)	(dBm/500kHz)			
155	5775	-8.06	-5.84	-5.84	30	Pass

Spectrum Plot of Worst Value

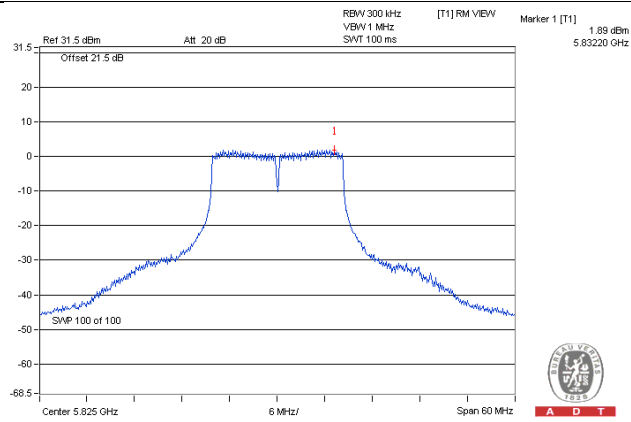
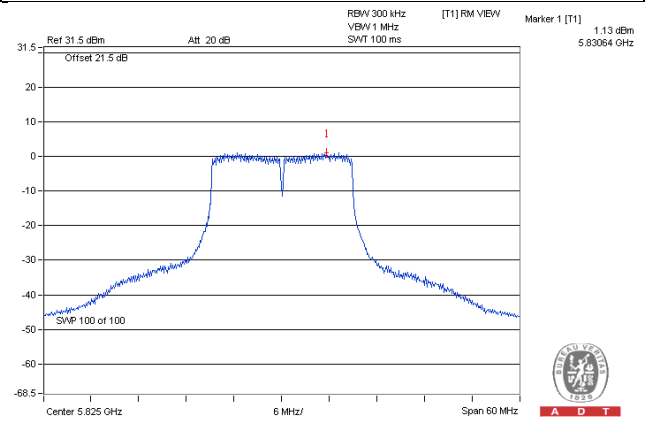
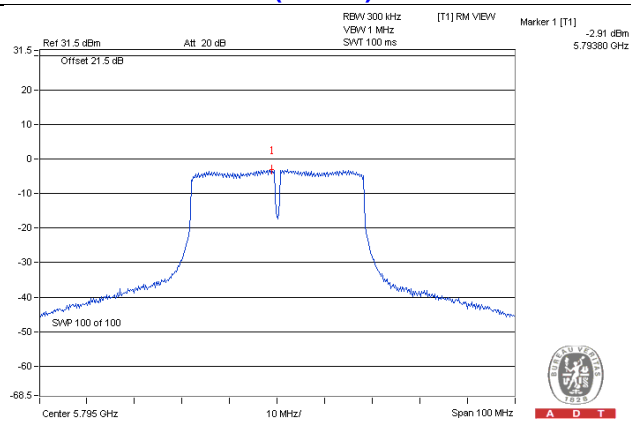
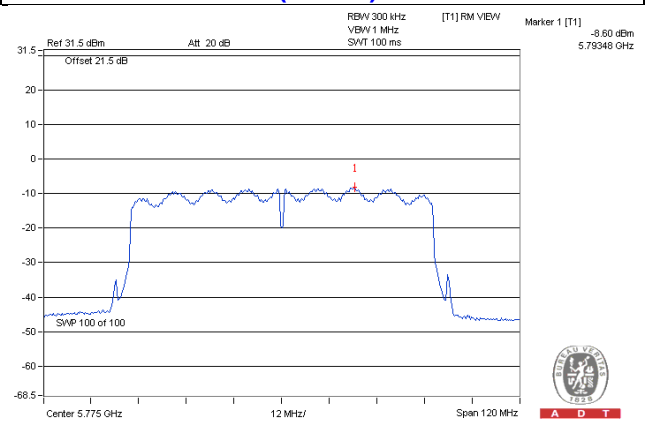
802.11a / CH165**802.11ac (VHT20) / CH165****802.11ac (VHT40) / CH159****802.11ac (VHT80) / CH155**

2TX Mode
802.11ac (VHT20)

TX chain	Chan.	Chan. Freq. (MHz)	PSD		10 log (N=2) dB	Total PSD (dBm/500kHz)	Limit (dBm/500kHz)	Pass /Fail
			(dBm/300kHz)	(dBm/500kHz)				
0	149	5745	-1.71	0.51	3.01	3.52	30	Pass
	157	5785	-1.36	0.86	3.01	3.87	30	Pass
	165	5825	-1.10	1.12	3.01	4.13	30	Pass
1	149	5745	-5.19	-2.97	3.01	0.04	30	Pass
	157	5785	-4.92	-2.70	3.01	0.31	30	Pass
	165	5825	-4.81	-2.59	3.01	0.42	30	Pass

802.11ac (VHT40)

TX chain	Chan.	Chan. Freq. (MHz)	PSD		10 log (N=2) dB	Total PSD (dBm/500kHz)	Limit (dBm/500kHz)	Pass /Fail
			(dBm/300kHz)	(dBm/500kHz)				
0	151	5755	-5.88	-3.66	3.01	-0.65	30	Pass
	159	5795	-4.97	-2.75	3.01	0.26	30	Pass
1	151	5755	-9.03	-6.81	3.01	-3.80	30	Pass
	159	5795	-8.68	-6.46	3.01	-3.45	30	Pass

802.11ac (VHT80)

TX chain	Chan.	Chan. Freq. (MHz)	PSD		10 log (N=2) dB	Total PSD (dBm/500kHz)	Limit (dBm/500kHz)	Pass /Fail
			(dBm/300kHz)	(dBm/500kHz)				
0	155	5775	-12.03	-9.81	3.01	-6.80	30	Pass
1	155	5775	-10.85	-8.63	3.01	-5.62	30	Pass

Spectrum Plot of Worst Value

802.11ac (VHT20)_Chain 0 / CH165

802.11ac (VHT40)_Chain 0 / CH159

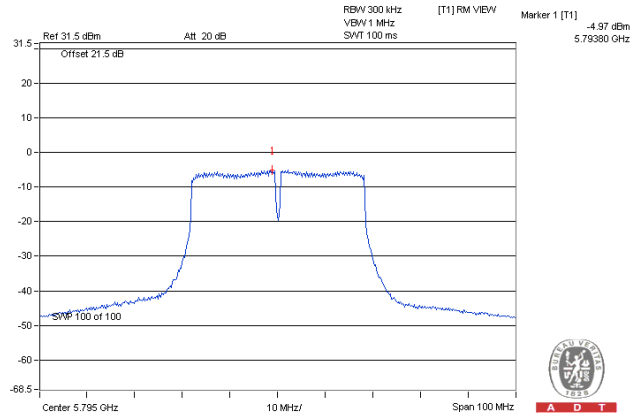
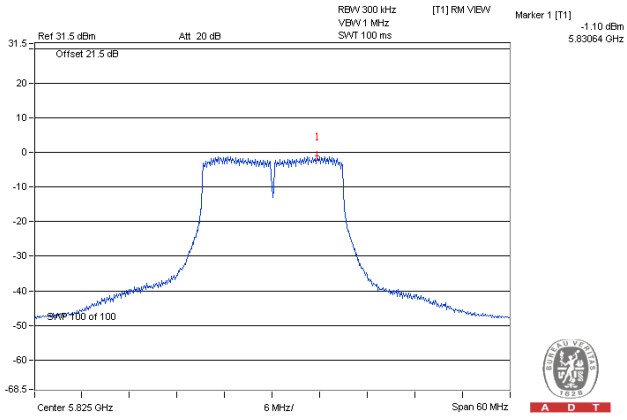

802.11ac (VHT80)_Chain 1 / CH155

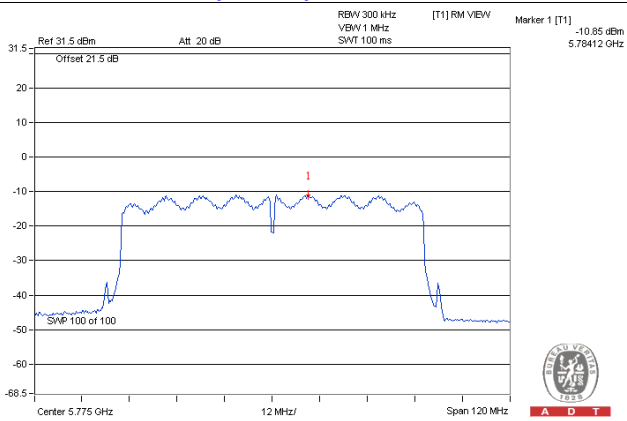

4.4.8 Test Results (Mode 2)

For U-NII-1:

1TX Mode

802.11a

Chan.	Chan. Freq. (MHz)	PSD (dBm)	MAX. Limit (dBm)	Pass / Fail
36	5180	1.49	9.19	Pass
40	5200	1.90	9.19	Pass
48	5240	-4.43	9.19	Pass

Note: The directional gain is 13.81dBi > 6dBi, therefore the limit needs to reduce, so the power density limit shall be reduced to $17-(13.81-6) = 9.19\text{dBm}$.

802.11ac (VHT20)

Chan.	Chan. Freq. (MHz)	PSD (dBm)	MAX. Limit (dBm)	Pass / Fail
36	5180	2.87	9.19	Pass
40	5200	1.67	9.19	Pass
48	5240	-4.52	9.19	Pass

Note: The directional gain is 13.81dBi > 6dBi, therefore the limit needs to reduce, so the power density limit shall be reduced to $17-(13.81-6) = 9.19\text{dBm}$.

802.11ac (VHT40)

Chan.	Chan. Freq. (MHz)	PSD (dBm)	MAX. Limit (dBm)	Pass / Fail
38	5190	-4.40	9.19	Pass
46	5230	-2.18	9.19	Pass

Note: The directional gain is 13.81dBi > 6dBi, therefore the limit needs to reduce, so the power density limit shall be reduced to $17-(13.81-6) = 9.19\text{dBm}$.

802.11ac (VHT80)

Chan.	Chan. Freq. (MHz)	PSD (dBm)	MAX. Limit (dBm)	Pass / Fail
42	5210	-8.44	9.19	Pass

Note: The directional gain is 13.81dBi > 6dBi, therefore the limit needs to reduce, so the power density limit shall be reduced to $17-(13.81-6) = 9.19\text{dBm}$.

Spectrum Plot of Worst Value

802.11a / CH40

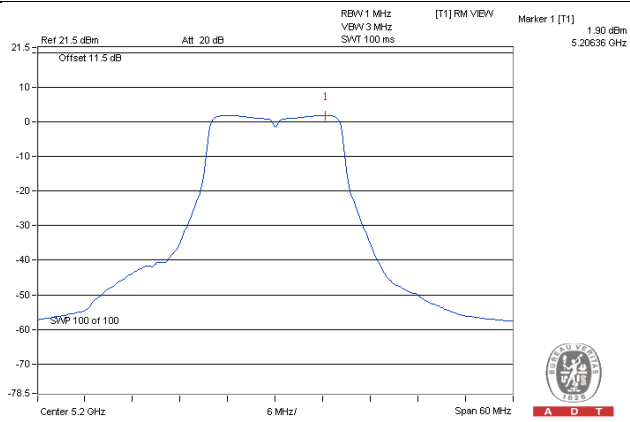

802.11ac (VHT20) / CH36

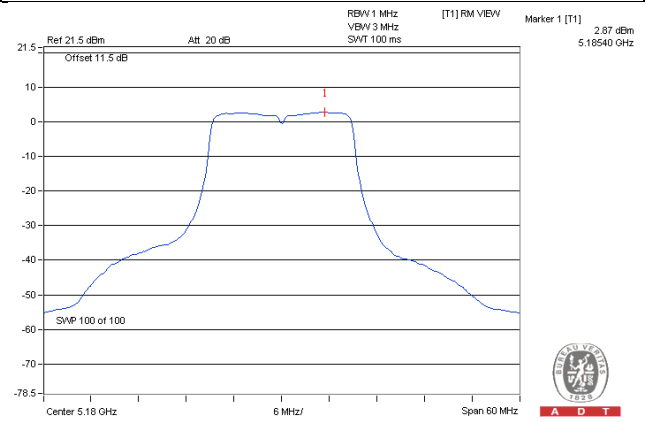

802.11ac (VHT40) / CH46

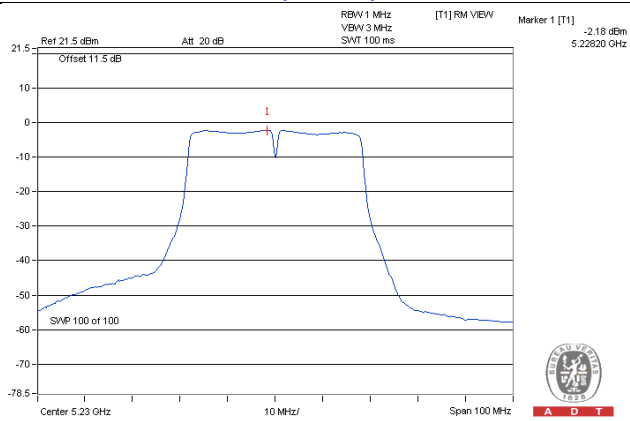

802.11ac (VHT80) / CH42

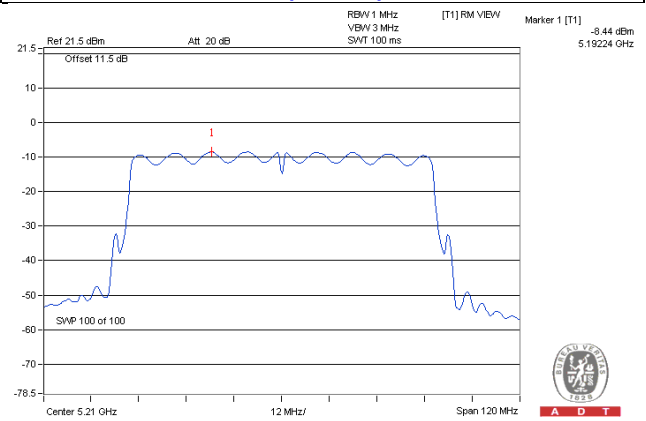

2TX Mode
802.11ac (VHT20)

Chan.	Chan. Freq. (MHz)	PSD (dBm)		Total Power Density (dBm)	MAX. Limit (dBm)	Pass / Fail
		Chain 0	Chain 1			
36	5180	2.63	3.11	5.89	9.19	Pass
40	5200	0.77	0.82	3.81	9.19	Pass
48	5240	-4.43	-5.20	-1.79	9.19	Pass

- Note:** 1. Method a) of power density measurement of KDB 662911 is using for calculating total power density. Total power density is summing entire spectra across corresponding frequency bins on the various outputs by computer.
2. The directional gain is 13.81dBi > 6dBi, therefore the limit needs to reduce, so the power density limit shall be reduced to $17-(13.81-6) = 9.19\text{dBm}$.

802.11ac (VHT40)

Chan.	Chan. Freq. (MHz)	PSD (dBm)		Total Power Density (dBm)	MAX. Limit (dBm)	Pass / Fail
		Chain 0	Chain 1			
38	5190	-3.73	-4.78	-1.21	9.19	Pass
46	5230	-2.31	-3.52	0.14	9.19	Pass

- Note:** 1. Method a) of power density measurement of KDB 662911 is using for calculating total power density. Total power density is summing entire spectra across corresponding frequency bins on the various outputs by computer.
2. The directional gain is 13.81dBi > 6dBi, therefore the limit needs to reduce, so the power density limit shall be reduced to $17-(13.81-6) = 9.19\text{dBm}$.

802.11ac (VHT80)

Chan.	Chan. Freq. (MHz)	PSD (dBm)		Total Power Density (dBm)	MAX. Limit (dBm)	Pass / Fail
		Chain 0	Chain 1			
42	5210	-8.21	-10.53	-6.21	9.19	Pass

- Note:** 1. Method a) of power density measurement of KDB 662911 is using for calculating total power density. Total power density is summing entire spectra across corresponding frequency bins on the various outputs by computer.
2. The directional gain is 13.81dBi > 6dBi, therefore the limit needs to reduce, so the power density limit shall be reduced to $17-(13.81-6) = 9.19\text{dBm}$.

Spectrum Plot of Worst Value

802.11ac (VHT20)_Chain 1 / CH36

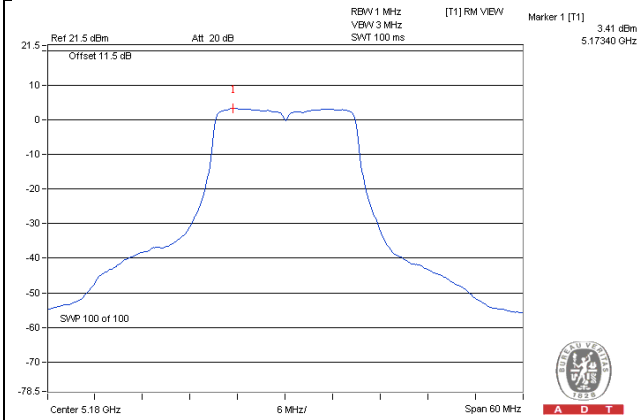

802.11ac (VHT40)_Chain 0 / CH46

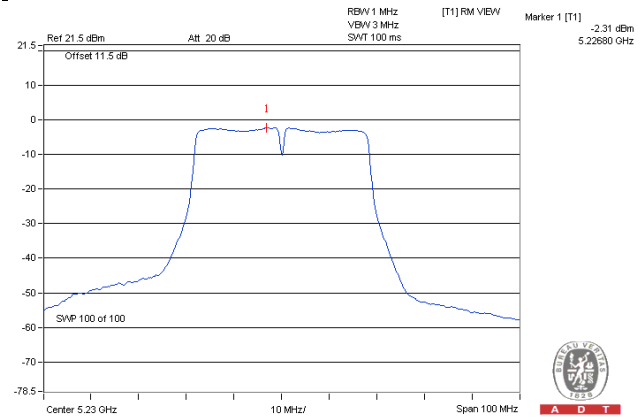

802.11ac (VHT80)_Chain 0 / CH42

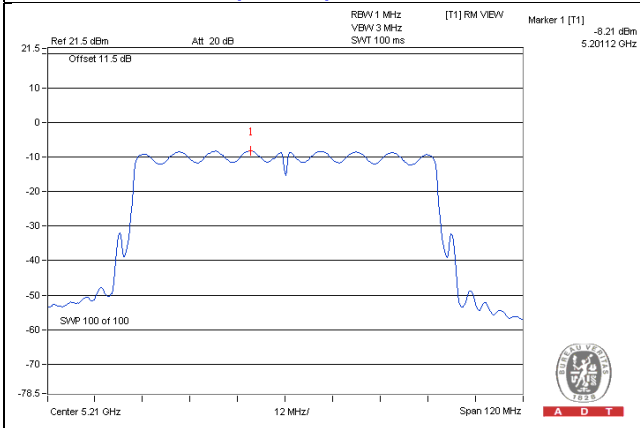

For U-NII-3:
1TX Mode
802.11a

Chan.	Chan. Freq. (MHz)	PSD		Total PSD (dBm/500kHz)	Limit (dBm/500kHz)	Pass /Fail
		(dBm/300kHz)	(dBm/500kHz)			
149	5745	-5.78	-3.56	-3.56	22.19	Pass
157	5785	0.00	2.22	2.22	22.19	Pass
165	5825	-2.46	-0.24	-0.24	22.19	Pass

Note: 1. The directional gain is 13.81dBi > 6dBi, therefore the limit needs to reduce, so the power density limit shall be reduced to $30-(13.81-6) = 22.19\text{dBm}$.

802.11ac (VHT20)

Chan.	Chan. Freq. (MHz)	PSD		Total PSD (dBm/500kHz)	Limit (dBm/500kHz)	Pass /Fail
		(dBm/300kHz)	(dBm/500kHz)			
149	5745	-5.92	-3.70	-3.70	22.19	Pass
157	5785	-0.22	2.00	2.00	22.19	Pass
165	5825	-3.70	-1.48	-1.48	22.19	Pass

Note: 1. The directional gain is 13.81dBi > 6dBi, therefore the limit needs to reduce, so the power density limit shall be reduced to $30-(13.81-6) = 22.19\text{dBm}$.

802.11ac (VHT40)

Chan.	Chan. Freq. (MHz)	PSD		Total PSD (dBm/500kHz)	Limit (dBm/500kHz)	Pass /Fail
		(dBm/300kHz)	(dBm/500kHz)			
151	5755	-12.35	-10.13	-10.13	22.19	Pass
159	5795	-6.51	-4.29	-4.29	22.19	Pass

Note: 1. The directional gain is 13.81dBi > 6dBi, therefore the limit needs to reduce, so the power density limit shall be reduced to $30-(13.81-6) = 22.19\text{dBm}$.

802.11ac (VHT80)

Chan.	Chan. Freq. (MHz)	PSD		Total PSD (dBm/500kHz)	Limit (dBm/500kHz)	Pass /Fail
		(dBm/300kHz)	(dBm/500kHz)			
155	5775	-15.76	-13.54	-13.54	22.19	Pass

Note: 1. The directional gain is 13.81dBi > 6dBi, therefore the limit needs to reduce, so the power density limit shall be reduced to $30-(13.81-6) = 22.19\text{dBm}$.

Spectrum Plot of Worst Value

802.11a / CH157

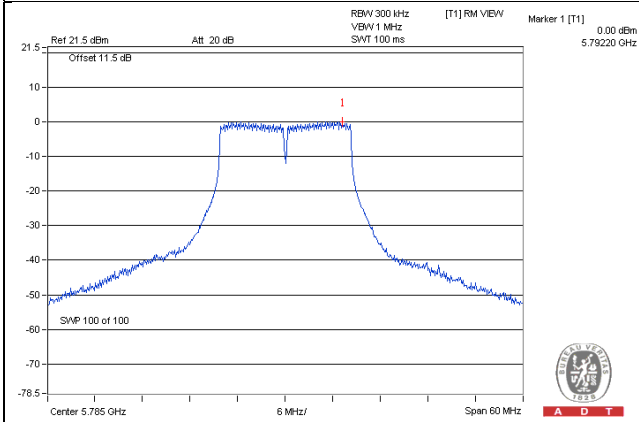

802.11ac (VHT20) / CH157

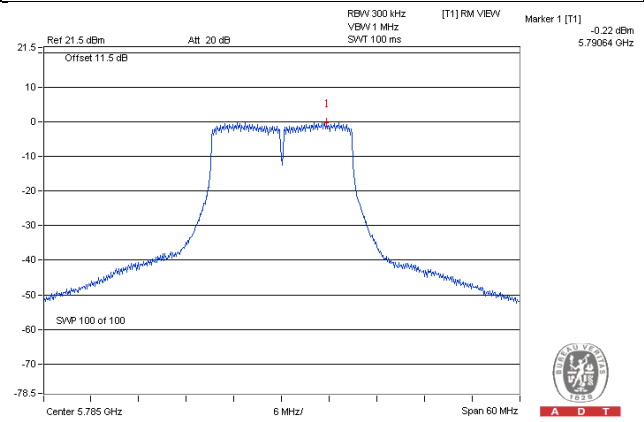

802.11ac (VHT40) / CH159

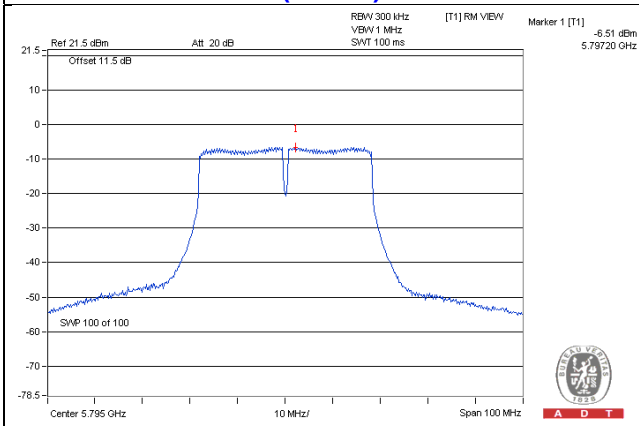

802.11ac (VHT80) / CH155

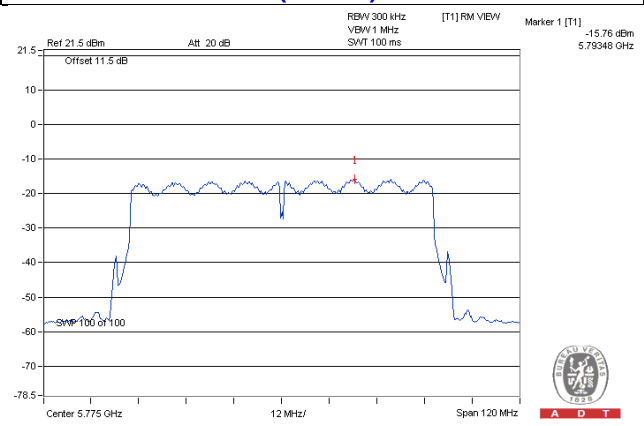

2TX Mode
802.11ac (VHT20)

TX chain	Chan.	Chan. Freq. (MHz)	PSD		10 log (N=2) dB	Total PSD (dBm/500kHz)	Limit (dBm/500kHz)	Pass /Fail
			(dBm/300kHz)	(dBm/500kHz)				
0	149	5745	-8.54	-6.32	3.01	-3.31	22.19	Pass
	157	5785	-4.32	-2.10	3.01	0.91	22.19	Pass
	165	5825	-4.58	-2.36	3.01	0.65	22.19	Pass
1	149	5745	-8.90	-6.68	3.01	-3.67	22.19	Pass
	157	5785	-4.99	-2.77	3.01	0.24	22.19	Pass
	165	5825	-5.35	-3.13	3.01	-0.12	22.19	Pass

Note: 1. The directional gain is 13.81dBi > 6dBi, therefore the limit needs to reduce, so the power density limit shall be reduced to $30-(13.81-6) = 22.19$ dBm.

802.11ac (VHT40)

TX chain	Chan.	Chan. Freq. (MHz)	PSD		10 log (N=2) dB	Total PSD (dBm/500kHz)	Limit (dBm/500kHz)	Pass /Fail
			(dBm/300kHz)	(dBm/500kHz)				
0	151	5755	-12.29	-10.07	3.01	-7.06	22.19	Pass
	159	5795	-7.40	-5.18	3.01	-2.17	22.19	Pass
1	151	5755	-12.84	-10.62	3.01	-7.61	22.19	Pass
	159	5795	-8.49	-6.27	3.01	-3.26	22.19	Pass

Note: 1. The directional gain is 13.81dBi > 6dBi, therefore the limit needs to reduce, so the power density limit shall be reduced to $30-(13.81-6) = 22.19$ dBm.

802.11ac (VHT80)

TX chain	Chan.	Chan. Freq. (MHz)	PSD		10 log (N=2) dB	Total PSD (dBm/500kHz)	Limit (dBm/500kHz)	Pass /Fail
			(dBm/300kHz)	(dBm/500kHz)				
0	155	5775	-16.69	-14.47	3.01	-11.46	22.19	Pass
1	155	5775	-10.77	-8.55	3.01	-5.54	22.19	Pass

Note: 1. The directional gain is 13.81dBi > 6dBi, therefore the limit needs to reduce, so the power density limit shall be reduced to $30-(13.81-6) = 22.19$ dBm.

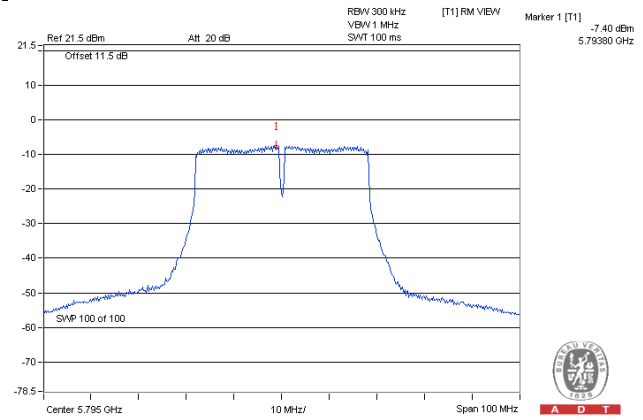
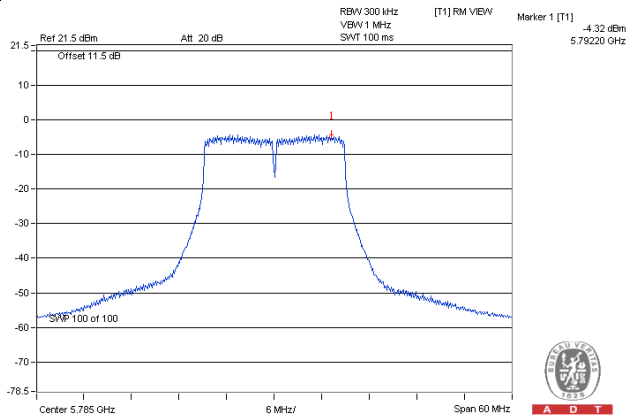
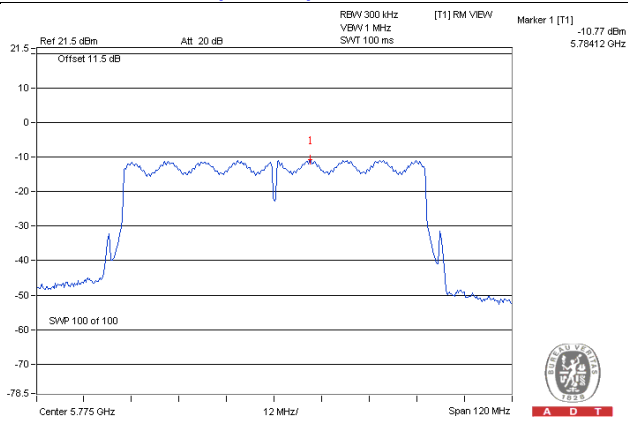
Spectrum Plot of Worst Value**802.11ac (VHT20)_Chain 0 / CH157****802.11ac (VHT40)_Chain 0 / CH159****802.11ac (VHT80)_Chain 1 / CH155**

4.5 Frequency Stability Measurement

4.5.1 Limits of Frequency Stability Measurement

The frequency of the carrier signal shall be maintained within band of operation

4.5.2 Test Setup

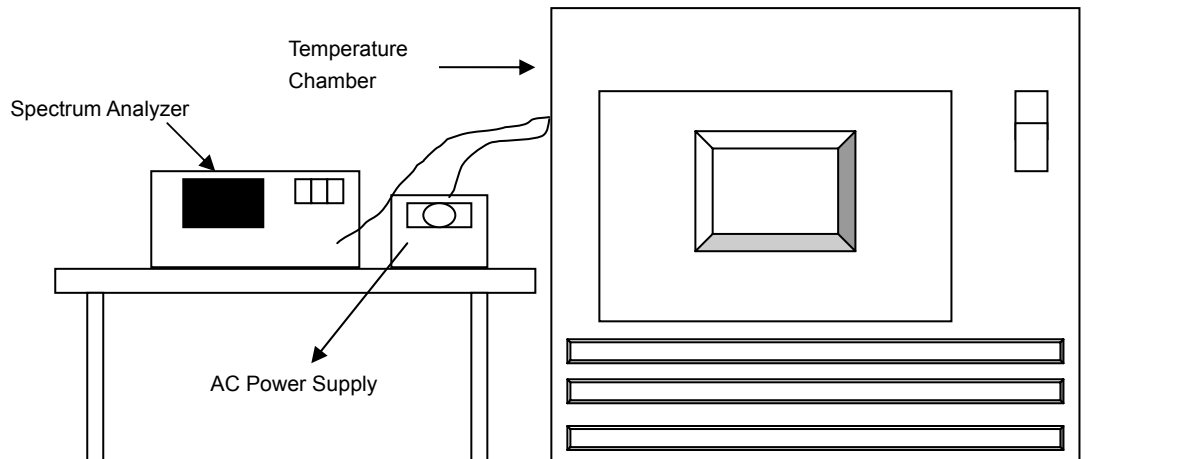

4.5.3 Test Instruments

Refer to section 4.1.2 to get information of above instrument.

4.5.4 Test Procedures

- The EUT was placed inside the environmental test chamber and powered by nominal AC voltage.
- Turn the EUT on and couple its output to a spectrum analyzer.
- Turn the EUT off and set the chamber to the highest temperature specified.
- Allow sufficient time (approximately 30 min) for the temperature of the chamber to stabilize, turn the EUT on and measure the operating frequency after 2, 5, and 10 minutes.
- Repeat step 2 and 3 with the temperature chamber set to the lowest temperature.
- The test chamber was allowed to stabilize at +20 degree C for a minimum of 30 minutes. The supply voltage was then adjusted on the EUT from 85% to 115% and the frequency record.

4.5.5 Deviation from Test Standard

No deviation.

4.5.6 EUT Operating Conditions

Set the EUT transmit at un-modulation mode to test frequency stability.

4.5.7 Test Results (Mode 1)

Frequency Stability Versus Temp.									
Operating Frequency: 5240MHz									
Temp. (°C)	Power Supply (Vac)	0 Minute		2 Minute		5 Minute		10 Minute	
		Measured Frequency (MHz)	Frequency Drift (%)	Measured Frequency (MHz)	Frequency Drift (%)	Measured Frequency (MHz)	Frequency Drift (%)	Measured Frequency (MHz)	Frequency Drift (%)
50	120	5239.989	-0.00021	5239.9879	-0.00023	5239.9867	-0.00025	5239.986	-0.00027
40	120	5240.0215	0.00041	5240.0199	0.00038	5240.0213	0.00041	5240.0217	0.00041
30	120	5239.9915	-0.00016	5239.9907	-0.00018	5239.9883	-0.00022	5239.99	-0.00019
20	120	5239.9919	-0.00015	5239.9919	-0.00015	5239.992	-0.00015	5239.9886	-0.00022
10	120	5240.0112	0.00021	5240.01	0.00019	5240.0069	0.00013	5240.0085	0.00016
0	120	5240.0122	0.00023	5240.0134	0.00026	5240.0137	0.00026	5240.0164	0.00031
-10	120	5240.0027	0.00005	5240.0042	0.00008	5240.0024	0.00005	5240.0007	0.00001
-20	120	5240.0081	0.00015	5240.0099	0.00019	5240.0082	0.00016	5240.01	0.00019
-30	120	5240.0243	0.00046	5240.0242	0.00046	5240.023	0.00044	5240.0245	0.00047

Frequency Stability Versus Temp.									
Operating Frequency: 5240MHz									
Temp. (°C)	Power Supply (Vac)	0 Minute		2 Minute		5 Minute		10 Minute	
		Measured Frequency (MHz)	Frequency Drift (%)	Measured Frequency (MHz)	Frequency Drift (%)	Measured Frequency (MHz)	Frequency Drift (%)	Measured Frequency (MHz)	Frequency Drift (%)
20	138	5239.9911	-0.00017	5239.9928	-0.00014	5239.9925	-0.00014	5239.9878	-0.00023
	120	5239.9919	-0.00015	5239.9919	-0.00015	5239.992	-0.00015	5239.9886	-0.00022
	102	5239.9924	-0.00015	5239.9909	-0.00017	5239.9923	-0.00015	5239.9894	-0.00020

4.5.8 Test Results (Mode 2)

Frequency Stability Versus Temp.									
Operating Frequency: 5240MHz									
Temp. (°C)	Power Supply (Vac)	0 Minute		2 Minute		5 Minute		10 Minute	
		Measured Frequency (MHz)	Frequency Drift (%)	Measured Frequency (MHz)	Frequency Drift (%)	Measured Frequency (MHz)	Frequency Drift (%)	Measured Frequency (MHz)	Frequency Drift (%)
50	120	5239.977	-0.00044	5239.9742	-0.00049	5239.9746	-0.00048	5239.9746	-0.00048
40	120	5239.9996	-0.00001	5240.0002	0.00000	5240.0007	0.00001	5239.9975	-0.00005
30	120	5239.9932	-0.00013	5239.9917	-0.00016	5239.9957	-0.00008	5239.9917	-0.00016
20	120	5239.9902	-0.00019	5239.9921	-0.00015	5239.9892	-0.00021	5239.9913	-0.00017
10	120	5240.0214	0.00041	5240.0221	0.00042	5240.0201	0.00038	5240.024	0.00046
0	120	5240.009	0.00017	5240.0064	0.00012	5240.0081	0.00015	5240.0055	0.00010
-10	120	5240.0003	0.00001	5240.0002	0.00000	5240.0021	0.00004	5240.0027	0.00005
-20	120	5239.9748	-0.00048	5239.9764	-0.00045	5239.9731	-0.00051	5239.9762	-0.00045
-30	120	5239.9937	-0.00012	5239.9969	-0.00006	5239.9925	-0.00014	5239.9937	-0.00012

Frequency Stability Versus Temp.									
Operating Frequency: 5240MHz									
Temp. (°C)	Power Supply (Vac)	0 Minute		2 Minute		5 Minute		10 Minute	
		Measured Frequency (MHz)	Frequency Drift (%)	Measured Frequency (MHz)	Frequency Drift (%)	Measured Frequency (MHz)	Frequency Drift (%)	Measured Frequency (MHz)	Frequency Drift (%)
20	138	5239.9902	-0.00019	5239.9921	-0.00015	5239.9898	-0.00019	5239.9905	-0.00018
	120	5239.9902	-0.00019	5239.9921	-0.00015	5239.9892	-0.00021	5239.9913	-0.00017
	102	5239.9906	-0.00018	5239.9927	-0.00014	5239.9889	-0.00021	5239.9905	-0.00018

4.6 6dB Bandwidth Measurement

4.6.1 Limits of 6dB Bandwidth Measurement

The minimum of 6dB Bandwidth Measurement is 0.5MHz.

4.6.2 Test Setup

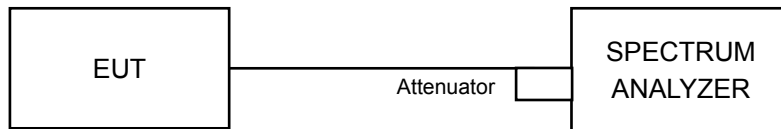

4.6.3 Test Instruments

Refer to section 4.1.2 to get information of above instrument.

4.6.4 Test Procedures

MEASUREMENT PROCEDURE REF

- a. Set resolution bandwidth (RBW) = 100kHz
- b. Set the video bandwidth (VBW) $\geq 3 \times$ RBW, Detector = Peak.
- c. Trace mode = max hold.
- d. Sweep = auto couple.
- e. Measure the maximum width of the emission that is constrained by the frequencies associated with the two amplitude points (upper and lower) that are attenuated by 6 dB relative to the maximum level measured in the fundamental emission

4.6.5 Deviation from Test Standard

No deviation.

4.6.6 EUT Operating Conditions

The software provided by client to enable the EUT under transmission condition continuously at lowest, middle and highest channel frequencies individually.

4.6.7 Test Results (Mode 1)

1TX Mode

802.11a

Channel	Frequency (MHz)	6dB Bandwidth (MHz)	Minimum Limit (MHz)	Pass / Fail
149	5745	16.61	0.5	Pass
157	5785	16.60	0.5	Pass
165	5825	16.59	0.5	Pass

802.11ac (VHT20)

Channel	Frequency (MHz)	6dB Bandwidth (MHz)	Minimum Limit (MHz)	Pass / Fail
149	5745	17.78	0.5	Pass
157	5785	17.77	0.5	Pass
165	5825	17.83	0.5	Pass

802.11ac (VHT40)

Channel	Frequency (MHz)	6dB Bandwidth (MHz)	Minimum Limit (MHz)	Pass / Fail
151	5755	36.61	0.5	Pass
159	5795	36.61	0.5	Pass

802.11ac (VHT80)

Channel	Frequency (MHz)	6dB Bandwidth (MHz)	Minimum Limit (MHz)	Pass / Fail
155	5775	75.99	0.5	Pass

Spectrum Plot of Worst Value

802.11a / CH165

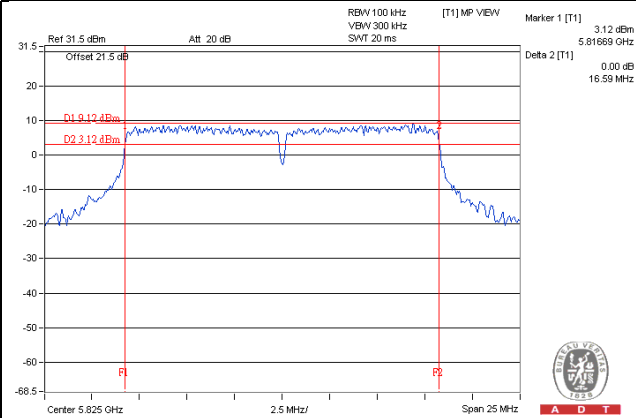

802.11ac (VHT20) / CH157

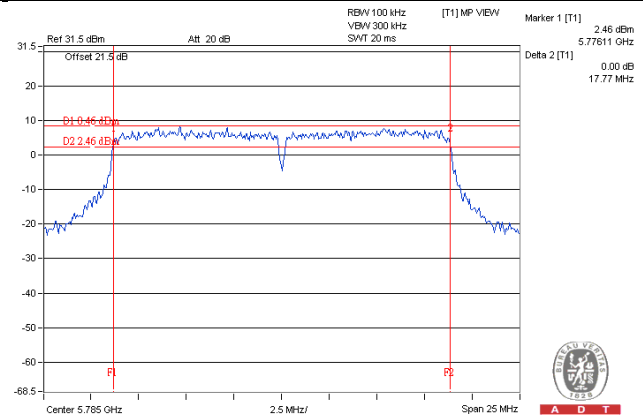

802.11ac (VHT40) / CH151

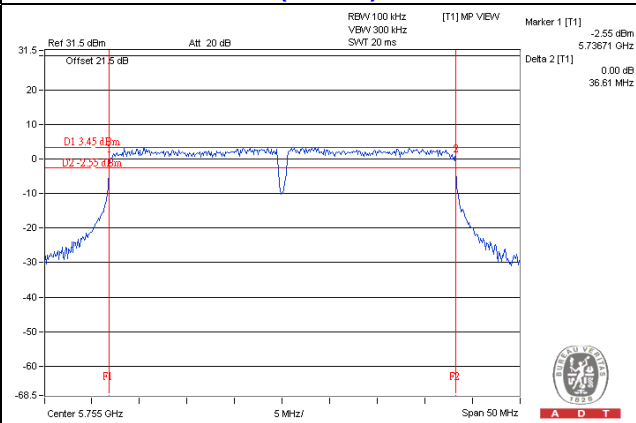

802.11ac (VHT80) / CH155

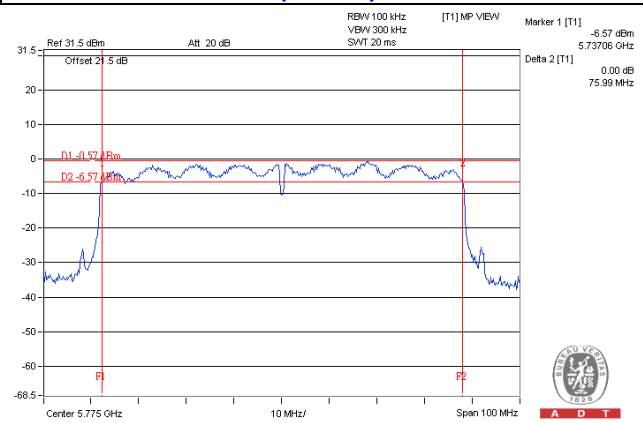

2TX Mode
802.11ac (VHT20)

Channel	Frequency (MHz)	6dB Bandwidth (MHz)		Minimum Limit (MHz)	Pass / Fail
		Chain 0	Chain 1		
149	5745	17.81	17.72	0.5	Pass
157	5785	17.81	17.74	0.5	Pass
165	5825	17.85	17.72	0.5	Pass

802.11ac (VHT40)

Channel	Frequency (MHz)	6dB Bandwidth (MHz)		Minimum Limit (MHz)	Pass / Fail
		Chain 0	Chain 1		
151	5755	36.61	36.53	0.5	Pass
159	5795	36.61	36.50	0.5	Pass

802.11ac (VHT80)

Channel	Frequency (MHz)	6dB Bandwidth (MHz)		Minimum Limit (MHz)	Pass / Fail
		Chain 0	Chain 1		
155	5775	75.82	76.00	0.5	Pass

Spectrum Plot of Worst Value

802.11ac (VHT20)_Chain 1 / CH149

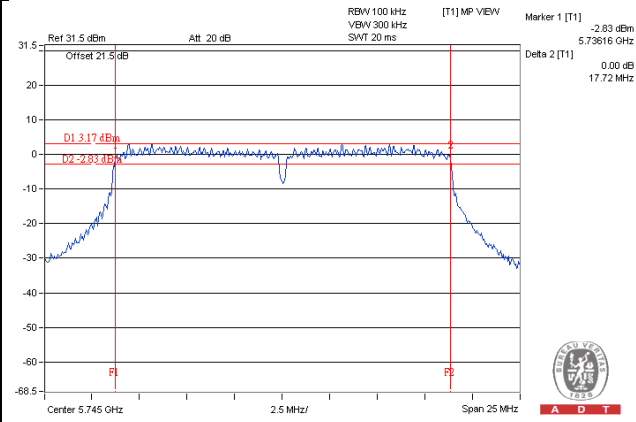

802.11ac (VHT40)_Chain 1 / CH159

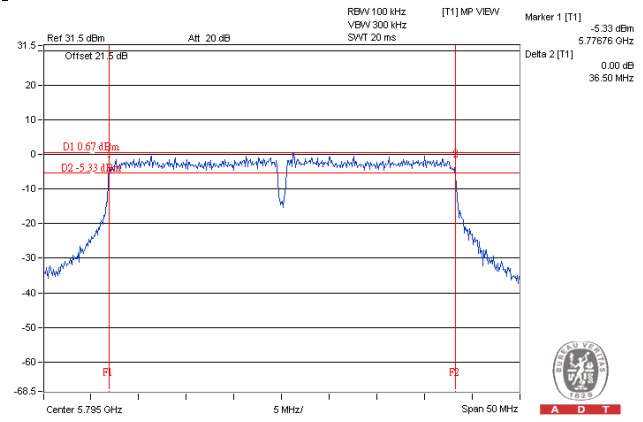

802.11ac (VHT80)_Chain 0 / CH155

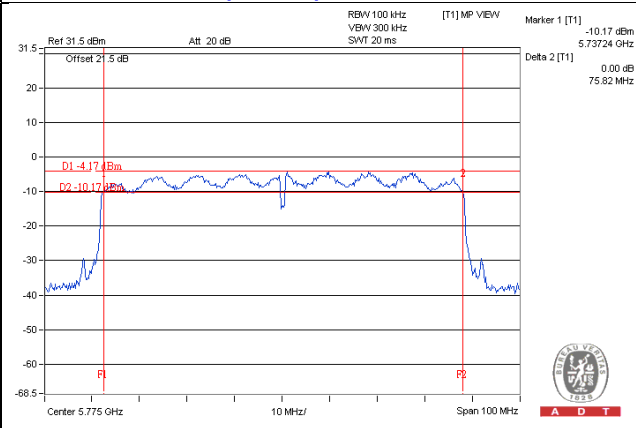

4.6.8 Test Results (Mode 2)

1TX Mode

802.11a

Channel	Frequency (MHz)	6dB Bandwidth (MHz)	Minimum Limit (MHz)	Pass / Fail
149	5745	16.60	0.5	Pass
157	5785	16.62	0.5	Pass
165	5825	16.62	0.5	Pass

802.11ac (VHT20)

Channel	Frequency (MHz)	6dB Bandwidth (MHz)	Minimum Limit (MHz)	Pass / Fail
149	5745	17.78	0.5	Pass
157	5785	17.79	0.5	Pass
165	5825	17.79	0.5	Pass

802.11ac (VHT40)

Channel	Frequency (MHz)	6dB Bandwidth (MHz)	Minimum Limit (MHz)	Pass / Fail
151	5755	36.61	0.5	Pass
159	5795	36.60	0.5	Pass

802.11ac (VHT80)

Channel	Frequency (MHz)	6dB Bandwidth (MHz)	Minimum Limit (MHz)	Pass / Fail
155	5775	76.67	0.5	Pass

Spectrum Plot of Worst Value

802.11a / CH149

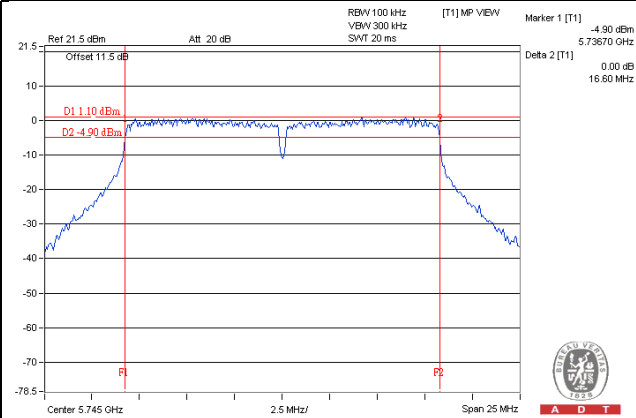

802.11ac (VHT20) / CH149

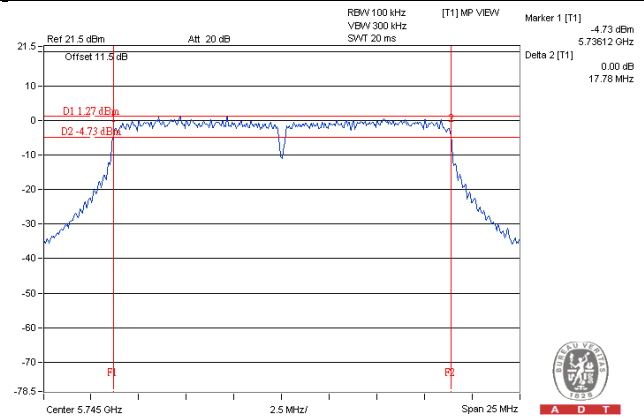

802.11ac (VHT40) / CH159

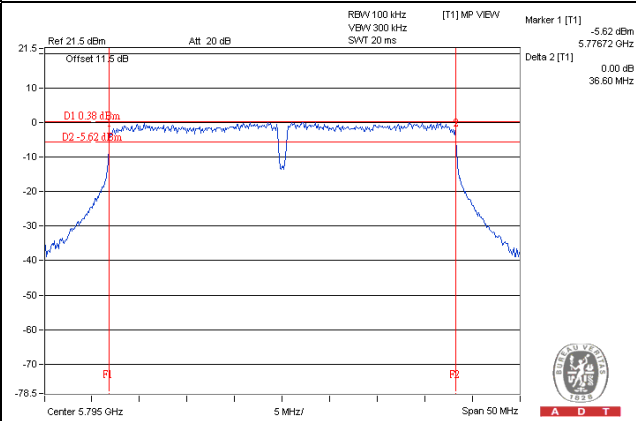

802.11ac (VHT80) / CH155

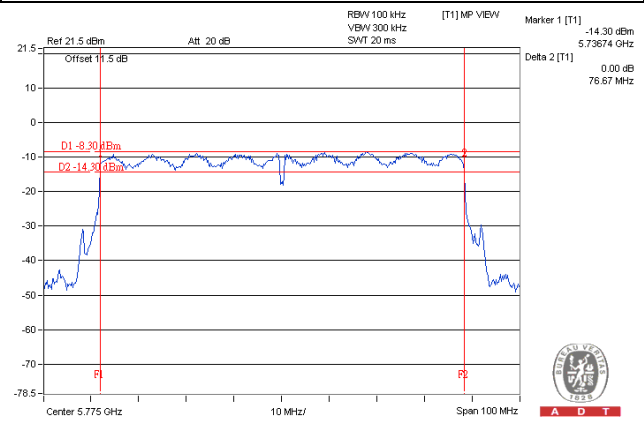

2TX Mode
802.11ac (VHT20)

Channel	Frequency (MHz)	6dB Bandwidth (MHz)		Minimum Limit (MHz)	Pass / Fail
		Chain 0	Chain 1		
149	5745	17.78	17.75	0.5	Pass
157	5785	17.80	17.70	0.5	Pass
165	5825	17.79	17.72	0.5	Pass

802.11ac (VHT40)

Channel	Frequency (MHz)	6dB Bandwidth (MHz)		Minimum Limit (MHz)	Pass / Fail
		Chain 0	Chain 1		
151	5755	36.63	36.52	0.5	Pass
159	5795	36.65	36.54	0.5	Pass

802.11ac (VHT80)

Channel	Frequency (MHz)	6dB Bandwidth (MHz)		Minimum Limit (MHz)	Pass / Fail
		Chain 0	Chain 1		
155	5775	76.65	76.67	0.5	Pass

Spectrum Plot of Worst Value

802.11ac (VHT20)_Chain 1 / CH157

802.11ac (VHT40)_Chain 1 / CH151

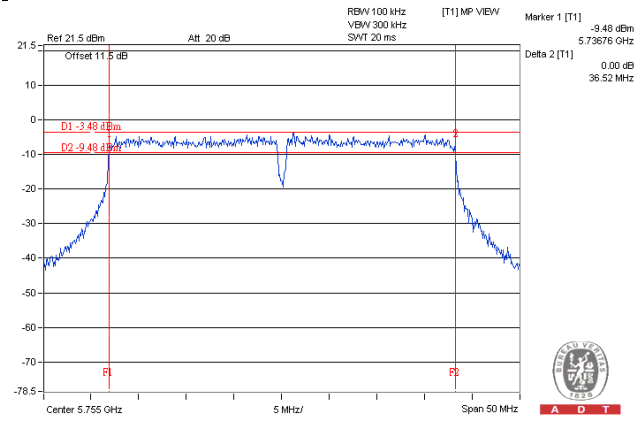
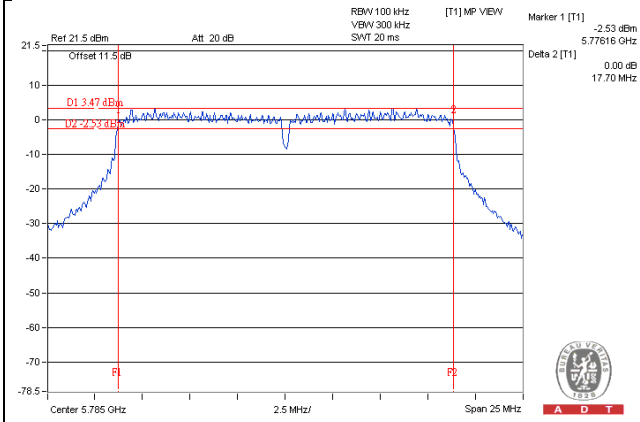

802.11ac (VHT80)_Chain 0 / CH155

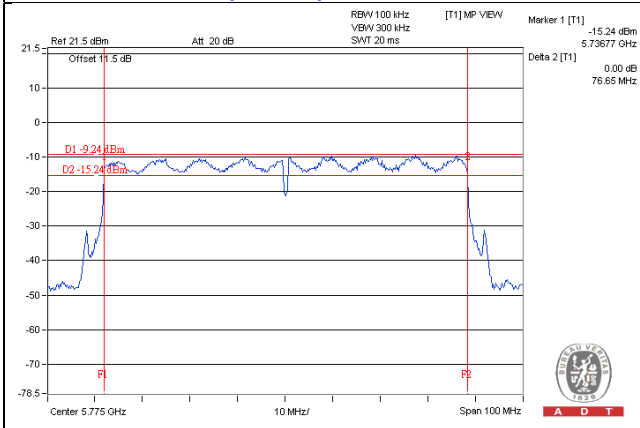



5 Pictures of Test Arrangements

Please refer to the attached file (Test Setup Photo).



Appendix – Information on the Testing Laboratories

We, Bureau Veritas Consumer Products Services (H.K.) Ltd., Taoyuan Branch, were founded in 1988 to provide our best service in EMC, Radio, Telecom and Safety consultation. Our laboratories are accredited and approved according to ISO/IEC 17025.

If you have any comments, please feel free to contact us at the following:

Linko EMC/RF Lab

Tel: 886-2-26052180

Fax: 886-2-26051924

Hsin Chu EMC/RF/Telecom Lab

Tel: 886-3-5935343

Fax: 886-3-5935342

Hwa Ya EMC/RF/Safety Lab

Tel: 886-3-3183232

Fax: 886-3-3270892

Email: service.adt@tw.bureauveritas.com

Web Site: www.bureauveritas-adt.com

The address and road map of all our labs can be found in our web site also.

--- END ---