



# FCC TEST REPORT

**REPORT NO.:** RF920212H05B

**MODEL NO.:** 3CRWE870075A

**RECEIVED:** Feb. 25, 2003

**TESTED:** Feb. 25 to Mar. 21, 2003

**APPLICANT:** Accton Technology Corporation

**ADDRESS:** No.1, Creation Rd. III, Science-based Industrial Park, Hsinchu, Taiwan, R.O.C

**ISSUED BY:** Advance Data Technology Corporation

**LAB LOCATION:** No. 81-1, Lu Liao Keng, 9 Ling, Wu Lung Tsuen, Chiung Lin Hsiang, Hsin Chu Hsien, Taiwan, R.O.C.

This test report consists of 140 pages in total. It may be duplicated completely for legal use with the approval of the applicant. It should not be reproduced except in full, without the written approval of our laboratory. The client should not use it to claim product endorsement by CNLA, NVLAP or any government agencies. The test results in the report only apply to the tested sample.



Lab Code: 200376-0



## Table of Contents

1.	CERTIFICATION.....	5
2.	SUMMARY OF TEST RESULTS .....	6
3.	GENERAL INFORMATION .....	8
3.1	GENERAL DESCRIPTION OF EUT.....	8
3.2	DESCRIPTION OF TEST MODES .....	9
3.3	GENERAL DESCRIPTION OF APPLIED STANDARDS .....	10
3.4	DESCRIPTION OF SUPPORT UNITS .....	11
4.	TEST TYPES AND RESULTS (FOR PART 802.11B).....	13
4.1	CONDUCTED EMISSION MEASUREMENT .....	13
4.1.1	LIMITS OF CONDUCTED EMISSION MEASUREMENT .....	13
4.1.2	TEST INSTRUMENTS .....	13
4.1.3	TEST PROCEDURES .....	14
4.1.4	DEVIATION FROM TEST STANDARD .....	14
4.1.5	TEST SETUP .....	15
4.1.6	EUT OPERATING CONDITIONS .....	15
4.1.7	TEST RESULTS .....	16
4.2	RADIATED EMISSION MEASUREMENT.....	22
4.2.1	LIMITS OF RADIATED EMISSION MEASUREMENT.....	22
4.2.2	TEST INSTRUMENTS .....	23
4.2.3	TEST PROCEDURES.....	24
4.2.4	DEVIATION FROM TEST STANDARD .....	24
4.2.5	TEST SETUP .....	25
4.2.6	EUT OPERATING CONDITIONS .....	25
4.2.7	TEST RESULTS .....	26
4.3	6dB BANDWIDTH MEASUREMENT.....	30
4.3.1	LIMITS OF 6dB BANDWIDTH MEASUREMENT.....	30
4.3.2	TEST INSTRUMENTS .....	30
4.3.3	TEST PROCEDURE .....	31
4.3.4	DEVIATION FROM TEST STANDARD .....	31
4.3.5	TEST SETUP .....	31
4.3.6	EUT OPERATING CONDITIONS .....	31
4.3.7	TEST RESULTS .....	32
4.4	MAXIMUM PEAK OUTPUT POWER.....	36
4.4.1	LIMITS OF MAXIMUM PEAK OUTPUT POWER MEASUREMENT.....	36
4.4.2	INSTRUMENTS .....	36
4.4.3	TEST PROCEDURES.....	37
4.4.4	DEVIATION FROM TEST STANDARD .....	37
4.4.5	TEST SETUP .....	37
4.4.6	EUT OPERATING CONDITIONS .....	37



4.4.7	TEST RESULTS .....	38
4.5	POWER SPECTRAL DENSITY MEASUREMENT.....	39
4.5.1	LIMITS OF POWER SPECTRAL DENSITY MEASUREMENT .....	39
4.5.2	TEST INSTRUMENTS .....	39
4.5.3	TEST PROCEDURE .....	40
4.5.4	DEVIATION FROM TEST STANDARD .....	40
4.5.5	TEST SETUP .....	40
4.5.6	EUT OPERATING CONDITION .....	40
4.5.7	TEST RESULTS .....	41
4.6	BAND EDGES MEASUREMENT.....	45
4.6.1	LIMITS OF BAND EDGES MEASUREMENT.....	45
4.6.2	TEST INSTRUMENTS .....	45
4.6.3	TEST PROCEDURE .....	45
4.6.4	DEVIATION FROM TEST STANDARD .....	45
4.6.5	EUT OPERATING CONDITION .....	46
4.6.6	TEST RESULTS .....	46
4.7	ANTENNA REQUIREMENT.....	49
4.7.1	STANDARD APPLICABLE .....	49
4.7.2	ANTENNA CONNECTED CONSTRUCTION .....	49
5.	TEST TYPES AND RESULTS (FOR PART 802.11A).....	50
5.1	CONDUCTED EMISSION MEASUREMENT .....	50
5.1.1	LIMITS OF CONDUCTED EMISSION MEASUREMENT .....	50
5.1.2	TEST INSTRUMENTS .....	50
5.1.3	TEST PROCEDURES.....	51
5.1.4	DEVIATION FROM TEST STANDARD .....	51
5.1.5	TEST SETUP .....	52
5.1.6	EUT OPERATING CONDITIONS .....	52
5.1.7	TEST RESULTS .....	53
5.2	RADIATED EMISSION MEASUREMENT.....	55
5.2.1	LIMITS OF RADIATED EMISSION MEASUREMENT.....	55
5.2.2	LIMITS OF UNWANTED EMISSION OUT OF THE RESTRICTED BANDS.....	56
5.2.3	TEST INSTRUMENTS .....	57
5.2.4	TEST PROCEDURES.....	58
5.2.5	DEVIATION FROM TEST STANDARD .....	58
5.2.6	TEST SETUP .....	59
5.2.7	EUT OPERATING CONDITIONS .....	59
5.2.8	TEST RESULTS .....	60
5.3	PEAK TRANSMIT POWER MEASUREMENT.....	72
5.3.1	LIMITS OF PEAK TRANSMIT POWER MEASUREMENT .....	72
5.3.2	TEST INSTRUMENTS .....	72
5.3.3	TEST PROCEDURE .....	73
5.3.4	DEVIATION FROM TEST STANDARD .....	73
5.3.5	TEST SETUP .....	73



5.3.6 EUT OPERATING CONDITIONS ..... 73

5.3.7 TEST RESULTS ..... 74

5.4 PEAK POWER EXCURSION MEASUREMENT..... 98

5.4.1 LIMITS OF PEAK POWER EXCURSION MEASUREMENT..... 98

5.4.2 TEST INSTRUMENTS ..... 98

5.4.3 TEST PROCEDURE ..... 99

5.4.4 DEVIATION FROM TEST STANDARD ..... 99

5.4.5 TEST SETUP ..... 99

5.4.6 EUT OPERATING CONDITIONS ..... 99

5.4.7 TEST RESULTS ..... 100

5.5 PEAK POWER SPECTRAL DENSITY MEASUREMENT..... 113

5.5.1 LIMITS OF PEAK POWER SPECTRAL DENSITY MEASUREMENT..... 113

5.5.2 TEST INSTRUMENTS ..... 113

5.5.3 TEST PROCEDURES..... 114

5.5.4 DEVIATION FROM TEST STANDARD ..... 114

5.5.5 TEST SETUP ..... 114

5.5.6 EUT OPERATING CONDITIONS ..... 114

5.5.7 TEST RESULTS ..... 115

5.6 FREQUENCY STABILITY..... 128

5.6.1 LIMITS OF FREQUENCY STABILITY MEASUREMENT..... 128

5.6.2 TEST INSTRUMENTS ..... 128

5.6.3 TEST PROCEDURE ..... 128

5.6.4 DEVIATION FROM TEST STANDARD ..... 129

5.6.5 TEST SETUP ..... 129

5.6.6 EUT OPERATING CONDITION ..... 129

5.6.7 TEST RESULTS ..... 130

5.7 BAND EDGES MEASUREMENT..... 131

5.7.1 TEST INSTRUMENTS ..... 131

5.7.2 TEST PROCEDURE ..... 131

5.7.3 EUT OPERATING CONDITION ..... 131

5.7.4 TEST RESULTS ..... 132

5.8 ANTENNA REQUIREMENT..... 137

5.8.1 STANDARD APPLICABLE ..... 137

5.8.2 ANTENNA CONNECTED CONSTRUCTION ..... 137

6. PHOTOGRAPHS OF THE TEST CONFIGURATION..... 138

7. INFORMATION ON THE TESTING LABORATORIES..... 140



## 1. CERTIFICATION

**PRODUCT :** Wireless LAN Access Point 8700  
**BRAND NAME :** 3Com  
**MODEL NO. :** 3CRWE870075A  
**APPLICANT :** Accton Technology Corporation  
**STANDARDS :** 47 CFR Part 15, Subpart C (Section 15.247),  
Subpart E (Section 15.407), ANSI C63.4-1992

We, **Advance Data Technology Corporation**, hereby certify that one sample of the designation has been tested in our facility from Feb. 25 to Mar. 21, 2003. The test record data evaluation and Equipment under Test (EUT) configurations represented herein are true and accurate accounts of the measurements of the sample's EMC characteristics under the conditions herein specified.

**CHECKED BY:** Amanda Chu, **DATE:** Apr. 15, 2003  
( Amanda Chu )

**APPROVED BY:** Eric Lin, **DATE:** Apr. 15, 2003  
( Eric Lin, Manager )



## 2. SUMMARY OF TEST RESULTS

The EUT has been tested according to the following specifications:

<b>APPLIED STANDARD: 47 CFR Part 15, Subpart C</b>			
<b>Standard Section</b>	<b>Test Type and Limit</b>	<b>Result</b>	<b>REMARK</b>
15.207	AC Power Conducted Emission	PASS	Meet the requirement of limit Minimum passing margin is -18.29dBuV at 1.240MHz
15.247(a)(2)	Spectrum Bandwidth of a Direct Sequence Spread Spectrum System Limit: min. 500kHz	PASS	Meet the requirement of limit
15.247(b)	Maximum Peak Output Power Limit: max. 30dBm	PASS	Meet the requirement of limit
15.247(c)	Radiated Emissions Limit: Table 15.209	PASS	Meet the requirement of limit Minimum passing margin is -4.2dBuV at 143.25MHz
15.247(d)	Power Spectral Density Limit: max. 8dBm	PASS	Meet the requirement of limit
15.247(c)	Band Edge Measurement Limit: 20dB less than the peak value of fundamental frequency	PASS	Meet the requirement of limit



<b>APPLIED STANDARD: 47 CFR Part 15, Subpart E</b>			
<b>Standard Section</b>	<b>Test Type</b>	<b>Result</b>	<b>REMARK</b>
15.407(b)(5)	AC Power Conducted Emission	PASS	Meet the requirement of limit Minimum passing margin is -12.25dBuV at 1.240MHz
15.407(b/1/2/3) (b)(5)	Electric Field Strength Spurious Emissions, 30 MHz – 40000 MHz	PASS	Meet the requirement of limit Minimum passing margin is -0.6dBuV at 5715.00MHz & 5725.00MHz
15.407(a/1/2/3)	Peak Transmit Power	PASS	Meet the requirement of limit
15.407(a)(6)	Peak Power Excursion	PASS	Meet the requirement of limit
15.407(a/1/2/3)	Peak Power Spectral Density	PASS	Meet the requirement of limit
15.407(g)	Frequency Stability	PASS	Meet the requirement of limit



### 3. GENERAL INFORMATION

#### 3.1 GENERAL DESCRIPTION OF EUT

<b>PRODUCT</b>	Wireless LAN Access Point 8700
<b>MODEL NO.</b>	3CRWE870075A
<b>POWER SUPPLY</b>	48.0VDC from POE (Power Over Ethernet)
<b>MODULATION</b>	802.11b: DSSS 802.11a: OFDM
<b>TRANSFER RATE</b>	802.11b: 1 / 2 / 5.5 / 11Mbps 802.11a: 6 to 54Mbps *(Turbo mode : up to 108Mbps)
<b>FREQUENCY RANGE</b>	802.11b: 2412MHz ~ 2462MHz 802.11a: 5.15GHz ~ 5.35GHz, 5.725GHz ~ 5.825GHz
<b>NUMBER OF CHANNEL</b>	802.11b: 11 802.11a: 12 for Normal mode / 5 for Turbo mode
<b>CHANNEL SPACING</b>	802.11b: 5MHz 802.11a: 20MHz for Normal mode / 40MHz for Turbo mode
<b>OUTPUT POWER</b>	802.11b: 14.90dBm 802.11a: 19.77dBm
<b>DATA CABLE</b>	NA
<b>ANTENNA TYPE</b>	Detachable Antenna
<b>I/O PORTS</b>	Console port x 1, RJ 45 port x 1
<b>ASSOCIATED DEVICES</b>	NA

**NOTE:**

- The EUT was powered by the following POE (Power Over Ethernet):

<b>Brand:</b>	3Com
<b>Model No.:</b>	PW130
<b>Input power :</b>	AC100-250V, 0.5A, 50/60Hz
<b>Output power :</b>	DC 48V, 0.42A

- The EUT operates in both the 5GHz and 2.4GHz Bands and compatibility with 802.11a and 802.11b technology.
- For more detailed features description, please refer to the manufacturer's specifications or User's Manual.





### 3.2 DESCRIPTION OF TEST MODES

For 802.11b: Eleven channels are provided to this EUT.

Channel	Frequency	Channel	Frequency
1	2412 MHz	7	2442 MHz
2	2417 MHz	8	2447 MHz
3	2422 MHz	9	2452 MHz
4	2427 MHz	10	2457 MHz
5	2432 MHz	11	2462 MHz
6	2437 MHz		

**NOTE:**

1. Below 1 GHz, the channel 1, 6, and 11 were pre-tested in chamber. The channel 11, worst case one, was chosen for final test.
2. Above 1 GHz, the channel 1, 6, and 11 were tested individually.

For 802.11a: Twelve channels are provided to this EUT for Normal mode.

Channel	Frequency	Channel	Frequency
1	5180 MHz	7	5300 MHz
2	5200 MHz	8	5320 MHz
3	5220 MHz	9	5745MHz
4	5240 MHz	10	5765MHz
5	5260 MHz	11	5785MHz
6	5280 MHz	12	5805MHz

Five channels are provided to this EUT for Turbo Mode.

Channel	Frequency	Channel	Frequency
1	5210 MHz	4	5760MHz
2	5250 MHz	5	5800MHz
3	5290 MHz		

**NOTE:**

1. The EUT was transmitting at full power on the specified channel with a duty cycle of 99% (maximum allowed). The EUT was tested in both normal mode (channel bandwidth of approximately 30MHz) and turbo mode (channel bandwidth of approximately 60MHz).
2. "Normal Mode" allows data rates of up to 54Mbps. The device was, therefore, tested in Normal mode at the data rate that produced the highest output power for normal mode (6Mbps).
3. "Turbo Mode" allows data rates of up to 108Mbps. At data rates higher than 12Mbps the PA gain is reduced to improve signal fidelity. The device was, therefore, tested in turbo mode at the data rate that produced the highest output power for turbo mode (12Mbps).
4. Channel 1, 4, 5, 8, 9 and 12 are the closest frequencies to the band edge, were chosen for final test of Normal Mode.
5. Channel 1 ~ 5 were chosen for final test of turbo mode.
6. The EUT was pre-scanned under vertical and horizontal mode. The worst radiated emission was found in horizontal mode. The horizontal mode, worst case one, was chosen for final test.



### **3.3 GENERAL DESCRIPTION OF APPLIED STANDARDS**

The EUT is a Wireless LAN Access Point 8700 According to the specifications of the manufacturer, it must comply with the requirements of the following standards:

**FCC 47CFR Part 15, Subpart C. (15.247),  
Subpart E (15.407). ANSI C63.4 : 1992**

All tests have been performed and recorded as per the above standards.

**NOTE:** The EUT is also considered as a kind of computer peripheral, because the connection to computer is necessary for typical use. It has been verified to comply with the requirements of FCC Part 15, Subpart B, Class B (DoC). The test report has been issued separately.



### 3.4 DESCRIPTION OF SUPPORT UNITS

The EUT has been tested as an independent unit together with other necessary accessories or support units. The following support units or accessories were used to form a representative test configuration during the tests.

No.	Product	Brand	Model No.	Serial No.	FCC ID
1	PERSONAL COMPUTER	HP	DTPC 27	SG21103567	FCC DoC
2	MONITOR	ADi	VD-695	023050L10301767	NA
3	KEYBOARD	FORWARD	FDA-104GA	FDKB8110045	F4ZDA-104G
4	MOUSE	Genuine	828 U+P	66820011002702	FCC DoC

No.	Signal cable description
1	NA
2	1.4 m braid shielded wire, terminated with VGA connector via metallic frame, w/o core.
3	1.8 m foil shielded wire, terminal by frame, PS2 Connector, w/o Core.
4	1.4 m foil shielded wire, terminal by frame, PS2 Connector, w/o Core.

Note: 1. All power cords of the above support units are unshielded (1.8m).

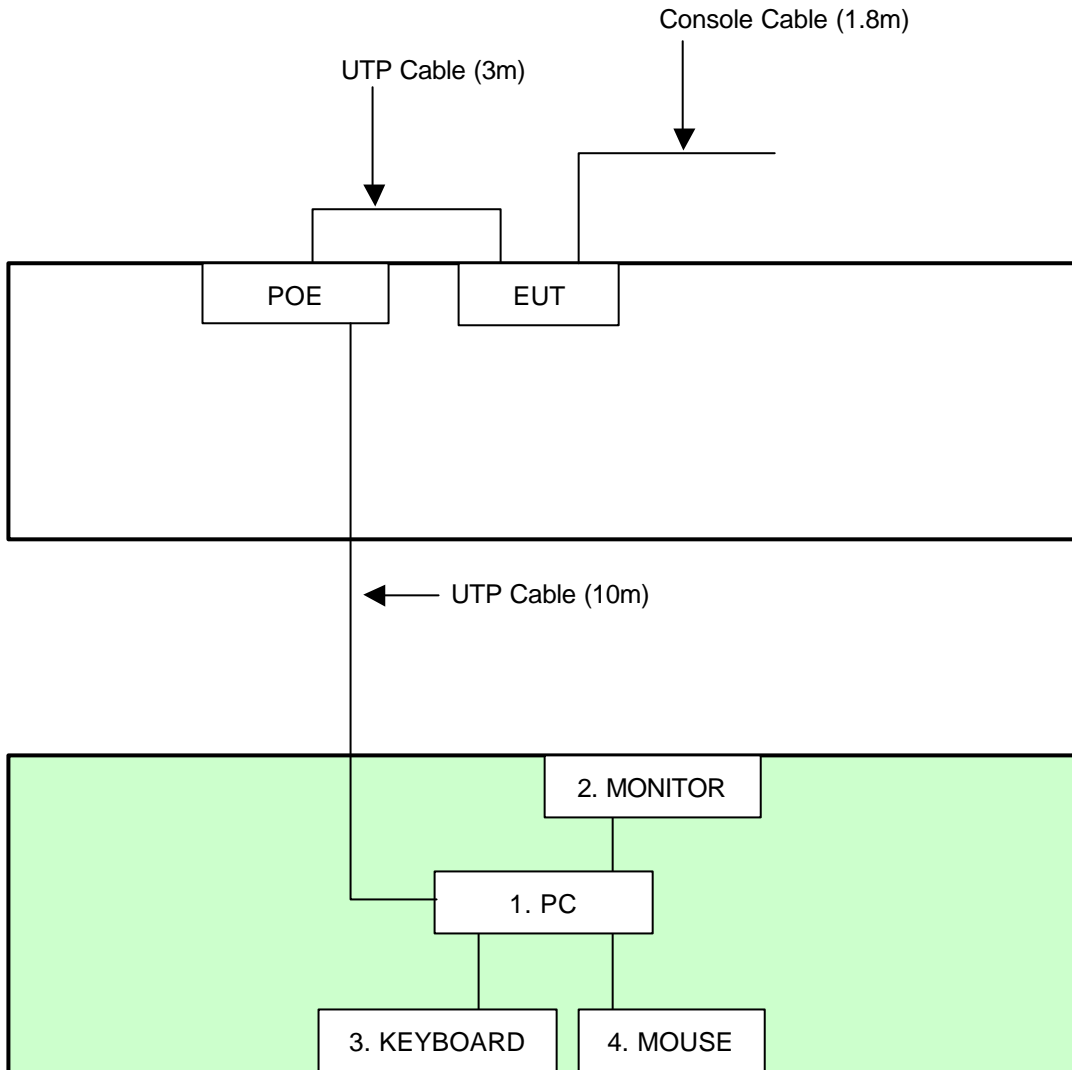

**NOTE:** 1. Support units 1-4 were kept in the control room during the test.  
2. Please refer to the photos of test configuration in Item 5 also.



## 4. TEST TYPES AND RESULTS (FOR PART 802.11b)

### 4.1 CONDUCTED EMISSION MEASUREMENT

#### 4.1.1 LIMITS OF CONDUCTED EMISSION MEASUREMENT

FREQUENCY OF EMISSION (MHz)	CONDUCTED LIMIT (dB $\mu$ V)	
	Quasi-peak	Average
0.15-0.5	66 to 56	56 to 46
0.5-5	56	46
5-30	60	50

- NOTE:**
1. The lower limit shall apply at the transition frequencies.
  2. The limit decreases in line with the logarithm of the frequency in the range of 0.15 to 0.50 MHz.
  3. All emanations from a class A/B digital device or system, including any network of conductors and apparatus connected thereto, shall not exceed the level of field strengths specified above.

#### 4.1.2 TEST INSTRUMENTS

DESCRIPTION & MANUFACTURER	MODEL NO.	SERIAL NO.	CALIBRATED UNTIL
ROHDE & SCHWARZ Test Receiver	ESCS 30	847124/029	Nov. 17, 2003
ROHDE & SCHWARZ LISN (for EUT)	ESHS-Z5	848773/004	Nov. 13, 2003
KYORITSU LISN (for peripheral)	KNW-407	8/1395/12	Jul. 23, 2003
RF Cable (JETBAO)	RG233/U	Cable_CA_01	Jul. 03, 2003
Terminator(for KYORITSU)	50	3	Apr. 11, 2004
Software	Cond-V2e	NA	NA

- NOTE:**
1. The calibration interval of the above test instruments is 12 months and the calibrations are traceable to NML/ROC and NIST/USA.
  2. The test was performed in ADT Shielded Room No. A.
  3. The VCCI Con A Registration No. is C-817.



#### 4.1.3 TEST PROCEDURES

- a. The EUT was placed 0.4 meters from the conducting wall of the shielded room with EUT being connected to the power mains through a line impedance stabilization network (LISN). Other support units were connected to the power mains through another LISN. The two LISNs provide 50 ohm/ 50uH of coupling impedance for the measuring instrument.
- b. Both lines of the power mains connected to the EUT were checked for maximum conducted interference.
- c. The frequency range from 150 kHz to 30 MHz was searched. Emission levels over 10dB under the prescribed limits could not be reported

#### 4.1.4 DEVIATION FROM TEST STANDARD

No deviation

#### 4.1.5 TEST SETUP

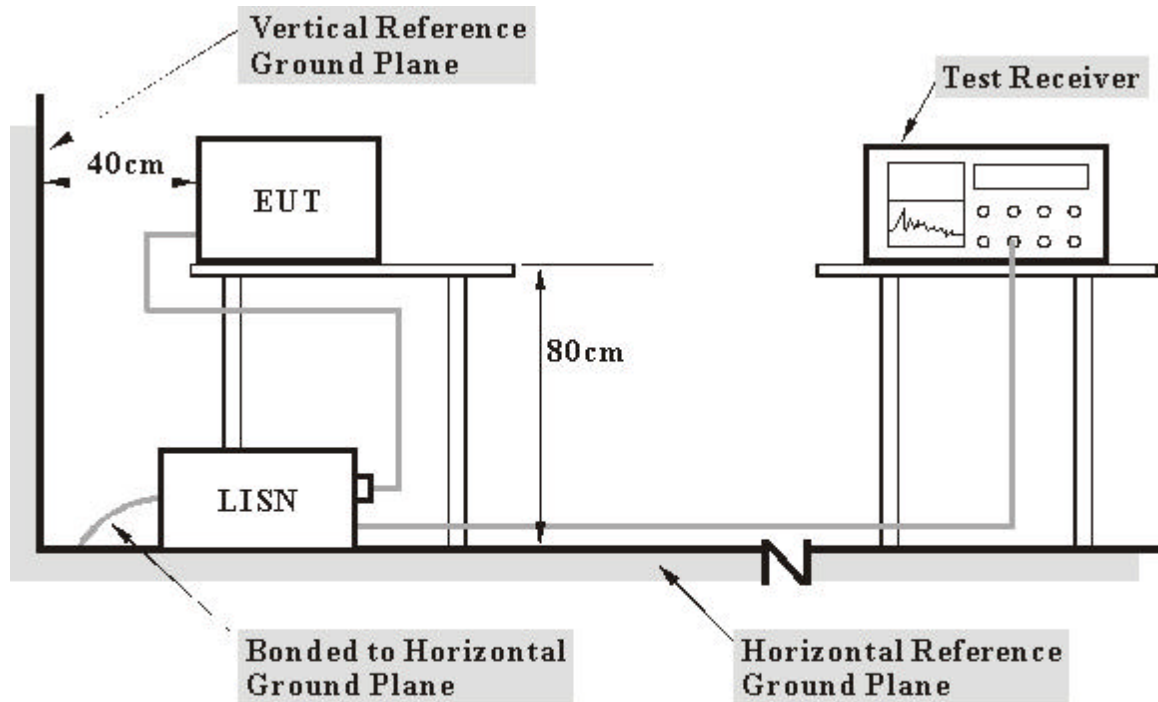

- Note:**
1. Support units were connected to second LISN.
  2. Both of LISNs (AMN) 80 cm from EUT and at the least 80 cm from other units and other metal planes support units.

For the actual test configuration, please refer to the related item – Photographs of the Test Configuration.

#### 4.1.6 EUT OPERATING CONDITIONS

- a. Placed the EUT on the testing table.
- b. Prepared another computer system to act as a communication partner and placed it outside of testing area.
- c. The communication partner run a test program to enable EUT under transmission/receiving condition continuously at specific channel frequency via an RJ 45 cable and wireless.
- d. The communication partner sent data to EUT by command "PING".



4.1.7 TEST RESULTS

<b>EUT</b>	Wireless LAN Access Point 8700	<b>MODEL</b>	3CRWE870075A
<b>MODE</b>	Channel 1	<b>6dB BANDWIDTH</b>	9 kHz
<b>INPUT POWER (SYSTEM)</b>	120Vac, 60Hz	<b>PHASE</b>	Line (L)
<b>ENVIRONMENTAL CONDITIONS</b>	21 deg. C, 61%RH, 974 hPa	<b>TESTED BY</b>	Tony Chen

No	Freq. [MHz]	Corr. Factor (dB)	Reading Value [dB (uV)]		Emission Level [dB (uV)]		Limit [dB (uV)]		Margin (dB)	
			Q.P.	AV.	Q.P.	AV.	Q.P.	AV.	Q.P.	AV.
1	0.197	0.10	34.52	-	34.62	-	63.74	53.74	-29.12	-
2	0.396	0.10	35.62	-	35.72	-	57.93	47.93	-22.21	-
3	0.619	0.10	35.50	-	35.60	-	56.00	46.00	-20.40	-
4	1.240	0.10	36.90	-	37.00	-	56.00	46.00	-19.00	-
5	1.548	0.10	35.38	-	35.48	-	56.00	46.00	-20.52	-
6	9.941	0.60	39.02	-	39.62	-	60.00	50.00	-20.38	-

- NOTES: (1) "": Undetectable  
 (2) Q.P. and AV. are abbreviations of quasi-peak and average.  
 (3) "-": The Quasi-peak reading value also meets an average limit, thus measurement with the average detector is unnecessary.  
 (4) The emission levels of other frequencies were very low against the limit.  
 (5) Correction Factor = Insertion loss + Cable loss  
 (6) Margin value = Emission level - Limit value

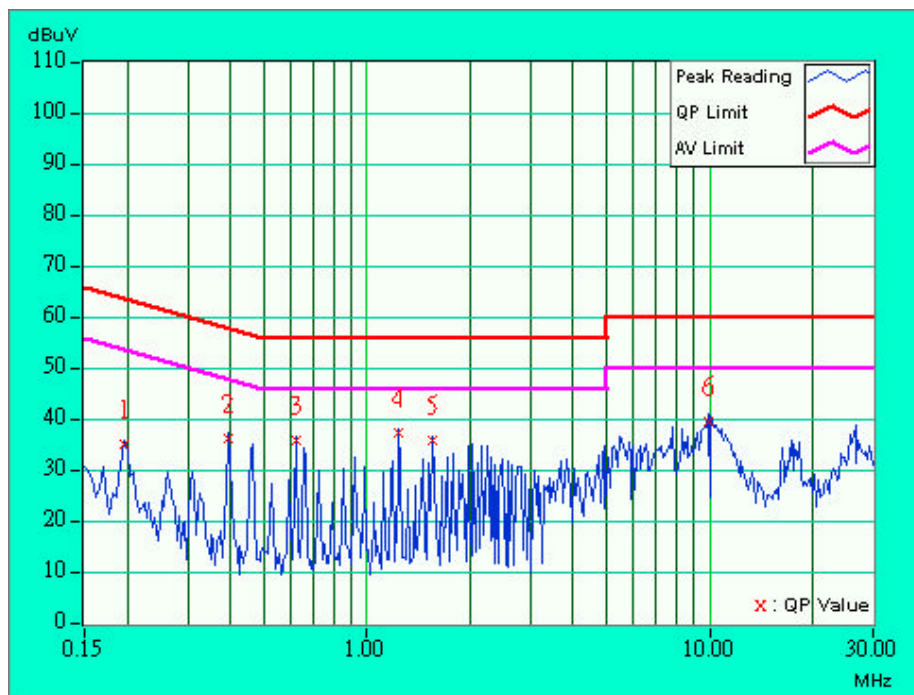





<b>EUT</b>	Wireless LAN Access Point 8700	<b>MODEL</b>	3CRWE870075A
<b>MODE</b>	Channel 1	<b>6dB BANDWIDTH</b>	9 kHz
<b>INPUT POWER (SYSTEM)</b>	120Vac, 60Hz	<b>PHASE</b>	Neutral (N)
<b>ENVIRONMENTAL CONDITIONS</b>	21 deg. C, 61%RH, 974 hPa	<b>TESTED BY</b>	Tony Chen

No	Freq. [MHz]	Corr. Factor (dB)	Reading Value [dB (uV)]		Emission Level [dB (uV)]		Limit [dB (uV)]		Margin (dB)	
			Q.P.	AV.	Q.P.	AV.	Q.P.	AV.	Q.P.	AV.
1	0.197	0.10	36.68	-	36.78	-	63.74	53.74	-26.96	-
2	0.396	0.10	36.50	-	36.60	-	57.93	47.93	-21.33	-
3	0.619	0.10	35.91	-	36.01	-	56.00	46.00	-19.99	-
4	1.240	0.10	37.23	-	37.33	-	56.00	46.00	-18.67	-
5	1.548	0.10	35.68	-	35.78	-	56.00	46.00	-20.22	-
6	9.941	0.50	37.94	-	38.44	-	60.00	50.00	-21.56	-

- NOTES: (1) "\*\*\*": Undetectable  
 (2) Q.P. and AV. are abbreviations of quasi-peak and average.  
 (3) "-": The Quasi-peak reading value also meets an average limit, thus measurement with the average detector is unnecessary.  
 (4) The emission levels of other frequencies were very low against the limit.  
 (5) Correction Factor = Insertion loss + Cable loss  
 (6) Margin value = Emission level - Limit value

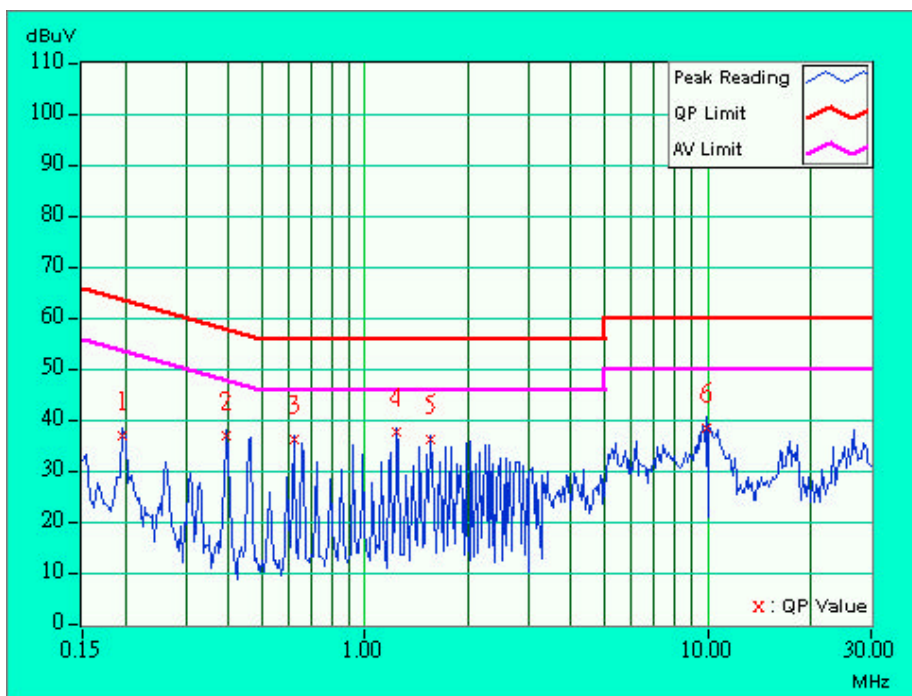



<b>EUT</b>	Wireless LAN Access Point 8700	<b>MODEL</b>	3CRWE870075A
<b>MODE</b>	Channel 6	<b>6dB BANDWIDTH</b>	9 kHz
<b>INPUT POWER (SYSTEM)</b>	120Vac, 60Hz	<b>PHASE</b>	Line (L)
<b>ENVIRONMENTAL CONDITIONS</b>	21 deg. C, 61%RH, 974 hPa	<b>TESTED BY</b>	Tony Chen

No	Freq. [MHz]	Corr. Factor (dB)	Reading Value [dB (uV)]		Emission Level [dB (uV)]		Limit [dB (uV)]		Margin (dB)	
			Q.P.	AV.	Q.P.	AV.	Q.P.	AV.	Q.P.	AV.
1	0.197	0.10	38.07	-	38.17	-	63.74	53.74	-25.57	-
2	0.396	0.10	35.83	-	35.93	-	57.93	47.93	-22.00	-
3	0.619	0.10	36.42	-	36.52	-	56.00	46.00	-19.48	-
4	1.240	0.10	37.31	-	37.41	-	56.00	46.00	-18.59	-
5	1.548	0.10	35.33	-	35.43	-	56.00	46.00	-20.57	-
6	9.750	0.59	37.95	-	38.54	-	60.00	50.00	-21.46	-

- NOTES: (1) "": Undetectable  
 (2) Q.P. and AV. are abbreviations of quasi-peak and average.  
 (3) "-": The Quasi-peak reading value also meets an average limit, thus measurement with the average detector is unnecessary.  
 (4) The emission levels of other frequencies were very low against the limit.  
 (5) Correction Factor = Insertion loss + Cable loss  
 (6) Margin value = Emission level - Limit value

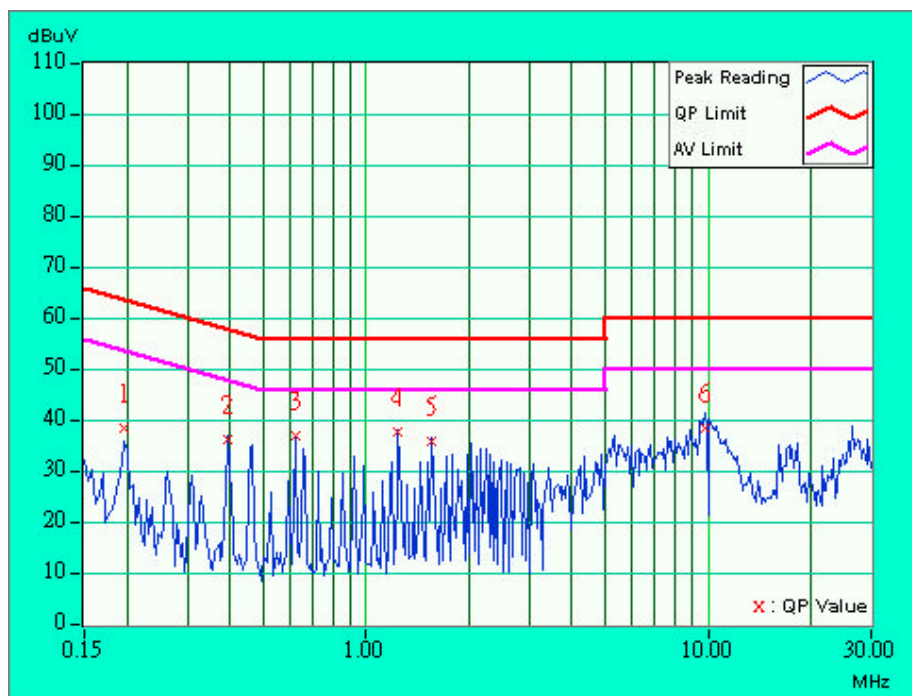



<b>EUT</b>	Wireless LAN Access Point 8700	<b>MODEL</b>	3CRWE870075A
<b>MODE</b>	Channel 6	<b>6dB BANDWIDTH</b>	9 kHz
<b>INPUT POWER (SYSTEM)</b>	120Vac, 60Hz	<b>PHASE</b>	Neutral (N)
<b>ENVIRONMENTAL CONDITIONS</b>	21 deg. C, 61%RH, 974 hPa	<b>TESTED BY</b>	Tony Chen

No	Freq. [MHz]	Corr. Factor (dB)	Reading Value [dB (uV)]		Emission Level [dB (uV)]		Limit [dB (uV)]		Margin (dB)	
			Q.P.	AV.	Q.P.	AV.	Q.P.	AV.	Q.P.	AV.
1	0.197	0.10	36.40	-	36.50	-	63.74	53.74	-27.24	-
2	0.396	0.10	36.52	-	36.62	-	57.93	47.93	-21.31	-
3	0.463	0.10	35.35	-	35.45	-	56.65	46.65	-21.20	-
4	0.619	0.10	36.22	-	36.32	-	56.00	46.00	-19.68	-
<b>5</b>	<b>1.240</b>	<b>0.10</b>	<b>37.61</b>	-	<b>37.71</b>	-	<b>56.00</b>	<b>46.00</b>	<b>-18.29</b>	-
6	26.609	0.90	36.35	-	37.25	-	60.00	50.00	-22.75	-

- NOTES: (1) "\*\*\*": Undetectable  
 (2) Q.P. and AV. are abbreviations of quasi-peak and average.  
 (3) "-": The Quasi-peak reading value also meets an average limit, thus measurement with the average detector is unnecessary.  
 (4) The emission levels of other frequencies were very low against the limit.  
 (5) Correction Factor = Insertion loss + Cable loss  
 (6) Margin value = Emission level - Limit value

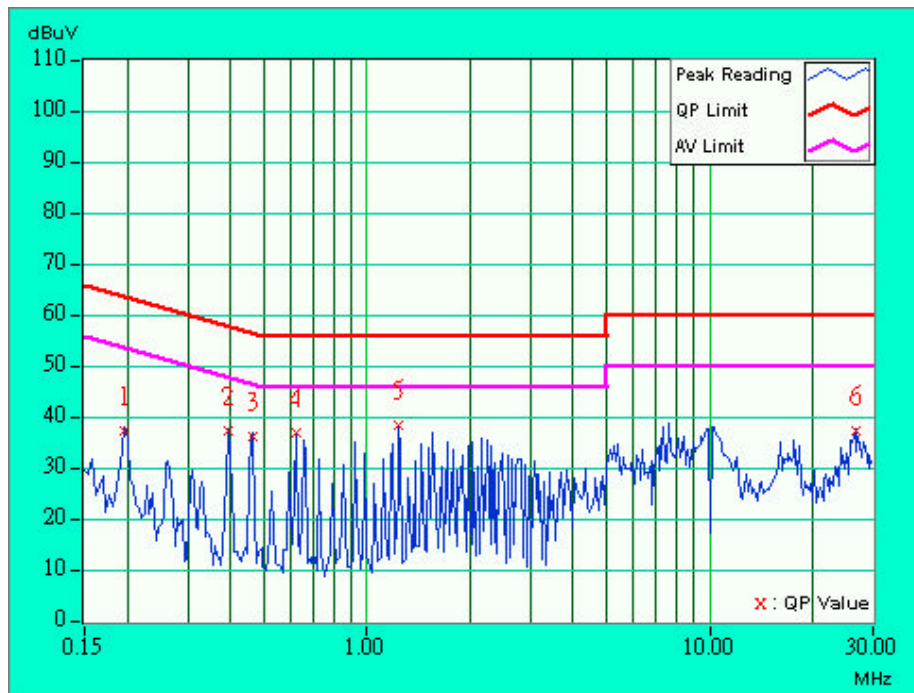



<b>EUT</b>	Wireless LAN Access Point 8700	<b>MODEL</b>	3CRWE870075A
<b>MODE</b>	Channel 11	<b>6dB BANDWIDTH</b>	9 kHz
<b>INPUT POWER (SYSTEM)</b>	120Vac, 60Hz	<b>PHASE</b>	Line (L)
<b>ENVIRONMENTAL CONDITIONS</b>	21 deg. C, 61%RH, 974 hPa	<b>TESTED BY</b>	Tony Chen

No	Freq. [MHz]	Corr. Factor (dB)	Reading Value [dB (uV)]		Emission Level [dB (uV)]		Limit [dB (uV)]		Margin (dB)	
			Q.P.	AV.	Q.P.	AV.	Q.P.	AV.	Q.P.	AV.
1	0.197	0.10	34.09	-	34.19	-	63.74	53.74	-29.55	-
2	0.396	0.10	35.97	-	36.07	-	57.93	47.93	-21.86	-
3	0.619	0.10	36.36	-	36.46	-	56.00	46.00	-19.54	-
4	1.240	0.10	37.30	-	37.40	-	56.00	46.00	-18.60	-
5	5.270	0.34	37.99	-	38.33	-	60.00	50.00	-21.67	-
6	9.750	0.59	36.80	-	37.39	-	60.00	50.00	-22.61	-

- NOTES: (1) "": Undetectable  
 (2) Q.P. and AV. are abbreviations of quasi-peak and average.  
 (3) "-": The Quasi-peak reading value also meets an average limit, thus measurement with the average detector is unnecessary.  
 (4) The emission levels of other frequencies were very low against the limit.  
 (5) Correction Factor = Insertion loss + Cable loss  
 (6) Margin value = Emission level - Limit value

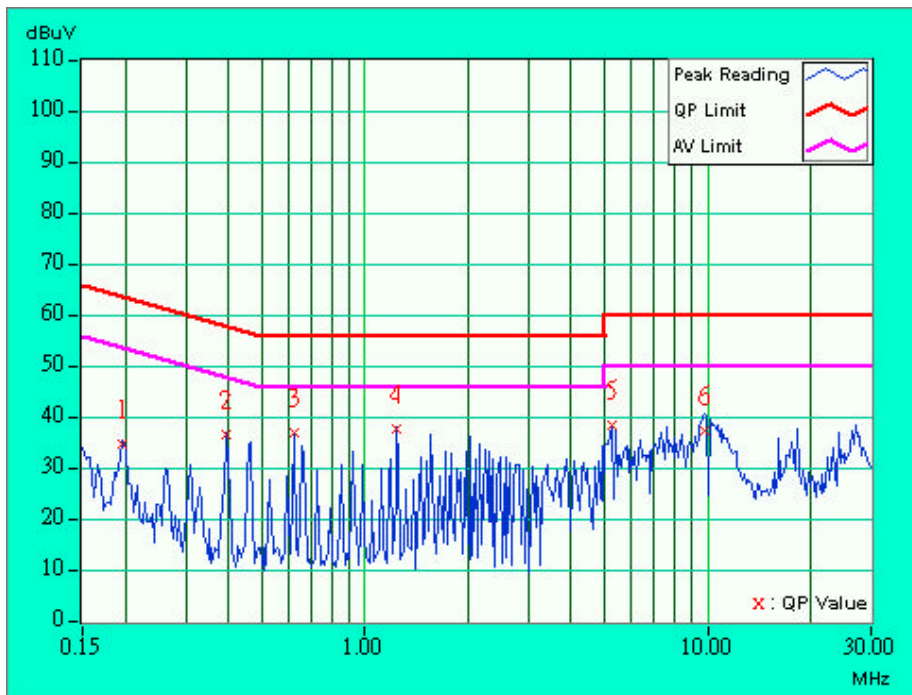



<b>EUT</b>	Wireless LAN Access Point 8700	<b>MODEL</b>	3CRWE87007 5A
<b>MODE</b>	Channel 11	<b>6dB BANDWIDTH</b>	9 kHz
<b>INPUT POWER (SYSTEM)</b>	120Vac, 60Hz	<b>PHASE</b>	Neutral (N)
<b>ENVIRONMENTAL CONDITIONS</b>	21 deg. C, 61%RH, 974 hPa	<b>TESTED BY</b>	Tony Chen

No	Freq. [MHz]	Corr. Factor (dB)	Reading Value [dB (uV)]		Emission Level [dB (uV)]		Limit [dB (uV)]		Margin (dB)	
			Q.P.	AV.	Q.P.	AV.	Q.P.	AV.	Q.P.	AV.
1	0.459	0.10	35.50	-	35.60	-	56.72	46.72	-21.12	-
2	0.658	0.10	35.13	-	35.23	-	56.00	46.00	-20.77	-
3	0.921	0.10	33.07	-	33.17	-	56.00	46.00	-22.83	-
4	1.447	0.10	33.23	-	33.33	-	56.00	46.00	-22.67	-
5	1.783	0.10	32.21	-	32.31	-	56.00	46.00	-23.69	-
6	10.273	0.51	37.49	-	38.00	-	60.00	50.00	-22.00	-

- NOTES: (1) "\*\*\*": Undetectable  
 (2) Q.P. and AV. are abbreviations of quasi-peak and average.  
 (3) "-": The Quasi-peak reading value also meets an average limit, thus measurement with the average detector is unnecessary.  
 (4) The emission levels of other frequencies were very low against the limit.  
 (5) Correction Factor = Insertion loss + Cable loss  
 (6) Margin value = Emission level - Limit value

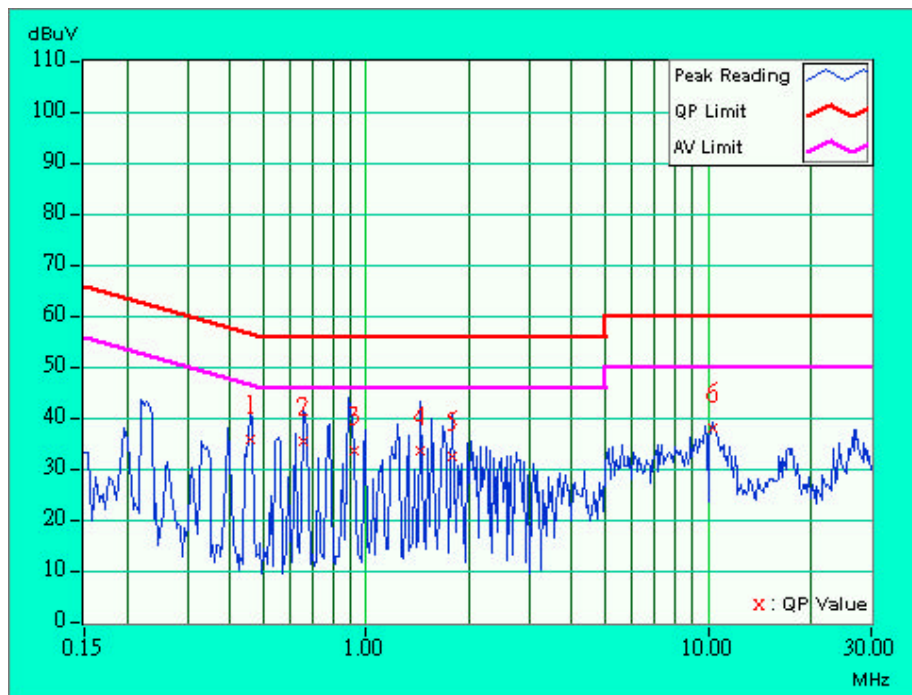



## 4.2 RADIATED EMISSION MEASUREMENT

### 4.2.1 LIMITS OF RADIATED EMISSION MEASUREMENT

Emissions radiated outside of the specified bands, shall be according to the general radiated limits in 15.209 as following:

Frequencies (MHz)	Field strength (microvolts/meter)	Measurement distance (meters)
0.009-0.490	2400/F(kHz)	300
0.490-1.705	24000/F(kHz)	30
1.705-30.0	30	30
30-88	100	3
88-216	150	3
216-960	200	3
Above 960	500	3

**NOTE:**

1. The lower limit shall apply at the transition frequencies.
2. Emission level (dBuV/m) = 20 log Emission level (uV/m).
3. As shown in 15.35(b), for frequencies above 1000MHz, the field strength limits are based on average detector, however, the peak field strength of any emission shall not exceed the maximum permitted average limits, specified above by more than 20dB under any condition of modulation.



#### 4.2.2 TEST INSTRUMENTS

DESCRIPTION & MANUFACTURER	MODEL NO.	SERIAL NO.	CALIBRATED UNTIL
HP Spectrum Analyzer	8590L	3829A02338	Sep. 10, 2003
*ADVANTEST Spectrum Analyzer	R3271A	85060311	May 21, 2003
CHASE RF Pre_Amplifier	CPA9232	1001	Mar. 02, 2003
*HP Pre_Amplifier	8449B	3008A01281	Jun. 12, 2003
*ROHDE & SCHWARZ Test Receiver	ESCS 30	100027	May 23, 2003
*CHASE Broadband Antenna	CBL6112B	2502	Jun. 28, 2003
*Schwarzbeck Horn_Antenna	BBHA9120-D1	D123	Jul. 31, 2003
SCHWARZBECK Tunable Dipole Antenna	UHAP	896	Mar. 07, 2003
SCHWARZBECK Tunable Dipole Antenna	VHAP	879	Mar. 07, 2003
*RF Switches	MP59B	M50867	Jul. 26, 2003
*RF Cable(JETBAO)	BELDN RG-214	Cable_OA_01	Jul. 26, 2003
*Software	AS60P8	NA	NA
*EMCO Antenna Tower	2075-2	9712-2124	NA
*EMCO Turn Table	2081-1.53	9712-2030	NA
*CORCOM AC Filter	MRI2030	107/108	NA

- Note: 1. The calibration interval of the above test instruments is 12 months and the calibrations are traceable to NML/ROC and NIST/USA.  
 2. \* = These equipment are used for the final measurement.  
 3. The horn antenna and HP preamplifier (model: 8449B) are used only for the measurement of emission frequency above 1GHz if tested.  
 4. The test was performed in ADT Open Site No. A.  
 5. The VCCI Site Registration No. is R-782.  
 6. The FCC Site Registration No. is 91097.



#### 4.2.3 TEST PROCEDURES

- a. The EUT was placed on the top of a rotating table 0.8 meters above the ground at a 10 meter open area test site. The table was rotated 360 degrees to determine the position of the highest radiation.
- b. The EUT was set 3 meters away from the interference-receiving antenna, which was mounted on the top of a variable-height antenna tower.
- c. The antenna is a broadband antenna, and its height is varied from one meter to four meters above the ground to determine the maximum value of the field strength. Both horizontal and vertical polarizations of the antenna are set to make the measurement.
- d. For each suspected emission, the EUT was arranged to its worst case and then the antenna was tuned to heights from 1 meter to 4 meters and the rotatable table was turned from 0 degrees to 360 degrees to find the maximum reading.
- e. The test-receiver system was set to Peak Detect Function and Specified Bandwidth with Maximum Hold Mode.
- f. If the emission level of the EUT in peak mode was 10 dB lower than the limit specified, then testing could be stopped and the peak values of the EUT would be reported. Otherwise the emissions that did not have 10 dB margin would be re-tested one by one using the quasi-peak method or average method as specified and then reported in Data sheet peak mode and QP mode.

**NOTE:**

1. The resolution bandwidth and video bandwidth of test receiver/spectrum analyzer is 120kHz for Quasi-peak detection at frequency below 1GHz.
2. The resolution bandwidth and video bandwidth of test receiver/spectrum analyzer is 1 MHz for Peak detection (PK) at frequency above 1GHz.
3. The resolution bandwidth of test receiver/spectrum analyzer is 1 MHz and the video bandwidth is 300 Hz for Average detection (AV) at frequency above 1GHz.

#### 4.2.4 DEVIATION FROM TEST STANDARD

No deviation



### 4.2.5 TEST SETUP

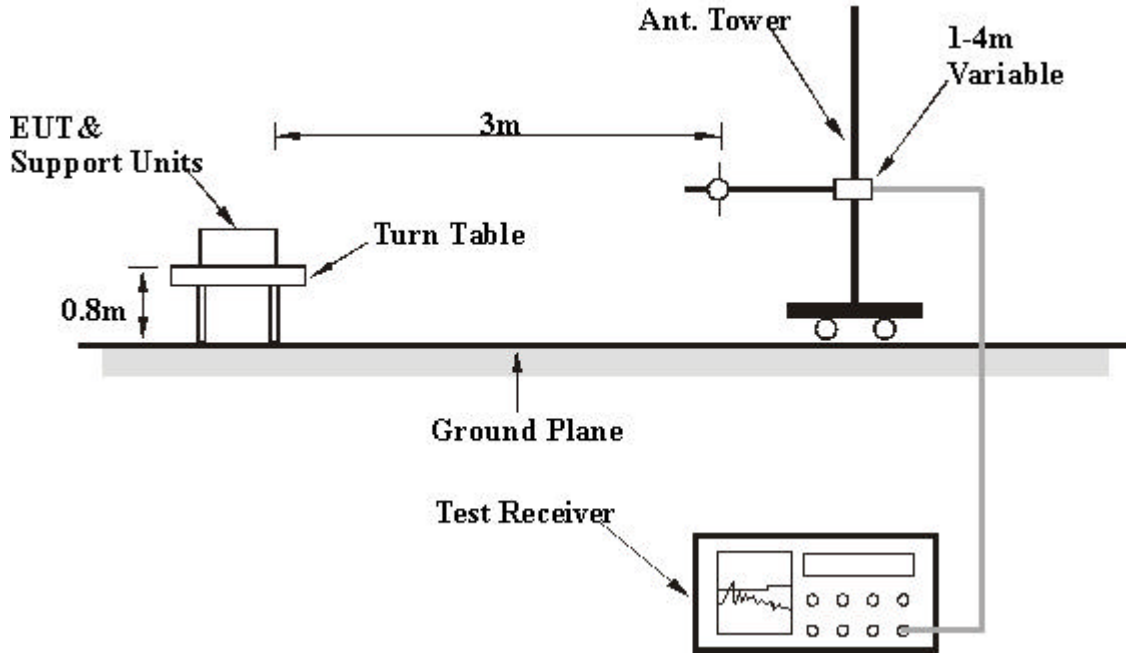

For the actual test configuration, please refer to the related item – Photographs of the Test Configuration.

### 4.2.6 EUT OPERATING CONDITIONS

Same as 4.1.6



## 4.2.7 TEST RESULTS

<b>EUT</b>	Wireless LAN Access Point 8700	<b>MODEL</b>	3CRWE870075A
<b>MODE</b>	Channel 11	<b>FREQUENCY RANGE</b>	30-1000 MHz
<b>INPUT POWER (SYSTEM)</b>	120Vac, 60Hz	<b>DETECTOR FUNCTION</b>	Quasi-Peak
<b>ENVIRONMENTAL CONDITIONS</b>	21 deg. C, 59%RH, 974 hPa	<b>TESTED BY</b>	Tony Chen

**ANTENNA POLARITY & TEST DISTANCE: HORIZONTAL AT 3 M**

No.	Freq. (MHz)	Emission Level (dBuV/m)	Limit (dBuV/m)	Margin (dB)	Antenna Height (m)	Table Angle (Degree)	Raw Value (dBuV)	Correction Factor (dB/m)
1	38.74	24.8 QP	40.00	-15.20	1.43 H	17	10.30	14.50
2	55.26	29.9 QP	40.00	-10.10	2.37 H	219	21.20	8.60
3	56.78	28.4 QP	40.00	-11.60	3.15 H	177	19.70	8.60
4	142.70	32.1 QP	43.50	-11.40	2.02 H	153	19.70	12.40
5	148.13	33.5 QP	43.50	-10.00	2.08 H	143	22.40	11.10
6	162.54	26.7 QP	43.50	-16.80	2.22 H	149	15.30	11.40
7	256.19	32.5 QP	46.00	-13.50	1.39 H	162	17.90	14.60
8	320.00	32.4 QP	46.00	-13.60	1.20 H	162	16.60	15.80
9	384.00	33.2 QP	46.00	-12.80	1.00 H	172	15.30	17.90
10	400.02	34.2 QP	46.00	-11.80	1.04 H	61	15.70	18.50
11	439.99	34.9 QP	46.00	-11.10	1.00 H	11	16.10	18.80
12	800.00	31.9 QP	46.00	-14.10	1.20 H	159	8.70	23.20

**ANTENNA POLARITY & TEST DISTANCE: VERTICAL AT 3 M**

No.	Freq. (MHz)	Emission Level (dBuV/m)	Limit (dBuV/m)	Margin (dB)	Antenna Height (m)	Table Angle (Degree)	Raw Value (dBuV)	Correction Factor (dB/m)
1	38.96	31.7 QP	40.00	-8.30	1.12 V	332	17.30	14.30
2	43.83	33.0 QP	40.00	-7.00	1.46 V	134	21.50	11.50
<b>3</b>	<b>143.25</b>	<b>39.3 QP</b>	<b>43.50</b>	<b>-4.20</b>	<b>1.00 V</b>	<b>153</b>	<b>27.10</b>	<b>12.30</b>
4	148.13	39.0 QP	43.50	-4.50	1.00 V	158	28.00	11.10
5	163.95	33.2 QP	43.50	-10.30	1.00 V	157	21.80	11.40
6	264.00	28.6 QP	46.00	-17.40	1.98 V	62	13.80	14.80
7	480.08	28.6 QP	46.00	-17.40	1.12 V	146	8.90	19.70
8	800.06	31.7 QP	46.00	-14.30	1.29 V	140	8.50	23.20
9	850.06	29.0 QP	46.00	-17.00	1.94 V	281	5.20	23.80
10	900.06	27.5 QP	46.00	-18.50	2.32 V	299	3.40	24.10

- REMARKS:**
1. Emission level(dBuV/m)=Raw Value(dBuV) + Correction Factor(dB)
  2. Correction Factor(dB/m) = Antenna Factor (dB/m) + Cable Factor (dB)
  3. The other emission levels were very low against the limit.
  4. Margin value = Emission level – Limit value.
  5. The limit value is defined as per 15.247



<b>EUT</b>	Wireless LAN Access Point 8700	<b>MODEL</b>	3CRWE870075A
<b>MODE</b>	Channel 1	<b>FREQUENCY RANGE</b>	Above 1000 MHz
<b>INPUT POWER (SYSTEM)</b>	120Vac, 60Hz	<b>DETECTOR FUNCTION</b>	Peak(PK) Average (AV)
<b>ENVIRONMENTAL CONDITIONS</b>	35 deg. C, 60%RH, 974 hPa	<b>TESTED BY</b>	Tony Chen

ANTENNA POLARITY & TEST DISTANCE: HORIZONTAL AT 3 M								
No.	Freq. (MHz)	Emission Level (dBuV/m)	Limit (dBuV/m)	Margin (dB)	Antenna Height (m)	Table Angle (Degree)	Raw Value (dBuV)	Correction Factor (dB/m)
1	2038.00	43.4 PK	74.00	-30.60	1.00 H	147	12.40	31.00
2	2370.00	42.1 PK	74.00	-31.90	2.09 H	153	9.80	32.40
3	*2412.00	102.3 PK			1.05 H	60	69.70	32.60
3	*2412.00	99.1 AV			1.05 H	60	66.60	31.00
4	2496.00	38.0 PK	74.00	-36.00	1.25 H	153	5.10	32.90
5	4075.00	45.6 PK	74.00	-28.40	1.24 H	48	8.70	36.90
6	4824.00	38.1 PK	74.00	-35.90	1.31 H	86	-0.70	38.80

ANTENNA POLARITY & TEST DISTANCE: VERTICAL AT 3 M								
No.	Freq. (MHz)	Emission Level (dBuV/m)	Limit (dBuV/m)	Margin (dB)	Antenna Height (m)	Table Angle (Degree)	Raw Value (dBuV)	Correction Factor (dB/m)
1	2038.00	44.3 PK	74.00	-29.70	1.19 V	61	13.30	31.00
2	2370.00	42.9 PK	74.00	-31.10	1.64 V	138	10.50	32.40
3	*2412.00	99.1 PK			1.99 V	85	66.50	32.60
3	*2412.00	97.9 AV			1.99 V	85	65.30	31.00
4	2495.00	38.8 PK	74.00	-35.20	1.00 V	154	5.90	32.90
5	4075.00	46.7 PK	74.00	-27.30	1.00 V	66	9.80	36.90
6	4824.00	39.2 PK	74.00	-34.80	1.28 V	135	0.30	38.80

- REMARKS:**
1. Emission level(dBuV/m)=Raw Value(dBuV) + Correction Factor(dB)
  2. Correction Factor(dB/m) = Antenna Factor (dB/m) + Cable Factor (dB)
  3. The other emission levels were very low against the limit.
  4. Margin value = Emission level – Limit value.
  5. The limit value is defined as per 15.247
  6. “ \* “ : Fundamental frequency



<b>EUT</b>	Wireless LAN Access Point 8700	<b>MODEL</b>	3CRWE870075A
<b>MODE</b>	Channel 6	<b>FREQUENCY RANGE</b>	Above 1000 MHz
<b>INPUT POWER (SYSTEM)</b>	120Vac, 60Hz	<b>DETECTOR FUNCTION</b>	Peak(PK) Average (AV)
<b>ENVIRONMENTAL CONDITIONS</b>	35 deg. C, 60%RH, 974 hPa	<b>TESTED BY</b>	Tony Chen

ANTENNA POLARITY & TEST DISTANCE: HORIZONTAL AT 3 M								
No.	Freq. (MHz)	Emission Level (dBuV/m)	Limit (dBuV/m)	Margin (dB)	Antenna Height (m)	Table Angle (Degree)	Raw Value (dBuV)	Correction Factor (dB/m)
1	2063.00	45.4 PK	74.00	-28.60	1.45 H	87	14.20	31.10
2	2370.00	42.1 PK	74.00	-31.90	2.02 H	57	9.70	32.40
3	*2437.00	102.3 PK			2.03 H	61	69.70	32.70
3	*2437.00	98.3 AV			2.03 H	61	65.70	31.10
4	2497.00	41.9 PK	74.00	-32.10	2.05 H	52	9.00	32.90
5	4125.00	43.8 PK	74.00	-30.20	1.59 H	166	6.90	36.90
6	4874.00	41.0 PK	74.00	-33.00	1.35 H	332	1.90	39.10

ANTENNA POLARITY & TEST DISTANCE: VERTICAL AT 3 M								
No.	Freq. (MHz)	Emission Level (dBuV/m)	Limit (dBuV/m)	Margin (dB)	Antenna Height (m)	Table Angle (Degree)	Raw Value (dBuV)	Correction Factor (dB/m)
1	2062.00	48.6 PK	74.00	-25.40	1.08 V	88	17.40	31.10
2	2370.00	37.1 PK	74.00	-36.90	2.25 V	174	4.80	32.40
3	*2437.00	101.1 PK			1.00 V	84	68.40	32.70
3	*2437.00	97.9 AV			1.00 V	84	65.20	31.10
4	2493.00	36.3 PK	74.00	-37.70	1.14 V	63	3.40	32.90
5	4126.00	45.2 PK	74.00	-28.80	1.03 V	118	8.30	36.90
6	4873.00	37.7 PK	74.00	-36.30	1.12 V	116	-1.40	39.10

- REMARKS:**
1. Emission level(dBuV/m)=Raw Value(dBuV) + Correction Factor(dB)
  2. Correction Factor(dB/m) = Antenna Factor (dB/m) + Cable Factor (dB)
  3. The other emission levels were very low against the limit.
  4. Margin value = Emission level – Limit value.
  5. The limit value is defined as per 15.247
  6. “ \* “ : Fundamental frequency