

FCC Test Report

Report No.: RF150804C20

FCC ID: HDCWLAN194XF2

Test Model: WLAN194XF2

Received Date: Aug. 04, 2015

Test Date: Aug. 31 ~ Sep. 16, 2015

Issued Date: Sep. 17, 2015

Applicant: Adtran

Address: 901 Explorer Boulevard, Huntsville Alabama, United States, 35806-2807

Issued By: Bureau Veritas Consumer Products Services (H.K.) Ltd., Taoyuan Branch

Lab Address: No. 47-2, 14th Ling, Chia Pau Vil., Lin Kou Dist., New Taipei City, Taiwan, R.O.C.

Test Location: No. 19, Hwa Ya 2nd Rd., Wen Hwa Vil., Kwei Shan Dist., Taoyuan City 33383, TAIWAN (R.O.C.)



This report is for your exclusive use. Any copying or replication of this report to or for any other person or entity, or use of our name or trademark, is permitted only with our prior written permission. This report sets forth our findings solely with respect to the test samples identified herein. The results set forth in this report are not indicative or representative of the quality or characteristics of the lot from which a test sample was taken or any similar or identical product unless specifically and expressly noted. Our report includes all of the tests requested by you and the results thereof based upon the information that you provided to us. You have 60 days from date of issuance of this report to notify us of any material error or omission caused by our negligence, provided, however, that such notice shall be in writing and shall specifically address the issue you wish to raise. A failure to raise such issue within the prescribed time shall constitute your unqualified acceptance of the completeness of this report, the tests conducted and the correctness of the report contents. Unless specific mention, the uncertainty of measurement has been explicitly taken into account to declare the compliance or non-compliance to the specification. The report must not be used by the client to claim product certification, approval, or endorsement by TAF or any government agencies.



Table of Contents

Release Control Record	4
1 Certificate of Conformity	5
2 Summary of Test Results	6
2.1 Measurement Uncertainty	6
2.2 Modification Record	6
3 General Information	7
3.1 General Description of EUT	7
3.2 Description of Test Modes	8
3.2.1 Test Mode Applicability and Tested Channel Detail.....	9
3.3 Duty Cycle of Test Signal	11
3.4 Description of Support Units	12
3.4.1 Configuration of System under Test	12
3.5 General Description of Applied Standards	13
4 Test Types and Results	14
4.1 Radiated Emission and Bandedge Measurement.....	14
4.1.1 Limits of Radiated Emission and Bandedge Measurement	14
4.1.2 Test Instruments	15
4.1.3 Test Procedures.....	16
4.1.4 Deviation from Test Standard	16
4.1.5 Test Set Up	17
4.1.6 EUT Operating Conditions.....	17
4.1.7 Test Results	18
4.2 Conducted Emission Measurement	35
4.2.1 Limits of Conducted Emission Measurement	35
4.2.2 Test Instruments	35
4.2.3 Test Procedures.....	36
4.2.4 Deviation from Test Standard	36
4.2.5 Test Setup.....	36
4.2.6 EUT Operating Conditions.....	36
4.2.7 Test Results	37
4.3 Transmit Power Measurement	39
4.3.1 Limits of Transmit Power Measurement	39
4.3.2 Test Setup.....	39
4.3.3 Test Instruments	39
4.3.4 Test Procedure	40
4.3.5 Deviation from Test Standard	40
4.3.6 EUT Operating Conditions.....	40
4.3.7 Test Result.....	41
4.4 Peak Power Spectral Density Measurement	46
4.4.1 Limits of Peak Power Spectral Density Measurement	46
4.4.2 Test Setup.....	46
4.4.3 Test Instruments	46
4.4.4 Test Procedures.....	47
4.4.5 Deviation from Test Standard	47
4.4.6 EUT Operating Conditions.....	47
4.4.7 Test Results	48
4.5 Frequency Stability.....	53
4.5.1 Limits of Frequency Stability Measurement	53
4.5.2 Test Setup.....	53
4.5.3 Test Instruments	53
4.5.4 Test Procedure	53
4.5.5 Deviation from Test Standard	53
4.5.6 EUT Operating Condition	53



4.5.7 Test Results	54
4.6 6dB Bandwidth Measurement.....	55
4.6.1 Limits of 6dB Bandwidth Measurement.....	55
4.6.2 Test Setup.....	55
4.6.3 Test Instruments	55
4.6.4 Test Procedure	55
4.6.5 Deviation from Test Standard	55
4.6.6 EUT Operating Condition	55
4.6.7 Test Results	56
5 Pictures of Test Arrangements.....	58
Appendix – Information on the Testing Laboratories	59



A D T

Release Control Record

Issue No.	Description	Date Issued
RF150804C20	Original release	Sep. 17, 2015

1 Certificate of Conformity

Product: 802.11 an PCIe Module

Brand: Adtran

Test Model: WLAN194XF2

Sample Status: ENGINEERING SAMPLE

Applicant: Adtran

Test Date: Aug. 31 ~ Sep. 16, 2015

Standards: 47 CFR FCC Part 15, Subpart E (Section 15.407)
ANSI C63.10:2013

The above equipment has been tested by **Bureau Veritas Consumer Products Services (H.K.) Ltd., Taoyuan Branch**, and found compliance with the requirement of the above standards. The test record, data evaluation & Equipment Under Test (EUT) configurations represented herein are true and accurate accounts of the measurements of the sample's EMC characteristics under the conditions specified in this report.

Prepared by :  , **Date:** Sep. 17, 2015
Pettie Chen / Senior Specialist

Approved by :  , **Date:** Sep. 17, 2015
Ken Liu / Senior Manager

2 Summary of Test Results

47 CFR FCC Part 15, Subpart E (SECTION 15.407)			
FCC Clause	Test Item	Result	Remarks
15.407(b)(6)	AC Power Conducted Emissions	Pass	Meet the requirement of limit. Minimum passing margin is -9.76dB at 0.52145MHz.
15.407(b) (1/2/3/4/6)	Radiated Emissions & Band Edge Measurement	Pass	Meet the requirement of limit. Minimum passing margin is -1.0dB at 5400.00, 5722.00MHz.
15.407(a)(1/2 /3)	Max Average Transmit Power	Pass	Meet the requirement of limit.
15.407(a)(1/2 /3)	Peak Power Spectral Density	Pass	Meet the requirement of limit.
15.407(e)	6dB bandwidth	Pass	Meet the requirement of limit. (U-NII-3 Band only)
15.407(g)	Frequency Stability	Pass	Meet the requirement of limit.
15.203	Antenna Requirement	Pass	Antenna connector is MMCX not a standard connector.

2.1 Measurement Uncertainty

Where relevant, the following measurement uncertainty levels have been estimated for tests performed on the EUT as specified in CISPR 16-4-2:

Measurement	Frequency	Expanded Uncertainty (k=2) (\pm)
Conducted Emissions at mains ports	150kHz ~ 30MHz	2.44 dB
Radiated Emissions up to 1 GHz	30MHz ~ 200MHz	3.86 dB
	200MHz ~ 1000MHz	3.87 dB
Radiated Emissions above 1 GHz	1GHz ~ 18GHz	2.29 dB
	18GHz ~ 40GHz	2.29 dB

2.2 Modification Record

There were no modifications required for compliance.

3 General Information

3.1 General Description of EUT

Product	802.11 an PCIe Module
Brand	Adtran
Test Model	WLAN194XF2
Status of EUT	ENGINEERING SAMPLE
Power Supply Rating	5Vdc (host)
Modulation Type	64QAM, 16QAM, QPSK, BPSK
Modulation Technology	OFDM
Transfer Rate	802.11a: 54.0/ 48.0/ 36.0/ 24.0/ 18.0/ 12.0/ 9.0/ 6.0Mbps 802.11n: up to 450.0Mbps
Operating Frequency	5180 ~ 5240MHz, 5745 ~ 5825MHz
Number of Channel	5180 ~ 5240MHz: 4 for 802.11a, 802.11n (HT20) 2 for 802.11n (HT40) 5745 ~ 5825MHz: 5 for 802.11a, 802.11n (HT20) 2 for 802.11n (HT40)
Output Power	5180 ~ 5240MHz: 303.345mW 5745 ~ 5825MHz: 223.953mW
Antenna Type	Dipole antenna with 7dBi gain
Antenna Connector	MMCX
Accessory Device	NA
Data Cable Supplied	NA

Note:

1. This report is prepared for FCC class II permissive change. The difference compared with the original design is updating standard to new rule version. All test data had been re-tested.
2. The EUT incorporates a MIMO function. Physically, the EUT provides 3 completed transmitters and 3 receivers.

Modulation Mode	TX Function
802.11a	3TX
802.11n (HT20)	3TX
802.11n (HT40)	3TX

3.2 Description of Test Modes

FOR 5180 ~ 5240MHz

4 channels are provided for 802.11a, 802.11n (HT20):

Channel	Frequency	Channel	Frequency
36	5180 MHz	44	5220 MHz
40	5200 MHz	48	5240 MHz

2 channels are provided for 802.11n (HT40):

Channel	Frequency	Channel	Frequency
38	5190 MHz	46	5230 MHz

FOR 5745 ~ 5825MHz

5 channels are provided for 802.11a, 802.11n (HT20):

Channel	Frequency	Channel	Frequency
149	5745MHz	161	5805MHz
153	5765MHz	165	5825MHz
157	5785MHz		

2 channels are provided for 802.11n (HT40):

Channel	Frequency	Channel	Frequency
151	5755MHz	159	5795MHz

3.2.1 Test Mode Applicability and Tested Channel Detail

EUT CONFIGURE MODE	APPLICABLE TO				DESCRIPTION
	RE≥1G	RE<1G	PLC	APCM	
-	√	√	√	√	-

Where **RE≥1G**: Radiated Emission above 1GHz & Bandedge Measurement
RE<1G: Radiated Emission below 1GHz
PLC: Power Line Conducted Emission
APCM: Antenna Port Conducted Measurement

NOTE: The EUT had been pre-tested on the positioned of each 3 axis. The worst case was found when positioned on **X-plane**.

Radiated Emission Test (Above 1GHz):

- Pre-Scan has been conducted to determine the worst-case mode from all possible combinations between available modulations, data rates and antenna ports (if EUT with antenna diversity architecture).
- Following channel(s) was (were) selected for the final test as listed below.

EUT CONFIGURE MODE	MODE	FREQ. BAND (MHz)	AVAILABLE CHANNEL	TESTED CHANNEL	MODULATION TECHNOLOGY	MODULATION TYPE	DATA RATE (Mbps)
-	802.11a	5180-5240	36 to 48	36, 40, 48	OFDM	BPSK	6.0
-	802.11n (HT20)		36 to 48	36, 40, 48	OFDM	BPSK	6.5
-	802.11n (HT40)		38 to 46	38, 46	OFDM	BPSK	13.5
-	802.11a	5745-5825	149 to 165	149, 157, 165	OFDM	BPSK	6.0
-	802.11n (HT20)		149 to 165	149, 157, 165	OFDM	BPSK	6.5
-	802.11n (HT40)		151 to 159	151, 159	OFDM	BPSK	13.5

Radiated Emission Test (Below 1GHz):

- Pre-Scan has been conducted to determine the worst-case mode from all possible combinations between available modulations, data rates and antenna ports (if EUT with antenna diversity architecture).
- Following channel(s) was (were) selected for the final test as listed below.

EUT CONFIGURE MODE	MODE	FREQ. BAND (MHz)	AVAILABLE CHANNEL	TESTED CHANNEL	MODULATION TECHNOLOGY	MODULATION TYPE	DATA RATE (Mbps)
-	802.11a	5180-5240	36 to 48	40	OFDM	BPSK	6.0
-	802.11a	5745-5825	149 to 165		OFDM	BPSK	6.0

Power Line Conducted Emission Test:

- Pre-Scan has been conducted to determine the worst-case mode from all possible combinations between available modulations, data rates and antenna ports (if EUT with antenna diversity architecture).
- Following channel(s) was (were) selected for the final test as listed below.

EUT CONFIGURE MODE	MODE	FREQ. BAND (MHz)	AVAILABLE CHANNEL	TESTED CHANNEL	MODULATION TECHNOLOGY	MODULATION TYPE	DATA RATE (Mbps)
-	802.11a	5180-5240	36 to 48	40	OFDM	BPSK	6.0
-	802.11a	5745-5825	149 to 165		OFDM	BPSK	6.0

Antenna Port Conducted Measurement:

- This item includes all test value of each mode, but only includes spectrum plot of worst value of each mode.
- Pre-Scan has been conducted to determine the worst-case mode from all possible combinations between available modulations, data rates and antenna ports (if EUT with antenna diversity architecture).
- Following channel(s) was (were) selected for the final test as listed below.

EUT CONFIGURE MODE	MODE	FREQ. BAND (MHz)	AVAILABLE CHANNEL	TESTED CHANNEL	MODULATION TECHNOLOGY	MODULATION TYPE	DATA RATE (Mbps)
-	802.11a	5180-5240	36 to 48	36, 40, 48	OFDM	BPSK	6.0
-	802.11n (HT20)		36 to 48	36, 40, 48	OFDM	BPSK	6.5
-	802.11n (HT40)		38 to 46	38, 46	OFDM	BPSK	13.5
-	802.11a	5745-5825	149 to 165	149, 157, 165	OFDM	BPSK	6.0
-	802.11n (HT20)		149 to 165	149, 157, 165	OFDM	BPSK	6.5
-	802.11n (HT40)		151 to 159	151, 159	OFDM	BPSK	13.5

Test Condition:

APPLICABLE TO	ENVIRONMENTAL CONDITIONS	INPUT POWER (SYSTEM)	TESTED BY
RE\geq1G	20deg. C, 66%RH	120Vac, 60Hz	Jones Chang
RE$<$1G	18deg. C, 70%RH	120Vac, 60Hz	Jones Chang
PLC	25deg. C, 65%RH	120Vac, 60Hz	Bayu Chen
APCM	25deg. C, 60%RH	120Vac, 60Hz	Frank Liu

3.3 Duty Cycle of Test Signal

Duty cycle of test signal is < 98 %, duty factor is required

802.11a: Duty cycle = $1.357/1.422 = 0.954$, Duty factor = $10 * \log(1/0.954) = 0.20$

802.11n (HT20): Duty cycle = $1.268/1.333 = 0.951$, Duty factor = $10 * \log(1/0.951) = 0.22$

802.11n (HT40): Duty cycle = $0.623/0.675 = 0.923$, Duty factor = $10 * \log(1/0.923) = 0.35$



3.4 Description of Support Units

The EUT has been tested as an independent unit together with other necessary accessories or support units. The following support units or accessories were used to form a representative test configuration during the tests.

ID	Product	Brand	Model No.	Serial No.	FCC ID	Remarks
A.	Notebook	DELL	E5410	1HC2XM1	FCC DoC Approved	-
B.	Convertible board	NA	NA	NA	NA	Provided by client
C.	Power Supply	Topward	33010D	807748	NA	-

Note: All power cords of the above support units are non-shielded (1.8m).

ID	Descriptions	Qty.	Length (m)	Shielding (Yes/No)	Cores (Qty.)	Remarks
1.	Power	1	1.8	N	0	-

3.4.1 Configuration of System under Test

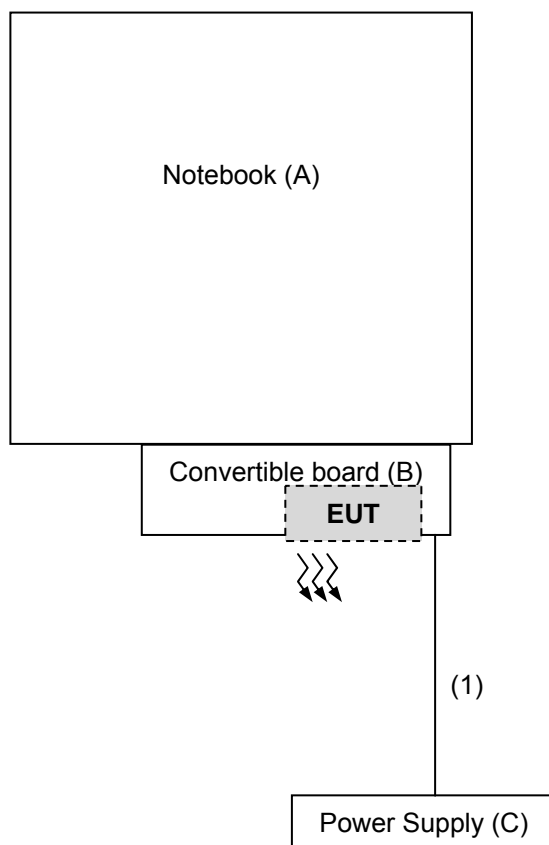

3.5 General Description of Applied Standards

The EUT is a RF Product. According to the specifications of the manufacturer, it must comply with the requirements of the following standards:

FCC Part 15, Subpart E (15.407)

789033 D02 General UNII Test Procedures New Rules v01

662911 D01 Multiple Transmitter Output v02r01

ANSI C63.10-2013

All test items have been performed and recorded as per the above standards.

Note: The EUT is also considered as a kind of computer peripheral, because the connection to computer is necessary for typical use. It has been verified to comply with the requirements of FCC Part 15, Subpart B, Class B (DoC). The test report has been issued separately.

4 Test Types and Results

4.1 Radiated Emission and Bandedge Measurement

4.1.1 Limits of Radiated Emission and Bandedge Measurement

Radiated emissions which fall in the restricted bands must comply with the radiated emission limits specified as below table. Other emissions shall be at least 20dB below the highest level of the desired power:

Frequencies (MHz)	Field Strength (microvolts/meter)	Measurement Distance (meters)
0.009 ~ 0.490	2400/F(kHz)	300
0.490 ~ 1.705	24000/F(kHz)	30
1.705 ~ 30.0	30	30
30 ~ 88	100	3
88 ~ 216	150	3
216 ~ 960	200	3
Above 960	500	3

NOTE:

1. The lower limit shall apply at the transition frequencies.
2. Emission level (dBuV/m) = 20 log Emission level (uV/m).
3. For frequencies above 1000MHz, the field strength limits are based on average detector, however, the peak field strength of any emission shall not exceed the maximum permitted average limits, specified above by more than 20dB under any condition of modulation.

LIMITS OF UNWANTED EMISSION OUT OF THE RESTRICTED BANDS

APPLICABLE TO	LIMIT	
789033 D02 General UNII Test Procedures New Rules v01	FIELD STRENGTH AT 3m	
	PK:74 (dBuV/m)	AV:54 (dBuV/m)
APPLICABLE TO	EIRP LIMIT	EQUIVALENT FIELD STRENGTH AT 3m
15.407(b)(1)	PK:-27 (dBm/MHz)	PK:68.2(dBuV/m)
15.407(b)(2)		
15.407(b)(3)		
15.407(b)(4)	PK:-27 (dBm/MHz) ^{*1} PK:-17 (dBm/MHz) ^{*2}	PK: 68.2(dBuV/m) ^{*1} PK: 78.2 (dBuV/m) ^{*2}

NOTE: ^{*1} beyond 10MHz of the band edge ^{*2} within 10 MHz of band edge

The following formula is used to convert the equipment isotropic radiated power (eirp) to field strength:

$$E = \frac{1000000\sqrt{30P}}{3} \mu\text{V/m, where P is the eirp (Watts).}$$

4.1.2 Test Instruments

Description & Manufacturer	Model No.	Serial No.	Date Of Calibration	Due Date Of Calibration
Test Receiver ROHDE & SCHWARZ	ESIB7	100187	Apr. 10, 2015	Apr. 09, 2016
Spectrum Analyzer ROHDE & SCHWARZ	FSP40	100040	Jul. 08, 2015	Jul. 07, 2016
BILOG Antenna SCHWARZBECK	VULB9168	9168-160	Feb. 05, 2015	Feb. 04, 2016
HORN Antenna SCHWARZBECK	9120D	209	Feb. 09, 2015	Feb. 08, 2016
HORN Antenna SCHWARZBECK	BBHA 9170	BBHA9170241	Feb. 09, 2015	Feb. 08, 2016
Preamplifier Agilent	8447D	2944A10738	Oct. 18, 2014	Oct. 17, 2015
Preamplifier Agilent	8449B	3008A01964	Aug. 22, 2015	Aug. 21, 2016
RF signal cable HUBER+SUHNER	SUCOFLEX 104	Cable-CH3-03(214 378)	Aug. 22, 2015	Aug. 21, 2016
RF signal cable HUBER+SUHNER	SUCOFLEX 106	Cable-CH3-03(309 224+12738)	Aug. 22, 2015	Aug. 21, 2016
Software BV ADT	ADT_Radiated_ V7.6.15.9.4	NA	NA	NA
Antenna Tower inn-co GmbH	MA 4000	013303	NA	NA
Antenna Tower Controller BV ADT	AT100	AT93021702	NA	NA
Turn Table BV ADT	TT100	TT93021702	NA	NA
Turn Table Controller BV ADT	SC100	SC93021702	NA	NA
26GHz ~ 40GHz Amplifier	EM26400	815221	Oct. 18, 2014	Oct. 17, 2015
High Speed Peak Power Meter	ML2495A	0824011	Jul. 09, 2015	Jul. 08, 2016
Power Sensor	MA2411B	0738171	Jul. 09, 2015	Jul. 08, 2016

- NOTE:**
1. The calibration interval of the above test instruments is 12 months and the calibrations are traceable to NML/ROC and NIST/USA.
 2. The test was performed in HwaYa Chamber 9.
 3. The horn antenna and HP preamplifier (model: 8449B) are used only for the measurement of emission frequency above 1GHz if tested.
 4. The FCC Site Registration No. is 215374.
 5. The IC Site Registration No. is IC 7450F-9.

4.1.3 Test Procedures

- a. The EUT was placed on the top of a rotating table 0.8 meters (for below 1GHz) / 1.5 meters (for above 1GHz) above the ground at 3 meter chamber room for test. The table was rotated 360 degrees to determine the position of the highest radiation.
- b. The EUT was set 3 meters away from the interference-receiving antenna, which was mounted on the top of a variable-height antenna tower.
- c. The height of antenna is varied from one meter to four meters above the ground to determine the maximum value of the field strength. Both horizontal and vertical polarizations of the antenna are set to make the measurement.
- d. For each suspected emission, the EUT was arranged to its worst case and then the antenna was tuned to heights from 1 meter to 4 meters and the rotatable table was turned from 0 degrees to 360 degrees to find the maximum reading.
- e. The test-receiver system was set to quasi-peak detect function and specified bandwidth with maximum hold mode when the test frequency is below 1 GHz.
- f. The test-receiver system was set to peak and average detect function and specified bandwidth with maximum hold mode when the test frequency is above 1 GHz. If the peak reading value also meets average limit, measurement with the average detector is unnecessary.

Note:

1. The resolution bandwidth and video bandwidth of test receiver/spectrum analyzer is 120kHz for Quasi-peak detection (QP) at frequency below 1GHz.
2. The resolution bandwidth of test receiver/spectrum analyzer is 1 MHz and the video bandwidth is 3 MHz for Peak detection (PK) at frequency above 1GHz.
3. The resolution bandwidth of test receiver/spectrum analyzer is 1MHz and the video bandwidth is 3MHz for RMS Average (Duty cycle < 98%) for Average detection (AV) at frequency above 1GHz, then the measurement results was added to a correction factor ($10 \log(1/\text{duty cycle})$).
4. The resolution bandwidth of test receiver/spectrum analyzer is 1MHz and the video bandwidth is 10Hz (Duty cycle $\geq 98\%$) for Average detection (AV) at frequency above 1GHz.
5. All modes of operation were investigated and the worst-case emissions are reported.

4.1.4 Deviation from Test Standard

No deviation.

4.1.5 Test Set Up

<Frequency Range below 1GHz>

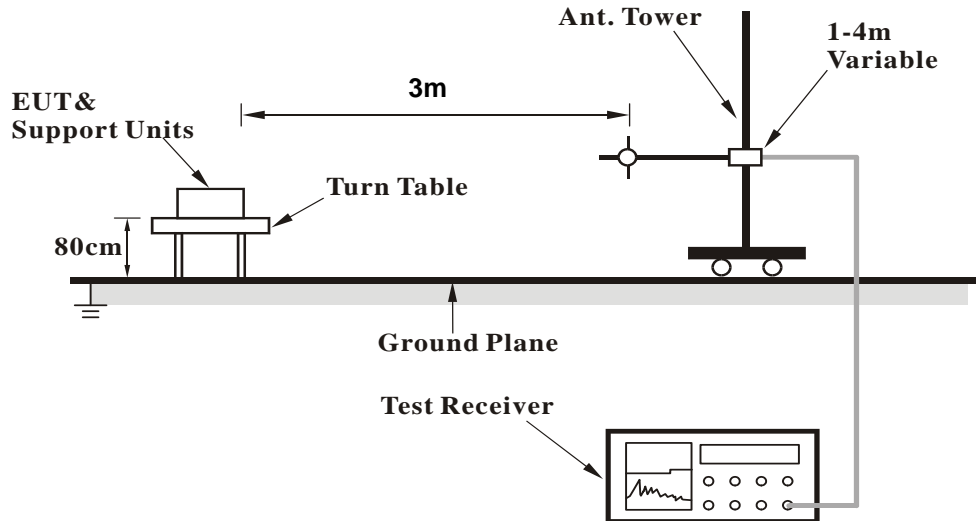

<Frequency Range above 1GHz>

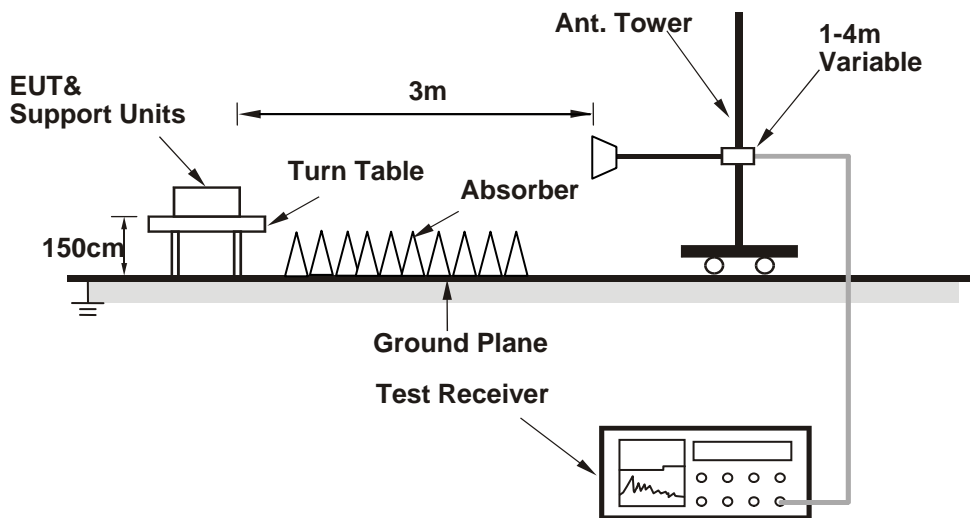

For the actual test configuration, please refer to the attached file (Test Setup Photo)

4.1.6 EUT Operating Conditions

- Plugged the EUT into notebook via a convertible board and placed them on the testing table.
- The notebook system ran a test program (provided by manufacturer) to enable EUT under transmission condition continuously at specific channel frequency.
- The necessary accessories enable the system in full functions.

4.1.7 Test Results

Above 1GHz data:

802.11a

CHANNEL	TX Channel 36	DETECTOR FUNCTION	Peak (PK) Average (AV)
FREQUENCY RANGE	1GHz ~ 40GHz		

ANTENNA POLARITY & TEST DISTANCE: HORIZONTAL AT 3 M

NO.	FREQ. (MHz)	EMISSION LEVEL (dBuV/m)	LIMIT (dBuV/m)	MARGIN (dB)	ANTENNA HEIGHT (m)	TABLE ANGLE (Degree)	RAW VALUE (dBuV)	CORRECTION FACTOR (dB/m)
1	5150.00	59.3 PK	74.0	-14.7	1.66 H	109	53.10	6.20
2	5150.00	47.6 AV	54.0	-6.4	1.66 H	109	41.40	6.20
3	*5180.00	107.3 PK			1.88 H	95	67.80	39.50
4	*5180.00	97.3 AV			1.88 H	95	57.80	39.50
5	#10360.00	59.0 PK	74.0	-15.0	1.45 H	211	42.00	17.00
6	#10360.00	46.1 AV	54.0	-7.9	1.45 H	211	29.10	17.00

ANTENNA POLARITY & TEST DISTANCE: VERTICAL AT 3 M

NO.	FREQ. (MHz)	EMISSION LEVEL (dBuV/m)	LIMIT (dBuV/m)	MARGIN (dB)	ANTENNA HEIGHT (m)	TABLE ANGLE (Degree)	RAW VALUE (dBuV)	CORRECTION FACTOR (dB/m)
1	5150.00	72.2 PK	74.0	-1.8	1.58 V	122	66.00	6.20
2	5150.00	52.5 AV	54.0	-1.5	1.58 V	122	46.30	6.20
3	*5180.00	119.6 PK			1.85 V	275	80.10	39.50
4	*5180.00	110.2 AV			1.85 V	275	70.70	39.50
5	#10360.00	59.4 PK	74.0	-14.6	1.73 V	72	42.40	17.00
6	#10360.00	46.5 AV	54.0	-7.5	1.73 V	72	29.50	17.00

REMARKS:

1. Emission Level(dBuV/m) = Raw Value(dBuV) + Correction Factor(dB/m)
2. Correction Factor(dB/m) = Antenna Factor(dB/m) + Cable Factor(dB)
3. The other emission levels were very low against the limit.
4. Margin value = Emission Level – Limit value
5. " * ": Fundamental frequency.
6. " # ": The radiated frequency is out of the restricted band.

CHANNEL	TX Channel 40	DETECTOR FUNCTION	Peak (PK)
FREQUENCY RANGE	1GHz ~ 40GHz		Average (AV)

ANTENNA POLARITY & TEST DISTANCE: HORIZONTAL AT 3 M

NO.	FREQ. (MHz)	EMISSION LEVEL (dBuV/m)	LIMIT (dBuV/m)	MARGIN (dB)	ANTENNA HEIGHT (m)	TABLE ANGLE (Degree)	RAW VALUE (dBuV)	CORRECTION FACTOR (dB/m)
1	*5200.00	108.9 PK			1.81 H	104	69.30	39.60
2	*5200.00	99.3 AV			1.81 H	104	59.70	39.60
3	5400.00	59.2 PK	74.0	-14.8	1.73 H	123	52.50	6.70
4	5400.00	47.3 AV	54.0	-6.7	1.73 H	123	40.60	6.70
5	#10400.00	59.5 PK	74.0	-14.5	1.50 H	186	42.50	17.00
6	#10400.00	46.3 AV	54.0	-7.7	1.50 H	186	29.30	17.00

ANTENNA POLARITY & TEST DISTANCE: VERTICAL AT 3 M

NO.	FREQ. (MHz)	EMISSION LEVEL (dBuV/m)	LIMIT (dBuV/m)	MARGIN (dB)	ANTENNA HEIGHT (m)	TABLE ANGLE (Degree)	RAW VALUE (dBuV)	CORRECTION FACTOR (dB/m)
1	*5200.00	120.3 PK			1.85 V	74	80.70	39.60
2	*5200.00	110.6 AV			1.85 V	74	71.00	39.60
3	5360.00	64.6 PK	74.0	-9.4	1.81 V	73	58.20	6.40
4	5360.00	52.1 AV	54.0	-1.9	1.81 V	73	45.70	6.40
5	#10400.00	59.9 PK	74.0	-14.1	1.70 V	96	42.90	17.00
6	#10400.00	46.9 AV	54.0	-7.1	1.70 V	96	29.90	17.00

REMARKS:

1. Emission Level(dBuV/m) = Raw Value(dBuV) + Correction Factor(dB/m)
2. Correction Factor(dB/m) = Antenna Factor(dB/m) + Cable Factor(dB)
3. The other emission levels were very low against the limit.
4. Margin value = Emission Level – Limit value
5. " * ": Fundamental frequency.
6. " # ": The radiated frequency is out of the restricted band.

CHANNEL	TX Channel 48	DETECTOR FUNCTION	Peak (PK)
FREQUENCY RANGE	1GHz ~ 40GHz		Average (AV)

ANTENNA POLARITY & TEST DISTANCE: HORIZONTAL AT 3 M

NO.	FREQ. (MHz)	EMISSION LEVEL (dBuV/m)	LIMIT (dBuV/m)	MARGIN (dB)	ANTENNA HEIGHT (m)	TABLE ANGLE (Degree)	RAW VALUE (dBuV)	CORRECTION FACTOR (dB/m)
1	*5240.00	107.3 PK			1.90 H	95	67.70	39.60
2	*5240.00	97.7 AV			1.90 H	95	58.10	39.60
3	5400.00	59.0 PK	74.0	-15.0	1.60 H	197	52.30	6.70
4	5400.00	47.3 AV	54.0	-6.7	1.60 H	197	40.60	6.70
5	#10480.00	60.2 PK	74.0	-13.8	1.44 H	177	42.20	18.00
6	#10480.00	47.3 AV	54.0	-6.7	1.44 H	177	29.30	18.00

ANTENNA POLARITY & TEST DISTANCE: VERTICAL AT 3 M

NO.	FREQ. (MHz)	EMISSION LEVEL (dBuV/m)	LIMIT (dBuV/m)	MARGIN (dB)	ANTENNA HEIGHT (m)	TABLE ANGLE (Degree)	RAW VALUE (dBuV)	CORRECTION FACTOR (dB/m)
1	*5240.00	122.4 PK			1.83 V	274	82.80	39.60
2	*5240.00	112.8 AV			1.83 V	274	73.20	39.60
3	5400.00	63.4 PK	74.0	-10.6	1.83 V	110	56.70	6.70
4	5400.00	52.5 AV	54.0	-1.5	1.83 V	110	45.80	6.70
5	#10480.00	60.9 PK	74.0	-13.1	1.73 V	80	42.90	18.00
6	#10480.00	47.8 AV	54.0	-6.2	1.73 V	80	29.80	18.00

REMARKS:

1. Emission Level(dBuV/m) = Raw Value(dBuV) + Correction Factor(dB/m)
2. Correction Factor(dB/m) = Antenna Factor(dB/m) + Cable Factor(dB)
3. The other emission levels were very low against the limit.
4. Margin value = Emission Level – Limit value
5. " * ": Fundamental frequency.
6. " # ": The radiated frequency is out of the restricted band.



CHANNEL	TX Channel 149	DETECTOR FUNCTION	Peak (PK)
FREQUENCY RANGE	1GHz ~ 40GHz		Average (AV)

ANTENNA POLARITY & TEST DISTANCE: HORIZONTAL AT 3 M

NO.	FREQ. (MHz)	EMISSION LEVEL (dBuV/m)	LIMIT (dBuV/m)	MARGIN (dB)	ANTENNA HEIGHT (m)	TABLE ANGLE (Degree)	RAW VALUE (dBuV)	CORRECTION FACTOR (dB/m)
1	#5714.00	59.8 PK	74.0	-14.2	1.80 H	66	52.60	7.20
2	#5714.00	47.7 AV	54.0	-6.3	1.80 H	66	40.50	7.20
3	#5722.00	62.8 PK	78.2	-15.4	1.89 H	57	55.60	7.20
4	#5725.00	61.0 PK	78.2	-17.2	1.89 H	57	53.80	7.20
5	*5745.00	106.6 PK			2.18 H	32	66.20	40.40
6	*5745.00	97.7 AV			2.18 H	32	57.30	40.40
7	11490.00	60.9 PK	74.0	-13.1	1.50 H	111	42.60	18.30
8	11490.00	47.7 AV	54.0	-6.3	1.50 H	111	29.40	18.30

ANTENNA POLARITY & TEST DISTANCE: VERTICAL AT 3 M

NO.	FREQ. (MHz)	EMISSION LEVEL (dBuV/m)	LIMIT (dBuV/m)	MARGIN (dB)	ANTENNA HEIGHT (m)	TABLE ANGLE (Degree)	RAW VALUE (dBuV)	CORRECTION FACTOR (dB/m)
1	#5714.00	64.3 PK	74.0	-9.7	1.97 V	43	57.10	7.20
2	#5714.00	51.5 AV	54.0	-2.5	1.97 V	43	44.30	7.20
3	#5722.00	77.2 PK	78.2	-1.0	1.99 V	105	70.00	7.20
4	#5725.00	62.8 PK	78.2	-15.4	1.99 V	105	55.60	7.20
5	*5745.00	117.9 PK			2.10 V	60	77.50	40.40
6	*5745.00	108.9 AV			2.10 V	60	68.50	40.40
7	11490.00	61.3 PK	74.0	-12.7	1.49 V	241	43.00	18.30
8	11490.00	48.3 AV	54.0	-5.7	1.49 V	241	30.00	18.30

REMARKS:

1. Emission Level(dBuV/m) = Raw Value(dBuV) + Correction Factor(dB/m)
2. Correction Factor(dB/m) = Antenna Factor(dB/m) + Cable Factor(dB)
3. The other emission levels were very low against the limit.
4. Margin value = Emission Level – Limit value
5. " * ": Fundamental frequency.
6. " # ": The radiated frequency is out of the restricted band.

CHANNEL	TX Channel 157	DETECTOR FUNCTION	Peak (PK)
FREQUENCY RANGE	1GHz ~ 40GHz		Average (AV)

ANTENNA POLARITY & TEST DISTANCE: HORIZONTAL AT 3 M

NO.	FREQ. (MHz)	EMISSION LEVEL (dBuV/m)	LIMIT (dBuV/m)	MARGIN (dB)	ANTENNA HEIGHT (m)	TABLE ANGLE (Degree)	RAW VALUE (dBuV)	CORRECTION FACTOR (dB/m)
1	5400.00	58.7 PK	74.0	-15.3	1.91 H	110	52.00	6.70
2	5400.00	46.8 AV	54.0	-7.2	1.91 H	110	40.10	6.70
3	*5785.00	106.2 PK			2.10 H	36	65.70	40.50
4	*5785.00	97.1 AV			2.10 H	36	56.60	40.50
5	11570.00	61.0 PK	74.0	-13.0	1.50 H	101	42.80	18.20
6	11570.00	47.9 AV	54.0	-6.1	1.50 H	101	29.70	18.20

ANTENNA POLARITY & TEST DISTANCE: VERTICAL AT 3 M

NO.	FREQ. (MHz)	EMISSION LEVEL (dBuV/m)	LIMIT (dBuV/m)	MARGIN (dB)	ANTENNA HEIGHT (m)	TABLE ANGLE (Degree)	RAW VALUE (dBuV)	CORRECTION FACTOR (dB/m)
1	5400.00	63.4 PK	74.0	-10.6	1.83 V	81	56.70	6.70
2	5400.00	53.0 AV	54.0	-1.0	1.83 V	81	46.30	6.70
3	*5785.00	119.1 PK			2.09 V	62	78.60	40.50
4	*5785.00	110.0 AV			2.09 V	62	69.50	40.50
5	11570.00	61.3 PK	74.0	-12.7	1.68 V	111	43.10	18.20
6	11570.00	49.0 AV	54.0	-5.0	1.68 V	111	30.80	18.20

REMARKS:

1. Emission Level(dBuV/m) = Raw Value(dBuV) + Correction Factor(dB/m)
2. Correction Factor(dB/m) = Antenna Factor(dB/m) + Cable Factor(dB)
3. The other emission levels were very low against the limit.
4. Margin value = Emission Level – Limit value
5. " * ": Fundamental frequency.



CHANNEL	TX Channel 165	DETECTOR FUNCTION	Peak (PK)
FREQUENCY RANGE	1GHz ~ 40GHz		Average (AV)

ANTENNA POLARITY & TEST DISTANCE: HORIZONTAL AT 3 M

NO.	FREQ. (MHz)	EMISSION LEVEL (dBuV/m)	LIMIT (dBuV/m)	MARGIN (dB)	ANTENNA HEIGHT (m)	TABLE ANGLE (Degree)	RAW VALUE (dBuV)	CORRECTION FACTOR (dB/m)
1	*5825.00	109.5 PK			2.19 H	29	69.00	40.50
2	*5825.00	99.9 AV			2.19 H	29	59.40	40.50
3	#5850.00	60.4 PK	78.2	-17.8	2.00 H	30	52.90	7.50
4	#5853.00	61.7 PK	78.2	-16.5	2.00 H	30	54.10	7.60
5	#5861.00	60.2 PK	74.0	-13.8	1.88 H	113	52.60	7.60
6	#5861.00	48.1 AV	54.0	-5.9	1.88 H	113	40.50	7.60
7	11650.00	61.4 PK	74.0	-12.6	1.48 H	159	42.70	18.70
8	11650.00	48.1 AV	54.0	-5.9	1.48 H	159	29.40	18.70

ANTENNA POLARITY & TEST DISTANCE: VERTICAL AT 3 M

NO.	FREQ. (MHz)	EMISSION LEVEL (dBuV/m)	LIMIT (dBuV/m)	MARGIN (dB)	ANTENNA HEIGHT (m)	TABLE ANGLE (Degree)	RAW VALUE (dBuV)	CORRECTION FACTOR (dB/m)
1	5360.00	63.9 PK	74.0	-10.1	1.86 V	71	57.50	6.40
2	5360.00	52.2 AV	54.0	-1.8	1.86 V	71	45.80	6.40
3	*5825.00	122.9 PK			2.10 V	52	82.40	40.50
4	*5825.00	113.0 AV			2.10 V	52	72.50	40.50
5	#5850.00	61.8 PK	78.2	-16.4	1.88 V	71	54.30	7.50
6	#5853.00	75.2 PK	78.2	-3.0	1.88 V	71	67.60	7.60
7	#5861.00	69.0 PK	74.0	-5.0	1.92 V	77	61.40	7.60
8	#5861.00	52.9 AV	54.0	-1.1	1.92 V	77	45.30	7.60
9	11650.00	61.9 PK	74.0	-12.1	1.77 V	105	43.20	18.70
10	11650.00	49.2 AV	54.0	-4.8	1.77 V	105	30.50	18.70

REMARKS:

1. Emission Level(dBuV/m) = Raw Value(dBuV) + Correction Factor(dB/m)
2. Correction Factor(dB/m) = Antenna Factor(dB/m) + Cable Factor(dB)
3. The other emission levels were very low against the limit.
4. Margin value = Emission Level – Limit value
5. " * ": Fundamental frequency.
6. " # ": The radiated frequency is out of the restricted band.

802.11n (HT20)

CHANNEL	TX Channel 36	DETECTOR FUNCTION	Peak (PK)
FREQUENCY RANGE	1GHz ~ 40GHz		Average (AV)

ANTENNA POLARITY & TEST DISTANCE: HORIZONTAL AT 3 M								
NO.	FREQ. (MHz)	EMISSION LEVEL (dBuV/m)	LIMIT (dBuV/m)	MARGIN (dB)	ANTENNA HEIGHT (m)	TABLE ANGLE (Degree)	RAW VALUE (dBuV)	CORRECTION FACTOR (dB/m)
1	5150.00	58.7 PK	74.0	-15.3	1.80 H	104	52.50	6.20
2	5150.00	46.4 AV	54.0	-7.6	1.80 H	104	40.20	6.20
3	*5180.00	106.4 PK			1.89 H	102	66.90	39.50
4	*5180.00	96.7 AV			1.89 H	102	57.20	39.50
5	#10360.00	59.0 PK	74.0	-15.0	1.66 H	70	42.00	17.00
6	#10360.00	45.9 AV	54.0	-8.1	1.66 H	70	28.90	17.00

ANTENNA POLARITY & TEST DISTANCE: VERTICAL AT 3 M								
NO.	FREQ. (MHz)	EMISSION LEVEL (dBuV/m)	LIMIT (dBuV/m)	MARGIN (dB)	ANTENNA HEIGHT (m)	TABLE ANGLE (Degree)	RAW VALUE (dBuV)	CORRECTION FACTOR (dB/m)
1	5150.00	70.8 PK	74.0	-3.2	1.68 V	121	64.60	6.20
2	5150.00	52.1 AV	54.0	-1.9	1.68 V	121	45.90	6.20
3	*5180.00	118.2 PK			1.81 V	96	78.70	39.50
4	*5180.00	108.2 AV			1.81 V	96	68.70	39.50
5	#10360.00	59.3 PK	74.0	-14.7	1.69 V	69	42.30	17.00
6	#10360.00	46.4 AV	54.0	-7.6	1.69 V	69	29.40	17.00

REMARKS:

1. Emission Level(dBuV/m) = Raw Value(dBuV) + Correction Factor(dB/m)
2. Correction Factor(dB/m) = Antenna Factor(dB/m) + Cable Factor(dB)
3. The other emission levels were very low against the limit.
4. Margin value = Emission Level – Limit value
5. " * ": Fundamental frequency.
6. " # ": The radiated frequency is out of the restricted band.

CHANNEL	TX Channel 40	DETECTOR FUNCTION	Peak (PK)
FREQUENCY RANGE	1GHz ~ 40GHz		Average (AV)

ANTENNA POLARITY & TEST DISTANCE: HORIZONTAL AT 3 M

NO.	FREQ. (MHz)	EMISSION LEVEL (dBuV/m)	LIMIT (dBuV/m)	MARGIN (dB)	ANTENNA HEIGHT (m)	TABLE ANGLE (Degree)	RAW VALUE (dBuV)	CORRECTION FACTOR (dB/m)
1	*5200.00	108.0 PK			1.80 H	103	68.40	39.60
2	*5200.00	98.0 AV			1.80 H	103	58.40	39.60
3	5400.00	57.3 PK	74.0	-16.7	1.90 H	119	50.60	6.70
4	5400.00	46.6 AV	54.0	-7.4	1.90 H	119	39.90	6.70
5	#10400.00	58.9 PK	74.0	-15.1	1.55 H	249	41.90	17.00
6	#10400.00	45.8 AV	54.0	-8.2	1.55 H	249	28.80	17.00

ANTENNA POLARITY & TEST DISTANCE: VERTICAL AT 3 M

NO.	FREQ. (MHz)	EMISSION LEVEL (dBuV/m)	LIMIT (dBuV/m)	MARGIN (dB)	ANTENNA HEIGHT (m)	TABLE ANGLE (Degree)	RAW VALUE (dBuV)	CORRECTION FACTOR (dB/m)
1	*5200.00	120.2 PK			1.79 V	75	80.60	39.60
2	*5200.00	110.3 AV			1.79 V	75	70.70	39.60
3	5400.00	64.8 PK	74.0	-9.2	1.77 V	72	58.10	6.70
4	5400.00	52.5 AV	54.0	-1.5	1.77 V	72	45.80	6.70
5	#10400.00	59.6 PK	74.0	-14.4	1.69 V	126	42.60	17.00
6	#10400.00	46.5 AV	54.0	-7.5	1.69 V	126	29.50	17.00

REMARKS:

1. Emission Level(dBuV/m) = Raw Value(dBuV) + Correction Factor(dB/m)
2. Correction Factor(dB/m) = Antenna Factor(dB/m) + Cable Factor(dB)
3. The other emission levels were very low against the limit.
4. Margin value = Emission Level – Limit value
5. " * ": Fundamental frequency.
6. " # ": The radiated frequency is out of the restricted band.



CHANNEL	TX Channel 48	DETECTOR FUNCTION	Peak (PK)
FREQUENCY RANGE	1GHz ~ 40GHz		Average (AV)

ANTENNA POLARITY & TEST DISTANCE: HORIZONTAL AT 3 M

NO.	FREQ. (MHz)	EMISSION LEVEL (dBuV/m)	LIMIT (dBuV/m)	MARGIN (dB)	ANTENNA HEIGHT (m)	TABLE ANGLE (Degree)	RAW VALUE (dBuV)	CORRECTION FACTOR (dB/m)
1	*5240.00	106.6 PK			1.76 H	267	67.00	39.60
2	*5240.00	96.8 AV			1.76 H	267	57.20	39.60
3	5400.00	60.0 PK	74.0	-14.0	1.71 H	121	53.30	6.70
4	5400.00	47.2 AV	54.0	-6.8	1.71 H	121	40.50	6.70
5	#10480.00	60.2 PK	74.0	-13.8	1.50 H	221	42.20	18.00
6	#10480.00	47.1 AV	54.0	-6.9	1.50 H	221	29.10	18.00

ANTENNA POLARITY & TEST DISTANCE: VERTICAL AT 3 M

NO.	FREQ. (MHz)	EMISSION LEVEL (dBuV/m)	LIMIT (dBuV/m)	MARGIN (dB)	ANTENNA HEIGHT (m)	TABLE ANGLE (Degree)	RAW VALUE (dBuV)	CORRECTION FACTOR (dB/m)
1	*5240.00	121.3 PK			1.89 V	59	81.70	39.60
2	*5240.00	111.7 AV			1.89 V	59	72.10	39.60
3	5400.00	53.3 PK	74.0	-20.7	1.89 V	112	46.60	6.70
4	5400.00	52.5 AV	54.0	-1.5	1.89 V	112	45.80	6.70
5	#10480.00	60.6 PK	74.0	-13.4	1.00 V	260	42.60	18.00
6	#10480.00	47.4 AV	54.0	-6.6	1.00 V	260	29.40	18.00

REMARKS:

1. Emission Level(dBuV/m) = Raw Value(dBuV) + Correction Factor(dB/m)
2. Correction Factor(dB/m) = Antenna Factor(dB/m) + Cable Factor(dB)
3. The other emission levels were very low against the limit.
4. Margin value = Emission Level – Limit value
5. " * ": Fundamental frequency.
6. " # ": The radiated frequency is out of the restricted band.

CHANNEL	TX Channel 149	DETECTOR FUNCTION	Peak (PK)
FREQUENCY RANGE	1GHz ~ 40GHz		Average (AV)

ANTENNA POLARITY & TEST DISTANCE: HORIZONTAL AT 3 M

NO.	FREQ. (MHz)	EMISSION LEVEL (dBuV/m)	LIMIT (dBuV/m)	MARGIN (dB)	ANTENNA HEIGHT (m)	TABLE ANGLE (Degree)	RAW VALUE (dBuV)	CORRECTION FACTOR (dB/m)
1	#5714.00	59.1 PK	74.0	-14.9	1.88 H	30	51.90	7.20
2	#5714.00	48.0 AV	54.0	-6.0	1.88 H	30	40.80	7.20
3	#5722.00	65.9 PK	78.2	-12.3	1.93 H	21	58.70	7.20
4	#5725.00	62.7 PK	78.2	-15.5	1.93 H	21	55.50	7.20
5	*5745.00	106.8 PK			2.13 H	22	66.40	40.40
6	*5745.00	96.4 AV			2.13 H	22	56.00	40.40
7	11490.00	60.9 PK	74.0	-13.1	1.53 H	121	42.60	18.30
8	11490.00	47.7 AV	54.0	-6.3	1.53 H	121	29.40	18.30

ANTENNA POLARITY & TEST DISTANCE: VERTICAL AT 3 M

NO.	FREQ. (MHz)	EMISSION LEVEL (dBuV/m)	LIMIT (dBuV/m)	MARGIN (dB)	ANTENNA HEIGHT (m)	TABLE ANGLE (Degree)	RAW VALUE (dBuV)	CORRECTION FACTOR (dB/m)
1	#5714.00	67.2 PK	74.0	-6.8	1.98 V	64	60.00	7.20
2	#5714.00	52.5 AV	54.0	-1.5	1.98 V	64	45.30	7.20
3	#5722.00	77.2 PK	78.2	-1.0	1.95 V	80	70.00	7.20
4	#5725.00	66.5 PK	78.2	-11.7	1.95 V	80	59.30	7.20
5	*5745.00	119.5 PK			2.10 V	59	79.10	40.40
6	*5745.00	109.8 AV			2.10 V	59	69.40	40.40
7	11490.00	61.2 PK	74.0	-12.8	1.80 V	140	42.90	18.30
8	11490.00	48.3 AV	54.0	-5.7	1.80 V	140	30.00	18.30

REMARKS:

1. Emission Level(dBuV/m) = Raw Value(dBuV) + Correction Factor(dB/m)
2. Correction Factor(dB/m) = Antenna Factor(dB/m) + Cable Factor(dB)
3. The other emission levels were very low against the limit.
4. Margin value = Emission Level – Limit value
5. " * ": Fundamental frequency.
6. " # ": The radiated frequency is out of the restricted band.

CHANNEL	TX Channel 157	DETECTOR FUNCTION	Peak (PK)
FREQUENCY RANGE	1GHz ~ 40GHz		Average (AV)

ANTENNA POLARITY & TEST DISTANCE: HORIZONTAL AT 3 M

NO.	FREQ. (MHz)	EMISSION LEVEL (dBuV/m)	LIMIT (dBuV/m)	MARGIN (dB)	ANTENNA HEIGHT (m)	TABLE ANGLE (Degree)	RAW VALUE (dBuV)	CORRECTION FACTOR (dB/m)
1	5400.00	59.0 PK	74.0	-15.0	1.83 H	19	52.30	6.70
2	5400.00	46.9 AV	54.0	-7.1	1.83 H	19	40.20	6.70
3	*5785.00	107.0 PK			2.22 H	30	66.50	40.50
4	*5785.00	98.0 AV			2.22 H	30	57.50	40.50
5	11570.00	60.5 PK	74.0	-13.5	1.56 H	99	42.30	18.20
6	11570.00	47.3 AV	54.0	-6.7	1.56 H	99	29.10	18.20

ANTENNA POLARITY & TEST DISTANCE: VERTICAL AT 3 M

NO.	FREQ. (MHz)	EMISSION LEVEL (dBuV/m)	LIMIT (dBuV/m)	MARGIN (dB)	ANTENNA HEIGHT (m)	TABLE ANGLE (Degree)	RAW VALUE (dBuV)	CORRECTION FACTOR (dB/m)
1	5400.00	63.5 PK	74.0	-10.5	1.83 V	61	56.80	6.70
2	5400.00	53.0 AV	54.0	-1.0	1.83 V	61	46.30	6.70
3	*5785.00	119.0 PK			2.08 V	49	78.50	40.50
4	*5785.00	110.1 AV			2.08 V	49	69.60	40.50
5	11570.00	60.3 PK	74.0	-13.7	1.60 V	137	42.10	18.20
6	11570.00	48.0 AV	54.0	-6.0	1.60 V	137	29.80	18.20

REMARKS:

1. Emission Level(dBuV/m) = Raw Value(dBuV) + Correction Factor(dB/m)
2. Correction Factor(dB/m) = Antenna Factor(dB/m) + Cable Factor(dB)
3. The other emission levels were very low against the limit.
4. Margin value = Emission Level – Limit value
5. " * ": Fundamental frequency.

CHANNEL	TX Channel 165	DETECTOR FUNCTION	Peak (PK)
FREQUENCY RANGE	1GHz ~ 40GHz		Average (AV)

ANTENNA POLARITY & TEST DISTANCE: HORIZONTAL AT 3 M

NO.	FREQ. (MHz)	EMISSION LEVEL (dBuV/m)	LIMIT (dBuV/m)	MARGIN (dB)	ANTENNA HEIGHT (m)	TABLE ANGLE (Degree)	RAW VALUE (dBuV)	CORRECTION FACTOR (dB/m)
1	*5825.00	108.4 PK			2.36 H	68	67.90	40.50
2	*5825.00	99.2 AV			2.36 H	68	58.70	40.50
3	#5850.00	60.9 PK	78.2	-17.3	2.30 H	67	53.40	7.50
4	#5853.00	63.5 PK	78.2	-14.7	2.30 H	67	55.90	7.60
5	#5861.00	60.6 PK	74.0	-13.4	1.99 H	101	53.00	7.60
6	#5861.00	48.3 AV	54.0	-5.7	1.99 H	101	40.70	7.60
7	11650.00	61.5 PK	74.0	-12.5	1.58 H	139	42.80	18.70
8	11650.00	48.2 AV	54.0	-5.8	1.58 H	139	29.50	18.70

ANTENNA POLARITY & TEST DISTANCE: VERTICAL AT 3 M

NO.	FREQ. (MHz)	EMISSION LEVEL (dBuV/m)	LIMIT (dBuV/m)	MARGIN (dB)	ANTENNA HEIGHT (m)	TABLE ANGLE (Degree)	RAW VALUE (dBuV)	CORRECTION FACTOR (dB/m)
1	*5825.00	120.5 PK			2.11 V	56	80.00	40.50
2	*5825.00	111.8 AV			2.11 V	56	71.30	40.50
3	#5850.00	62.8 PK	78.2	-15.4	2.13 V	66	55.30	7.50
4	#5853.00	74.3 PK	78.2	-3.9	2.13 V	66	66.70	7.60
5	#5861.00	71.4 PK	74.0	-2.6	1.91 V	56	63.80	7.60
6	#5861.00	52.4 AV	54.0	-1.6	1.91 V	56	44.80	7.60
7	11650.00	61.5 PK	74.0	-12.5	1.80 V	211	42.80	18.70
8	11650.00	48.3 AV	54.0	-5.7	1.80 V	211	29.60	18.70

REMARKS:

1. Emission Level(dBuV/m) = Raw Value(dBuV) + Correction Factor(dB/m)
2. Correction Factor(dB/m) = Antenna Factor(dB/m) + Cable Factor(dB)
3. The other emission levels were very low against the limit.
4. Margin value = Emission Level – Limit value
5. " * ": Fundamental frequency.
6. " # ": The radiated frequency is out of the restricted band.

802.11n (HT40)

CHANNEL	TX Channel 38	DETECTOR FUNCTION	Peak (PK)
FREQUENCY RANGE	1GHz ~ 40GHz		Average (AV)

ANTENNA POLARITY & TEST DISTANCE: HORIZONTAL AT 3 M								
NO.	FREQ. (MHz)	EMISSION LEVEL (dBuV/m)	LIMIT (dBuV/m)	MARGIN (dB)	ANTENNA HEIGHT (m)	TABLE ANGLE (Degree)	RAW VALUE (dBuV)	CORRECTION FACTOR (dB/m)
1	5150.00	56.2 PK	74.0	-17.8	1.69 H	111	50.00	6.20
2	5150.00	46.0 AV	54.0	-8.0	1.69 H	111	39.80	6.20
3	*5190.00	91.8 PK			1.75 H	105	52.30	39.50
4	*5190.00	87.5 AV			1.75 H	105	48.00	39.50
5	#10380.00	58.5 PK	74.0	-15.5	1.42 H	279	41.50	17.00
6	#10380.00	45.6 AV	54.0	-8.4	1.42 H	279	28.60	17.00
ANTENNA POLARITY & TEST DISTANCE: VERTICAL AT 3 M								
NO.	FREQ. (MHz)	EMISSION LEVEL (dBuV/m)	LIMIT (dBuV/m)	MARGIN (dB)	ANTENNA HEIGHT (m)	TABLE ANGLE (Degree)	RAW VALUE (dBuV)	CORRECTION FACTOR (dB/m)
1	5150.00	69.7 PK	74.0	-4.3	1.80 V	66	63.50	6.20
2	5150.00	52.9 AV	54.0	-1.1	1.80 V	66	46.70	6.20
3	*5190.00	110.3 PK			1.52 V	275	70.80	39.50
4	*5190.00	100.4 AV			1.52 V	275	60.90	39.50
5	#10380.00	58.8 PK	74.0	-15.2	1.46 V	175	41.80	17.00
6	#10380.00	45.8 AV	54.0	-8.2	1.46 V	175	28.80	17.00

REMARKS:

1. Emission Level(dBuV/m) = Raw Value(dBuV) + Correction Factor(dB/m)
2. Correction Factor(dB/m) = Antenna Factor(dB/m) + Cable Factor(dB)
3. The other emission levels were very low against the limit.
4. Margin value = Emission Level – Limit value
5. " * ": Fundamental frequency.
6. " # ": The radiated frequency is out of the restricted band.

CHANNEL	TX Channel 46	DETECTOR FUNCTION	Peak (PK)
FREQUENCY RANGE	1GHz ~ 40GHz		Average (AV)

ANTENNA POLARITY & TEST DISTANCE: HORIZONTAL AT 3 M

NO.	FREQ. (MHz)	EMISSION LEVEL (dBuV/m)	LIMIT (dBuV/m)	MARGIN (dB)	ANTENNA HEIGHT (m)	TABLE ANGLE (Degree)	RAW VALUE (dBuV)	CORRECTION FACTOR (dB/m)
1	*5230.00	101.1 PK			1.77 H	96	61.50	39.60
2	*5230.00	91.6 AV			1.77 H	96	52.00	39.60
3	5360.00	60.0 PK	74.0	-14.0	1.56 H	142	53.60	6.40
4	5360.00	47.2 AV	54.0	-6.8	1.56 H	142	40.80	6.40
5	#10460.00	59.3 PK	74.0	-14.7	1.33 H	133	41.50	17.80
6	#10460.00	46.1 AV	54.0	-7.9	1.33 H	133	28.30	17.80

ANTENNA POLARITY & TEST DISTANCE: VERTICAL AT 3 M

NO.	FREQ. (MHz)	EMISSION LEVEL (dBuV/m)	LIMIT (dBuV/m)	MARGIN (dB)	ANTENNA HEIGHT (m)	TABLE ANGLE (Degree)	RAW VALUE (dBuV)	CORRECTION FACTOR (dB/m)
1	*5230.00	116.7 PK			1.82 V	273	77.10	39.60
2	*5230.00	106.7 AV			1.82 V	273	67.10	39.60
3	5360.00	64.1 PK	74.0	-9.9	1.78 V	70	57.70	6.40
4	5360.00	52.1 AV	54.0	-1.9	1.78 V	70	45.70	6.40
5	#10460.00	59.9 PK	74.0	-14.1	1.68 V	283	42.10	17.80
6	#10460.00	46.7 AV	54.0	-7.3	1.68 V	283	28.90	17.80

REMARKS:

1. Emission Level(dBuV/m) = Raw Value(dBuV) + Correction Factor(dB/m)
2. Correction Factor(dB/m) = Antenna Factor(dB/m) + Cable Factor(dB)
3. The other emission levels were very low against the limit.
4. Margin value = Emission Level – Limit value
5. " * ": Fundamental frequency.
6. " # ": The radiated frequency is out of the restricted band.

CHANNEL	TX Channel 151	DETECTOR FUNCTION	Peak (PK)
FREQUENCY RANGE	1GHz ~ 40GHz		Average (AV)

ANTENNA POLARITY & TEST DISTANCE: HORIZONTAL AT 3 M

NO.	FREQ. (MHz)	EMISSION LEVEL (dBuV/m)	LIMIT (dBuV/m)	MARGIN (dB)	ANTENNA HEIGHT (m)	TABLE ANGLE (Degree)	RAW VALUE (dBuV)	CORRECTION FACTOR (dB/m)
1	#5714.00	60.3 PK	74.0	-13.7	1.99 H	120	53.10	7.20
2	#5714.00	47.2 AV	54.0	-6.8	1.99 H	120	40.00	7.20
3	#5722.00	59.6 PK	78.2	-18.6	2.02 H	22	52.40	7.20
4	#5725.00	57.3 PK	78.2	-20.9	2.02 H	22	50.10	7.20
5	*5755.00	96.6 PK			2.15 H	47	56.10	40.50
6	*5755.00	87.1 AV			2.15 H	47	46.60	40.50
7	11510.00	60.4 PK	74.0	-13.6	1.51 H	93	42.20	18.20
8	11510.00	47.1 AV	54.0	-6.9	1.51 H	93	28.90	18.20

ANTENNA POLARITY & TEST DISTANCE: VERTICAL AT 3 M

NO.	FREQ. (MHz)	EMISSION LEVEL (dBuV/m)	LIMIT (dBuV/m)	MARGIN (dB)	ANTENNA HEIGHT (m)	TABLE ANGLE (Degree)	RAW VALUE (dBuV)	CORRECTION FACTOR (dB/m)
1	#5714.90	65.9 PK	74.0	-8.1	1.92 V	75	58.70	7.20
2	#5714.90	52.7 AV	54.0	-1.3	1.92 V	75	45.50	7.20
3	#5722.00	72.6 PK	78.2	-5.6	2.03 V	99	65.40	7.20
4	#5725.00	60.7 PK	78.2	-17.5	2.03 V	99	53.50	7.20
5	*5755.00	108.7 PK			2.06 V	98	68.20	40.50
6	*5755.00	99.2 AV			2.06 V	98	58.70	40.50
7	11510.00	60.7 PK	74.0	-13.3	1.76 V	83	42.50	18.20
8	11510.00	47.4 AV	54.0	-6.6	1.76 V	83	29.20	18.20

REMARKS:

1. Emission Level(dBuV/m) = Raw Value(dBuV) + Correction Factor(dB/m)
2. Correction Factor(dB/m) = Antenna Factor(dB/m) + Cable Factor(dB)
3. The other emission levels were very low against the limit.
4. Margin value = Emission Level – Limit value
5. " * ": Fundamental frequency.
6. " # ": The radiated frequency is out of the restricted band.

CHANNEL	TX Channel 159	DETECTOR FUNCTION	Peak (PK)
FREQUENCY RANGE	1GHz ~ 40GHz		Average (AV)

ANTENNA POLARITY & TEST DISTANCE: HORIZONTAL AT 3 M

NO.	FREQ. (MHz)	EMISSION LEVEL (dBuV/m)	LIMIT (dBuV/m)	MARGIN (dB)	ANTENNA HEIGHT (m)	TABLE ANGLE (Degree)	RAW VALUE (dBuV)	CORRECTION FACTOR (dB/m)
1	5400.00	59.6 PK	74.0	-14.4	1.98 H	148	52.90	6.70
2	5400.00	47.1 AV	54.0	-6.9	1.98 H	148	40.40	6.70
3	*5795.00	103.2 PK			2.07 H	35	62.70	40.50
4	*5795.00	93.6 AV			2.07 H	35	53.10	40.50
5	#5850.00	56.0 PK	78.2	-22.2	1.91 H	79	48.50	7.50
6	#5853.00	57.6 PK	78.2	-20.6	1.91 H	79	50.00	7.60
7	#5861.00	59.5 PK	74.0	-14.5	1.96 H	133	51.90	7.60
8	#5861.00	47.7 AV	54.0	-6.3	1.96 H	133	40.10	7.60
9	11590.00	60.3 PK	74.0	-13.7	1.56 H	37	42.00	18.30
10	11590.00	47.0 AV	54.0	-7.0	1.56 H	37	28.70	18.30

ANTENNA POLARITY & TEST DISTANCE: VERTICAL AT 3 M

NO.	FREQ. (MHz)	EMISSION LEVEL (dBuV/m)	LIMIT (dBuV/m)	MARGIN (dB)	ANTENNA HEIGHT (m)	TABLE ANGLE (Degree)	RAW VALUE (dBuV)	CORRECTION FACTOR (dB/m)
1	5400.00	63.8 PK	74.0	-10.2	1.83 V	71	57.10	6.70
2	5400.00	52.5 AV	54.0	-1.5	1.83 V	71	45.80	6.70
3	*5795.00	117.2 PK			2.47 V	66	76.70	40.50
4	*5795.00	108.2 AV			2.47 V	66	67.70	40.50
5	#5850.00	58.5 PK	78.2	-19.7	1.90 V	69	51.00	7.50
6	#5853.00	65.2 PK	78.2	-13.0	1.90 V	69	57.60	7.60
7	#5861.00	62.7 PK	74.0	-11.3	1.94 V	77	55.10	7.60
8	#5861.00	50.2 AV	54.0	-3.8	1.94 V	77	42.60	7.60
9	11590.00	60.9 PK	74.0	-13.1	1.67 V	123	42.60	18.30
10	11590.00	47.6 AV	54.0	-6.4	1.67 V	123	29.30	18.30

REMARKS:

1. Emission Level(dBuV/m) = Raw Value(dBuV) + Correction Factor(dB/m)
2. Correction Factor(dB/m) = Antenna Factor(dB/m) + Cable Factor(dB)
3. The other emission levels were very low against the limit.
4. Margin value = Emission Level – Limit value
5. " * ": Fundamental frequency.
6. " # ": The radiated frequency is out of the restricted band.

Below 1GHz worst-case data:

802.11a

CHANNEL	TX Channel 40	DETECTOR FUNCTION	Quasi-Peak (QP)
FREQUENCY RANGE	30MHz ~ 1GHz		

ANTENNA POLARITY & TEST DISTANCE: HORIZONTAL AT 3 M								
NO.	FREQ. (MHz)	EMISSION LEVEL (dBuV/m)	LIMIT (dBuV/m)	MARGIN (dB)	ANTENNA HEIGHT (m)	TABLE ANGLE (Degree)	RAW VALUE (dBuV)	CORRECTION FACTOR (dB/m)
1	99.89	39.9 QP	43.5	-3.6	1.99 H	12	58.80	-18.90
2	132.95	39.2 QP	43.5	-4.3	1.99 H	355	54.50	-15.30
3	166.49	41.9 QP	43.5	-1.6	2.00 H	12	56.10	-14.20
4	239.88	37.0 QP	46.0	-9.0	1.00 H	153	52.00	-15.00
5	300.16	44.3 QP	46.0	-1.7	1.00 H	132	56.70	-12.40
6	500.42	44.9 QP	46.0	-1.1	1.49 H	147	53.20	-8.30
ANTENNA POLARITY & TEST DISTANCE: VERTICAL AT 3 M								
NO.	FREQ. (MHz)	EMISSION LEVEL (dBuV/m)	LIMIT (dBuV/m)	MARGIN (dB)	ANTENNA HEIGHT (m)	TABLE ANGLE (Degree)	RAW VALUE (dBuV)	CORRECTION FACTOR (dB/m)
1	99.89	38.7 QP	43.5	-4.8	1.00 V	81	57.60	-18.90
2	166.00	39.4 QP	43.5	-4.1	1.00 V	127	53.60	-14.20
3	239.88	34.5 QP	46.0	-11.5	1.99 V	172	49.50	-15.00
4	300.16	38.5 QP	46.0	-7.5	1.00 V	344	50.90	-12.40
5	499.51	44.1 QP	46.0	-1.9	1.00 V	270	52.40	-8.30
6	747.34	36.4 QP	46.0	-9.6	1.00 V	7	39.60	-3.20

REMARKS:

1. Emission Level(dBuV/m) = Raw Value(dBuV) + Correction Factor(dB/m)
2. Correction Factor(dB/m) = Antenna Factor(dB/m) + Cable Factor(dB)
3. The other emission levels were very low against the limit.
4. Margin value = Emission Level – Limit value

4.2 Conducted Emission Measurement

4.2.1 Limits of Conducted Emission Measurement

Frequency (MHz)	Conducted Limit (dBuV)	
	Quasi-peak	Average
0.15 - 0.5	66 - 56	56 - 46
0.50 - 5.0	56	46
5.0 - 30.0	60	50

- Note:** 1. The lower limit shall apply at the transition frequencies.
 2. The limit decreases in line with the logarithm of the frequency in the range of 0.15 to 0.50MHz.

4.2.2 Test Instruments

Description & Manufacturer	Model No.	Serial No.	Date Of Calibration	Due Date Of Calibration
Test Receiver ROHDE & SCHWARZ	ESCI	100613	Nov. 11, 2014	Nov. 10, 2015
RF signal cable (with 10dB PAD) Woken	5D-FB	Cable-cond1-01	Dec. 26, 2014	Dec. 25, 2015
LISN ROHDE & SCHWARZ (EUT)	ESH3-Z5	835239/001	Feb. 26, 2015	Feb. 25, 2016
LISN ROHDE & SCHWARZ (Peripheral)	ESH3-Z5	100311	Jul. 24, 2015	Jul. 23, 2016
Software ADT	BV ADT_Cond_ V7.3.7.3	NA	NA	NA

- Note:** 1. The calibration interval of the above test instruments is 12 months and the calibrations are traceable to NML/ROC and NIST/USA.
 2. The test was performed in HwaYa Shielded Room 1.
 3. The VCCI Site Registration No. is C-2040.

4.2.3 Test Procedures

- The EUT was placed 0.4 meters from the conducting wall of the shielded room with EUT being connected to the power mains through a line impedance stabilization network (LISN). Other support units were connected to the power mains through another LISN. The two LISNs provide 50 ohm/ 50uH of coupling impedance for the measuring instrument.
- Both lines of the power mains connected to the EUT were checked for maximum conducted interference.
- The frequency range from 150kHz to 30MHz was searched. Emission levels under (Limit - 20dB) was not recorded.

NOTE: The resolution bandwidth and video bandwidth of test receiver is 9kHz for quasi-peak detection (QP) and average detection (AV) at frequency 0.15MHz-30MHz.

4.2.4 Deviation from Test Standard

No deviation.

4.2.5 Test Setup

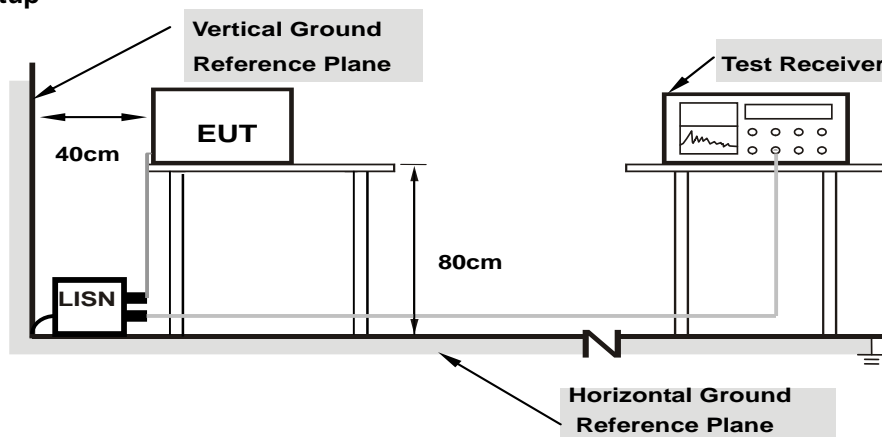

Note: 1.Support units were connected to second LISN.

For the actual test configuration, please refer to the attached file (Test Setup Photo).

4.2.6 EUT Operating Conditions

Same as 4.1.6.

4.2.7 Test Results

Phase	Line (L)	Detector Function	Quasi-Peak (QP) / Average (AV)
-------	----------	-------------------	--------------------------------

No	Freq. [MHz]	Corr. Factor (dB)	Reading Value [dB (uV)]		Emission Level [dB (uV)]		Limit [dB (uV)]		Margin (dB)	
			Q.P.	AV.	Q.P.	AV.	Q.P.	AV.	Q.P.	AV.
			1	0.17737	9.83	19.03	7.75	28.86	17.58	64.61
2	0.22791	9.85	22.91	22.46	32.76	32.31	62.53	52.53	-29.77	-20.22
3	0.52130	9.89	28.48	25.85	38.37	35.74	56.00	46.00	-17.63	-10.26
4	1.03366	9.93	17.70	14.47	27.63	24.40	56.00	46.00	-28.37	-21.60
5	5.69829	10.24	10.10	3.61	20.34	13.85	60.00	50.00	-39.66	-36.15
6	20.81435	11.12	34.35	27.52	45.47	38.64	60.00	50.00	-14.53	-11.36

REMARKS:

1. Q.P. and AV. are abbreviations of quasi-peak and average individually.
2. The emission levels of other frequencies were very low against the limit.
3. Margin value = Emission level - Limit value
4. Correction factor = Insertion loss + Cable loss
5. Emission Level = Correction Factor + Reading Value.

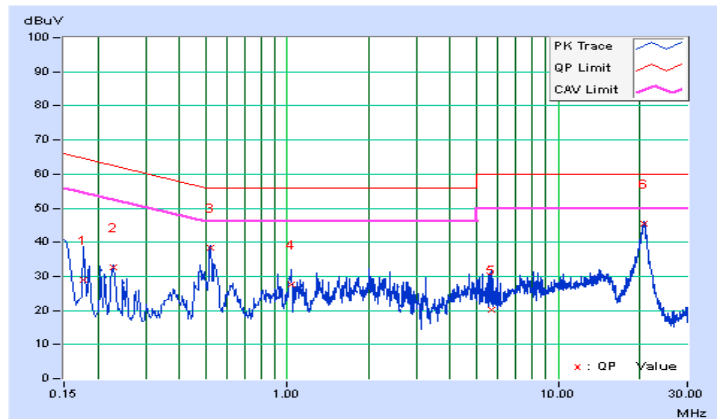

Phase	Neutral (N)	Detector Function	Quasi-Peak (QP) / Average (AV)
-------	-------------	-------------------	--------------------------------

No	Freq. [MHz]	Corr. Factor (dB)	Reading Value [dB (uV)]		Emission Level [dB (uV)]		Limit [dB (uV)]		Margin (dB)	
			Q.P.	AV.	Q.P.	AV.	Q.P.	AV.	Q.P.	AV.
			1	0.16173	9.82	20.64	7.71	30.46	17.53	65.37
2	0.22820	9.84	22.11	21.85	31.95	31.69	62.51	52.51	-30.57	-20.83
3	0.52145	9.89	27.81	26.35	37.70	36.24	56.00	46.00	-18.30	-9.76
4	2.02289	9.99	17.34	9.45	27.33	19.44	56.00	46.00	-28.67	-26.56
5	14.79295	10.70	16.11	9.52	26.81	20.22	60.00	50.00	-33.19	-29.78
6	20.12228	10.92	16.31	10.21	27.23	21.13	60.00	50.00	-32.77	-28.87

REMARKS:

1. Q.P. and AV. are abbreviations of quasi-peak and average individually.
2. The emission levels of other frequencies were very low against the limit.
3. Margin value = Emission level - Limit value
4. Correction factor = Insertion loss + Cable loss
5. Emission Level = Correction Factor + Reading Value.

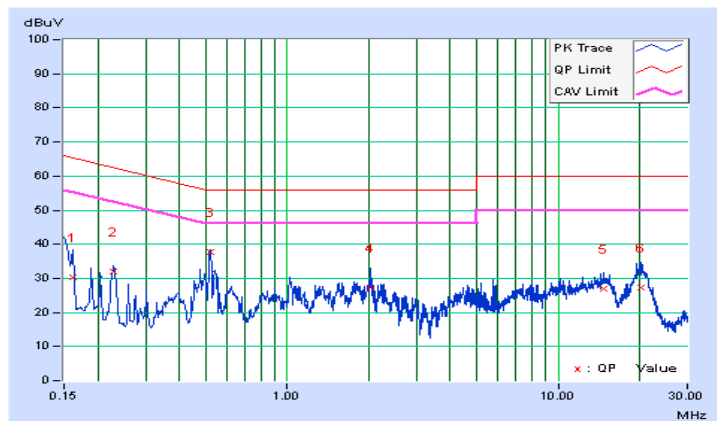

4.3 Transmit Power Measurement

4.3.1 Limits of Transmit Power Measurement

Operation Band	EUT Category		LIMIT
U-NII-1		Outdoor Access Point	1 Watt (30 dBm) (Max. e.i.r.p \leq 125mW(21 dBm) at any elevation angle above 30 degrees as measured from the horizon)
		Fixed point-to-point Access Point	1 Watt (30 dBm)
	√	Indoor Access Point	1 Watt (30 dBm)
		Mobile and Portable client device	250mW (24 dBm)
U-NII-2A	-		250mW (24 dBm) or 11 dBm+10 log B*
U-NII-2C	-		250mW (24 dBm) or 11 dBm+10 log B*
U-NII-3	√		1 Watt (30 dBm)

*B is the 26 dB emission bandwidth in megahertz

Per KDB 662911 Method of conducted output power measurement on IEEE 802.11 devices,

Array Gain = 0 dB (i.e., no array gain) for $N_{ANT} \leq 4$;

Array Gain = 0 dB (i.e., no array gain) for channel widths ≥ 40 MHz for any N_{ANT} ;

Array Gain = $5 \log(N_{ANT}/N_{SS})$ dB or 3 dB, whichever is less for 20-MHz channel widths with $N_{ANT} \geq 5$.

For power measurements on all other devices: Array Gain = $10 \log(N_{ANT}/N_{SS})$ dB.

4.3.2 Test Setup

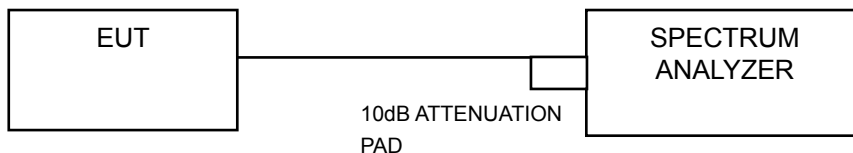
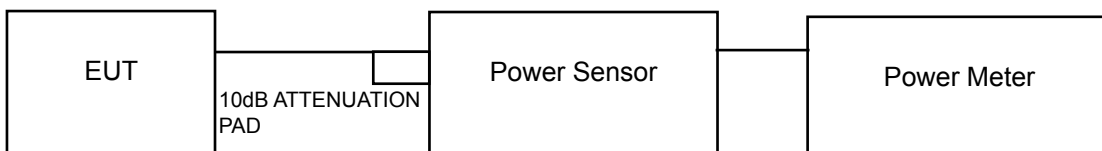

4.3.3 Test Instruments

Refer to section 4.1.2 to get information of above instrument.

4.3.4 Test Procedure

FOR AVERAGE POWER MEASUREMENT

For 802.11a, 802.11n (HT20), 802.11n (HT40)

Method PM is used to perform output power measurement, trigger and gating function of wide band power meter is enabled to measure max output power of TX on burst. Duty factor is not added to measured value.

4.3.5 Deviation from Test Standard

No deviation.

4.3.6 EUT Operating Conditions

The software provided by client to enable the EUT under transmission condition continuously at lowest, middle and highest channel frequencies individually.

4.3.7 Test Result

POWER OUTPUT:

802.11a

Channel	Frequency (MHz)	Maximum Conducted Power (dBm)			Maximum Conducted Power (mW)	Maximum Conducted Power (dBm)	Power Limit (dBm)	Pass / Fail
		Chain 0	Chain 1	Chain 2				
36	5180	18.33	17.64	18.18	191.919	22.83	29.00	Pass
40	5200	20.31	19.12	20.58	303.345	24.82	29.00	Pass
48	5240	19.93	18.95	19.11	258.395	24.12	29.00	Pass
149	5745	17.90	17.63	17.16	171.603	22.35	29.00	Pass
157	5785	18.56	17.79	16.95	181.441	22.59	29.00	Pass
165	5825	18.44	19.66	17.90	223.953	23.50	29.00	Pass

*Gain: 7dBi > 6dBi, power limit shall be reduced to 30-(7-6) = 29.0dBm.

802.11n (HT20)

Channel	Frequency (MHz)	Maximum Conducted Power (dBm)			Maximum Conducted Power (mW)	Maximum Conducted Power (dBm)	Power Limit (dBm)	Pass / Fail
		Chain 0	Chain 1	Chain 2				
36	5180	19.03	17.92	18.93	220.090	23.43	29.00	Pass
40	5200	19.81	19.02	19.35	261.617	24.18	29.00	Pass
48	5240	20.13	19.32	19.03	268.529	24.29	29.00	Pass
149	5745	15.92	16.50	16.13	124.772	20.96	29.00	Pass
157	5785	17.87	18.08	16.94	174.935	22.43	29.00	Pass
165	5825	17.64	18.61	17.04	181.269	22.58	29.00	Pass

*Gain: 7dBi > 6dBi, power limit shall be reduced to 30-(7-6) = 29.0dBm.

802.11n (HT40)

Channel	Frequency (MHz)	Maximum Conducted Power (dBm)			Maximum Conducted Power (mW)	Maximum Conducted Power (dBm)	Power Limit (dBm)	Pass / Fail
		Chain 0	Chain 1	Chain 2				
38	5190	12.98	11.46	12.76	52.737	17.22	29.00	Pass
46	5230	17.98	17.14	18.21	180.789	22.57	29.00	Pass
151	5755	10.66	11.13	10.36	35.477	15.50	29.00	Pass
159	5795	17.68	17.85	16.43	163.522	22.14	29.00	Pass

*Gain: 7dBi > 6dBi, power limit shall be reduced to 30-(7-6) = 29.0dBm.

26dB BANDWIDTH:
802.11a

Channel	Frequency (MHz)	26dBc Bandwidth (MHz)			Pass / Fail
		Chain 0	Chain 1	Chain 2	
36	5180	23.48	22.12	23.31	Pass
40	5200	23.31	22.22	23.14	Pass
48	5240	23.28	21.79	22.41	Pass

802.11n (HT20)

Channel	Frequency (MHz)	26dBc Bandwidth (MHz)			Pass / Fail
		Chain 0	Chain 1	Chain 2	
36	5180	24.80	23.11	23.98	Pass
40	5200	23.61	22.53	23.67	Pass
48	5240	23.31	22.28	24.19	Pass

802.11n (HT40)

Channel	Frequency (MHz)	26dBc Bandwidth (MHz)			Pass / Fail
		Chain 0	Chain 1	Chain 2	
38	5190	48.20	48.28	47.02	Pass
46	5230	49.18	48.62	48.53	Pass

Spectrum Plot of Worst Value

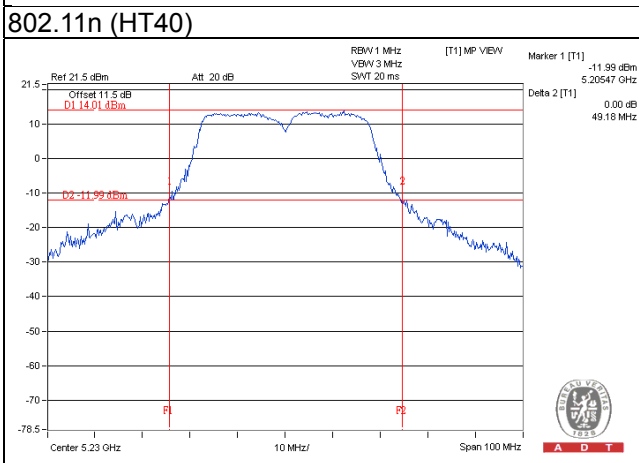
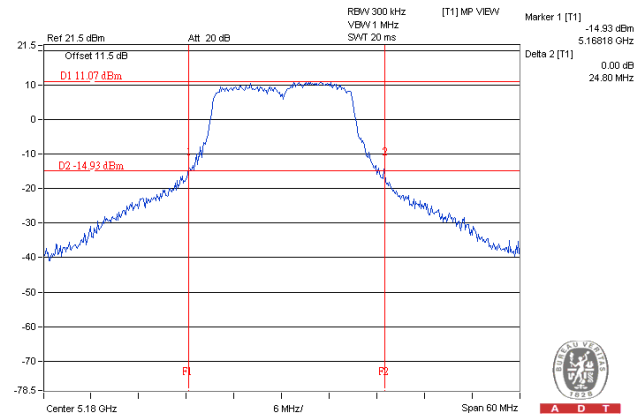
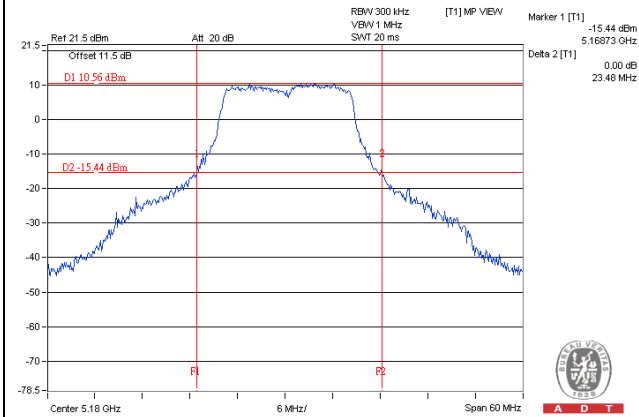

OCCUPIED BANDWIDTH:
802.11a

Channel	Frequency (MHz)	Occupied Bandwidth (MHz)		
		Chain 0	Chain 1	Chain 2
36	5180	16.92	16.68	16.92
40	5200	16.68	16.68	16.68
48	5240	16.80	16.68	16.92
149	5745	16.68	16.56	16.56
157	5785	16.80	16.68	16.68
165	5825	16.80	16.68	16.80

802.11n (HT20)

Channel	Frequency (MHz)	Occupied Bandwidth (MHz)		
		Chain 0	Chain 1	Chain 2
36	5180	17.88	18.00	17.88
40	5200	17.88	17.76	17.88
48	5240	17.88	17.76	17.88
149	5745	17.88	18.00	17.88
157	5785	17.88	17.88	17.76
165	5825	17.88	17.88	18.00

802.11n (HT40)

Channel	Frequency (MHz)	Occupied Bandwidth (MHz)		
		Chain 0	Chain 1	Chain 2
38	5190	36.72	36.60	36.84
46	5230	36.72	36.48	36.84
151	5755	36.84	36.84	36.72
159	5795	36.84	36.84	36.72

Spectrum Plot of Worst Value

802.11a

802.11n (HT20)

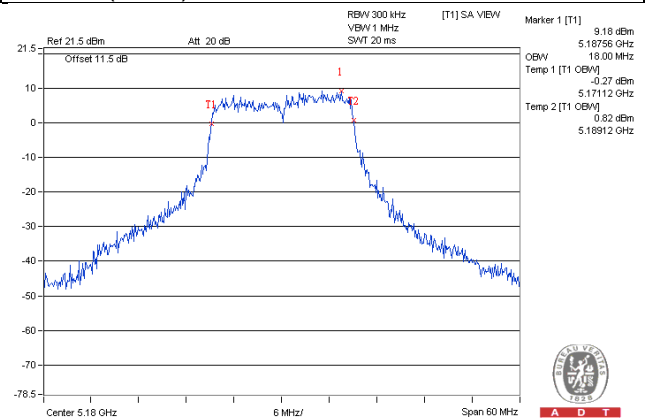
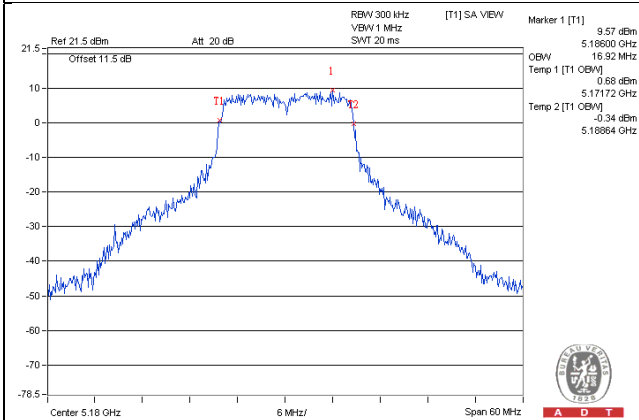

802.11n (HT40)

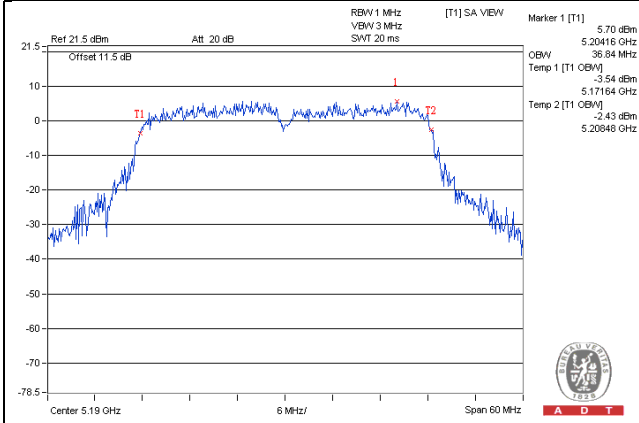

4.4 Peak Power Spectral Density Measurement

4.4.1 Limits of Peak Power Spectral Density Measurement

Operation Band	EUT Category		LIMIT
U-NII-1		Outdoor Access Point	17dBm/ MHz
		Fixed point-to-point Access Point	
	√	Indoor Access Point	
		Mobile and Portable client device	11dBm/ MHz
U-NII-2A	-		11dBm/ MHz
U-NII-2C	-		11dBm/ MHz
U-NII-3	√		30dBm/ 500kHz

4.4.2 Test Setup

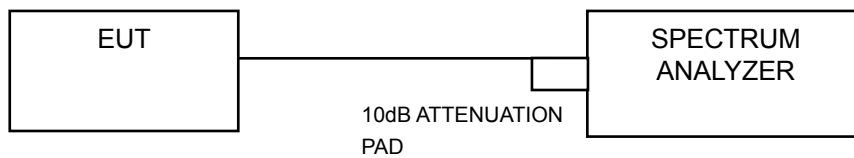

4.4.3 Test Instruments

Refer to section 4.1.2 to get information of above instrument.

4.4.4 Test Procedures

For U-NII-1 band:

Using method SA-2

- a. Set span to encompass the entire emission bandwidth (EBW) of the signal.
- b. Set RBW = 1 MHz, Set VBW \geq 3 MHz, Detector = RMS
- c. Sweep time = auto, trigger set to "free run".
- d. Trace average at least 100 traces in power averaging mode.
- e. Record the max value and add 10 log (1/duty cycle)

For U-NII-3 band:

- a. Set span to encompass the entire emission bandwidth (EBW) of the signal.
- b. Set RBW = 300 kHz, Set VBW \geq 1 MHz, Detector = RMS
- c. Use the peak marker function to determine the maximum power level in any 300 kHz band segment within the fundamental EBW.
- d. Scale the observed power level to an equivalent value in 500 kHz by adjusting (reducing) the measured power by a bandwidth correction factor (BWCF) where $BWCF = 10\log(500\text{ kHz}/300\text{kHz})$
- e. Sweep time = auto, trigger set to "free run".
- f. Trace average at least 100 traces in power averaging mode.
- g. Record the max value and add 10 log (1/duty cycle)

4.4.5 Deviation from Test Standard

No deviation.

4.4.6 EUT Operating Conditions

Same as Item 4.3.6.

4.4.7 Test Results

For U-NII-1 Band

802.11a

Chan.	Frequency (MHz)	PSD (dBm/MHz)			Total PSD W/O Duty Factor (dBm/MHz)	Duty Factor	Total PSD With Duty Factor (dBm/MHz)	Maximum Limit (dBm/MHz)	Pass / Fail
		Chain 0	Chain 1	Chain 2					
36	5180	4.71	5.37	5.12	9.85	0.20	10.05	11.23	Pass
40	5200	5.96	6.66	4.96	10.69	0.20	10.89	11.23	Pass
48	5240	6.03	5.69	3.90	10.08	0.20	10.28	11.23	Pass

Note:

- Method 1 of power density measurement of KDB 662911 is using for calculating total power density. Total power density is summing entire spectra across corresponding frequency bins on the various outputs by computer.
- For U-NII-1:** Directional gain = 7dBi + 10log(3) = 11.77dBi > 6dBi, so the power density limit shall be reduced to 17-(11.77-6) = 11.23dBm.
- Refer to section 3.3 for duty cycle spectrum plot.

802.11n (HT20)

Chan.	Frequency (MHz)	PSD (dBm/MHz)			Total PSD W/O Duty Factor (dBm/MHz)	Duty Factor	Total PSD With Duty Factor (dBm/MHz)	Maximum Limit (dBm/MHz)	Pass / Fail
		Chain 0	Chain 1	Chain 2					
36	5180	6.39	5.29	3.83	10.06	0.22	10.28	11.23	Pass
40	5200	6.38	6.28	4.68	10.62	0.22	10.84	11.23	Pass
48	5240	5.88	5.88	5.36	10.48	0.22	10.70	11.23	Pass

Note:

- Method 1 of power density measurement of KDB 662911 is using for calculating total power density. Total power density is summing entire spectra across corresponding frequency bins on the various outputs by computer.
- For U-NII-1:** Directional gain = 7dBi + 10log(3) = 11.77dBi > 6dBi, so the power density limit shall be reduced to 17-(11.77-6) = 11.23dBm.
- Refer to section 3.3 for duty cycle spectrum plot.

802.11n (HT40)

Chan.	Frequency (MHz)	PSD (dBm/MHz)			Total PSD W/O Duty Factor (dBm/MHz)	Duty Factor	Total PSD With Duty Factor (dBm/MHz)	Maximum Limit (dBm/MHz)	Pass / Fail
		Chain 0	Chain 1	Chain 2					
38	5190	-2.92	-4.06	-4.93	0.88	0.35	1.23	11.23	Pass
46	5230	2.78	1.10	1.55	6.64	0.35	6.99	11.23	Pass

Note:

- Method 1 of power density measurement of KDB 662911 is using for calculating total power density. Total power density is summing entire spectra across corresponding frequency bins on the various outputs by computer.
- For **U-NII-1**: Directional gain = $7\text{dBi} + 10\log(3) = 11.77\text{dBi} > 6\text{dBi}$, so the power density limit shall be reduced to $17 - (11.77 - 6) = 11.23\text{dBm}$.
- Refer to section 3.3 for duty cycle spectrum plot.

Spectrum Plot of Worst Value

802.11a / CH 40 / Chain 1

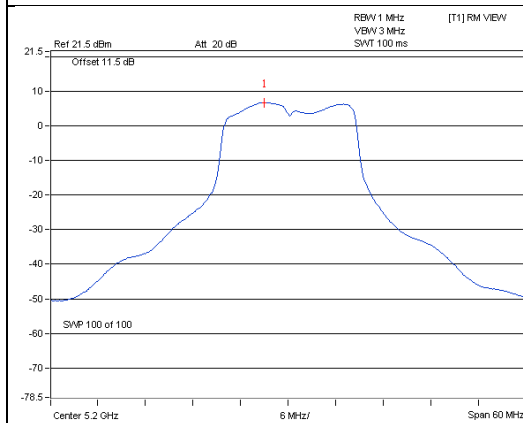

802.11n (HT20) / CH 36 / Chain 0

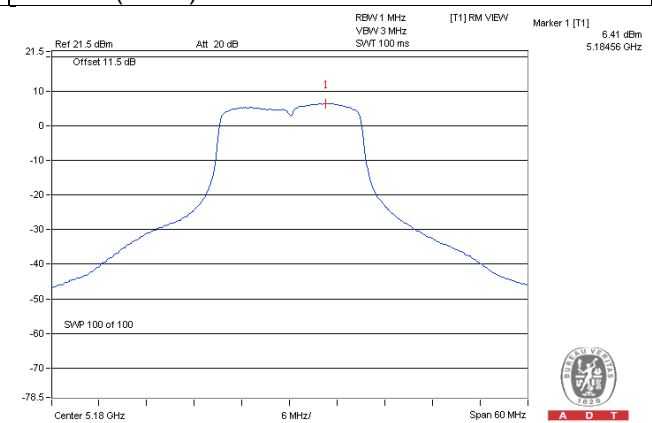

802.11n (HT40) / CH 46 / Chain 0

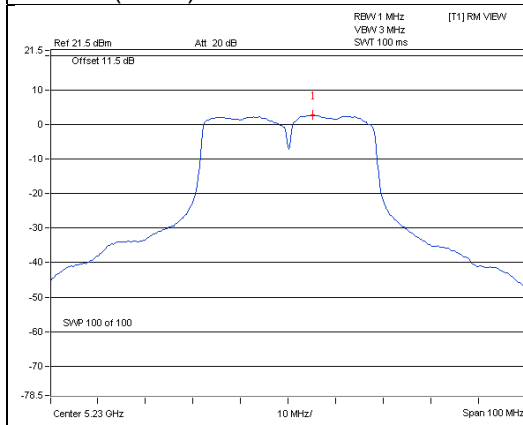

For U-NII-3 Band

802.11a

TX chain	Channel	Freq. (MHz)	PSD (dBm/300kHz)	PSD (dBm/500kHz)	10 log (N=3) dB	Duty Factor	Total PSD (dBm/500kHz)	Limit (dBm/500kHz)	Pass /Fail
0	149	5745	3.30	5.52	4.77	0.20	10.49	24.23	Pass
	157	5785	2.36	4.58	4.77	0.20	9.55	24.23	Pass
	165	5825	2.52	4.74	4.77	0.20	9.71	24.23	Pass
1	149	5745	1.50	3.72	4.77	0.20	8.69	24.23	Pass
	157	5785	1.47	3.69	4.77	0.20	8.66	24.23	Pass
	165	5825	3.06	5.28	4.77	0.20	10.25	24.23	Pass
2	149	5745	1.23	3.45	4.77	0.20	8.42	24.23	Pass
	157	5785	1.65	3.87	4.77	0.20	8.84	24.23	Pass
	165	5825	1.34	3.56	4.77	0.20	8.53	24.23	Pass

Note:

- Directional gain = 7dBi + 10log(3) = 11.77dBi > 6dBi, so the power density limit shall be reduced to 30-(11.77-6) = 24.23dBm.
- Refer to section 3.3 for duty cycle spectrum plot.

802.11n (HT20)

TX chain	Channel	Freq. (MHz)	PSD (dBm/300kHz)	PSD (dBm/500kHz)	10 log (N=3) dB	Duty Factor	Total PSD (dBm/500kHz)	Limit (dBm/500kHz)	Pass /Fail
0	149	5745	0.47	2.69	4.77	0.22	7.68	24.23	Pass
	157	5785	2.20	4.42	4.77	0.22	9.41	24.23	Pass
	165	5825	1.66	3.88	4.77	0.22	8.87	24.23	Pass
1	149	5745	-0.46	1.76	4.77	0.22	6.75	24.23	Pass
	157	5785	2.60	4.82	4.77	0.22	9.81	24.23	Pass
	165	5825	1.30	3.52	4.77	0.22	8.51	24.23	Pass
2	149	5745	-0.38	1.84	4.77	0.22	6.83	24.23	Pass
	157	5785	1.42	3.64	4.77	0.22	8.63	24.23	Pass
	165	5825	0.19	2.41	4.77	0.22	7.40	24.23	Pass

Note:

- Directional gain = 7dBi + 10log(3) = 11.77dBi > 6dBi, so the power density limit shall be reduced to 30-(11.77-6) = 24.23dBm.
- Refer to section 3.3 for duty cycle spectrum plot.

802.11n (HT40)

TX chain	Channel	Freq. (MHz)	PSD (dBm/300kHz)	PSD (dBm/500kHz)	10 log (N=3) dB	Duty Factor	Total PSD (dBm/500kHz)	Limit (dBm/500kHz)	Pass /Fail
0	151	5755	-7.06	-4.84	4.77	0.35	0.28	24.23	Pass
	159	5795	-1.39	0.83	4.77	0.35	5.95	24.23	Pass
1	151	5755	-6.56	-4.34	4.77	0.35	0.78	24.23	Pass
	159	5795	-0.60	1.62	4.77	0.35	6.74	24.23	Pass
2	151	5755	-7.99	-5.77	4.77	0.35	-0.65	24.23	Pass
	159	5795	-2.13	0.09	4.77	0.35	5.21	24.23	Pass

Note:

1. Directional gain = $7\text{dBi} + 10\log(3) = 11.77\text{dBi} > 6\text{dBi}$, so the power density limit shall be reduced to $30 - (11.77 - 6) = 24.23\text{dBm}$.
2. Refer to section 3.3 for duty cycle spectrum plot.

Spectrum Plot of Worst Value

802.11a

802.11n (HT20)

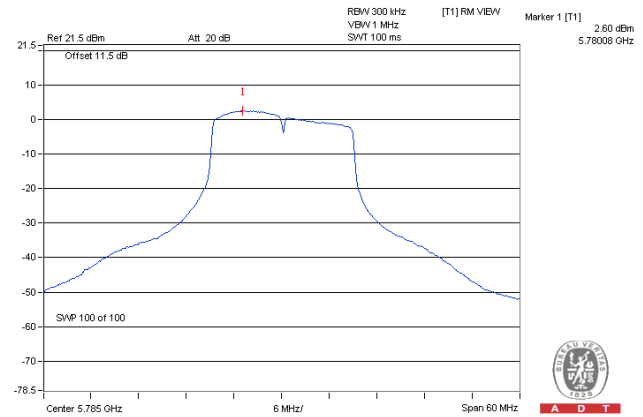
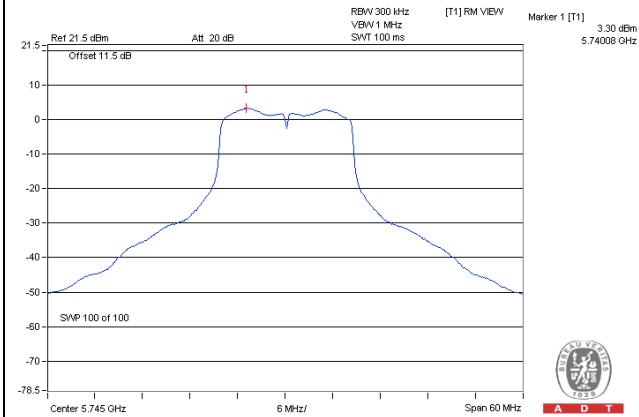

802.11n (HT40)

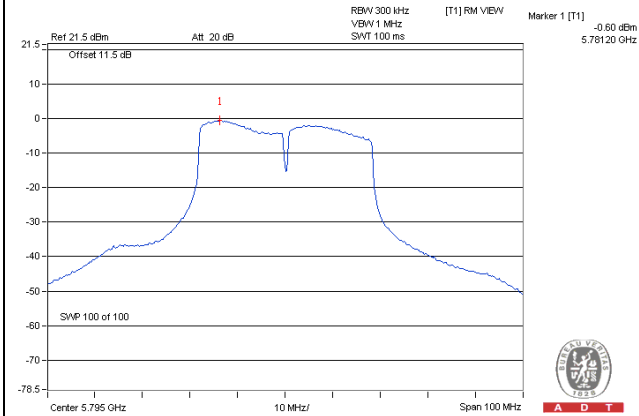

4.5 Frequency Stability

4.5.1 Limits of Frequency Stability Measurement

The frequency of the carrier signal shall be maintained within band of operation

4.5.2 Test Setup

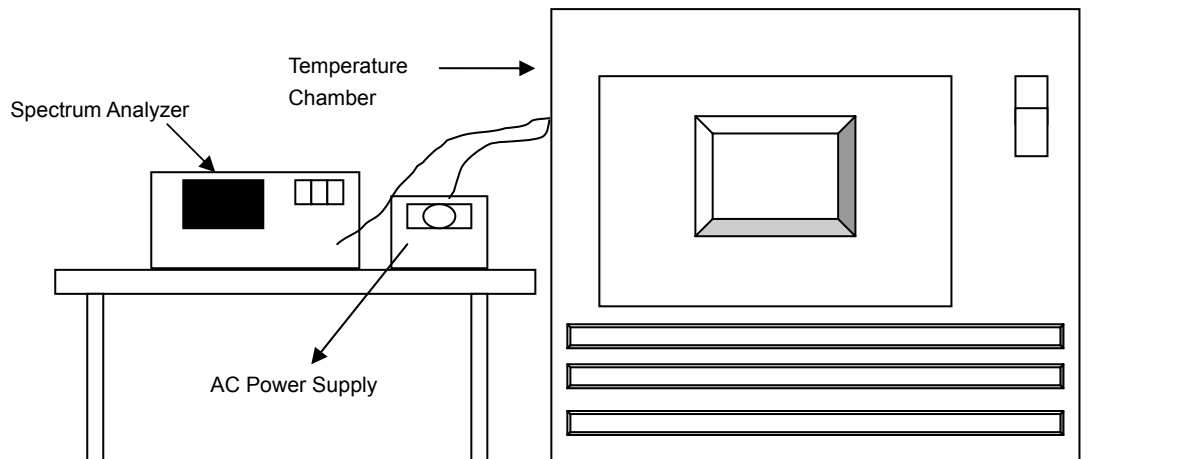

4.5.3 Test Instruments

Refer to section 4.1.2 to get information of above instrument.

4.5.4 Test Procedure

- a. The EUT was placed inside the environmental test chamber and powered by nominal AC voltage.
- b. Turn the EUT on and couple its output to a spectrum analyzer.
- c. Turn the EUT off and set the chamber to the highest temperature specified.
- d. Allow sufficient time (approximately 30 min) for the temperature of the chamber to stabilize, turn the EUT on and measure the operating frequency after 2, 5, and 10 minutes.
- e. Repeat step 2 and 3 with the temperature chamber set to the lowest temperature.
- f. The test chamber was allowed to stabilize at +20 degree C for a minimum of 30 minutes. The supply voltage was then adjusted on the EUT from 85% to 115% and the frequency record.

4.5.5 Deviation from Test Standard

No deviation.

4.5.6 EUT Operating Condition

Set the EUT transmit at un-modulation mode to test frequency stability.

4.5.7 Test Results

Frequency Stability Versus Temp.									
Operating Frequency: 5180MHz									
Temp. (°C)	Power Supply (Vac)	0 Minute		2 Minute		5 Minute		10 Minute	
		Measured Frequency (MHz)	Frequency Drift (%)	Measured Frequency (MHz)	Frequency Drift (%)	Measured Frequency (MHz)	Frequency Drift (%)	Measured Frequency (MHz)	Frequency Drift (%)
50	120	5180.0016	0.00003	5180.0003	0.00001	5180.0004	0.00001	5179.9992	-0.00002
40	120	5179.9850	-0.00029	5179.9826	-0.00034	5179.9844	-0.00030	5179.9842	-0.00031
30	120	5180.0165	0.00032	5180.0132	0.00025	5180.0138	0.00027	5180.0151	0.00029
20	120	5180.0009	0.00002	5180.0003	0.00001	5180.0004	0.00001	5179.9976	-0.00005
10	120	5180.0184	0.00036	5180.0202	0.00039	5180.0190	0.00037	5180.0183	0.00035
0	120	5179.9900	-0.00019	5179.9886	-0.00022	5179.9895	-0.00020	5179.9857	-0.00028
-10	120	5180.0233	0.00045	5180.0272	0.00053	5180.0239	0.00046	5180.0250	0.00048
-20	120	5179.9974	-0.00005	5179.9929	-0.00014	5179.9977	-0.00004	5179.9962	-0.00007
-30	120	5180.0081	0.00016	5180.0079	0.00015	5180.0075	0.00014	5180.0101	0.00019

Frequency Stability Versus Temp.									
Operating Frequency: 5180MHz									
Temp. (°C)	Power Supply (Vac)	0 Minute		2 Minute		5 Minute		10 Minute	
		Measured Frequency (MHz)	Frequency Drift (%)	Measured Frequency (MHz)	Frequency Drift (%)	Measured Frequency (MHz)	Frequency Drift (%)	Measured Frequency (MHz)	Frequency Drift (%)
20	138	5180.0003	0.00001	5180.0005	0.00001	5179.9997	-0.00001	5179.9976	-0.00005
	120	5180.0009	0.00002	5180.0003	0.00001	5180.0004	0.00001	5179.9976	-0.00005
	102	5180.0001	0.00000	5180.0001	0.00000	5180.0006	0.00001	5179.9980	-0.00004

4.6 6dB Bandwidth Measurement

4.6.1 Limits of 6dB Bandwidth Measurement

The minimum of 6dB Bandwidth Measurement is 0.5MHz.

4.6.2 Test Setup

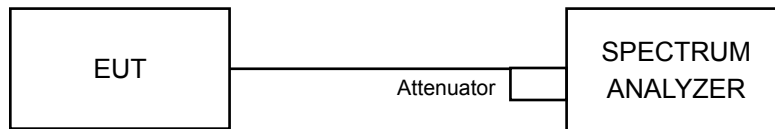

4.6.3 Test Instruments

Refer to section 4.1.2 to get information of above instrument.

4.6.4 Test Procedure

MEASUREMENT PROCEDURE REF

- Set resolution bandwidth (RBW) = 100kHz
- Set the video bandwidth (VBW) $\geq 3 \times$ RBW, Detector = Peak.
- Trace mode = max hold.
- Sweep = auto couple.
- Measure the maximum width of the emission that is constrained by the frequencies associated with the two amplitude points (upper and lower) that are attenuated by 6 dB relative to the maximum level measured in the fundamental emission

4.6.5 Deviation from Test Standard

No deviation.

4.6.6 EUT Operating Condition

The software provided by client to enable the EUT under transmission condition continuously at lowest, middle and highest channel frequencies individually.

4.6.7 Test Results

802.11a

Channel	Frequency (MHz)	6dB Bandwidth (MHz)			Minimum Limit (MHz)	Pass / Fail
		Chain 0	Chain 1	Chain 2		
149	5745	15.62	15.82	16.42	0.5	Pass
157	5785	16.13	16.40	15.95	0.5	Pass
165	5825	16.42	16.38	16.44	0.5	Pass

802.11n (HT20)

Channel	Frequency (MHz)	6dB Bandwidth (MHz)			Minimum Limit (MHz)	Pass / Fail
		Chain 0	Chain 1	Chain 2		
149	5745	16.70	16.92	16.38	0.5	Pass
157	5785	17.36	17.01	17.35	0.5	Pass
165	5825	16.93	17.33	16.99	0.5	Pass

802.11n (HT40)

Channel	Frequency (MHz)	6dB Bandwidth (MHz)			Minimum Limit (MHz)	Pass / Fail
		Chain 0	Chain 1	Chain 2		
151	5755	35.88	34.53	35.87	0.5	Pass
159	5795	35.86	35.77	35.80	0.5	Pass

Spectrum Plot of Worst Value

802.11a

802.11n (HT20)

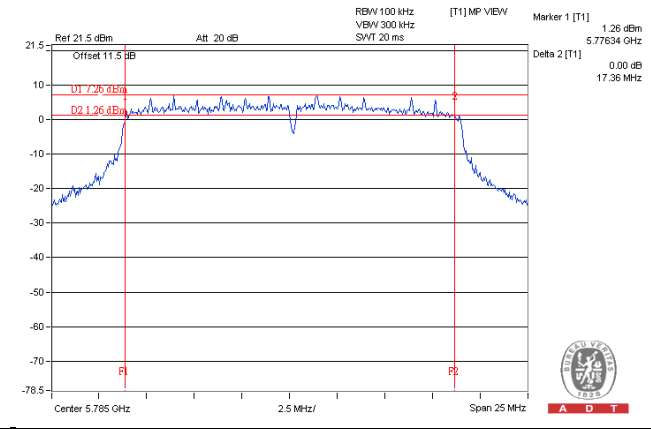
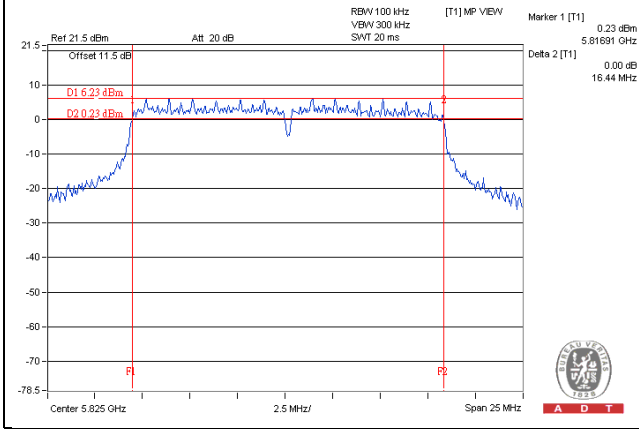

802.11n (HT40)

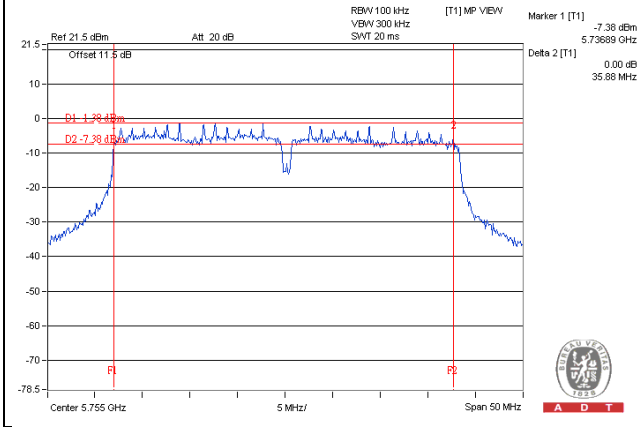

5 Pictures of Test Arrangements

Please refer to the attached file (Test Setup Photo).

Appendix – Information on the Testing Laboratories

We, Bureau Veritas Consumer Products Services (H.K.) Ltd., Taoyuan Branch, were founded in 1988 to provide our best service in EMC, Radio, Telecom and Safety consultation. Our laboratories are accredited and approved according to ISO/IEC 17025.

If you have any comments, please feel free to contact us at the following:

Linko EMC/RF Lab

Tel: 886-2-26052180

Fax: 886-2-26051924

Hsin Chu EMC/RF Lab/Telecom Lab

Tel: 886-3-5935343

Fax: 886-3-5935342

Hwa Ya EMC/RF/Safety

Tel: 886-3-3183232

Fax: 886-3-3270892

Email: service.adt@tw.bureauveritas.com

Web Site: www.bureauveritas-adt.com

The address and road map of all our labs can be found in our web site also.

--- END ---