



SPORTON International Inc.

No. 52, Hwa Ya 1st Rd., Kwei-Shan Hsiang, TaoYuan Hsien, Taiwan, R.O.C.
Ph: 886-3-327-3456 / FAX: 886-3-327-0973 / www.sporton.com.tw

FCC RADIO TEST REPORT

Applicant's company	Adtran
Applicant Address	901 Explorer Boulevard Huntsville Alabama United States 35806-2807
FCC ID	HDCWLAN194XF1
Manufacturer's company	Senao Networks, Inc.
Manufacturer Address	3F, No. 529, Chung Cheng Rd., Hsintien, Taipei, Taiwan

Product Name	802.11 bgn PCIe Module
Brand Name	Adtran
Model Name	WLAN194XF1
Test Rule Part(s)	47 CFR FCC Part 15 Subpart C § 15.247
Test Freq. Range	2400 ~ 2483.5MHz
Received Date	Sep. 12, 2012
Final Test Date	Nov. 22, 2012
Submission Type	Original Equipment



Statement

Test result included is only for the IEEE 802.11n, IEEE 802.11b/g part of the product.

The test result in this report refers exclusively to the presented test model / sample.

Without written approval of SPORTON International Inc., the test report shall not be reproduced except in full.

The measurements and test results shown in this test report were made in accordance with the procedures and found in compliance with the limit given in **ANSI C63.10-2009, 47 CFR FCC Part 15 Subpart C, KDB 558074 D01 v02 and KDB 662911 D01 v01r02.**

The test equipment used to perform the test is calibrated and traceable to NML/ROC.



Table of Contents

1. CERTIFICATE OF COMPLIANCE	1
2. SUMMARY OF THE TEST RESULT	2
3. GENERAL INFORMATION	3
3.1. Product Details.....	3
3.2. Accessories.....	5
3.3. Table for Filed Antenna.....	6
3.4. Table for Carrier Frequencies	7
3.5. Table for Test Modes	8
3.6. Table for Testing Locations.....	9
3.7. Table for Supporting Units	9
3.8. Table for Parameters of Test Software Setting	9
3.9. Test Configurations	10
4. TEST RESULT	13
4.1. AC Power Line Conducted Emissions Measurement.....	13
4.2. Maximum Conducted Average Output Power Measurement	17
4.3. Power Spectral Density Measurement	20
4.4. 6dB Spectrum Bandwidth Measurement	26
4.5. Radiated Emissions Measurement	31
4.6. Band Edge Emissions Measurement	49
4.7. Antenna Requirements	62
5. LIST OF MEASURING EQUIPMENTS	63
6. TEST LOCATION.....	65
7. TAF CERTIFICATE OF ACCREDITATION	66
APPENDIX A. TEST PHOTOS	A1 ~ A5
APPENDIX B. MAXIMUM PERMISSIBLE EXPOSURE	B1 ~ B3



History of This Test Report

REPORT NO.	VERSION	DESCRIPTION	ISSUED DATE
FR291831AC	Rev. 01	Initial issue of report	Jan. 08, 2013



1. CERTIFICATE OF COMPLIANCE

Product Name : 802.11 bgn PCIe Module
Brand Name : Adtran
Model Name : WLAN194XF1
Applicant : Adtran
Test Rule Part(s) : 47 CFR FCC Part 15 Subpart C § 15.247

Sporton International as requested by the applicant to evaluate the EMC performance of the product sample received on Sep. 12, 2012 would like to declare that the tested sample has been evaluated and found to be in compliance with the tested rule parts. The data recorded as well as the test configuration specified is true and accurate for showing the sample's EMC nature.

A handwritten signature in blue ink that reads 'Jordan Hsiao'.

Jordan Hsiao
SPORTON INTERNATIONAL INC.

2. SUMMARY OF THE TEST RESULT

Applied Standard: 47 CFR FCC Part 15 Subpart C				
Part	Rule Section	Description of Test	Result	Under Limit
4.1	15.207	AC Power Line Conducted Emissions	Complies	14.83 dB
4.2	15.247(b)(3)	Maximum Conducted Average Output Power	Complies	1.16 dB
4.3	15.247(e)	Power Spectral Density	Complies	1.5 dB
4.4	15.247(a)(2)	6dB Spectrum Bandwidth	Complies	-
4.5	15.247(d)	Radiated Emissions	Complies	6.59 dB
4.6	15.247(d)	Band Edge Emissions	Complies	1.17 dB
4.7	15.203	Antenna Requirements	Complies	-

Test Items	Uncertainty	Remark
AC Power Line Conducted Emissions	±2.3dB	Confidence levels of 95%
Maximum Conducted Average Output Power	±0.8dB	Confidence levels of 95%
Power Spectral Density	±0.5dB	Confidence levels of 95%
6dB Spectrum Bandwidth	±8.5×10 ⁻⁸	Confidence levels of 95%
Radiated Emissions (9kHz~30MHz)	±0.8dB	Confidence levels of 95%
Radiated Emissions (30MHz~1000MHz)	±1.9dB	Confidence levels of 95%
Radiated / Band Edge Emissions (1GHz~18GHz)	±1.9dB	Confidence levels of 95%
Radiated Emissions (18GHz~40GHz)	±1.9dB	Confidence levels of 95%
Temperature	±0.7°C	Confidence levels of 95%
Humidity	±3.2%	Confidence levels of 95%
DC / AC Power Source	±1.4%	Confidence levels of 95%

3. GENERAL INFORMATION

3.1. Product Details

IEEE 802.11n

Items	Description
Product Type	WLAN (3TX, 3RX)
Radio Type	Intentional Transceiver
Power Type	From Host System
Modulation	see the below table for IEEE 802.11n
Data Modulation	OFDM (BPSK / QPSK / 16QAM / 64QAM)
Data Rate (Mbps)	see the below table for IEEE 802.11n
Frequency Range	2400 ~ 2483.5MHz
Channel Number	11 for 20MHz bandwidth ; 7 for 40MHz bandwidth
Channel Band Width (99%)	MCS0 (20MHz): 17.84 MHz ; MCS0 (40MHz): 36.32 MHz
Maximum Conducted Average Output Power	MCS0 (20MHz): 28.75 dBm ; MCS0 (40MHz): 23 dBm
Carrier Frequencies	Please refer to section 3.4
Antenna	Please refer to section 3.3

802.11b/g

Items	Description
Product Type	WLAN (3TX, 3RX)
Radio Type	Intentional Transceiver
Power Type	From Host System
Modulation	DSSS for IEEE 802.11b ; OFDM for IEEE 802.11g
Data Modulation	DSSS (BPSK / QPSK / CCK) ; OFDM (BPSK / QPSK / 16QAM / 64QAM)
Data Rate (Mbps)	DSSS (1/ 2/ 5.5/11) ; OFDM (6/9/12/18/24/36/48/54)
Frequency Range	2400 ~ 2483.5MHz
Channel Number	11b/g: 11
Channel Band Width (99%)	11b: 15.20 MHz ; 11g: 16.88 MHz
Maximum Conducted Average Output Power	11b: 28.61 dBm ; 11g: 28.84 dBm
Carrier Frequencies	Please refer to section 3.4
Antenna	Please refer to section 3.3

Antenna & Band width

Antenna	Single (TX)		Two (TX)		Three (TX)	
Band width Mode	20 MHz	40 MHz	20 MHz	40 MHz	20 MHz	40 MHz
IEEE 802.11b	X	X	X	X	V	X
IEEE 802.11g	X	X	X	X	V	X
IEEE 802.11n	X	X	X	X	V	V

IEEE 802.11n spec

MCS	Spatial	Modulation	Coding	Data rate (Mbit/s)			
index	streams	type	rate	20 MHz channel		40 MHz channel	
				800 ns GI	400 ns GI	800 ns GI	400 ns GI
0	1	BPSK	1/2	6.5	7.2	13.5	15
1	1	QPSK	1/2	13	14.4	27	30
2	1	QPSK	3/4	19.5	21.7	40.5	45
3	1	16-QAM	1/2	26	28.9	54	60
4	1	16-QAM	3/4	39	43.3	81	90
5	1	64-QAM	2/3	52	57.8	108	120
6	1	64-QAM	3/4	58.5	65	121.5	135
7	1	64-QAM	5/6	65	72.2	135	150
8	2	BPSK	1/2	13	14.4	27	30
9	2	QPSK	1/2	26	28.9	54	60
10	2	QPSK	3/4	39	43.3	81	90
11	2	16-QAM	1/2	52	57.8	108	120
12	2	16-QAM	3/4	78	86.7	162	180
13	2	64-QAM	2/3	104	115.6	216	240
14	2	64-QAM	3/4	117	130	243	270
15	2	64-QAM	5/6	130	144.4	270	300
16	3	BPSK	1/2	19.5	21.7	40.5	45
17	3	QPSK	1/2	39	43.3	81	90
18	3	QPSK	3/4	58.5	65	121.5	135
19	3	16-QAM	1/2	78	86.7	162	180
20	3	16-QAM	3/4	117	130	243	270
21	3	64-QAM	2/3	156	173.3	324	360
22	3	64-QAM	3/4	175.5	195	364.5	405
23	3	64-QAM	5/6	195	216.7	405	450

Symbol	Explanation
NSS	Number of spatial streams
R	Code rate
NBPSC	Number of coded bits per single carrier
NCBPS	Number of coded bits per symbol
NDBPS	Number of data bits per symbol
GI	guard interval

3.2. Accessories

N/A

3.3. Table for Filed Antenna

Ant.	Brand	Model Name	Antenna Type	Connector	Gain (dBi)
1	Master Wave Technology CO., LTD	98618MNXX001	Dipole Antenna	MMCX	5
2	Master Wave Technology CO., LTD	98618MNXX001	Dipole Antenna	MMCX	5
3	Master Wave Technology CO., LTD	98618MNXX001	Dipole Antenna	MMCX	5

Note: The EUT has three antennas. (3TX/3RX)

For IEEE 802.11bgn mode (3TX/3RX)

Antenna 1 & Antenna 2 and Antenna 3 could transmit/receive simultaneously

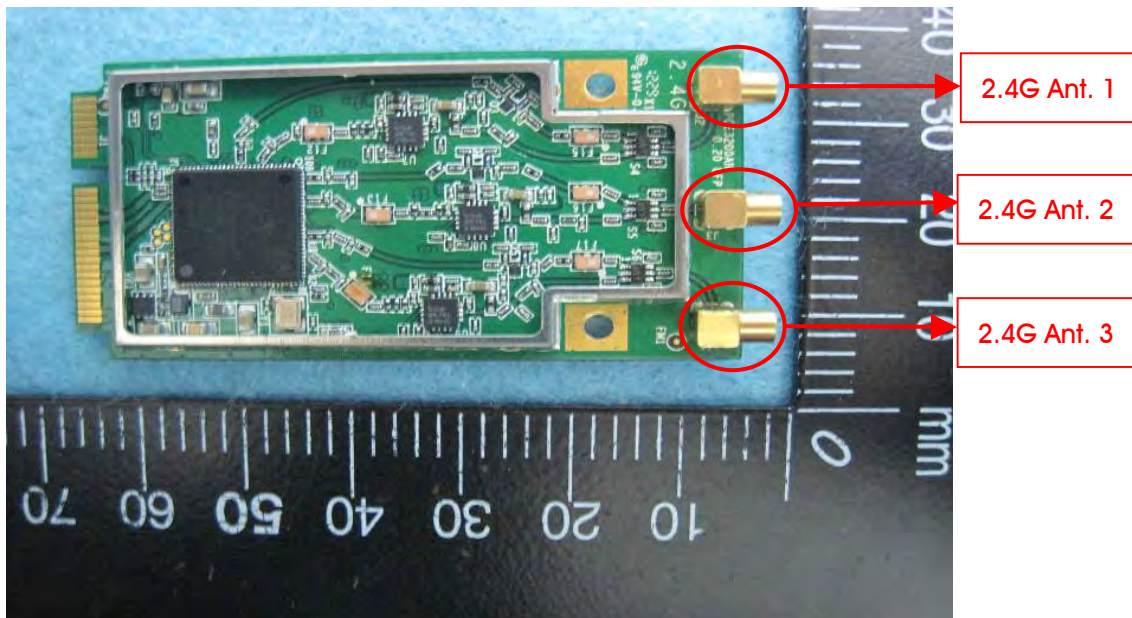

3.4. Table for Carrier Frequencies

For IEEE 802.11b/g, use Channel 1~Channel 11.

There are two bandwidth systems for IEEE 802.11n.

For both 20MHz bandwidth systems, use Channel 1~Channel 11.

For both 40MHz bandwidth systems, use Channel 3~Channel 9.

Frequency Band	Channel No.	Frequency	Channel No.	Frequency
2400~2483.5MHz	1	2412 MHz	7	2442 MHz
	2	2417 MHz	8	2447 MHz
	3	2422 MHz	9	2452 MHz
	4	2427 MHz	10	2457 MHz
	5	2432 MHz	11	2462 MHz
	6	2437 MHz	-	-

3.5. Table for Test Modes

Preliminary tests were performed in different data rate to find the worst radiated emission. The data rate shown in the table below is the worst-case rate with respect to the specific test item. Investigation has been done on all the possible configurations for searching the worst cases. The following table is a list of the test modes shown in this test report.

Test Items	Mode	Data Rate	Channel	Antenna
AC Power Line Conducted Emissions	CTX	Auto	-	-
Maximum Conducted Average Output Power	MCS0/20MHz	7.2 Mbps	1/6/11	1/2/3/1+2+3
	MCS0/40MHz	14.4 Mbps	3/6/9	1/2/3/1+2+3
	11b/CCK	1 Mbps	1/6/11	1/2/3/1+2+3
	11g/BPSK	6 Mbps	1/6/11	1/2/3/1+2+3
Power Spectral Density	MCS0/20MHz	7.2 Mbps	1/6/11	1/2/3
	MCS0/40MHz	14.4 Mbps	3/6/9	1/2/3
	11b/CCK	1 Mbps	1/6/11	1/2/3
	11g/BPSK	6 Mbps	1/6/11	1/2/3
6dB Spectrum Bandwidth	MCS0/20MHz	7.2 Mbps	1/6/11	1+2+3
	MCS0/40MHz	14.4 Mbps	3/6/9	1+2+3
	11b/CCK	1 Mbps	1/6/11	1+2+3
	11g/BPSK	6 Mbps	1/6/11	1+2+3
Radiated Emissions Below 1GHz	CTX	Auto	-	-
Radiated Emissions Above 1GHz	MCS0/20MHz	7.2 Mbps	1/6/11	1+2+3
	MCS0/40MHz	14.4 Mbps	3/6/9	1+2+3
	11b/CCK	1 Mbps	1/6/11	1+2+3
	11g/BPSK	6 Mbps	1/6/11	1+2+3
Band Edge Emissions	MCS0/20MHz	7.2 Mbps	1/6/11	1+2+3
	MCS0/40MHz	14.4 Mbps	3/6/9	1+2+3
	11b/CCK	1 Mbps	1/6/11	1+2+3
	11g/BPSK	6 Mbps	1/6/11	1+2+3

3.6. Table for Testing Locations

Test Site No.	Site Category	Location	FCC Reg. No.	IC File No.
03CH01-CB	SAC	Hsin Chu	262045	IC 4086D
CO01-CB	Conduction	Hsin Chu	262045	IC 4086D
TH01-CB	OVEN Room	Hsin Chu	-	-

Open Area Test Site (OATS); Semi Anechoic Chamber (SAC).

Please refer section 6 for Test Site Address.

3.7. Table for Supporting Units

Support Unit	Brand	Model	FCC ID
Notebook	DELL	E6220	E2KWM3945ABG

3.8. Table for Parameters of Test Software Setting

During testing, Channel & Power Controlling Software provided by the customer was used to control the operating channel as well as the output power level. The RF output power selection is for the setting of RF output power expected by the customer and is going to be fixed on the firmware of the final end product.

Power Parameters of IEEE 802.11n MCS0 20MHz

Test Software Version	ART2-GUI Version:2.3 Build		
Frequency	2412 MHz	2437 MHz	2462 MHz
MCS0 20MHz	15.5	25	15

Power Parameters of IEEE 802.11n MCS0 40MHz

Test Software Version	ART2-GUI Version:2.3 Build		
Frequency	2422 MHz	2437 MHz	2452 MHz
MCS0 40MHz	13	17.5	12.5

Power Parameters of IEEE 802.11b/g

Test Software Version	ART2-GUI Version:2.3 Build		
Frequency	2412 MHz	2437 MHz	2462 MHz
IEEE 802.11b	21	25	21.5
IEEE 802.11g	18	25	14

During the test, "ART2-GUI Version:2.3 Build" under WIN XP was executed the test program to control the EUT continuously transmit RF signal.

3.9. Test Configurations

3.9.1. Radiation Emissions Test Configuration

Test Configuration: 30MHz~1GHz

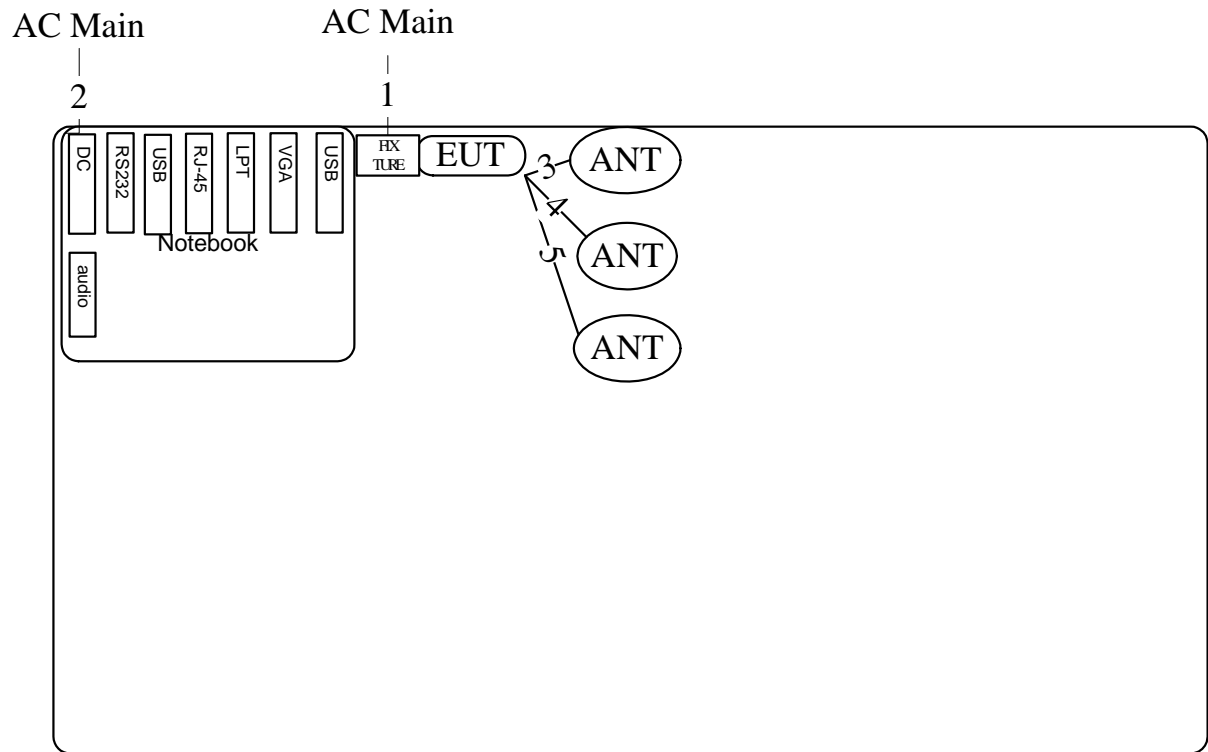

Item	Connection	Shield	Length
1	Power cable	No	3.4M
2	Power cable	No	2.6M
3	ANT cable	No	0.2M
4	ANT cable	No	0.2M
5	ANT cable	No	0.2M

Test Configuration: above 1GHz

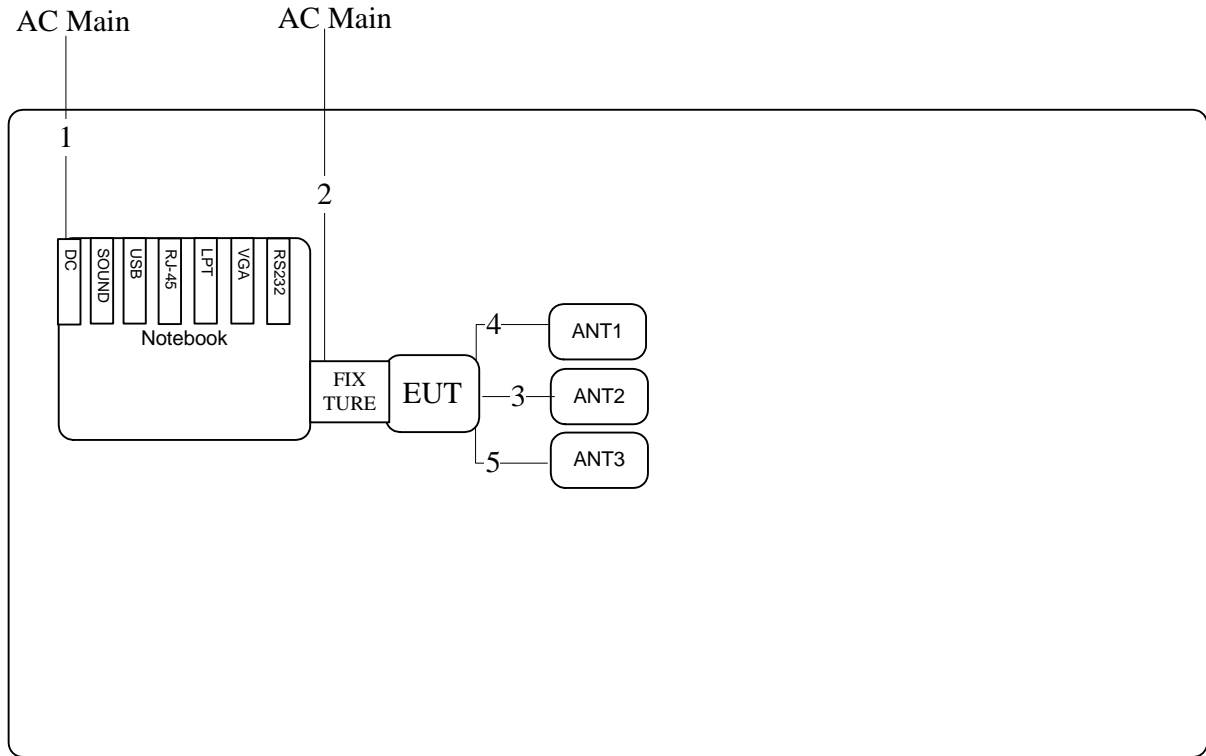

Item	Connection	Shield	Length
1	Power cable	No	1.8M
2	Power cable	No	1.8M
3	ANT cable	Yes	0.105M
4	ANT cable	No	0.175M
5	ANT cable	Yes	0.175M

3.9.2. AC Power Line Conduction Emissions Test Configuration

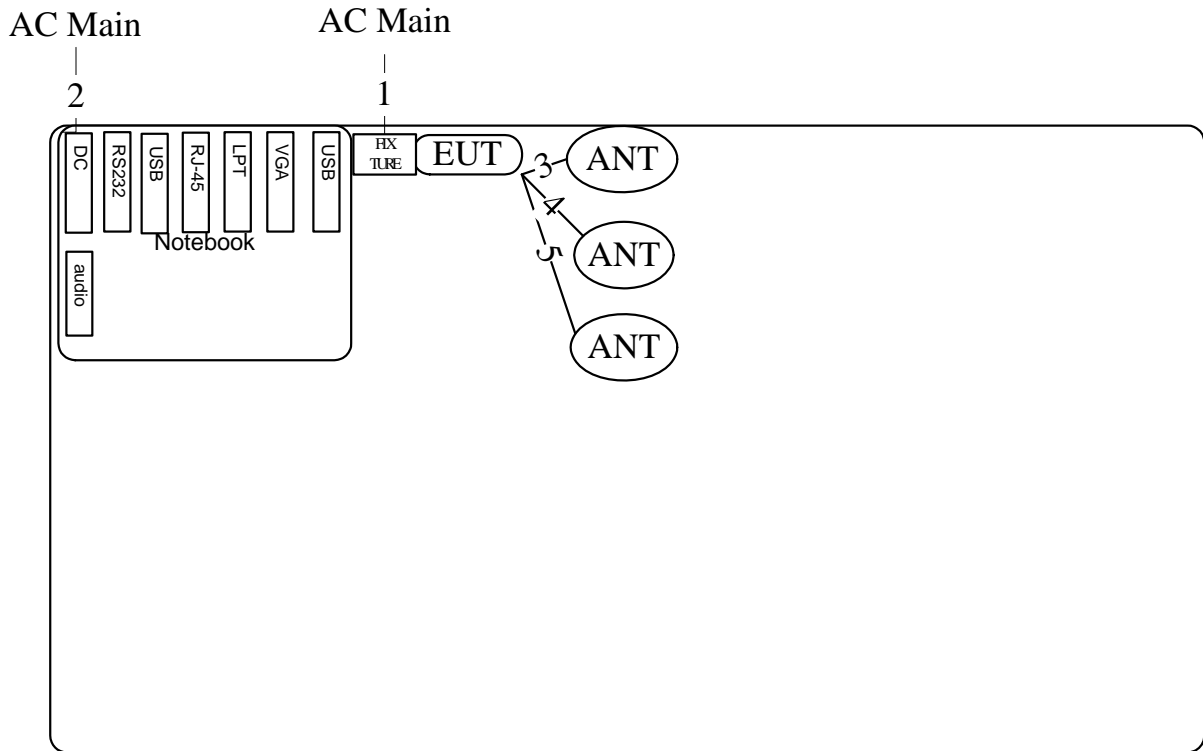

Item	Connection	Shield	Length
1	Power cable	No	3.4M
2	Power cable	No	2.6M
3	ANT cable	No	0.2M
4	ANT cable	No	0.2M
5	ANT cable	No	0.2M

4. TEST RESULT

4.1. AC Power Line Conducted Emissions Measurement

4.1.1. Limit

For this product which is designed to be connected to the AC power line, the radio frequency voltage that is conducted back onto the AC power line on any frequency or frequencies within the band 150 kHz to 30 MHz shall not exceed below limits table.

Frequency (MHz)	QP Limit (dBuV)	AV Limit (dBuV)
0.15~0.5	66~56	56~46
0.5~5	56	46
5~30	60	50

4.1.2. Measuring Instruments and Setting

Please refer to section 5 of equipments list in this report. The following table is the setting of the receiver.

Receiver Parameters	Setting
Attenuation	10 dB
Start Frequency	0.15 MHz
Stop Frequency	30 MHz
IF Bandwidth	9 KHz

4.1.3. Test Procedures

1. Configure the EUT according to ANSI C63.10. The EUT or host of EUT has to be placed 0.4 meter far from the conducting wall of the shielding room and at least 80 centimeters from any other grounded conducting surface.
2. Connect EUT or host of EUT to the power mains through a line impedance stabilization network (LISN).
3. All the support units are connected to the other LISNs. The LISN should provide 50uH/50ohms coupling impedance.
4. The frequency range from 150 KHz to 30 MHz was searched.
5. Set the test-receiver system to Peak Detect Function and Specified Bandwidth with Maximum Hold Mode.
6. The measurement has to be done between each power line and ground at the power terminal.

4.1.7. Results of AC Power Line Conducted Emissions Measurement

Temperature	24°C	Humidity	58%
Test Engineer	Sollo Lo	Phase	Line
Configuration	CTX		

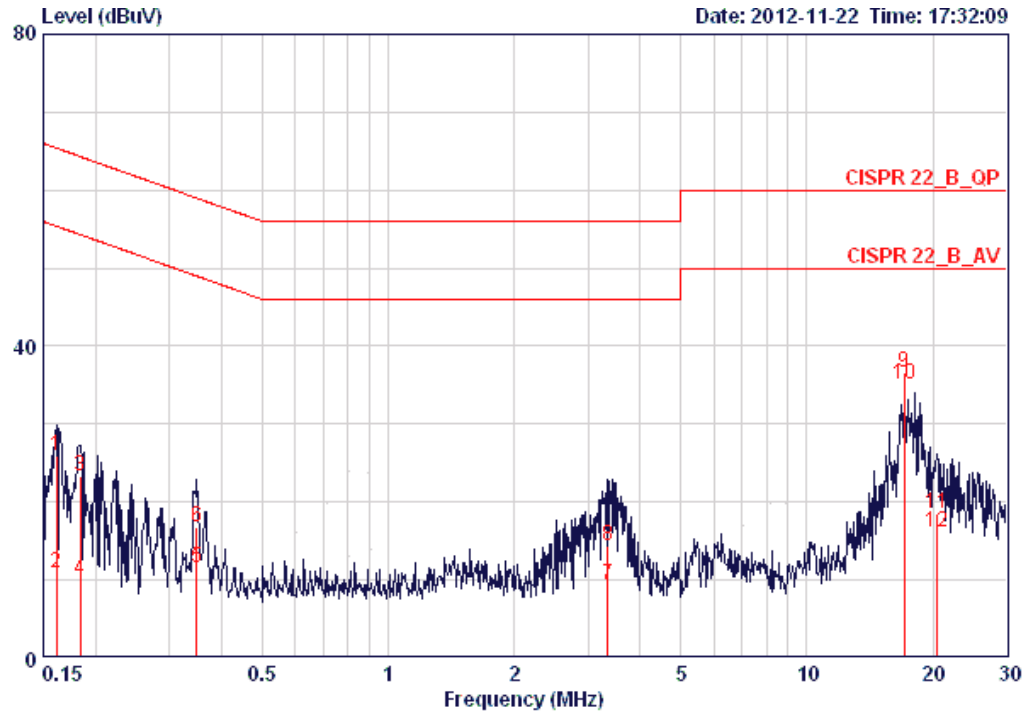

	Freq	Level	Over Limit	Limit Line	Read Level	LISN Factor	Cable Loss	Pol/Phase	Remark
	MHz	dBuV	dB	dBuV	dBuV	dB	dB		
1	0.16155	25.95	-39.43	65.38	25.59	0.16	0.20	LINE	QP
2	0.16155	10.93	-44.45	55.38	10.57	0.16	0.20	LINE	AVERAGE
3	0.18346	23.41	-40.92	64.33	23.06	0.15	0.20	LINE	QP
4	0.18346	10.04	-44.29	54.33	9.69	0.15	0.20	LINE	AVERAGE
5	0.34830	11.51	-37.49	49.00	11.16	0.15	0.20	LINE	AVERAGE
6	0.34830	16.81	-42.19	59.00	16.46	0.15	0.20	LINE	QP
7	3.347	9.30	-36.70	46.00	8.82	0.21	0.27	LINE	AVERAGE
8	3.347	14.32	-41.68	56.00	13.84	0.21	0.27	LINE	QP
9	17.109	36.63	-23.37	60.00	35.69	0.44	0.50	LINE	QP
10	17.109	35.17	-14.83	50.00	34.23	0.44	0.50	LINE	AVERAGE
11	20.377	18.45	-41.55	60.00	17.46	0.49	0.50	LINE	QP
12	20.377	16.04	-33.96	50.00	15.05	0.49	0.50	LINE	AVERAGE

Temperature	24°C	Humidity	58%
Test Engineer	Sollo Lo	Phase	Neutral
Configuration	CTX		

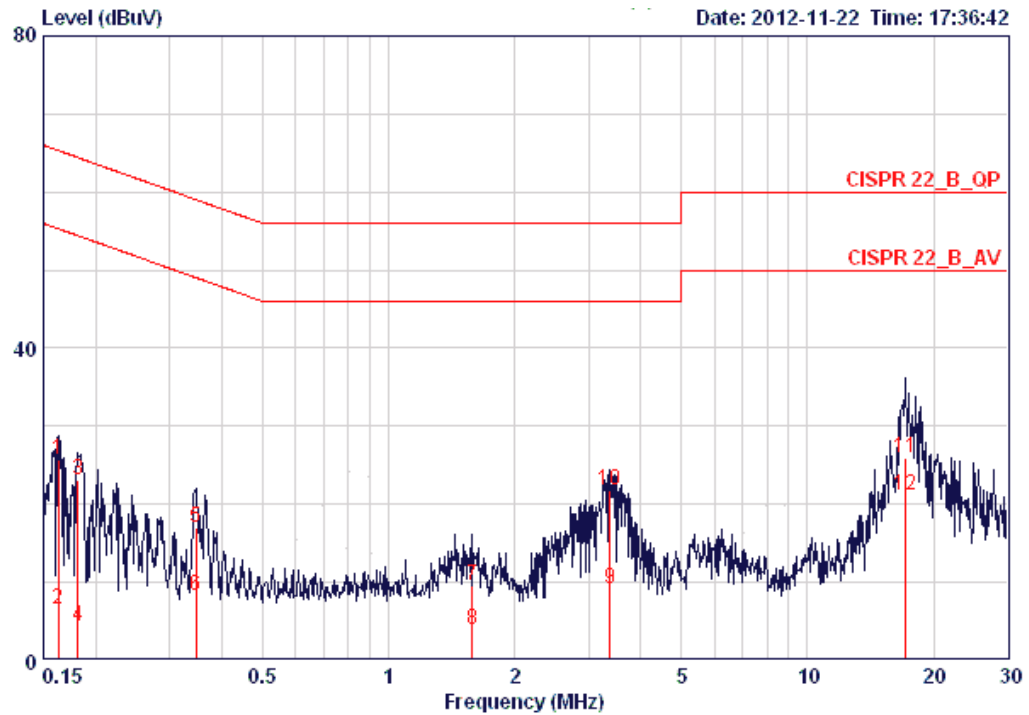

	Freq	Level	Over Limit	Limit Line	Read Level	LISN Factor	Cable Loss	Pol/Phase	Remark
	MHz	dBuV	dB	dBuV	dBuV	dB	dB		
1	0.16241	25.70	-39.64	65.34	25.42	0.08	0.20	NEUTRAL	QP
2	0.16241	6.50	-48.84	55.34	6.22	0.08	0.20	NEUTRAL	AVERAGE
3	0.18152	23.08	-41.34	64.42	22.80	0.08	0.20	NEUTRAL	QP
4	0.18152	4.29	-50.13	54.42	4.01	0.08	0.20	NEUTRAL	AVERAGE
5	0.34646	16.90	-42.15	59.05	16.62	0.08	0.20	NEUTRAL	QP
6	0.34646	8.33	-40.72	49.05	8.05	0.08	0.20	NEUTRAL	AVERAGE
7	1.585	9.59	-46.41	56.00	9.37	0.10	0.12	NEUTRAL	QP
8	1.585	3.87	-42.13	46.00	3.65	0.10	0.12	NEUTRAL	AVERAGE
9	3.374	9.10	-36.90	46.00	8.70	0.12	0.28	NEUTRAL	AVERAGE
10	3.374	21.82	-34.18	56.00	21.42	0.12	0.28	NEUTRAL	QP
11	17.201	26.05	-33.95	60.00	25.20	0.35	0.50	NEUTRAL	QP
12	17.201	21.20	-28.80	50.00	20.35	0.35	0.50	NEUTRAL	AVERAGE

Note:

$$\text{Level} = \text{Read Level} + \text{LISN Factor} + \text{Cable Loss}$$

4.2. Maximum Conducted Average Output Power Measurement

4.2.1. Limit

For systems using digital modulation in the 2400-2483.5MHz, the limit for output power is 30dBm. The limited has to be reduced by the amount in dB that the gain of the antenna exceed 6dBi. In case of point-to-point operation, the limit has to be reduced by 1dB for every 3dB that the directional gain of the antenna exceeds 6dBi. Systems operating in the 5725-5850 MHz band that are used exclusively for fixed, point-to-point operations may employ transmitting antennas with directional gain greater than 6 dBi without any corresponding reduction in transmitter output power.

4.2.2. Measuring Instruments and Setting

Please refer to section 5 of equipments list in this report. The following table is the setting of the power meter.

Power Meter Parameter	Setting
Bandwidth	50MHz bandwidth is greater than the EUT emission bandwidth
Detector	Average

4.2.3. Test Procedures

1. Test procedures refer KDB558074 v01 r02 section 8.2.3 option 3.
2. This procedure provides an alternative for determining the RMS output power using a broadband RF average power meter with a thermocouple detector.

4.2.4. Test Setup Layout

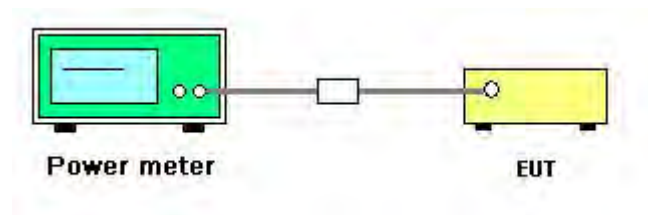

4.2.5. Test Deviation

There is no deviation with the original standard.

4.2.6. EUT Operation during Test

The EUT was programmed to be in continuously transmitting mode.

4.2.7. Test Result of Maximum Conducted Average Output Power

Temperature	25°C	Humidity	56%
Test Engineer	Denis Su	Configurations	IEEE 802.11n
Test Date	Nov. 22, 2012		

Configuration IEEE 802.11n MCS0 20MHz

Channel	Frequency	Conducted Average Power (dBm)			Total Conducted Average Power (dBm)	Max. Limit (dBm)	Result
		Ant. 1	Ant. 2	Ant. 3			
1	2412 MHz	15.50	15.46	16.38	20.57	30.00	Complies
6	2437 MHz	23.63	23.85	24.42	28.75	30.00	Complies
11	2462 MHz	15.47	15.63	15.72	20.38	30.00	Complies

Configuration IEEE 802.11n MCS0 40MHz

Channel	Frequency	Conducted Average Power (dBm)			Total Conducted Average Power (dBm)	Max. Limit (dBm)	Result
		Ant. 1	Ant. 2	Ant. 3			
3	2422 MHz	13.21	13.41	14.38	18.47	30.00	Complies
6	2437 MHz	17.38	18.09	19.05	23.00	30.00	Complies
9	2452 MHz	12.64	13.13	14.01	18.07	30.00	Complies

Temperature	25°C	Humidity	56%
Test Engineer	Denis Su	Configurations	IEEE 802.11b/g
Test Date	Nov. 22, 2012		

Configuration IEEE 802.11b

Channel	Frequency	Conducted Average Power (dBm)			Total Conducted Average Power (dBm)	Max. Limit (dBm)	Result
		Ant. 1	Ant. 2	Ant. 3			
1	2412 MHz	20.45	20.46	21.35	25.55	30.00	Complies
6	2437 MHz	23.52	23.86	24.12	28.61	30.00	Complies
11	2462 MHz	20.78	21.22	21.62	25.99	30.00	Complies

Configuration IEEE 802.11g

Channel	Frequency	Conducted Average Power (dBm)			Total Conducted Average Power (dBm)	Max. Limit (dBm)	Result
		Ant. 1	Ant. 2	Ant. 3			
1	2412 MHz	17.85	17.78	18.82	22.95	30.00	Complies
6	2437 MHz	23.92	23.95	24.32	28.84	30.00	Complies
11	2462 MHz	14.13	14.62	15.12	19.41	30.00	Complies

4.3. Power Spectral Density Measurement

4.3.1. Limit

For digitally modulated systems, the power spectral density conducted from the intentional radiator to the antenna shall not be greater than 8dBm in any 3 kHz band during any time interval of continuous transmission.

4.3.2. Measuring Instruments and Setting

Please refer to section 5 of equipments list in this report. The following table is the setting of the spectrum analyzer.

Spectrum Parameter	Setting
Attenuation	Auto
Span Frequency	Set the span to 1.5 times the DTS channel bandwidth.
RB	100 kHz
VB	300 kHz
Detector	Pesk
Trace	Max Hold
Sweep Time	Auto

4.3.3. Test Procedures

1. Test procedures refer KDB558074 v01 r02 section 9.1 option 1
2. Spectrum analyzer must be capable of utilizing a number of measurement points in each sweep that is greater than or equal to twice the span/RBW in order to ensure bin-to-bin spacing of $\leq RBW/2$ so that narrowband signals are not lost between frequency bins.
3. Use this procedure when the Maximum Conducted Average Output Power in the fundamental emission is used to demonstrate compliance. The EUT must be configured to transmit continuously at full power over the measurement duration.
4. Ensure that the number of measurement points in the sweep $\geq 2 \times \text{span}/\text{RBW}$ (use of a greater number of measurement points than this minimum requirement is recommended).
5. Use the peak marker function to determine the maximum level in any 100 kHz band segment within the fundamental EBW.
6. Scale the observed power level to an equivalent level in 3 kHz by adjusting (reducing) the measured power by a bandwidth correction factor (BWCF) where: $BWCF = 10\log(3 \text{ kHz}/100 \text{ kHz} = -15.2 \text{ dB})$.
7. The resulting PSD level must be $\leq 8 \text{ dBm}$.
8. When measuring power spectral density with multiple antenna systems, add every result of the values by mathematic formula.

4.3.4. Test Setup Layout

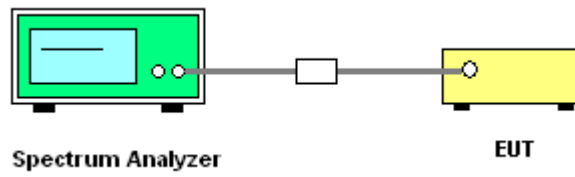

4.3.5. Test Deviation

There is no deviation with the original standard.

4.3.6. EUT Operation during Test

The EUT was programmed to be in continuously transmitting mode.

4.3.7. Test Result of Power Spectral Density

Temperature	25°C	Humidity	56%
Test Engineer	Denis Su	Configurations	IEEE 802.11n

Configuration IEEE 802.11n MCS0 20MHz

Channel	Frequency	Power Density (dBm/100kHz)			BWCF factor (100KHz to 3KHz)	Power Density (dBm/3kHz)			Single port Limit (dBm/3kHz)	Result
		Ant. 1	Ant. 2	Ant. 3		Ant. 1	Ant. 2	Ant. 3		
1	2412 MHz	2.36	2.82	3.55	-15.23	-12.87	-12.41	-11.68	3.23	Complies
6	2437 MHz	11.44	11.86	12.13	-15.23	-3.79	-3.37	-3.10	3.23	Complies
11	2462 MHz	2.21	2.02	2.31	-15.23	-13.02	-13.21	-12.92	3.23	Complies

Note: PSD Limit = (8dBm/MHz - (10log(3))) = 3.23dBm/MHz

Configuration IEEE 802.11n MCS0 40MHz

Channel	Frequency	Power Density (dBm/100kHz)			BWCF factor (100KHz to 3KHz)	Power Density (dBm/3kHz)			Single port Limit (dBm/3kHz)	Result
		Ant. 1	Ant. 2	Ant. 3		Ant. 1	Ant. 2	Ant. 3		
3	2422 MHz	-2.60	-2.69	-0.83	-15.23	-17.83	-17.92	-16.06	3.23	Complies
6	2437 MHz	2.52	2.95	3.77	-15.23	-12.71	-12.28	-11.46	3.23	Complies
9	2452 MHz	-3.16	-2.54	-1.88	-15.23	-18.39	-17.77	-17.11	3.23	Complies

Note: PSD Limit = (8dBm/MHz - (10log(3))) = 3.23dBm/MHz

Temperature	25°C	Humidity	56%
Test Engineer	Denis Su	Configurations	IEEE 802.11b/g

Configuration IEEE 802.11b

Channel	Frequency	Power Density (dBm/100kHz)			BWCF factor (100KHz to 3KHz)	Power Density (dBm/3kHz)			Single port Limit (dBm/3kHz)	Result
		Ant. 1	Ant. 2	Ant. 3		Ant. 1	Ant. 2	Ant. 3		
1	2412 MHz	12.28	12.57	13.58	-15.23	-2.95	-2.66	-1.65	3.23	Complies
6	2437 MHz	16.09	16.54	16.96	-15.23	0.86	1.31	1.73	3.23	Complies
11	2462 MHz	12.97	12.63	14.70	-15.23	-2.26	-2.60	-0.53	3.23	Complies

Note: PSD Limit = (8dBm/MHz - (10log(3))) = 3.23dBm/MHz

Configuration IEEE 802.11g

Channel	Frequency	Power Density (dBm/100kHz)			BWCF factor (100KHz to 3KHz)	Power Density (dBm/3kHz)			Single port Limit (dBm/3kHz)	Result
		Ant. 1	Ant. 2	Ant. 3		Ant. 1	Ant. 2	Ant. 3		
1	2412 MHz	4.62	5.32	6.70	-15.23	-10.61	-9.91	-8.53	3.23	Complies
6	2437 MHz	12.06	12.07	12.92	-15.23	-3.17	-3.16	-2.31	3.23	Complies
11	2462 MHz	1.61	2.08	2.39	-15.23	-13.62	-13.15	-12.84	3.23	Complies

Note: PSD Limit = (8dBm/MHz - (10log(3))) = 3.23dBm/MHz

Note: All the test values were listed in the report.

For plots, only the channel with maximum results was shown.

Power Density Plot on Configuration IEEE 802.11n MCS0 20MHz / Ant. 3 / 2437 MHz

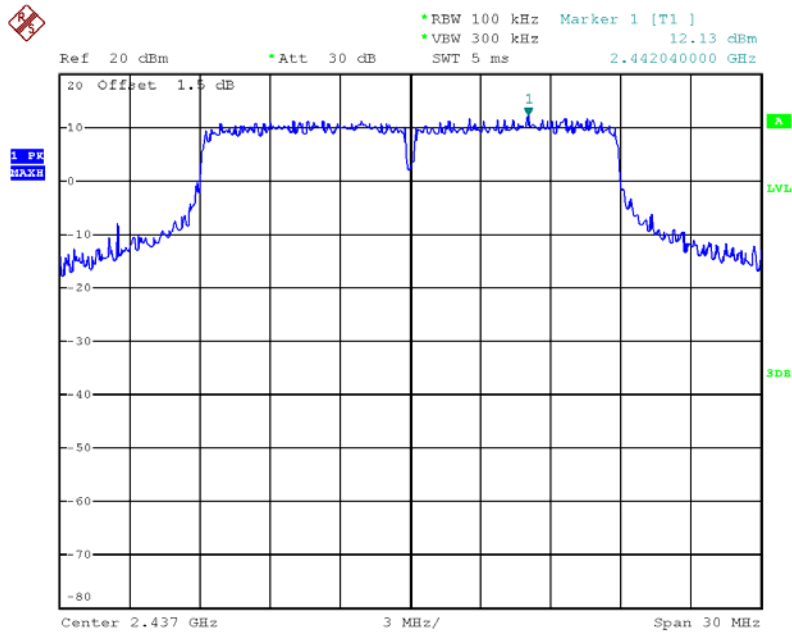

Date: 22.NOV.2012 16:33:51

Power Density Plot on Configuration IEEE 802.11n MCS0 40MHz / Ant. 3 / 2437 MHz

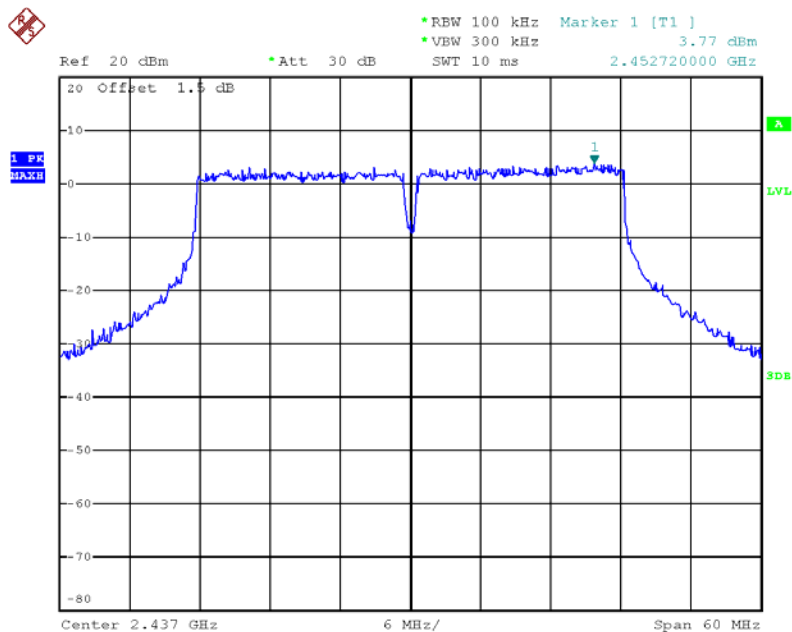

Date: 22.NOV.2012 16:30:39

Power Density Plot on Configuration IEEE 802.11b / Ant. 3 / 2437 MHz

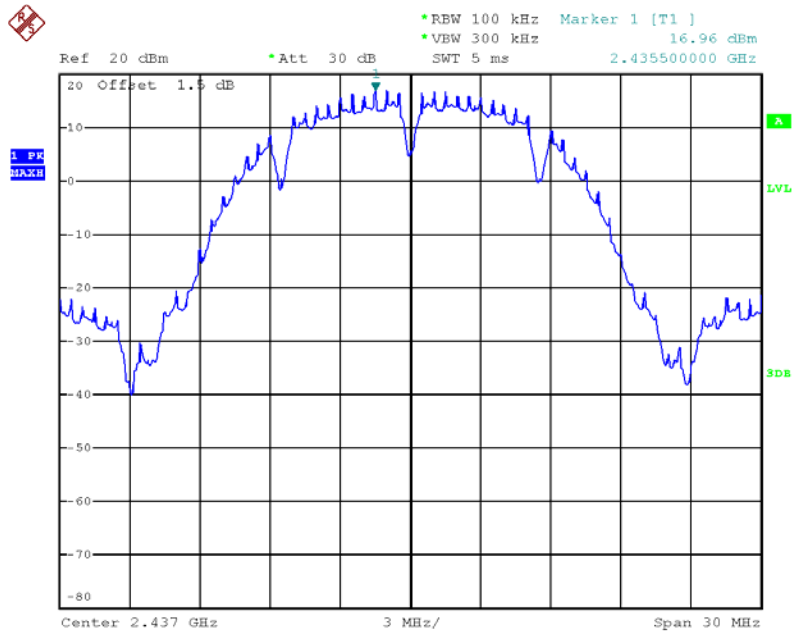

Date: 22.NOV.2012 16:37:32

Power Density Plot on Configuration IEEE 802.11g / Ant. 3 / 2437 MHz

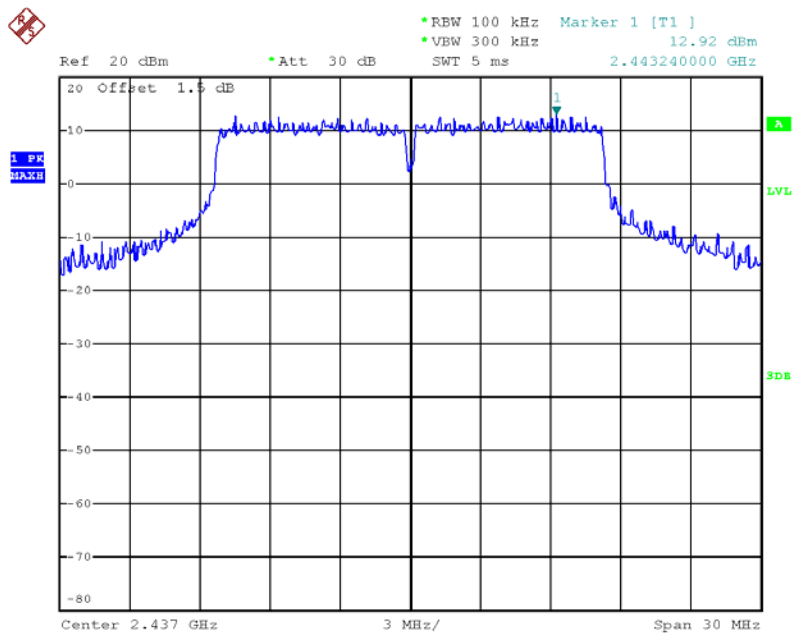

Date: 22.NOV.2012 16:35:49

4.4. 6dB Spectrum Bandwidth Measurement

4.4.1. Limit

For digital modulation systems, the minimum 6dB bandwidth shall be at least 500 kHz.

4.4.2. Measuring Instruments and Setting

Please refer to section 5 of equipments list in this report. The following table is the setting of the spectrum analyzer.

Spectrum Parameters	Setting
Attenuation	Auto
Span Frequency	> 6dB Bandwidth
RB	1-5 % or DTS BW, not exceed 100KHz
VB	$\geq 3 \times RBW$
Detector	Peak
Trace	Max Hold
Sweep Time	Auto

4.4.3. Test Procedures

1. The transmitter output (antenna port) was connected to the spectrum analyzer in peak hold mode.
2. Test was performed in accordance with KDB 558074 Guidance for Performing Compliance Measurements on Digital Transmission Systems (DTS) Operating Under §15.247 section 5.1.1 EBW Measurement Procedure
3. Multiple antenna system was performed in accordance with KDB 662911 Emissions Testing of Transmitters with Multiple Outputs in the Same Band.
4. Measured the spectrum width with power higher than 6dB below carrier.

4.4.4. Test Setup Layout

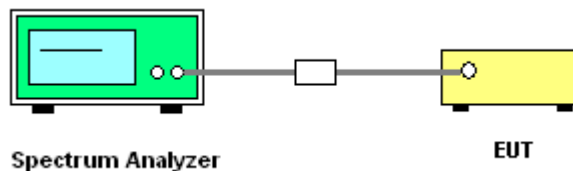

4.4.5. Test Deviation

There is no deviation with the original standard.

4.4.6. EUT Operation during Test

The EUT was programmed to be in continuously transmitting mode.

4.4.7. Test Result of 6dB Spectrum Bandwidth

Temperature	25°C	Humidity	56%
Test Engineer	Denis Su	Configurations	IEEE 802.11n

Configuration IEEE 802.11n MCS0 20MHz / Ant. 1 + Ant. 2 + Ant. 3

Channel	Frequency	6dB Bandwidth (MHz)	99% Occupied Bandwidth (MHz)	Min. Limit (kHz)	Test Result
1	2412 MHz	15.20	17.84	500	Complies
6	2437 MHz	15.68	17.68	500	Complies
11	2462 MHz	16.08	17.52	500	Complies

Configuration IEEE 802.11n MCS0 40MHz / Ant. 1 + Ant. 2 + Ant. 3

Channel	Frequency	6dB Bandwidth (MHz)	99% Occupied Bandwidth (MHz)	Min. Limit (kHz)	Test Result
3	2422 MHz	34.72	36.32	500	Complies
6	2437 MHz	34.72	36.32	500	Complies
9	2452 MHz	27.68	35.04	500	Complies

Temperature	25°C	Humidity	56%
Test Engineer	Denis Su	Configurations	IEEE 802.11b/g

Configuration IEEE 802.11b / Ant. 1 + Ant. 2 + Ant. 3

Channel	Frequency	6dB Bandwidth (MHz)	99% Occupied Bandwidth (MHz)	Min. Limit (kHz)	Test Result
1	2412 MHz	6.32	10.40	500	Complies
6	2437 MHz	6.48	10.40	500	Complies
11	2462 MHz	9.60	15.20	500	Complies

Configuration IEEE 802.11g / Ant. 1 + Ant. 2 + Ant. 3

Channel	Frequency	6dB Bandwidth (MHz)	99% Occupied Bandwidth (MHz)	Min. Limit (kHz)	Test Result
1	2412 MHz	16.48	16.56	500	Complies
6	2437 MHz	16.24	16.88	500	Complies
11	2462 MHz	13.92	15.76	500	Complies

6 dB Bandwidth Plot on Configuration IEEE 802.11n MCS0 20MHz / Ant. 1 + Ant. 2 + Ant. 3 / 2462 MHz

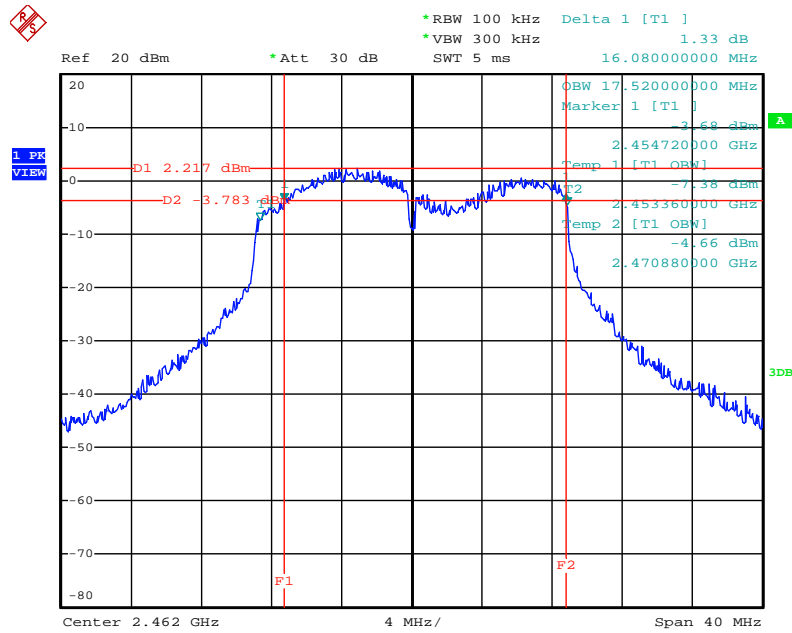

Date: 22.NOV.2012 15:50:36

6 dB Bandwidth Plot on Configuration IEEE 802.11n MCS0 40MHz / Ant. 1 + Ant. 2 + Ant. 3 / 2437 MHz

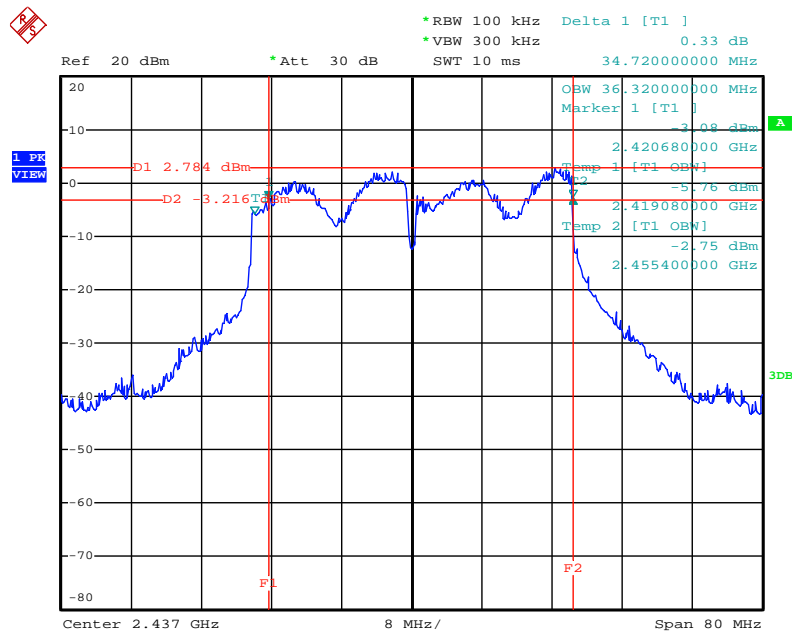

Date: 22.NOV.2012 15:52:18

6 dB Bandwidth Plot on Configuration IEEE 802.11b / Ant. 1 + Ant. 2 + Ant. 3 / 2462 MHz

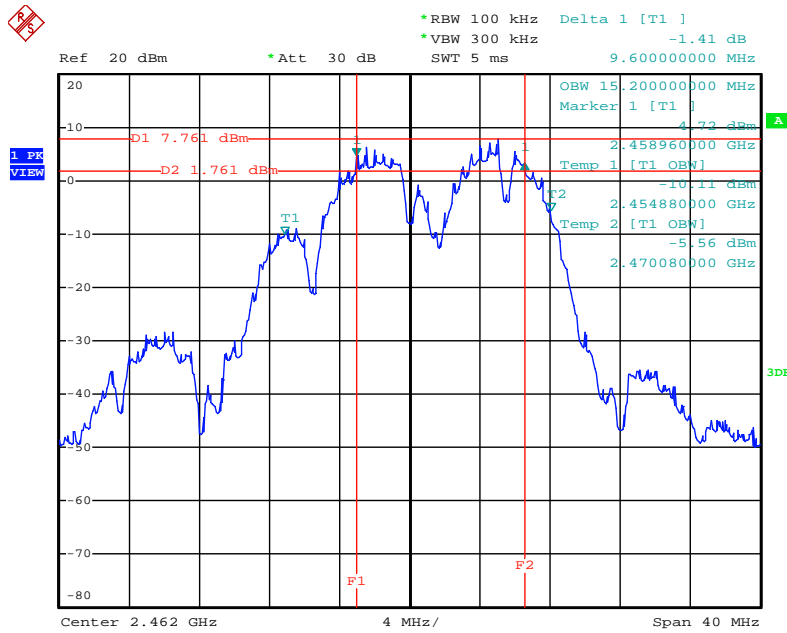

Date: 22.NOV.2012 15:43:58

6 dB Bandwidth Plot on Configuration IEEE 802.11g / Ant. 1 + Ant. 2 + Ant. 3 / 2412 MHz

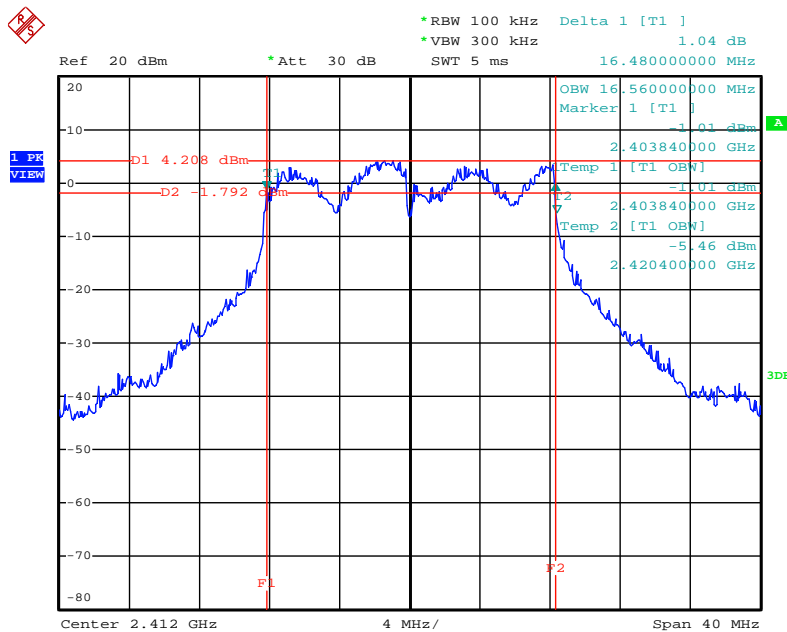

Date: 22.NOV.2012 15:47:35

4.5. Radiated Emissions Measurement

4.5.1. Limit

30dBc in any 100 kHz bandwidth outside the operating frequency band. In case the emission fall within the restricted band specified on 15.205(a), then the 15.209(a) limit in the table below has to be followed.

Frequencies (MHz)	Field Strength (microrvolts/meter)	Measurement Distance (meters)
0.009~0.490	2400/F(KHz)	300
0.490~1.705	24000/F(KHz)	30
1.705~30.0	30	30
30~88	100	3
88~216	150	3
216~960	200	3
Above 960	500	3

4.5.2. Measuring Instruments and Setting

Please refer to section 5 of equipments list in this report. The following table is the setting of spectrum analyzer and receiver.

Spectrum Parameter	Setting
Attenuation	Auto
Start Frequency	1000 MHz
Stop Frequency	10th carrier harmonic
RB / VB (Emission in restricted band)	1MHz / 3MHz for Peak, 1 MHz / 10Hz for Average
RB / VB (Emission in non-restricted band)	1MHz / 3MHz for peak

Receiver Parameter	Setting
Attenuation	Auto
Start ~ Stop Frequency	9kHz~150kHz / RB 200Hz for QP
Start ~ Stop Frequency	150kHz~30MHz / RB 9kHz for QP
Start ~ Stop Frequency	30MHz~1000MHz / RB 120kHz for QP

4.5.3. Test Procedures

1. Configure the EUT according to ANSI C63.10. The EUT was placed on the top of the turntable 0.8 meter above ground. The phase center of the receiving antenna mounted on the top of a height-variable antenna tower was placed 3 meters far away from the turntable.
2. Power on the EUT and all the supporting units. The turntable was rotated by 360 degrees to determine the position of the highest radiation.
3. The height of the broadband receiving antenna was varied between one meter and four meters above ground to find the maximum emissions field strength of both horizontal and vertical polarization.
4. For each suspected emissions, the antenna tower was scan (from 1 M to 4 M) and then the turntable was rotated (from 0 degree to 360 degrees) to find the maximum reading.
5. Set the test-receiver system to Peak or CISPR quasi-peak Detect Function with specified bandwidth under Maximum Hold Mode.
6. For emissions above 1GHz, use 1MHz VBW and 3MHz RBW for peak reading. Then 1MHz RBW and 10Hz VBW for average reading in spectrum analyzer.
7. When the radiated emissions limits are expressed in terms of the average value of the emissions, and pulsed operation is employed, the measurement field strength shall be determined by averaging over one complete pulse train, including blanking intervals, as long as the pulse train does not exceed 0.1 seconds. As an alternative (provided the transmitter operates for longer than 0.1 seconds) or in cases where the pulse train exceeds 0.1 seconds, the measured field strength shall be determined from the average absolute voltage during a 0.1 second interval during which the field strength is at its maximum value.
8. If the emissions level of the EUT in peak mode was 3 dB lower than the average limit specified, then testing will be stopped and peak values of EUT will be reported, otherwise, the emissions which do not have 3 dB margin will be repeated one by one using the quasi-peak method for below 1GHz.
9. For testing above 1GHz, the emissions level of the EUT in peak mode was lower than average limit (that means the emissions level in peak mode also complies with the limit in average mode), then testing will be stopped and peak values of EUT will be reported, otherwise, the emissions will be measured in average mode again and reported.
10. In case the emission is lower than 30MHz, loop antenna has to be used for measurement and the recorded data should be QP measured by receiver. High – Low scan is not required in this case.

4.5.4. Test Setup Layout

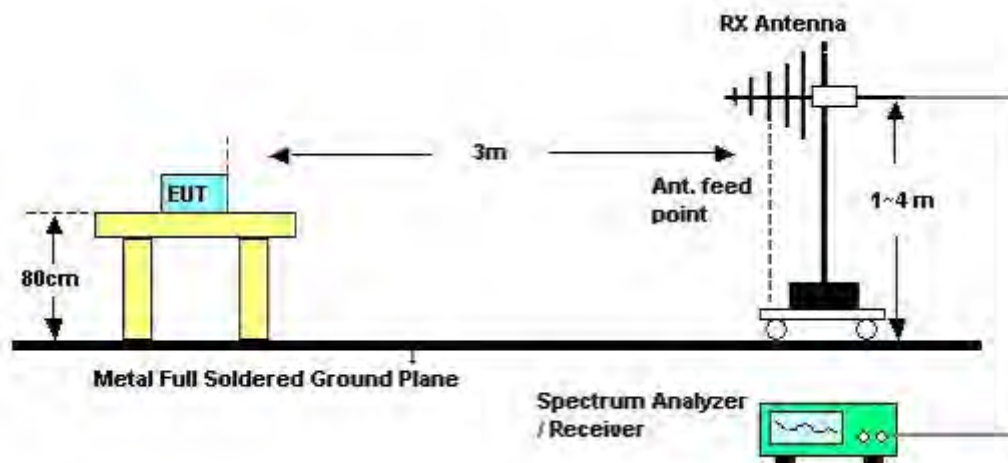
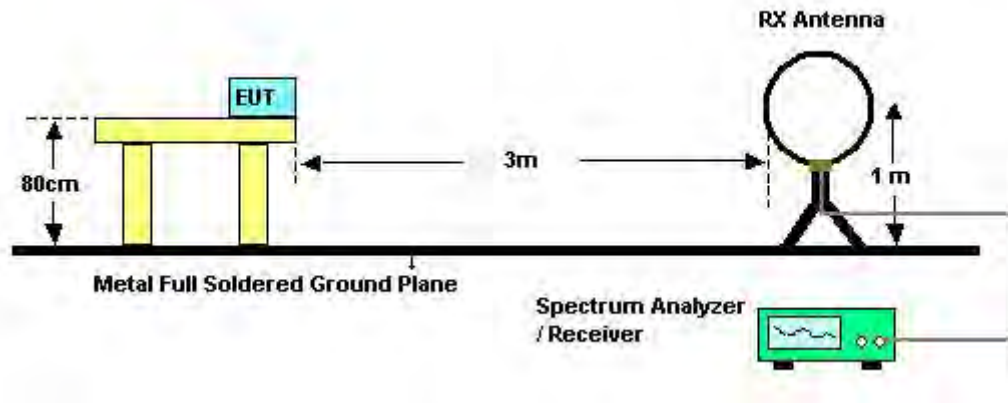

4.5.5. Test Deviation

There is no deviation with the original standard.

4.5.6. EUT Operation during Test

The EUT was programmed to be in continuously transmitting mode.

4.5.7. Results of Radiated Emissions (9kHz~30MHz)

Temperature	20°C	Humidity	60%
Test Engineer	Kenneth Huang	Configurations	CTX
Test Date	Nov. 22, 2012		

Freq. (MHz)	Level (dBuV)	Over Limit (dB)	Limit Line (dBuV)	Remark
-	-	-	-	See Note

Note:

The amplitude of spurious emissions that are attenuated by more than 20 dB below the permissible value has no need to be reported.

Distance extrapolation factor = $40 \log(\text{specific distance} / \text{test distance})$ (dB);

Limit line = specific limits (dBuV) + distance extrapolation factor.

4.5.8. Results of Radiated Emissions (30MHz~1GHz)

Temperature	20°C	Humidity	60%
Test Engineer	Kenneth Huang	Configurations	CTX

Horizontal

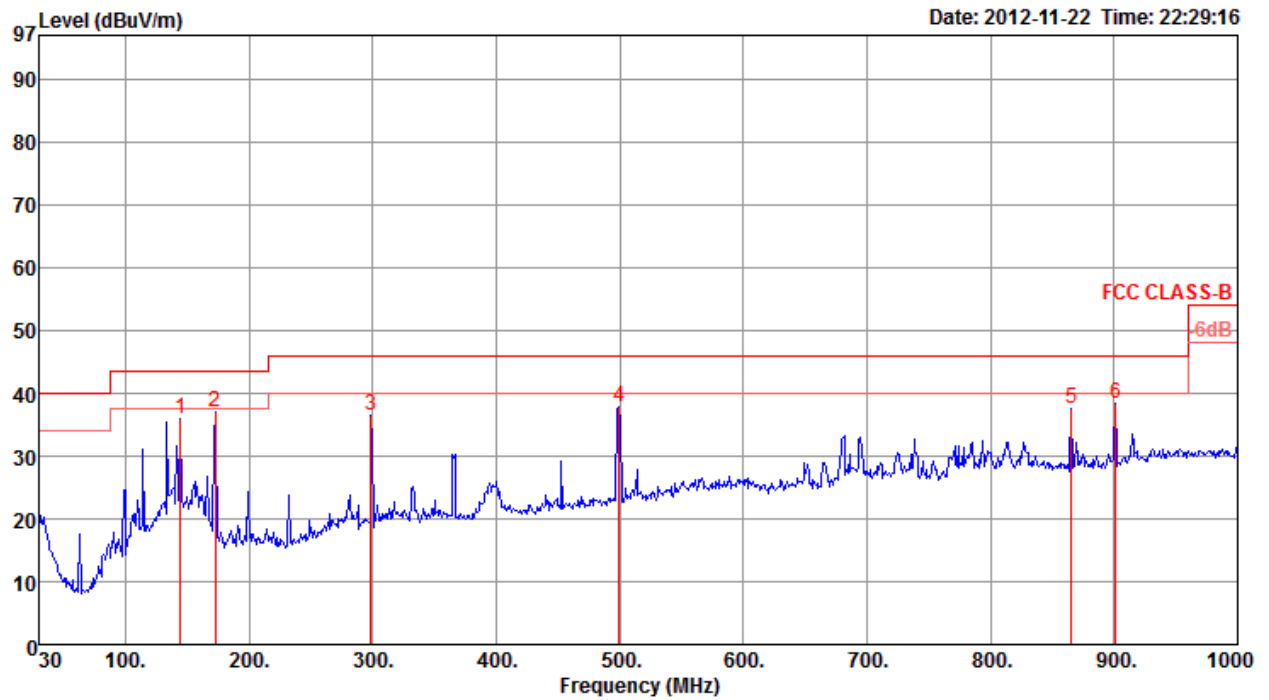

	Freq	Level	Limit	Over	Read	Cable	Preamp	Antenna	Remark	T/Pos	A/Pos	Pol/Phase
	MHz	dBuV/m	dBuV/m	dB	dBuV	dB	dB	dB/m		deg	cm	
1	144.46	35.83	43.50	-7.67	49.92	1.75	27.53	11.69	Peak	0	400	HORIZONTAL
2	172.59	36.89	43.50	-6.61	52.14	1.96	27.40	10.19	Peak	0	400	HORIZONTAL
3	298.69	36.41	46.00	-9.59	46.93	2.51	26.83	13.80	Peak	0	400	HORIZONTAL
4	499.48	37.69	46.00	-8.31	44.46	3.38	27.93	17.78	Peak	0	400	HORIZONTAL
5	865.17	37.67	46.00	-8.33	38.78	4.48	26.88	21.29	Peak	0	400	HORIZONTAL
6	901.06	38.28	46.00	-7.72	38.99	4.60	26.82	21.51	Peak	0	400	HORIZONTAL

Vertical

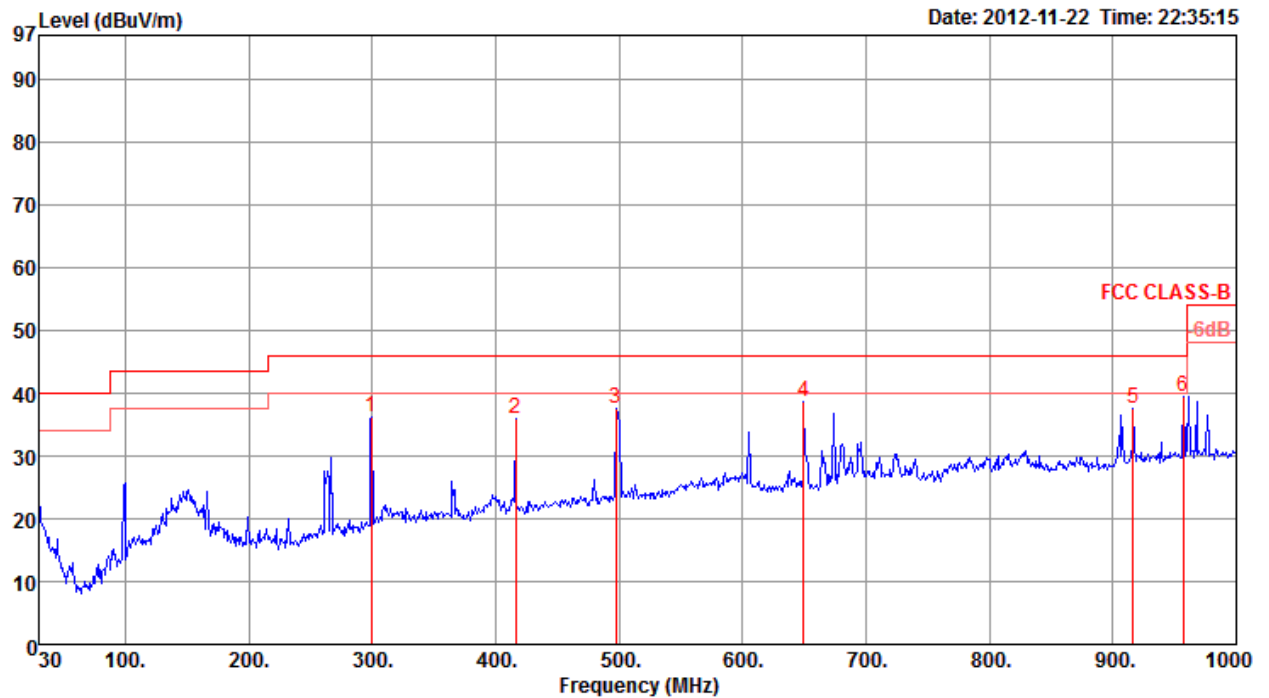

	Freq	Level	Limit	Over	Read	Cable	Preamp	Antenna	Remark	T/Pos	A/Pos	Pol/Phase
	MHz	dBuV/m	dBuV/m	dB	dBuV	dB	dB	dB/m		deg	cm	
1	299.66	36.19	46.00	-9.81	46.71	2.51	26.83	13.80	Peak	0	100	VERTICAL
2	416.06	36.01	46.00	-9.99	43.90	3.07	27.62	16.66	Peak	0	100	VERTICAL
3	497.54	37.51	46.00	-8.49	44.32	3.37	27.93	17.75	Peak	0	100	VERTICAL
4	649.83	38.58	46.00	-7.42	42.64	3.90	27.56	19.60	Peak	0	100	VERTICAL
5	916.58	37.63	46.00	-8.37	38.04	4.68	26.72	21.63	Peak	0	100	VERTICAL
6 p	957.32	39.41	46.00	-6.59	39.07	4.86	26.47	21.95	Peak	0	100	VERTICAL

Note:

The amplitude of spurious emissions that are attenuated by more than 20dB below the permissible value has no need to be reported.

Emission level (dBuV/m) = 20 log Emission level (uV/m).

Corrected Reading: Antenna Factor + Cable Loss + Read Level - Preamp Factor = Level.

4.5.9. Results for Radiated Emissions (1GHz~10th Harmonic)

Temperature	20°C	Humidity	60%
Test Engineer	Kenneth Huang	Configurations	IEEE 802.11n MCS0 20MHz Ch 1 / Ant. 1 + Ant. 2 + Ant. 3
Test Date	Nov. 15, 2012		

Horizontal

	Freq	Level	Limit Line	Over Limit	Read Level	CableAntenna Loss	Antenna Factor	Preamp Factor	Remark	A/Pos	T/Pos	Pol/Phase
	MHz	dBuV/m	dBuV/m	dB	dBuV	dB	dB/m	dB		cm	deg	
1	4824.60	45.53	74.00	-28.47	41.07	6.27	33.39	35.20	Peak	100	212	HORIZONTAL
2	4824.94	31.44	54.00	-22.56	26.98	6.27	33.39	35.20	Average	100	212	HORIZONTAL

Vertical

	Freq	Level	Limit Line	Over Limit	Read Level	CableAntenna Loss	Antenna Factor	Preamp Factor	Remark	A/Pos	T/Pos	Pol/Phase
	MHz	dBuV/m	dBuV/m	dB	dBuV	dB	dB/m	dB		cm	deg	
1	4823.39	44.90	74.00	-29.10	40.44	6.27	33.39	35.20	Peak	100	39	VERTICAL
2	4824.98	31.42	54.00	-22.58	26.96	6.27	33.39	35.20	Average	100	39	VERTICAL

Temperature	20°C	Humidity	60%
Test Engineer	Kenneth Huang	Configurations	IEEE 802.11n MCS0 20MHz Ch 6 / Ant. 1 + Ant. 2 + Ant. 3
Test Date	Nov. 15, 2012		

Horizontal

	Freq	Level	Limit	Over	Read	Cable	Antenna	Preamp	Remark	A/Pos	T/Pos	Pol/Phase
	MHz	dBuV/m	dBuV/m	dB	dBuV	dB	dB/m	dB		cm	deg	
1	4877.56	30.94	54.00	-23.06	29.48	3.33	33.16	35.03	Average	100	283	HORIZONTAL
2	4877.62	43.61	74.00	-30.39	42.15	3.33	33.16	35.03	Peak	100	283	HORIZONTAL
3	7310.41	45.21	74.00	-28.79	40.59	4.06	35.96	35.40	Peak	100	119	HORIZONTAL
4	7314.81	33.18	54.00	-20.82	28.56	4.06	35.96	35.40	Average	100	119	HORIZONTAL

Vertical

	Freq	Level	Limit	Over	Read	Cable	Antenna	Preamp	Remark	A/Pos	T/Pos	Pol/Phase
	MHz	dBuV/m	dBuV/m	dB	dBuV	dB	dB/m	dB		cm	deg	
1	4879.03	46.08	74.00	-27.92	44.62	3.33	33.16	35.03	Peak	100	70	VERTICAL
2	4879.74	33.77	54.00	-20.23	32.31	3.33	33.16	35.03	Average	100	70	VERTICAL
3	7315.57	35.64	54.00	-18.36	31.02	4.06	35.96	35.40	Average	100	328	VERTICAL
4	7315.70	48.83	74.00	-25.17	44.21	4.06	35.96	35.40	Peak	100	328	VERTICAL

Temperature	20°C	Humidity	60%
Test Engineer	Kenneth Huang	Configurations	IEEE 802.11n MCS0 20MHz Ch11 / Ant. 1 + Ant. 2 + Ant. 3
Test Date	Nov. 15, 2012		

Horizontal

	Freq	Level	Limit Line	Over Limit	Read Level	Cable Loss	Antenna Factor	Preamp Factor	Remark	A/Pos	T/Pos	Pol/Phase
	MHz	dBuV/m	dBuV/m	dB	dBuV	dB	dB/m	dB		cm	deg	
1	4926.95	29.84	54.00	-24.16	28.24	3.35	33.26	35.01	Average	100	180	HORIZONTAL
2	4928.31	42.25	74.00	-31.75	40.65	3.35	33.26	35.01	Peak	100	180	HORIZONTAL
3	7385.81	45.26	74.00	-28.74	40.51	4.06	36.09	35.40	Peak	100	85	HORIZONTAL
4	7386.47	32.79	54.00	-21.21	28.04	4.06	36.09	35.40	Average	100	85	HORIZONTAL

Vertical

	Freq	Level	Limit Line	Over Limit	Read Level	Cable Loss	Antenna Factor	Preamp Factor	Remark	A/Pos	T/Pos	Pol/Phase
	MHz	dBuV/m	dBuV/m	dB	dBuV	dB	dB/m	dB		cm	deg	
1	4922.25	30.21	54.00	-23.79	28.61	3.35	33.26	35.01	Average	100	323	VERTICAL
2	4925.60	42.60	74.00	-31.40	41.00	3.35	33.26	35.01	Peak	100	323	VERTICAL
3	7383.53	45.76	74.00	-28.24	41.01	4.06	36.09	35.40	Peak	100	211	VERTICAL
4	7387.28	33.00	54.00	-21.00	28.25	4.06	36.09	35.40	Average	100	211	VERTICAL

Temperature	20°C	Humidity	60%
Test Engineer	Kenneth Huang	Configurations	IEEE 802.11n MCS0 40MHz Ch 3 / Ant. 1 + Ant. 2 + Ant. 3
Test Date	Nov. 15, 2012		

Horizontal

	Freq	Level	Limit Line	Over Limit	Read Level	Cable Loss	Antenna Factor	Preamp Factor	Remark	A/Pos	T/Pos	Pol/Phase
	MHz	dBuV/m	dBuV/m	dB	dBuV	dB	dB/m	dB		cm	deg	
1	4841.65	42.12	74.00	-31.88	40.74	3.32	33.09	35.03	Peak	100	123	HORIZONTAL
2	4844.39	29.04	54.00	-24.96	27.66	3.32	33.09	35.03	Average	100	123	HORIZONTAL

Vertical

	Freq	Level	Limit Line	Over Limit	Read Level	Cable Loss	Antenna Factor	Preamp Factor	Remark	A/Pos	T/Pos	Pol/Phase
	MHz	dBuV/m	dBuV/m	dB	dBuV	dB	dB/m	dB		cm	deg	
1	4844.07	42.21	74.00	-31.79	40.83	3.32	33.09	35.03	Peak	100	266	VERTICAL
2	4845.70	29.24	54.00	-24.76	27.86	3.32	33.09	35.03	Average	100	266	VERTICAL

Temperature	20°C	Humidity	60%
Test Engineer	Kenneth Huang	Configurations	IEEE 802.11n MCS0 40MHz Ch 6 / Ant. 1 + Ant. 2 + Ant. 3
Test Date	Nov. 15, 2012		

Horizontal

	Freq	Level	Limit	Over	Read	Cable	Antenna	Preamp	Remark	A/Pos	T/Pos	Pol/Phase
	MHz	dBuV/m	dBuV/m	dB	dBuV	dB	dB/m	dB		cm	deg	
1	4871.60	29.12	54.00	-24.88	27.66	3.33	33.16	35.03	Average	100	286	HORIZONTAL
2	4872.53	42.14	74.00	-31.86	40.68	3.33	33.16	35.03	Peak	100	286	HORIZONTAL
3	7311.14	32.67	54.00	-21.33	28.05	4.06	35.96	35.40	Average	100	150	HORIZONTAL
4	7312.88	45.40	74.00	-28.60	40.78	4.06	35.96	35.40	Peak	100	150	HORIZONTAL

Vertical

	Freq	Level	Limit	Over	Read	Cable	Antenna	Preamp	Remark	A/Pos	T/Pos	Pol/Phase
	MHz	dBuV/m	dBuV/m	dB	dBuV	dB	dB/m	dB		cm	deg	
1	4871.63	41.71	74.00	-32.29	40.25	3.33	33.16	35.03	Peak	100	159	VERTICAL
2	4872.49	29.75	54.00	-24.25	28.29	3.33	33.16	35.03	Average	100	159	VERTICAL
3	7312.60	44.84	74.00	-29.16	40.22	4.06	35.96	35.40	Peak	100	287	VERTICAL
4	7312.68	32.69	54.00	-21.31	28.07	4.06	35.96	35.40	Average	100	287	VERTICAL

Temperature	20°C	Humidity	60%
Test Engineer	Kenneth Huang	Configurations	IEEE 802.11n MCS0 40MHz Ch 9 / Ant. 1 + Ant. 2 + Ant. 3
Test Date	Nov. 15, 2012		

Horizontal

	Freq	Level	Limit	Over	Read	CableAntenna	Preamp	Remark	A/Pos	T/Pos	Pol/Phase	
	MHz	dBuV/m	dBuV/m	dB	dBuV	dB	dB/m	dB	cm	deg		
1	4903.29	45.36	74.00	-28.64	40.72	6.33	33.51	35.20	Peak	100	215	HORIZONTAL
2	4903.86	31.70	54.00	-22.30	27.06	6.33	33.51	35.20	Average	100	215	HORIZONTAL
3	7355.90	35.75	54.00	-18.25	27.06	7.57	36.56	35.44	Average	100	92	HORIZONTAL
4	7356.43	50.40	74.00	-23.60	41.71	7.57	36.56	35.44	Peak	100	92	HORIZONTAL

Vertical

	Freq	Level	Limit	Over	Read	CableAntenna	Preamp	Remark	A/Pos	T/Pos	Pol/Phase	
	MHz	dBuV/m	dBuV/m	dB	dBuV	dB	dB/m	dB	cm	deg		
1	4903.44	31.78	54.00	-22.22	27.14	6.33	33.51	35.20	Average	100	182	VERTICAL
2	4904.82	45.59	74.00	-28.41	40.92	6.33	33.54	35.20	Peak	100	182	VERTICAL
3	7356.39	49.42	74.00	-24.58	40.73	7.57	36.56	35.44	Peak	100	84	VERTICAL
4	7356.69	35.83	54.00	-18.17	27.14	7.57	36.56	35.44	Average	100	84	VERTICAL

Temperature	20°C	Humidity	60%
Test Engineer	Kenneth Huang	Configurations	IEEE 802.11b CH 1 / Ant. 1 + Ant. 2 + Ant. 3
Test Date	Nov. 15, 2012		

Horizontal

	Freq	Level	Limit Line	Over Limit	Read Level	Cable Loss	Antenna Factor	Preamp Factor	Remark	A/Pos	T/Pos	Pol/Phase
	MHz	dBuV/m	dBuV/m	dB	dBuV	dB	dB/m	dB		cm	deg	
1	4823.99	37.40	54.00	-16.60	36.06	3.31	33.06	35.03	Average	100	166	HORIZONTAL
2	4823.99	45.52	74.00	-28.48	44.18	3.31	33.06	35.03	Peak	100	166	HORIZONTAL

Vertical

	Freq	Level	Limit Line	Over Limit	Read Level	Cable Loss	Antenna Factor	Preamp Factor	Remark	A/Pos	T/Pos	Pol/Phase
	MHz	dBuV/m	dBuV/m	dB	dBuV	dB	dB/m	dB		cm	deg	
1	4823.86	48.07	74.00	-25.93	46.73	3.31	33.06	35.03	Peak	100	244	VERTICAL
2	4824.02	43.29	54.00	-10.71	41.95	3.31	33.06	35.03	Average	100	244	VERTICAL

Temperature	20°C	Humidity	60%
Test Engineer	Kenneth Huang	Configurations	IEEE 802.11b CH 6 / Ant. 1 + Ant. 2 + Ant. 3
Test Date	Nov. 15, 2012		

Horizontal

	Freq	Level	Limit	Over	Read	Cable	Antenna	Preamp	Remark	A/Pos	T/Pos	Pol/Phase
	MHz	dBuV/m	dBuV/m	dB	dBuV	dB	dB/m	dB		cm	deg	
1	4873.97	47.02	74.00	-26.98	45.56	3.33	33.16	35.03	Peak	101	130	HORIZONTAL
2	4874.00	41.73	54.00	-12.27	40.27	3.33	33.16	35.03	Average	101	130	HORIZONTAL
3	7310.17	45.67	74.00	-28.33	41.05	4.06	35.96	35.40	Peak	100	257	HORIZONTAL
4	7310.31	33.13	54.00	-20.87	28.51	4.06	35.96	35.40	Average	100	257	HORIZONTAL

Vertical

	Freq	Level	Limit	Over	Read	Cable	Antenna	Preamp	Remark	A/Pos	T/Pos	Pol/Phase
	MHz	dBuV/m	dBuV/m	dB	dBuV	dB	dB/m	dB		cm	deg	
1	4873.94	49.82	74.00	-24.18	48.36	3.33	33.16	35.03	Peak	109	212	VERTICAL
2	4874.00	46.45	54.00	-7.55	44.99	3.33	33.16	35.03	Average	109	212	VERTICAL
3	7310.25	36.78	54.00	-17.22	32.16	4.06	35.96	35.40	Average	100	72	VERTICAL
4	7311.40	47.59	74.00	-26.41	42.97	4.06	35.96	35.40	Peak	100	72	VERTICAL

Temperature	20°C	Humidity	60%
Test Engineer	Kenneth Huang	Configurations	IEEE 802.11b CH 11 / Ant. 1 + Ant. 2 + Ant. 3
Test Date	Nov. 15, 2012		

Horizontal

	Freq	Level	Limit	Over	Read	Cable	Antenna	Preamp	Remark	A/Pos	T/Pos	Pol/Phase
	MHz	dBuV/m	dBuV/m	dB	dBuV	dB	dB/m	dB		cm	deg	
1	4924.01	46.24	74.00	-27.76	44.64	3.35	33.26	35.01	Peak	178	296	HORIZONTAL
2	4924.02	39.01	54.00	-14.99	37.41	3.35	33.26	35.01	Average	178	296	HORIZONTAL
3	7384.27	45.05	74.00	-28.95	40.30	4.06	36.09	35.40	Peak	100	136	HORIZONTAL
4	7387.09	32.80	54.00	-21.20	28.05	4.06	36.09	35.40	Average	100	136	HORIZONTAL

Vertical

	Freq	Level	Limit	Over	Read	Cable	Antenna	Preamp	Remark	A/Pos	T/Pos	Pol/Phase
	MHz	dBuV/m	dBuV/m	dB	dBuV	dB	dB/m	dB		cm	deg	
1	4924.00	45.11	54.00	-8.89	43.51	3.35	33.26	35.01	Average	105	150	VERTICAL
2	4924.04	49.67	74.00	-24.33	48.07	3.35	33.26	35.01	Peak	105	150	VERTICAL
3	7385.04	34.81	54.00	-19.19	30.06	4.06	36.09	35.40	Average	100	77	VERTICAL
4	7385.33	45.26	74.00	-28.74	40.51	4.06	36.09	35.40	Peak	100	77	VERTICAL

Temperature	20°C	Humidity	60%
Test Engineer	Kenneth Huang	Configurations	IEEE 802.11g CH 1 / Ant. 1 + Ant. 2 + Ant. 3
Test Date	Nov. 15, 2012		

Horizontal

	Freq	Level	Limit Line	Over Limit	Read Level	Cable Loss	Antenna Factor	Preamp Factor	Remark	A/Pos	T/Pos	Pol/Phase
	MHz	dBuV/m	dBuV/m	dB	dBuV	dB	dB/m	dB		cm	deg	
1	4828.04	29.55	54.00	-24.45	28.21	3.31	33.06	35.03	Average	100	168	HORIZONTAL
2	4833.01	41.38	74.00	-32.62	40.04	3.31	33.06	35.03	Peak	100	168	HORIZONTAL

Vertical

	Freq	Level	Limit Line	Over Limit	Read Level	Cable Loss	Antenna Factor	Preamp Factor	Remark	A/Pos	T/Pos	Pol/Phase
	MHz	dBuV/m	dBuV/m	dB	dBuV	dB	dB/m	dB		cm	deg	
1	4830.03	29.54	54.00	-24.46	28.20	3.31	33.06	35.03	Average	100	253	VERTICAL
2	4832.53	41.63	74.00	-32.37	40.29	3.31	33.06	35.03	Peak	100	253	VERTICAL

Temperature	20°C	Humidity	60%
Test Engineer	Kenneth Huang	Configurations	IEEE 802.11g CH 6 / Ant. 1 + Ant. 2 + Ant. 3
Test Date	Nov. 15, 2012		

Horizontal

	Freq	Level	Limit Line	Over Limit	Read Level	Cable Loss	Antenna Factor	Preamp Factor	Remark	A/Pos	T/Pos	Pol/Phase
	MHz	dBuV/m	dBuV/m	dB	dBuV	dB	dB/m	dB		cm	deg	
1	4871.34	43.02	74.00	-30.98	41.56	3.33	33.16	35.03	Peak	100	167	HORIZONTAL
2	4872.27	31.29	54.00	-22.71	29.83	3.33	33.16	35.03	Average	100	167	HORIZONTAL
3	7301.74	45.35	74.00	-28.65	40.77	4.06	35.92	35.40	Peak	100	240	HORIZONTAL
4	7313.44	33.18	54.00	-20.82	28.56	4.06	35.96	35.40	Average	100	240	HORIZONTAL

Vertical

	Freq	Level	Limit Line	Over Limit	Read Level	Cable Loss	Antenna Factor	Preamp Factor	Remark	A/Pos	T/Pos	Pol/Phase
	MHz	dBuV/m	dBuV/m	dB	dBuV	dB	dB/m	dB		cm	deg	
1	4876.95	45.08	74.00	-28.92	43.62	3.33	33.16	35.03	Peak	100	60	VERTICAL
2	4877.62	33.94	54.00	-20.06	32.48	3.33	33.16	35.03	Average	100	60	VERTICAL
3	7303.72	48.42	74.00	-25.58	43.84	4.06	35.92	35.40	Peak	100	81	VERTICAL
4	7313.28	35.96	54.00	-18.04	31.34	4.06	35.96	35.40	Average	100	81	VERTICAL

Temperature	20°C	Humidity	60%
Test Engineer	Kenneth Huang	Configurations	IEEE 802.11g CH 11 / Ant. 1 + Ant. 2 + Ant. 3
Test Date	Nov. 15, 2012		

Horizontal

	Freq	Level	Limit Line	Over Limit	Read Level	CableAntenna Loss	Antenna Factor	Preamp Factor	Remark	A/Pos	T/Pos	Pol/Phase
	MHz	dBuV/m	dBuV/m	dB	dBuV	dB	dB/m	dB		cm	deg	
1	4914.29	29.80	54.00	-24.20	28.24	3.35	33.23	35.02	Average	100	63	HORIZONTAL
2	4920.19	41.58	74.00	-32.42	40.01	3.35	33.23	35.01	Peak	100	63	HORIZONTAL
3	7383.05	32.65	54.00	-21.35	27.90	4.06	36.09	35.40	Average	100	215	HORIZONTAL
4	7384.40	45.18	74.00	-28.82	40.43	4.06	36.09	35.40	Peak	100	215	HORIZONTAL

Vertical

	Freq	Level	Limit Line	Over Limit	Read Level	CableAntenna Loss	Antenna Factor	Preamp Factor	Remark	A/Pos	T/Pos	Pol/Phase
	MHz	dBuV/m	dBuV/m	dB	dBuV	dB	dB/m	dB		cm	deg	
1	4917.49	29.80	54.00	-24.20	28.24	3.35	33.23	35.02	Average	100	175	VERTICAL
2	4927.56	42.41	74.00	-31.59	40.81	3.35	33.26	35.01	Peak	100	175	VERTICAL
3	7381.00	44.93	74.00	-29.07	40.18	4.06	36.09	35.40	Peak	100	259	VERTICAL
4	7382.51	32.66	54.00	-21.34	27.91	4.06	36.09	35.40	Average	100	259	VERTICAL

4.6. Band Edge Emissions Measurement

4.6.1. Limit

30dBc in any 100 kHz bandwidth outside the operating frequency band. In case the emission fall within the restricted band specified on 15.205(a), then the 15.209(a) limit in the table below has to be followed.

Frequencies (MHz)	Field Strength (micorvolts/meter)	Measurement Distance (meters)
0.009~0.490	2400/F(KHz)	300
0.490~1.705	24000/F(KHz)	30
1.705~30.0	30	30
30~88	100	3
88~216	150	3
216~960	200	3
Above 960	500	3

4.6.2. Measuring Instruments and Setting

Please refer to section 5 of equipments list in this report. The following table is the setting of the spectrum analyzer.

Spectrum Parameter	Setting
Attenuation	Auto
Span Frequency	100 MHz
RB / VB (Emission in restricted band)	1MHz / 3MHz for Peak, 1 MHz / 10Hz for Average
RB / VB (Emission in non-restricted band)	100 KHz / 300 KHz for Peak

4.6.3. Test Procedures

- The test procedure is the same as section 4.5.3, only the frequency range investigated is limited to 100MHz around bandedges.

4.6.4. Test Setup Layout

This test setup layout is the same as that shown in section 4.5.4.

4.6.5. Test Deviation

There is no deviation with the original standard.

4.6.6. EUT Operation during Test

The EUT was programmed to be in continuously transmitting mode.

4.6.7. Test Result of Band Edge and Fundamental Emissions

Temperature	20°C	Humidity	60%
Test Engineer	Kenneth Huang	Configurations	IEEE 802.11n MCS0 20MHz Ch 1, 6, 11 / Ant. 1 + Ant. 2 + Ant. 3
Test date	Nov. 15, 2012		

Channel 1

	Freq	Level	Limit Line	Over Limit	Read Level	CableAntenna Loss	Antenna Factor	Preamp Factor	Remark	A/Pos	T/Pos	Pol/Phase
	MHz	dBuV/m	dBuV/m	dB	dBuV	dB	dB/m	dB		cm	deg	
1	2389.00	69.27	74.00	-4.73	36.88	4.34	28.05	0.00	Peak	143	326	VERTICAL
2	2390.00	52.54	54.00	-1.46	20.15	4.34	28.05	0.00	Average	143	326	VERTICAL
3	2409.40	97.01				4.34	28.09	0.00	Average	143	326	VERTICAL
4	2409.40	110.69				4.34	28.09	0.00	Peak	143	326	VERTICAL

Item 3, 4 are the fundamental frequency at 2412 MHz.

Channel 6

	Freq	Level	Limit Line	Over Limit	Read Level	CableAntenna Loss	Antenna Factor	Preamp Factor	Remark	A/Pos	T/Pos	Pol/Phase
	MHz	dBuV/m	dBuV/m	dB	dBuV	dB	dB/m	dB		cm	deg	
1	2356.03	50.67	54.00	-3.33	20.38	2.19	28.10	0.00	Average	100	293	VERTICAL
2	2356.03	60.76	74.00	-13.24	30.47	2.19	28.10	0.00	Peak	100	293	VERTICAL
3	2444.05	112.20				2.24	28.29	0.00	Average	100	293	VERTICAL
4	2444.05	121.51				2.24	28.29	0.00	Peak	100	293	VERTICAL
5	2484.46	64.90	74.00	-9.10	34.27	2.26	28.37	0.00	Peak	100	293	VERTICAL
6	2484.78	52.21	54.00	-1.79	21.58	2.26	28.37	0.00	Average	100	293	VERTICAL

Item 3, 4 are the fundamental frequency at 2437MHz.

Channel 11

	Freq	Level	Limit Line	Over Limit	Read Level	CableAntenna Loss	Antenna Factor	Preamp Factor	Remark	A/Pos	T/Pos	Pol/Phase
	MHz	dBuV/m	dBuV/m	dB	dBuV	dB	dB/m	dB		cm	deg	
1	2463.44	115.41				2.24	28.33	0.00	Peak	100	23	VERTICAL
2	2463.60	105.13				2.24	28.33	0.00	Average	100	23	VERTICAL
3	2483.50	52.69	54.00	-1.31	22.06	2.26	28.37	0.00	Average	100	23	VERTICAL
4	2483.50	64.06	74.00	-9.94	33.43	2.26	28.37	0.00	Peak	100	23	VERTICAL

Item 1, 2 are the fundamental frequency at 2462 MHz.

Temperature	20°C	Humidity	60%
Test Engineer	Kenneth Huang	Configurations	IEEE 802.11n MCS0 40MHz Ch 3, 6, 9 / Ant. 1 + Ant. 2 + Ant. 3
Test date	Nov. 15, 2012		

Channel 3

	Freq	Level	Limit Line	Over Limit	Read Level	Cable Loss	Antenna Factor	Preamp Factor	Remark	A/Pos	T/Pos	Pol/Phase
	MHz	dBuV/m	dBuV/m	dB	dBuV	dB	dB/m	dB		cm	deg	
1	2390.00	52.52	54.00	-1.48	22.13	2.22	28.17	0.00	Average	100	19	VERTICAL
2	2390.00	68.87	74.00	-5.13	38.48	2.22	28.17	0.00	Peak	100	19	VERTICAL
3	2428.09	99.12				2.23	28.25	0.00	Average	100	19	VERTICAL
4	2428.09	108.71				2.23	28.25	0.00	Peak	100	19	VERTICAL

Item 3, 4 are the fundamental frequency at 2422 MHz.

Channel 6

	Freq	Level	Limit Line	Over Limit	Read Level	Cable Loss	Antenna Factor	Preamp Factor	Remark	A/Pos	T/Pos	Pol/Phase
	MHz	dBuV/m	dBuV/m	dB	dBuV	dB	dB/m	dB		cm	deg	
1	2388.08	66.96	74.00	-7.04	36.58	2.21	28.17	0.00	Peak	100	21	VERTICAL
2	2390.00	52.63	54.00	-1.37	22.24	2.22	28.17	0.00	Average	100	21	VERTICAL
3	2448.22	114.52				2.24	28.29	0.00	Peak	100	21	VERTICAL
4	2448.54	105.35				2.24	28.29	0.00	Average	100	21	VERTICAL
5	2484.46	64.40	74.00	-9.60	33.77	2.26	28.37	0.00	Peak	100	21	VERTICAL
6	2485.74	51.49	54.00	-2.51	20.82	2.26	28.41	0.00	Average	100	21	VERTICAL

Item 3, 4 are the fundamental frequency at 2437MHz.

Channel 9

	Freq	Level	Limit Line	Over Limit	Read Level	Cable Loss	Antenna Factor	Preamp Factor	Remark	A/Pos	T/Pos	Pol/Phase
	MHz	dBuV/m	dBuV/m	dB	dBuV	dB	dB/m	dB		cm	deg	
1	2441.60	105.40				4.38	28.18	0.00	Peak	137	50	VERTICAL
2	2463.60	92.93				4.40	28.22	0.00	Average	137	50	VERTICAL
3	2483.50	52.69	54.00	-1.31	20.03	4.40	28.26	0.00	Average	137	50	VERTICAL
4	2483.50	70.13	74.00	-3.87	37.47	4.40	28.26	0.00	Peak	137	50	VERTICAL

Item 1, 2 are the fundamental frequency at 2452 MHz.

Note:

Emission level (dBuV/m) = 20 log Emission level (uV/m).

Corrected Reading: Antenna Factor + Cable Loss + Read Level - Preamp Factor = Level.

Temperature	20°C	Humidity	60%
Test Engineer	Kenneth Huang	Configurations	IEEE 802.11b CH 1, 6, 11 / Ant. 1 + Ant. 2 + Ant. 3
Test Date	Nov. 15, 2012		

Channel 1

	Freq	Level	Limit Line	Over Limit	Read Level	Cable Loss	Antenna Factor	Preamp Factor	Remark	A/Pos	T/Pos	Pol/Phase
	MHz	dBuV/m	dBuV/m	dB	dBuV	dB	dB/m	dB		cm	deg	
1	2389.68	48.37	54.00	-5.63	17.99	2.21	28.17	0.00	Average	118	147	VERTICAL
2	2389.68	57.68	74.00	-16.32	27.30	2.21	28.17	0.00	Peak	118	147	VERTICAL
3	2409.44	119.25				2.22	28.21	0.00	Peak	118	147	VERTICAL
4	2410.40	116.05				2.22	28.21	0.00	Average	118	147	VERTICAL
5	2490.87	52.83	54.00	-1.17	22.16	2.26	28.41	0.00	Average	118	147	VERTICAL
6	2493.12	63.59	74.00	-10.41	32.91	2.27	28.41	0.00	Peak	118	147	VERTICAL

Item 3, 4 are the fundamental frequency at 2412 MHz.

Channel 6

	Freq	Level	Limit Line	Over Limit	Read Level	Cable Loss	Antenna Factor	Preamp Factor	Remark	A/Pos	T/Pos	Pol/Phase
	MHz	dBuV/m	dBuV/m	dB	dBuV	dB	dB/m	dB		cm	deg	
1	2352.50	61.03	74.00	-12.97	30.74	2.19	28.10	0.00	Peak	100	216	VERTICAL
2	2352.82	51.58	54.00	-2.42	21.29	2.19	28.10	0.00	Average	100	216	VERTICAL
3	2435.08	114.13				2.23	28.29	0.00	Peak	100	216	VERTICAL
4	2435.40	111.16				2.23	28.29	0.00	Average	100	216	VERTICAL
5	2496.00	49.54	54.00	-4.46	18.86	2.27	28.41	0.00	Average	100	216	VERTICAL
6	2496.00	59.32	74.00	-14.68	28.64	2.27	28.41	0.00	Peak	100	216	VERTICAL

Item 3, 4 are the fundamental frequency at 2437 MHz.

Channel 11

	Freq	Level	Limit Line	Over Limit	Read Level	Cable Loss	Antenna Factor	Preamp Factor	Remark	A/Pos	T/Pos	Pol/Phase
	MHz	dBuV/m	dBuV/m	dB	dBuV	dB	dB/m	dB		cm	deg	
1	2460.08	116.49				2.24	28.33	0.00	Average	104	180	VERTICAL
2	2461.36	120.14				2.24	28.33	0.00	Peak	104	180	VERTICAL
3	2483.50	52.78	54.00	-1.22	22.15	2.26	28.37	0.00	Average	104	180	VERTICAL
4	2483.50	63.53	74.00	-10.47	32.90	2.26	28.37	0.00	Peak	104	180	VERTICAL

Item 1, 2 are the fundamental frequency at 2462 MHz.

Temperature	20°C	Humidity	60%
Test Engineer	Kenneth Huang	Configurations	IEEE 802.11g CH 1, 6, 11 / Ant. 1 + Ant. 2 + Ant. 3
Test Date	Nov. 15, 2012		

Channel 1

	Freq	Level	Limit Line	Over Limit	Read Level	Cable Loss	Antenna Factor	Preamp Factor	Remark	A/Pos	T/Pos	Pol/Phase
	MHz	dBuV/m	dBuV/m	dB	dBuV	dB	dB/m	dB		cm	deg	
1	2389.68	65.22	74.00	-8.78	34.84	2.21	28.17	0.00	Peak	119	135	VERTICAL
2	2390.00	52.56	54.00	-1.44	22.17	2.22	28.17	0.00	Average	119	135	VERTICAL
3	2410.72	108.21				2.22	28.21	0.00	Average	119	135	VERTICAL
4	2411.36	118.28				2.22	28.21	0.00	Peak	119	135	VERTICAL

Item 3, 4 are the fundamental frequency at 2412 MHz.

Channel 6

	Freq	Level	Limit Line	Over Limit	Read Level	Cable Loss	Antenna Factor	Preamp Factor	Remark	A/Pos	T/Pos	Pol/Phase
	MHz	dBuV/m	dBuV/m	dB	dBuV	dB	dB/m	dB		cm	deg	
1	2389.68	64.13	74.00	-9.87	33.75	2.21	28.17	0.00	Peak	100	119	VERTICAL
2	2390.00	52.04	54.00	-1.96	21.65	2.22	28.17	0.00	Average	100	119	VERTICAL
3	2430.27	111.94				2.23	28.25	0.00	Average	100	119	VERTICAL
4	2430.27	121.97				2.23	28.25	0.00	Peak	100	119	VERTICAL
5	2485.10	50.28	54.00	-3.72	19.61	2.26	28.41	0.00	Average	100	119	VERTICAL
6	2485.10	61.71	74.00	-12.29	31.04	2.26	28.41	0.00	Peak	100	119	VERTICAL

Item 3, 4 are the fundamental frequency at 2437 MHz.

Channel 11

	Freq	Level	Limit Line	Over Limit	Read Level	Cable Loss	Antenna Factor	Preamp Factor	Remark	A/Pos	T/Pos	Pol/Phase
	MHz	dBuV/m	dBuV/m	dB	dBuV	dB	dB/m	dB		cm	deg	
1	2462.96	104.48				2.24	28.33	0.00	Average	104	166	VERTICAL
2	2463.28	113.78				2.24	28.33	0.00	Peak	104	166	VERTICAL
3	2483.50	52.13	54.00	-1.87	21.50	2.26	28.37	0.00	Average	104	166	VERTICAL
4	2484.46	65.20	74.00	-8.80	34.57	2.26	28.37	0.00	Peak	104	166	VERTICAL

Item 1, 2 are the fundamental frequency at 2462 MHz.

For Emission not in Restricted Band

Plot on Configuration IEEE 802.11n MCS0 20MHz / Reference Level

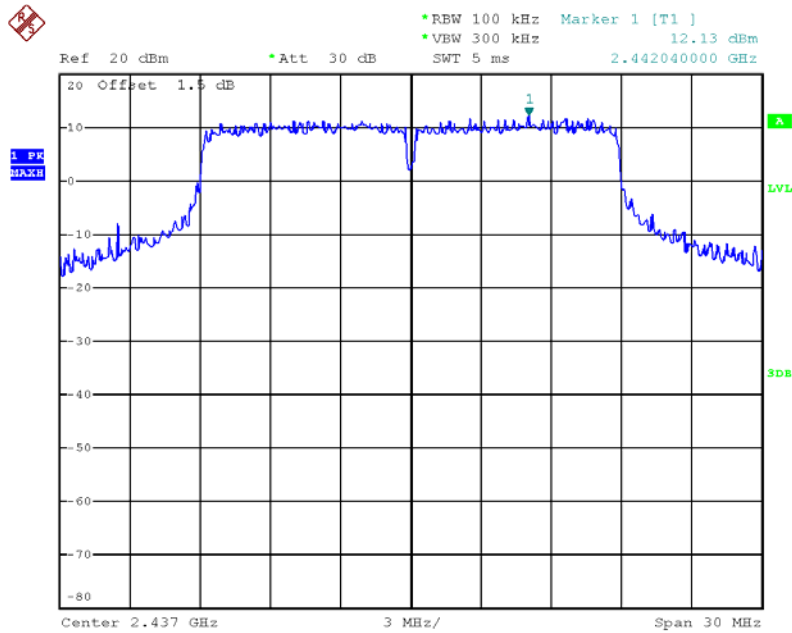

Date: 22.NOV.2012 16:33:51

Plot on Configuration IEEE 802.11n MCS0 20MHz / CH 1 (down 30dBc)

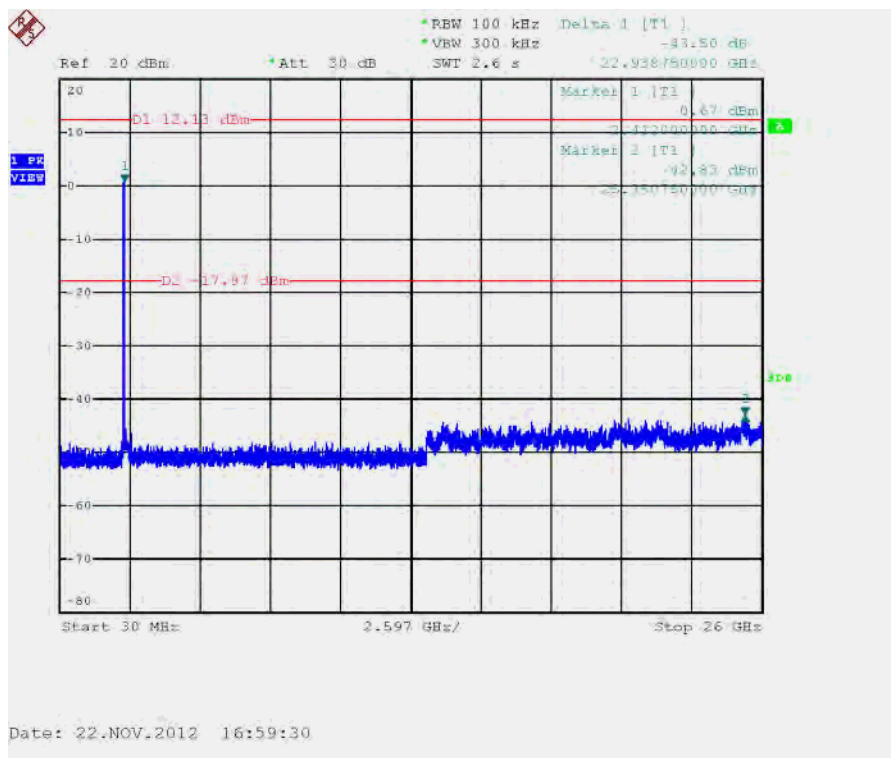

Plot on Configuration IEEE 802.11n MCS0 20MHz / CH 6 (down 30dBc)

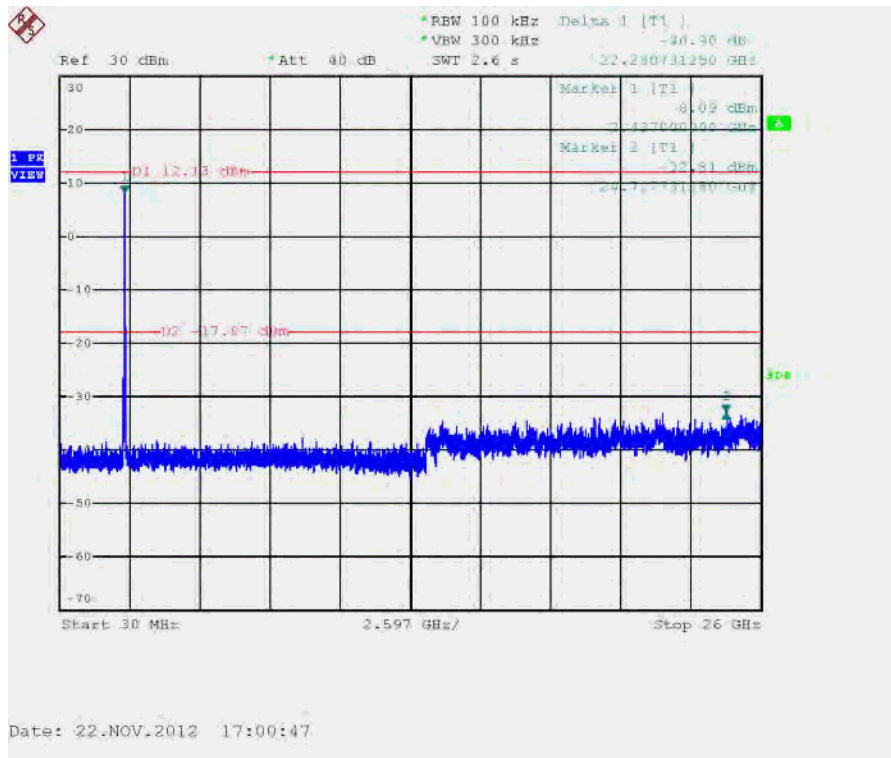

Plot on Configuration IEEE 802.11n MCS0 20MHz / CH 11 (down 30dBc)

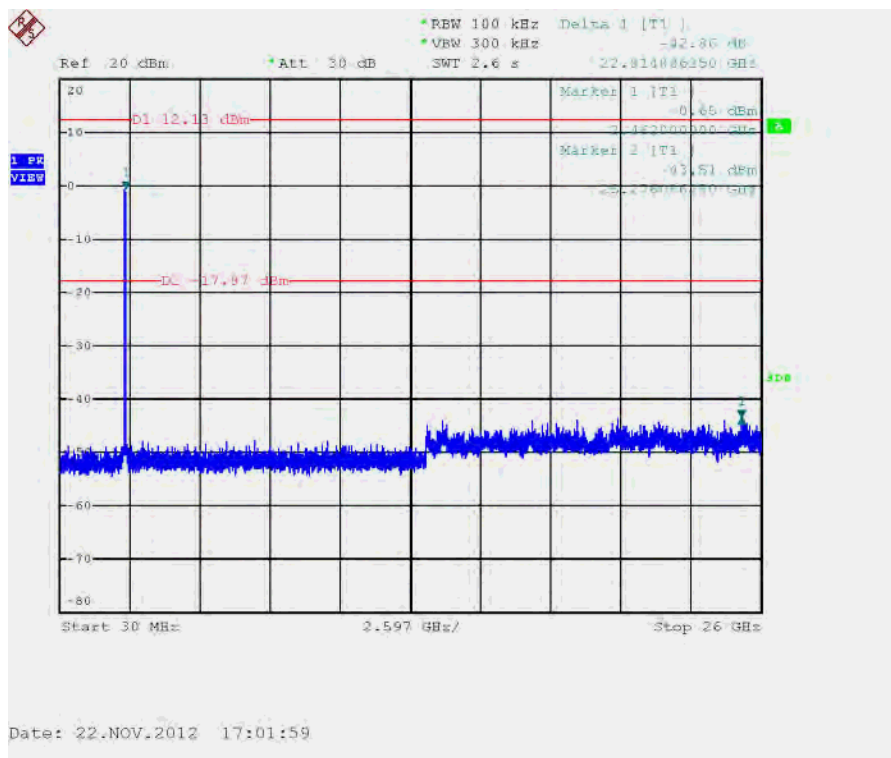

Plot on Configuration IEEE 802.11n MCS0 40MHz / Reference Level

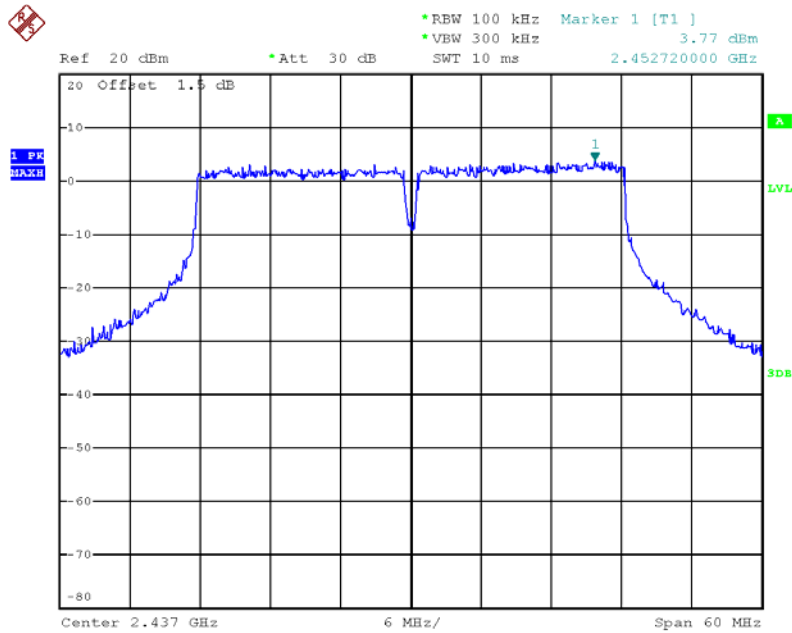

Date: 22.NOV.2012 16:30:39

Plot on Configuration IEEE 802.11n MCS0 40MHz / CH 3 (down 30dBc)

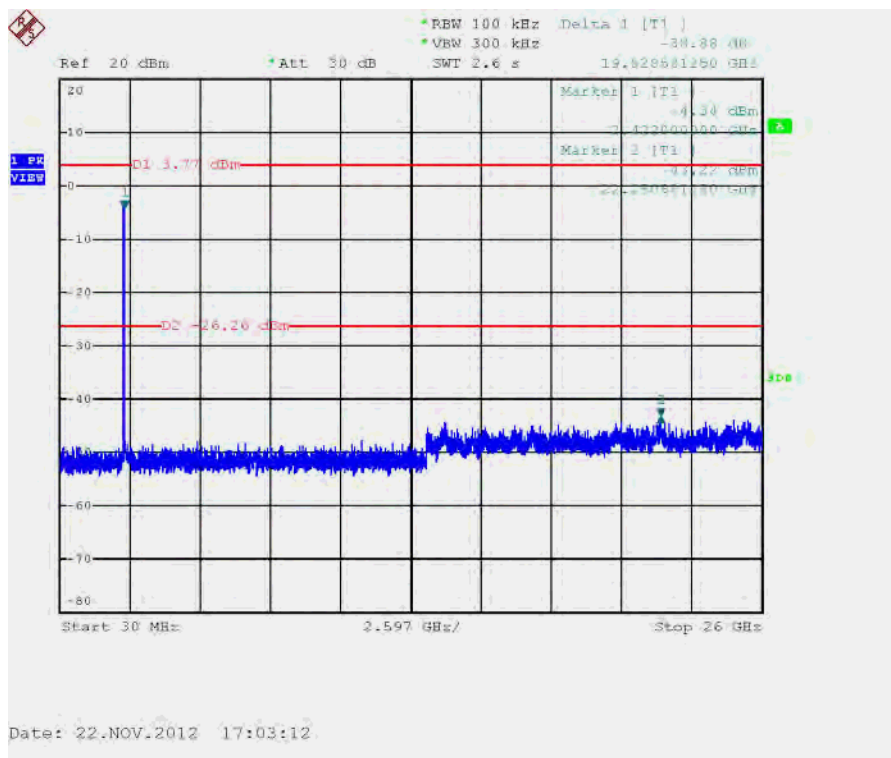

Plot on Configuration IEEE 802.11n MCS0 40MHz / CH 6 (down 30dBc)

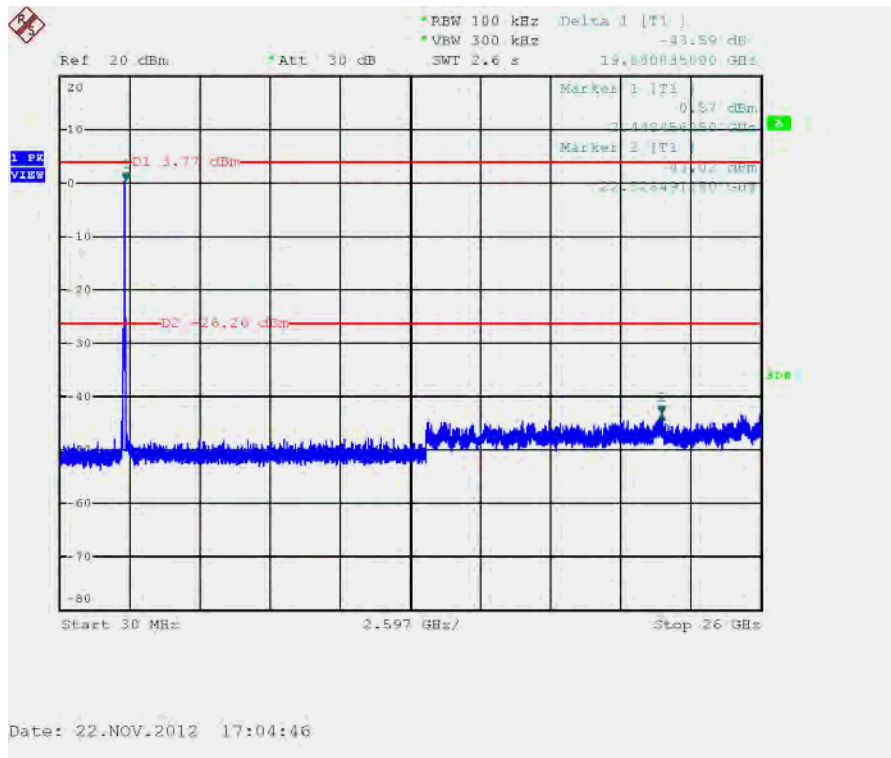

Plot on Configuration IEEE 802.11n MCS0 40MHz / CH 9 (down 30dBc)

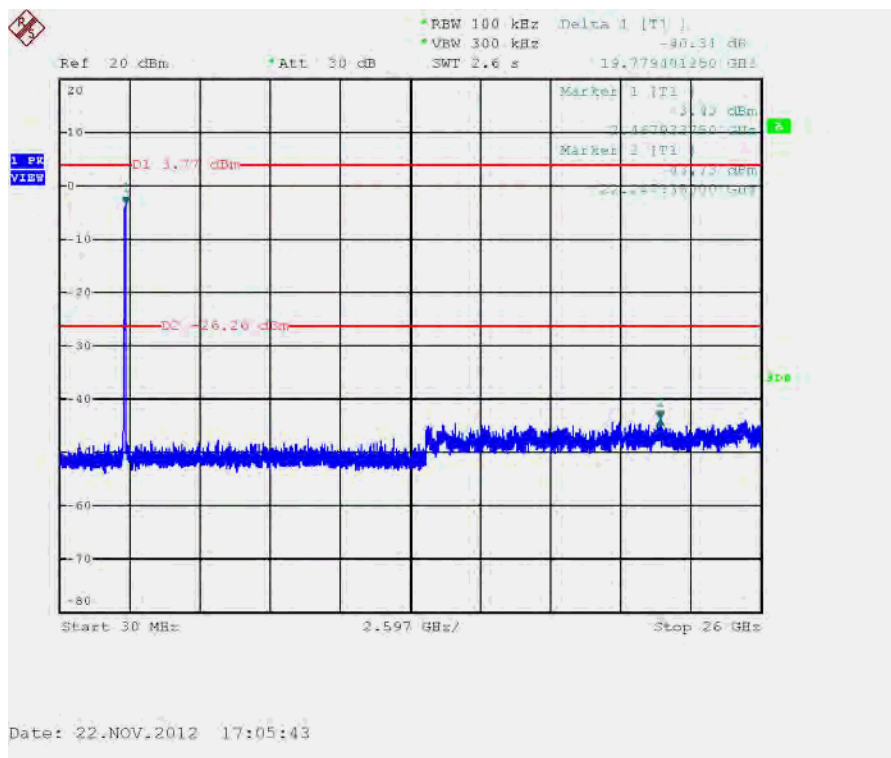

Plot on Configuration IEEE 802.11b / Reference Level

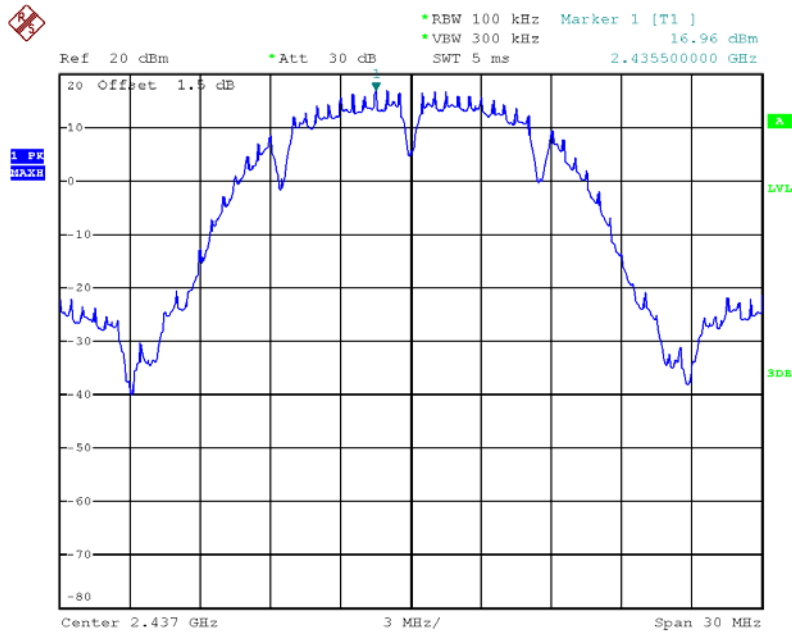

Date: 22.NOV.2012 16:37:32

Plot on Configuration IEEE 802.11b / CH 1 (down 30dBc)

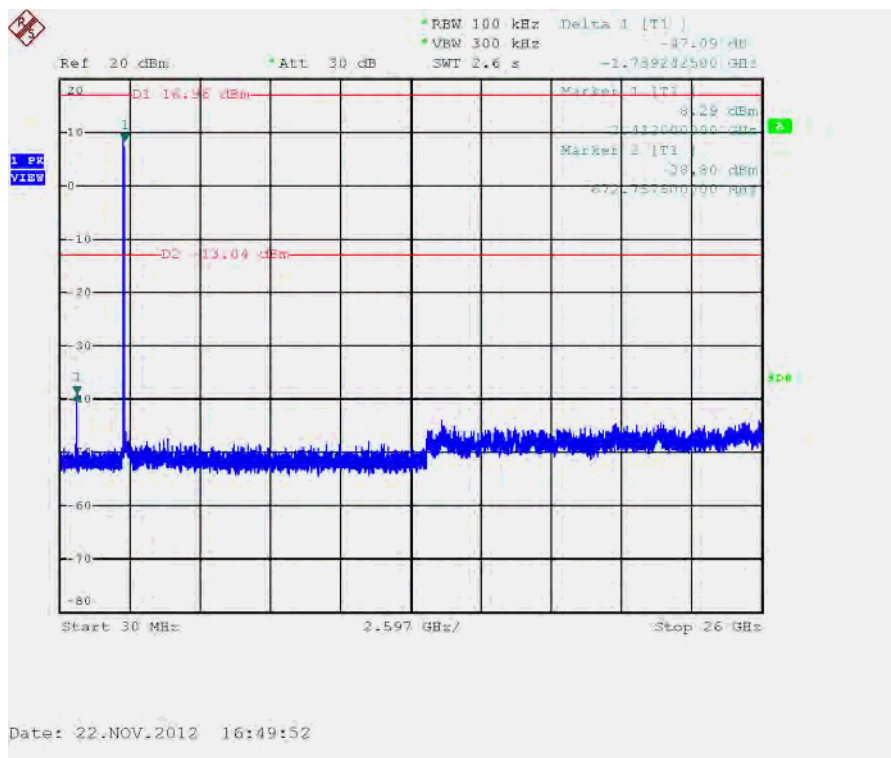

Plot on Configuration IEEE 802.11b / CH 6 (down 30dBc)

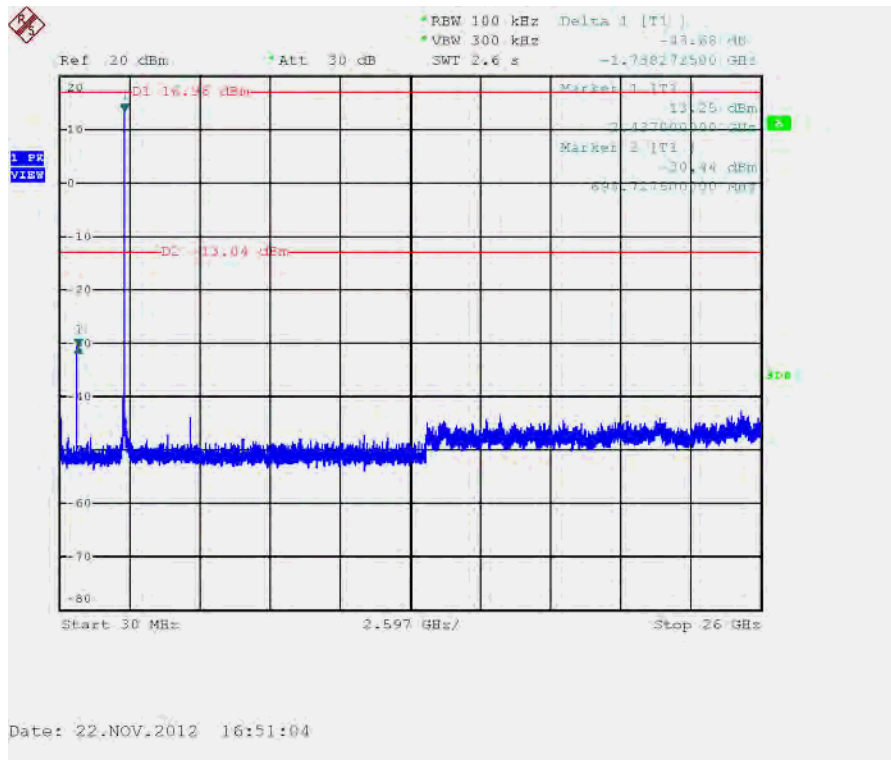

Plot on Configuration IEEE 802.11b / CH 11 (down 30dBc)

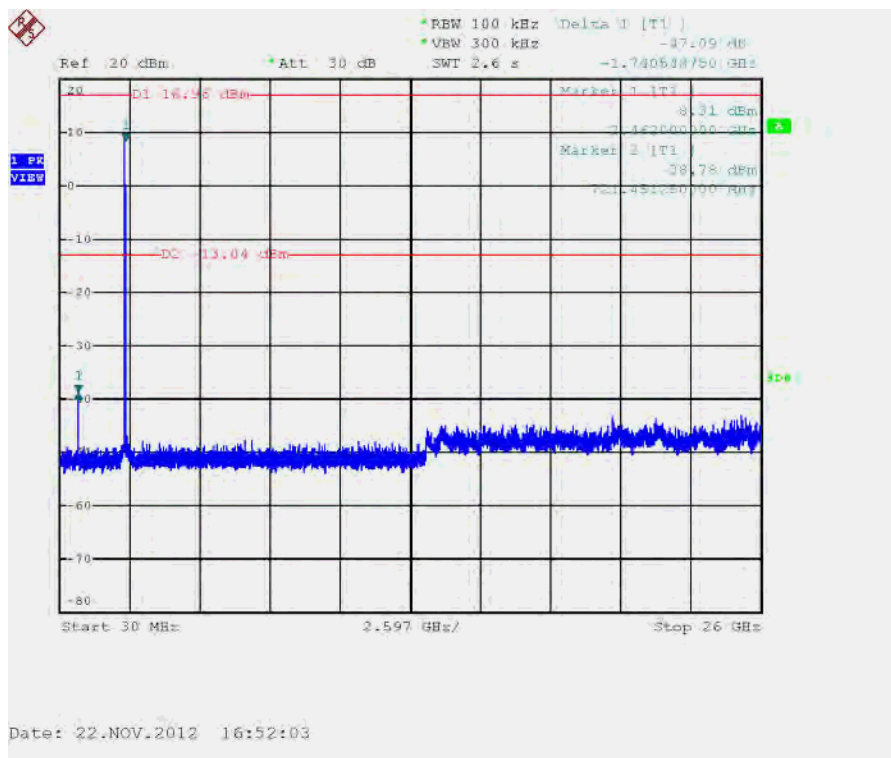

Plot on Configuration IEEE 802.11g / Reference Level

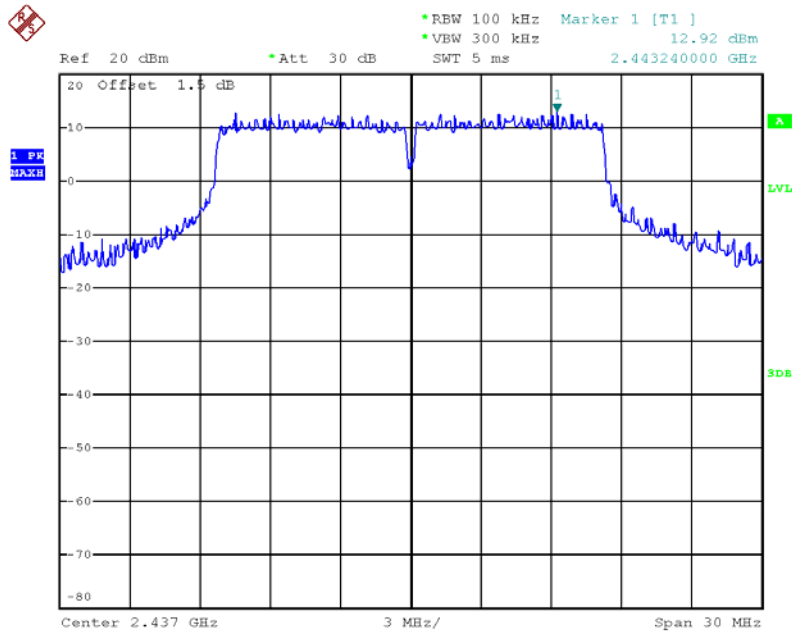

Date: 22.NOV.2012 16:35:49

Plot on Configuration IEEE 802.11g / CH 1 (down 30dBc)

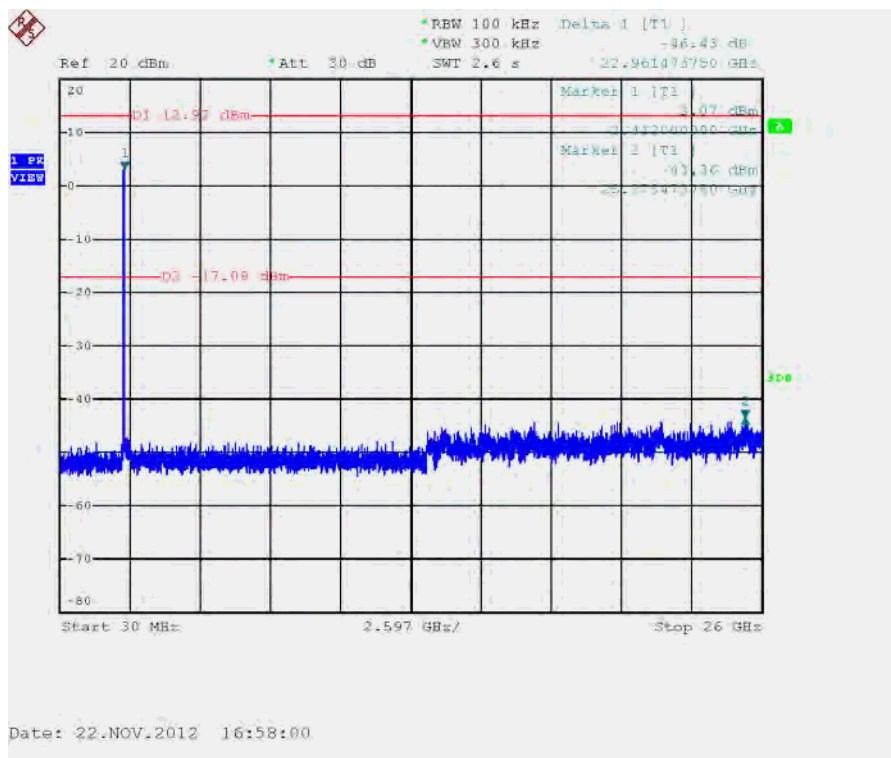

Date: 22.NOV.2012 16:58:00

Plot on Configuration IEEE 802.11g / CH 6 (down 30dBc)

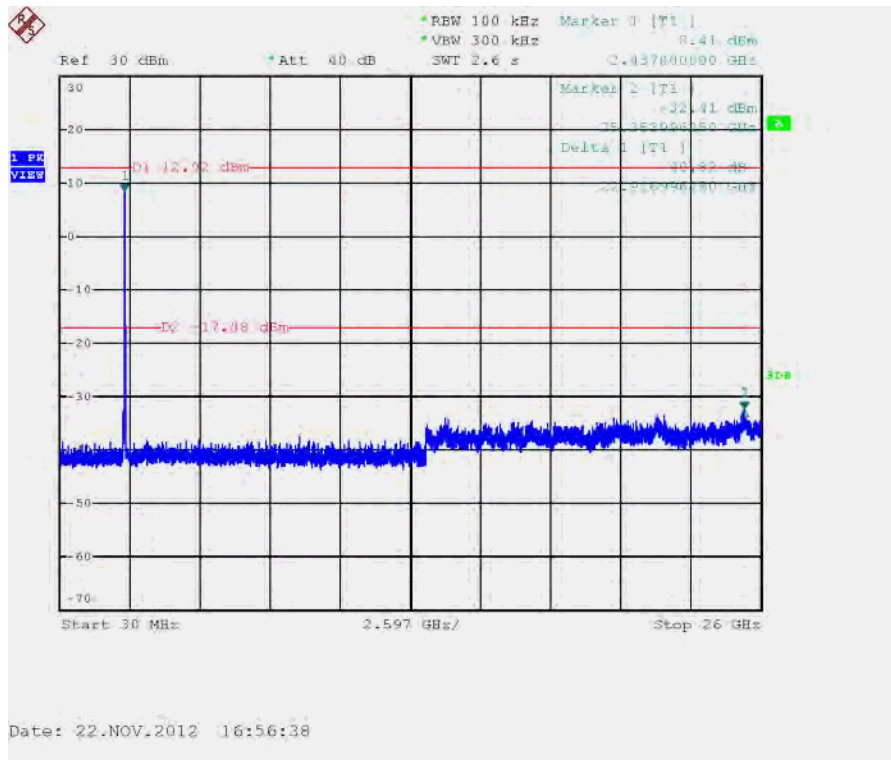

Plot on Configuration IEEE 802.11g / CH 11 (down 30dBc)

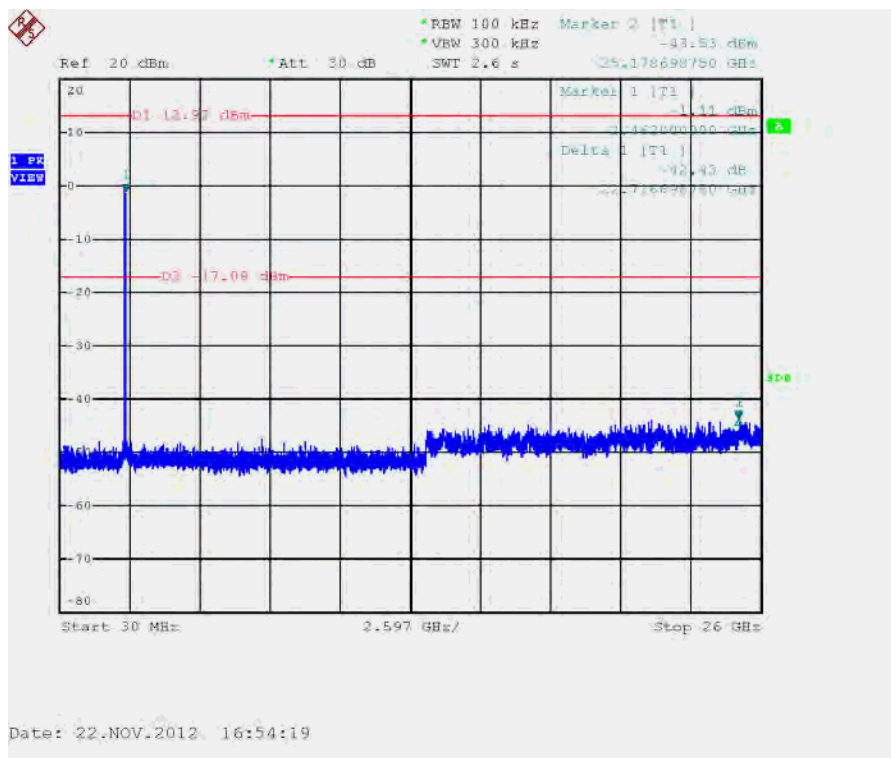

4.7. Antenna Requirements

4.7.1. Limit

Except for special regulations, the Low-power Radio-frequency Devices must not be equipped with any jacket for installing an antenna with extension cable. An intentional radiator shall be designed to ensure that no antenna other than that furnished by the responsible party shall be used with the device. The use of a permanently attached antenna or of an antenna that uses a unique coupling to the intentional radiator shall be considered sufficient to comply with the provisions of this Section. The manufacturer may design the unit so that the user can replace a broken antenna, but the use of a standard antenna jack or electrical connector is prohibited. Further, this requirement does not apply to intentional radiators that must be professionally installed.

4.7.2. Antenna Connector Construction

Please refer to section 3.3 in this test report; antenna connector complied with the requirements.

5. LIST OF MEASURING EQUIPMENTS

Instrument	Manufacturer	Model No.	Serial No.	Characteristics	Calibration Date	Remark
BILOG ANTENNA	Schaffner	CBL6112D	22021	20MHz ~ 2GHz	Jan. 11, 2012	Radiation (03CH01-CB)
Horn Antenna	EMCO	3115	00075790	750MHz~18GHz	Nov. 25, 2011	Radiation (03CH01-CB)
Horn Antenna	SCHWARZBEAK	BBHA 9170	BBHA9170252	15GHz ~ 40GHz	Nov. 22, 2011	Radiation (03CH01-CB)
Horn Antenna	SCHWARZBEAK	BBHA 9170	BBHA9170252	15GHz ~ 40GHz	Nov. 22, 2012	Radiation (03CH01-CB)
Pre-Amplifier	Agilent	8447D	2944A10991	0.1MHz ~ 1.3GHz	Nov. 17, 2011	Radiation (03CH01-CB)
Pre-Amplifier	Agilent	8447D	2944A10991	0.1MHz ~ 1.3GHz	Nov. 17, 2012	Radiation (03CH01-CB)
Pre-Amplifier	Agilent	8449B	3008A02310	1GHz ~ 26.5GHz	Nov. 29, 2011	Radiation (03CH01-CB)
Pre-Amplifier	WM	TF-130N-R1	923365	26.5GHz ~ 40GHz	Jul. 31, 2012	Radiation (03CH01-CB)
Spectrum analyzer	R&S	FSP40	100056	9KHz~40GHz	Nov. 03, 2012	Radiation (03CH01-CB)
EMI Test Receiver	R&S	ESCS 30	100355	9KHz ~ 2.75GHz	Mar. 20, 2012	Radiation (03CH01-CB)
Loop Antenna	Teseq	HLA 6120	24155	9 kHz - 30 MHz	Sep. 09, 2011*	Radiation (03CH01-CB)
Turn Table	INN CO	CO 2000	N/A	0 ~ 360 degree	N/A	Radiation (03CH01-CB)
Antenna Mast	INN CO	CO2000	N/A	1 m - 4 m	N/A	Radiation (03CH01-CB)
RF Cable-low	Woken	Low Cable-1	N/A	30 MHz - 1 GHz	Nov. 17, 2011	Radiation (03CH01-CB)
RF Cable-high	Woken	High Cable-1	N/A	1 GHz – 26.5 GHz	Nov. 17, 2011	Radiation (03CH01-CB)
RF Cable-high	Woken	High Cable-2	N/A	1 GHz – 26.5 GHz	Nov. 17, 2011	Radiation (03CH01-CB)
RF Cable-high	Woken	High Cable-3	N/A	1 GHz - 40 GHz	Nov. 17, 2011	Radiation (03CH01-CB)
RF Cable-high	Woken	High Cable-4	N/A	1 GHz - 40 GHz	Nov. 17, 2011	Radiation (03CH01-CB)
EMI Test Receiver	R&S	ESCS 30	100377	9kHz ~ 2.75GHz	Oct. 23, 2012	Conduction (CO01-CB)
LISN	F.C.C.	FCC-LISN-50-16-2	04083	150kHz ~ 100MHz	Nov. 14, 2012	Conduction (CO01-CB)
V- LISN	Schwarzbeck	NSLK 8127	8127-478	9kHz ~ 30MHz	Jun. 22, 2012	Conduction (CO01-CB)
Impulsbegrenzer Pulse Limiter	Rohde&Schwarz	ESH3-Z2	100430	9kHz~30MHz	Feb. 03, 2012	Conduction (CO01-CB)
COND Cable	Woken	Cable	01	0.15MHz~30MHz	Dec. 4, 2011	Conduction (CO01-CB)
Signal analyzer	R&S	FSV40	100979	9KHz~40GHz	Oct. 08, 2012	Conducted (TH01-CB)
Temp. and Humidity Chamber	Ten Billion	TTH-D3SP	TBN-931011	-30~100 degree	Jun. 05, 2012	Conducted (TH01-CB)
Thermo-Hygro Meter	N/A	HC 520	#1	15~70 degree	Nov. 02, 2012	Conducted (TH01-CB)

Instrument	Manufacturer	Model No.	Serial No.	Characteristics	Calibration Date	Remark
Signal Generator	R&S	SMR40	100302	10MHz-40GHz	Nov. 22, 2012	Conducted (TH01-CB)
RF Power Divider	HP	11636A	00306	2GHz ~ 18GHz	N/A	Conducted (TH01-CB)
RF Power Splitter	Anaren	44100	1839	2GHz ~ 18GHz	N/A	Conducted (TH01-CB)
RF Power Splitter	Anaren	42100	17930	2GHz ~ 18GHz	N/A	Conducted (TH01-CB)
Signal generator	R&S	SMU200A	102782	10MHz-40GHz	Sep. 26, 2012	Conducted (TH01-CB)
Horn Antenna	COM-POWER	AH-118	071187	1GHz – 18GHz	May 09, 2012	Conducted (TH01-CB)
RF Cable-high	Woken	High Cable-7	-	1 GHz – 26.5 GHz	Nov. 17, 2012	Conducted (TH01-CB)
RF Cable-high	Woken	High Cable-8	-	1 GHz – 26.5 GHz	Nov. 17, 2012	Conducted (TH01-CB)
RF Cable-high	Woken	High Cable-9	-	1 GHz – 26.5 GHz	Nov. 17, 2012	Conducted (TH01-CB)
RF Cable-high	Woken	High Cable-10	-	1 GHz – 26.5 GHz	Nov. 17, 2012	Conducted (TH01-CB)
RF Cable-high	Woken	High Cable-11	-	1 GHz – 26.5 GHz	Nov. 17, 2012	Conducted (TH01-CB)
RF Cable-high	Woken	High Cable-12	-	1 GHz – 26.5 GHz	Nov. 17, 2012	Conducted (TH01-CB)
RF Cable-high	Woken	High Cable-13	-	1 GHz – 26.5 GHz	Nov. 17, 2012	Conducted (TH01-CB)
Power Sensor	Anritsu	MA2411B	0917223	300MHz~40GHz	Nov. 01, 2012	Conducted (TH01-CB)
Power Meter	Anritsu	ML2495A	1035008	300MHz~40GHz	Nov. 01, 2012	Conducted (TH01-CB)

Note: Calibration Interval of instruments listed above is one year.

Note: "*" Calibration Interval of instruments listed above is two years.

6. TEST LOCATION

SHIJR	ADD : 6Fl., No. 106, Sec. 1, Shintai 5th Rd., Shijr City, Taipei, Taiwan 221, R.O.C. TEL : 886-2-2696-2468 FAX : 886-2-2696-2255
HWA YA	ADD : No. 52, Hwa Ya 1st Rd., Kwei-Shan Hsiang, Tao Yuan Hsien, Taiwan, R.O.C. TEL : 886-3-327-3456 FAX : 886-3-318-0055
LINKOU	ADD : No. 30-2, Dingfu Tsuen, Linkou Shiang, Taipei, Taiwan 244, R.O.C TEL : 886-2-2601-1640 FAX : 886-2-2601-1695
DUNGHU	ADD : No. 3, Lane 238, Kangle St., Neihu Chiu, Taipei, Taiwan 114, R.O.C. TEL : 886-2-2631-4739 FAX : 886-2-2631-9740
JUNGHE	ADD : 7Fl., No. 758, Jungjeng Rd., Junghe City, Taipei, Taiwan 235, R.O.C. TEL : 886-2-8227-2020 FAX : 886-2-8227-2626
NEIHU	ADD : 4Fl., No. 339, Hsin Hu 2 nd Rd., Taipei 114, Taiwan, R.O.C. TEL : 886-2-2794-8886 FAX : 886-2-2794-9777
JHUBEI	ADD : No.8, Lane 724, Bo-ai St., Jhubei City, HsinChu County 302, Taiwan, R.O.C. TEL : 886-3-656-9065 FAX : 886-3-656-9085

7. TAF CERTIFICATE OF ACCREDITATION



Certificate No. : L1190-110702

財團法人全國認證基金會
Taiwan Accreditation Foundation

Certificate of Accreditation

This is to certify that

Sporton International Inc.
EMC & Wireless Communications Laboratory
No.52, Hwa Ya 1st Road, Hwa Ya Technology Park, Kwei-Shan Hsiang, Tao Yuan Hsien,
Taiwan, R.O.C.

is accredited in respect of laboratory

Accreditation Criteria	: ISO/IEC 17025:2005
Accreditation Number	: 1190
Originally Accredited	: December 15, 2003
Effective Period	: January 10, 2010 to January 09, 2013
Accredited Scope	: Testing Field, see described in the Appendix
Specific Accreditation Program	: Accreditation Program for Designated Testing Laboratory for Commodities Inspection Accreditation Program for Telecommunication Equipment Testing Laboratory Accreditation Program for BSMI Mutual Recognition Arrangement with Foreign Authorities

Jay-San Chen
President, Taiwan Accreditation Foundation
Date : July 02, 2011

P1, total 22 pages

The Appendix forms an integral part of this Certificate, which shall be invalid when use without the Appendix