

FCC Test Report

Report No.: RF121023C05A

FCC ID: HDCWLAN192XF1

Test Model: BSAP-1920

Series Model: BSAP-1925

Received Date: Aug. 07, 2015

Test Date: Aug. 12 ~ Sep. 08, 2015

Issued Date: Sep. 10, 2015

Applicant: Adtran

Address: 901 Explorer Boulevard Huntsville Alabama United States

Issued By: Bureau Veritas Consumer Products Services (H.K.) Ltd., Taoyuan Branch

Lab Address: No. 47-2, 14th Ling, Chia Pau Vil., Lin Kou Dist., New Taipei City, Taiwan, R.O.C.

Lab Address: No.19, Hwa Ya 2nd Rd., Wen Hwa Vil., Kwei Shan Dist., Taoyuan City 33383, TAIWAN (R.O.C.)



This report is for your exclusive use. Any copying or replication of this report to or for any other person or entity, or use of our name or trademark, is permitted only with our prior written permission. This report sets forth our findings solely with respect to the test samples identified herein. The results set forth in this report are not indicative or representative of the quality or characteristics of the lot from which a test sample was taken or any similar or identical product unless specifically and expressly noted. Our report includes all of the tests requested by you and the results thereof based upon the information that you provided to us. You have 60 days from date of issuance of this report to notify us of any material error or omission caused by our negligence, provided, however, that such notice shall be in writing and shall specifically address the issue you wish to raise. A failure to raise such issue within the prescribed time shall constitute your unqualified acceptance of the completeness of this report, the tests conducted and the correctness of the report contents. Unless specific mention, the uncertainty of measurement has been explicitly taken into account to declare the compliance or non-compliance to the specification. The report must not be used by the client to claim product certification, approval, or endorsement by TAF or any government agencies.



Table of Contents

| | |
|---|-----------|
| Release Control Record | 4 |
| 1 Certificate of Conformity | 5 |
| 2 Summary of Test Results | 6 |
| 2.1 Measurement Uncertainty..... | 6 |
| 2.2 Modification Record..... | 6 |
| 3 General Information | 7 |
| 3.1 General Description of EUT..... | 7 |
| 3.2 Description of Test Modes..... | 8 |
| 3.2.1 Test Mode Applicability and Tested Channel Detail..... | 9 |
| 3.3 Duty Cycle of Test Signal..... | 11 |
| 3.4 Description of Support Units..... | 12 |
| 3.4.1 Configuration of System under Test..... | 13 |
| 3.5 General Description of Applied Standards..... | 14 |
| 4 Test Types and Results | 15 |
| 4.1 Radiated Emission and Bandedge Measurement..... | 15 |
| 4.1.1 Limits of Radiated Emission and Bandedge Measurement..... | 15 |
| 4.1.2 Test Instruments..... | 16 |
| 4.1.3 Test Procedures..... | 17 |
| 4.1.4 Deviation from Test Standard..... | 17 |
| 4.1.5 Test Set Up..... | 18 |
| 4.1.6 EUT Operating Conditions..... | 18 |
| 4.1.7 Test Results..... | 19 |
| 4.2 Conducted Emission Measurement..... | 55 |
| 4.2.1 Limits of Conducted Emission Measurement..... | 55 |
| 4.2.2 Test Instruments..... | 55 |
| 4.2.3 Test Procedures..... | 56 |
| 4.2.4 Deviation from Test Standard..... | 56 |
| 4.2.5 Test Setup..... | 56 |
| 4.2.6 EUT Operating Conditions..... | 56 |
| 4.2.7 Test Results..... | 57 |
| 4.3 Transmit Power Measurement..... | 65 |
| 4.3.1 Limits of Transmit Power Measurement..... | 65 |
| 4.3.2 Test Setup..... | 65 |
| 4.3.3 Test Instruments..... | 65 |
| 4.3.4 Test Procedure..... | 65 |
| 4.3.5 Deviation from Test Standard..... | 65 |
| 4.3.6 EUT Operating Conditions..... | 65 |
| 4.3.7 Test Result..... | 66 |
| 4.4 Peak Power Spectral Density Measurement..... | 71 |
| 4.4.1 Limits of Peak Power Spectral Density Measurement..... | 71 |
| 4.4.2 Test Setup..... | 71 |
| 4.4.3 Test Instruments..... | 71 |
| 4.4.4 Test Procedures..... | 71 |
| 4.4.5 Deviation from Test Standard..... | 72 |
| 4.4.6 EUT Operating Conditions..... | 72 |
| 4.4.7 Test Results..... | 73 |
| 4.5 Frequency Stability..... | 77 |
| 4.5.1 Limits of Frequency Stability Measurement..... | 77 |
| 4.5.2 Test Setup..... | 77 |
| 4.5.3 Test Instruments..... | 77 |
| 4.5.4 Test Procedure..... | 77 |
| 4.5.5 Deviation from Test Standard..... | 77 |
| 4.5.6 EUT Operating Condition..... | 77 |



| | |
|---|-----------|
| 4.5.7 Test Results | 78 |
| 4.6 6dB Bandwidth Measurement | 79 |
| 4.6.1 Limits of 6dB Bandwidth Measurement | 79 |
| 4.6.2 Test Setup | 79 |
| 4.6.3 Test Instruments | 79 |
| 4.6.4 Test Procedure | 79 |
| 4.6.5 Deviation from Test Standard | 79 |
| 4.6.6 EUT Operating Condition | 79 |
| 4.6.7 Test Results | 80 |
| 5 Pictures of Test Arrangements | 82 |
| Appendix – Information on the Testing Laboratories | 83 |



A D T

Release Control Record

| Issue No. | Description | Date Issued |
|--------------|------------------|---------------|
| RF121023C05A | Original release | Sep. 10, 2015 |

1 Certificate of Conformity

Product: Wireless 802.11abgn Access Point
Brand: Adtran
Test Model: BSAP-1920
Series Model: BSAP-1925
Sample Status: Engineering sample
Applicant: Adtran
Test Date: Aug. 12 ~ Sep. 08, 2015
Standards: 47 CFR FCC Part 15, Subpart E (Section 15.407)
ANSI C63.10:2013

The above equipment has been tested by **Bureau Veritas Consumer Products Services (H.K.) Ltd., Taoyuan Branch**, and found compliance with the requirement of the above standards. The test record, data evaluation & Equipment Under Test (EUT) configurations represented herein are true and accurate accounts of the measurements of the sample's EMC characteristics under the conditions specified in this report.

Prepared by : Celine Chou , **Date:** Sep. 10, 2015
Celine Chou / Specialist

Approved by : Ken Liu , **Date:** Sep. 10, 2015
Ken Liu / Senior Manager

2 Summary of Test Results

| 47 CFR FCC Part 15, Subpart E (SECTION 15.407) | | | |
|--|--|--------|---|
| FCC Clause | Test Item | Result | Remarks |
| 15.207 15.407(b)(6) | AC Power Conducted Emissions | Pass | Meet the requirement of limit. Minimum passing margin is -6.07dB at 0.46179MHz. |
| 15.407(b) (1/2/3/4/6) | Radiated Emissions & Band Edge Measurement | Pass | Meet the requirement of limit. Minimum passing margin is -1.0dB at 10360.00MHz, 11570.00MHz and 625.02MHz. |
| 15.407(a)(1/2 /3) | Max Average Transmit Power | Pass | Meet the requirement of limit. |
| 15.407(a)(1/2 /3) | Peak Power Spectral Density | Pass | Meet the requirement of limit. |
| 15.407(e) | 6dB bandwidth | Pass | Meet the requirement of limit. (U-NII-3 Band only) |
| 15.407(g) | Frequency Stability | Pass | Meet the requirement of limit. |
| 15.203 | Antenna Requirement | Pass | Antenna connectors are UFL and RSMA not a standard connector. |

2.1 Measurement Uncertainty

Where relevant, the following measurement uncertainty levels have been estimated for tests performed on the EUT as specified in CISPR 16-4-2:

| Measurement | Frequency | Expanded Uncertainty (k=2) (±) |
|-------------------------------------|-----------------|--------------------------------|
| Conducted Emissions at mains ports0 | 150kHz ~ 30MHz | 2.44 dB |
| Radiated Emissions up to 1 GHz | 30MHz ~ 200MHz | 3.86 dB |
| | 200MHz ~1000MHz | 3.87 dB |
| Radiated Emissions above 1 GHz | 1GHz ~ 18GHz | 2.29 dB |
| | 18GHz ~ 40GHz | 2.29 dB |

2.2 Modification Record

There were no modifications required for compliance.

3 General Information

3.1 General Description of EUT

| | |
|-----------------------|--|
| Product | Wireless 802.11abgn Access Point |
| Brand | Adtran |
| Test Model | BSAP-1920 |
| Series Model | BSAP-1925 |
| Model Difference | Refer to Note |
| Status of EUT | Engineering sample |
| Power Supply Rating | 12Vdc (adapter) 56Vdc (PoE) |
| Modulation Type | 64QAM, 16QAM, QPSK, BPSK for OFDM |
| Modulation Technology | OFDM |
| Transfer Rate | 802.11a: 54.0/ 48.0/ 36.0/ 24.0/ 18.0/ 12.0/ 9.0/ 6.0Mbps 802.11n: up to 300Mbps |
| Operating Frequency | 5180 ~ 5240MHz, 5745 ~ 5825MHz |
| Number of Channel | 5180 ~ 5240MHz: 4 for 802.11a, 802.11n (HT20) 2 for 802.11n (HT40) 5745 ~ 5825MHz: 5 for 802.11a, 802.11n (HT20) 2 for 802.11n (HT40) |
| Output Power | 5180 ~ 5240MHz: 129.090mW 5745 ~ 5825MHz: 107.590mW |
| Antenna Type | Refer to Note |
| Antenna Connector | Refer to Note |
| Accessory Device | Adapter |
| Data Cable Supplied | NA |

Note:

1. This report is prepared for FCC class II permissive change.
2. This report is issued as a supplementary report to the original ADT report no.: RF120618C25D-1. The difference compared with the original report is updating U-NII-1 and U-NII-3 band to new rules. All test data had been re-tested.
3. All models are listed as below. All models are hardware, software, electrically identical, different model names are for different antenna. (refer to as below for more detail)

| Brand | Model | Description |
|--------|-----------|----------------------------|
| Adtran | BSAP-1925 | With External Antenna only |
| | BSAP-1920 | With Internal Antenna only |

4. The EUT incorporates a MIMO function. Physically, the EUT provides 2 completed transmitters and 2 receivers.

| Modulation Mode | TX Function |
|-----------------|-------------|
| 802.11a | 2TX |
| 802.11n (HT20) | 2TX |
| 802.11n (HT40) | 2TX |

5. The EUT consumes power from the following adapter.

| | |
|------------|-----------------------------|
| Adapter | |
| Brand | Powertron |
| Model | PA1015-2I/PA1015-2I120125 |
| Input | 100-240Vac, 50-60Hz, 0.4A |
| Output | 12Vdc, 1.25A, 15W |
| Power Line | 1.5m non-shielded, w/o core |

6. The following antennas were provided to the EUT.

| No. | Type | Gain(dBi) | Connector |
|-----|----------|--------------------------------------|-----------|
| 1 | Embedded | 2.4GHz Band: 3dBi 5GHz Band: 4dBi | UFL |
| 2 | Dipole | 2.4GHz Band: 3dBi 5GHz Band: 3dBi | RSMA |

3.2 Description of Test Modes

For 5180 ~ 5240MHz

4 channels are provided for 802.11a, 802.11n (HT20):

| Channel | Frequency | Channel | Frequency |
|---------|-----------|---------|-----------|
| 36 | 5180 MHz | 44 | 5220 MHz |
| 40 | 5200 MHz | 48 | 5240 MHz |

2 channels are provided for 802.11n (HT40):

| Channel | Frequency | Channel | Frequency |
|---------|-----------|---------|-----------|
| 38 | 5190 MHz | 46 | 5230 MHz |

For 5745 ~ 5825MHz

5 channels are provided for 802.11a, 802.11n (HT20):

| Channel | Frequency | Channel | Frequency |
|---------|-----------|---------|-----------|
| 149 | 5745MHz | 161 | 5805MHz |
| 153 | 5765MHz | 165 | 5825MHz |
| 157 | 5785MHz | | |

2 channels are provided for 802.11n (HT40):

| Channel | Frequency | Channel | Frequency |
|---------|-----------|---------|-----------|
| 151 | 5755MHz | 159 | 5795MHz |

3.2.1 Test Mode Applicability and Tested Channel Detail

| EUT CONFIGURE MODE | APPLICABLE TO | | | | DESCRIPTION | |
|--------------------|---------------|-------|-----|------|-------------|--------------------|
| | RE \geq 1G | RE<1G | PLC | APCM | EUT Model | Power |
| A | √ | √ | √ | √ | BSAP-1920 | Power from adapter |
| B | - | √ | √ | - | | Power from PoE |
| C | √ | √ | √ | - | BSAP-1925 | Power from adapter |
| D | - | √ | √ | - | | Power from PoE |

Where **RE \geq 1G**: Radiated Emission above 1GHz & Bandedge Measurement
RE<1G: Radiated Emission below 1GHz
PLC: Power Line Conducted Emission
APCM: Antenna Port Conducted Measurement

Note:

1. The EUT had been pre-tested on the positioned of each 3 axis. The worst case was found when positioned on **X-plane**.
2. "-" means no effect.

Radiated Emission Test (Above 1GHz):

- Pre-Scan has been conducted to determine the worst-case mode from all possible combinations between available modulations, data rates and antenna ports (if EUT with antenna diversity architecture).
- Following channel(s) was (were) selected for the final test as listed below.

| EUT CONFIGURE MODE | MODE | FREQ. BAND (MHz) | AVAILABLE CHANNEL | TESTED CHANNEL | MODULATION TECHNOLOGY | MODULATION TYPE | DATA RATE (Mbps) |
|--------------------|----------------|------------------|-------------------|----------------|-----------------------|-----------------|------------------|
| A, C | 802.11a | 5180-5240 | 36 to 48 | 36, 40, 48 | OFDM | BPSK | 6.0 |
| A, C | 802.11n (HT20) | | 36 to 48 | 36, 40, 48 | OFDM | BPSK | 7.2 |
| A, C | 802.11n (HT40) | | 38 to 46 | 38, 46 | OFDM | BPSK | 15.0 |
| A, C | 802.11a | 5745-5825 | 149 to 165 | 149, 157, 165 | OFDM | BPSK | 6.0 |
| A, C | 802.11n (HT20) | | 149 to 165 | 149, 157, 165 | OFDM | BPSK | 7.2 |
| A, C | 802.11n (HT40) | | 151 to 159 | 151, 159 | OFDM | BPSK | 15.0 |

Radiated Emission Test (Below 1GHz):

- Pre-Scan has been conducted to determine the worst-case mode from all possible combinations between available modulations, data rates and antenna ports (if EUT with antenna diversity architecture).
- Following channel(s) was (were) selected for the final test as listed below.

| EUT CONFIGURE MODE | MODE | FREQ. BAND (MHz) | AVAILABLE CHANNEL | TESTED CHANNEL | MODULATION TECHNOLOGY | MODULATION TYPE | DATA RATE (Mbps) |
|--------------------|---------|------------------|-------------------|----------------|-----------------------|-----------------|------------------|
| A, B, C, D | 802.11a | 5180-5240 | 36 to 48 | 36 | OFDM | BPSK | 6.0 |
| | 802.11a | 5745-5825 | 149 to 165 | | OFDM | BPSK | 6.0 |

Power Line Conducted Emission Test:

- Pre-Scan has been conducted to determine the worst-case mode from all possible combinations between available modulations, data rates and antenna ports (if EUT with antenna diversity architecture).
- Following channel(s) was (were) selected for the final test as listed below.

| EUT CONFIGURE MODE | MODE | FREQ. BAND (MHz) | AVAILABLE CHANNEL | TESTED CHANNEL | MODULATION TECHNOLOGY | MODULATION TYPE | DATA RATE (Mbps) |
|--------------------|---------|------------------|-------------------|----------------|-----------------------|-----------------|------------------|
| A, B, C, D | 802.11a | 5180-5240 | 36 to 48 | 36 | OFDM | BPSK | 6.0 |
| | 802.11a | 5745-5825 | 149 to 165 | | OFDM | BPSK | 6.0 |

Antenna Port Conducted Measurement:

- This item includes all test value of each mode, but only includes spectrum plot of worst value of each mode.
- Pre-Scan has been conducted to determine the worst-case mode from all possible combinations between available modulations, data rates and antenna ports (if EUT with antenna diversity architecture).
- Following channel(s) was (were) selected for the final test as listed below.

| EUT CONFIGURE MODE | MODE | FREQ. BAND (MHz) | AVAILABLE CHANNEL | TESTED CHANNEL | MODULATION TECHNOLOGY | MODULATION TYPE | DATA RATE (Mbps) |
|--------------------|----------------|------------------|-------------------|----------------|-----------------------|-----------------|------------------|
| A, C | 802.11a | 5180-5240 | 36 to 48 | 36, 40, 48 | OFDM | BPSK | 6.0 |
| A, C | 802.11n (HT20) | | 36 to 48 | 36, 40, 48 | OFDM | BPSK | 7.2 |
| A, C | 802.11n (HT40) | | 38 to 46 | 38, 46 | OFDM | BPSK | 15.0 |
| A, C | 802.11a | 5745-5825 | 149 to 165 | 149, 157, 165 | OFDM | BPSK | 6.0 |
| A, C | 802.11n (HT20) | | 149 to 165 | 149, 157, 165 | OFDM | BPSK | 7.2 |
| A, C | 802.11n (HT40) | | 151 to 159 | 151, 159 | OFDM | BPSK | 15.0 |

Test Condition:

| APPLICABLE TO | ENVIRONMENTAL CONDITIONS | INPUT POWER | TESTED BY |
|------------------------------|--------------------------|-----------------------|-------------|
| RE\geq1G | 18deg. C, 70%RH | 120Vac, 60Hz | Nick Hsu |
| RE$<$1G | 18deg. C, 70%RH | 120Vac, 60Hz 56Vdc | Nick Hsu |
| PLC | 20deg. C, 70%RH | 120Vac, 60Hz | Jones Chang |
| APCM | 25deg. C, 60%RH | 120Vac, 60Hz | Antony Lee |

3.3 Duty Cycle of Test Signal

Duty cycle of test signal is > 98 %, duty factor is not required

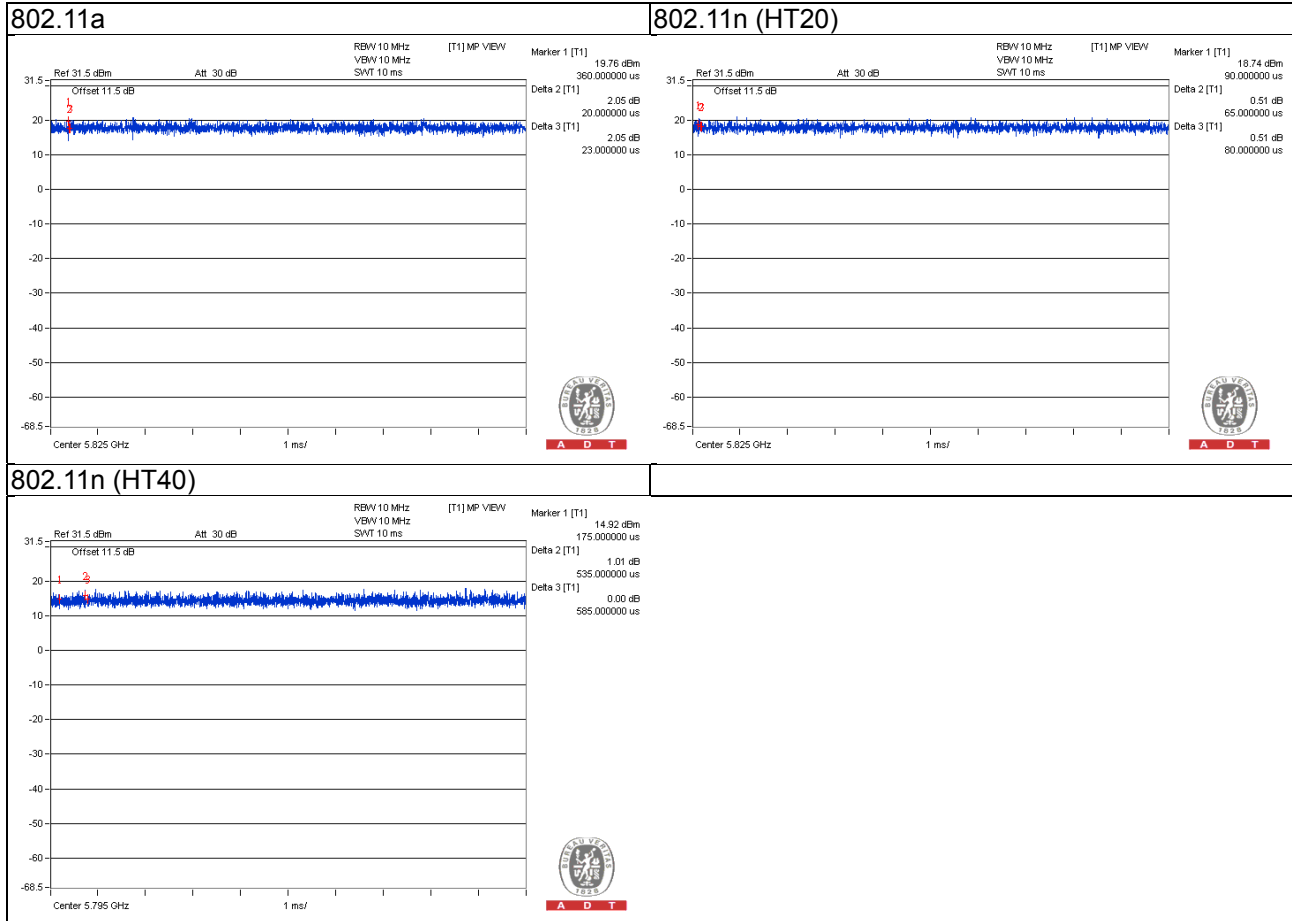

3.4 Description of Support Units

The EUT has been tested as an independent unit together with other necessary accessories or support units. The following support units or accessories were used to form a representative test configuration during the tests.

| ID | Product | Brand | Model No. | Serial No. | FCC ID | Remarks |
|----|----------|---------|------------|------------|------------------|--|
| A. | Notebook | DELL | E5410 | 1HC2XM1 | FCC DoC Approved | - |
| B. | POE | PHIHONG | POE21U-1AF | NA | NA | Provided by Manufacturer For test mode B and D only |

Note:

1. All power cords of the above support units are non-shielded (1.8m).
2. Item A acted as a communication partner to transfer data.

| ID | Descriptions | Qty. | Length (m) | Shielding (Yes/No) | Cores (Qty.) | Remarks |
|----|--------------|------|------------|--------------------|--------------|----------------------------|
| 1. | Power | 1 | 1.5 | N | 0 | Attached on adapter |
| 2. | RJ45 , Cat5e | 1 | 3 | N | 0 | - |
| 3. | RJ45 , Cat5e | 1 | 3 | N | 0 | For test mode B and D only |

3.4.1 Configuration of System under Test

Test mode A and C

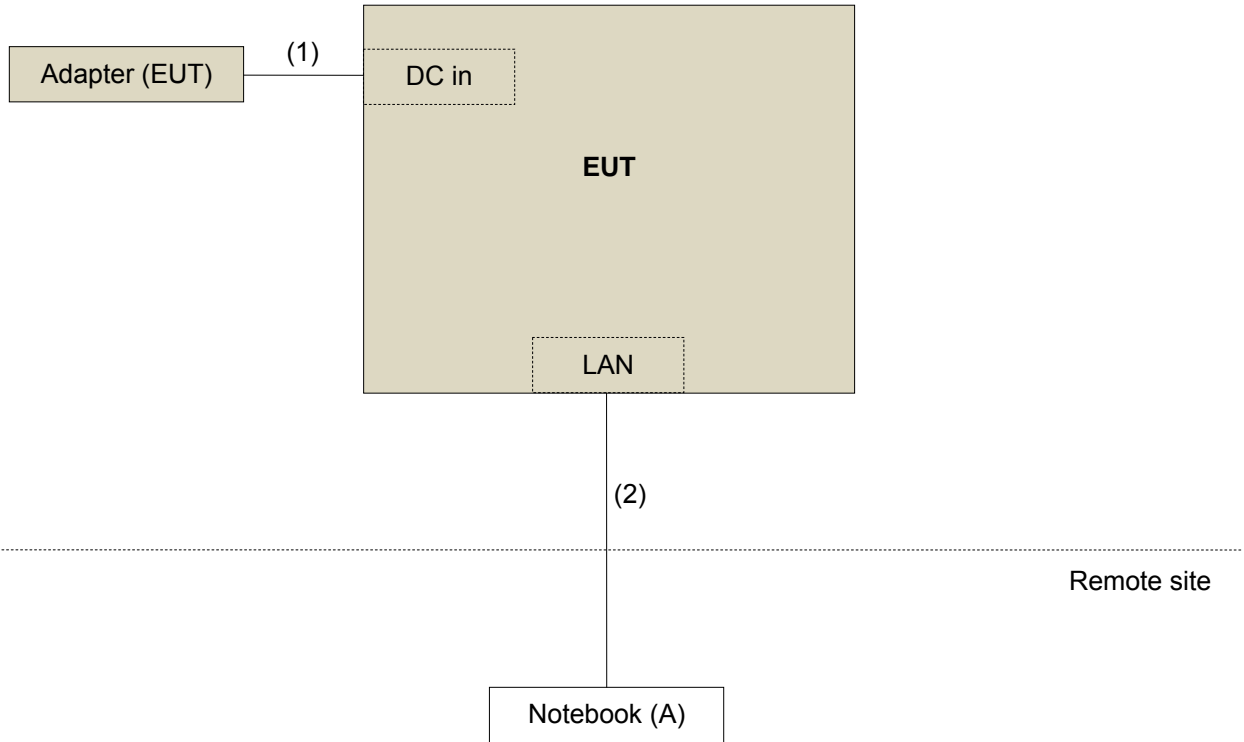

Test mode B and D

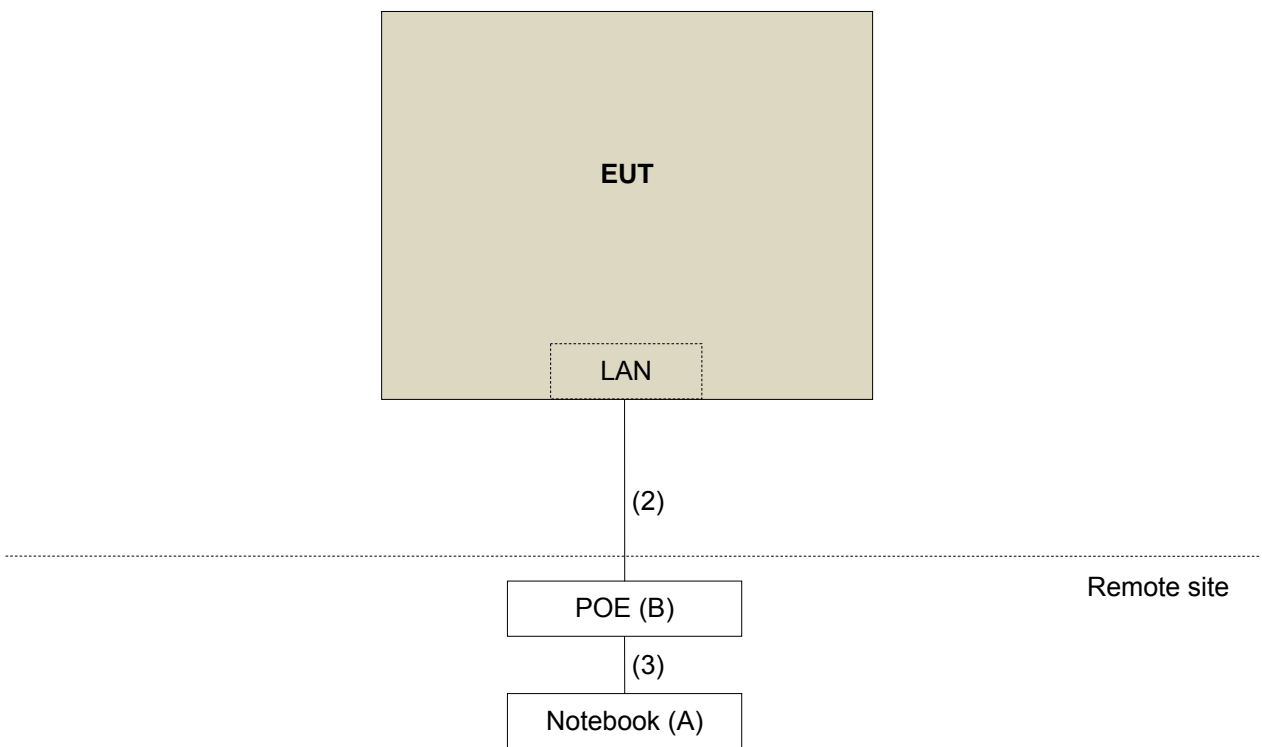

3.5 General Description of Applied Standards

The EUT is a RF Product. According to the specifications of the manufacturer, it must comply with the requirements of the following standards:

FCC Part 15, Subpart E (15.407)

789033 D02 General UNII Test Procedures New Rules v01

662911 D01 Multiple Transmitter Output v02r01

ANSI C63.10-2013

All test items have been performed and recorded as per the above standards.

Note: The EUT is also considered as a kind of computer peripheral, because the connection to computer is necessary for typical use. It has been verified to comply with the requirements of FCC Part 15, Subpart B, Class B (DoC). The test report has been issued separately.

4 Test Types and Results

4.1 Radiated Emission and Bandedge Measurement

4.1.1 Limits of Radiated Emission and Bandedge Measurement

Radiated emissions which fall in the restricted bands must comply with the radiated emission limits specified as below table.

| Frequencies (MHz) | Field Strength (microvolts/meter) | Measurement Distance (meters) |
|-------------------|-----------------------------------|-------------------------------|
| 0.009 ~ 0.490 | 2400/F(kHz) | 300 |
| 0.490 ~ 1.705 | 24000/F(kHz) | 30 |
| 1.705 ~ 30.0 | 30 | 30 |
| 30 ~ 88 | 100 | 3 |
| 88 ~ 216 | 150 | 3 |
| 216 ~ 960 | 200 | 3 |
| Above 960 | 500 | 3 |

NOTE:

1. The lower limit shall apply at the transition frequencies.
2. Emission level (dBuV/m) = 20 log Emission level (uV/m).
3. For frequencies above 1000MHz, the field strength limits are based on average detector, however, the peak field strength of any emission shall not exceed the maximum permitted average limits, specified above by more than 20dB under any condition of modulation.

LIMITS OF UNWANTED EMISSION OUT OF THE RESTRICTED BANDS

| Applicable To | Limit | |
|---|--|--|
| 789033 D02 General UNII Test Procedures New Rules v01 | FIELD STRENGTH AT 3m | |
| | PK:74 (dBµV/m) | AV:54 (dBµV/m) |
| Applicable To | EIRP Limit | Equivalent Field Strength at 3m |
| 15.407(b)(1) | PK:-27 (dBm/MHz) | PK:68.2(dBµV/m) |
| 15.407(b)(2) | | |
| 15.407(b)(3) | | |
| 15.407(b)(4) | PK:-27 (dBm/MHz) ^{*1} PK:-17 (dBm/MHz) ^{*2} | PK: 68.2(dBµV/m) ^{*1} PK:78.2 (dBµV/m) ^{*2} |

NOTE: ^{*1} beyond 10MHz of the band edge ^{*2} within 10 MHz of band edge

The following formula is used to convert the equipment isotropic radiated power (eirp) to field strength:

$$E = \frac{1000000\sqrt{30P}}{3} \mu\text{V/m, where } P \text{ is the eirp (Watts).}$$

4.1.2 Test Instruments

| Description & Manufacturer | Model No. | Serial No. | Cal. Date | Cal. Due |
|---|--------------------------|----------------------------|---------------|---------------|
| Test Receiver ROHDE & SCHWARZ | ESIB7 | 100187 | Apr. 10, 2015 | Apr. 09, 2016 |
| Spectrum Analyzer ROHDE & SCHWARZ | FSP40 | 100041 | Sep. 02, 2014 | Sep. 01, 2015 |
| | | | Sep. 02, 2015 | Sep. 01, 2016 |
| BILOG Antenna SCHWARZBECK | VULB9168 | 9168-160 | Feb. 05, 2015 | Feb. 04, 2016 |
| HORN Antenna SCHWARZBECK | 9120D | 209 | Feb. 09, 2015 | Feb. 08, 2016 |
| HORN Antenna SCHWARZBECK | BBHA 9170 | BBHA9170241 | Feb. 09, 2015 | Feb. 08, 2016 |
| Preamplifier Agilent | 8447D | 2944A10738 | Oct. 18, 2014 | Oct. 17, 2015 |
| Preamplifier Agilent | 8449B | 3008A01964 | Aug. 22, 2014 | Aug. 21, 2015 |
| | | | Aug. 22, 2015 | Aug. 21, 2016 |
| RF signal cable HUBER+SUHNER | SUCOFLEX 104 | Cable-CH3-03(214378) | Aug. 22, 2014 | Aug. 21, 2015 |
| | | | Aug. 22, 2015 | Aug. 21, 2016 |
| RF signal cable HUBER+SUHNER | SUCOFLEX 106 | Cable-CH3-03(309224+12738) | Aug. 22, 2014 | Aug. 21, 2015 |
| | | | Aug. 22, 2015 | Aug. 21, 2016 |
| Software BV ADT | ADT_Radiated_V7.6.15.9.4 | NA | NA | NA |
| Antenna Tower inn-co GmbH | MA 4000 | 013303 | NA | NA |
| Antenna Tower Controller BV ADT | AT100 | AT93021702 | NA | NA |
| Turn Table BV ADT | TT100 | TT93021702 | NA | NA |
| Turn Table Controller BV ADT | SC100 | SC93021702 | NA | NA |
| 26GHz ~ 40GHz Amplifier | EM26400 | 815221 | Oct. 18, 2014 | Oct. 17, 2015 |
| High Speed Peak Power Meter | ML2495A | 0824011 | Jul. 09, 2015 | Jul. 08, 2016 |
| Power Sensor | MA2411B | 0738171 | Jul. 09, 2015 | Jul. 08, 2016 |
| WIT Standard Temperature And Humidity Chamber | TH-4S-C | W981030 | Jun. 08, 2015 | Jun. 07, 2016 |

- Note:
1. The calibration interval of the above test instruments is 12 months and the calibrations are traceable to NML/ROC and NIST/USA.
 2. The test was performed in HwaYa Chamber 3.
 3. The horn antenna and preamplifier (model: 8449B) are used only for the measurement of emission frequency above 1GHz if tested.
 4. The FCC Site Registration No. is 988962.
 5. The IC Site Registration No. is IC 7450F-3.

4.1.3 Test Procedures

- a. The EUT was placed on the top of a rotating table 0.8 meters (for below 1GHz) / 1.5 meters (for above 1GHz) above the ground at 3 meter chamber room for test. The table was rotated 360 degrees to determine the position of the highest radiation.
- b. The EUT was set 3 meters away from the interference-receiving antenna, which was mounted on the top of a variable-height antenna tower.
- c. The height of antenna is varied from one meter to four meters above the ground to determine the maximum value of the field strength. Both horizontal and vertical polarizations of the antenna are set to make the measurement.
- d. For each suspected emission, the EUT was arranged to its worst case and then the antenna was tuned to heights from 1 meter to 4 meters and the rotatable table was turned from 0 degrees to 360 degrees to find the maximum reading.
- e. The test-receiver system was set to quasi-peak detect function and specified bandwidth with maximum hold mode when the test frequency is below 1 GHz.
- f. The test-receiver system was set to peak and average detect function and specified bandwidth with maximum hold mode when the test frequency is above 1 GHz. If the peak reading value also meets average limit, measurement with the average detector is unnecessary.

Note:

1. The resolution bandwidth and video bandwidth of test receiver/spectrum analyzer is 120kHz for Quasi-peak detection (QP) at frequency below 1GHz.
2. The resolution bandwidth of test receiver/spectrum analyzer is 1 MHz and the video bandwidth is 3 MHz for Peak detection (PK) at frequency above 1GHz.
3. The resolution bandwidth of test receiver/spectrum analyzer is 1MHz and the video bandwidth is 3MHz for RMS Average (Duty cycle < 98%) for Average detection (AV) at frequency above 1GHz, then the measurement results was added to a correction factor ($10 \log(1/\text{duty cycle})$).
4. The resolution bandwidth of test receiver/spectrum analyzer is 1MHz and the video bandwidth is 10Hz (Duty cycle $\geq 98\%$) for Average detection (AV) at frequency above 1GHz.
5. All modes of operation were investigated and the worst-case emissions are reported.

4.1.4 Deviation from Test Standard

No deviation.

4.1.5 Test Set Up

<Frequency Range below 1GHz>

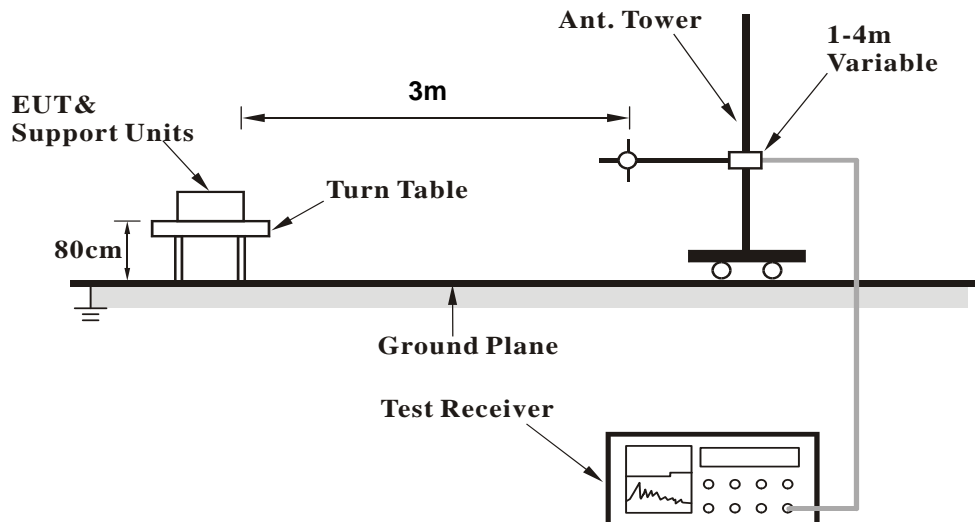

<Frequency Range above 1GHz>

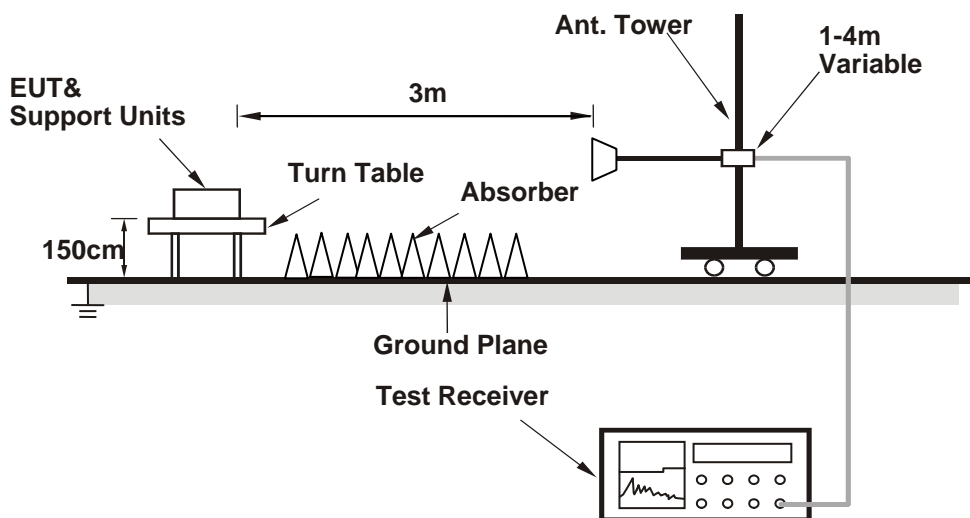

For the actual test configuration, please refer to the attached file (Test Setup Photo)

4.1.6 EUT Operating Conditions

- Placed the EUT on the testing table.
- Prepared a notebook to act as a communication partner and placed it outside of testing area.
- The communication partner connected with EUT via external board through a RJ45 cable and ran a test program (provided by manufacturer) to enable EUT under transmission condition continuously at specific channel frequency.
- The communication partner sent data to EUT by command "PING".

4.1.7 Test Results

Above 1GHz Data

802.11a

| | | | |
|-----------------|---------------|----------------------|--------------|
| CHANNEL | TX Channel 36 | DETECTOR FUNCTION | Peak (PK) |
| FREQUENCY RANGE | 1GHz ~ 40GHz | | Average (AV) |
| TEST MODE | A | | |

| ANTENNA POLARITY & TEST DISTANCE: HORIZONTAL AT 3 M | | | | | | | | |
|---|----------------|-------------------------------|-------------------|----------------|--------------------------|----------------------------|------------------------|--------------------------------|
| NO. | FREQ. (MHz) | EMISSION LEVEL (dBuV/m) | LIMIT (dBuV/m) | MARGIN (dB) | ANTENNA HEIGHT (m) | TABLE ANGLE (Degree) | RAW VALUE (dBuV) | CORRECTION FACTOR (dB/m) |
| 1 | 5150.00 | 72.7 PK | 74.0 | -1.3 | 1.56 H | 331 | 66.70 | 6.00 |
| 2 | 5150.00 | 52.5 AV | 54.0 | -1.5 | 1.56 H | 331 | 46.50 | 6.00 |
| 3 | *5180.00 | 113.8 PK | | | 1.78 H | 339 | 74.30 | 39.50 |
| 4 | *5180.00 | 102.8 AV | | | 1.78 H | 339 | 63.30 | 39.50 |
| 5 | #6906.00 | 59.8 PK | 68.2 | -8.4 | 2.21 H | 331 | 48.30 | 11.50 |
| 6 | #10360.00 | 61.3 PK | 74.0 | -12.7 | 1.96 H | 291 | 42.90 | 18.40 |
| 7 | #10360.00 | 48.7 AV | 54.0 | -5.3 | 1.96 H | 291 | 30.30 | 18.40 |
| 8 | 15540.00 | 61.2 PK | 74.0 | -12.8 | 1.69 H | 293 | 42.30 | 18.90 |
| 9 | 15540.00 | 48.1 AV | 54.0 | -5.9 | 1.69 H | 293 | 29.20 | 18.90 |

| ANTENNA POLARITY & TEST DISTANCE: VERTICAL AT 3 M | | | | | | | | |
|---|----------------|-------------------------------|-------------------|----------------|--------------------------|----------------------------|------------------------|--------------------------------|
| NO. | FREQ. (MHz) | EMISSION LEVEL (dBuV/m) | LIMIT (dBuV/m) | MARGIN (dB) | ANTENNA HEIGHT (m) | TABLE ANGLE (Degree) | RAW VALUE (dBuV) | CORRECTION FACTOR (dB/m) |
| 1 | 5150.00 | 70.9 PK | 74.0 | -3.1 | 2.20 V | 324 | 64.90 | 6.00 |
| 2 | 5150.00 | 51.9 AV | 54.0 | -2.1 | 2.20 V | 324 | 45.90 | 6.00 |
| 3 | *5180.00 | 114.0 PK | | | 1.98 V | 324 | 74.50 | 39.50 |
| 4 | *5180.00 | 103.5 AV | | | 1.98 V | 324 | 64.00 | 39.50 |
| 5 | #6906.00 | 60.5 PK | 68.2 | -7.7 | 2.34 V | 359 | 49.00 | 11.50 |
| 6 | #10360.00 | 63.5 PK | 74.0 | -10.5 | 2.54 V | 221 | 45.10 | 18.40 |
| 7 | #10360.00 | 50.6 AV | 54.0 | -3.4 | 2.54 V | 221 | 32.20 | 18.40 |
| 8 | 15540.00 | 62.4 PK | 74.0 | -11.6 | 1.79 V | 115 | 43.50 | 18.90 |
| 9 | 15540.00 | 49.3 AV | 54.0 | -4.7 | 1.79 V | 115 | 30.40 | 18.90 |

Remarks:

1. Emission Level(dBuV/m) = Raw Value(dBuV) + Correction Factor(dB/m)
2. Correction Factor(dB/m) = Antenna Factor(dB/m) + Cable Factor(dB)
3. The other emission levels were very low against the limit.
4. Margin value = Emission Level – Limit value
5. " * ": Fundamental frequency.
6. " # ": The radiated frequency is out of the restricted band.



| | | | |
|-----------------|---------------|----------------------|--------------|
| CHANNEL | TX Channel 40 | DETECTOR FUNCTION | Peak (PK) |
| FREQUENCY RANGE | 1GHz ~ 40GHz | | Average (AV) |
| TEST MODE | A | | |

ANTENNA POLARITY & TEST DISTANCE: HORIZONTAL AT 3 M

| NO. | FREQ. (MHz) | EMISSION LEVEL (dBuV/m) | LIMIT (dBuV/m) | MARGIN (dB) | ANTENNA HEIGHT (m) | TABLE ANGLE (Degree) | RAW VALUE (dBuV) | CORRECTION FACTOR (dB/m) |
|-----|----------------|-------------------------------|-------------------|----------------|--------------------------|----------------------------|------------------------|--------------------------------|
| 1 | *5200.00 | 114.8 PK | | | 1.72 H | 342 | 75.20 | 39.60 |
| 2 | *5200.00 | 104.6 AV | | | 1.72 H | 342 | 65.00 | 39.60 |
| 3 | #6933.00 | 58.5 PK | 68.2 | -9.7 | 1.28 H | 335 | 46.80 | 11.70 |
| 4 | #10400.00 | 63.3 PK | 74.0 | -10.7 | 1.13 H | 98 | 44.80 | 18.50 |
| 5 | #10400.00 | 51.3 AV | 54.0 | -2.7 | 1.13 H | 98 | 32.80 | 18.50 |
| 6 | 15600.00 | 61.2 PK | 74.0 | -12.8 | 1.70 H | 288 | 42.40 | 18.80 |
| 7 | 15600.00 | 48.2 AV | 54.0 | -5.8 | 1.70 H | 288 | 29.40 | 18.80 |

ANTENNA POLARITY & TEST DISTANCE: VERTICAL AT 3 M

| NO. | FREQ. (MHz) | EMISSION LEVEL (dBuV/m) | LIMIT (dBuV/m) | MARGIN (dB) | ANTENNA HEIGHT (m) | TABLE ANGLE (Degree) | RAW VALUE (dBuV) | CORRECTION FACTOR (dB/m) |
|-----|----------------|-------------------------------|-------------------|----------------|--------------------------|----------------------------|------------------------|--------------------------------|
| 1 | *5200.00 | 115.8 PK | | | 2.07 V | 323 | 76.20 | 39.60 |
| 2 | *5200.00 | 105.6 AV | | | 2.07 V | 323 | 66.00 | 39.60 |
| 3 | #6933.00 | 60.7 PK | 68.2 | -7.5 | 1.07 V | 271 | 49.00 | 11.70 |
| 4 | #10400.00 | 65.1 PK | 74.0 | -8.9 | 1.02 V | 182 | 46.60 | 18.50 |
| 5 | #10400.00 | 52.4 AV | 54.0 | -1.6 | 1.02 V | 182 | 33.90 | 18.50 |
| 6 | 15600.00 | 67.3 PK | 74.0 | -6.7 | 1.89 V | 111 | 48.50 | 18.80 |
| 7 | 15600.00 | 52.6 AV | 54.0 | -1.4 | 1.89 V | 111 | 33.80 | 18.80 |

Remarks:

1. Emission Level(dBuV/m) = Raw Value(dBuV) + Correction Factor(dB/m)
2. Correction Factor(dB/m) = Antenna Factor(dB/m) + Cable Factor(dB)
3. The other emission levels were very low against the limit.
4. Margin value = Emission Level – Limit value
5. " * ": Fundamental frequency.
6. " # ": The radiated frequency is out of the restricted band.



| | | | |
|-----------------|---------------|----------------------|--------------|
| CHANNEL | TX Channel 48 | DETECTOR FUNCTION | Peak (PK) |
| FREQUENCY RANGE | 1GHz ~ 40GHz | | Average (AV) |
| TEST MODE | A | | |

ANTENNA POLARITY & TEST DISTANCE: HORIZONTAL AT 3 M

| NO. | FREQ. (MHz) | EMISSION LEVEL (dBuV/m) | LIMIT (dBuV/m) | MARGIN (dB) | ANTENNA HEIGHT (m) | TABLE ANGLE (Degree) | RAW VALUE (dBuV) | CORRECTION FACTOR (dB/m) |
|-----|----------------|-------------------------------|-------------------|----------------|--------------------------|----------------------------|------------------------|--------------------------------|
| 1 | *5240.00 | 114.2 PK | | | 1.79 H | 339 | 74.60 | 39.60 |
| 2 | *5240.00 | 103.9 AV | | | 1.79 H | 339 | 64.30 | 39.60 |
| 3 | 5460.00 | 59.8 PK | 74.0 | -14.2 | 1.78 H | 348 | 53.40 | 6.40 |
| 4 | 5460.00 | 47.9 AV | 54.0 | -6.1 | 1.78 H | 348 | 41.50 | 6.40 |
| 5 | #10480.00 | 60.9 PK | 74.0 | -13.1 | 1.98 H | 100 | 41.90 | 19.00 |
| 6 | #10480.00 | 47.7 AV | 54.0 | -6.3 | 1.98 H | 100 | 28.70 | 19.00 |
| 7 | 15720.00 | 61.6 PK | 74.0 | -12.4 | 1.70 H | 291 | 43.10 | 18.50 |
| 8 | 15720.00 | 48.5 AV | 54.0 | -5.5 | 1.70 H | 291 | 30.00 | 18.50 |

ANTENNA POLARITY & TEST DISTANCE: VERTICAL AT 3 M

| NO. | FREQ. (MHz) | EMISSION LEVEL (dBuV/m) | LIMIT (dBuV/m) | MARGIN (dB) | ANTENNA HEIGHT (m) | TABLE ANGLE (Degree) | RAW VALUE (dBuV) | CORRECTION FACTOR (dB/m) |
|-----|----------------|-------------------------------|-------------------|----------------|--------------------------|----------------------------|------------------------|--------------------------------|
| 1 | *5240.00 | 114.8 PK | | | 1.61 V | 324 | 75.20 | 39.60 |
| 2 | *5240.00 | 104.9 AV | | | 1.61 V | 324 | 65.30 | 39.60 |
| 3 | 5460.00 | 60.6 PK | 74.0 | -13.4 | 1.66 V | 333 | 54.20 | 6.40 |
| 4 | 5460.00 | 49.2 AV | 54.0 | -4.8 | 1.66 V | 333 | 42.80 | 6.40 |
| 5 | #10480.00 | 61.9 PK | 74.0 | -12.1 | 1.00 V | 185 | 42.90 | 19.00 |
| 6 | #10480.00 | 49.1 AV | 54.0 | -4.9 | 1.00 V | 185 | 30.10 | 19.00 |
| 7 | 15720.00 | 66.8 PK | 74.0 | -7.2 | 1.89 V | 112 | 48.30 | 18.50 |
| 8 | 15720.00 | 52.3 AV | 54.0 | -1.7 | 1.89 V | 112 | 33.80 | 18.50 |

Remarks:

1. Emission Level(dBuV/m) = Raw Value(dBuV) + Correction Factor(dB/m)
2. Correction Factor(dB/m) = Antenna Factor(dB/m) + Cable Factor(dB)
3. The other emission levels were very low against the limit.
4. Margin value = Emission Level – Limit value
5. " * ": Fundamental frequency.
6. " # ": The radiated frequency is out of the restricted band.

| | | | |
|-----------------|----------------|----------------------|--------------|
| CHANNEL | TX Channel 149 | DETECTOR FUNCTION | Peak (PK) |
| FREQUENCY RANGE | 1GHz ~ 40GHz | | Average (AV) |
| TEST MODE | A | | |

ANTENNA POLARITY & TEST DISTANCE: HORIZONTAL AT 3 M

| NO. | FREQ. (MHz) | EMISSION LEVEL (dBuV/m) | LIMIT (dBuV/m) | MARGIN (dB) | ANTENNA HEIGHT (m) | TABLE ANGLE (Degree) | RAW VALUE (dBuV) | CORRECTION FACTOR (dB/m) |
|-----|----------------|-------------------------------|-------------------|----------------|--------------------------|----------------------------|------------------------|--------------------------------|
| 1 | #5714.00 | 58.9 PK | 74.0 | -15.1 | 1.67 H | 332 | 52.10 | 6.80 |
| 2 | #5714.00 | 47.6 AV | 54.0 | -6.4 | 1.67 H | 332 | 40.80 | 6.80 |
| 3 | #5722.00 | 73.1 PK | 78.2 | -5.1 | 1.67 H | 333 | 66.30 | 6.80 |
| 4 | #5725.00 | 65.9 PK | 78.2 | -12.3 | 1.67 H | 333 | 59.10 | 6.80 |
| 5 | *5745.00 | 107.2 PK | | | 1.86 H | 331 | 66.80 | 40.40 |
| 6 | *5745.00 | 97.3 AV | | | 1.86 H | 331 | 56.90 | 40.40 |
| 7 | 11490.00 | 60.2 PK | 74.0 | -13.8 | 1.56 H | 231 | 41.80 | 18.40 |
| 8 | 11490.00 | 47.0 AV | 54.0 | -7.0 | 1.56 H | 231 | 28.60 | 18.40 |

ANTENNA POLARITY & TEST DISTANCE: VERTICAL AT 3 M

| NO. | FREQ. (MHz) | EMISSION LEVEL (dBuV/m) | LIMIT (dBuV/m) | MARGIN (dB) | ANTENNA HEIGHT (m) | TABLE ANGLE (Degree) | RAW VALUE (dBuV) | CORRECTION FACTOR (dB/m) |
|-----|----------------|-------------------------------|-------------------|----------------|--------------------------|----------------------------|------------------------|--------------------------------|
| 1 | #5714.00 | 71.2 PK | 74.0 | -2.8 | 1.82 V | 310 | 64.40 | 6.80 |
| 2 | #5714.00 | 51.6 AV | 54.0 | -2.4 | 1.82 V | 310 | 44.80 | 6.80 |
| 3 | #5722.90 | 76.7 PK | 78.2 | -1.5 | 1.82 V | 310 | 69.90 | 6.80 |
| 4 | #5725.00 | 66.8 PK | 78.2 | -11.4 | 1.90 V | 302 | 60.00 | 6.80 |
| 5 | *5745.00 | 110.8 PK | | | 1.90 V | 303 | 70.40 | 40.40 |
| 6 | *5745.00 | 100.7 AV | | | 1.90 V | 303 | 60.30 | 40.40 |
| 7 | #10490.00 | 61.2 PK | 74.0 | -12.8 | 1.71 V | 289 | 42.10 | 19.10 |
| 8 | #10490.00 | 48.1 AV | 54.0 | -5.9 | 1.71 V | 289 | 29.00 | 19.10 |

Remarks:

1. Emission Level(dBuV/m) = Raw Value(dBuV) + Correction Factor(dB/m)
2. Correction Factor(dB/m) = Antenna Factor(dB/m) + Cable Factor(dB)
3. The other emission levels were very low against the limit.
4. Margin value = Emission Level – Limit value
5. " * ": Fundamental frequency.
6. " # ": The radiated frequency is out of the restricted band.

| | | | |
|-----------------|----------------|----------------------|--------------|
| CHANNEL | TX Channel 157 | DETECTOR FUNCTION | Peak (PK) |
| FREQUENCY RANGE | 1GHz ~ 40GHz | | Average (AV) |
| TEST MODE | A | | |

ANTENNA POLARITY & TEST DISTANCE: HORIZONTAL AT 3 M

| NO. | FREQ. (MHz) | EMISSION LEVEL (dBuV/m) | LIMIT (dBuV/m) | MARGIN (dB) | ANTENNA HEIGHT (m) | TABLE ANGLE (Degree) | RAW VALUE (dBuV) | CORRECTION FACTOR (dB/m) |
|-----|----------------|-------------------------------|-------------------|----------------|--------------------------|----------------------------|------------------------|--------------------------------|
| 1 | *5785.00 | 108.3 PK | | | 1.63 H | 309 | 67.80 | 40.50 |
| 2 | *5785.00 | 98.1 AV | | | 1.63 H | 309 | 57.60 | 40.50 |
| 3 | 11570.00 | 60.7 PK | 74.0 | -13.3 | 1.63 H | 19 | 42.30 | 18.40 |
| 4 | 11570.00 | 47.6 AV | 54.0 | -6.4 | 1.63 H | 19 | 29.20 | 18.40 |
| 5 | #17355.00 | 69.2 PK | 74.0 | -4.8 | 1.59 H | 22 | 43.00 | 26.20 |
| 6 | #17355.00 | 51.2 AV | 54.0 | -2.8 | 1.59 H | 22 | 25.00 | 26.20 |

ANTENNA POLARITY & TEST DISTANCE: VERTICAL AT 3 M

| NO. | FREQ. (MHz) | EMISSION LEVEL (dBuV/m) | LIMIT (dBuV/m) | MARGIN (dB) | ANTENNA HEIGHT (m) | TABLE ANGLE (Degree) | RAW VALUE (dBuV) | CORRECTION FACTOR (dB/m) |
|-----|----------------|-------------------------------|-------------------|----------------|--------------------------|----------------------------|------------------------|--------------------------------|
| 1 | *5785.00 | 110.7 PK | | | 1.82 V | 303 | 70.20 | 40.50 |
| 2 | *5785.00 | 100.1 AV | | | 1.82 V | 303 | 59.60 | 40.50 |
| 3 | 11570.00 | 66.0 PK | 74.0 | -8.0 | 2.10 V | 142 | 47.60 | 18.40 |
| 4 | 11570.00 | 52.1 AV | 54.0 | -1.9 | 2.10 V | 142 | 33.70 | 18.40 |
| 5 | #17355.00 | 70.5 PK | 74.0 | -3.5 | 1.76 V | 332 | 44.30 | 26.20 |
| 6 | #17355.00 | 52.2 AV | 54.0 | -1.8 | 1.76 V | 332 | 26.00 | 26.20 |

Remarks:

1. Emission Level(dBuV/m) = Raw Value(dBuV) + Correction Factor(dB/m)
2. Correction Factor(dB/m) = Antenna Factor(dB/m) + Cable Factor(dB)
3. The other emission levels were very low against the limit.
4. Margin value = Emission Level – Limit value
5. " * ": Fundamental frequency.



| | | | |
|-----------------|----------------|----------------------|--------------|
| CHANNEL | TX Channel 165 | DETECTOR FUNCTION | Peak (PK) |
| FREQUENCY RANGE | 1GHz ~ 40GHz | | Average (AV) |
| TEST MODE | A | | |

ANTENNA POLARITY & TEST DISTANCE: HORIZONTAL AT 3 M

| NO. | FREQ. (MHz) | EMISSION LEVEL (dBuV/m) | LIMIT (dBuV/m) | MARGIN (dB) | ANTENNA HEIGHT (m) | TABLE ANGLE (Degree) | RAW VALUE (dBuV) | CORRECTION FACTOR (dB/m) |
|-----|-------------|-------------------------|----------------|-------------|--------------------|----------------------|------------------|--------------------------|
| 1 | *5825.00 | 108.8 PK | | | 1.58 H | 307 | 68.30 | 40.50 |
| 2 | *5825.00 | 98.6 AV | | | 1.58 H | 307 | 58.10 | 40.50 |
| 3 | #5850.00 | 62.7 PK | 78.2 | -15.5 | 1.78 H | 306 | 55.80 | 6.90 |
| 4 | #5853.00 | 72.7 PK | 78.2 | -5.5 | 1.78 H | 306 | 65.70 | 7.00 |
| 5 | #5861.00 | 64.3 PK | 74.0 | -9.7 | 4.00 H | 311 | 57.30 | 7.00 |
| 6 | #5861.00 | 47.5 AV | 54.0 | -6.5 | 4.00 H | 311 | 40.50 | 7.00 |
| 7 | 11650.00 | 60.8 PK | 74.0 | -13.2 | 1.59 H | 286 | 41.90 | 18.90 |
| 8 | 11650.00 | 47.4 AV | 54.0 | -6.6 | 1.59 H | 286 | 28.50 | 18.90 |
| 9 | #17475.00 | 69.7 PK | 74.0 | -4.3 | 1.50 H | 234 | 42.70 | 27.00 |
| 10 | #17475.00 | 51.5 AV | 54.0 | -2.5 | 1.50 H | 234 | 24.50 | 27.00 |

ANTENNA POLARITY & TEST DISTANCE: VERTICAL AT 3 M

| NO. | FREQ. (MHz) | EMISSION LEVEL (dBuV/m) | LIMIT (dBuV/m) | MARGIN (dB) | ANTENNA HEIGHT (m) | TABLE ANGLE (Degree) | RAW VALUE (dBuV) | CORRECTION FACTOR (dB/m) |
|-----|-------------|-------------------------|----------------|-------------|--------------------|----------------------|------------------|--------------------------|
| 1 | *5825.00 | 110.7 PK | | | 1.86 V | 298 | 70.20 | 40.50 |
| 2 | *5825.00 | 101.0 AV | | | 1.86 V | 298 | 60.50 | 40.50 |
| 3 | #5850.00 | 65.0 PK | 78.2 | -13.2 | 2.30 V | 18 | 58.10 | 6.90 |
| 4 | #5853.00 | 74.3 PK | 78.2 | -3.9 | 2.30 V | 18 | 67.30 | 7.00 |
| 5 | #5861.00 | 66.7 PK | 74.0 | -7.3 | 1.78 V | 346 | 59.70 | 7.00 |
| 6 | #5861.00 | 49.9 AV | 54.0 | -4.1 | 1.78 V | 346 | 42.90 | 7.00 |
| 7 | 11650.00 | 65.7 PK | 74.0 | -8.3 | 2.07 V | 142 | 46.80 | 18.90 |
| 8 | 11650.00 | 52.2 AV | 54.0 | -1.8 | 2.07 V | 142 | 33.30 | 18.90 |
| 9 | #17475.00 | 70.2 PK | 74.0 | -3.8 | 1.75 V | 331 | 43.20 | 27.00 |
| 10 | #17475.00 | 52.1 AV | 54.0 | -1.9 | 1.75 V | 331 | 25.10 | 27.00 |

Remarks:

1. Emission Level(dBuV/m) = Raw Value(dBuV) + Correction Factor(dB/m)
2. Correction Factor(dB/m) = Antenna Factor(dB/m) + Cable Factor(dB)
3. The other emission levels were very low against the limit.
4. Margin value = Emission Level – Limit value
5. " * ": Fundamental frequency.
6. " # ": The radiated frequency is out of the restricted band.

802.11n (HT20)

| | | | |
|-----------------|---------------|----------------------|---------------------------|
| CHANNEL | TX Channel 36 | DETECTOR FUNCTION | Peak (PK) Average (AV) |
| FREQUENCY RANGE | 1GHz ~ 40GHz | | |
| TEST MODE | A | | |

ANTENNA POLARITY & TEST DISTANCE: HORIZONTAL AT 3 M

| NO. | FREQ. (MHz) | EMISSION LEVEL (dBuV/m) | LIMIT (dBuV/m) | MARGIN (dB) | ANTENNA HEIGHT (m) | TABLE ANGLE (Degree) | RAW VALUE (dBuV) | CORRECTION FACTOR (dB/m) |
|-----|----------------|-------------------------------|-------------------|----------------|--------------------------|----------------------------|------------------------|--------------------------------|
| 1 | 5150.00 | 70.5 PK | 74.0 | -3.5 | 1.56 H | 322 | 64.50 | 6.00 |
| 2 | 5150.00 | 52.5 AV | 54.0 | -1.5 | 1.56 H | 322 | 46.50 | 6.00 |
| 3 | *5180.00 | 113.4 PK | | | 1.80 H | 322 | 73.90 | 39.50 |
| 4 | *5180.00 | 102.9 AV | | | 1.80 H | 322 | 63.40 | 39.50 |
| 5 | #10360.00 | 61.2 PK | 74.0 | -12.8 | 2.01 H | 282 | 42.80 | 18.40 |
| 6 | #10360.00 | 48.1 AV | 54.0 | -5.9 | 2.01 H | 282 | 29.70 | 18.40 |
| 7 | 15540.00 | 61.1 PK | 74.0 | -12.9 | 1.73 H | 19 | 42.20 | 18.90 |
| 8 | 15540.00 | 48.5 AV | 54.0 | -5.5 | 1.73 H | 19 | 29.60 | 18.90 |

ANTENNA POLARITY & TEST DISTANCE: VERTICAL AT 3 M

| NO. | FREQ. (MHz) | EMISSION LEVEL (dBuV/m) | LIMIT (dBuV/m) | MARGIN (dB) | ANTENNA HEIGHT (m) | TABLE ANGLE (Degree) | RAW VALUE (dBuV) | CORRECTION FACTOR (dB/m) |
|-----|----------------|-------------------------------|-------------------|----------------|--------------------------|----------------------------|------------------------|--------------------------------|
| 1 | 5150.00 | 69.9 PK | 74.0 | -4.1 | 2.00 V | 330 | 63.90 | 6.00 |
| 2 | 5150.00 | 51.2 AV | 54.0 | -2.8 | 2.00 V | 330 | 45.20 | 6.00 |
| 3 | *5180.00 | 113.0 PK | | | 1.72 V | 329 | 73.50 | 39.50 |
| 4 | *5180.00 | 102.5 AV | | | 1.72 V | 329 | 63.00 | 39.50 |
| 5 | #10360.00 | 62.9 PK | 74.0 | -11.1 | 2.15 V | 178 | 44.50 | 18.40 |
| 6 | #10360.00 | 49.8 AV | 54.0 | -4.2 | 2.15 V | 178 | 31.40 | 18.40 |
| 7 | 15540.00 | 62.1 PK | 74.0 | -11.9 | 1.77 V | 79 | 43.20 | 18.90 |
| 8 | 15540.00 | 49.5 AV | 54.0 | -4.5 | 1.77 V | 79 | 30.60 | 18.90 |

Remarks:

1. Emission Level(dBuV/m) = Raw Value(dBuV) + Correction Factor(dB/m)
2. Correction Factor(dB/m) = Antenna Factor(dB/m) + Cable Factor(dB)
3. The other emission levels were very low against the limit.
4. Margin value = Emission Level – Limit value
5. " * ": Fundamental frequency.
6. " # ": The radiated frequency is out of the restricted band.

| | | | |
|-----------------|---------------|----------------------|--------------|
| CHANNEL | TX Channel 40 | DETECTOR FUNCTION | Peak (PK) |
| FREQUENCY RANGE | 1GHz ~ 40GHz | | Average (AV) |
| TEST MODE | A | | |

ANTENNA POLARITY & TEST DISTANCE: HORIZONTAL AT 3 M

| NO. | FREQ. (MHz) | EMISSION LEVEL (dBuV/m) | LIMIT (dBuV/m) | MARGIN (dB) | ANTENNA HEIGHT (m) | TABLE ANGLE (Degree) | RAW VALUE (dBuV) | CORRECTION FACTOR (dB/m) |
|-----|----------------|-------------------------------|-------------------|----------------|--------------------------|----------------------------|------------------------|--------------------------------|
| 1 | *5200.00 | 114.2 PK | | | 1.68 H | 339 | 74.60 | 39.60 |
| 2 | *5200.00 | 104.2 AV | | | 1.68 H | 339 | 64.60 | 39.60 |
| 3 | #10400.00 | 62.5 PK | 74.0 | -11.5 | 1.33 H | 96 | 44.00 | 18.50 |
| 4 | #10400.00 | 50.3 AV | 54.0 | -3.7 | 1.33 H | 96 | 31.80 | 18.50 |
| 5 | 15600.00 | 61.0 PK | 74.0 | -13.0 | 1.70 H | 288 | 42.20 | 18.80 |
| 6 | 15600.00 | 47.8 AV | 54.0 | -6.2 | 1.70 H | 288 | 29.00 | 18.80 |

ANTENNA POLARITY & TEST DISTANCE: VERTICAL AT 3 M

| NO. | FREQ. (MHz) | EMISSION LEVEL (dBuV/m) | LIMIT (dBuV/m) | MARGIN (dB) | ANTENNA HEIGHT (m) | TABLE ANGLE (Degree) | RAW VALUE (dBuV) | CORRECTION FACTOR (dB/m) |
|-----|----------------|-------------------------------|-------------------|----------------|--------------------------|----------------------------|------------------------|--------------------------------|
| 1 | *5200.00 | 113.7 PK | | | 2.02 V | 319 | 74.10 | 39.60 |
| 2 | *5200.00 | 103.4 AV | | | 2.02 V | 319 | 63.80 | 39.60 |
| 3 | #10400.00 | 61.1 PK | 74.0 | -12.9 | 1.23 V | 179 | 42.60 | 18.50 |
| 4 | #10400.00 | 48.0 AV | 54.0 | -6.0 | 1.23 V | 179 | 29.50 | 18.50 |
| 5 | 15600.00 | 67.2 PK | 74.0 | -6.8 | 1.88 V | 111 | 48.40 | 18.80 |
| 6 | 15600.00 | 52.5 AV | 54.0 | -1.5 | 1.88 V | 111 | 33.70 | 18.80 |

Remarks:

1. Emission Level(dBuV/m) = Raw Value(dBuV) + Correction Factor(dB/m)
2. Correction Factor(dB/m) = Antenna Factor(dB/m) + Cable Factor(dB)
3. The other emission levels were very low against the limit.
4. Margin value = Emission Level – Limit value
5. " * ": Fundamental frequency.
6. " # ": The radiated frequency is out of the restricted band.

| | | | |
|-----------------|---------------|----------------------|--------------|
| CHANNEL | TX Channel 48 | DETECTOR FUNCTION | Peak (PK) |
| FREQUENCY RANGE | 1GHz ~ 40GHz | | Average (AV) |
| TEST MODE | A | | |

ANTENNA POLARITY & TEST DISTANCE: HORIZONTAL AT 3 M

| NO. | FREQ. (MHz) | EMISSION LEVEL (dBuV/m) | LIMIT (dBuV/m) | MARGIN (dB) | ANTENNA HEIGHT (m) | TABLE ANGLE (Degree) | RAW VALUE (dBuV) | CORRECTION FACTOR (dB/m) |
|-----|----------------|-------------------------------|-------------------|----------------|--------------------------|----------------------------|------------------------|--------------------------------|
| 1 | *5240.00 | 113.6 PK | | | 1.61 H | 337 | 74.00 | 39.60 |
| 2 | *5240.00 | 103.5 AV | | | 1.61 H | 337 | 63.90 | 39.60 |
| 3 | 5460.00 | 61.0 PK | 74.0 | -13.0 | 1.56 H | 324 | 54.60 | 6.40 |
| 4 | 5460.00 | 49.4 AV | 54.0 | -4.6 | 1.56 H | 324 | 43.00 | 6.40 |
| 5 | #10480.00 | 61.2 PK | 74.0 | -12.8 | 2.00 H | 123 | 42.20 | 19.00 |
| 6 | #10480.00 | 48.0 AV | 54.0 | -6.0 | 2.00 H | 123 | 29.00 | 19.00 |
| 7 | 15720.00 | 62.3 PK | 74.0 | -11.7 | 1.71 H | 293 | 43.80 | 18.50 |
| 8 | 15720.00 | 49.1 AV | 54.0 | -4.9 | 1.71 H | 293 | 30.60 | 18.50 |

ANTENNA POLARITY & TEST DISTANCE: VERTICAL AT 3 M

| NO. | FREQ. (MHz) | EMISSION LEVEL (dBuV/m) | LIMIT (dBuV/m) | MARGIN (dB) | ANTENNA HEIGHT (m) | TABLE ANGLE (Degree) | RAW VALUE (dBuV) | CORRECTION FACTOR (dB/m) |
|-----|----------------|-------------------------------|-------------------|----------------|--------------------------|----------------------------|------------------------|--------------------------------|
| 1 | *5240.00 | 115.1 PK | | | 1.61 V | 331 | 75.50 | 39.60 |
| 2 | *5240.00 | 105.5 AV | | | 1.61 V | 331 | 65.90 | 39.60 |
| 3 | 5460.00 | 58.9 PK | 74.0 | -15.1 | 1.71 V | 167 | 52.50 | 6.40 |
| 4 | 5460.00 | 47.4 AV | 54.0 | -6.6 | 1.71 V | 167 | 41.00 | 6.40 |
| 5 | #10480.00 | 61.1 PK | 74.0 | -12.9 | 1.90 V | 122 | 42.10 | 19.00 |
| 6 | #10480.00 | 48.2 AV | 54.0 | -5.8 | 1.90 V | 122 | 29.20 | 19.00 |
| 7 | 15720.00 | 66.0 PK | 74.0 | -8.0 | 1.87 V | 112 | 47.50 | 18.50 |
| 8 | 15720.00 | 52.5 AV | 54.0 | -1.5 | 1.87 V | 112 | 34.00 | 18.50 |

Remarks:

1. Emission Level(dBuV/m) = Raw Value(dBuV) + Correction Factor(dB/m)
2. Correction Factor(dB/m) = Antenna Factor(dB/m) + Cable Factor(dB)
3. The other emission levels were very low against the limit.
4. Margin value = Emission Level – Limit value
5. " * ": Fundamental frequency.
6. " # ": The radiated frequency is out of the restricted band.

| | | | |
|-----------------|----------------|----------------------|--------------|
| CHANNEL | TX Channel 149 | DETECTOR FUNCTION | Peak (PK) |
| FREQUENCY RANGE | 1GHz ~ 40GHz | | Average (AV) |
| TEST MODE | A | | |

ANTENNA POLARITY & TEST DISTANCE: HORIZONTAL AT 3 M

| NO. | FREQ. (MHz) | EMISSION LEVEL (dBuV/m) | LIMIT (dBuV/m) | MARGIN (dB) | ANTENNA HEIGHT (m) | TABLE ANGLE (Degree) | RAW VALUE (dBuV) | CORRECTION FACTOR (dB/m) |
|-----|----------------|-------------------------------|-------------------|----------------|--------------------------|----------------------------|------------------------|--------------------------------|
| 1 | #5714.90 | 66.9 PK | 74.0 | -7.1 | 1.57 H | 331 | 60.10 | 6.80 |
| 2 | #5714.90 | 47.8 AV | 54.0 | -6.2 | 1.57 H | 331 | 41.00 | 6.80 |
| 3 | #5722.90 | 74.6 PK | 78.2 | -3.6 | 1.89 H | 11 | 67.80 | 6.80 |
| 4 | #5725.00 | 55.2 PK | 78.2 | -23.0 | 1.87 H | 13 | 48.40 | 6.80 |
| 5 | *5745.00 | 105.3 PK | | | 1.55 H | 304 | 64.90 | 40.40 |
| 6 | *5745.00 | 95.5 AV | | | 1.55 H | 304 | 55.10 | 40.40 |
| 7 | 11490.00 | 58.5 PK | 74.0 | -15.5 | 1.15 H | 69 | 40.10 | 18.40 |
| 8 | 11490.00 | 46.1 AV | 54.0 | -7.9 | 1.15 H | 69 | 27.70 | 18.40 |

ANTENNA POLARITY & TEST DISTANCE: VERTICAL AT 3 M

| NO. | FREQ. (MHz) | EMISSION LEVEL (dBuV/m) | LIMIT (dBuV/m) | MARGIN (dB) | ANTENNA HEIGHT (m) | TABLE ANGLE (Degree) | RAW VALUE (dBuV) | CORRECTION FACTOR (dB/m) |
|-----|----------------|-------------------------------|-------------------|----------------|--------------------------|----------------------------|------------------------|--------------------------------|
| 1 | #5714.90 | 66.2 PK | 74.0 | -7.8 | 2.06 V | 60 | 59.40 | 6.80 |
| 2 | #5714.90 | 48.8 AV | 54.0 | -5.2 | 2.06 V | 60 | 42.00 | 6.80 |
| 3 | #5722.90 | 76.8 PK | 78.2 | -1.4 | 1.81 V | 16 | 70.00 | 6.80 |
| 4 | #5725.00 | 57.0 PK | 78.2 | -21.2 | 1.88 V | 12 | 50.20 | 6.80 |
| 5 | *5745.00 | 108.9 PK | | | 1.89 V | 300 | 68.50 | 40.40 |
| 6 | *5745.00 | 98.9 AV | | | 1.89 V | 300 | 58.50 | 40.40 |
| 7 | 11490.00 | 58.5 PK | 74.0 | -15.5 | 1.78 V | 273 | 40.10 | 18.40 |
| 8 | 11490.00 | 46.0 AV | 54.0 | -8.0 | 1.78 V | 273 | 27.60 | 18.40 |

Remarks:

1. Emission Level(dBuV/m) = Raw Value(dBuV) + Correction Factor(dB/m)
2. Correction Factor(dB/m) = Antenna Factor(dB/m) + Cable Factor(dB)
3. The other emission levels were very low against the limit.
4. Margin value = Emission Level – Limit value
5. " * ": Fundamental frequency.
6. " # ": The radiated frequency is out of the restricted band.

| | | | |
|-----------------|----------------|----------------------|--------------|
| CHANNEL | TX Channel 157 | DETECTOR FUNCTION | Peak (PK) |
| FREQUENCY RANGE | 1GHz ~ 40GHz | | Average (AV) |
| TEST MODE | A | | |

ANTENNA POLARITY & TEST DISTANCE: HORIZONTAL AT 3 M

| NO. | FREQ. (MHz) | EMISSION LEVEL (dBuV/m) | LIMIT (dBuV/m) | MARGIN (dB) | ANTENNA HEIGHT (m) | TABLE ANGLE (Degree) | RAW VALUE (dBuV) | CORRECTION FACTOR (dB/m) |
|-----|----------------|-------------------------------|-------------------|----------------|--------------------------|----------------------------|------------------------|--------------------------------|
| 1 | *5785.00 | 109.7 PK | | | 1.66 H | 306 | 69.20 | 40.50 |
| 2 | *5785.00 | 99.2 AV | | | 1.66 H | 306 | 58.70 | 40.50 |
| 3 | 11570.00 | 63.0 PK | 74.0 | -11.0 | 1.02 H | 129 | 44.60 | 18.40 |
| 4 | 11570.00 | 50.6 AV | 54.0 | -3.4 | 1.02 H | 129 | 32.20 | 18.40 |

ANTENNA POLARITY & TEST DISTANCE: VERTICAL AT 3 M

| NO. | FREQ. (MHz) | EMISSION LEVEL (dBuV/m) | LIMIT (dBuV/m) | MARGIN (dB) | ANTENNA HEIGHT (m) | TABLE ANGLE (Degree) | RAW VALUE (dBuV) | CORRECTION FACTOR (dB/m) |
|-----|----------------|-------------------------------|-------------------|----------------|--------------------------|----------------------------|------------------------|--------------------------------|
| 1 | *5785.00 | 112.4 PK | | | 1.31 V | 274 | 71.90 | 40.50 |
| 2 | *5785.00 | 102.2 AV | | | 1.31 V | 274 | 61.70 | 40.50 |
| 3 | 11570.00 | 63.8 PK | 74.0 | -10.2 | 1.15 V | 323 | 45.40 | 18.40 |
| 4 | 11570.00 | 52.2 AV | 54.0 | -1.8 | 1.15 V | 323 | 33.80 | 18.40 |

Remarks:

1. Emission Level(dBuV/m) = Raw Value(dBuV) + Correction Factor(dB/m)
2. Correction Factor(dB/m) = Antenna Factor(dB/m) + Cable Factor(dB)
3. The other emission levels were very low against the limit.
4. Margin value = Emission Level – Limit value
5. " * ": Fundamental frequency.
6. " # ": The radiated frequency is out of the restricted band.

| | | | |
|-----------------|----------------|----------------------|--------------|
| CHANNEL | TX Channel 165 | DETECTOR FUNCTION | Peak (PK) |
| FREQUENCY RANGE | 1GHz ~ 40GHz | | Average (AV) |
| TEST MODE | A | | |

ANTENNA POLARITY & TEST DISTANCE: HORIZONTAL AT 3 M

| NO. | FREQ. (MHz) | EMISSION LEVEL (dBuV/m) | LIMIT (dBuV/m) | MARGIN (dB) | ANTENNA HEIGHT (m) | TABLE ANGLE (Degree) | RAW VALUE (dBuV) | CORRECTION FACTOR (dB/m) |
|-----|----------------|-------------------------------|-------------------|----------------|--------------------------|----------------------------|------------------------|--------------------------------|
| 1 | *5825.00 | 107.3 PK | | | 1.56 H | 302 | 66.80 | 40.50 |
| 2 | *5825.00 | 97.6 AV | | | 1.56 H | 302 | 57.10 | 40.50 |
| 3 | #5850.00 | 51.2 PK | 78.2 | -27.0 | 1.67 H | 300 | 44.30 | 6.90 |
| 4 | #5852.10 | 70.8 PK | 78.2 | -7.4 | 1.66 H | 301 | 63.80 | 7.00 |
| 5 | #5860.10 | 65.2 PK | 74.0 | -8.8 | 1.72 H | 304 | 58.20 | 7.00 |
| 6 | #5860.10 | 49.0 AV | 54.0 | -5.0 | 1.72 H | 304 | 42.00 | 7.00 |
| 7 | 11650.00 | 63.2 PK | 74.0 | -10.8 | 1.12 H | 101 | 44.30 | 18.90 |
| 8 | 11650.00 | 49.7 AV | 54.0 | -4.3 | 1.12 H | 101 | 30.80 | 18.90 |

ANTENNA POLARITY & TEST DISTANCE: VERTICAL AT 3 M

| NO. | FREQ. (MHz) | EMISSION LEVEL (dBuV/m) | LIMIT (dBuV/m) | MARGIN (dB) | ANTENNA HEIGHT (m) | TABLE ANGLE (Degree) | RAW VALUE (dBuV) | CORRECTION FACTOR (dB/m) |
|-----|----------------|-------------------------------|-------------------|----------------|--------------------------|----------------------------|------------------------|--------------------------------|
| 1 | *5825.00 | 110.7 PK | | | 1.63 V | 300 | 70.20 | 40.50 |
| 2 | *5825.00 | 101.3 AV | | | 1.63 V | 300 | 60.80 | 40.50 |
| 3 | #5850.00 | 56.0 PK | 78.2 | -22.2 | 1.34 V | 334 | 49.10 | 6.90 |
| 4 | #5852.10 | 72.8 PK | 78.2 | -5.4 | 1.35 V | 330 | 65.80 | 7.00 |
| 5 | #5860.10 | 72.2 PK | 74.0 | -1.8 | 1.36 V | 270 | 65.20 | 7.00 |
| 6 | #5860.10 | 51.4 AV | 54.0 | -2.6 | 1.36 V | 270 | 44.40 | 7.00 |
| 7 | 11650.00 | 64.0 PK | 74.0 | -10.0 | 1.16 V | 291 | 45.10 | 18.90 |
| 8 | 11650.00 | 49.7 AV | 54.0 | -4.3 | 1.16 V | 291 | 30.80 | 18.90 |

Remarks:

1. Emission Level(dBuV/m) = Raw Value(dBuV) + Correction Factor(dB/m)
2. Correction Factor(dB/m) = Antenna Factor(dB/m) + Cable Factor(dB)
3. The other emission levels were very low against the limit.
4. Margin value = Emission Level – Limit value
5. " * ": Fundamental frequency.
6. " # ": The radiated frequency is out of the restricted band.

802.11n (HT40)

| | | | |
|-----------------|---------------|----------------------|---------------------------|
| CHANNEL | TX Channel 38 | DETECTOR FUNCTION | Peak (PK) Average (AV) |
| FREQUENCY RANGE | 1GHz ~ 40GHz | | |
| TEST MODE | A | | |

ANTENNA POLARITY & TEST DISTANCE: HORIZONTAL AT 3 M

| NO. | FREQ. (MHz) | EMISSION LEVEL (dBuV/m) | LIMIT (dBuV/m) | MARGIN (dB) | ANTENNA HEIGHT (m) | TABLE ANGLE (Degree) | RAW VALUE (dBuV) | CORRECTION FACTOR (dB/m) |
|-----|----------------|-------------------------------|-------------------|----------------|--------------------------|----------------------------|------------------------|--------------------------------|
| 1 | 5150.00 | 70.3 PK | 74.0 | -3.7 | 1.58 H | 345 | 64.30 | 6.00 |
| 2 | 5150.00 | 52.1 AV | 54.0 | -1.9 | 1.58 H | 345 | 46.10 | 6.00 |
| 3 | *5190.00 | 105.1 PK | | | 1.78 H | 340 | 65.60 | 39.50 |
| 4 | *5190.00 | 95.0 AV | | | 1.78 H | 340 | 55.50 | 39.50 |
| 5 | #10380.00 | 60.6 PK | 74.0 | -13.4 | 1.68 H | 320 | 42.10 | 18.50 |
| 6 | #10380.00 | 47.4 AV | 54.0 | -6.6 | 1.68 H | 320 | 28.90 | 18.50 |

ANTENNA POLARITY & TEST DISTANCE: VERTICAL AT 3 M

| NO. | FREQ. (MHz) | EMISSION LEVEL (dBuV/m) | LIMIT (dBuV/m) | MARGIN (dB) | ANTENNA HEIGHT (m) | TABLE ANGLE (Degree) | RAW VALUE (dBuV) | CORRECTION FACTOR (dB/m) |
|-----|----------------|-------------------------------|-------------------|----------------|--------------------------|----------------------------|------------------------|--------------------------------|
| 1 | 5150.00 | 68.8 PK | 74.0 | -5.2 | 1.70 V | 319 | 62.80 | 6.00 |
| 2 | 5150.00 | 48.5 AV | 54.0 | -5.5 | 1.70 V | 319 | 42.50 | 6.00 |
| 3 | *5190.00 | 107.3 PK | | | 1.70 V | 337 | 67.80 | 39.50 |
| 4 | *5190.00 | 97.0 AV | | | 1.70 V | 337 | 57.50 | 39.50 |
| 5 | #10380.00 | 61.0 PK | 74.0 | -13.0 | 2.02 V | 170 | 42.50 | 18.50 |
| 6 | #10380.00 | 47.9 AV | 54.0 | -6.1 | 2.02 V | 170 | 29.40 | 18.50 |

Remarks:

1. Emission Level(dBuV/m) = Raw Value(dBuV) + Correction Factor(dB/m)
2. Correction Factor(dB/m) = Antenna Factor(dB/m) + Cable Factor(dB)
3. The other emission levels were very low against the limit.
4. Margin value = Emission Level – Limit value
5. " * ": Fundamental frequency.
6. " # ": The radiated frequency is out of the restricted band.

| | | | |
|-----------------|---------------|----------------------|--------------|
| CHANNEL | TX Channel 46 | DETECTOR FUNCTION | Peak (PK) |
| FREQUENCY RANGE | 1GHz ~ 40GHz | | Average (AV) |
| TEST MODE | A | | |

ANTENNA POLARITY & TEST DISTANCE: HORIZONTAL AT 3 M

| NO. | FREQ. (MHz) | EMISSION LEVEL (dBuV/m) | LIMIT (dBuV/m) | MARGIN (dB) | ANTENNA HEIGHT (m) | TABLE ANGLE (Degree) | RAW VALUE (dBuV) | CORRECTION FACTOR (dB/m) |
|-----|----------------|-------------------------------|-------------------|----------------|--------------------------|----------------------------|------------------------|--------------------------------|
| 1 | 5150.00 | 58.9 PK | 74.0 | -15.1 | 1.71 H | 19 | 52.90 | 6.00 |
| 2 | 5150.00 | 47.4 AV | 54.0 | -6.6 | 1.71 H | 19 | 41.40 | 6.00 |
| 3 | *5230.00 | 111.2 PK | | | 1.59 H | 339 | 71.60 | 39.60 |
| 4 | *5230.00 | 101.0 AV | | | 1.59 H | 339 | 61.40 | 39.60 |
| 5 | #10460.00 | 60.9 PK | 74.0 | -13.1 | 1.75 H | 290 | 42.00 | 18.90 |
| 6 | #10460.00 | 47.9 AV | 54.0 | -6.1 | 1.75 H | 290 | 29.00 | 18.90 |
| 7 | 15690.00 | 60.2 PK | 74.0 | -13.8 | 1.67 H | 330 | 41.60 | 18.60 |
| 8 | 15690.00 | 47.2 AV | 54.0 | -6.8 | 1.67 H | 330 | 28.60 | 18.60 |

ANTENNA POLARITY & TEST DISTANCE: VERTICAL AT 3 M

| NO. | FREQ. (MHz) | EMISSION LEVEL (dBuV/m) | LIMIT (dBuV/m) | MARGIN (dB) | ANTENNA HEIGHT (m) | TABLE ANGLE (Degree) | RAW VALUE (dBuV) | CORRECTION FACTOR (dB/m) |
|-----|----------------|-------------------------------|-------------------|----------------|--------------------------|----------------------------|------------------------|--------------------------------|
| 1 | 5150.00 | 59.0 PK | 74.0 | -15.0 | 1.80 V | 292 | 53.00 | 6.00 |
| 2 | 5150.00 | 47.7 AV | 54.0 | -6.3 | 1.80 V | 292 | 41.70 | 6.00 |
| 3 | *5230.00 | 112.4 PK | | | 1.87 V | 331 | 72.80 | 39.60 |
| 4 | *5230.00 | 102.6 AV | | | 1.87 V | 331 | 63.00 | 39.60 |
| 5 | #10460.00 | 60.8 PK | 74.0 | -13.2 | 1.47 V | 181 | 41.90 | 18.90 |
| 6 | #10460.00 | 47.5 AV | 54.0 | -6.5 | 1.47 V | 181 | 28.60 | 18.90 |
| 7 | 15690.00 | 66.0 PK | 74.0 | -8.0 | 1.83 V | 111 | 47.40 | 18.60 |
| 8 | 15690.00 | 52.6 AV | 54.0 | -1.4 | 1.83 V | 111 | 34.00 | 18.60 |

Remarks:

1. Emission Level(dBuV/m) = Raw Value(dBuV) + Correction Factor(dB/m)
2. Correction Factor(dB/m) = Antenna Factor(dB/m) + Cable Factor(dB)
3. The other emission levels were very low against the limit.
4. Margin value = Emission Level – Limit value
5. " * ": Fundamental frequency.
6. " # ": The radiated frequency is out of the restricted band.



| | | | |
|-----------------|----------------|----------------------|--------------|
| CHANNEL | TX Channel 151 | DETECTOR FUNCTION | Peak (PK) |
| FREQUENCY RANGE | 1GHz ~ 40GHz | | Average (AV) |
| TEST MODE | A | | |

ANTENNA POLARITY & TEST DISTANCE: HORIZONTAL AT 3 M

| NO. | FREQ. (MHz) | EMISSION LEVEL (dBuV/m) | LIMIT (dBuV/m) | MARGIN (dB) | ANTENNA HEIGHT (m) | TABLE ANGLE (Degree) | RAW VALUE (dBuV) | CORRECTION FACTOR (dB/m) |
|-----|-------------|-------------------------|----------------|-------------|--------------------|----------------------|------------------|--------------------------|
| 1 | #5714.90 | 69.5 PK | 74.0 | -4.5 | 1.60 H | 335 | 62.70 | 6.80 |
| 2 | #5714.90 | 51.3 AV | 54.0 | -2.7 | 1.60 H | 335 | 44.50 | 6.80 |
| 3 | #5722.90 | 74.7 PK | 78.2 | -3.5 | 1.76 H | 327 | 67.90 | 6.80 |
| 4 | #5725.00 | 59.2 PK | 78.2 | -19.0 | 1.66 H | 327 | 52.40 | 6.80 |
| 5 | *5755.00 | 101.8 PK | | | 1.55 H | 325 | 61.30 | 40.50 |
| 6 | *5755.00 | 92.0 AV | | | 1.55 H | 325 | 51.50 | 40.50 |
| 7 | 11510.00 | 57.9 PK | 74.0 | -16.1 | 1.16 H | 123 | 39.60 | 18.30 |
| 8 | 11510.00 | 46.5 AV | 54.0 | -7.5 | 1.16 H | 123 | 28.20 | 18.30 |

ANTENNA POLARITY & TEST DISTANCE: VERTICAL AT 3 M

| NO. | FREQ. (MHz) | EMISSION LEVEL (dBuV/m) | LIMIT (dBuV/m) | MARGIN (dB) | ANTENNA HEIGHT (m) | TABLE ANGLE (Degree) | RAW VALUE (dBuV) | CORRECTION FACTOR (dB/m) |
|-----|-------------|-------------------------|----------------|-------------|--------------------|----------------------|------------------|--------------------------|
| 1 | #5714.90 | 72.4 PK | 74.0 | -1.6 | 1.83 V | 301 | 65.60 | 6.80 |
| 2 | #5714.90 | 52.3 AV | 54.0 | -1.7 | 1.83 V | 301 | 45.50 | 6.80 |
| 3 | #5722.90 | 76.6 PK | 78.2 | -1.6 | 1.84 V | 303 | 69.80 | 6.80 |
| 4 | #5725.00 | 60.9 PK | 78.2 | -17.3 | 1.81 V | 302 | 54.10 | 6.80 |
| 5 | *5755.00 | 104.7 PK | | | 1.72 V | 300 | 64.20 | 40.50 |
| 6 | *5755.00 | 95.5 AV | | | 1.72 V | 300 | 55.00 | 40.50 |
| 7 | 11510.00 | 57.9 PK | 74.0 | -16.1 | 1.61 V | 277 | 39.60 | 18.30 |
| 8 | 11510.00 | 46.2 AV | 54.0 | -7.8 | 1.61 V | 277 | 27.90 | 18.30 |

Remarks:

1. Emission Level(dBuV/m) = Raw Value(dBuV) + Correction Factor(dB/m)
2. Correction Factor(dB/m) = Antenna Factor(dB/m) + Cable Factor(dB)
3. The other emission levels were very low against the limit.
4. Margin value = Emission Level – Limit value
5. " * ": Fundamental frequency.
6. " # ": The radiated frequency is out of the restricted band.

| | | | |
|-----------------|----------------|----------------------|--------------|
| CHANNEL | TX Channel 159 | DETECTOR FUNCTION | Peak (PK) |
| FREQUENCY RANGE | 1GHz ~ 40GHz | | Average (AV) |
| TEST MODE | A | | |

ANTENNA POLARITY & TEST DISTANCE: HORIZONTAL AT 3 M

| NO. | FREQ. (MHz) | EMISSION LEVEL (dBuV/m) | LIMIT (dBuV/m) | MARGIN (dB) | ANTENNA HEIGHT (m) | TABLE ANGLE (Degree) | RAW VALUE (dBuV) | CORRECTION FACTOR (dB/m) |
|-----|----------------|-------------------------------|-------------------|----------------|--------------------------|----------------------------|------------------------|--------------------------------|
| 1 | *5795.00 | 104.6 PK | | | 1.45 H | 307 | 64.10 | 40.50 |
| 2 | *5795.00 | 95.1 AV | | | 1.45 H | 307 | 54.60 | 40.50 |
| 3 | #5850.00 | 51.1 PK | 78.2 | -27.1 | 1.24 H | 303 | 44.20 | 6.90 |
| 4 | #5852.10 | 68.9 PK | 78.2 | -9.3 | 1.38 H | 302 | 61.90 | 7.00 |
| 5 | #5860.10 | 66.8 PK | 74.0 | -7.2 | 1.54 H | 305 | 59.80 | 7.00 |
| 6 | #5860.10 | 49.2 AV | 54.0 | -4.8 | 1.54 H | 305 | 42.20 | 7.00 |
| 7 | 11550.00 | 58.6 PK | 74.0 | -15.4 | 1.19 H | 114 | 40.20 | 18.40 |
| 8 | 11550.00 | 47.0 AV | 54.0 | -7.0 | 1.19 H | 114 | 28.60 | 18.40 |

ANTENNA POLARITY & TEST DISTANCE: VERTICAL AT 3 M

| NO. | FREQ. (MHz) | EMISSION LEVEL (dBuV/m) | LIMIT (dBuV/m) | MARGIN (dB) | ANTENNA HEIGHT (m) | TABLE ANGLE (Degree) | RAW VALUE (dBuV) | CORRECTION FACTOR (dB/m) |
|-----|----------------|-------------------------------|-------------------|----------------|--------------------------|----------------------------|------------------------|--------------------------------|
| 1 | *5795.00 | 108.0 PK | | | 1.72 V | 301 | 67.50 | 40.50 |
| 2 | *5795.00 | 98.5 AV | | | 1.72 V | 301 | 58.00 | 40.50 |
| 3 | #5850.00 | 54.4 PK | 78.2 | -23.8 | 1.55 V | 265 | 47.50 | 6.90 |
| 4 | #5852.10 | 70.8 PK | 78.2 | -7.4 | 1.55 V | 269 | 63.80 | 7.00 |
| 5 | #5860.10 | 69.3 PK | 74.0 | -4.7 | 1.55 V | 268 | 62.30 | 7.00 |
| 6 | #5860.10 | 52.2 AV | 54.0 | -1.8 | 1.55 V | 268 | 45.20 | 7.00 |
| 7 | 11550.00 | 58.4 PK | 74.0 | -15.6 | 1.57 V | 220 | 40.00 | 18.40 |
| 8 | 11550.00 | 47.0 AV | 54.0 | -7.0 | 1.57 V | 220 | 28.60 | 18.40 |

Remarks:

1. Emission Level(dBuV/m) = Raw Value(dBuV) + Correction Factor(dB/m)
2. Correction Factor(dB/m) = Antenna Factor(dB/m) + Cable Factor(dB)
3. The other emission levels were very low against the limit.
4. Margin value = Emission Level – Limit value
5. " * ": Fundamental frequency.
6. " # ": The radiated frequency is out of the restricted band.

802.11a

| | | | |
|-----------------|---------------|----------------------|---------------------------|
| CHANNEL | TX Channel 36 | DETECTOR FUNCTION | Peak (PK) Average (AV) |
| FREQUENCY RANGE | 1GHz ~ 40GHz | | |
| TEST MODE | C | | |

ANTENNA POLARITY & TEST DISTANCE: HORIZONTAL AT 3 M

| NO. | FREQ. (MHz) | EMISSION LEVEL (dBuV/m) | LIMIT (dBuV/m) | MARGIN (dB) | ANTENNA HEIGHT (m) | TABLE ANGLE (Degree) | RAW VALUE (dBuV) | CORRECTION FACTOR (dB/m) |
|-----|----------------|-------------------------------|-------------------|----------------|--------------------------|----------------------------|------------------------|--------------------------------|
| 1 | 5150.00 | 64.2 PK | 74.0 | -9.8 | 1.51 H | 282 | 58.20 | 6.00 |
| 2 | 5150.00 | 48.8 AV | 54.0 | -5.2 | 1.51 H | 282 | 42.80 | 6.00 |
| 3 | *5180.00 | 108.9 PK | | | 1.77 H | 3 | 69.40 | 39.50 |
| 4 | *5180.00 | 99.0 AV | | | 1.77 H | 3 | 59.50 | 39.50 |
| 5 | #10360.00 | 62.8 PK | 74.0 | -11.2 | 1.00 H | 59 | 44.40 | 18.40 |
| 6 | #10360.00 | 50.7 AV | 54.0 | -3.3 | 1.00 H | 59 | 32.30 | 18.40 |

ANTENNA POLARITY & TEST DISTANCE: VERTICAL AT 3 M

| NO. | FREQ. (MHz) | EMISSION LEVEL (dBuV/m) | LIMIT (dBuV/m) | MARGIN (dB) | ANTENNA HEIGHT (m) | TABLE ANGLE (Degree) | RAW VALUE (dBuV) | CORRECTION FACTOR (dB/m) |
|-----|----------------|-------------------------------|-------------------|----------------|--------------------------|----------------------------|------------------------|--------------------------------|
| 1 | 5150.00 | 69.8 PK | 74.0 | -4.2 | 1.15 V | 185 | 63.80 | 6.00 |
| 2 | 5150.00 | 52.2 AV | 54.0 | -1.8 | 1.15 V | 185 | 46.20 | 6.00 |
| 3 | *5180.00 | 114.9 PK | | | 2.01 V | 36 | 75.40 | 39.50 |
| 4 | *5180.00 | 104.5 AV | | | 2.01 V | 36 | 65.00 | 39.50 |
| 5 | #10360.00 | 65.6 PK | 74.0 | -8.4 | 1.00 V | 16 | 47.20 | 18.40 |
| 6 | #10360.00 | 52.7 AV | 54.0 | -1.3 | 1.00 V | 16 | 34.30 | 18.40 |

Remarks:

1. Emission Level(dBuV/m) = Raw Value(dBuV) + Correction Factor(dB/m)
2. Correction Factor(dB/m) = Antenna Factor(dB/m) + Cable Factor(dB)
3. The other emission levels were very low against the limit.
4. Margin value = Emission Level – Limit value
5. " * ": Fundamental frequency.
6. " # ": The radiated frequency is out of the restricted band.



| | | | |
|-----------------|---------------|-------------------|--------------|
| CHANNEL | TX Channel 40 | DETECTOR FUNCTION | Peak (PK) |
| FREQUENCY RANGE | 1GHz ~ 40GHz | | Average (AV) |
| TEST MODE | C | | |

ANTENNA POLARITY & TEST DISTANCE: HORIZONTAL AT 3 M

| NO. | FREQ. (MHz) | EMISSION LEVEL (dBuV/m) | LIMIT (dBuV/m) | MARGIN (dB) | ANTENNA HEIGHT (m) | TABLE ANGLE (Degree) | RAW VALUE (dBuV) | CORRECTION FACTOR (dB/m) |
|-----|-------------|-------------------------|----------------|-------------|--------------------|----------------------|------------------|--------------------------|
| 1 | *5200.00 | 110.4 PK | | | 1.59 H | 6 | 70.80 | 39.60 |
| 2 | *5200.00 | 100.3 AV | | | 1.59 H | 6 | 60.70 | 39.60 |
| 3 | #10400.00 | 62.1 PK | 68.2 | -6.1 | 1.02 H | 60 | 43.60 | 18.50 |

ANTENNA POLARITY & TEST DISTANCE: VERTICAL AT 3 M

| NO. | FREQ. (MHz) | EMISSION LEVEL (dBuV/m) | LIMIT (dBuV/m) | MARGIN (dB) | ANTENNA HEIGHT (m) | TABLE ANGLE (Degree) | RAW VALUE (dBuV) | CORRECTION FACTOR (dB/m) |
|-----|-------------|-------------------------|----------------|-------------|--------------------|----------------------|------------------|--------------------------|
| 1 | *5200.00 | 115.4 PK | | | 1.90 V | 35 | 75.80 | 39.60 |
| 2 | *5200.00 | 105.0 AV | | | 1.90 V | 35 | 65.40 | 39.60 |
| 3 | #10400.00 | 67.0 PK | 68.2 | -1.2 | 1.00 V | 15 | 48.50 | 18.50 |

Remarks:

1. Emission Level(dBuV/m) = Raw Value(dBuV) + Correction Factor(dB/m)
2. Correction Factor(dB/m) = Antenna Factor(dB/m) + Cable Factor(dB)
3. The other emission levels were very low against the limit.
4. Margin value = Emission Level – Limit value
5. " * ": Fundamental frequency.
6. " # ": The radiated frequency is out of the restricted band.

| | | | |
|-----------------|---------------|----------------------|--------------|
| CHANNEL | TX Channel 48 | DETECTOR FUNCTION | Peak (PK) |
| FREQUENCY RANGE | 1GHz ~ 40GHz | | Average (AV) |
| TEST MODE | C | | |

ANTENNA POLARITY & TEST DISTANCE: HORIZONTAL AT 3 M

| NO. | FREQ. (MHz) | EMISSION LEVEL (dBuV/m) | LIMIT (dBuV/m) | MARGIN (dB) | ANTENNA HEIGHT (m) | TABLE ANGLE (Degree) | RAW VALUE (dBuV) | CORRECTION FACTOR (dB/m) |
|-----|----------------|-------------------------------|-------------------|----------------|--------------------------|----------------------------|------------------------|--------------------------------|
| 1 | *5240.00 | 112.4 PK | | | 1.61 H | 4 | 72.80 | 39.60 |
| 2 | *5240.00 | 102.4 AV | | | 1.61 H | 4 | 62.80 | 39.60 |
| 3 | 5400.00 | 57.2 PK | 74.0 | -16.8 | 1.28 H | 340 | 50.90 | 6.30 |
| 4 | 5400.00 | 44.5 AV | 54.0 | -9.5 | 1.28 H | 340 | 38.20 | 6.30 |
| 5 | #10480.00 | 62.6 PK | 74.0 | -11.4 | 1.06 H | 136 | 43.60 | 19.00 |
| 6 | #10480.00 | 49.6 AV | 54.0 | -4.4 | 1.06 H | 136 | 30.60 | 19.00 |
| 7 | 15720.00 | 62.3 PK | 74.0 | -11.7 | 1.18 H | 321 | 43.80 | 18.50 |
| 8 | 15720.00 | 50.1 AV | 54.0 | -3.9 | 1.18 H | 321 | 31.60 | 18.50 |

ANTENNA POLARITY & TEST DISTANCE: VERTICAL AT 3 M

| NO. | FREQ. (MHz) | EMISSION LEVEL (dBuV/m) | LIMIT (dBuV/m) | MARGIN (dB) | ANTENNA HEIGHT (m) | TABLE ANGLE (Degree) | RAW VALUE (dBuV) | CORRECTION FACTOR (dB/m) |
|-----|----------------|-------------------------------|-------------------|----------------|--------------------------|----------------------------|------------------------|--------------------------------|
| 1 | *5240.00 | 116.7 PK | | | 1.99 V | 185 | 77.10 | 39.60 |
| 2 | *5240.00 | 106.7 AV | | | 1.99 V | 185 | 67.10 | 39.60 |
| 3 | 5400.00 | 57.9 PK | 74.0 | -16.1 | 1.97 V | 49 | 51.60 | 6.30 |
| 4 | 5400.00 | 46.8 AV | 54.0 | -7.2 | 1.97 V | 49 | 40.50 | 6.30 |
| 5 | #10480.00 | 68.8 PK | 74.0 | -5.2 | 1.06 V | 13 | 49.80 | 19.00 |
| 6 | #10480.00 | 52.7 AV | 54.0 | -1.3 | 1.06 V | 13 | 33.70 | 19.00 |
| 7 | 15720.00 | 63.3 PK | 74.0 | -10.7 | 2.27 V | 60 | 44.80 | 18.50 |
| 8 | 15720.00 | 50.8 AV | 54.0 | -3.2 | 2.27 V | 60 | 32.30 | 18.50 |

Remarks:

1. Emission Level(dBuV/m) = Raw Value(dBuV) + Correction Factor(dB/m)
2. Correction Factor(dB/m) = Antenna Factor(dB/m) + Cable Factor(dB)
3. The other emission levels were very low against the limit.
4. Margin value = Emission Level – Limit value
5. " * ": Fundamental frequency.
6. " # ": The radiated frequency is out of the restricted band.



| | | | |
|-----------------|----------------|----------------------|--------------|
| CHANNEL | TX Channel 149 | DETECTOR FUNCTION | Peak (PK) |
| FREQUENCY RANGE | 1GHz ~ 40GHz | | Average (AV) |
| TEST MODE | C | | |

ANTENNA POLARITY & TEST DISTANCE: HORIZONTAL AT 3 M

| NO. | FREQ. (MHz) | EMISSION LEVEL (dBuV/m) | LIMIT (dBuV/m) | MARGIN (dB) | ANTENNA HEIGHT (m) | TABLE ANGLE (Degree) | RAW VALUE (dBuV) | CORRECTION FACTOR (dB/m) |
|-----|-------------|-------------------------|----------------|-------------|--------------------|----------------------|------------------|--------------------------|
| 1 | #5714.90 | 59.1 PK | 74.0 | -14.9 | 1.72 H | 177 | 52.30 | 6.80 |
| 2 | #5714.90 | 45.6 AV | 54.0 | -8.4 | 1.72 H | 177 | 38.80 | 6.80 |
| 3 | #5722.90 | 67.1 PK | 78.2 | -11.1 | 1.24 H | 140 | 60.30 | 6.80 |
| 4 | #5725.00 | 52.3 PK | 78.2 | -25.9 | 1.66 H | 168 | 45.50 | 6.80 |
| 5 | *5745.00 | 101.6 PK | | | 1.78 H | 170 | 61.20 | 40.40 |
| 6 | *5745.00 | 91.5 AV | | | 1.78 H | 170 | 51.10 | 40.40 |
| 7 | 11490.00 | 57.5 PK | 74.0 | -16.5 | 1.15 H | 241 | 39.10 | 18.40 |
| 8 | 11490.00 | 45.5 AV | 54.0 | -8.5 | 1.15 H | 241 | 27.10 | 18.40 |

ANTENNA POLARITY & TEST DISTANCE: VERTICAL AT 3 M

| NO. | FREQ. (MHz) | EMISSION LEVEL (dBuV/m) | LIMIT (dBuV/m) | MARGIN (dB) | ANTENNA HEIGHT (m) | TABLE ANGLE (Degree) | RAW VALUE (dBuV) | CORRECTION FACTOR (dB/m) |
|-----|-------------|-------------------------|----------------|-------------|--------------------|----------------------|------------------|--------------------------|
| 1 | #5714.90 | 63.0 PK | 74.0 | -11.0 | 1.62 V | 350 | 56.20 | 6.80 |
| 2 | #5714.90 | 46.6 AV | 54.0 | -7.4 | 1.62 V | 350 | 39.80 | 6.80 |
| 3 | #5722.90 | 76.5 PK | 78.2 | -1.7 | 1.80 V | 189 | 69.70 | 6.80 |
| 4 | #5725.00 | 60.2 PK | 78.2 | -18.0 | 1.63 V | 119 | 53.40 | 6.80 |
| 5 | *5745.00 | 106.6 PK | | | 1.45 V | 354 | 66.20 | 40.40 |
| 6 | *5745.00 | 96.7 AV | | | 1.45 V | 354 | 56.30 | 40.40 |
| 7 | 11490.00 | 60.1 PK | 74.0 | -13.9 | 1.23 V | 157 | 41.70 | 18.40 |
| 8 | 11490.00 | 48.0 AV | 54.0 | -6.0 | 1.23 V | 157 | 29.60 | 18.40 |

Remarks:

1. Emission Level(dBuV/m) = Raw Value(dBuV) + Correction Factor(dB/m)
2. Correction Factor(dB/m) = Antenna Factor(dB/m) + Cable Factor(dB)
3. The other emission levels were very low against the limit.
4. Margin value = Emission Level – Limit value
5. " * ": Fundamental frequency.
6. " # ": The radiated frequency is out of the restricted band.

| | | | |
|-----------------|----------------|----------------------|--------------|
| CHANNEL | TX Channel 157 | DETECTOR FUNCTION | Peak (PK) |
| FREQUENCY RANGE | 1GHz ~ 40GHz | | Average (AV) |
| TEST MODE | C | | |

ANTENNA POLARITY & TEST DISTANCE: HORIZONTAL AT 3 M

| NO. | FREQ. (MHz) | EMISSION LEVEL (dBuV/m) | LIMIT (dBuV/m) | MARGIN (dB) | ANTENNA HEIGHT (m) | TABLE ANGLE (Degree) | RAW VALUE (dBuV) | CORRECTION FACTOR (dB/m) |
|-----|----------------|-------------------------------|-------------------|----------------|--------------------------|----------------------------|------------------------|--------------------------------|
| 1 | *5785.00 | 105.8 PK | | | 2.12 H | 171 | 65.30 | 40.50 |
| 2 | *5785.00 | 95.7 AV | | | 2.12 H | 171 | 55.20 | 40.50 |
| 3 | 11570.00 | 63.3 PK | 74.0 | -10.7 | 1.00 H | 134 | 44.90 | 18.40 |
| 4 | 11570.00 | 50.8 AV | 54.0 | -3.2 | 1.00 H | 134 | 32.40 | 18.40 |

ANTENNA POLARITY & TEST DISTANCE: VERTICAL AT 3 M

| NO. | FREQ. (MHz) | EMISSION LEVEL (dBuV/m) | LIMIT (dBuV/m) | MARGIN (dB) | ANTENNA HEIGHT (m) | TABLE ANGLE (Degree) | RAW VALUE (dBuV) | CORRECTION FACTOR (dB/m) |
|-----|----------------|-------------------------------|-------------------|----------------|--------------------------|----------------------------|------------------------|--------------------------------|
| 1 | *5785.00 | 113.1 PK | | | 1.71 V | 94 | 72.60 | 40.50 |
| 2 | *5785.00 | 102.9 AV | | | 1.71 V | 94 | 62.40 | 40.50 |
| 3 | 11570.00 | 66.7 PK | 74.0 | -7.3 | 1.00 V | 164 | 48.30 | 18.40 |
| 4 | 11570.00 | 52.9 AV | 54.0 | -1.1 | 1.00 V | 164 | 34.50 | 18.40 |

Remarks:

1. Emission Level(dBuV/m) = Raw Value(dBuV) + Correction Factor(dB/m)
2. Correction Factor(dB/m) = Antenna Factor(dB/m) + Cable Factor(dB)
3. The other emission levels were very low against the limit.
4. Margin value = Emission Level – Limit value
5. " * ": Fundamental frequency.

| | | | |
|-----------------|----------------|----------------------|--------------|
| CHANNEL | TX Channel 165 | DETECTOR FUNCTION | Peak (PK) |
| FREQUENCY RANGE | 1GHz ~ 40GHz | | Average (AV) |
| TEST MODE | C | | |

ANTENNA POLARITY & TEST DISTANCE: HORIZONTAL AT 3 M

| NO. | FREQ. (MHz) | EMISSION LEVEL (dBuV/m) | LIMIT (dBuV/m) | MARGIN (dB) | ANTENNA HEIGHT (m) | TABLE ANGLE (Degree) | RAW VALUE (dBuV) | CORRECTION FACTOR (dB/m) |
|-----|----------------|-------------------------------|-------------------|----------------|--------------------------|----------------------------|------------------------|--------------------------------|
| 1 | *5825.00 | 103.0 PK | | | 1.64 H | 170 | 62.50 | 40.50 |
| 2 | *5825.00 | 92.7 AV | | | 1.64 H | 170 | 52.20 | 40.50 |
| 3 | #5850.00 | 47.0 PK | 78.2 | -31.2 | 1.48 H | 180 | 40.10 | 6.90 |
| 4 | #5852.10 | 64.9 PK | 78.2 | -13.3 | 1.65 H | 169 | 57.90 | 7.00 |
| 5 | #5860.10 | 60.0 PK | 74.0 | -14.0 | 1.77 H | 171 | 53.00 | 7.00 |
| 6 | #5860.10 | 45.7 AV | 54.0 | -8.3 | 1.77 H | 171 | 38.70 | 7.00 |
| 7 | 11650.00 | 58.6 PK | 74.0 | -15.4 | 1.14 H | 42 | 39.70 | 18.90 |
| 8 | 11650.00 | 46.9 AV | 54.0 | -7.1 | 1.14 H | 42 | 28.00 | 18.90 |

ANTENNA POLARITY & TEST DISTANCE: VERTICAL AT 3 M

| NO. | FREQ. (MHz) | EMISSION LEVEL (dBuV/m) | LIMIT (dBuV/m) | MARGIN (dB) | ANTENNA HEIGHT (m) | TABLE ANGLE (Degree) | RAW VALUE (dBuV) | CORRECTION FACTOR (dB/m) |
|-----|----------------|-------------------------------|-------------------|----------------|--------------------------|----------------------------|------------------------|--------------------------------|
| 1 | *5825.00 | 111.1 PK | | | 1.85 V | 96 | 70.60 | 40.50 |
| 2 | *5825.00 | 100.8 AV | | | 1.85 V | 96 | 60.30 | 40.50 |
| 3 | #5850.00 | 59.0 PK | 78.2 | -19.2 | 2.04 V | 129 | 52.10 | 6.90 |
| 4 | #5852.10 | 76.5 PK | 78.2 | -1.7 | 1.94 V | 187 | 69.50 | 7.00 |
| 5 | #5860.10 | 69.2 PK | 74.0 | -4.8 | 2.01 V | 126 | 62.20 | 7.00 |
| 6 | #5860.10 | 51.7 AV | 54.0 | -2.3 | 2.01 V | 126 | 44.70 | 7.00 |
| 7 | 11650.00 | 61.2 PK | 74.0 | -12.8 | 2.00 V | 216 | 42.30 | 18.90 |
| 8 | 11650.00 | 49.2 AV | 54.0 | -4.8 | 2.00 V | 216 | 30.30 | 18.90 |

Remarks:

1. Emission Level(dBuV/m) = Raw Value(dBuV) + Correction Factor(dB/m)
2. Correction Factor(dB/m) = Antenna Factor(dB/m) + Cable Factor(dB)
3. The other emission levels were very low against the limit.
4. Margin value = Emission Level – Limit value
5. " * ": Fundamental frequency.
6. " # ": The radiated frequency is out of the restricted band.

802.11n (HT20)

| | | | |
|-----------------|---------------|----------------------|---------------------------|
| CHANNEL | TX Channel 36 | DETECTOR FUNCTION | Peak (PK) Average (AV) |
| FREQUENCY RANGE | 1GHz ~ 40GHz | | |
| TEST MODE | C | | |

ANTENNA POLARITY & TEST DISTANCE: HORIZONTAL AT 3 M

| NO. | FREQ. (MHz) | EMISSION LEVEL (dBuV/m) | LIMIT (dBuV/m) | MARGIN (dB) | ANTENNA HEIGHT (m) | TABLE ANGLE (Degree) | RAW VALUE (dBuV) | CORRECTION FACTOR (dB/m) |
|-----|----------------|-------------------------------|-------------------|----------------|--------------------------|----------------------------|------------------------|--------------------------------|
| 1 | 5150.00 | 67.9 PK | 74.0 | -6.1 | 1.42 H | 3 | 61.90 | 6.00 |
| 2 | 5150.00 | 51.4 AV | 54.0 | -2.6 | 1.42 H | 3 | 45.40 | 6.00 |
| 3 | *5180.00 | 108.4 PK | | | 1.77 H | 4 | 68.90 | 39.50 |
| 4 | *5180.00 | 98.2 AV | | | 1.77 H | 4 | 58.70 | 39.50 |
| 5 | #10360.00 | 62.9 PK | 74.0 | -11.1 | 1.00 H | 60 | 44.50 | 18.40 |
| 6 | #10360.00 | 49.7 AV | 54.0 | -4.3 | 1.00 H | 60 | 31.30 | 18.40 |

ANTENNA POLARITY & TEST DISTANCE: VERTICAL AT 3 M

| NO. | FREQ. (MHz) | EMISSION LEVEL (dBuV/m) | LIMIT (dBuV/m) | MARGIN (dB) | ANTENNA HEIGHT (m) | TABLE ANGLE (Degree) | RAW VALUE (dBuV) | CORRECTION FACTOR (dB/m) |
|----------|------------------|-------------------------------|-------------------|----------------|--------------------------|----------------------------|------------------------|--------------------------------|
| 1 | 5150.00 | 67.8 PK | 74.0 | -6.2 | 1.01 V | 193 | 61.80 | 6.00 |
| 2 | 5150.00 | 52.2 AV | 54.0 | -1.8 | 1.01 V | 193 | 46.20 | 6.00 |
| 3 | *5180.00 | 115.2 PK | | | 2.00 V | 36 | 75.70 | 39.50 |
| 4 | *5180.00 | 105.2 AV | | | 2.00 V | 36 | 65.70 | 39.50 |
| 5 | #10360.00 | 67.0 PK | 74.0 | -7.0 | 2.12 V | 15 | 48.60 | 18.40 |
| 6 | #10360.00 | 53.0 AV | 54.0 | -1.0 | 2.12 V | 15 | 34.60 | 18.40 |

Remarks:

1. Emission Level(dBuV/m) = Raw Value(dBuV) + Correction Factor(dB/m)
2. Correction Factor(dB/m) = Antenna Factor(dB/m) + Cable Factor(dB)
3. The other emission levels were very low against the limit.
4. Margin value = Emission Level – Limit value
5. " * ": Fundamental frequency.
6. " # ": The radiated frequency is out of the restricted band.



| | | | |
|-----------------|---------------|-------------------|--------------|
| CHANNEL | TX Channel 40 | DETECTOR FUNCTION | Peak (PK) |
| FREQUENCY RANGE | 1GHz ~ 40GHz | | Average (AV) |
| TEST MODE | C | | |

ANTENNA POLARITY & TEST DISTANCE: HORIZONTAL AT 3 M

| NO. | FREQ. (MHz) | EMISSION LEVEL (dBuV/m) | LIMIT (dBuV/m) | MARGIN (dB) | ANTENNA HEIGHT (m) | TABLE ANGLE (Degree) | RAW VALUE (dBuV) | CORRECTION FACTOR (dB/m) |
|-----|-------------|-------------------------|----------------|-------------|--------------------|----------------------|------------------|--------------------------|
| 1 | *5200.00 | 109.5 PK | | | 1.73 H | 4 | 69.90 | 39.60 |
| 2 | *5200.00 | 99.5 AV | | | 1.73 H | 4 | 59.90 | 39.60 |
| 3 | #10400.00 | 62.1 PK | 68.2 | -6.1 | 1.12 H | 50 | 43.60 | 18.50 |

ANTENNA POLARITY & TEST DISTANCE: VERTICAL AT 3 M

| NO. | FREQ. (MHz) | EMISSION LEVEL (dBuV/m) | LIMIT (dBuV/m) | MARGIN (dB) | ANTENNA HEIGHT (m) | TABLE ANGLE (Degree) | RAW VALUE (dBuV) | CORRECTION FACTOR (dB/m) |
|-----|-------------|-------------------------|----------------|-------------|--------------------|----------------------|------------------|--------------------------|
| 1 | *5200.00 | 114.1 PK | | | 1.68 V | 185 | 74.50 | 39.60 |
| 2 | *5200.00 | 104.1 AV | | | 1.68 V | 185 | 64.50 | 39.60 |
| 3 | #10400.00 | 67.1 PK | 68.2 | -1.1 | 1.00 V | 16 | 48.60 | 18.50 |

Remarks:

1. Emission Level(dBuV/m) = Raw Value(dBuV) + Correction Factor(dB/m)
2. Correction Factor(dB/m) = Antenna Factor(dB/m) + Cable Factor(dB)
3. The other emission levels were very low against the limit.
4. Margin value = Emission Level – Limit value
5. " * ": Fundamental frequency.
6. " # ": The radiated frequency is out of the restricted band.

| | | | |
|-----------------|---------------|----------------------|--------------|
| CHANNEL | TX Channel 48 | DETECTOR FUNCTION | Peak (PK) |
| FREQUENCY RANGE | 1GHz ~ 40GHz | | Average (AV) |
| TEST MODE | C | | |

ANTENNA POLARITY & TEST DISTANCE: HORIZONTAL AT 3 M

| NO. | FREQ. (MHz) | EMISSION LEVEL (dBuV/m) | LIMIT (dBuV/m) | MARGIN (dB) | ANTENNA HEIGHT (m) | TABLE ANGLE (Degree) | RAW VALUE (dBuV) | CORRECTION FACTOR (dB/m) |
|-----|----------------|-------------------------------|-------------------|----------------|--------------------------|----------------------------|------------------------|--------------------------------|
| 1 | *5240.00 | 111.8 PK | | | 1.49 H | 4 | 72.20 | 39.60 |
| 2 | *5240.00 | 101.7 AV | | | 1.49 H | 4 | 62.10 | 39.60 |
| 3 | 5400.00 | 57.4 PK | 74.0 | -16.6 | 1.29 H | 206 | 51.10 | 6.30 |
| 4 | 5400.00 | 44.7 AV | 54.0 | -9.3 | 1.29 H | 206 | 38.40 | 6.30 |
| 5 | #10480.00 | 62.6 PK | 74.0 | -11.4 | 1.02 H | 68 | 43.60 | 19.00 |
| 6 | #10480.00 | 49.2 AV | 54.0 | -4.8 | 1.02 H | 68 | 30.20 | 19.00 |
| 7 | 15720.00 | 62.8 PK | 74.0 | -11.2 | 1.53 H | 129 | 44.30 | 18.50 |
| 8 | 15720.00 | 50.1 AV | 54.0 | -3.9 | 1.53 H | 129 | 31.60 | 18.50 |

ANTENNA POLARITY & TEST DISTANCE: VERTICAL AT 3 M

| NO. | FREQ. (MHz) | EMISSION LEVEL (dBuV/m) | LIMIT (dBuV/m) | MARGIN (dB) | ANTENNA HEIGHT (m) | TABLE ANGLE (Degree) | RAW VALUE (dBuV) | CORRECTION FACTOR (dB/m) |
|-----|----------------|-------------------------------|-------------------|----------------|--------------------------|----------------------------|------------------------|--------------------------------|
| 1 | *5240.00 | 116.6 PK | | | 2.11 V | 185 | 77.00 | 39.60 |
| 2 | *5240.00 | 106.0 AV | | | 2.11 V | 185 | 66.40 | 39.60 |
| 3 | 5400.00 | 58.1 PK | 74.0 | -15.9 | 1.82 V | 51 | 51.80 | 6.30 |
| 4 | 5400.00 | 46.7 AV | 54.0 | -7.3 | 1.82 V | 51 | 40.40 | 6.30 |
| 5 | #10480.00 | 69.0 PK | 74.0 | -5.0 | 2.38 V | 15 | 50.00 | 19.00 |
| 6 | #10480.00 | 52.6 AV | 54.0 | -1.4 | 2.38 V | 15 | 33.60 | 19.00 |
| 7 | 15720.00 | 62.2 PK | 74.0 | -11.8 | 1.00 V | 302 | 43.70 | 18.50 |
| 8 | 15720.00 | 50.3 AV | 54.0 | -3.7 | 1.00 V | 302 | 31.80 | 18.50 |

Remarks:

1. Emission Level(dBuV/m) = Raw Value(dBuV) + Correction Factor(dB/m)
2. Correction Factor(dB/m) = Antenna Factor(dB/m) + Cable Factor(dB)
3. The other emission levels were very low against the limit.
4. Margin value = Emission Level – Limit value
5. " * ": Fundamental frequency.
6. " # ": The radiated frequency is out of the restricted band.

| | | | |
|-----------------|----------------|----------------------|--------------|
| CHANNEL | TX Channel 149 | DETECTOR FUNCTION | Peak (PK) |
| FREQUENCY RANGE | 1GHz ~ 40GHz | | Average (AV) |
| TEST MODE | C | | |

ANTENNA POLARITY & TEST DISTANCE: HORIZONTAL AT 3 M

| NO. | FREQ. (MHz) | EMISSION LEVEL (dBuV/m) | LIMIT (dBuV/m) | MARGIN (dB) | ANTENNA HEIGHT (m) | TABLE ANGLE (Degree) | RAW VALUE (dBuV) | CORRECTION FACTOR (dB/m) |
|-----|----------------|-------------------------------|-------------------|----------------|--------------------------|----------------------------|------------------------|--------------------------------|
| 1 | #5714.00 | 57.5 PK | 74.0 | -16.5 | 1.69 H | 169 | 50.70 | 6.80 |
| 2 | #5714.00 | 46.2 AV | 54.0 | -7.8 | 1.69 H | 169 | 39.40 | 6.80 |
| 3 | #5722.00 | 70.5 PK | 78.2 | -7.7 | 1.75 H | 170 | 63.70 | 6.80 |
| 4 | #5725.00 | 55.6 PK | 78.2 | -22.6 | 1.75 H | 170 | 48.80 | 6.80 |
| 5 | *5745.00 | 100.9 PK | | | 1.80 H | 170 | 60.50 | 40.40 |
| 6 | *5745.00 | 90.6 AV | | | 1.80 H | 170 | 50.20 | 40.40 |
| 7 | 11490.00 | 60.0 PK | 74.0 | -14.0 | 1.11 H | 244 | 41.60 | 18.40 |
| 8 | 11490.00 | 47.0 AV | 54.0 | -7.0 | 1.11 H | 244 | 28.60 | 18.40 |

ANTENNA POLARITY & TEST DISTANCE: VERTICAL AT 3 M

| NO. | FREQ. (MHz) | EMISSION LEVEL (dBuV/m) | LIMIT (dBuV/m) | MARGIN (dB) | ANTENNA HEIGHT (m) | TABLE ANGLE (Degree) | RAW VALUE (dBuV) | CORRECTION FACTOR (dB/m) |
|-----|----------------|-------------------------------|-------------------|----------------|--------------------------|----------------------------|------------------------|--------------------------------|
| 1 | #5700.00 | 59.9 PK | 74.0 | -14.1 | 1.88 V | 200 | 53.10 | 6.80 |
| 2 | #5700.00 | 47.7 AV | 54.0 | -6.3 | 1.88 V | 200 | 40.90 | 6.80 |
| 3 | #5722.00 | 76.8 PK | 78.2 | -1.4 | 1.93 V | 120 | 70.00 | 6.80 |
| 4 | #5725.00 | 63.3 PK | 78.2 | -14.9 | 1.93 V | 120 | 56.50 | 6.80 |
| 5 | *5745.00 | 108.8 PK | | | 1.72 V | 136 | 68.40 | 40.40 |
| 6 | *5745.00 | 99.0 AV | | | 1.72 V | 136 | 58.60 | 40.40 |
| 7 | 11490.00 | 60.8 PK | 74.0 | -13.2 | 1.27 V | 165 | 42.40 | 18.40 |
| 8 | 11490.00 | 47.7 AV | 54.0 | -6.3 | 1.27 V | 165 | 29.30 | 18.40 |

Remarks:

1. Emission Level(dBuV/m) = Raw Value(dBuV) + Correction Factor(dB/m)
2. Correction Factor(dB/m) = Antenna Factor(dB/m) + Cable Factor(dB)
3. The other emission levels were very low against the limit.
4. Margin value = Emission Level – Limit value
5. " * ": Fundamental frequency.
6. " # ": The radiated frequency is out of the restricted band.

| | | | |
|-----------------|----------------|-------------------|--------------|
| CHANNEL | TX Channel 157 | DETECTOR FUNCTION | Peak (PK) |
| FREQUENCY RANGE | 1GHz ~ 40GHz | | Average (AV) |
| TEST MODE | C | | |

ANTENNA POLARITY & TEST DISTANCE: HORIZONTAL AT 3 M

| NO. | FREQ. (MHz) | EMISSION LEVEL (dBuV/m) | LIMIT (dBuV/m) | MARGIN (dB) | ANTENNA HEIGHT (m) | TABLE ANGLE (Degree) | RAW VALUE (dBuV) | CORRECTION FACTOR (dB/m) |
|-----|-------------|-------------------------|----------------|-------------|--------------------|----------------------|------------------|--------------------------|
| 1 | *5785.00 | 105.4 PK | | | 2.01 H | 321 | 64.90 | 40.50 |
| 2 | *5785.00 | 94.6 AV | | | 2.01 H | 321 | 54.10 | 40.50 |
| 3 | 11570.00 | 64.0 PK | 74.0 | -10.0 | 1.00 H | 180 | 45.60 | 18.40 |
| 4 | 11570.00 | 51.1 AV | 54.0 | -2.9 | 1.00 H | 180 | 32.70 | 18.40 |

ANTENNA POLARITY & TEST DISTANCE: VERTICAL AT 3 M

| NO. | FREQ. (MHz) | EMISSION LEVEL (dBuV/m) | LIMIT (dBuV/m) | MARGIN (dB) | ANTENNA HEIGHT (m) | TABLE ANGLE (Degree) | RAW VALUE (dBuV) | CORRECTION FACTOR (dB/m) |
|----------|-----------------|-------------------------|----------------|-------------|--------------------|----------------------|------------------|--------------------------|
| 1 | *5785.00 | 113.2 PK | | | 1.75 V | 137 | 72.70 | 40.50 |
| 2 | *5785.00 | 103.7 AV | | | 1.75 V | 137 | 63.20 | 40.50 |
| 3 | 11570.00 | 69.4 PK | 74.0 | -4.6 | 1.90 V | 308 | 51.00 | 18.40 |
| 4 | 11570.00 | 53.0 AV | 54.0 | -1.0 | 1.90 V | 308 | 34.60 | 18.40 |

Remarks:

1. Emission Level(dBuV/m) = Raw Value(dBuV) + Correction Factor(dB/m)
2. Correction Factor(dB/m) = Antenna Factor(dB/m) + Cable Factor(dB)
3. The other emission levels were very low against the limit.
4. Margin value = Emission Level – Limit value
5. " * ": Fundamental frequency.
6. " # ": The radiated frequency is out of the restricted band.

| | | | |
|-----------------|----------------|----------------------|--------------|
| CHANNEL | TX Channel 165 | DETECTOR FUNCTION | Peak (PK) |
| FREQUENCY RANGE | 1GHz ~ 40GHz | | Average (AV) |
| TEST MODE | C | | |

ANTENNA POLARITY & TEST DISTANCE: HORIZONTAL AT 3 M

| NO. | FREQ. (MHz) | EMISSION LEVEL (dBuV/m) | LIMIT (dBuV/m) | MARGIN (dB) | ANTENNA HEIGHT (m) | TABLE ANGLE (Degree) | RAW VALUE (dBuV) | CORRECTION FACTOR (dB/m) |
|-----|----------------|-------------------------------|-------------------|----------------|--------------------------|----------------------------|------------------------|--------------------------------|
| 1 | *5825.00 | 104.0 PK | | | 2.12 H | 170 | 63.50 | 40.50 |
| 2 | *5825.00 | 93.9 AV | | | 2.12 H | 170 | 53.40 | 40.50 |
| 3 | #5850.00 | 57.6 PK | 78.2 | -20.6 | 2.12 H | 170 | 50.70 | 6.90 |
| 4 | #5853.00 | 64.7 PK | 78.2 | -13.5 | 2.12 H | 170 | 57.70 | 7.00 |
| 5 | #5861.00 | 60.5 PK | 74.0 | -13.5 | 1.76 H | 177 | 53.50 | 7.00 |
| 6 | #5861.00 | 48.9 AV | 54.0 | -5.1 | 1.76 H | 177 | 41.90 | 7.00 |
| 7 | 11650.00 | 60.7 PK | 74.0 | -13.3 | 1.20 H | 264 | 41.80 | 18.90 |
| 8 | 11650.00 | 47.9 AV | 54.0 | -6.1 | 1.20 H | 264 | 29.00 | 18.90 |

ANTENNA POLARITY & TEST DISTANCE: VERTICAL AT 3 M

| NO. | FREQ. (MHz) | EMISSION LEVEL (dBuV/m) | LIMIT (dBuV/m) | MARGIN (dB) | ANTENNA HEIGHT (m) | TABLE ANGLE (Degree) | RAW VALUE (dBuV) | CORRECTION FACTOR (dB/m) |
|-----|----------------|-------------------------------|-------------------|----------------|--------------------------|----------------------------|------------------------|--------------------------------|
| 1 | *5825.00 | 113.3 PK | | | 2.07 V | 307 | 72.80 | 40.50 |
| 2 | *5825.00 | 102.9 AV | | | 2.07 V | 307 | 62.40 | 40.50 |
| 3 | #5850.00 | 63.8 PK | 78.2 | -14.4 | 1.90 V | 311 | 56.90 | 6.90 |
| 4 | #5853.00 | 76.3 PK | 78.2 | -1.9 | 1.90 V | 311 | 69.30 | 7.00 |
| 5 | #5861.00 | 70.2 PK | 74.0 | -3.8 | 1.00 V | 94 | 63.20 | 7.00 |
| 6 | #5861.00 | 49.1 AV | 54.0 | -4.9 | 1.00 V | 94 | 42.10 | 7.00 |
| 7 | 11650.00 | 62.2 PK | 74.0 | -11.8 | 2.01 V | 316 | 43.30 | 18.90 |
| 8 | 11650.00 | 49.9 AV | 54.0 | -4.1 | 2.01 V | 316 | 31.00 | 18.90 |

Remarks:

1. Emission Level(dBuV/m) = Raw Value(dBuV) + Correction Factor(dB/m)
2. Correction Factor(dB/m) = Antenna Factor(dB/m) + Cable Factor(dB)
3. The other emission levels were very low against the limit.
4. Margin value = Emission Level – Limit value
5. " * ": Fundamental frequency.
6. " # ": The radiated frequency is out of the restricted band.

802.11n (HT40)

| | | | |
|-----------------|---------------|----------------------|---------------------------|
| CHANNEL | TX Channel 38 | DETECTOR FUNCTION | Peak (PK) Average (AV) |
| FREQUENCY RANGE | 1GHz ~ 40GHz | | |
| TEST MODE | C | | |

ANTENNA POLARITY & TEST DISTANCE: HORIZONTAL AT 3 M

| NO. | FREQ. (MHz) | EMISSION LEVEL (dBuV/m) | LIMIT (dBuV/m) | MARGIN (dB) | ANTENNA HEIGHT (m) | TABLE ANGLE (Degree) | RAW VALUE (dBuV) | CORRECTION FACTOR (dB/m) |
|-----|----------------|-------------------------------|-------------------|----------------|--------------------------|----------------------------|------------------------|--------------------------------|
| 1 | 5150.00 | 65.3 PK | 74.0 | -8.7 | 1.34 H | 71 | 59.30 | 6.00 |
| 2 | 5150.00 | 51.4 AV | 54.0 | -2.6 | 1.34 H | 71 | 45.40 | 6.00 |
| 3 | *5190.00 | 100.7 PK | | | 1.64 H | 357 | 61.20 | 39.50 |
| 4 | *5190.00 | 91.0 AV | | | 1.64 H | 357 | 51.50 | 39.50 |
| 5 | #10380.00 | 59.5 PK | 74.0 | -14.5 | 1.22 H | 54 | 41.00 | 18.50 |
| 6 | #10380.00 | 48.0 AV | 54.0 | -6.0 | 1.22 H | 54 | 29.50 | 18.50 |

ANTENNA POLARITY & TEST DISTANCE: VERTICAL AT 3 M

| NO. | FREQ. (MHz) | EMISSION LEVEL (dBuV/m) | LIMIT (dBuV/m) | MARGIN (dB) | ANTENNA HEIGHT (m) | TABLE ANGLE (Degree) | RAW VALUE (dBuV) | CORRECTION FACTOR (dB/m) |
|-----|----------------|-------------------------------|-------------------|----------------|--------------------------|----------------------------|------------------------|--------------------------------|
| 1 | 5150.00 | 71.2 PK | 74.0 | -2.8 | 1.83 V | 57 | 65.20 | 6.00 |
| 2 | 5150.00 | 52.6 AV | 54.0 | -1.4 | 1.83 V | 57 | 46.60 | 6.00 |
| 3 | *5190.00 | 104.6 PK | | | 1.82 V | 67 | 65.10 | 39.50 |
| 4 | *5190.00 | 94.9 AV | | | 1.82 V | 67 | 55.40 | 39.50 |
| 5 | #10380.00 | 59.5 PK | 74.0 | -14.5 | 1.70 V | 35 | 41.00 | 18.50 |
| 6 | #10380.00 | 48.1 AV | 54.0 | -5.9 | 1.70 V | 35 | 29.60 | 18.50 |

Remarks:

1. Emission Level(dBuV/m) = Raw Value(dBuV) + Correction Factor(dB/m)
2. Correction Factor(dB/m) = Antenna Factor(dB/m) + Cable Factor(dB)
3. The other emission levels were very low against the limit.
4. Margin value = Emission Level – Limit value
5. " * ": Fundamental frequency.
6. " # ": The radiated frequency is out of the restricted band.

| | | | |
|-----------------|---------------|----------------------|--------------|
| CHANNEL | TX Channel 46 | DETECTOR FUNCTION | Peak (PK) |
| FREQUENCY RANGE | 1GHz ~ 40GHz | | Average (AV) |
| TEST MODE | C | | |

ANTENNA POLARITY & TEST DISTANCE: HORIZONTAL AT 3 M

| NO. | FREQ. (MHz) | EMISSION LEVEL (dBuV/m) | LIMIT (dBuV/m) | MARGIN (dB) | ANTENNA HEIGHT (m) | TABLE ANGLE (Degree) | RAW VALUE (dBuV) | CORRECTION FACTOR (dB/m) |
|-----|----------------|-------------------------------|-------------------|----------------|--------------------------|----------------------------|------------------------|--------------------------------|
| 1 | 5150.00 | 61.0 PK | 74.0 | -13.0 | 1.44 H | 282 | 55.00 | 6.00 |
| 2 | 5150.00 | 47.1 AV | 54.0 | -6.9 | 1.44 H | 282 | 41.10 | 6.00 |
| 3 | *5230.00 | 107.6 PK | | | 1.86 H | 358 | 68.00 | 39.60 |
| 4 | *5230.00 | 98.2 AV | | | 1.86 H | 358 | 58.60 | 39.60 |
| 5 | #10460.00 | 59.2 PK | 74.0 | -14.8 | 1.17 H | 257 | 40.30 | 18.90 |
| 6 | #10460.00 | 47.8 AV | 54.0 | -6.2 | 1.17 H | 257 | 28.90 | 18.90 |

ANTENNA POLARITY & TEST DISTANCE: VERTICAL AT 3 M

| NO. | FREQ. (MHz) | EMISSION LEVEL (dBuV/m) | LIMIT (dBuV/m) | MARGIN (dB) | ANTENNA HEIGHT (m) | TABLE ANGLE (Degree) | RAW VALUE (dBuV) | CORRECTION FACTOR (dB/m) |
|-----|----------------|-------------------------------|-------------------|----------------|--------------------------|----------------------------|------------------------|--------------------------------|
| 1 | 5150.00 | 69.0 PK | 74.0 | -5.0 | 1.80 V | 40 | 63.00 | 6.00 |
| 2 | 5150.00 | 52.4 AV | 54.0 | -1.6 | 1.80 V | 40 | 46.40 | 6.00 |
| 3 | *5230.00 | 110.5 PK | | | 2.10 V | 162 | 70.90 | 39.60 |
| 4 | *5230.00 | 101.2 AV | | | 2.10 V | 162 | 61.60 | 39.60 |
| 5 | #10460.00 | 62.4 PK | 74.0 | -11.6 | 2.25 V | 8 | 43.50 | 18.90 |
| 6 | #10460.00 | 50.3 AV | 54.0 | -3.7 | 2.25 V | 8 | 31.40 | 18.90 |

Remarks:

1. Emission Level(dBuV/m) = Raw Value(dBuV) + Correction Factor(dB/m)
2. Correction Factor(dB/m) = Antenna Factor(dB/m) + Cable Factor(dB)
3. The other emission levels were very low against the limit.
4. Margin value = Emission Level – Limit value
5. " * ": Fundamental frequency.
6. " # ": The radiated frequency is out of the restricted band.

| | | | |
|-----------------|----------------|----------------------|--------------|
| CHANNEL | TX Channel 151 | DETECTOR FUNCTION | Peak (PK) |
| FREQUENCY RANGE | 1GHz ~ 40GHz | | Average (AV) |
| TEST MODE | C | | |

ANTENNA POLARITY & TEST DISTANCE: HORIZONTAL AT 3 M

| NO. | FREQ. (MHz) | EMISSION LEVEL (dBuV/m) | LIMIT (dBuV/m) | MARGIN (dB) | ANTENNA HEIGHT (m) | TABLE ANGLE (Degree) | RAW VALUE (dBuV) | CORRECTION FACTOR (dB/m) |
|-----|----------------|-------------------------------|-------------------|----------------|--------------------------|----------------------------|------------------------|--------------------------------|
| 1 | #5714.00 | 59.9 PK | 74.0 | -14.1 | 1.99 H | 302 | 53.10 | 6.80 |
| 2 | #5714.00 | 48.8 AV | 54.0 | -5.2 | 1.99 H | 302 | 42.00 | 6.80 |
| 3 | #5722.00 | 65.1 PK | 78.2 | -13.1 | 1.86 H | 212 | 58.30 | 6.80 |
| 4 | #5725.00 | 51.9 PK | 78.2 | -26.3 | 1.83 H | 212 | 45.10 | 6.80 |
| 5 | *5755.00 | 95.1 PK | | | 2.09 H | 322 | 54.60 | 40.50 |
| 6 | *5755.00 | 85.4 AV | | | 2.09 H | 322 | 44.90 | 40.50 |
| 7 | 11510.00 | 60.1 PK | 74.0 | -13.9 | 1.22 H | 255 | 41.80 | 18.30 |
| 8 | 11510.00 | 47.1 AV | 54.0 | -6.9 | 1.22 H | 255 | 28.80 | 18.30 |

ANTENNA POLARITY & TEST DISTANCE: VERTICAL AT 3 M

| NO. | FREQ. (MHz) | EMISSION LEVEL (dBuV/m) | LIMIT (dBuV/m) | MARGIN (dB) | ANTENNA HEIGHT (m) | TABLE ANGLE (Degree) | RAW VALUE (dBuV) | CORRECTION FACTOR (dB/m) |
|-----|----------------|-------------------------------|-------------------|----------------|--------------------------|----------------------------|------------------------|--------------------------------|
| 1 | #5714.00 | 71.0 PK | 74.0 | -3.0 | 1.76 V | 315 | 64.20 | 6.80 |
| 2 | #5714.00 | 51.3 AV | 54.0 | -2.7 | 1.76 V | 315 | 44.50 | 6.80 |
| 3 | #5722.00 | 76.6 PK | 78.2 | -1.6 | 1.76 V | 308 | 69.80 | 6.80 |
| 4 | #5725.00 | 65.3 PK | 78.2 | -12.9 | 1.82 V | 192 | 58.50 | 6.80 |
| 5 | *5755.00 | 104.4 PK | | | 1.78 V | 309 | 63.90 | 40.50 |
| 6 | *5755.00 | 94.7 AV | | | 1.78 V | 309 | 54.20 | 40.50 |
| 7 | 11510.00 | 61.0 PK | 74.0 | -13.0 | 1.86 V | 208 | 42.70 | 18.30 |
| 8 | 11510.00 | 47.9 AV | 54.0 | -6.1 | 1.86 V | 208 | 29.60 | 18.30 |

Remarks:

1. Emission Level(dBuV/m) = Raw Value(dBuV) + Correction Factor(dB/m)
2. Correction Factor(dB/m) = Antenna Factor(dB/m) + Cable Factor(dB)
3. The other emission levels were very low against the limit.
4. Margin value = Emission Level – Limit value
5. " * ": Fundamental frequency.
6. " # ": The radiated frequency is out of the restricted band.



| | | | |
|-----------------|----------------|----------------------|--------------|
| CHANNEL | TX Channel 159 | DETECTOR FUNCTION | Peak (PK) |
| FREQUENCY RANGE | 1GHz ~ 40GHz | | Average (AV) |
| TEST MODE | C | | |

ANTENNA POLARITY & TEST DISTANCE: HORIZONTAL AT 3 M

| NO. | FREQ. (MHz) | EMISSION LEVEL (dBuV/m) | LIMIT (dBuV/m) | MARGIN (dB) | ANTENNA HEIGHT (m) | TABLE ANGLE (Degree) | RAW VALUE (dBuV) | CORRECTION FACTOR (dB/m) |
|-----|-------------|-------------------------|----------------|-------------|--------------------|----------------------|------------------|--------------------------|
| 1 | *5795.00 | 101.0 PK | | | 2.02 H | 321 | 60.50 | 40.50 |
| 2 | *5795.00 | 91.0 AV | | | 2.02 H | 321 | 50.50 | 40.50 |
| 3 | #5850.00 | 51.8 PK | 78.2 | -26.4 | 1.76 H | 188 | 44.90 | 6.90 |
| 4 | #5853.00 | 61.8 PK | 78.2 | -16.4 | 1.76 H | 188 | 54.80 | 7.00 |
| 5 | #5861.00 | 58.5 PK | 74.0 | -15.5 | 1.81 H | 314 | 51.50 | 7.00 |
| 6 | #5861.00 | 47.2 AV | 54.0 | -6.8 | 1.81 H | 314 | 40.20 | 7.00 |
| 7 | 11590.00 | 60.1 PK | 74.0 | -13.9 | 1.05 H | 189 | 41.60 | 18.50 |
| 8 | 11590.00 | 47.0 AV | 54.0 | -7.0 | 1.05 H | 189 | 28.50 | 18.50 |

ANTENNA POLARITY & TEST DISTANCE: VERTICAL AT 3 M

| NO. | FREQ. (MHz) | EMISSION LEVEL (dBuV/m) | LIMIT (dBuV/m) | MARGIN (dB) | ANTENNA HEIGHT (m) | TABLE ANGLE (Degree) | RAW VALUE (dBuV) | CORRECTION FACTOR (dB/m) |
|-----|-------------|-------------------------|----------------|-------------|--------------------|----------------------|------------------|--------------------------|
| 1 | *5795.00 | 108.6 PK | | | 1.80 V | 138 | 68.10 | 40.50 |
| 2 | *5795.00 | 98.4 AV | | | 1.80 V | 138 | 57.90 | 40.50 |
| 3 | #5850.00 | 63.0 PK | 78.2 | -15.2 | 1.79 V | 133 | 56.10 | 6.90 |
| 4 | #5853.00 | 73.4 PK | 78.2 | -4.8 | 1.79 V | 133 | 66.40 | 7.00 |
| 5 | #5861.00 | 71.8 PK | 74.0 | -2.2 | 1.87 V | 125 | 64.80 | 7.00 |
| 6 | #5861.00 | 52.4 AV | 54.0 | -1.6 | 1.87 V | 125 | 45.40 | 7.00 |
| 7 | 11590.00 | 61.2 PK | 74.0 | -12.8 | 1.80 V | 175 | 42.70 | 18.50 |
| 8 | 11590.00 | 48.2 AV | 54.0 | -5.8 | 1.80 V | 175 | 29.70 | 18.50 |

Remarks:

1. Emission Level(dBuV/m) = Raw Value(dBuV) + Correction Factor(dB/m)
2. Correction Factor(dB/m) = Antenna Factor(dB/m) + Cable Factor(dB)
3. The other emission levels were very low against the limit.
4. Margin value = Emission Level – Limit value
5. " * ": Fundamental frequency.
6. " # ": The radiated frequency is out of the restricted band.

Below 1GHz Data

802.11a

| | | | |
|-----------------|---------------|----------------------|-----------------|
| CHANNEL | TX Channel 36 | DETECTOR FUNCTION | Quasi-Peak (QP) |
| FREQUENCY RANGE | 30MHz ~ 1GHz | | |
| TEST MODE | A | | |

ANTENNA POLARITY & TEST DISTANCE: HORIZONTAL AT 3 M

| NO. | FREQ. (MHz) | EMISSION LEVEL (dBuV/m) | LIMIT (dBuV/m) | MARGIN (dB) | ANTENNA HEIGHT (m) | TABLE ANGLE (Degree) | RAW VALUE (dBuV) | CORRECTION FACTOR (dB/m) |
|-----|----------------|-------------------------------|-------------------|----------------|--------------------------|----------------------------|------------------------|--------------------------------|
| 1 | 88.23 | 33.3 QP | 43.5 | -10.2 | 1.99 H | 289 | 53.10 | -19.80 |
| 2 | 210.72 | 39.9 QP | 43.5 | -3.6 | 1.00 H | 181 | 56.60 | -16.70 |
| 3 | 282.02 | 43.4 QP | 46.0 | -2.6 | 1.00 H | 188 | 56.30 | -12.90 |
| 4 | 375.01 | 43.5 QP | 46.0 | -2.5 | 1.00 H | 243 | 54.40 | -10.90 |
| 5 | 624.85 | 44.0 QP | 46.0 | -2.0 | 1.49 H | 329 | 49.40 | -5.40 |
| 6 | 875.67 | 41.1 QP | 46.0 | -4.9 | 1.49 H | 289 | 42.00 | -0.90 |

ANTENNA POLARITY & TEST DISTANCE: VERTICAL AT 3 M

| NO. | FREQ. (MHz) | EMISSION LEVEL (dBuV/m) | LIMIT (dBuV/m) | MARGIN (dB) | ANTENNA HEIGHT (m) | TABLE ANGLE (Degree) | RAW VALUE (dBuV) | CORRECTION FACTOR (dB/m) |
|-----|----------------|-------------------------------|-------------------|----------------|--------------------------|----------------------------|------------------------|--------------------------------|
| 1 | 29.90 | 37.3 QP | 40.0 | -2.7 | 1.00 V | 233 | 53.40 | -16.10 |
| 2 | 51.19 | 35.6 QP | 40.0 | -4.4 | 1.00 V | 1 | 50.20 | -14.60 |
| 3 | 69.30 | 36.6 QP | 40.0 | -3.4 | 1.04 V | 55 | 52.60 | -16.00 |
| 4 | 282.66 | 44.2 QP | 46.0 | -1.8 | 1.00 V | 134 | 57.10 | -12.90 |
| 5 | 375.98 | 38.6 QP | 46.0 | -7.4 | 1.00 V | 189 | 49.50 | -10.90 |
| 6 | 624.85 | 43.0 QP | 46.0 | -3.0 | 1.00 V | 185 | 48.40 | -5.40 |

Remarks:

1. Emission Level(dBuV/m) = Raw Value(dBuV) + Correction Factor(dB/m)
2. Correction Factor(dB/m) = Antenna Factor(dB/m) + Cable Factor(dB)
3. The other emission levels were very low against the limit.
4. Margin value = Emission Level – Limit value



| | | | |
|-----------------|---------------|----------------------|-----------------|
| CHANNEL | TX Channel 36 | DETECTOR FUNCTION | Quasi-Peak (QP) |
| FREQUENCY RANGE | 30MHz ~ 1GHz | | |
| TEST MODE | B | | |

ANTENNA POLARITY & TEST DISTANCE: HORIZONTAL AT 3 M

| NO. | FREQ. (MHz) | EMISSION LEVEL (dBuV/m) | LIMIT (dBuV/m) | MARGIN (dB) | ANTENNA HEIGHT (m) | TABLE ANGLE (Degree) | RAW VALUE (dBuV) | CORRECTION FACTOR (dB/m) |
|-----|-------------|-------------------------|----------------|-------------|--------------------|----------------------|------------------|--------------------------|
| 1 | 47.40 | 33.4 QP | 40.0 | -6.6 | 1.99 H | 132 | 48.00 | -14.60 |
| 2 | 140.72 | 34.1 QP | 43.5 | -9.4 | 1.99 H | 282 | 48.70 | -14.60 |
| 3 | 210.72 | 39.8 QP | 43.5 | -3.7 | 1.50 H | 261 | 56.50 | -16.70 |
| 4 | 282.66 | 40.6 QP | 46.0 | -5.4 | 1.50 H | 141 | 53.50 | -12.90 |
| 5 | 624.85 | 43.5 QP | 46.0 | -2.5 | 1.00 H | 235 | 48.90 | -5.40 |
| 6 | 875.67 | 39.6 QP | 46.0 | -6.4 | 1.50 H | 288 | 40.50 | -0.90 |

ANTENNA POLARITY & TEST DISTANCE: VERTICAL AT 3 M

| NO. | FREQ. (MHz) | EMISSION LEVEL (dBuV/m) | LIMIT (dBuV/m) | MARGIN (dB) | ANTENNA HEIGHT (m) | TABLE ANGLE (Degree) | RAW VALUE (dBuV) | CORRECTION FACTOR (dB/m) |
|-----|-------------|-------------------------|----------------|-------------|--------------------|----------------------|------------------|--------------------------|
| 1 | 47.63 | 37.1 QP | 40.0 | -2.9 | 1.00 V | 351 | 51.70 | -14.60 |
| 2 | 64.90 | 34.6 QP | 40.0 | -5.4 | 1.00 V | 272 | 50.00 | -15.40 |
| 3 | 210.72 | 33.8 QP | 43.5 | -9.7 | 1.99 V | 241 | 50.50 | -16.70 |
| 4 | 282.66 | 41.5 QP | 46.0 | -4.5 | 1.49 V | 343 | 54.40 | -12.90 |
| 5 | 624.85 | 41.1 QP | 46.0 | -4.9 | 1.00 V | 142 | 46.50 | -5.40 |
| 6 | 875.67 | 38.6 QP | 46.0 | -7.4 | 1.49 V | 208 | 39.50 | -0.90 |

Remarks:

1. Emission Level(dBuV/m) = Raw Value(dBuV) + Correction Factor(dB/m)
2. Correction Factor(dB/m) = Antenna Factor(dB/m) + Cable Factor(dB)
3. The other emission levels were very low against the limit.
4. Margin value = Emission Level – Limit value

| | | | |
|-----------------|---------------|----------------------|-----------------|
| CHANNEL | TX Channel 36 | DETECTOR FUNCTION | Quasi-Peak (QP) |
| FREQUENCY RANGE | 30MHz ~ 1GHz | | |
| TEST MODE | C | | |

ANTENNA POLARITY & TEST DISTANCE: HORIZONTAL AT 3 M

| NO. | FREQ. (MHz) | EMISSION LEVEL (dBuV/m) | LIMIT (dBuV/m) | MARGIN (dB) | ANTENNA HEIGHT (m) | TABLE ANGLE (Degree) | RAW VALUE (dBuV) | CORRECTION FACTOR (dB/m) |
|-----|----------------|-------------------------------|-------------------|----------------|--------------------------|----------------------------|------------------------|--------------------------------|
| 1 | 125.17 | 35.0 QP | 43.5 | -8.5 | 1.00 H | 83 | 50.90 | -15.90 |
| 2 | 214.08 | 41.9 QP | 43.5 | -1.6 | 1.07 H | 224 | 58.60 | -16.70 |
| 3 | 374.04 | 39.3 QP | 46.0 | -6.7 | 1.00 H | 200 | 50.30 | -11.00 |
| 4 | 625.02 | 44.6 QP | 46.0 | -1.4 | 1.32 H | 112 | 50.00 | -5.40 |
| 5 | 751.23 | 38.9 QP | 46.0 | -7.1 | 1.00 H | 129 | 42.00 | -3.10 |
| 6 | 875.67 | 37.8 QP | 46.0 | -8.2 | 1.00 H | 111 | 38.70 | -0.90 |

ANTENNA POLARITY & TEST DISTANCE: VERTICAL AT 3 M

| NO. | FREQ. (MHz) | EMISSION LEVEL (dBuV/m) | LIMIT (dBuV/m) | MARGIN (dB) | ANTENNA HEIGHT (m) | TABLE ANGLE (Degree) | RAW VALUE (dBuV) | CORRECTION FACTOR (dB/m) |
|----------|----------------|-------------------------------|-------------------|----------------|--------------------------|----------------------------|------------------------|--------------------------------|
| 1 | 31.84 | 36.4 QP | 40.0 | -3.6 | 1.00 V | 47 | 52.50 | -16.10 |
| 2 | 59.06 | 36.2 QP | 40.0 | -3.8 | 1.00 V | 350 | 51.00 | -14.80 |
| 3 | 82.40 | 37.4 QP | 40.0 | -2.6 | 1.00 V | 275 | 56.50 | -19.10 |
| 4 | 212.66 | 35.4 QP | 43.5 | -8.1 | 1.00 V | 293 | 52.10 | -16.70 |
| 5 | 374.04 | 41.9 QP | 46.0 | -4.1 | 1.00 V | 175 | 52.90 | -11.00 |
| 6 | 625.02 | 45.0 QP | 46.0 | -1.0 | 1.00 V | 83 | 50.40 | -5.40 |

Remarks:

1. Emission Level(dBuV/m) = Raw Value(dBuV) + Correction Factor(dB/m)
2. Correction Factor(dB/m) = Antenna Factor(dB/m) + Cable Factor(dB)
3. The other emission levels were very low against the limit.
4. Margin value = Emission Level – Limit value

| | | | |
|-----------------|---------------|----------------------|-----------------|
| CHANNEL | TX Channel 36 | DETECTOR FUNCTION | Quasi-Peak (QP) |
| FREQUENCY RANGE | 30MHz ~ 1GHz | | |
| TEST MODE | D | | |

ANTENNA POLARITY & TEST DISTANCE: HORIZONTAL AT 3 M

| NO. | FREQ. (MHz) | EMISSION LEVEL (dBuV/m) | LIMIT (dBuV/m) | MARGIN (dB) | ANTENNA HEIGHT (m) | TABLE ANGLE (Degree) | RAW VALUE (dBuV) | CORRECTION FACTOR (dB/m) |
|-----|----------------|-------------------------------|-------------------|----------------|--------------------------|----------------------------|------------------------|--------------------------------|
| 1 | 45.45 | 34.9 QP | 40.0 | -5.1 | 2.00 H | 135 | 49.70 | -14.80 |
| 2 | 193.22 | 38.3 QP | 43.5 | -5.2 | 1.50 H | 168 | 54.60 | -16.30 |
| 3 | 206.56 | 40.7 QP | 43.5 | -2.8 | 1.05 H | 327 | 57.50 | -16.80 |
| 4 | 280.71 | 42.7 QP | 46.0 | -3.3 | 1.01 H | 31 | 55.60 | -12.90 |
| 5 | 624.85 | 40.2 QP | 46.0 | -5.8 | 1.01 H | 256 | 45.60 | -5.40 |
| 6 | 875.67 | 42.0 QP | 46.0 | -4.0 | 1.50 H | 241 | 42.90 | -0.90 |

ANTENNA POLARITY & TEST DISTANCE: VERTICAL AT 3 M

| NO. | FREQ. (MHz) | EMISSION LEVEL (dBuV/m) | LIMIT (dBuV/m) | MARGIN (dB) | ANTENNA HEIGHT (m) | TABLE ANGLE (Degree) | RAW VALUE (dBuV) | CORRECTION FACTOR (dB/m) |
|-----|----------------|-------------------------------|-------------------|----------------|--------------------------|----------------------------|------------------------|--------------------------------|
| 1 | 37.99 | 34.2 QP | 40.0 | -5.8 | 1.00 V | 14 | 49.50 | -15.30 |
| 2 | 47.88 | 38.6 QP | 40.0 | -1.4 | 1.06 V | 21 | 53.20 | -14.60 |
| 3 | 206.83 | 39.5 QP | 43.5 | -4.0 | 1.99 V | 219 | 56.30 | -16.80 |
| 4 | 375.98 | 33.8 QP | 46.0 | -12.2 | 1.00 V | 201 | 44.70 | -10.90 |
| 5 | 624.85 | 38.2 QP | 46.0 | -7.8 | 1.00 V | 190 | 43.60 | -5.40 |
| 6 | 875.67 | 39.3 QP | 46.0 | -6.7 | 1.49 V | 201 | 40.20 | -0.90 |

Remarks:

1. Emission Level(dBuV/m) = Raw Value(dBuV) + Correction Factor(dB/m)
2. Correction Factor(dB/m) = Antenna Factor(dB/m) + Cable Factor(dB)
3. The other emission levels were very low against the limit.
4. Margin value = Emission Level – Limit value

4.2 Conducted Emission Measurement

4.2.1 Limits of Conducted Emission Measurement

| Frequency (MHz) | Conducted Limit (dBuV) | |
|-----------------|------------------------|---------|
| | Quasi-peak | Average |
| 0.15 - 0.5 | 66 - 56 | 56 - 46 |
| 0.50 - 5.0 | 56 | 46 |
| 5.0 - 30.0 | 60 | 50 |

- Note:** 1. The lower limit shall apply at the transition frequencies.
 2. The limit decreases in line with the logarithm of the frequency in the range of 0.15 to 0.50MHz.

4.2.2 Test Instruments

| Description & Manufacturer | Model No. | Serial No. | Cal. Date | Cal. Due |
|--|--------------------------|----------------|---------------|---------------|
| Test Receiver ROHDE & SCHWARZ | ESCI | 100613 | Nov. 11, 2014 | Nov. 10, 2015 |
| RF signal cable (with 10dB PAD) Woken | 5D-FB | Cable-cond1-01 | Dec. 26, 2014 | Dec. 25, 2015 |
| LISN ROHDE & SCHWARZ (EUT) | ESH3-Z5 | 835239/001 | Feb. 26, 2015 | Feb. 25, 2016 |
| LISN ROHDE & SCHWARZ (Peripheral) | ESH3-Z5 | 100311 | Jul. 24, 2015 | Jul. 23, 2016 |
| Software ADT | BV ADT_Cond_ V7.3.7.3 | NA | NA | NA |

- Note:** 1. The calibration interval of the above test instruments is 12 months and the calibrations are traceable to NML/ROC and NIST/USA.
 2. The test was performed in HwaYa Shielded Room 1.
 3. The VCCI Site Registration No. is C-2040.

4.2.3 Test Procedures

- The EUT was placed 0.4 meters from the conducting wall of the shielded room with EUT being connected to the power mains through a line impedance stabilization network (LISN). Other support units were connected to the power mains through another LISN. The two LISNs provide 50 ohm/ 50uH of coupling impedance for the measuring instrument.
- Both lines of the power mains connected to the EUT were checked for maximum conducted interference.
- The frequency range from 150kHz to 30MHz was searched. Emission levels under (Limit - 20dB) was not recorded.

NOTE: The resolution bandwidth and video bandwidth of test receiver is 9kHz for quasi-peak detection (QP) and average detection (AV) at frequency 0.15MHz-30MHz.

4.2.4 Deviation from Test Standard

No deviation.

4.2.5 Test Setup

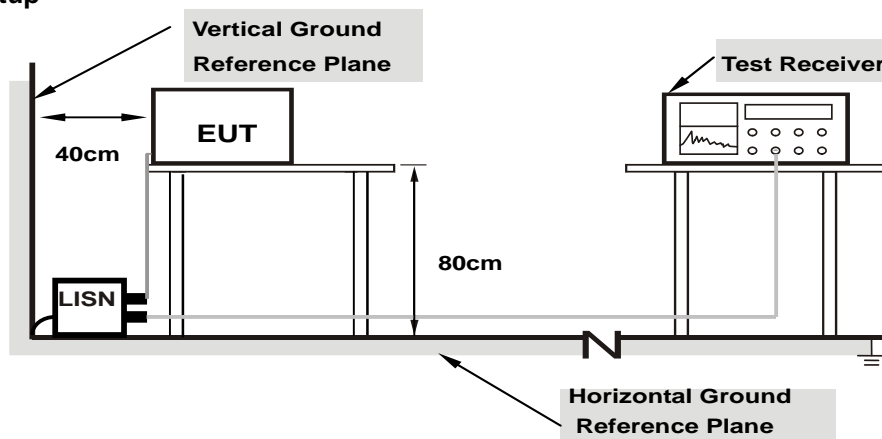

Note: 1.Support units were connected to second LISN.

For the actual test configuration, please refer to the attached file (Test Setup Photo).

4.2.6 EUT Operating Conditions

Same as 4.1.6.

4.2.7 Test Results

| | | | |
|-----------|----------|-------------------|--------------------------------|
| Phase | Line (L) | Detector Function | Quasi-Peak (QP) / Average (AV) |
| Test Mode | A | | |

| No | Freq. [MHz] | Corr. Factor (dB) | Reading Value [dB (uV)] | | Emission Level [dB (uV)] | | Limit [dB (uV)] | | Margin (dB) | |
|----|----------------|----------------------|----------------------------|---------|-----------------------------|-------|--------------------|-------|----------------|--------|
| | | | Q.P. | AV. | Q.P. | AV. | Q.P. | AV. | Q.P. | AV. |
| | | | 1 | 0.45889 | 9.91 | 36.14 | 24.04 | 46.05 | 33.95 | 56.71 |
| 2 | 0.73259 | 9.97 | 29.22 | 16.72 | 39.19 | 26.69 | 56.00 | 46.00 | -16.81 | -19.31 |
| 3 | 1.11186 | 10.04 | 28.78 | 16.47 | 38.82 | 26.51 | 56.00 | 46.00 | -17.18 | -19.49 |
| 4 | 3.68464 | 10.18 | 32.29 | 21.15 | 42.47 | 31.33 | 56.00 | 46.00 | -13.53 | -14.67 |
| 5 | 4.07564 | 10.19 | 31.18 | 20.35 | 41.37 | 30.54 | 56.00 | 46.00 | -14.63 | -15.46 |
| 6 | 8.71681 | 10.47 | 25.27 | 15.23 | 35.74 | 25.70 | 60.00 | 50.00 | -24.26 | -24.30 |

Remarks:

1. Q.P. and AV. are abbreviations of quasi-peak and average individually.
2. The emission levels of other frequencies were very low against the limit.
3. Margin value = Emission level - Limit value
4. Correction factor = Insertion loss + Cable loss
5. Emission Level = Correction Factor + Reading Value.

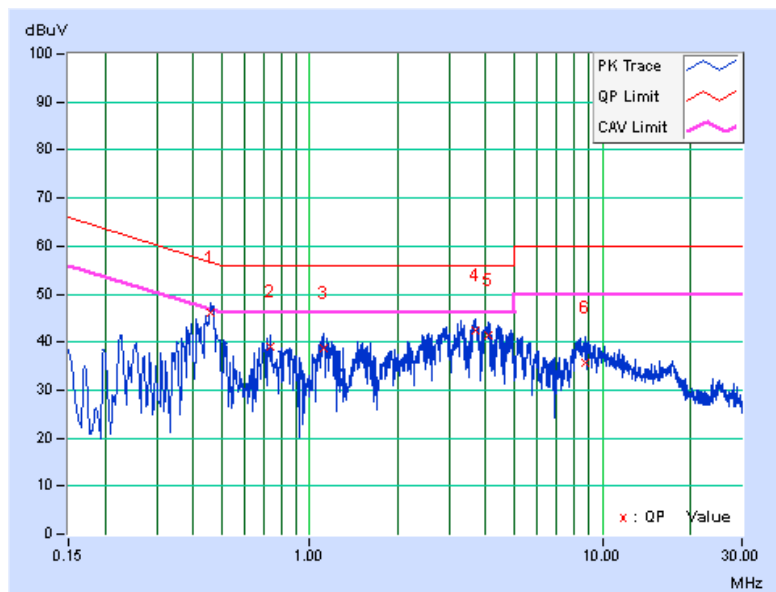

| | | | |
|-----------|-------------|-------------------|--------------------------------|
| Phase | Neutral (N) | Detector Function | Quasi-Peak (QP) / Average (AV) |
| Test Mode | A | | |

| No | Freq. [MHz] | Corr. Factor (dB) | Reading Value [dB (uV)] | | Emission Level [dB (uV)] | | Limit [dB (uV)] | | Margin (dB) | |
|----|----------------|----------------------|----------------------------|----------------|-----------------------------|--------------|--------------------|--------------|----------------|--------------|
| | | | Q.P. | AV. | Q.P. | AV. | Q.P. | AV. | Q.P. | AV. |
| | | | 1 | 0.46179 | 9.99 | 39.44 | 30.60 | 49.43 | 40.59 | 56.66 |
| 2 | 0.59183 | 10.00 | 30.37 | 20.90 | 40.37 | 30.90 | 56.00 | 46.00 | -15.63 | -15.10 |
| 3 | 0.95155 | 10.03 | 28.42 | 18.36 | 38.45 | 28.39 | 56.00 | 46.00 | -17.55 | -17.61 |
| 4 | 2.80880 | 10.19 | 29.61 | 20.34 | 39.80 | 30.53 | 56.00 | 46.00 | -16.20 | -15.47 |
| 5 | 4.43536 | 10.35 | 27.78 | 19.97 | 38.13 | 30.32 | 56.00 | 46.00 | -17.87 | -15.68 |
| 6 | 17.33836 | 10.93 | 23.32 | 15.29 | 34.25 | 26.22 | 60.00 | 50.00 | -25.75 | -23.78 |

Remarks:

1. Q.P. and AV. are abbreviations of quasi-peak and average individually.
2. The emission levels of other frequencies were very low against the limit.
3. Margin value = Emission level - Limit value
4. Correction factor = Insertion loss + Cable loss
5. Emission Level = Correction Factor + Reading Value.

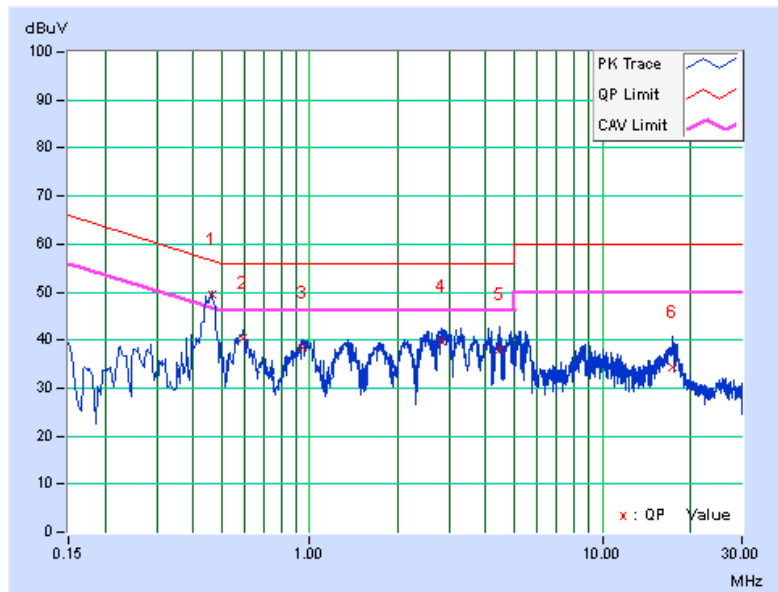

| | | | |
|-----------|----------|-------------------|--------------------------------|
| Phase | Line (L) | Detector Function | Quasi-Peak (QP) / Average (AV) |
| Test Mode | B | | |

| No | Freq. [MHz] | Corr. Factor (dB) | Reading Value [dB (uV)] | | Emission Level [dB (uV)] | | Limit [dB (uV)] | | Margin (dB) | |
|----|----------------|----------------------|----------------------------|---------|-----------------------------|-------|--------------------|-------|----------------|--------|
| | | | Q.P. | AV. | Q.P. | AV. | Q.P. | AV. | Q.P. | AV. |
| | | | 1 | 0.15000 | 9.82 | 27.45 | 25.96 | 37.27 | 35.78 | 66.00 |
| 2 | 0.19717 | 9.84 | 27.12 | 17.04 | 36.96 | 26.88 | 63.73 | 53.73 | -26.77 | -26.85 |
| 3 | 0.44273 | 9.88 | 31.37 | 22.72 | 41.25 | 32.60 | 57.01 | 47.01 | -15.76 | -14.41 |
| 4 | 0.80307 | 9.91 | 18.13 | 9.90 | 28.04 | 19.81 | 56.00 | 46.00 | -27.96 | -26.19 |
| 5 | 9.23684 | 10.46 | 30.32 | 29.34 | 40.78 | 39.80 | 60.00 | 50.00 | -19.22 | -10.20 |
| 6 | 26.49558 | 11.33 | 33.73 | 31.50 | 45.06 | 42.83 | 60.00 | 50.00 | -14.94 | -7.17 |

Remarks:

1. Q.P. and AV. are abbreviations of quasi-peak and average individually.
2. The emission levels of other frequencies were very low against the limit.
3. Margin value = Emission level - Limit value
4. Correction factor = Insertion loss + Cable loss
5. Emission Level = Correction Factor + Reading Value.

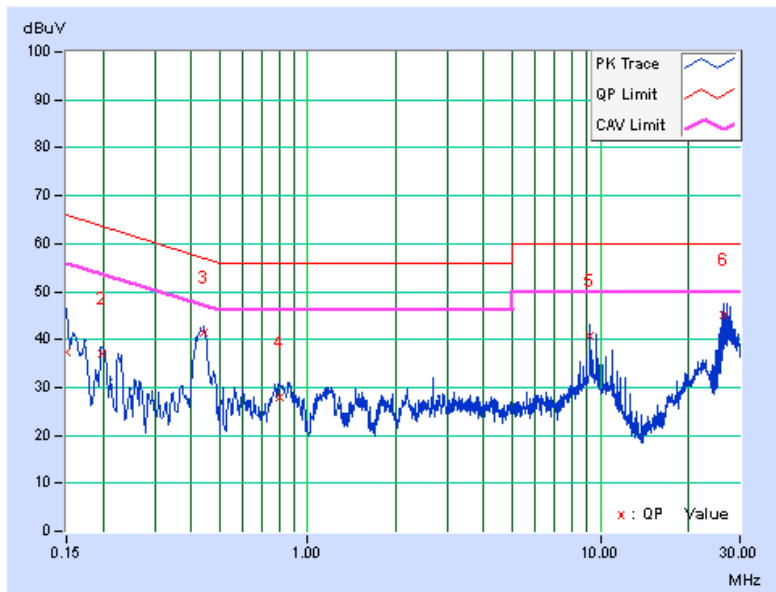

| | | | |
|-----------|-------------|-------------------|--------------------------------|
| Phase | Neutral (N) | Detector Function | Quasi-Peak (QP) / Average (AV) |
| Test Mode | B | | |

| No | Freq. [MHz] | Corr. Factor (dB) | Reading Value [dB (uV)] | | Emission Level [dB (uV)] | | Limit [dB (uV)] | | Margin (dB) | |
|----|----------------|----------------------|----------------------------|---------|-----------------------------|-------|--------------------|-------|----------------|--------|
| | | | Q.P. | AV. | Q.P. | AV. | Q.P. | AV. | Q.P. | AV. |
| | | | 1 | 0.15760 | 9.82 | 25.94 | 19.28 | 35.76 | 29.10 | 65.59 |
| 2 | 0.22429 | 9.84 | 24.97 | 19.15 | 34.81 | 28.99 | 62.66 | 52.66 | -27.85 | -23.67 |
| 3 | 0.43579 | 9.88 | 31.16 | 23.16 | 41.04 | 33.04 | 57.14 | 47.14 | -16.10 | -14.10 |
| 4 | 2.67195 | 10.04 | 19.77 | 18.24 | 29.81 | 28.28 | 56.00 | 46.00 | -26.19 | -17.72 |
| 5 | 9.72559 | 10.46 | 30.08 | 29.43 | 40.54 | 39.89 | 60.00 | 50.00 | -19.46 | -10.11 |
| 6 | 26.74582 | 11.08 | 34.42 | 33.02 | 45.50 | 44.10 | 60.00 | 50.00 | -14.50 | -5.90 |

Remarks:

1. Q.P. and AV. are abbreviations of quasi-peak and average individually.
2. The emission levels of other frequencies were very low against the limit.
3. Margin value = Emission level - Limit value
4. Correction factor = Insertion loss + Cable loss
5. Emission Level = Correction Factor + Reading Value.

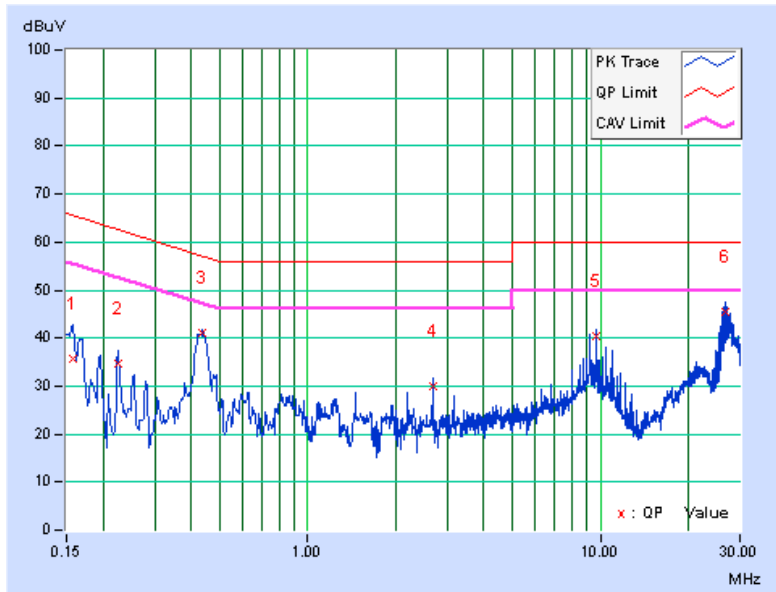

| | | | |
|-----------|----------|-------------------|--------------------------------|
| Phase | Line (L) | Detector Function | Quasi-Peak (QP) / Average (AV) |
| Test Mode | C | | |

| No | Freq. [MHz] | Corr. Factor (dB) | Reading Value [dB (uV)] | | Emission Level [dB (uV)] | | Limit [dB (uV)] | | Margin (dB) | |
|----|----------------|----------------------|----------------------------|---------|-----------------------------|-------|--------------------|-------|----------------|--------|
| | | | Q.P. | AV. | Q.P. | AV. | Q.P. | AV. | Q.P. | AV. |
| | | | 1 | 0.46280 | 9.91 | 39.03 | 27.03 | 48.94 | 36.94 | 56.64 |
| 2 | 1.11577 | 10.04 | 27.76 | 15.68 | 37.80 | 25.72 | 56.00 | 46.00 | -18.20 | -20.28 |
| 3 | 3.18807 | 10.15 | 33.29 | 22.72 | 43.44 | 32.87 | 56.00 | 46.00 | -12.56 | -13.13 |
| 4 | 3.60644 | 10.17 | 33.98 | 23.62 | 44.15 | 33.79 | 56.00 | 46.00 | -11.85 | -12.21 |
| 5 | 3.91142 | 10.19 | 32.68 | 21.29 | 42.87 | 31.48 | 56.00 | 46.00 | -13.13 | -14.52 |
| 6 | 8.83020 | 10.47 | 27.24 | 17.76 | 37.71 | 28.23 | 60.00 | 50.00 | -22.29 | -21.77 |

Remarks:

1. Q.P. and AV. are abbreviations of quasi-peak and average individually.
2. The emission levels of other frequencies were very low against the limit.
3. Margin value = Emission level - Limit value
4. Correction factor = Insertion loss + Cable loss
5. Emission Level = Correction Factor + Reading Value.

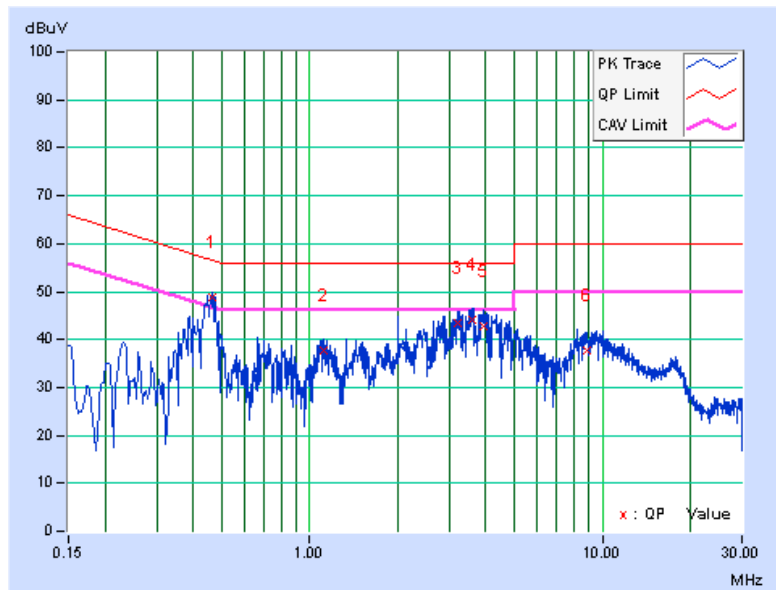

| | | | |
|-----------|-------------|-------------------|--------------------------------|
| Phase | Neutral (N) | Detector Function | Quasi-Peak (QP) / Average (AV) |
| Test Mode | C | | |

| No | Freq. [MHz] | Corr. Factor (dB) | Reading Value [dB (uV)] | | Emission Level [dB (uV)] | | Limit [dB (uV)] | | Margin (dB) | |
|----|----------------|----------------------|----------------------------|---------|-----------------------------|-------|--------------------|-------|----------------|--------|
| | | | Q.P. | AV. | Q.P. | AV. | Q.P. | AV. | Q.P. | AV. |
| | | | 1 | 0.45097 | 9.99 | 39.82 | 30.64 | 49.81 | 40.63 | 56.86 |
| 2 | 0.58010 | 10.00 | 30.89 | 22.86 | 40.89 | 32.86 | 56.00 | 46.00 | -15.11 | -13.14 |
| 3 | 0.95937 | 10.03 | 28.99 | 19.21 | 39.02 | 29.24 | 56.00 | 46.00 | -16.98 | -16.76 |
| 4 | 2.96911 | 10.21 | 30.53 | 20.51 | 40.74 | 30.72 | 56.00 | 46.00 | -15.26 | -15.28 |
| 5 | 3.27800 | 10.24 | 31.88 | 22.94 | 42.12 | 33.18 | 56.00 | 46.00 | -13.88 | -12.82 |
| 6 | 10.25735 | 10.60 | 25.83 | 15.42 | 36.43 | 26.02 | 60.00 | 50.00 | -23.57 | -23.98 |

Remarks:

1. Q.P. and AV. are abbreviations of quasi-peak and average individually.
2. The emission levels of other frequencies were very low against the limit.
3. Margin value = Emission level - Limit value
4. Correction factor = Insertion loss + Cable loss
5. Emission Level = Correction Factor + Reading Value.

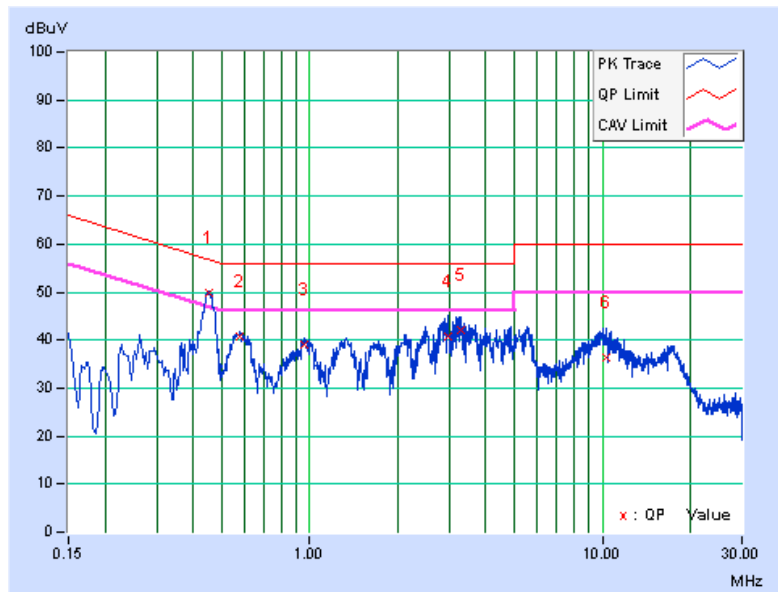

| | | | |
|-----------|----------|-------------------|--------------------------------|
| Phase | Line (L) | Detector Function | Quasi-Peak (QP) / Average (AV) |
| Test Mode | D | | |

| No | Freq. [MHz] | Corr. Factor (dB) | Reading Value [dB (uV)] | | Emission Level [dB (uV)] | | Limit [dB (uV)] | | Margin (dB) | |
|----|----------------|----------------------|----------------------------|---------|-----------------------------|-------|--------------------|-------|----------------|--------|
| | | | Q.P. | AV. | Q.P. | AV. | Q.P. | AV. | Q.P. | AV. |
| | | | 1 | 0.15000 | 9.82 | 26.85 | 25.88 | 36.67 | 35.70 | 66.00 |
| 2 | 0.18910 | 9.84 | 28.15 | 16.31 | 37.99 | 26.15 | 64.08 | 54.08 | -26.09 | -27.93 |
| 3 | 0.43122 | 9.88 | 32.44 | 25.42 | 42.32 | 35.30 | 57.23 | 47.23 | -14.91 | -11.93 |
| 4 | 0.81802 | 9.91 | 18.96 | 11.76 | 28.87 | 21.67 | 56.00 | 46.00 | -27.13 | -24.33 |
| 5 | 9.27594 | 10.46 | 29.70 | 28.49 | 40.16 | 38.95 | 60.00 | 50.00 | -19.84 | -11.05 |
| 6 | 27.34014 | 11.36 | 30.47 | 28.44 | 41.83 | 39.80 | 60.00 | 50.00 | -18.17 | -10.20 |

Remarks:

1. Q.P. and AV. are abbreviations of quasi-peak and average individually.
2. The emission levels of other frequencies were very low against the limit.
3. Margin value = Emission level - Limit value
4. Correction factor = Insertion loss + Cable loss
5. Emission Level = Correction Factor + Reading Value.

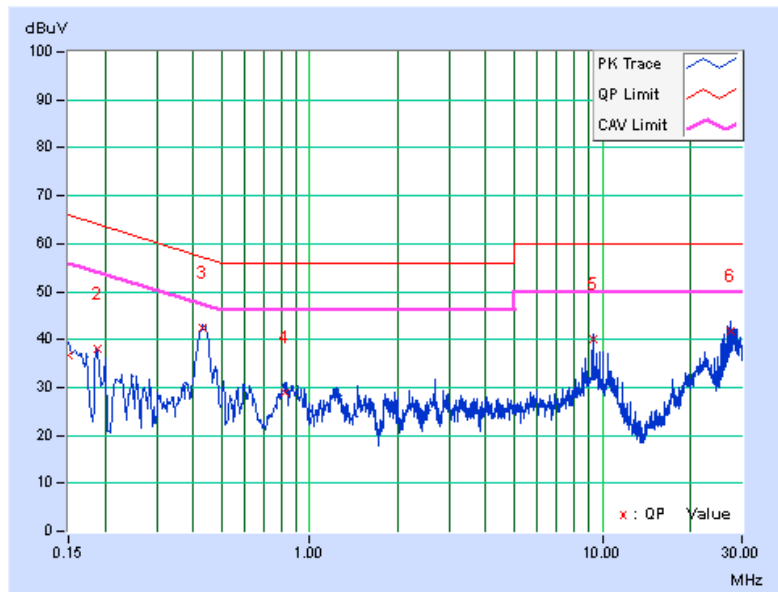

| | | | |
|-----------|-------------|-------------------|--------------------------------|
| Phase | Neutral (N) | Detector Function | Quasi-Peak (QP) / Average (AV) |
| Test Mode | D | | |

| No | Freq. [MHz] | Corr. Factor (dB) | Reading Value [dB (uV)] | | Emission Level [dB (uV)] | | Limit [dB (uV)] | | Margin (dB) | |
|----|----------------|----------------------|----------------------------|---------|-----------------------------|-------|--------------------|-------|----------------|--------|
| | | | Q.P. | AV. | Q.P. | AV. | Q.P. | AV. | Q.P. | AV. |
| | | | 1 | 0.15000 | 9.82 | 26.78 | 25.91 | 36.60 | 35.73 | 66.00 |
| 2 | 0.16955 | 9.82 | 31.31 | 20.68 | 41.13 | 30.50 | 64.98 | 54.98 | -23.85 | -24.48 |
| 3 | 0.43122 | 9.88 | 31.50 | 24.54 | 41.38 | 34.42 | 57.23 | 47.23 | -15.85 | -12.81 |
| 4 | 0.87335 | 9.92 | 17.97 | 10.50 | 27.89 | 20.42 | 56.00 | 46.00 | -28.11 | -25.58 |
| 5 | 9.27594 | 10.44 | 29.63 | 28.49 | 40.07 | 38.93 | 60.00 | 50.00 | -19.93 | -11.07 |
| 6 | 27.82498 | 11.10 | 31.38 | 29.53 | 42.48 | 40.63 | 60.00 | 50.00 | -17.52 | -9.37 |

Remarks:

1. Q.P. and AV. are abbreviations of quasi-peak and average individually.
2. The emission levels of other frequencies were very low against the limit.
3. Margin value = Emission level - Limit value
4. Correction factor = Insertion loss + Cable loss
5. Emission Level = Correction Factor + Reading Value.

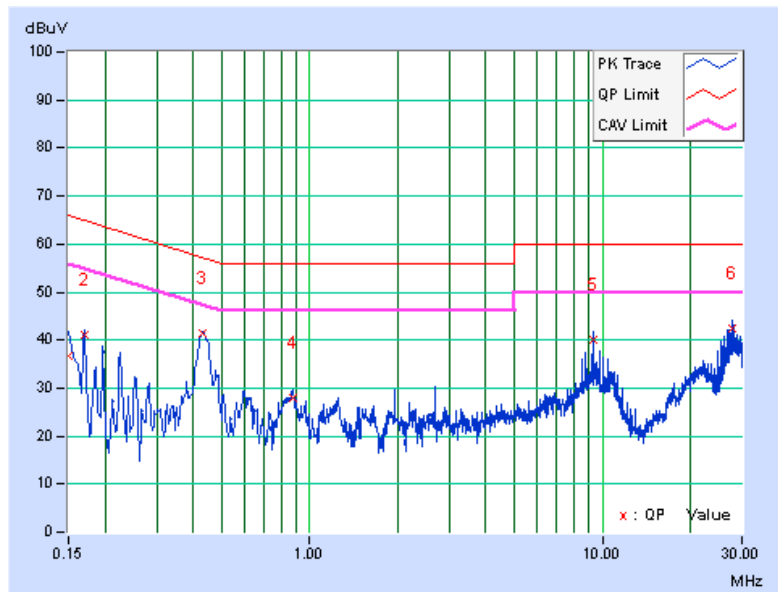

4.3 Transmit Power Measurement

4.3.1 Limits of Transmit Power Measurement

| Operation Band | EUT Category | | Limit |
|----------------|--------------|-----------------------------------|---|
| U-NII-1 | | Outdoor Access Point | 1 Watt (30 dBm) (Max. e.i.r.p \leq 125mW(21 dBm) at any elevation angle above 30 degrees as measured from the horizon) |
| | | Fixed point-to-point Access Point | 1 Watt (30 dBm) |
| | √ | Indoor Access Point | 1 Watt (30 dBm) |
| | | Mobile and Portable client device | 250mW (24 dBm) |
| U-NII-2A | --- | | 250mW (24 dBm) or 11 dBm+10 log B* |
| U-NII-2C | --- | | 250mW (24 dBm) or 11 dBm+10 log B* |
| U-NII-3 | √ | | 1 Watt (30 dBm) |

*B is the 26 dB emission bandwidth in megahertz

Per KDB 662911 Method of conducted output power measurement on IEEE 802.11 devices,

Array Gain = 0 dB (i.e., no array gain) for $N_{ANT} \leq 4$;

Array Gain = 0 dB (i.e., no array gain) for channel widths ≥ 40 MHz for any N_{ANT} ;

Array Gain = $5 \log(N_{ANT}/N_{SS})$ dB or 3 dB, whichever is less for 20-MHz channel widths with $N_{ANT} \geq 5$.

For power measurements on all other devices: Array Gain = $10 \log(N_{ANT}/N_{SS})$ dB.

4.3.2 Test Setup

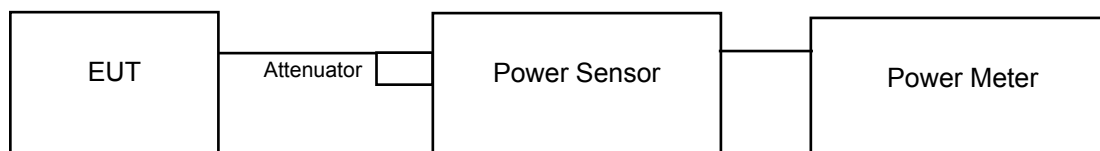

4.3.3 Test Instruments

Refer to section 4.1.2 to get information of above instrument.

4.3.4 Test Procedure

Method PM is used to perform output power measurement, trigger and gating function of wide band power meter is enabled to measure max output power of TX on burst. Duty factor is not added to measured value.

4.3.5 Deviation from Test Standard

No deviation.

4.3.6 EUT Operating Conditions

The software provided by client to enable the EUT under transmission condition continuously at lowest, middle and highest channel frequencies individually.

4.3.7 Test Result

Power Output:

802.11a

| Channel | Channel Frequency (MHz) | Maximum Conducted Power (dBm) | | Total Power (mW) | Total Power (dBm) | Power Limit (dBm) | Pass / Fail |
|---------|-------------------------|-------------------------------|---------|------------------|-------------------|-------------------|-------------|
| | | Chain 0 | Chain 1 | | | | |
| 36 | 5180 | 16.69 | 17.55 | 103.551 | 20.15 | 30.00 | Pass |
| 40 | 5200 | 17.85 | 17.84 | 121.768 | 20.86 | 30.00 | Pass |
| 48 | 5240 | 16.57 | 17.89 | 106.912 | 20.29 | 30.00 | Pass |
| 149 | 5745 | 14.05 | 13.36 | 47.087 | 16.73 | 30.00 | Pass |
| 157 | 5785 | 15.76 | 15.60 | 73.978 | 18.69 | 30.00 | Pass |
| 165 | 5825 | 14.76 | 14.77 | 59.915 | 17.78 | 30.00 | Pass |

802.11n (HT20)

| Channel | Channel Frequency (MHz) | Maximum Conducted Power (dBm) | | Total Power (mW) | Total Power (dBm) | Power Limit (dBm) | Pass / Fail |
|---------|-------------------------|-------------------------------|---------|------------------|-------------------|-------------------|-------------|
| | | Chain 0 | Chain 1 | | | | |
| 36 | 5180 | 16.32 | 17.16 | 94.855 | 19.77 | 30.00 | Pass |
| 40 | 5200 | 17.66 | 17.97 | 121.006 | 20.83 | 30.00 | Pass |
| 48 | 5240 | 16.98 | 18.12 | 114.751 | 20.60 | 30.00 | Pass |
| 149 | 5745 | 13.16 | 12.05 | 36.733 | 15.65 | 30.00 | Pass |
| 157 | 5785 | 17.45 | 17.16 | 107.590 | 20.32 | 30.00 | Pass |
| 165 | 5825 | 14.74 | 14.75 | 59.639 | 17.76 | 30.00 | Pass |

802.11n (HT40)

| Channel | Channel Frequency (MHz) | Maximum Conducted Power (dBm) | | Total Power (mW) | Total Power (dBm) | Power Limit (dBm) | Pass / Fail |
|---------|-------------------------|-------------------------------|---------|------------------|-------------------|-------------------|-------------|
| | | Chain 0 | Chain 1 | | | | |
| 38 | 5190 | 12.33 | 12.86 | 36.420 | 15.61 | 30.00 | Pass |
| 46 | 5230 | 17.48 | 18.64 | 129.090 | 21.11 | 30.00 | Pass |
| 151 | 5755 | 11.03 | 10.11 | 22.934 | 13.60 | 30.00 | Pass |
| 159 | 5795 | 15.23 | 15.10 | 65.702 | 18.18 | 30.00 | Pass |

26dB Bandwidth:
802.11a

| Channel | Channel Frequency (MHz) | 26dBc Bandwidth (MHz) | | Pass / Fail |
|---------|-------------------------|-----------------------|---------|-------------|
| | | Chain 0 | Chain 1 | |
| 36 | 5180 | 24.11 | 23.88 | Pass |
| 40 | 5200 | 24.15 | 24.76 | Pass |
| 48 | 5240 | 24.32 | 22.89 | Pass |

802.11n (HT20)

| Channel | Channel Frequency (MHz) | 26dBc Bandwidth (MHz) | | Pass / Fail |
|---------|-------------------------|-----------------------|---------|-------------|
| | | Chain 0 | Chain 1 | |
| 36 | 5180 | 24.75 | 24.61 | Pass |
| 40 | 5200 | 24.75 | 24.74 | Pass |
| 48 | 5240 | 24.57 | 25.20 | Pass |

802.11n (HT40)

| Channel | Channel Frequency (MHz) | 26dBc Bandwidth (MHz) | | Pass / Fail |
|---------|-------------------------|-----------------------|---------|-------------|
| | | Chain 0 | Chain 1 | |
| 38 | 5190 | 52.59 | 51.37 | Pass |
| 46 | 5230 | 61.93 | 53.98 | Pass |

Spectrum Plot of Worst Value

802.11a

802.11n (HT20)

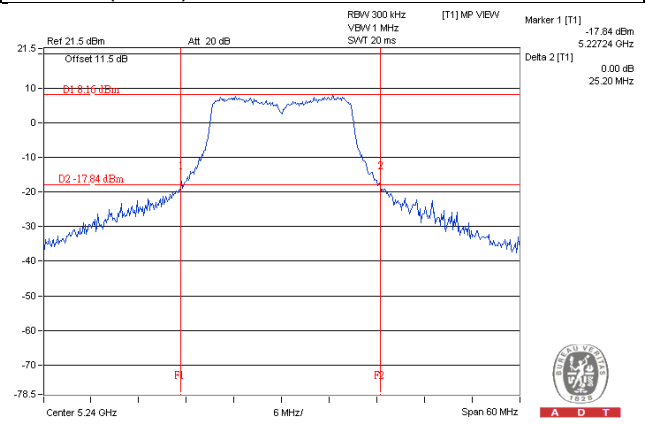
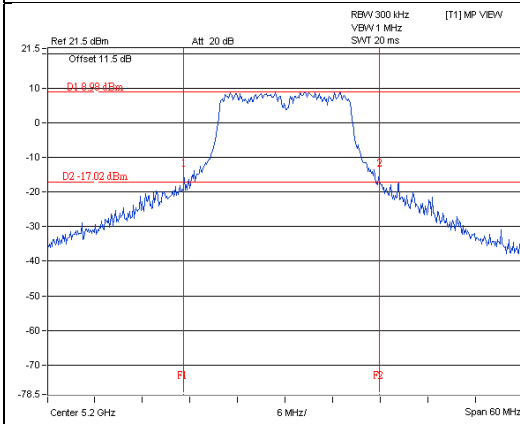

802.11n (HT40)

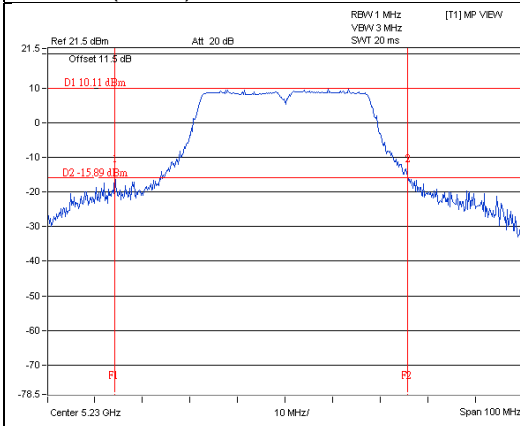

Occupied Bandwidth:
802.11a

| Channel | Channel Frequency (MHz) | Occupied Bandwidth (MHz) | |
|---------|-------------------------|--------------------------|---------|
| | | Chain 0 | Chain 1 |
| 36 | 5180 | 17.16 | 16.80 |
| 40 | 5200 | 17.04 | 16.92 |
| 48 | 5240 | 17.16 | 16.80 |
| 149 | 5745 | 17.04 | 16.78 |
| 157 | 5785 | 17.16 | 17.04 |
| 165 | 5825 | 17.16 | 16.92 |

802.11n (HT20)

| Channel | Channel Frequency (MHz) | Occupied Bandwidth (MHz) | |
|---------|-------------------------|--------------------------|---------|
| | | Chain 0 | Chain 1 |
| 36 | 5180 | 18.12 | 17.88 |
| 40 | 5200 | 18.12 | 17.88 |
| 48 | 5240 | 18.12 | 18.36 |
| 149 | 5745 | 18.36 | 18.24 |
| 157 | 5785 | 19.68 | 18.48 |
| 165 | 5825 | 18.12 | 18.00 |

802.11n (HT40)

| Channel | Channel Frequency (MHz) | Occupied Bandwidth (MHz) | |
|---------|-------------------------|--------------------------|---------|
| | | Chain 0 | Chain 1 |
| 38 | 5190 | 37.56 | 37.68 |
| 46 | 5230 | 37.92 | 37.20 |
| 151 | 5755 | 37.56 | 37.68 |
| 159 | 5795 | 37.80 | 37.56 |

Spectrum Plot of Worst Value

802.11a

802.11n (HT20)

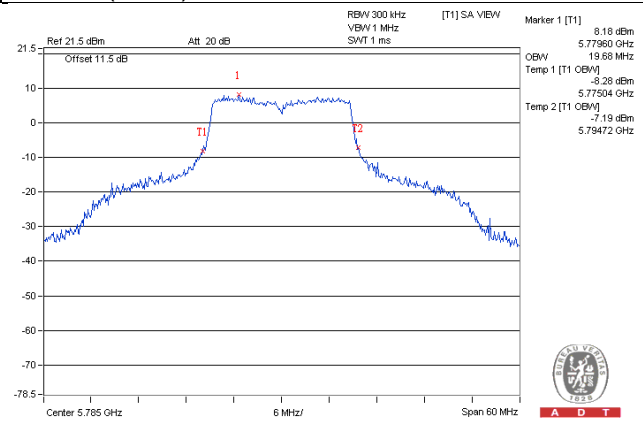
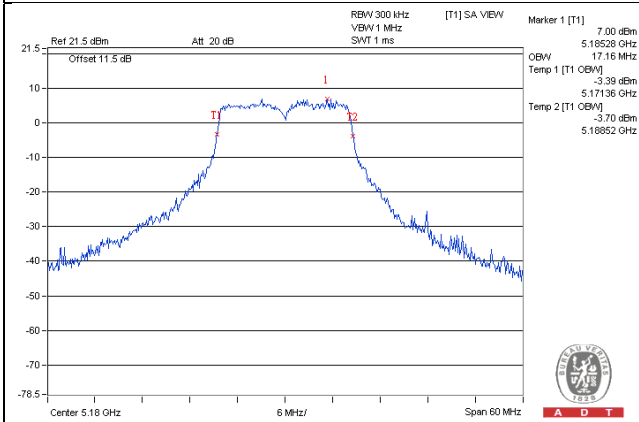

802.11n (HT40)

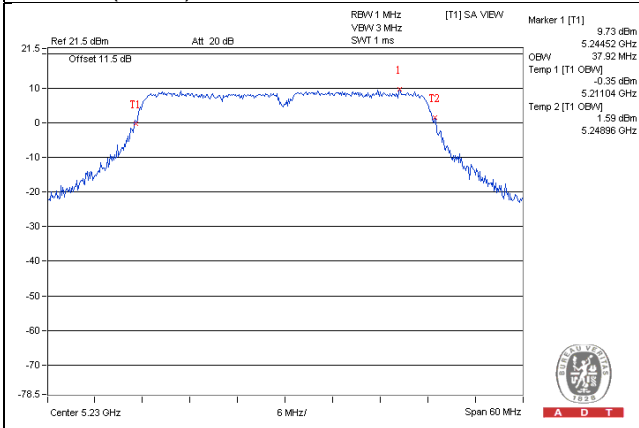

4.4 Peak Power Spectral Density Measurement

4.4.1 Limits of Peak Power Spectral Density Measurement

| Operation Band | EUT Category | | Limit |
|----------------|--------------|-----------------------------------|---------------|
| U-NII-1 | | Outdoor Access Point | 17dBm/ MHz |
| | | Fixed point-to-point Access Point | |
| | √ | Indoor Access Point | 11dBm/ MHz |
| | | Mobile and Portable client device | |
| U-NII-2A | --- | | 11dBm/ MHz |
| U-NII-2C | --- | | 11dBm/ MHz |
| U-NII-3 | √ | | 30dBm/ 500kHz |

4.4.2 Test Setup

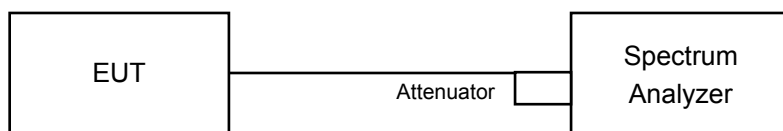

4.4.3 Test Instruments

Refer to section 4.1.2 to get information of above instrument.

4.4.4 Test Procedures

For U-NII-1 band:

Using method SA-1

- Set span to encompass the entire emission bandwidth (EBW) of the signal.
- Set RBW = 1 MHz, Set VBW ≥ 3 MHz, Detector = RMS
- Sweep time = auto, trigger set to “free run”.
- Trace average at least 100 traces in power averaging mode.
- Record the max value

For U-NII-3 band:

- Set span to encompass the entire emission bandwidth (EBW) of the signal.
- Set RBW = 300 kHz, Set VBW ≥ 1 MHz, Detector = RMS
- Use the peak marker function to determine the maximum power level in any 300 kHz band segment within the fundamental EBW.
- Scale the observed power level to an equivalent value in 500 kHz by adjusting (reducing) the measured power by a bandwidth correction factor (BWCF) where $BWCF = 10\log(500\text{ kHz}/300\text{ kHz})$
- Sweep time = auto, trigger set to “free run”.
- Trace average at least 100 traces in power averaging mode.
- Record the max value

4.4.5 Deviation from Test Standard

No deviation.

4.4.6 EUT Operating Conditions

Same as Item 4.3.6.

4.4.7 Test Results

For U-NII-1 Band

802.11a

| Channel | Channel Frequency (MHz) | PSD (dBm) | | Total PSD (dBm) | Max. Limit (dBm) | Pass / Fail |
|---------|-------------------------|-----------|---------|-----------------|------------------|-------------|
| | | Chain 0 | Chain 1 | | | |
| 36 | 5180 | 1.89 | 5.45 | 7.04 | 15.99 | Pass |
| 40 | 5200 | 2.34 | 4.63 | 6.64 | 15.99 | Pass |
| 48 | 5240 | 2.22 | 4.47 | 6.50 | 15.99 | Pass |

Note:

- Method 1 of power density measurement of KDB 662911 is using for calculating total power density. Total power density is summing entire spectra across corresponding frequency bins on the various outputs by computer.
- Directional gain = $4\text{dBi} + 10\log(2) = 7.01\text{dBi} > 6\text{dBi}$, so the power density limit shall be reduced to $17-(7.01-6) = 15.99\text{dBm}$.

802.11n (HT20)

| Channel | Channel Frequency (MHz) | PSD (dBm) | | Total PSD (dBm) | Max. Limit (dBm) | Pass / Fail |
|---------|-------------------------|-----------|---------|-----------------|------------------|-------------|
| | | Chain 0 | Chain 1 | | | |
| 36 | 5180 | 1.82 | 3.60 | 5.81 | 15.99 | Pass |
| 40 | 5200 | 1.77 | 3.61 | 5.80 | 15.99 | Pass |
| 48 | 5240 | 2.03 | 3.47 | 5.82 | 15.99 | Pass |

Note:

- Method 1 of power density measurement of KDB 662911 is using for calculating total power density. Total power density is summing entire spectra across corresponding frequency bins on the various outputs by computer.
- Directional gain = $4\text{dBi} + 10\log(2) = 7.01\text{dBi} > 6\text{dBi}$, so the power density limit shall be reduced to $17-(7.01-6) = 15.99\text{dBm}$.

802.11n (HT40)

| Channel | Channel Frequency (MHz) | PSD (dBm) | | Total PSD (dBm) | Max. Limit (dBm) | Pass / Fail |
|---------|-------------------------|-----------|---------|-----------------|------------------|-------------|
| | | Chain 0 | Chain 1 | | | |
| 38 | 5190 | -6.04 | -4.08 | -1.94 | 15.99 | Pass |
| 46 | 5230 | -0.89 | 1.73 | 3.63 | 15.99 | Pass |

Note:

- Method 1 of power density measurement of KDB 662911 is using for calculating total power density. Total power density is summing entire spectra across corresponding frequency bins on the various outputs by computer.
- Directional gain = $4\text{dBi} + 10\log(2) = 7.01\text{dBi} > 6\text{dBi}$, so the power density limit shall be reduced to $17-(7.01-6) = 15.99\text{dBm}$.

Spectrum Plot of Worst Value

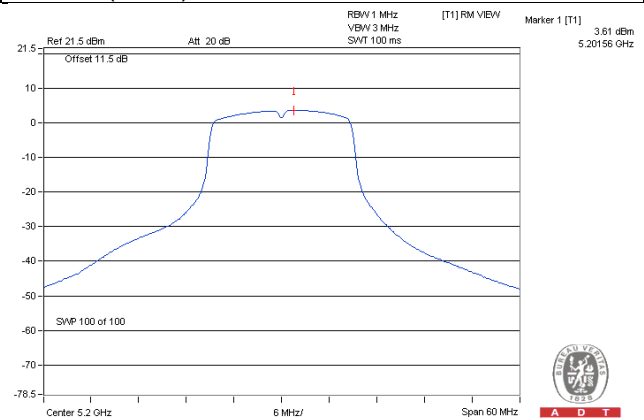
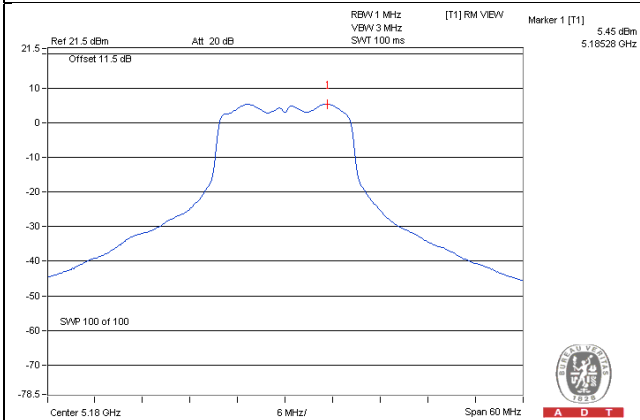
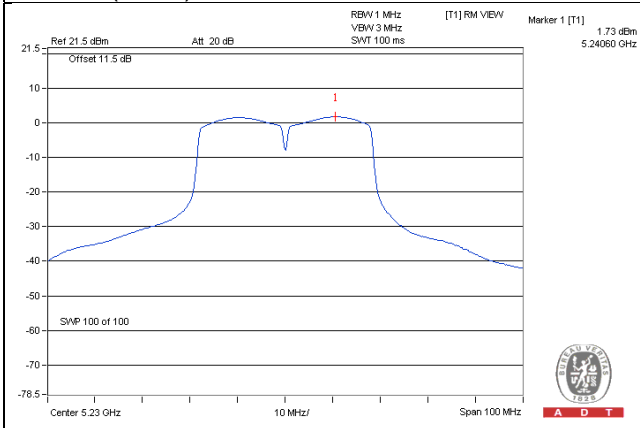
802.11a**802.11n (HT20)****802.11n (HT40)**

For U-NII-3 Band
802.11a

| TX chain | Channel | Channel Frequency (MHz) | PSD (dBm/300 kHz) | PSD (dBm/500 kHz) | 10 log (N=2) dB | Total PSD (dBm/500 kHz) | Limit (dBm/500 kHz) | Pass / Fail |
|----------|---------|-------------------------|-------------------|-------------------|-----------------|-------------------------|---------------------|-------------|
| 0 | 149 | 5745 | -8.04 | -5.82 | 3.01 | -2.81 | 28.99 | Pass |
| | 157 | 5785 | -6.08 | -3.86 | 3.01 | -0.85 | 28.99 | Pass |
| | 165 | 5825 | -6.44 | -4.22 | 3.01 | -1.21 | 28.99 | Pass |
| 1 | 149 | 5745 | -8.09 | -5.87 | 3.01 | -2.86 | 28.99 | Pass |
| | 157 | 5785 | -6.47 | -4.25 | 3.01 | -1.24 | 28.99 | Pass |
| | 165 | 5825 | -7.45 | -5.23 | 3.01 | -2.22 | 28.99 | Pass |

Note:

- Method 1 of power density measurement of KDB 662911 is using for calculating total power density. Total power density is summing entire spectra across corresponding frequency bins on the various outputs by computer.
- Directional gain = $4\text{dBi} + 10\log(2) = 7.01\text{dBi} > 6\text{dBi}$, so the power density limit shall be reduced to $30-(7.01-6) = 28.99\text{dBm}$.

802.11n (HT20)

| TX chain | Channel | Channel Frequency (MHz) | PSD (dBm/300 kHz) | PSD (dBm/500 kHz) | 10 log (N=2) dB | Total PSD (dBm/500 kHz) | Limit (dBm/500 kHz) | Pass / Fail |
|----------|---------|-------------------------|-------------------|-------------------|-----------------|-------------------------|---------------------|-------------|
| 0 | 149 | 5745 | -9.72 | -7.50 | 3.01 | -4.49 | 28.99 | Pass |
| | 157 | 5785 | -4.93 | -2.71 | 3.01 | 0.30 | 28.99 | Pass |
| | 165 | 5825 | -7.13 | -4.91 | 3.01 | -1.90 | 28.99 | Pass |
| 1 | 149 | 5745 | -9.80 | -7.58 | 3.01 | -4.57 | 28.99 | Pass |
| | 157 | 5785 | -4.93 | -2.71 | 3.01 | 0.30 | 28.99 | Pass |
| | 165 | 5825 | -7.51 | -5.29 | 3.01 | -2.28 | 28.99 | Pass |

Note:

- Method 1 of power density measurement of KDB 662911 is using for calculating total power density. Total power density is summing entire spectra across corresponding frequency bins on the various outputs by computer.
- Directional gain = $4\text{dBi} + 10\log(2) = 7.01\text{dBi} > 6\text{dBi}$, so the power density limit shall be reduced to $30-(7.01-6) = 28.99\text{dBm}$.

802.11n (HT40)

| TX chain | Channel | Channel Frequency (MHz) | PSD (dBm/300 kHz) | PSD (dBm/500 kHz) | 10 log (N=2) dB | Total PSD (dBm/500 kHz) | Limit (dBm/500 kHz) | Pass / Fail |
|----------|---------|-------------------------|-------------------|-------------------|-----------------|-------------------------|---------------------|-------------|
| 0 | 151 | 5755 | -14.40 | -12.18 | 3.01 | -9.17 | 28.99 | Pass |
| | 159 | 5795 | -9.49 | -7.27 | 3.01 | -4.26 | 28.99 | Pass |
| 1 | 151 | 5755 | -15.16 | -12.94 | 3.01 | -9.93 | 28.99 | Pass |
| | 159 | 5795 | -9.91 | -7.69 | 3.01 | -4.68 | 28.99 | Pass |

Note:

- Method 1 of power density measurement of KDB 662911 is using for calculating total power density. Total power density is summing entire spectra across corresponding frequency bins on the various outputs by computer.
- Directional gain = $4\text{dBi} + 10\log(2) = 7.01\text{dBi} > 6\text{dBi}$, so the power density limit shall be reduced to $30-(7.01-6) = 28.99\text{dBm}$.

Spectrum Plot of Worst Value

802.11a

802.11n (HT20)

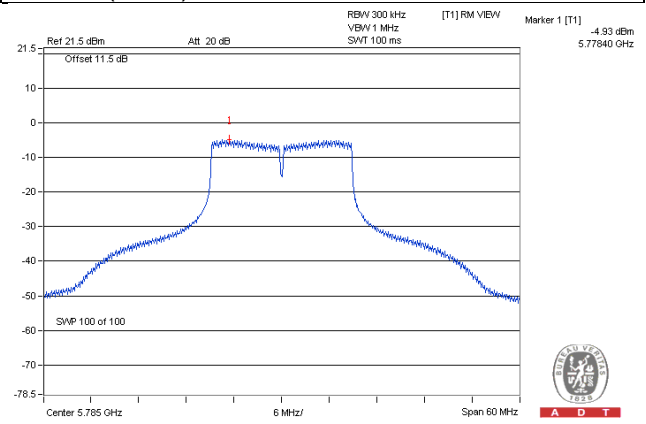
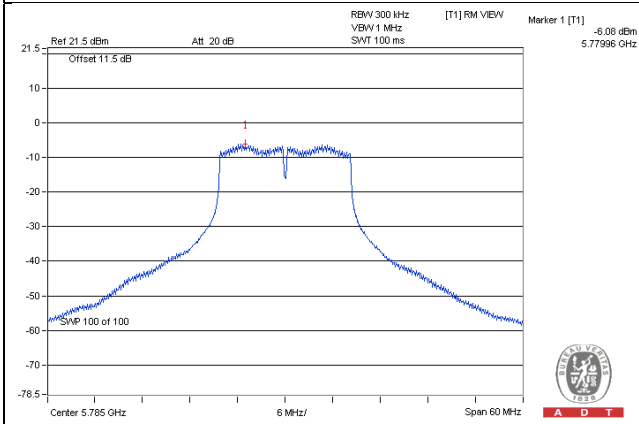

802.11n (HT40)

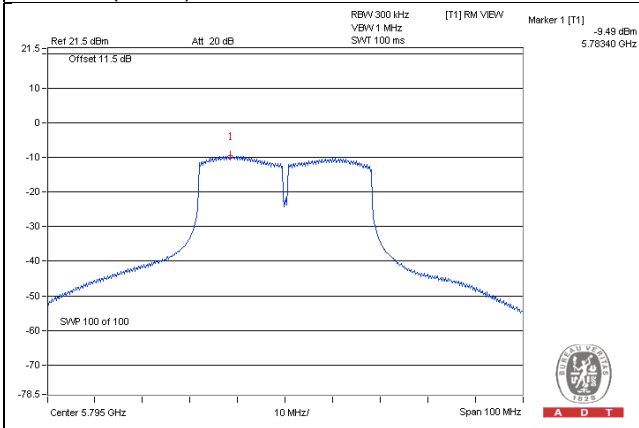

4.5 Frequency Stability

4.5.1 Limits of Frequency Stability Measurement

The frequency of the carrier signal shall be maintained within band of operation

4.5.2 Test Setup

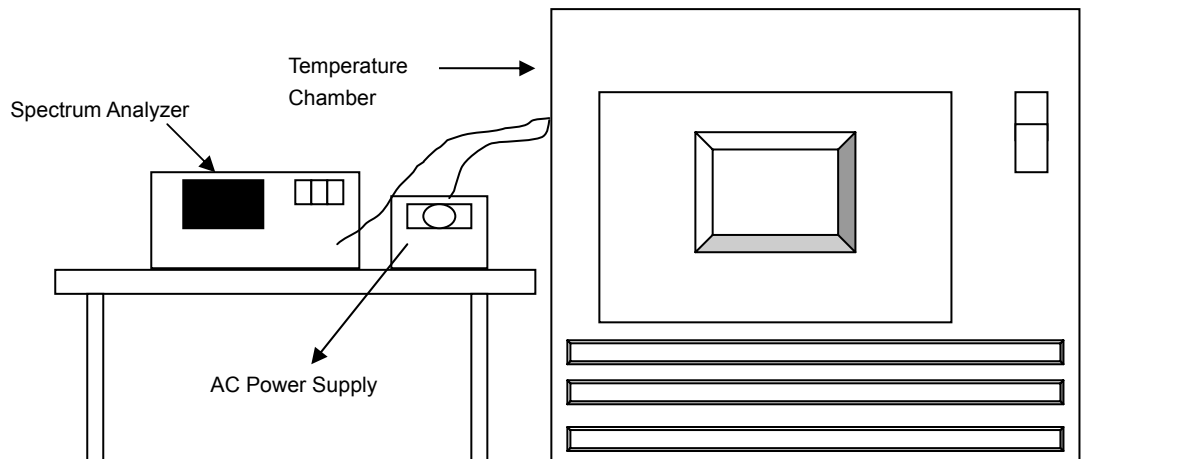

4.5.3 Test Instruments

Refer to section 4.1.2 to get information of above instrument.

4.5.4 Test Procedure

- a. The EUT was placed inside the environmental test chamber and powered by nominal AC voltage.
- b. Turn the EUT on and couple its output to a spectrum analyzer.
- c. Turn the EUT off and set the chamber to the highest temperature specified.
- d. Allow sufficient time (approximately 30 min) for the temperature of the chamber to stabilize, turn the EUT on and measure the operating frequency after 2, 5, and 10 minutes.
- e. Repeat step 2 and 3 with the temperature chamber set to the lowest temperature.
- f. The test chamber was allowed to stabilize at +20 degree C for a minimum of 30 minutes. The supply voltage was then adjusted on the EUT from 85% to 115% and the frequency record.

4.5.5 Deviation from Test Standard

No deviation.

4.5.6 EUT Operating Condition

Set the EUT transmit at un-modulation mode to test frequency stability.

4.5.7 Test Results

| Frequency Stability Versus Temp. | | | | | | | | | |
|----------------------------------|--------------------|--------------------------|---------------------|--------------------------|---------------------|--------------------------|---------------------|--------------------------|---------------------|
| Operating Frequency: 5180MHz | | | | | | | | | |
| Temp. (°C) | Power Supply (Vac) | 0 Minute | | 2 Minute | | 5 Minute | | 10 Minute | |
| | | Measured Frequency (MHz) | Frequency Drift (%) | Measured Frequency (MHz) | Frequency Drift (%) | Measured Frequency (MHz) | Frequency Drift (%) | Measured Frequency (MHz) | Frequency Drift (%) |
| 55 | 120 | 5180.0143 | 0.00028 | 5180.0128 | 0.00025 | 5180.0123 | 0.00024 | 5180.0116 | 0.00022 |
| 50 | 120 | 5179.9798 | -0.00039 | 5179.9773 | -0.00044 | 5179.9783 | -0.00042 | 5179.9791 | -0.00040 |
| 40 | 120 | 5179.9819 | -0.00035 | 5179.983 | -0.00033 | 5179.9849 | -0.00029 | 5179.9859 | -0.00027 |
| 30 | 120 | 5180.0147 | 0.00028 | 5180.0182 | 0.00035 | 5180.0148 | 0.00029 | 5180.0162 | 0.00031 |
| 20 | 120 | 5179.9978 | -0.00004 | 5179.9964 | -0.00007 | 5179.9985 | -0.00003 | 5179.997 | -0.00006 |
| 10 | 120 | 5180.0096 | 0.00019 | 5180.0103 | 0.00020 | 5180.0089 | 0.00017 | 5180.0107 | 0.00021 |
| 0 | 120 | 5179.9787 | -0.00041 | 5179.9798 | -0.00039 | 5179.9784 | -0.00042 | 5179.9778 | -0.00043 |
| -10 | 120 | 5180.0202 | 0.00039 | 5180.0161 | 0.00031 | 5180.0183 | 0.00035 | 5180.0184 | 0.00036 |
| -20 | 120 | 5179.9925 | -0.00014 | 5179.9922 | -0.00015 | 5179.996 | -0.00008 | 5179.995 | -0.00010 |

| Frequency Stability Versus Temp. | | | | | | | | | |
|----------------------------------|--------------------|--------------------------|---------------------|--------------------------|---------------------|--------------------------|---------------------|--------------------------|---------------------|
| Operating Frequency: 5180MHz | | | | | | | | | |
| Temp. (°C) | Power Supply (Vac) | 0 Minute | | 2 Minute | | 5 Minute | | 10 Minute | |
| | | Measured Frequency (MHz) | Frequency Drift (%) | Measured Frequency (MHz) | Frequency Drift (%) | Measured Frequency (MHz) | Frequency Drift (%) | Measured Frequency (MHz) | Frequency Drift (%) |
| 20 | 138 | 5179.9971 | -0.00006 | 5179.9973 | -0.00005 | 5179.9982 | -0.00003 | 5179.9968 | -0.00006 |
| | 120 | 5179.9978 | -0.00004 | 5179.9964 | -0.00007 | 5179.9985 | -0.00003 | 5179.997 | -0.00006 |
| | 102 | 5179.9971 | -0.00006 | 5179.9968 | -0.00006 | 5179.9992 | -0.00002 | 5179.9968 | -0.00006 |

4.6 6dB Bandwidth Measurement

4.6.1 Limits of 6dB Bandwidth Measurement

The minimum of 6dB Bandwidth Measurement is 0.5MHz.

4.6.2 Test Setup

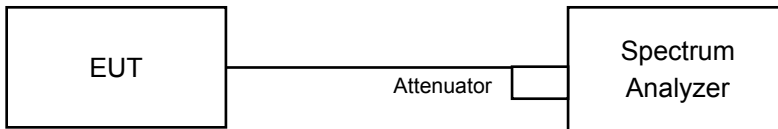

4.6.3 Test Instruments

Refer to section 4.1.2 to get information of above instrument.

4.6.4 Test Procedure

MEASUREMENT PROCEDURE REF

- Set resolution bandwidth (RBW) = 100kHz
- Set the video bandwidth (VBW) $\geq 3 \times$ RBW, Detector = Peak.
- Trace mode = max hold.
- Sweep = auto couple.
- Measure the maximum width of the emission that is constrained by the frequencies associated with the two amplitude points (upper and lower) that are attenuated by 6 dB relative to the maximum level measured in the fundamental emission

4.6.5 Deviation from Test Standard

No deviation.

4.6.6 EUT Operating Condition

The software provided by client to enable the EUT under transmission condition continuously at lowest, middle and highest channel frequencies individually.

4.6.7 Test Results

802.11a

| Channel | Frequency (MHz) | 6dB Bandwidth (MHz) | | Minimum Limit (MHz) | Pass / Fail |
|---------|-----------------|---------------------|---------|---------------------|-------------|
| | | Chain 0 | Chain 1 | | |
| 149 | 5745 | 16.49 | 16.45 | 0.5 | Pass |
| 157 | 5785 | 16.50 | 16.58 | 0.5 | Pass |
| 165 | 5825 | 16.64 | 16.54 | 0.5 | Pass |

802.11n (HT20)

| Channel | Frequency (MHz) | 6dB Bandwidth (MHz) | | Minimum Limit (MHz) | Pass / Fail |
|---------|-----------------|---------------------|---------|---------------------|-------------|
| | | Chain 0 | Chain 1 | | |
| 149 | 5745 | 17.87 | 17.87 | 0.5 | Pass |
| 157 | 5785 | 17.90 | 17.86 | 0.5 | Pass |
| 165 | 5825 | 17.74 | 17.79 | 0.5 | Pass |

802.11n (HT40)

| Channel | Frequency (MHz) | 6dB Bandwidth (MHz) | | Minimum Limit (MHz) | Pass / Fail |
|---------|-----------------|---------------------|---------|---------------------|-------------|
| | | Chain 0 | Chain 1 | | |
| 151 | 5755 | 36.56 | 36.67 | 0.5 | Pass |
| 159 | 5795 | 36.56 | 36.55 | 0.5 | Pass |

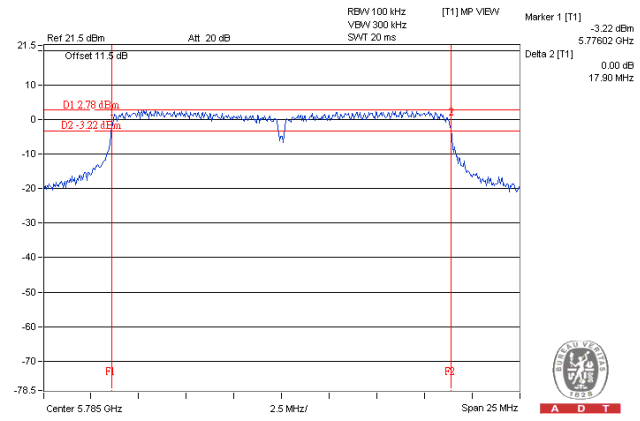
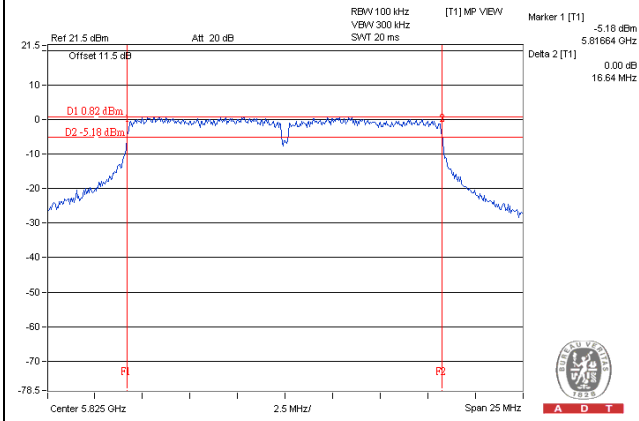
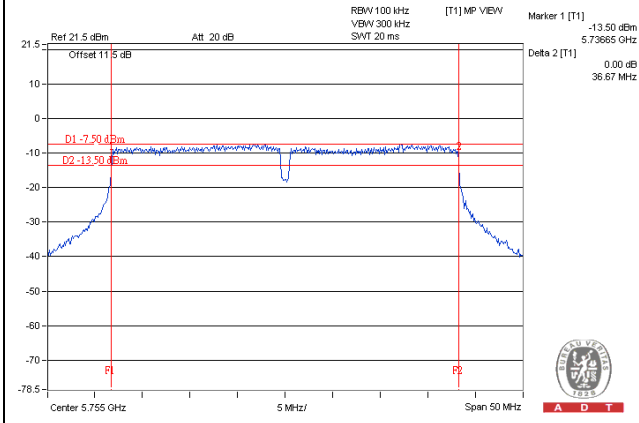
Spectrum Plot of Worst Value**802.11a****802.11n (HT20)****802.11n (HT40)**

5 Pictures of Test Arrangements

Please refer to the attached file (Test Setup Photo).

Appendix – Information on the Testing Laboratories

We, Bureau Veritas Consumer Products Services (H.K.) Ltd., Taoyuan Branch, were founded in 1988 to provide our best service in EMC, Radio, Telecom and Safety consultation. Our laboratories are accredited and approved according to ISO/IEC 17025.

If you have any comments, please feel free to contact us at the following:

Linko EMC/RF Lab

Tel: 886-2-26052180

Fax: 886-2-26051924

Hsin Chu EMC/RF Lab/Telecom Lab

Tel: 886-3-5935343

Fax: 886-3-5935342

Hwa Ya EMC/RF/Safety

Tel: 886-3-3183232

Fax: 886-3-3270892

Email: service.adt@tw.bureauveritas.com

Web Site: www.bureauveritas-adt.com

The address and road map of all our labs can be found in our web site also.

--- END ---