

# A

---

## **Cushcraft S2403B Omnidirectional Antenna**

The following pages contain specific information on the Cushcraft, Model: 2403B antenna. Included are photographs, installation documentation, and plots of the radiated spurs within the restricted band 2483.5-2500MHz for each antenna orientation.

# A

Setup photograph for radiated spurious emissions testing using the Cushcraft 2403B antenna.

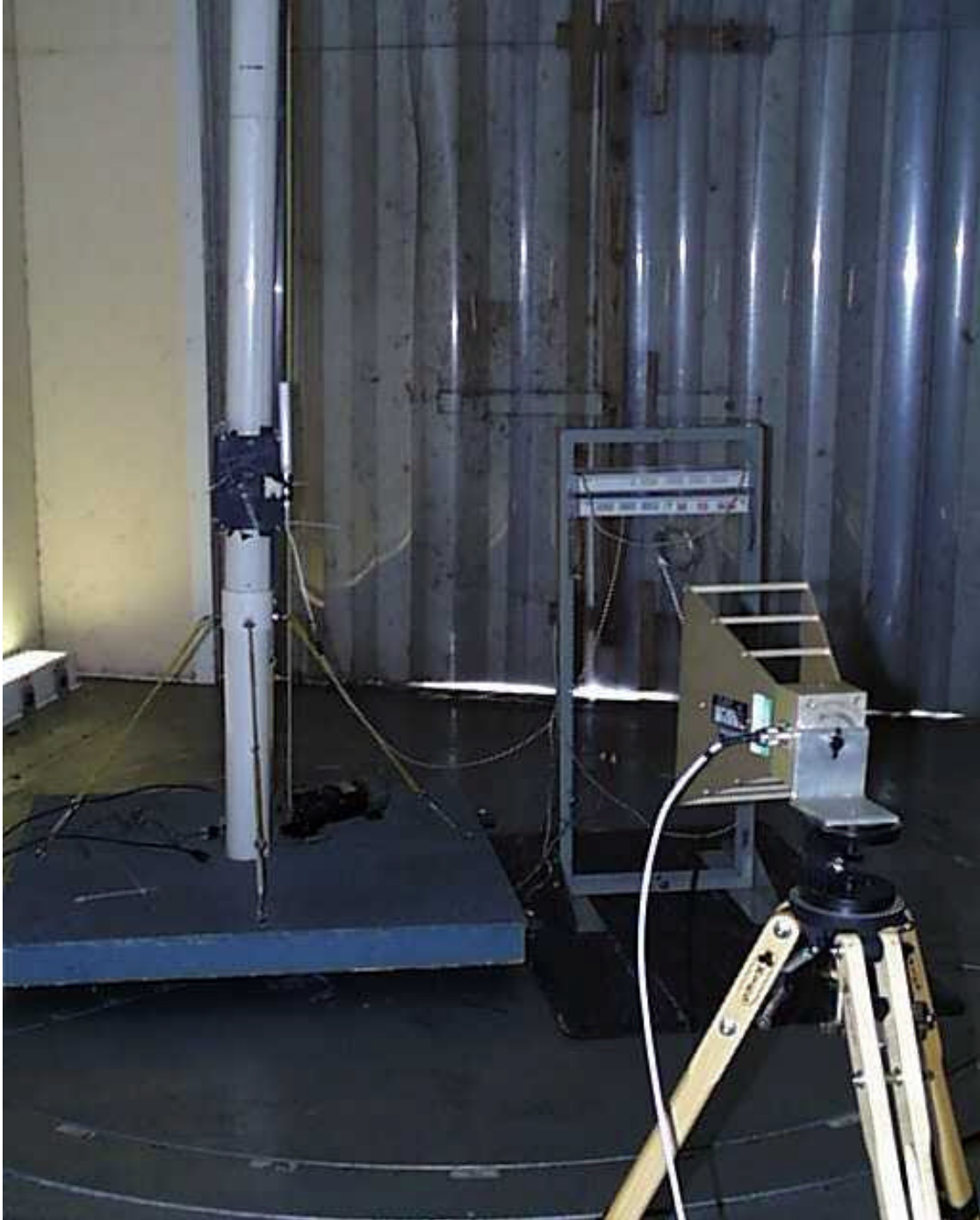

# A

Plan A

TX Antenna: 3dBd Omnidirectional antenna S2403B

0dB external attenuation; Bandpass filter installed at spectrum analyzer

Receive antenna Vertical Polarization

Receive Cable :C9

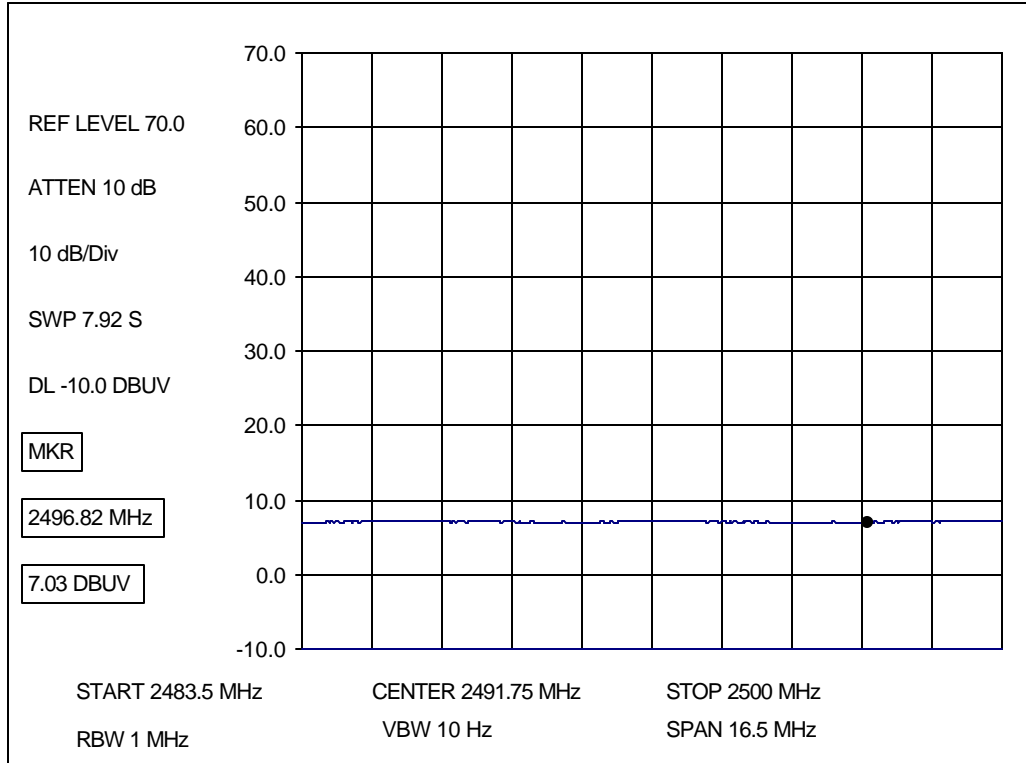

ADTRAN, Inc.

M/N: 4280TRACERT1L9-A and 4280TRACERT1L9-B

FCC ID: HDCTRACERL9

# A

Plan A

TX Antenna: 3dBd Omnidirectional antenna S2403B

0dB external attenuation; Bandpass filter installed at spectrum analyzer

Receive antenna Horizontal Polarization

Receive Cable :C9

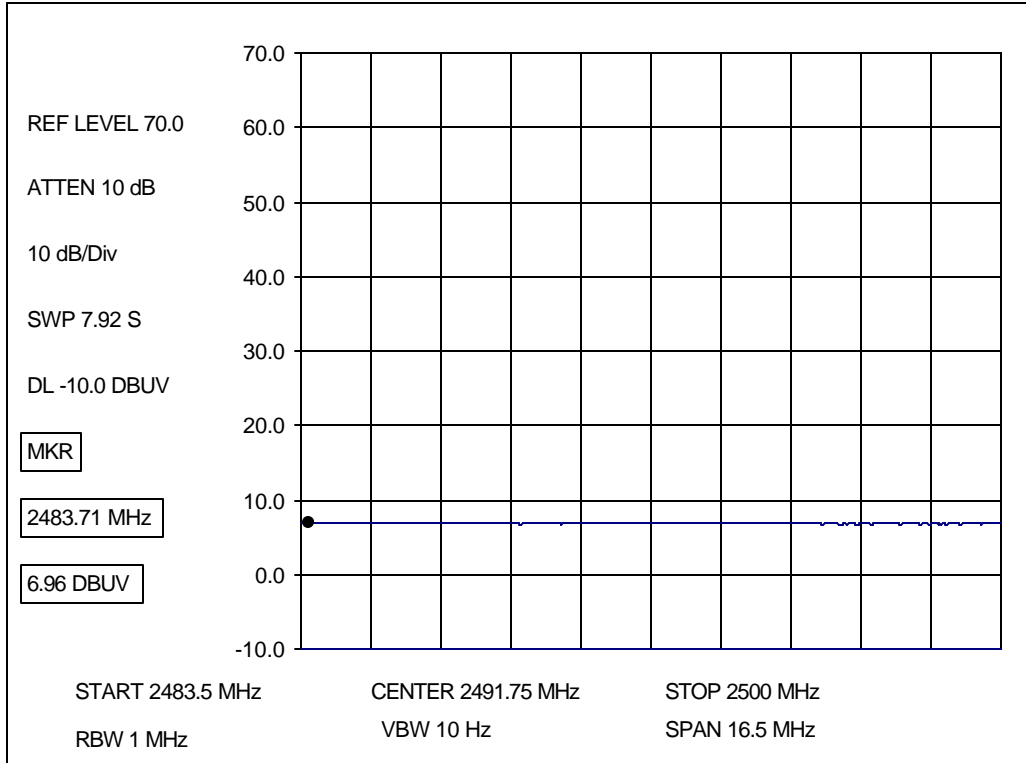

ADTRAN, Inc.

M/N: 4280TRACERT1L9-A and 4280TRACERT1L9-B

FCC ID: HDCTRACERL9

# A

Plan B

TX Antenna: 3dBd Omnidirectional antenna S2403B

0dB external attenuation; Bandpass filter installed at spectrum analyzer

Receive antenna Horizontal Polarization

Receive Cable :C9

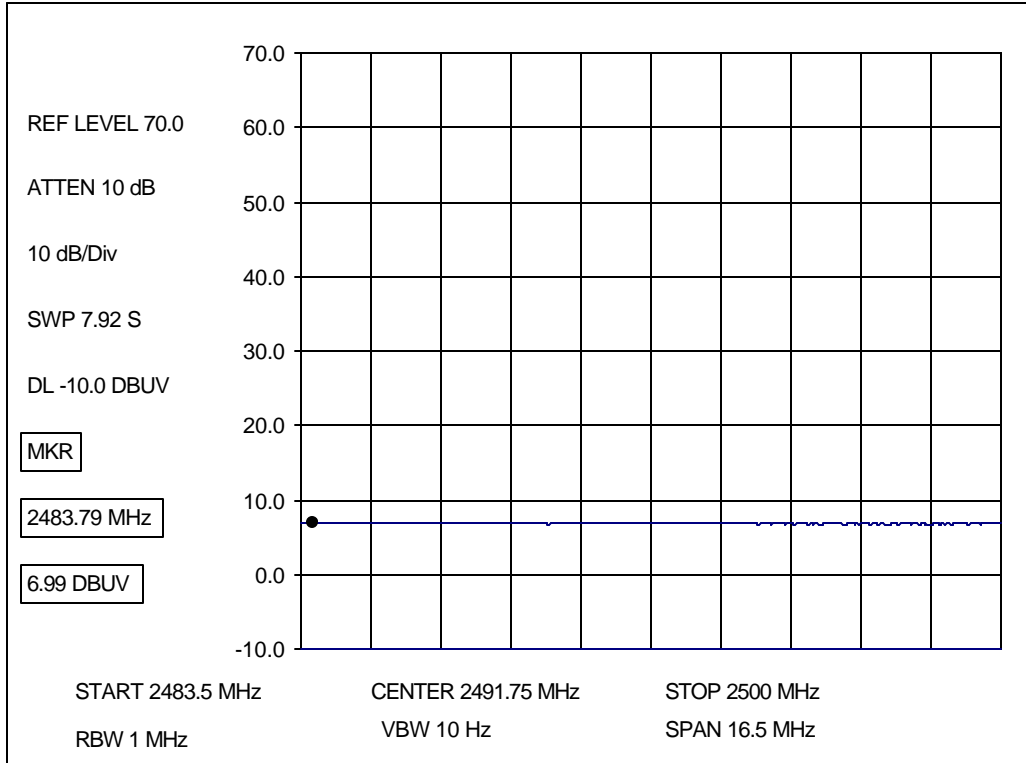

ADTRAN, Inc.

M/N: 4280TRACERT1L9-A and 4280TRACERT1L9-B

FCC ID: HDCTRACERL9

# A

Plan B

TX Antenna: 3dBd Omnidirectional antenna S2403B

0dB external attenuation; Bandpass filter installed at spectrum analyzer

Receive antenna Vertical Polarization

Receive Cable :C9

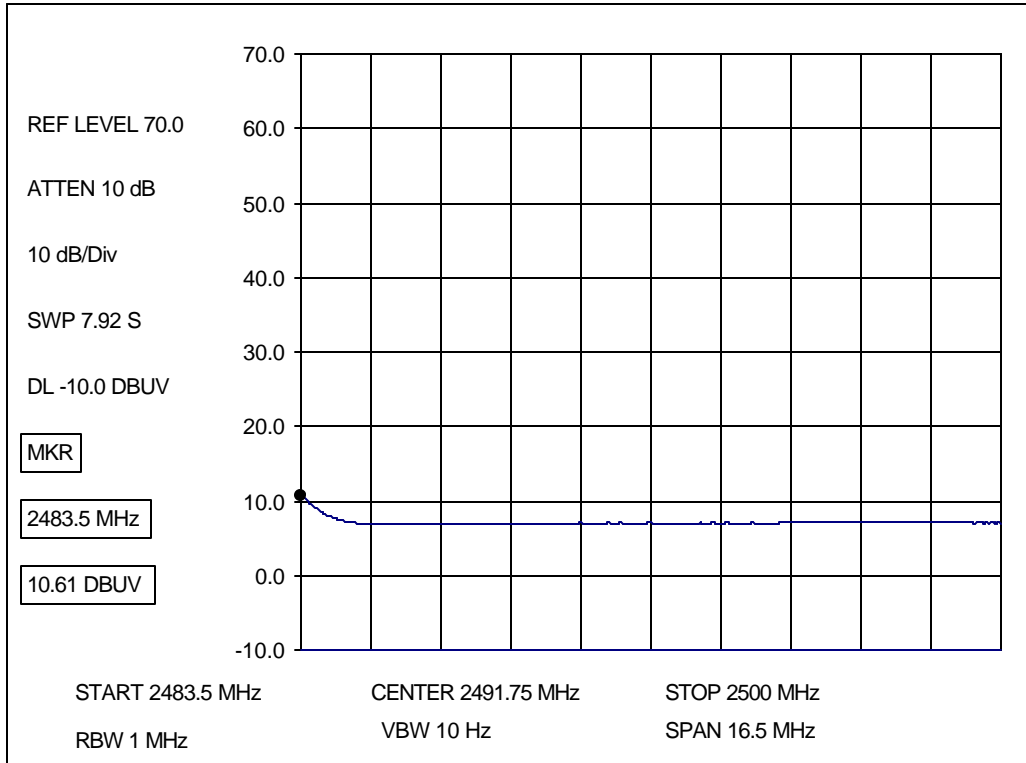

ADTRAN, Inc.

M/N: 4280TRACERT1L9-A and 4280TRACERT1L9-B

FCC ID: HDCTRACERL9

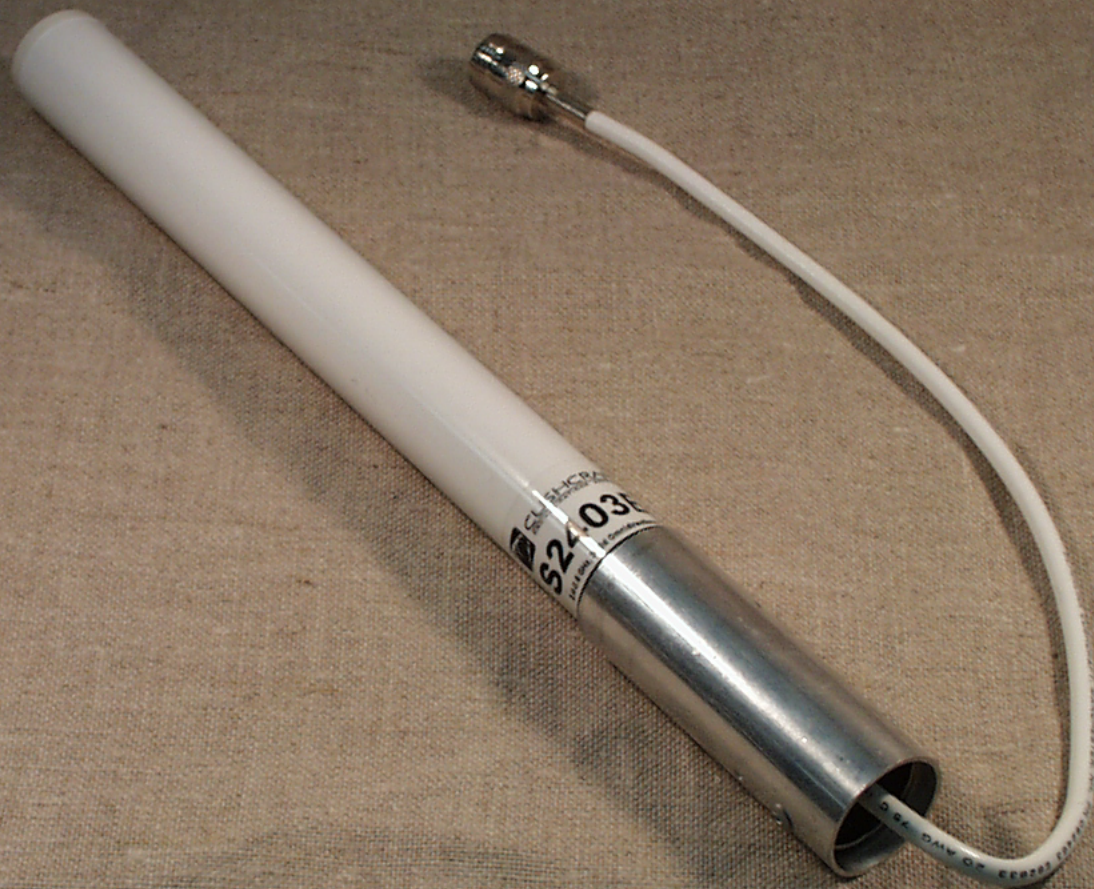

52403

# S2403BP

## 2400 MHz Antenna

### SAFETY

The antenna has been designed to attach to and hang from standard ceiling panel runners. To prevent personal injury or equipment damage, the antenna must be securely mounted per instructions.

### LOCATION

The location of the antenna is important. Objects such as metal columns, walls, etc. will reduce efficiency. Best performance is achieved when transmit and receive antennas are mounted at the same height and in a direct line of sight with no obstructions. If this is not possible and reception is poor, it's a good idea to try a few different mounting positions to optimize reception.

### MOUNTING

The hose clamp and mounting bracket provided will accommodate a 1.25 to 2 inch (3.2-5.1 cm) mast. A 1.5 inch (3.8 cm) OD or larger tubing mast should be used. Make sure that the mast does not extend above the metal base on the omni. If multiple antennas are mounted on the same mast, it is important to place this antenna at least 12 inches (30 cm) from the other to keep interaction to a minimum.

### CONNECTOR ATTACHMENT

This antenna has a pigtail feed with a female N-connector which provides great flexibility during installation. Dress the pigtail down the mast and connect it to the feedline. Then weatherproof the connectors and attach the pigtail and feedline to the mast with cable ties or tape.

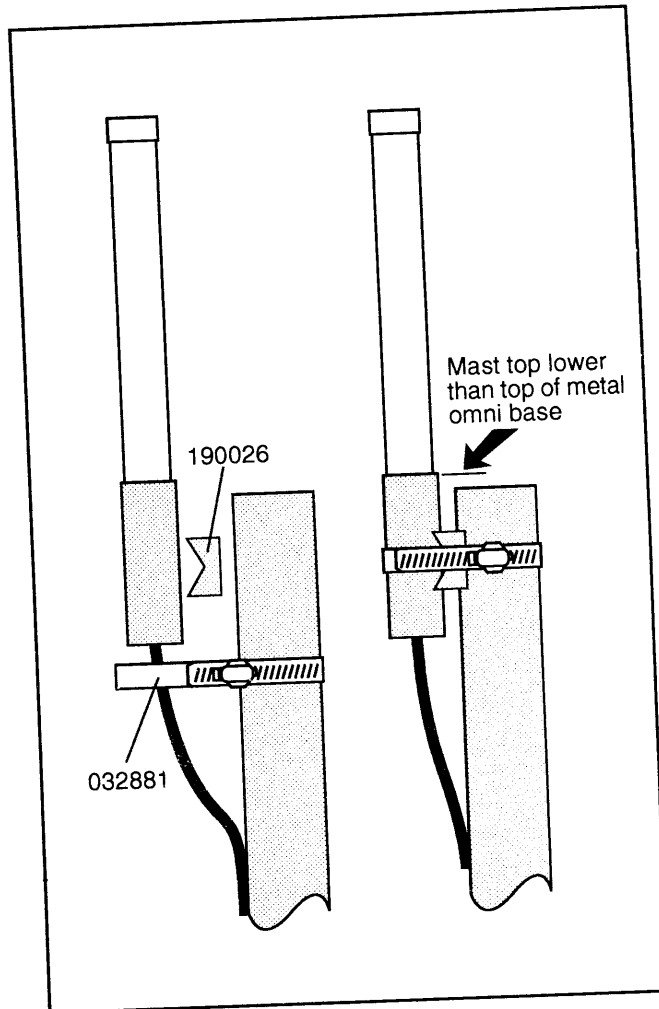

Model	S2403BP
Frequency, MHz	2400-2500
Gain, dBd	3.0
Wind Surface Area, ft <sup>2</sup> (m <sup>2</sup> )	0.122 (0.011)
Wind Survivability, mph (kph)	125 (200)
Weight, lb (kg)	0.29 (0.64)
Height, in (cm)	9 (22.9)
Nominal Impedance, Ohms	50
VSWR	1.5:1 nominal
Power handling, Watts	50
Radiating Element	Plated copper laminate
Enclosure	Polycarbonate
Feed	N
	3" (7.6 cm) UltraLink pigtail

### Limited Warranty

Cushcraft Corporation, 48 Perimeter Road, Manchester, New Hampshire 03103, warrants to the original consumer purchaser for one year from date of purchase that each Cushcraft antenna is free of defects in material or workmanship. If, in the judgement of Cushcraft, any such antenna is defective, then Cushcraft will, at its option, repair or replace the antenna at its expense within thirty days of the date the antenna is returned (at purchaser's expense) to Cushcraft or one of its authorized representatives. This warranty is in lieu of all other expressed warranties. Any implied warranty is limited in duration to one year. Cushcraft Corporation shall not be liable for any incidental or consequential damages which may result from a defect. Some states do not allow a limitation on how long an implied warranty lasts or exclusions or limitations of incidental or consequential damages, so the above limitation and exclusion may not apply to you. This warranty gives you specific legal rights, and you may also have other rights which vary from state to state. This warranty does not extend to any products which have been subject to misuse, neglect, accident or improper installation. Any repairs or alterations outside of the Cushcraft factory will nullify this warranty.



P.O. BOX 4680, MANCHESTER, NH 03018 • Phone: 603-627-7877 • Fax: 603-627-1764  
Web: <http://www.cushcraft.com> • E-mail: [hamsales@cushcraft.com](mailto:hamsales@cushcraft.com)

951467



## GENERAL INSTALLATION INSTRUCTIONS FOR MAST MOUNTED ANTENNAS

1. Assemble your new antenna on the ground at the installation site. Keep separate assembly instructions that come with it. Large CB and Amateur beams may have to be finally assembled on the tower or mast.
2. On the ground, clamp the antenna to mast and connect the coaxial cable to the antenna.
3. To insure that the mast does not fall the "wrong way" if it should get away during the installation or takedown, durable non-conductive rope should be secured at each two foot level as the mast is raised. The boss stands in a position where he can yank or pull the ropes if the need arise to deflect the falling mast away from hazards (such as power lines) into a "safe fall" (such as a yard or driveway). The ropes are tied taut at the base of the mast after installation and in place at the various levels.
4. Install selected mounting bracket.
5. If you are going to use guy wire installation instead of a mounting bracket:
  - install guy anchor bolts
  - estimate length of guy wire and cut
  - attach a mast using guy ring
6. Carefully take antenna and mast assembly to mounting bracket and insert. Tighten camp bolts. In case of guyed installation, it will be necessary to have at least a second person hold the mast upright while the guy wires are attached and tightened to the anchor bolts.
7. Install self-adhering "DANGER" label packaged in antenna hardware kit at eye level on your mast.
8. Install ground rod to drain off static electricity build-up and connect ground wire to mast and ground rod. Use special ground rods, not a spare piece of pipe.

## EXAMPLE OF ANTENNA GROUNDING AS PER NATIONAL ELECTRICAL CODE INSTRUCTIONS

1. Use No. 10 AWG copper or No. 8 AWG or larger copper-clad steel or bronze wire, as ground wires for both mast and lead-in. Securely clamp the wire to the bottom of the mast.
2. Secure lead-in wire from antenna to antenna discharge unit and mast ground wire to house with stand-off insulators spaced from 4 feet (1.2 meters) to 6 feet (1.8 meters) apart.
3. Mount antenna discharge unit as close as possible to where the lead-in wire enters the house.
4. Drill a hole in wall (CAREFUL! There are wires in that wall.) near your set just large enough to permit entry of cable.
5. Push cable through hole and form a rain drip loop close to where it enters the house.
6. Put small amount of caulking around cable where it enters house to keep out drafts.
7. Install static electricity discharge unit.
8. Connect antenna cable to the set.

You should not attempt to raise a mast in excess of 30 feet in height/length (not including the antenna proper) in a fully-extended condition. Thirty to fifty foot tubular masts must be elevated, a section at a time, with the base or outer section secured in place with guy wires. GET PROFESSIONAL HELP.

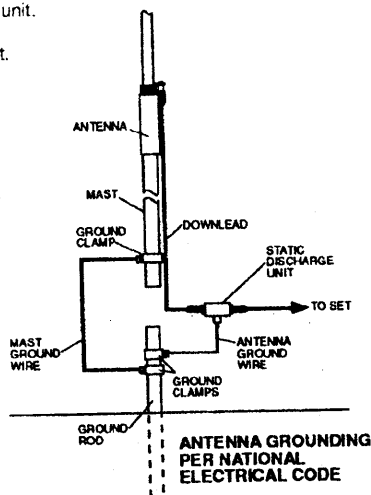

# WARNING

**INSTALLATION OF THIS PRODUCT NEAR POWER LINES IS DANGEROUS. FOR YOUR SAFETY, FOLLOW THE ENCLOSED INSTALLATION DIRECTIONS.**

## HOW TO INSTALL YOUR OUTDOOR ANTENNA SAFELY IN ACCORDANCE WITH THE RECOMMENDATIONS OF THE U.S. CONSUMER PRODUCT SAFETY COMMISSION

*These safety recommendations apply to all Cushcraft TV, amateur and general purpose communication antennas.*

### YOU, YOUR ANTENNA, AND SAFETY

Each year hundreds of people are killed, mutilated or receive severe permanent injuries when attempting to install an antenna. In many of these cases, the victim was aware of the danger of electrocution, but did not take adequate steps to avoid the hazard.

For your safety, and to help you achieve a good installation, please **READ** and **FOLLOW** the safety precautions below. **THEY MAY SAVE YOUR LIFE!**

1. If you are installing an antenna for the first time, please, for your own safety as well as others, seek **PROFESSIONAL ASSISTANCE**. Consult your dealer. He can explain which mounting method to use for the size and type antenna you are about to install.
2. Select your installation site with safety, as well as performance, in mind. (Detailed information on Site Selection appears in a separate section of this booklet.) **REMEMBER: ELECTRIC POWER LINES AND PHONE LINES LOOK ALIKE. FOR YOUR SAFETY, ASSUME THAT ANY OVERHEAD LINES CAN KILL YOU.**
3. Call your electric power company. Tell them your plans and ask them to come look at your proposed installation. This is a small inconvenience considering **YOUR LIFE IS AT STAKE**.
4. Plan your installation procedure carefully and completely *before* you begin. Successful raising of a mast or tower is largely a matter of coordination. Each person should be assigned to a specific task, and should know what to do and when to do it. One person should be designated as the "boss" of the operation to call out instructions and watch for signs of trouble.
5. When installing your antenna, **REMEMBER: DO NOT** use a metal ladder. **DO NOT** work on a wet or windy day. **DO** dress properly—shoes with rubber soles and heels, rubber gloves, long sleeve shirt or jacket.
6. If the assembly starts to drop, get away from it and let it fall. Remember, the antenna, mast, cable and metal guy wires are all excellent conductors of electrical current. Even the slightest touch of any of these parts to a power line complete an electrical path through the antenna and the installer—**THAT'S YOU!**
7. If any part of the antenna system should come in contact with a power line—**DON'T TOUCH IT OR TRY TO REMOVE IT YOURSELF. CALL YOUR LOCAL POWER COMPANY.** They will remove it safely.

If an accident should occur with the power lines call for qualified emergency help immediately.



**CUSHCRAFT**  
CORPORATION

P.O. BOX 4680, MANCHESTER, NH 03108

## SITE SELECTION

Before attempting to install your antenna, think where you can best place your antenna for **safety** and **performance**.

To determine a safe distance from wires, power lines and trees:

1. Measure the height of your antenna.
2. Add this length to the length of your tower or mast, and then
3. Double this total for the minimum recommended safe distance.

If you are unable to maintain this safe distance, **STOP! GET PROFESSIONAL HELP**. Many antennas are supported by pipe masts attached to the chimney, roof or side of the house. Generally, the higher the antenna is above the ground, the better it performs. Good practice is to install your antenna about 5 to 10 feet above the roof line and away from power lines and obstructions. Remember that FCC limits your antenna height to 60 feet. If possible, find a mounting place directly above your set, where the antenna wire can take a short, vertical drop on the outside of the house for entry through a wall or window near the set. Your dealer carries a complete line of installation hardware.

AVOID THIS LOCATION

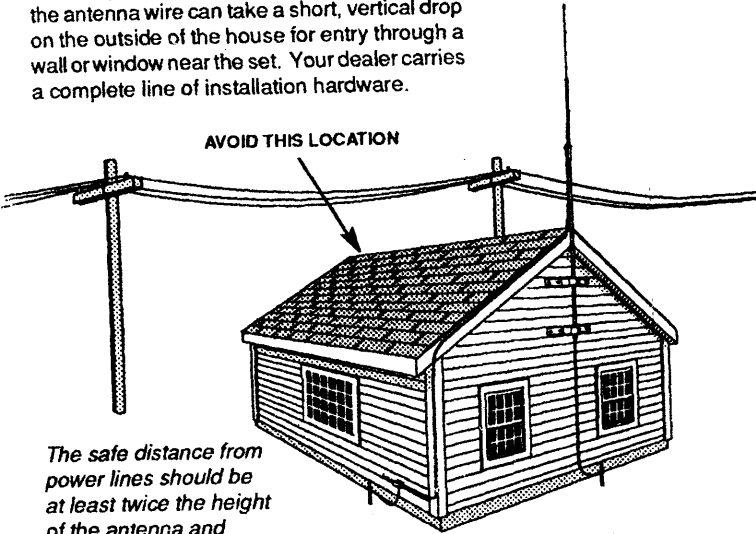

The safe distance from power lines should be at least twice the height of the antenna and mast combined.

## CHOOSE A PROPER SUPPORT AND MOUNTING METHOD

However you decide to mount and support your antenna always make sure that safety is your first concern. Some of the more common installation methods are illustrated below.

### ROOF MOUNTED

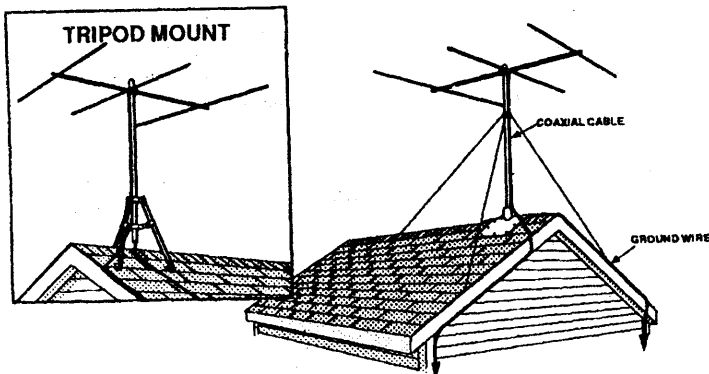

### ROOF MOUNTING

The swivel feature of "universal" type mounting brackets makes a convenient antenna mount for flat or peaked roofs. One clamp type bracket is used with 3 or 4 guy wires equally spaced around the mast and anchored to the roof or eaves by eyebolts. Apply roofing compound around the base of the bracket, screws and eyebolts for moisture sealing.

## TELESCOPING MAST

Guy wires should be equally spaced in at least three directions. Use at least three guy wires for each 10 foot section of mast.

## SIDE OF HOUSE MOUNTING

The safe distance from power lines is at least twice the height of antenna and mast combined. Where roof overhang is not excessive, the side of the house provides a convenient mounting. Position the brackets over a stud if possible, one above the other, and space two or three feet apart. For metal siding, first mark mounting holes, then drill pilot holes through the siding to accept mounting screws.

## TOWER

Tower safety is paramount to a good installation and requires that you take location, tree growth, soil depth and proximity to buildings into consideration. Tower foundations must be securely based on a solid concrete/ tower mounting plate. An alternative is to sink a 4-6 foot section of tower into a concrete base for an extremely rugged mount. Proper guying is essential to a safe weather-resistant installation that must handle severe wind loading and is best accomplished with preformed guy grips, torque brackets and turnbuckles. When working on towers always use a safety belt made of high quality web-type material

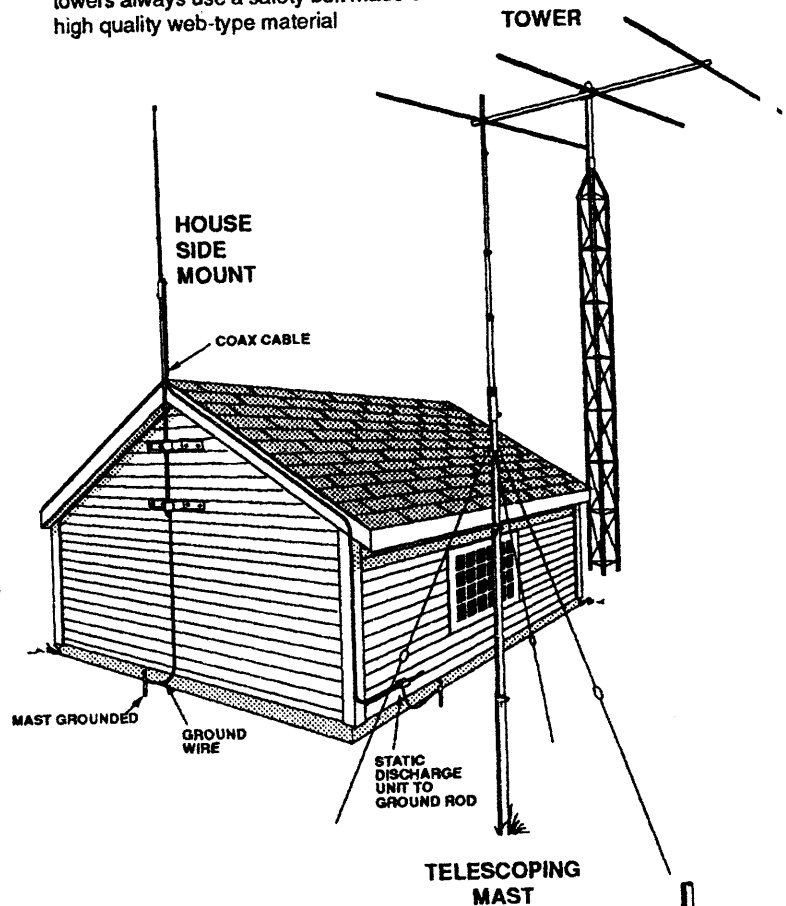

## CHIMNEY MOUNTING

The chimney is often an easy and convenient mounting place. But the chimney must be strong enough to support the antenna in high winds. Do not use a chimney that has loose bricks or mortar. A good chimney mount makes use of a 5 or 10 foot, 1-1/4" diameter steel mast, and a heavy duty two strap clamp-type bracket. Install the upper bracket just below the top course of bricks, and the lower bracket two or three feet below the upper bracket. For maximum strength, space the brackets as far apart as possible.

