

Prüfbericht-Nr.: <i>Test report no.:</i>	CN22MB93 (P15E-WiFi) 001	Auftrags-Nr.: <i>Order no.:</i>	238547861	Seite 1 von 36 Page 1 of 36
Kunden-Referenz-Nr.: <i>Client reference no.:</i>	N/A	Auftragsdatum: <i>Order date:</i>	2022-09-14	
Auftraggeber: <i>Client:</i>	Adtran Inc 901 Explorer Blvd. Huntsville			
Prüfgegenstand: <i>Test item:</i>	2x2 AX Dual-band AP			
Bezeichnung / Typ-Nr.: <i>Identification / Type no.:</i>	BSAP 6020			
Auftrags-Inhalt: <i>Order content:</i>	FCC Part 15E Test report (WiFi 5GHz)			
Prüfgrundlage: <i>Test specification:</i>	FCC 47CFR Part 15: Subpart E Section 15.407			
Wareneingangsdatum: <i>Date of sample receipt:</i>	2022-09-16			
Prüfmuster-Nr.: <i>Test sample no.:</i>	A003337100-001			
Prüfzeitraum: <i>Testing period:</i>	2022-10-25 - 2022-11-12			
Ort der Prüfung: <i>Place of testing:</i>	EMC/RF Taipei Testing Site			
Prüflaboratorium: <i>Testing laboratory:</i>	Taipei Testing Laboratories			
Prüfergebnis*: <i>Test result*:</i>	Pass			
überprüft von: <i>compiled by:</i>	genehmigt von: <i>authorized by:</i>			
Datum: <i>Date:</i> 2023-02-18	 Ethan Shao	Ausstellungsdatum: <i>Issue date:</i> 2023-02-18	 Brenda Chen	
Stellung / Position:	Assistant Project Engineer	Stellung / Position:	Senior Project Manager	
Sonstiges / Other:				
Zustand des Prüfgegenstandes bei Anlieferung: <i>Condition of the test item at delivery:</i>		Prüfmuster vollständig und unbeschädigt <i>Test item complete and undamaged</i>		
* Legende:	1 = sehr gut P(ass) = entspricht o.g. Prüfgrundlage(n)	2 = gut F(ail) = entspricht nicht o.g. Prüfgrundlage(n)	3 = befriedigend N/A = nicht anwendbar	4 = ausreichend N/T = nicht getestet
* Legend:	1 = very good P(ass) = passed a.m. test specification(s)	2 = good F(ail) = failed a.m. test specification(s)	3 = satisfactory N/A = not applicable	4 = sufficient N/T = not tested
<p>Dieser Prüfbericht bezieht sich nur auf das o.g. Prüfmuster und darf ohne Genehmigung der Prüfstelle nicht auszugsweise vervielfältigt werden. Dieser Bericht berechtigt nicht zur Verwendung eines Prüfzeichens. <i>This test report only relates to the a. m. test sample. Without permission of the test center this test report is not permitted to be duplicated in extracts. This test report does not entitle to carry any test mark.</i></p>				

TEST SUMMARY

Report Section	FCC Clause	Test Item	Result
5.1.1	15.407(a) & 15.203	Antenna Requirement	Pass
5.1.2	15.407(a)	Maximum Conducted Output Power	Pass
-	15.407(h)(1)	Transmit Power Control (TPC)	N/A
5.1.4	15.407(a)	26 dB Bandwidth	Pass
5.1.4	2.1049	99% Occupied Bandwidth	Pass
5.1.5	15.407(e)	6 dB Bandwidth (U-NII-3 Band only)	Pass
5.1.6	15.407(g)	Frequency Stability	Pass
5.1.7	15.407(a)	Power Spectral Density	Pass
5.1.8	15.407(b) & 15.205 & 15.209	Radiated Spurious Emissions and Band Edges	Pass
-	15.407(h) & KDB 905462 D02	Dynamic Frequency Selection	N/A
5.2.1	15.207	Mains Conducted Emission	Pass

Note: Determining compliance based on the results of the compliance measurement, not taking into account measurement instrumentation uncertainty.

Contents

HISTORY OF THIS TEST REPORT	5
1. GENERAL REMARKS	6
1.1 COMPLEMENTARY MATERIALS.....	6
1.2 DECISION RULE OF CONFORMITY	6
2. TEST SITES	7
2.1 TEST LABORATORY	7
2.2 TEST FACILITY.....	7
2.3 TRACEABILITY	8
2.4 CALIBRATION	8
2.5 MEASUREMENT UNCERTAINTY	8
3. GENERAL PRODUCT INFORMATION.....	9
3.1 PRODUCT FUNCTION AND INTENDED USE	9
3.2 SYSTEM DETAILS AND RATINGS.....	9
3.3 NOISE GENERATING AND NOISE SUPPRESSING PARTS	10
3.4 SUBMITTED DOCUMENTS.....	10
4. TEST SET-UP AND OPERATION MODES.....	11
4.1 PRINCIPLE OF CONFIGURATION SELECTION	11
4.2 CARRIER FREQUENCY AND CHANNEL.....	11
4.3 TEST OPERATION AND TEST SOFTWARE.....	12
4.4 SPECIAL ACCESSORIES AND AUXILIARY EQUIPMENT	15
4.5 TEST SETUP DIAGRAM	16
4.6 DUTY CYCLE OF TEST SIGNAL	17
5. TEST RESULTS	18
5.1 TRANSMITTER REQUIREMENT & TEST SUITES.....	18
5.1.1 <i>Antenna Requirement</i>	<i>18</i>
5.1.2 <i>Maximum Conducted Output Power</i>	<i>19</i>
5.1.4 <i>26 dB Bandwidth and 99% Occupied Bandwidth.....</i>	<i>24</i>
5.1.5 <i>6 dB Bandwidth (5725-5850MHz).....</i>	<i>25</i>
5.1.6 <i>Frequency Stability Measurement.....</i>	<i>26</i>
5.1.7 <i>Power Spectral Density.....</i>	<i>28</i>
5.1.8 <i>Radiated Spurious Emissions</i>	<i>30</i>
5.2 MAINS EMISSION	35
5.2.1 <i>Mains Conducted Emission.....</i>	<i>35</i>

Prüfbericht - Nr.: CN22MB93 (P15E-WiFi) 001
Test Report No.

Seite 4 von 36
Page 4 of 36

APPENDIX A - TEST RESULT OF CONDUCTED

APPENDIX B - TEST RESULT OF RADIATED EMISSIONS & MAINS CONDUCTED EMISSION

APPENDIX SP - PHOTOGRAPHS OF TEST SETUP

APPENDIX EP - PHOTOGRAPHS OF EUT

Prüfbericht - Nr.: CN22MB93 (P15E-WiFi) 001
Test Report No.

Seite 5 von 36
Page 5 of 36

HISTORY OF THIS TEST REPORT

Report No.	Description	Date Issued
CN22MB93 (P15E-WiFi) 001	Original Release	2023-02-18

1. General Remarks

1.1 Complementary Materials

All attachments are integral parts of this test report. This applies especially to the following appendix:

Appendix A - Test Result of Conducted

Appendix B - Test Result of Radiated Emissions & Mains Conducted Emission

Appendix SP - Photographs of Test Setup

Appendix EP - Photographs of EUT

Applied Standard and Test Levels

Radio
FCC 47CFR Part 15: Subpart E Section 15.407
FCC 47CFR Part 2: Subpart J Section 2.1049
ANSI C63.10:2013
KDB 789033 D02 General UNII Test Procedures New Rules v02r01
KDB 662911 D01 Multiple Transmitter Output v02r01

1.2 Decision Rule of Conformity

The decision rule of conformity of this test report is following the requirements of the requested standard in the quotation, and agreed among testing laboratory and manufacturer (applicant) to exclude the consideration of Measurement Uncertainty, unless it is required by the specific standard.

2. Test Sites

2.1 Test Laboratory

Taipei Testing Laboratories

11F. No.758, Sec. 4, Bade Rd., Songshan Dist.
Taipei City 105
Taiwan (R.O.C.)

2.2 Test Facility

Taipei Testing Laboratories

No.458-18, Sec. 2, Fenliao Rd., Linkou Dist.,
New Taipei City 244
Taiwan (R.O.C.)
FCC Registration No.: 180491
ISED Registration No.: 25563

2.3 Traceability

All measurement equipment calibrations are traceable to NML(Taiwan)/NIST(USA) or where calibration is performed outside Taiwan, to equivalent nationally recognized standards organizations.

2.4 Calibration

Equipment requiring calibration is calibrated periodically in a suitably accredited Calibration Lab. Additionally all equipment is verified for proper performance on a regular basis using in house standards or comparisons.

2.5 Measurement Uncertainty

All measurement uncertainty values are shown with a coverage factor of $k=2$ to indicate a 95% level of confidence.

Emission Measurement Uncertainty

Parameter	Uncertainty
Radiated Emission (9 kHz ~ 30 MHz)	± 1.15 dB
Radiated Emission (30 MHz ~ 200 MHz)	± 1.30 dB
Radiated Emission (200 MHz ~ 1 GHz)	± 1.30 dB
Radiated Emission (1 GHz ~ 18 GHz)	± 1.54 dB
Radiated Emission (18 GHz ~ 40 GHz)	± 2.52 dB
Mains Conducted Emission	± 1.65 dB

3. General Product Information

3.1 Product Function and Intended Use

The EUT is a 2x2 AX Dual-band AP. It contains a WLAN compatible module enabling the user to communicate data through a Wireless interface.

For details refer to the User Guide, Data Sheet and Circuit Diagram.

3.2 System Details and Ratings

Basic Information of EUT

Item	EUT information
Kind of Equipment/Test Item	2x2 AX Dual-band AP
Type Identification	BSAP 6020
FCC ID	HDCBSAP6020

Technical Specification of EUT

Item	EUT information	
Operating Frequency	Band 1: 5180 MHz ~ 5240 MHz Band 4: 5745 MHz ~ 5825 MHz	
Channel Number	Band 1: 4 for 802.11a, 802.11n HT20, 802.11ac VHT20, 802.11ax HE20 2 for 802.11n HT40, 802.11ac VHT40, 802.11ax HE40 1 for 802.11ac VHT80, 802.11ax HE80 Band 4: 5 for 802.11a, 802.11n HT20, 802.11ac VHT20, 802.11ax HE20 2 802.11n HT40, 802.11ac VHT40, 802.11ax HE40 1 for 802.11ac VHT80, 802.11ax HE80	
Data Rate	802.11a: 54.0 / 48.0 / 36.0 / 24.0 / 18.0 / 12.0 / 9.0 / 6.0 Mbps 802.11n: up to MCS7 802.11ac: up to MCS9 802.11ax: up to MCS11	
Operation Voltage	12 Vdc (Adapter) 54 Vdc (POE Injector)	
Modulation	OFDM (BPSK, QPSK, 16QAM, 64QAM, 256QAM) OFDMA (1024QAM)	
Maximum Output Power (mW)	CDD Mode	5180 ~ 5240 MHz: 423.81 5745 ~ 5825 MHz: 447.89
	Beamforming Mode	5180 ~ 5240 MHz: 205.67 5745 ~ 5825 MHz: 223.96
Antenna Information	Refer to 5.1.1	
Accessory Device	Refer to 4.4	

3.3 Noise Generating and Noise Suppressing Parts

Refer to the Circuit Diagram.

3.4 Submitted Documents

- Circuit Diagram
- Instruction Manual
- Rating Label
- Technical Description

4. Test Set-up and Operation Modes

4.1 Principle of Configuration Selection

The test modes were adapted accordingly in reference to the instructions for use.

During testing, Channel and Power Controlling Software provided by the customer was used to control the operating channel as well as the output power level. The RF output power selection is for the setting of RF output expected by the customer and is going to be fixed on the firmware of the final end product.

4.2 Carrier Frequency and Channel

Band	Channel	Frequency (MHz)	802.11a 802.11n HT20 802.11ac VHT20 802.11ax HE20	802.11n HT40 802.11ac VHT40 802.11ax HE40	802.11ac VHT80 802.11ax HE80
U-NII-1 (Band 1)	36	5180	V		
	38	5190		V	
	40	5200	V		
	42	5210			V
	44	5220	V		
	46	5230		V	
	48	5240	V		
U-NII-3 (Band 4)	149	5745	V		
	151	5755		V	
	153	5765	V		
	155	5775			V
	157	5785	V		
	159	5795		V	
	161	5805	V		
	165	5825	V		

4.3 Test Operation and Test Software

Setup for testing: Test samples are provided with a LAN interface which makes it possible to control them through a test software installed on a notebook computer.

This software was running on the laptop computer connected to the EUT. It was used to enable the operation modes listed as below.

Test Software	QSPR
---------------	------

The samples were used as follows:
A003337100-001

Full test was applied on all test modes, but only worst case was shown.

The EUT incorporates a MIMO function. Physically, the EUT provides two completed transmitters and receivers.

Modulation Mode	Tx Function
802.11a	2TX (MIMO)
802.11n HT20	2TX (MIMO)
802.11n HT40	2TX (MIMO)
802.11ac VHT20	2TX (MIMO)
802.11ac VHT40	2TX (MIMO)
802.11ac VHT80	2TX (MIMO)
802.11ax HE20	2TX (MIMO)
802.11ax HE40	2TX (MIMO)
802.11ax HE80	2TX (MIMO)

* The modulation and bandwidth are similar for 802.11n mode HT20/HT40 and 802.11ac mode VHT20/VHT40 and 802.11ax mode HE20/HE40, therefore investigated worse case as representative mode in test report.

** For Beamforming mode, only the output power is evaluated and presented in this report.

EUT Configure Mode	Applicable To				Description
	Antenna Port Conducted Measurement	Radiated Spurious Emissions above 1 GHz	Radiated Spurious Emissions below 1 GHz	Mains Conducted Emission	
-	√	√	√	√	-

Note:

1. The EUT had been pre-tested on the positioned of each 3 axis. The worst case was found when position on **Z-plane**.
2. "-" means no effect.

Antenna Port Conducted Measurement

- Pre-Scan full test was applied on all test modes, but only worst case was shown.
- Following channel(s) was (were) selected for the final test as listed below.

EUT Configure Mode	Mode	Frequency (MHz)	Available Channel	Tested Channel	Date Rate (Mbps)
CDD	802.11a	5180-5240	36 to 48	36, 40, 48	6.0
		5745-5825	149 to 165	149, 157, 165	
	802.11n HT20	5180-5240	36 to 48	36, 40, 48	MCS0
		5745-5825	149 to 165	149, 157, 165	
	802.11n HT40	5180-5240	38 to 46	38, 46	MCS0
		5745-5825	151 to 159	151, 159	
	802.11ac VHT20	5180-5240	36 to 48	36, 40, 48	NSS1 MCS0
		5745-5825	149 to 165	149, 157, 165	
	802.11ac VHT40	5180-5240	38 to 46	38, 46	NSS1 MCS0
		5745-5825	151 to 159	151, 159	
	802.11ac VHT80	5180-5240	42	42	NSS1 MCS0
		5745-5825	155	155	
	802.11ax HE20	5180-5240	36 to 48	36, 40, 48	NSS1 MCS0
		5745-5825	149 to 165	149, 157, 165	
	802.11ax HE40	5180-5240	38 to 46	38, 46	NSS1 MCS0
		5745-5825	151 to 159	151, 159	
	802.11ax HE80	5180-5240	42	42	NSS1 MCS0
		5745-5825	155	155	
Beamforming (Power only)	802.11ac VHT20	5180-5240	36 to 48	36, 40, 48	NSS1 MCS0
		5745-5825	149 to 165	149, 157, 165	
	802.11ac VHT40	5180-5240	38 to 46	38, 46	NSS1 MCS0
		5745-5825	151 to 159	151, 159	
	802.11ac VHT80	5180-5240	42	42	NSS1 MCS0
		5745-5825	155	155	
	802.11ax HE20	5180-5240	36 to 48	36, 40, 48	NSS1 MCS0
		5745-5825	149 to 165	149, 157, 165	
	802.11ax HE40	5180-5240	38 to 46	38, 46	NSS1 MCS0
		5745-5825	151 to 159	151, 159	
	802.11ax HE80	5180-5240	42	42	NSS1 MCS0
		5745-5825	155	155	

Radiated Spurious Emissions (Above 1 GHz)

- Pre-Scan full test was applied on all test modes, but only worst case was shown.
 Following channel(s) was (were) selected for the final test as listed below.

EUT Configure Mode	Mode	Frequency (MHz)	Available Channel	Tested Channel	Date Rate (Mbps)
-	802.11a	5180-5240	36 to 48	36, 40, 48	6.0
-		5745-5825	149 to 165	149, 157, 165	
-	802.11ax HE20	5180-5240	36 to 48	36, 40, 48	NSS1 MCS0
-		5745-5825	149 to 165	149, 157, 165	
-	802.11ax HE40	5180-5240	38 to 46	38, 46	NSS1 MCS0
-		5745-5825	151 to 159	151, 159	
-	802.11ax HE80	5180-5240	42	42	NSS1 MCS0
-		5745-5825	155	155	

Radiated Spurious Emissions (Below 1 GHz)

- Pre-Scan full test was applied on all test modes, but only worst case was shown.
 Following channel(s) was (were) selected for the final test as listed below.

EUT Configure Mode	Mode	Frequency (MHz)	Available Channel	Tested Channel	Date Rate (Mbps)
-	802.11ax HE20	5745-5825	149 to 165	157	NSS1 MCS0

Mains Conducted Emission Test

- Pre-Scan full test was applied on all test modes, but only worst case was shown.
 Following channel(s) was (were) selected for the final test as listed below.

EUT Configure Mode	Mode
-	WLAN 2.4GHz + WLAN 5GHz

Test Condition

Test Item	Ambient Temperature	Relative Humidity	Tested by
Conducted Measurement	21.5 °C	59 %	Nick Guan
Radiated Spurious Emissions above 1 GHz	23.1-24.8 °C	60-63 %	Ivan Chiang
Radiated Spurious Emissions below 1 GHz	23.1-24.8 °C	60-63 %	Ivan Chiang
Mains Conducted Emission	20 °C	51 %	Ray Huang

4.4 Special Accessories and Auxiliary Equipment

The product has been tested together with the following additional accessories:

Accessory of EUT

None

Support Unit

Support Unit								
No	Description	Brand	Model	S/N	Shielded	Ferrite Core (Qty)	Length (cm)	Remark
A	Adapter	Emplus	PA1024-120HUB200	N/A	NO	NO	100	Radiated
1	RJ 45	TUV	TUV-01	N/A	-	-	-	
2	Notebook	Lenovo	81BL	MP1DCD6Y	-	-	-	
A	Adapter	Emplus	PA1024-120HUB200	N/A	NO	NO	100	Mains Conducted
1	Notebook	Lenovo	81BL	MP1DCD6Y	-	-	-	
2	LAN Cable	TUV	TUV-001	NO	NO	NO	300	

4.5 Test Setup Diagram

<Radiated Spurious Emissions mode>

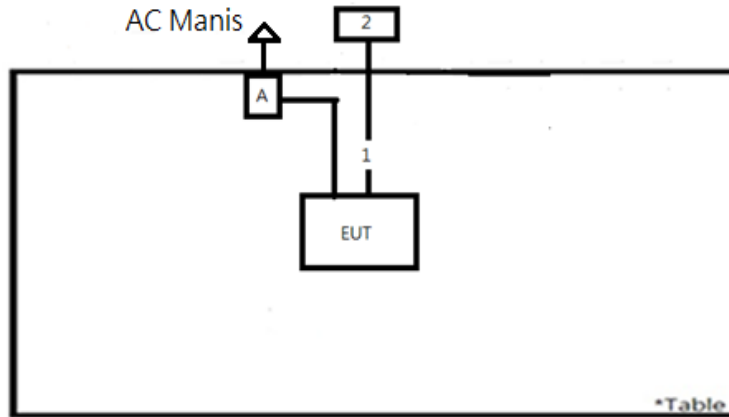

<Mains Conducted Emission mode>

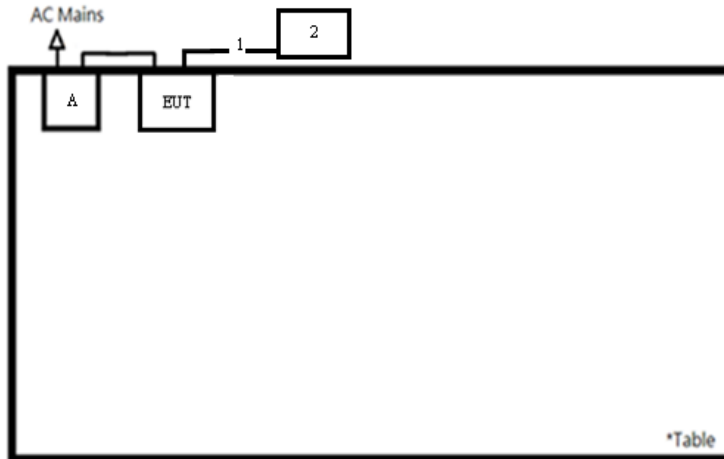

4.6 Duty Cycle of Test Signal

Mode	On + Off Time (ms)	On Time (ms)	Duty Cycle (%)	Duty Factor (dB)
802.11a	2.13	1.98	92.94	0.32
802.11ax HE20	5.70	5.43	95.26	0.21
802.11ax HE40	5.76	5.40	93.66	0.28
802.11ax HE80	5.75	5.40	93.99	0.27

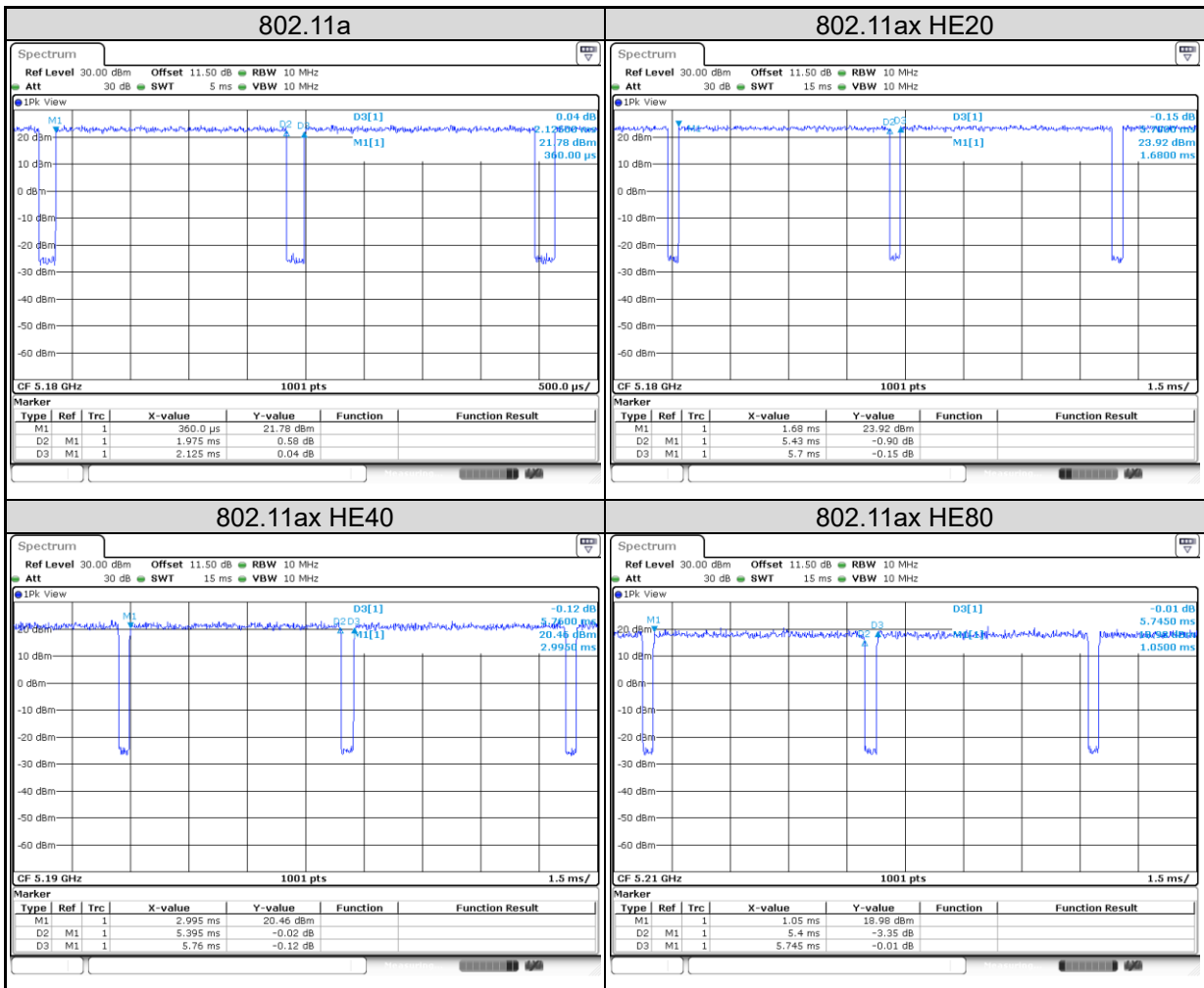

5. Test Results

5.1 Transmitter Requirement & Test Suites

5.1.1 Antenna Requirement

Requirement Use of approved antennas only

According to the manufacturer declaration, the EUT's antenna specifications are described as below. The antenna is used with no possibility of replacement with a non-approved antenna by the end-user. Therefore, the EUT is considered to comply with this provision.

ANT		Gain (dBi)		Antenna Type
		Band 1	Band 4	
1		4.3	5.1	PIFA
2		4.7	4.8	PIFA
Max Peak Gain		4.7	5.1	-
CDD Mode	Power Directional Gain	4.7	5.1	-
	PSD Directional Gain	7.51	7.96	-
Beamforming Mode	Power Directional Gain	7.51	7.96	-
	PSD Directional Gain	7.51	7.96	-

Note: PSD Directional Gain = $10\log[(10^{G1/20} + 10^{G2/20} + \dots + 10^{GN/20})^2 / N_{ANT}]$

Refer to EUT photo for details.

5.1.2 Maximum Conducted Output Power

Limit

Operation Band	EUT Category	Limit
U-NII-1	Outdoor Access Point	1 Watt (30 dBm) (Max. e.i.r.p \leq 125 mW (21 dBm) at any elevation angle above 30 degrees as measured from the horizon)
	Fixed point-to-point Access Point	1 Watt (30 dBm)
	Indoor Access Point	1 Watt (30 dBm)
	Mobile and Portable client device	250 mW (24 dBm)
U-NII-2A	---	250 mW (24 dBm) or 11 dBm + 10 log B*
U-NII-2C	---	250 mW (24 dBm) or 11 dBm + 10 log B*
U-NII-3	---	1 Watt (30 dBm)

Note: B* is the 26 dB emission bandwidth in megahertz

Per KDB 662911 Method of conducted output power measurement on IEEE 802.11 devices,

Array Gain = 0 dB (i.e., no array gain) for $N_{ANT} \leq 4$;

Array Gain = 0 dB (i.e., no array gain) for channel widths \geq 40 MHz for any N_{ANT} ;

Array Gain = 5 log(N_{ANT}/N_{SS}) dB or 3 dB, whichever is less for 20 MHz channel widths with $N_{ANT} \geq 5$.

For power measurements on all other devices: Array Gain = 10 log(N_{ANT}/N_{SS}) dB.

Kind of Test Site Shielded room

Test Setup

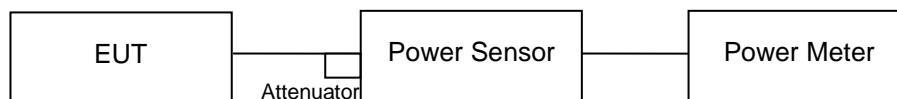

Test Instruments

Kind of Equipment	Manufacturer	Type	S/N	Calibration Date	Calibration Due Date	Test Date	
						From	Until
Power Meter	Anritsu	ML2495A	1901008	2022/3/15	2023/3/14	2022/10/25	2022/11/11
Power Sensor	Anritsu	MA2411B	1725269	2022/3/15	2023/3/14	2022/10/25	2022/11/11

Test Procedures

Method PM is used to perform output power measurement, trigger and gating function of wide band power meter is enabled to measure max output power of TX on burst and set the detector to AVERAGE. Duty factor is not added to measured value.

Test Result
CDD Mode
<802.11a>

Channel	Channel Frequency (MHz)	Average Output Power (dBm)		Total Power		Limit (dBm)
		Ant 1	Ant 2	(dBm)	(mW)	
36	5180	21.48	21.59	24.55	284.82	30
40	5200	23.15	23.37	26.27	423.81	30
48	5240	23.16	23.21	26.20	416.43	30
149	5745	22.92	23.48	26.22	418.73	30
157	5785	23.17	23.77	26.49	445.72	30
165	5825	22.95	23.63	26.31	427.92	30

<802.11n HT20>

Channel	Channel Frequency (MHz)	Average Output Power (dBm)		Total Power		Limit (dBm)
		Ant 1	Ant 2	(dBm)	(mW)	
36	5180	21.10	21.19	24.16	260.35	30
40	5200	22.72	22.93	25.84	383.40	30
48	5240	22.85	22.83	25.85	384.62	30
149	5745	22.21	22.49	25.36	343.76	30
157	5785	23.15	23.40	26.29	425.31	30
165	5825	22.77	22.75	25.77	377.60	30

<802.11n HT40>

Channel	Channel Frequency (MHz)	Average Output Power (dBm)		Total Power		Limit (dBm)
		Ant 1	Ant 2	(dBm)	(mW)	
38	5190	20.66	20.68	23.68	233.36	30
46	5230	22.57	22.91	25.75	376.15	30
151	5755	22.11	22.37	25.25	335.14	30
159	5795	22.90	23.65	26.30	426.72	30

<802.11ac VHT20>

Channel	Channel Frequency (MHz)	Average Output Power (dBm)		Total Power		Limit (dBm)
		Ant 1	Ant 2	(dBm)	(mW)	
36	5180	21.14	21.18	24.17	261.24	30
40	5200	22.91	22.95	25.94	392.68	30
48	5240	22.98	22.97	25.99	396.76	30
149	5745	22.34	22.93	25.66	367.73	30
157	5785	22.99	23.34	26.18	414.84	30
165	5825	22.57	23.44	26.04	401.52	30

<802.11ac VHT40>

Channel	Channel Frequency (MHz)	Average Output Power (dBm)		Total Power		Limit (dBm)
		Ant 1	Ant 2	(dBm)	(mW)	
38	5190	21.00	21.05	24.04	253.24	30
46	5230	22.93	23.20	26.08	405.27	30
151	5755	22.63	23.31	25.99	397.52	30
159	5795	22.90	23.60	26.27	424.07	30

<802.11ac VHT80>

Channel	Channel Frequency (MHz)	Average Output Power (dBm)		Total Power		Limit (dBm)
		Ant 1	Ant 2	(dBm)	(mW)	
42	5210	19.88	19.92	22.91	195.45	30
155	5775	18.76	19.15	21.97	157.39	30

<802.11ax HE20>

Channel	Channel Frequency (MHz)	Average Output Power (dBm)		Total Power		Limit (dBm)
		Ant 1	Ant 2	(dBm)	(mW)	
36	5180	21.23	21.22	24.24	265.17	30
40	5200	22.94	23.03	26.00	397.70	30
48	5240	23.10	23.01	26.07	404.16	30
149	5745	22.37	23.12	25.77	377.70	30
157	5785	23.39	23.61	26.51	447.89	30
165	5825	22.85	23.63	26.27	423.43	30

<802.11ax HE40>

Channel	Channel Frequency (MHz)	Average Output Power (dBm)		Total Power		Limit (dBm)
		Ant 1	Ant 2	(dBm)	(mW)	
38	5190	21.03	21.12	24.09	256.18	30
46	5230	23.02	23.24	26.14	411.31	30
151	5755	22.70	23.47	26.11	408.54	30
159	5795	22.99	23.78	26.41	437.85	30

<802.11ax HE80>

Channel	Channel Frequency (MHz)	Average Output Power (dBm)		Total Power		Limit (dBm)
		Ant 1	Ant 2	(dBm)	(mW)	
42	5210	20.06	20.14	23.11	204.67	30
155	5775	18.78	19.24	22.03	159.46	30

Beamforming Mode
<802.11ac VHT20>

Channel	Channel Frequency (MHz)	Average Output Power (dBm)		Total Power		Limit (dBm)
		Ant 1	Ant 2	(dBm)	(mW)	
36	5180	18.13	18.17	21.16	130.63	28.49
40	5200	19.90	19.94	22.93	196.35	28.49
48	5240	19.97	19.96	22.98	198.39	28.49
149	5745	19.33	19.92	22.65	183.88	28.04
157	5785	19.98	20.33	23.17	207.44	28.04
165	5825	19.56	20.43	23.03	200.77	28.04

<802.11ac VHT40>

Channel	Channel Frequency (MHz)	Average Output Power (dBm)		Total Power		Limit (dBm)
		Ant 1	Ant 2	(dBm)	(mW)	
38	5190	17.99	18.04	21.03	126.63	28.49
46	5230	19.92	20.19	23.07	202.65	28.49
151	5755	19.62	20.30	22.98	198.77	28.04
159	5795	19.89	20.59	23.26	212.05	28.04

<802.11ac VHT80>

Channel	Channel Frequency (MHz)	Average Output Power (dBm)		Total Power		Limit (dBm)
		Ant 1	Ant 2	(dBm)	(mW)	
42	5210	16.87	16.91	19.90	97.73	28.49
155	5775	15.75	16.14	18.96	78.70	28.04

<802.11ax HE20>

Channel	Channel Frequency (MHz)	Average Output Power (dBm)		Total Power		Limit (dBm)
		Ant 1	Ant 2	(dBm)	(mW)	
36	5180	18.22	18.21	21.23	132.60	28.49
40	5200	19.93	20.02	22.99	198.86	28.49
48	5240	20.09	20.00	23.06	202.09	28.49
149	5745	19.36	20.11	22.76	188.86	28.04
157	5785	20.38	20.60	23.50	223.96	28.04
165	5825	19.84	20.62	23.26	211.73	28.04

<802.11ax HE40>

Channel	Channel Frequency (MHz)	Average Output Power (dBm)		Total Power		Limit (dBm)
		Ant 1	Ant 2	(dBm)	(mW)	
38	5190	18.02	18.11	21.08	128.10	28.49
46	5230	20.01	20.23	23.13	205.67	28.49
151	5755	19.69	20.46	23.10	204.28	28.04
159	5795	19.98	20.77	23.40	218.94	28.04

<802.11ax HE80>

Channel	Channel Frequency (MHz)	Average Output Power (dBm)		Total Power		Limit (dBm)
		Ant 1	Ant 2	(dBm)	(mW)	
42	5210	17.05	17.13	20.10	102.34	28.49
155	5775	15.77	16.23	19.02	79.73	28.04

5.1.4 26 dB Bandwidth and 99% Occupied Bandwidth

Kind of Test Site Shielded room

Test Setup

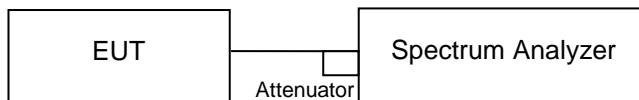

Test Instruments

Kind of Equipment	Manufacturer	Type	S/N	Calibration Date	Calibration Due Date	Test Date	
						From	Until
Spectrum Analyzer	R&S	FSV40	101512	2022/2/24	2023/2/23	2022/10/25	2022/11/11

Test Procedure

- a. Set RBW = approximately 1% of the emission bandwidth.
- b. Set the VBW > RBW.
- c. Detector = Peak.
- d. Trace mode = max hold.
- e. Measure the maximum width of the emission that is 26 dB down from the peak of the emission. Compare this with the RBW setting of the analyzer. Readjust RBW and repeat measurement as needed until the RBW/EBW ratio is approximately 1%.
- f. For 99% Bandwidth Measurement, the transmitter output was connected to the spectrum analyzer through an attenuator. The bandwidth of the fundamental frequency was measured by spectrum analyzer with resolution bandwidth in the range of 1% to 5% of the anticipated emission bandwidth, and a video bandwidth at least 3x the resolution bandwidth and set the detector to PEAK. The width of a frequency band such that, below the lower and above the upper frequency limits, the mean powers emitted are each equal to a specified percentage 0.5% of the total mean power of a given emission.

Test Results

Please refer to Appendix A

5.1.5 6 dB Bandwidth (5725-5850MHz)

Kind of Test Site Shielded room

Test Setup

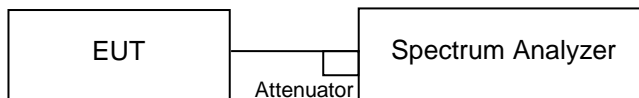

Test Instruments

Kind of Equipment	Manufacturer	Type	S/N	Calibration Date	Calibration Due Date	Test Date	
						From	Until
Spectrum Analyzer	R&S	FSV40	101512	2022/2/24	2023/2/23	2022/10/25	2022/11/11

Test Procedure

MEASUREMENT PROCEDURE REF

- a. Set resolution bandwidth (RBW) = 100 kHz
- b. Set the video bandwidth (VBW) ≥ 3 x RBW, Detector = Peak.
- c. Trace mode = max hold.
- d. Sweep = auto couple.
- e. Measure the maximum width of the emission that is constrained by the frequencies associated with the two amplitude points (upper and lower) that are attenuated by 6 dB relative to the maximum level measured in the fundamental emission.

Test Results

Please refer to Appendix A

5.1.6 Frequency Stability Measurement

Kind of Test Site Shielded room

Test Setup

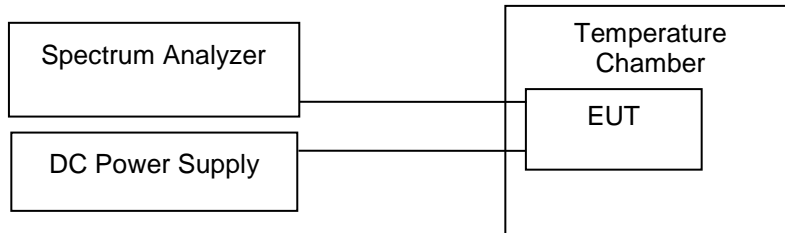

Test Instruments

Kind of Equipment	Manufacturer	Type	S/N	Calibration Date	Calibration Due Date	Test Date	
						From	Until
Spectrum Analyzer	R&S	FSV40	101512	2022/2/24	2023/2/23	2022/10/25	2022/11/11
Thermal Chamber	Giant Force	GHT-150-40-CP-SD	MAA1902-010	2022/3/2	2023/3/1	2022/10/25	2022/11/11

Test Procedure

- To ensure emission at the band edge is maintained within the authorized band, those values shall be measured by radiation emissions at upper and lower frequency points, and finally compensated by frequency deviation as procedures below.
- The EUT was operated at the maximum output power, and connected to the spectrum analyzer, which is set to maximum hold function and peak detector. The peak value of the power envelope was measured and noted. The upper and lower frequency points were respectively measured relatively 10 dB lower than the measured peak value.
- The frequency deviation was calculated by adding the upper frequency point and the lower frequency point divided by two. Those detailed values of frequency deviation are provided in table below.

Test Results

Frequency (MHz)	5180			
Voltage (V)	Measurement Frequency (MHz)			Max. Deviation (ppm)
132	5179.97656			4.525
120	5179.9754			4.749
108	5179.97554			4.722
Temperature (°C)	Measurement Frequency (MHz)			
	0 Minute	2 Minute	5 Minute	10 Minute
50	5179.97164	5179.9725	5179.97366	5179.97598
40	5179.97482	5179.97366	5179.9725	5179.97164
30	5179.99595	5179.98698	5179.98205	5179.97916
20	5180.011	5180.00492	5179.9974	5179.99421
10	5180.02547	5180.01534	5180.01013	5180.00666
0	5180.0356	5180.02518	5180.02315	5180.02142
-10	5180.05123	5180.0466	5180.04313	5180.04052
-20	5180.04595	5180.04776	5180.04667	5180.04776
Max. Deviation (ppm)	9.890	9.220	9.010	9.220

5.1.7 Power Spectral Density

Limit

For the 5.15~5.25GHz Bands:

For mobile and portable client devices in the 5.15~5.25GHz band, the Maximum Power spectral density shall not exceed 11dBm/MHz. For an indoor access point operating in the band 5.15~5.25GHz, the maximum power spectral density shall not exceed 17dBm/MHz.

For the 5.745~5.85GHz Bands:

The maximum power spectral density shall not exceed 30dBm/500kHz.

Kind of Test Site Shielded room

Test Setup

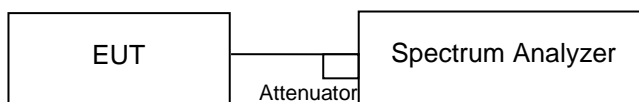

Test Instruments

Kind of Equipment	Manufacturer	Type	S/N	Calibration Date	Calibration Due Date	Test Date	
						From	Until
Spectrum Analyzer	R&S	FSV40	101512	2022/2/24	2023/2/23	2022/10/25	2022/11/11

Test Procedure**For U-NII-1, U-NII-2A, U-NII-2C band:**

Using method SA-2

1. Set span to encompass the entire emission bandwidth (EBW) of the signal.
2. Set RBW = 1 MHz, Set VBW \geq 3 MHz, Detector = RMS
3. Sweep time = auto, trigger set to "free run".
4. Trace average at least 100 traces in power averaging mode.
5. Record the max value and add 10 log (1/duty cycle)

※For U-NII-3:

1. Set span to encompass the entire emission bandwidth (EBW) of the signal.
2. Set RBW = 500 kHz, Set VBW \geq 3 RBW, Detector = RMS
3. Use the peak marker function to determine the maximum power level in any 500 kHz band segment within the fundamental EBW.
4. Sweep time = auto, trigger set to "free run".
5. Trace average at least 100 traces in power averaging mode.
6. Record the max value and add 10 log (1/duty cycle)

For MIMO mode, calculation method follows FCC KDB 662911 Method 2) a) of power density measurement using for calculating total power density. Total power density is summing entire spectra across corresponding frequency bins on the various outputs by computer.

Test Results

Please refer to Appendix A

5.1.8 Radiated Spurious Emissions

Limit

Radiated emissions which fall in the restricted bands, as defined in §15.205(a), must comply with the radiated emission limits specified in §15.209(a).

Emissions radiated outside the restricted and authorized frequency bands must either comply with the radiated emission limits specified for the restricted bands or in §15.407(b).

Kind of Test Site 3m Semi-Anechoic Chamber

Test Setup

<Radiated Emissions below 30 MHz>

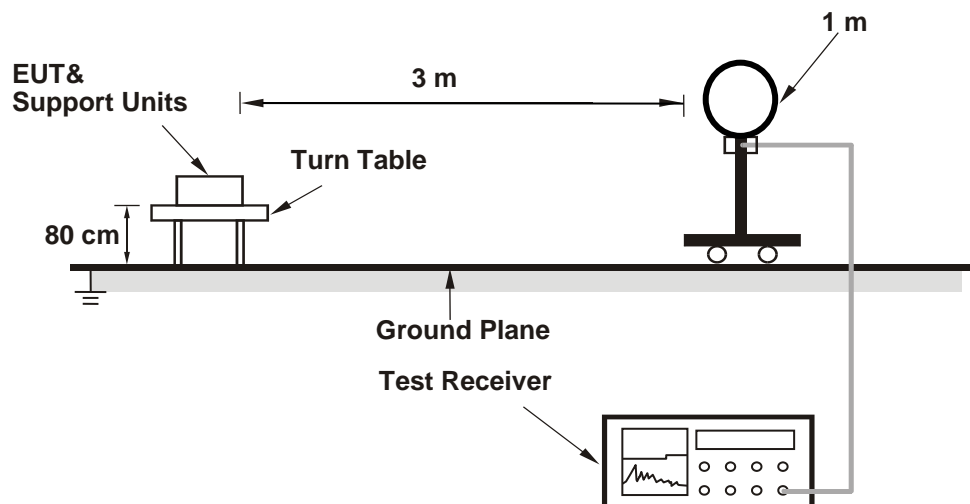

<Radiated Emissions 30 MHz to 1 GHz>

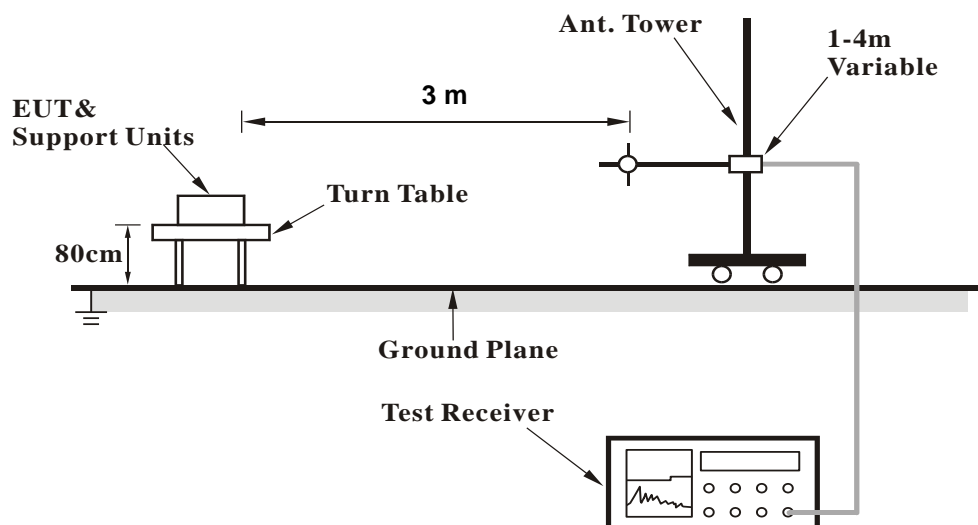

<Radiated Emissions above 1 GHz>

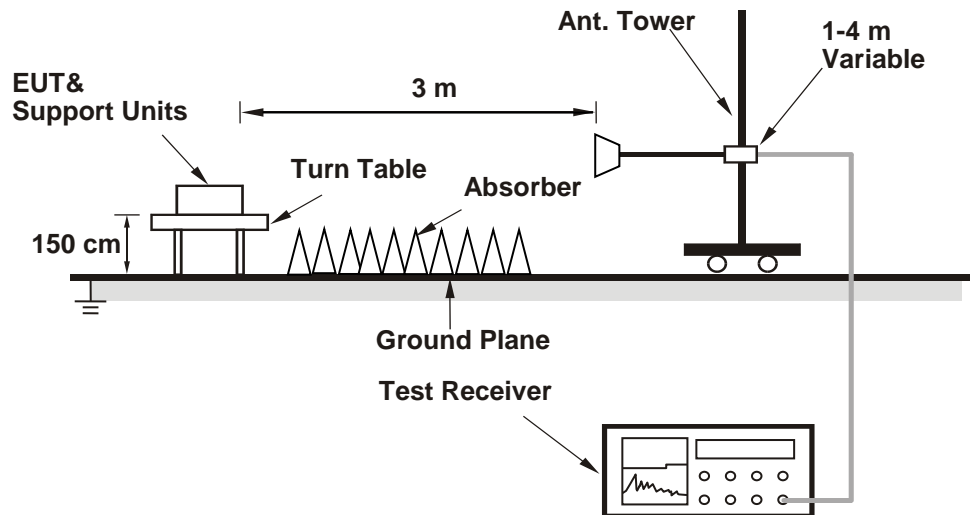

For the actual test configuration, please refer to the attached file (Test Setup Photo).

Test Instruments

Kind of Equipment	Manufacturer	Type	S/N	Calibration Date	Calibration Due Date
Above 1 GHz					
Signal Analyzer	R&S	FSV40	101508	2022/4/13	2023/4/12
Horn Antenna	ETS-Lindgren	3117	00218930	2021/12/20	2022/12/19
HF-AMP + AC source	EMCI	EMC051845SE	980633	2022/2/16	2023/2/15
HF-AMP + AC source	EMCI	EMC184045SE	980657	2022/2/16	2023/2/15
Horn Antenna	SCHWARZBECK	BBHA 9170	00887	2022/3/29	2023/3/28
Signal Analyzer	R&S	FSV40	101508	2022/4/13	2023/4/12
30 MHz ~ 1 GHz					
Receiver	R&S	ESR7	102108	2022/4/28	2023/4/27
Bilog Antenna	SCHWARZBECK	VULB-9168	00951	2022/4/6	2023/4/5
LF-AMP	Agilent	8447D	2944A107722	2022/3/22	2023/3/21
Below 30 MHz					
Receiver	R&S	ESR7	102108	2022/4/28	2023/4/27
Microwave Cable	SUCOFLEX 104EA	800056/4EA	804680/4	2022/3/22	2023/3/21
Loop Antenna	SCHWARZBECK	FMZB 1519B	00215	2021/12/8	2022/12/7

Test Procedures**For Radiated Emissions below 30 MHz**

- a. The EUT was placed on the top of a rotating table 0.8 meters above the ground at a 3 meter chamber room. The table was rotated 360 degrees to determine the position of the highest radiation.
- b. The EUT was set 3 meters away from the interference-receiving antenna, which was mounted on the top of a variable-height antenna tower.
- c. Parallel (OPEN), perpendicular (CLOSE), and ground-parallel (GROUND) orientations of the antenna are set to make the measurement.
- d. For each suspected emission, the EUT was arranged to its worst case and the rotatable table was turned from 0 degrees to 360 degrees to find the maximum reading.
- e. The test-receiver system was set to Quasi-Peak Detect Function and Specified Bandwidth with Maximum Hold Mode.

Note:

1. The resolution bandwidth and video bandwidth of test receiver/spectrum analyzer is 9 kHz at frequency below 30 MHz.
2. All modes of operation were investigated and the worst-case emissions are reported.

For Radiated Emissions above 30 MHz

- a. The EUT was placed on the top of a rotating table 0.8 meters (for 30 MHz ~ 1 GHz) / 1.5 meters (for above 1 GHz) above the ground at 3 meter chamber room for test. The table was rotated 360 degrees to determine the position of the highest radiation.
- b. The EUT was set 3 meters away from the interference-receiving antenna, which was mounted on the top of a variable-height antenna tower.
- c. The height of antenna is varied from one meter to four meters above the ground to determine the maximum value of the field strength. Both horizontal and vertical polarizations of the antenna are set to make the measurement.
- d. For each suspected emission, the EUT was arranged to its worst case and then the antenna was tuned to heights from 1 meter to 4 meters and the rotatable table was turned from 0 degrees to 360 degrees to find the maximum reading.
- e. The test-receiver system was set to quasi-peak detect function and specified bandwidth with maximum hold mode when the test frequency is below 1 GHz.
- f. The test-receiver system was set to peak and average detected function and specified bandwidth with maximum hold mode when the test frequency is above 1 GHz. If the peak reading value also meets average limit, measurement with the average detector is unnecessary.

Note:

1. The resolution bandwidth and video bandwidth of test receiver/spectrum analyzer is 120 kHz for Quasi-peak detection (QP) or Peak detection (PK) at frequency below 1 GHz.
2. The resolution bandwidth of test receiver/spectrum analyzer is 1 MHz and the video bandwidth is 3 MHz for Peak detection (PK) at frequency above 1 GHz.
3. The resolution bandwidth of test receiver/spectrum analyzer is 1 MHz and the video bandwidth is $\geq 1/T$ (Duty cycle < 98 %) or 10 Hz (Duty cycle ≥ 98 %) for Average detection (AV) at frequency above 1 GHz.
4. All modes of operation were investigated and the worst-case emissions are reported.
5. The Radiated Emissions testing was performed in the X(E1), Y(H) and Z(E2) axis orientation. The worst-case Axis orientation is recorded in this test report.

Prüfbericht - Nr.: **CN22MB93 (P15E-WiFi) 001**
Test Report No.

Seite 34 von 36
Page 34 of 36

Test Results

Factor (dB/m) = Antenna Factor (dB/m) + Cable Loss (dB)
Level (dBuV/m) = Reading (dBuV) + Factor (dB/m)

Please refer to Appendix B.

5.2 Mains Emission

5.2.1 Mains Conducted Emission

Limit

Mains Conducted emissions as defined in §15.207 must comply with the mains conducted emission limits.

Kind of Test Site Shielded room

Test Setup

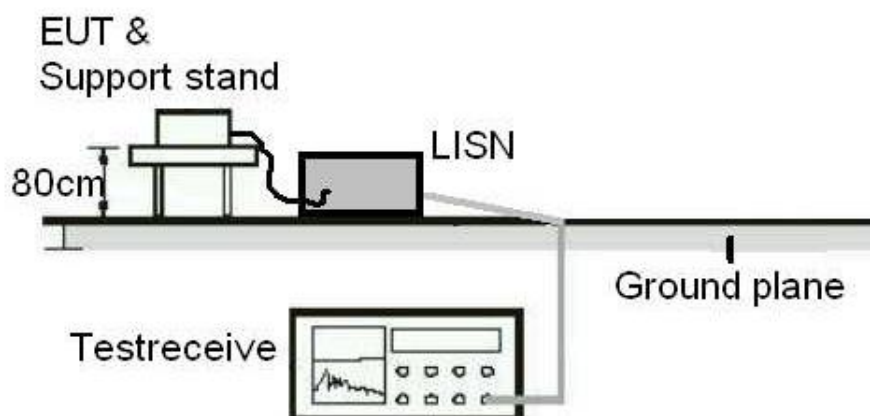

Test Instruments

Kind of Equipment	Manufacturer	Type	S/N	Calibration Date	Calibration Due Date
Two-Line V-Network	Rohde & Schwarz	ENV216	101938	2022/9/22	2023/9/21
EMI Test Receiver	R&S	ESR	102109	2022/2/25	2023/2/24

Test Procedures

- a. The EUT was placed 0.4 meters from the conducting wall of the shielded room with EUT being connected to the power mains through a line impedance stabilization network (LISN). Other support units were connected to the power mains through another LISN. The two LISNs provide 50 ohm/50 uH of coupling impedance for the measuring instrument.
- b. Both lines of the power mains connected to the EUT were checked for maximum conducted interference.
- c. The frequency range from 150 kHz to 30 MHz was searched. Emission levels under (Limit – 20 dB) was not recorded.

Note: The resolution bandwidth and video bandwidth of test receiver is 9 kHz for quasi-peak detection (QP) and average detection (AV) at frequency 0.15 MHz – 30 MHz.

Test Results

Please refer to Appendix B.