

## FCC Test Report

**Report No.:** RF160726C12-2

**FCC ID:** HDCBSAP304X

**Test Model:** BSAP-3045

**Series Model:** BSAP-3040

**Received Date:** Jul. 26, 2016

**Test Date:** Jul. 31 ~ Sep. 09, 2016

**Issued Date:** Nov. 04, 2016

**Applicant:** Adtran

**Address:** 901 Explorer Boulevard Huntsville Alabama United States

**Issued By:** Bureau Veritas Consumer Products Services (H.K.) Ltd., Taoyuan Branch

**Lab Address:** No. 47-2, 14th Ling, Chia Pau Vil., Lin Kou Dist., New Taipei City, Taiwan, R.O.C.

**Test Location:** No.19, Hwa Ya 2nd Rd., Wen Hwa Vil., Kwei Shan Dist., Taoyuan City 33383, TAIWAN (R.O.C.)



This report is for your exclusive use. Any copying or replication of this report to or for any other person or entity, or use of our name or trademark, is permitted only with our prior written permission. This report sets forth our findings solely with respect to the test samples identified herein. The results set forth in this report are not indicative or representative of the quality or characteristics of the lot from which a test sample was taken or any similar or identical product unless specifically and expressly noted. Our report includes all of the tests requested by you and the results thereof based upon the information that you provided to us. You have 60 days from date of issuance of this report to notify us of any material error or omission caused by our negligence, provided, however, that such notice shall be in writing and shall specifically address the issue you wish to raise. A failure to raise such issue within the prescribed time shall constitute your unqualified acceptance of the completeness of this report, the tests conducted and the correctness of the report contents. Unless specific mention, the uncertainty of measurement has been explicitly taken into account to declare the compliance or non-compliance to the specification. This report should not be used by the client to claim product certification, approval, or endorsement by TAF or any government agencies.

## Table of Contents

<b>Release Control Record</b> .....	<b>4</b>
<b>1 Certificate of Conformity</b> .....	<b>5</b>
<b>2 Summary of Test Results</b> .....	<b>6</b>
2.1 Measurement Uncertainty.....	6
2.2 Modification Record.....	6
<b>3 General Information</b> .....	<b>7</b>
3.1 General Description of EUT.....	7
3.2 Description of Test Modes.....	9
3.2.1 Test Mode Applicability and Tested Channel Detail.....	10
3.3 Duty Cycle of Test Signal.....	11
3.4 Description of Support Units.....	12
3.4.1 Configuration of System under Test.....	13
3.5 General Description of Applied Standards.....	15
<b>4 Test Types and Results</b> .....	<b>16</b>
4.1 Radiated Emission and Bandedge Measurement.....	16
4.1.1 Limits of Radiated Emission and Bandedge Measurement.....	16
4.1.2 Test Instruments.....	17
4.1.3 Test Procedures.....	18
4.1.4 Deviation from Test Standard.....	18
4.1.5 Test Set Up.....	19
4.1.6 EUT Operating Conditions.....	20
4.1.7 Test Results.....	21
4.2 Conducted Emission Measurement.....	31
4.2.1 Limits of Conducted Emission Measurement.....	31
4.2.2 Test Instruments.....	31
4.2.3 Test Procedures.....	32
4.2.4 Deviation from Test Standard.....	32
4.2.5 Test Setup.....	32
4.2.6 EUT Operating Conditions.....	32
4.2.7 Test Results.....	33
4.3 6dB Bandwidth Measurement.....	41
4.3.1 Limits of 6dB Bandwidth Measurement.....	41
4.3.2 Test Setup.....	41
4.3.3 Test Instruments.....	41
4.3.4 Test Procedure.....	41
4.3.5 Deviation from Test Standard.....	41
4.3.6 EUT Operating Conditions.....	41
4.3.7 Test Result.....	42
4.4 Conducted Output Power Measurement.....	43
4.4.1 Limits of Conducted Output Power Measurement.....	43
4.4.2 Test Setup.....	43
4.4.3 Test Instruments.....	43
4.4.4 Test Procedures.....	43
4.4.5 Deviation from Test Standard.....	43
4.4.6 EUT Operating Conditions.....	43
4.4.7 Test Results.....	43
4.5 Power Spectral Density Measurement.....	44
4.5.1 Limits of Power Spectral Density Measurement.....	44
4.5.2 Test Setup.....	44
4.5.3 Test Instruments.....	44
4.5.4 Test Procedure.....	44
4.5.5 Deviation from Test Standard.....	44
4.5.6 EUT Operating Condition.....	44

4.5.7 Test Results .....	45
4.6 Conducted Out of Band Emission Measurement.....	46
4.6.1 Limits of Conducted Out of Band Emission Measurement .....	46
4.6.2 Test Setup.....	46
4.6.3 Test Instruments .....	46
4.6.4 Test Procedure .....	46
4.6.5 Deviation from Test Standard .....	47
4.6.6 EUT Operating Condition .....	47
4.6.7 Test Results .....	47
<b>5 Pictures of Test Arrangements.....</b>	<b>49</b>
<b>Appendix – Information on the Testing Laboratories .....</b>	<b>50</b>

### Release Control Record

Issue No.	Description	Date Issued
RF160726C12-2	Original release	Nov. 04, 2016

## 1 Certificate of Conformity

**Product:** Wireless 802.11abgn/ac Access Point

**Brand:** Adtran

**Test Model:** BSAP-3045

**Series Model:** BSAP-3040

**Sample Status:** Engineering sample

**Applicant:** Adtran

**Test Date:** Jul. 31 ~ Sep. 09, 2016

**Standards:** 47 CFR FCC Part 15, Subpart C (Section 15.247)  
ANSI C63.10:2013

The above equipment has been tested by **Bureau Veritas Consumer Products Services (H.K.) Ltd., Taoyuan Branch**, and found compliance with the requirement of the above standards. The test record, data evaluation & Equipment Under Test (EUT) configurations represented herein are true and accurate accounts of the measurements of the sample's EMC characteristics under the conditions specified in this report.

**Prepared by :** Celine Chou , **Date:** Nov. 04, 2016  
Celine Chou / Specialist

**Approved by :** Ken Liu , **Date:** Nov. 04, 2016  
Ken Liu / Senior Manager

## 2 Summary of Test Results

47 CFR FCC Part 15, Subpart C (Section 15.247)			
FCC Clause	Test Item	Result	Remarks
15.207	AC Power Conducted Emission	Pass	Meet the requirement of limit. Minimum passing margin is -7.96dB at 0.49715MHz
15.205 / 15.209 / 15.247(d)	Radiated Emissions and Band Edge Measurement	Pass	Meet the requirement of limit. Minimum passing margin is -1.2dB at 7440.00MHz.
15.247(d)	Antenna Port Emission	Pass	Meet the requirement of limit.
15.247(a)(2)	6dB bandwidth	Pass	Meet the requirement of limit.
15.247(b)	Conducted power	Pass	Meet the requirement of limit.
15.247(e)	Power Spectral Density	Pass	Meet the requirement of limit.
15.203	Antenna Requirement	Pass	Antenna connector is IPEX not a standard connector.

### 2.1 Measurement Uncertainty

Where relevant, the following measurement uncertainty levels have been estimated for tests performed on the EUT as specified in CISPR 16-4-2:

Measurement	Frequency	Expanded Uncertainty (k=2) ( $\pm$ )
Conducted Emissions at mains ports	150kHz ~ 30MHz	2.44 dB
Radiated Emissions up to 1 GHz	30MHz ~ 200MHz	3.86 dB
	200MHz ~ 1000MHz	3.87 dB
Radiated Emissions above 1 GHz	1GHz ~ 18GHz	2.29 dB
	18GHz ~ 40GHz	2.29 dB

### 2.2 Modification Record

There were no modifications required for compliance.

### 3 General Information

#### 3.1 General Description of EUT

Product	Wireless 802.11abgn/ac Access Point
Brand	Adtran
Test Model	BSAP-3045
Series Model	BSAP-3040
Model Difference	Refer to note for more details
Sample Status	Engineering sample
Power Supply Rating	12Vdc from adapter 48Vdc from POE
Modulation Type	GFSK
Transfer Rate	1Mbps
Operating Frequency	2402 ~ 2480MHz
Number of Channel	40
Channel Spacing	2MHz
Output Power	1.026mW
Antenna Type	Refer to note
Antenna Connector	Refer to note
Accessory Device	NA
Data Cable Supplied	NA

Note:

1. The following models are provided to this EUT.

Brand	Model	Difference
Adtran	BSAP-3040	Internal antenna
	BSAP-3045	External antenna

2. There are four radios for the EUT.

Radio	Model	Function
Radio 1	QCA9994	WLAN 2.4G
Radio 2	QCA9994	WLAN 5G
Radio 3	QCA9889	WLAN 2.4GHz (TX/RX)+5GHz (RX)
Radio 4	MKW40Z160 MCU	BT LE

3. The EUT uses following antennas.

**For Model: BSAP-3040 (Internal antenna)**

Ant. No.	1	2	3	4	5	6	7	8	9 (Scan) Individual	10 (BLE) Individual
Ant. Type	PIFA								PIFA	Dipole
Frequency (MHz)	2400-2500				5150-5850				2400-2500/ 5150-5850	2400-2500
Gain (dBi)	3.81	3.98	3.47	3.75	5.65	5.50	5.84	5.84	2.9/5.1	3.93
Connector	IPEX								IPEX	IPEX

**For Model: BSAP-3045 (External antenna)**

Ant. No.	-						-		9 (Scan) Individual	1 (BLE) Individual
Ant. Type	Dipole								PIFA	PIFA
Frequency (MHz)	2400	2450	2500	5150	5550	5850	2400-2500/ 5150-5850		2400-2500	
Gain (dBi)	4.66	4.47	4.49	3.34	4.67	4.52	2.9/5.1		3.81	
Connector	IPEX								IPEX	IPEX

4. The EUT consumes power from the following adapter and POE. (Support units only)

Adapter	
Brand	AOEM
Model	ADS036T-W120300
Input Power	100-240Vac, 50-60Hz, 1.0A
Output Power	12Vdc, 3.0A
Power Line	1.5m cable with one core attached on adapter

POE	
Brand	EnGenius
Model	EPE-48GR
Output Power	48Vdc, 0.5A, 24W Max

POE's adapter	
Brand	Powertron Electronics Corp.
Model	PA1040-480IB080
Input Power	100-240Vac, 50-60Hz, 1.5A
Output Power	48Vdc, 0.8A, 38.4W Max
Power Line	1.55m cable with one core attached on adapter

5. 2.4GHz, 5GHz and BT LE technology can transmit at same time.

6. Spurious emission of the simultaneous operation (2.4GHz, 5GHz and BT LE) has been evaluated and no non-compliance was found.



### 3.2 Description of Test Modes

40 channels are provided to this EUT:

Channel	Freq. (MHz)	Channel	Freq. (MHz)	Channel	Freq. (MHz)	Channel	Freq. (MHz)
0	2402	10	2422	20	2442	30	2462
1	2404	11	2424	21	2444	31	2464
2	2406	12	2426	22	2446	32	2466
3	2408	13	2428	23	2448	33	2468
4	2410	14	2430	24	2450	34	2470
5	2412	15	2432	25	2452	35	2472
6	2414	16	2434	26	2454	36	2474
7	2416	17	2436	27	2456	37	2476
8	2418	18	2438	28	2458	38	2478
9	2420	19	2440	29	2460	39	2480

### 3.2.1 Test Mode Applicability and Tested Channel Detail

EUT CONFIGURE MODE	APPLICABLE TO				DESCRIPTION
	RE $\geq$ 1G	RE $<$ 1G	PLC	APCM	
A	√	√	√	√	Model: BSAP-3045 Power from adapter
B	-	√	√	-	Model: BSAP-3045 Power from POE
C	√	√	√	-	Model: BSAP-3040 Power from adapter
D	-	√	√	-	Model: BSAP-3040 Power from POE

Where **RE $\geq$ 1G**: Radiated Emission above 1GHz & Bandedge Measurement  
**RE $<$ 1G**: Radiated Emission below 1GHz  
**PLC**: Power Line Conducted Emission  
**APCM**: Antenna Port Conducted Measurement

Note:

1. The EUT had been pre-tested on the positioned of each 3 axis. The worst case was found when positioned on **Z-plane**.
2. "-" means no effect.

#### Radiated Emission Test (Above 1GHz):

- Pre-Scan has been conducted to determine the worst-case mode from all possible combinations between available modulations, data rates and antenna ports (if EUT with antenna diversity architecture).
- Following channel(s) was (were) selected for the final test as listed below.

EUT CONFIGURE MODE	AVAILABLE CHANNEL	TESTED CHANNEL	MODULATION TYPE	DATA RATE (Mbps)
A, C	0 to 39	0, 19, 39	GFSK	1

#### Radiated Emission Test (Below 1GHz):

- Pre-Scan has been conducted to determine the worst-case mode from all possible combinations between available modulations, data rates and antenna ports (if EUT with antenna diversity architecture).
- Following channel(s) was (were) selected for the final test as listed below.

EUT CONFIGURE MODE	AVAILABLE CHANNEL	TESTED CHANNEL	MODULATION TYPE	DATA RATE (Mbps)
A, B, C, D	0 to 39	0	GFSK	1

#### Power Line Conducted Emission Test:

- Pre-Scan has been conducted to determine the worst-case mode from all possible combinations between available modulations, data rates and antenna ports (if EUT with antenna diversity architecture).
- Following channel(s) was (were) selected for the final test as listed below.

EUT CONFIGURE MODE	AVAILABLE CHANNEL	TESTED CHANNEL	MODULATION TYPE	DATA RATE (Mbps)
A, B, C, D	0 to 39	0	GFSK	1

**Antenna Port Conducted Measurement:**

- This item includes all test value of each mode, but only includes spectrum plot of worst value of each mode.
- Pre-Scan has been conducted to determine the worst-case mode from all possible combinations between available modulations, data rates and antenna ports (if EUT with antenna diversity architecture).
- Following channel(s) was (were) selected for the final test as listed below.

EUT CONFIGURE MODE	AVAILABLE CHANNEL	TESTED CHANNEL	MODULATION TYPE	DATA RATE (Mbps)
A	0 to 39	0, 19, 39	GFSK	1

**Test Condition:**

APPLICABLE TO	ENVIRONMENTAL CONDITIONS	INPUT POWER	TESTED BY
RE $\geq$ 1G	19deg. C, 70%RH 18deg. C, 70%RH	120Vac, 60Hz	James Yang
RE<1G	19deg. C, 70%RH 18deg. C, 70%RH	120Vac, 60Hz 48Vdc	Jones Chang
PLC	20deg. C, 70%RH	120Vac, 60Hz 48Vdc	Jones Chang
APCM	25deg. C, 60%RH	120Vac, 60Hz	Leo Tsai

**3.3 Duty Cycle of Test Signal**

Duty cycle of test signal is < 98 %, duty factor is required.

Duty cycle =  $0.380/0.625 = 0.608$ , Duty factor =  $10 * \log( 1/0.608 ) = 2.16$

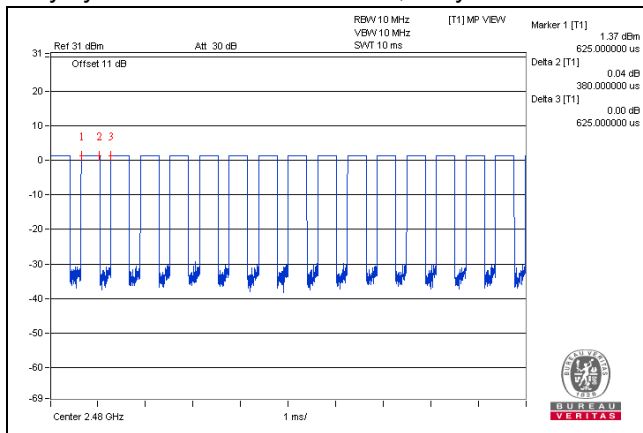

### 3.4 Description of Support Units

The EUT has been tested as an independent unit together with other necessary accessories or support units. The following support units or accessories were used to form a representative test configuration during the tests.

ID	Product	Brand	Model No.	Serial No.	FCC ID	Remarks
A.	Notebook	DELL	E5410	1HC2XM1	FCC DoC Approved	-
B.	Adapter	AOEM	ADS036T-W120300	N/A	N/A	Provided by manufacturer For test mode A and C only
C.	POE	EnGenius	EPE-48GR	N/A	N/A	Provided by manufacturer For test mode B and D only
D.	POE adapter	Powertron Electronics Corp.	PA1040-480IB080	N/A	N/A	Provided by manufacturer For test mode B and D only
E.	Load	N/A	N/A	N/A	N/A	-
F.	USB Flash	HP	v250W	01	FCC DoC Approved	-

Note:

1. All power cords of the above support units are non-shielded (1.8m).
2. Item A acted as communication partner to transfer data.

ID	Descriptions	Qty.	Length (m)	Shielding (Yes/No)	Cores (Qty.)	Remarks
1.	RJ45 Cable	1	3	N	0	Cat5e
2.	Power Cable	1	1.5	-	1	For test mode A and C only
3.	Power Cable	1	1.55	-	1	For test mode B and D only
4.	RJ45 Cable	1	1.8	N	0	Cat5e
5.	RJ45 to RS-232 Cable	1	1.8	N	0	-
6.	RJ45 Cable	1	1.8	N	0	Cat5e

### 3.4.1 Configuration of System under Test

#### Test Mode A

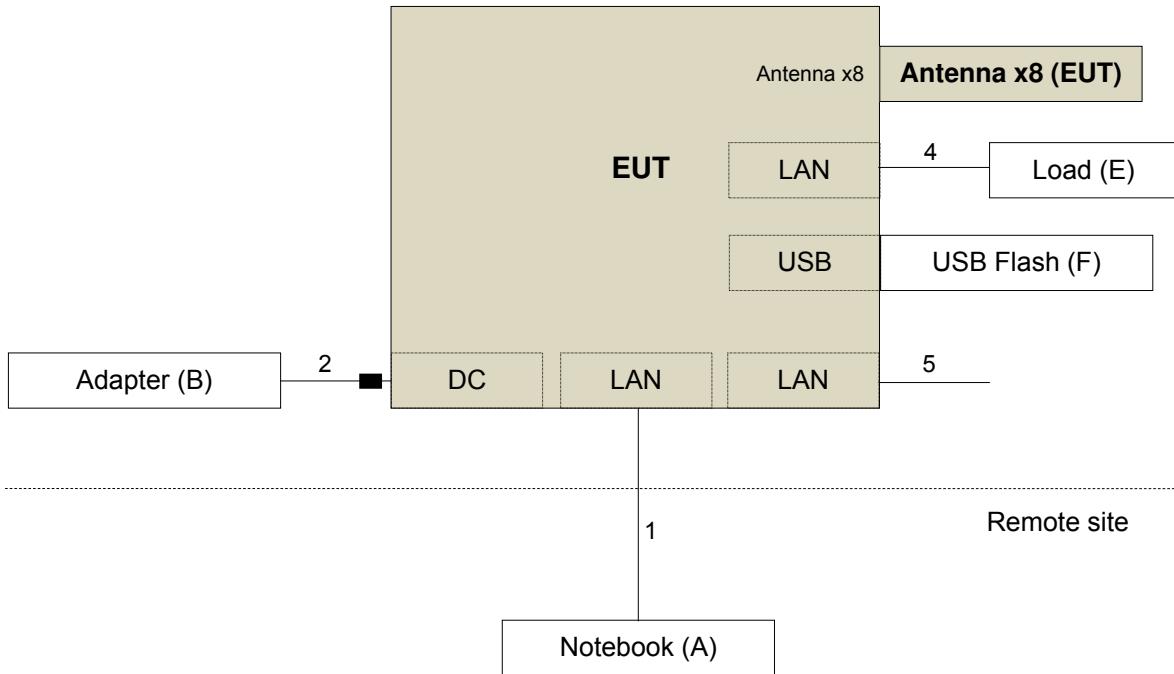

#### Test Mode B

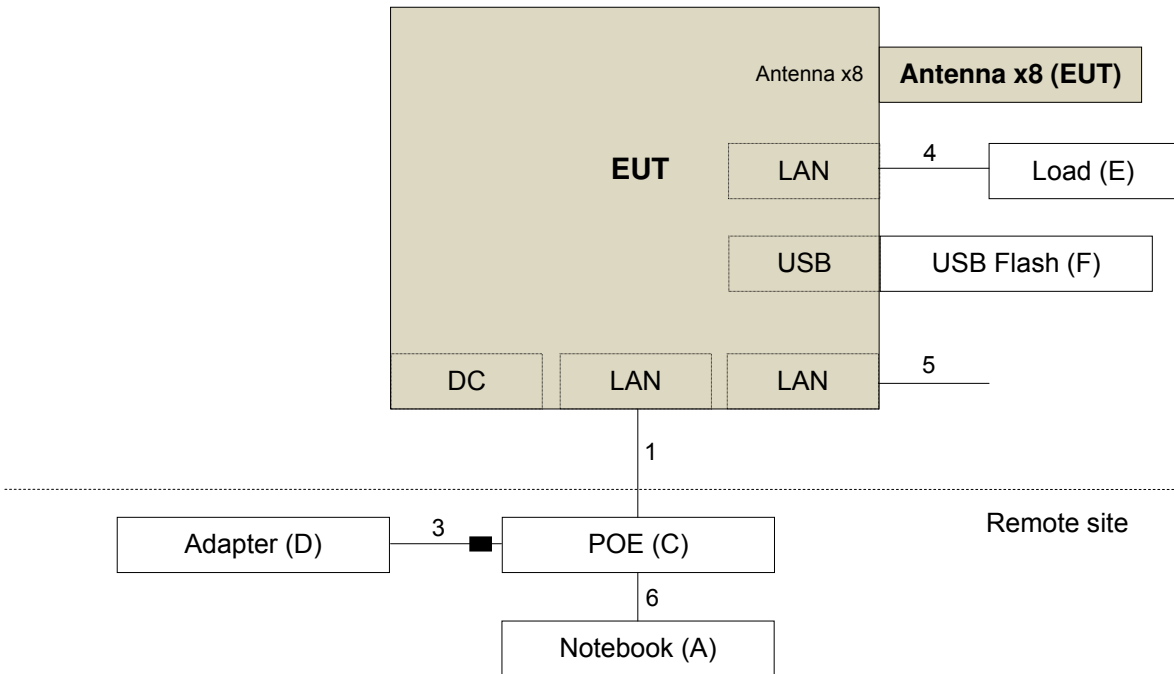

Test Mode C

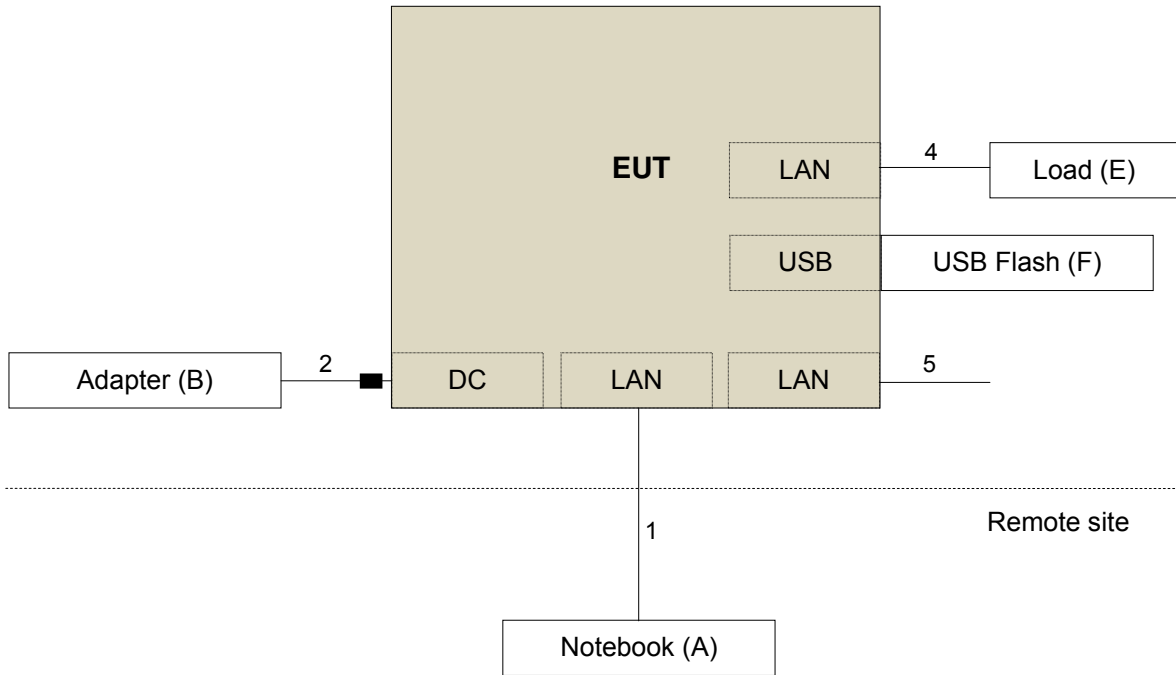

Test Mode D

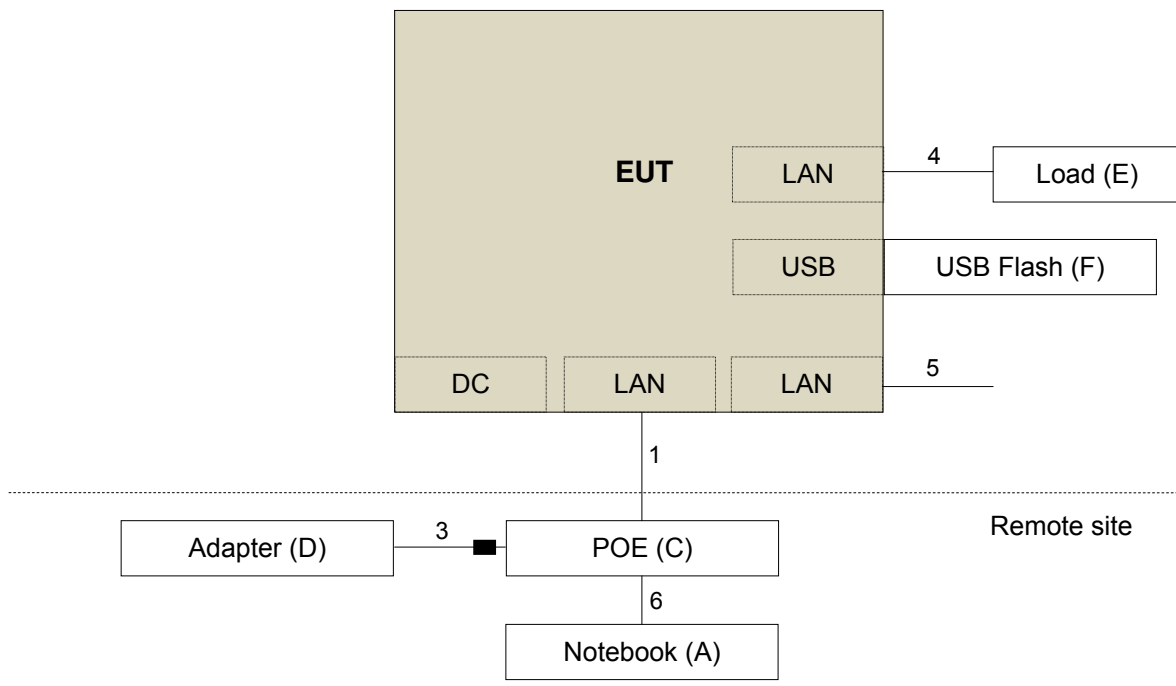

### 3.5 General Description of Applied Standards

The EUT is a RF Product. According to the specifications of the manufacturer, it must comply with the requirements of the following standards:

**FCC Part 15, Subpart C (15.247)**

**KDB 558074 D01 DTS Meas Guidance v03r05**

ANSI C63.10-2013

All test items have been performed and recorded as per the above standards.

Note: The EUT has been verified to comply with the requirements of FCC Part 15, Subpart B, Class B (DoC).  
The test report has been issued separately.

## 4 Test Types and Results

### 4.1 Radiated Emission and Bandedge Measurement

#### 4.1.1 Limits of Radiated Emission and Bandedge Measurement

Radiated emissions which fall in the restricted bands must comply with the radiated emission limits specified as below table. Other emissions shall be at least 30dB below the highest level of the desired power:

Frequencies (MHz)	Field Strength (microvolts/meter)	Measurement Distance (meters)
0.009 ~ 0.490	2400/F(kHz)	300
0.490 ~ 1.705	24000/F(kHz)	30
1.705 ~ 30.0	30	30
30 ~ 88	100	3
88 ~ 216	150	3
216 ~ 960	200	3
Above 960	500	3

**Note:**

1. The lower limit shall apply at the transition frequencies.
2. Emission level (dBuV/m) = 20 log Emission level (uV/m).
3. For frequencies above 1000MHz, the field strength limits are based on average detector, however, the peak field strength of any emission shall not exceed the maximum permitted average limits, specified above by more than 30dB under any condition of modulation.



#### 4.1.2 Test Instruments

Description & Manufacturer	Model No.	Serial No.	Cal. Date	Cal. Due
Test Receiver ROHDE & SCHWARZ	ESIB7	100187	Apr. 18, 2016	Apr. 17, 2017
Spectrum Analyzer ROHDE & SCHWARZ	FSP40	100041	Sep. 02, 2015	Sep. 01, 2016
			Sep. 02, 2016	Sep. 01, 2017
BILOG Antenna SCHWARZBECK	VULB9168	9168-171	Jan. 07, 2016	Jan. 06, 2017
HORN Antenna SCHWARZBECK	9120D	209	Jan. 20, 2016	Jan. 19, 2017
HORN Antenna SCHWARZBECK	BBHA 9170	BBHA9170241	Jan. 18, 2016	Jan. 17, 2017
Loop Antenna	EM-6879	269	Aug. 11, 2015	Aug. 10, 2016
			Aug. 11, 2016	Aug. 10, 2017
Preamplifier Agilent	8447D	2944A10738	Aug. 22, 2015	Aug. 21, 2016
			Aug. 22, 2016	Aug. 21, 2017
Preamplifier Agilent	8449B	3008A01964	Aug. 22, 2015	Aug. 21, 2016
			Aug. 22, 2016	Aug. 21, 2017
RF signal cable HUBER+SUHNER	SUCOFLEX 104	Cable-CH3-03 (214378)	Aug. 22, 2015	Aug. 21, 2016
			Aug. 22, 2016	Aug. 21, 2017
RF signal cable HUBER+SUHNER	SUCOFLEX 106	Cable-CH3-03 (309224+12738)	Aug. 22, 2015	Aug. 21, 2016
			Aug. 22, 2016	Aug. 21, 2017
Software BV ADT	ADT_Radiated_ V7.6.15.9.4	NA	NA	NA
Antenna Tower inn-co GmbH	MA 4000	013303	NA	NA
Antenna Tower Controller BV ADT	AT100	AT93021702	NA	NA
Turn Table BV ADT	TT100	TT93021702	NA	NA
Turn Table Controller BV ADT	SC100	SC93021702	NA	NA
High Speed Peak Power Meter	ML2495A	0824011	Jul. 09, 2016	Jul. 08, 2017
Power Sensor	MA2411B	0738171	Aug. 11, 2015	Aug. 10, 2016
			Aug. 11, 2016	Aug. 10, 2017

- Note:
1. The calibration interval of the above test instruments is 12 months and the calibrations are traceable to NML/ROC and NIST/USA.
  2. The test was performed in HwaYa Chamber 3.
  3. The horn antenna and preamplifier (model: 8449B) are used only for the measurement of emission frequency above 1GHz if tested.
  4. The FCC Site Registration No. is 988962.
  5. The IC Site Registration No. is IC 7450F-3.

### 4.1.3 Test Procedures

#### For Radiated emission below 30MHz

- a. The EUT was placed on the top of a rotating table 0.8 meters above the ground at a 3 meter chamber room. The table was rotated 360 degrees to determine the position of the highest radiation.
- b. The EUT was set 3 meters away from the interference-receiving antenna, which was mounted on the top of a variable-height antenna tower.
- c. Both X and Y axes of the antenna are set to make the measurement.
- d. For each suspected emission, the EUT was arranged to its worst case and the rotatable table was turned from 0 degrees to 360 degrees to find the maximum reading.
- e. The test-receiver system was set to Quasi-Peak Detect Function and Specified Bandwidth with Maximum Hold Mode.

#### Note:

1. The resolution bandwidth and video bandwidth of test receiver/spectrum analyzer is 9kHz at frequency below 30MHz.

#### For Radiated emission above 30MHz

- a. The EUT was placed on the top of a rotating table 0.8 meters (for 30MHz ~ 1GHz) / 1.5 meters (for above 1GHz) above the ground at 3 meter chamber room for test. The table was rotated 360 degrees to determine the position of the highest radiation.
- b. The EUT was set 3 meters away from the interference-receiving antenna, which was mounted on the top of a variable-height antenna tower.
- c. The height of antenna is varied from one meter to four meters above the ground to determine the maximum value of the field strength. Both horizontal and vertical polarizations of the antenna are set to make the measurement.
- d. For each suspected emission, the EUT was arranged to its worst case and then the antenna was tuned to heights from 1 meter to 4 meters and the rotatable table was turned from 0 degrees to 360 degrees to find the maximum reading.
- e. The test-receiver system was set to quasi-peak detect function and specified bandwidth with maximum hold mode when the test frequency is below 1 GHz.
- f. The test-receiver system was set to peak and average detect function and specified bandwidth with maximum hold mode when the test frequency is above 1 GHz. If the peak reading value also meets average limit, measurement with the average detector is unnecessary.

#### Note:

1. The resolution bandwidth and video bandwidth of test receiver/spectrum analyzer is 120kHz for Quasi-peak detection (QP) at frequency below 1GHz.
2. The resolution bandwidth of test receiver/spectrum analyzer is 1 MHz and the video bandwidth is 3 MHz for Peak detection (PK) at frequency above 1GHz.
3. The resolution bandwidth of test receiver/spectrum analyzer is 1MHz and the video bandwidth is  $\geq 1/T$  (Duty cycle < 98%) or 10Hz (Duty cycle  $\geq 98\%$ ) for Average detection (AV) at frequency above 1GHz.
4. All modes of operation were investigated and the worst-case emissions are reported.

### 4.1.4 Deviation from Test Standard

No deviation.

#### 4.1.5 Test Set Up

##### For Radiated emission below 30MHz

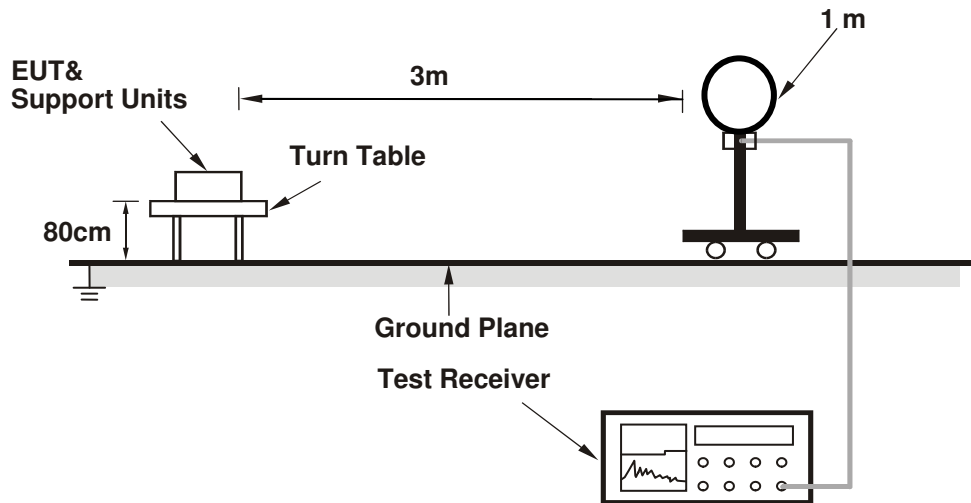

##### For Radiated emission 30MHz to 1GHz

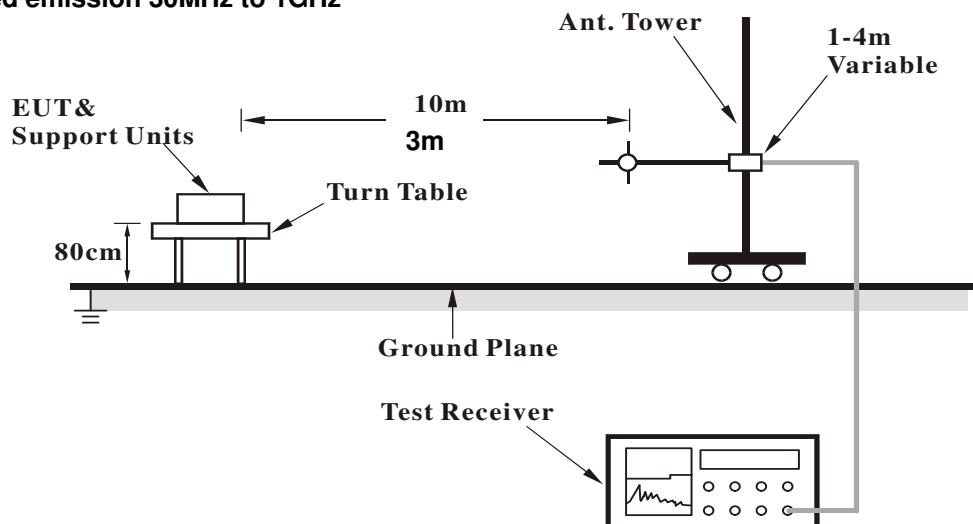

### For Radiated emission above 1GHz

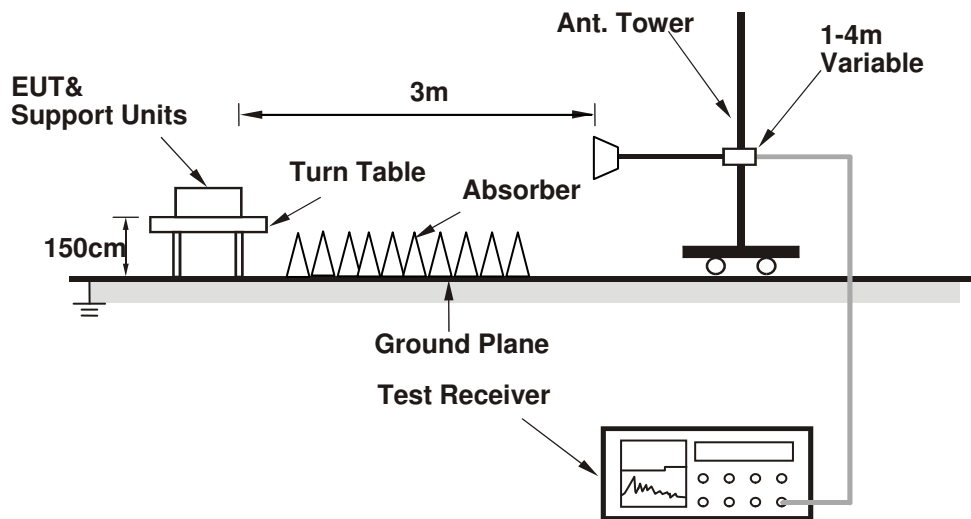

For the actual test configuration, please refer to the attached file (Test Setup Photo).

#### 4.1.6 EUT Operating Conditions

- a. Placed the EUT on the testing table.
- b. Prepared a notebook to act as a communication partner and placed it outside of testing area.
- c. The communication partner connected with EUT via a RJ45 cable and ran a test program (provided by manufacturer) to enable EUT under transmission condition continuously at specific channel frequency.
- d. The communication partner sent data to EUT by command "PING".

#### 4.1.7 Test Results

Above 1GHz worst-case data:

Test Mode A

CHANNEL	TX Channel 0	DETECTOR FUNCTION	Peak (PK) Average (AV)
FREQUENCY RANGE	1GHz ~ 25GHz		

ANTENNA POLARITY & TEST DISTANCE: HORIZONTAL AT 3 M								
NO.	FREQ. (MHz)	EMISSION LEVEL (dBuV/m)	LIMIT (dBuV/m)	MARGIN (dB)	ANTENNA HEIGHT (m)	TABLE ANGLE (Degree)	RAW VALUE (dBuV)	CORRECTION FACTOR (dB/m)
1	2338.00	56.6 PK	74.0	-17.4	2.09 H	315	24.1	32.5
2	2338.00	46.8 AV	54.0	-7.2	2.09 H	315	14.3	32.5
3	*2402.00	97.0 PK			2.72 H	318	64.2	32.8
4	*2402.00	92.5 AV			2.72 H	318	59.7	32.8
5	4804.00	51.8 PK	74.0	-22.2	1.53 H	355	45.9	5.9
6	4804.00	43.7 AV	54.0	-10.3	1.53 H	355	37.8	5.9
ANTENNA POLARITY & TEST DISTANCE: VERTICAL AT 3 M								
NO.	FREQ. (MHz)	EMISSION LEVEL (dBuV/m)	LIMIT (dBuV/m)	MARGIN (dB)	ANTENNA HEIGHT (m)	TABLE ANGLE (Degree)	RAW VALUE (dBuV)	CORRECTION FACTOR (dB/m)
1	2338.00	57.4 PK	74.0	-16.6	2.52 V	327	24.9	32.5
2	2338.00	46.0 AV	54.0	-8.0	2.52 V	327	13.5	32.5
3	*2402.00	94.2 PK			2.53 V	347	61.4	32.8
4	*2402.00	89.7 AV			2.53 V	347	56.9	32.8
5	4804.00	55.1 PK	74.0	-18.9	1.59 V	10	49.2	5.9
6	4804.00	48.7 AV	54.0	-5.3	1.59 V	10	42.8	5.9

Remarks:

1. Emission Level(dBuV/m) = Raw Value(dBuV) + Correction Factor(dB/m)
2. Correction Factor(dB/m) = Antenna Factor(dB/m) + Cable Factor(dB)
3. The other emission levels were very low against the limit.
4. Margin value = Emission Level – Limit value
5. " \* ": Fundamental frequency.
6. " # ": The radiated frequency is out of the restricted band.

CHANNEL	TX Channel 19	DETECTOR FUNCTION	Peak (PK)
FREQUENCY RANGE	1GHz ~ 25GHz		Average (AV)

ANTENNA POLARITY & TEST DISTANCE: HORIZONTAL AT 3 M								
NO.	FREQ. (MHz)	EMISSION LEVEL (dBuV/m)	LIMIT (dBuV/m)	MARGIN (dB)	ANTENNA HEIGHT (m)	TABLE ANGLE (Degree)	RAW VALUE (dBuV)	CORRECTION FACTOR (dB/m)
1	*2440.00	96.3 PK			2.69 H	322	63.3	33.0
2	*2440.00	91.6 AV			2.69 H	322	58.6	33.0
3	4880.00	51.7 PK	74.0	-22.3	1.55 H	357	45.7	6.0
4	4880.00	43.4 AV	54.0	-10.6	1.55 H	357	37.4	6.0
5	7320.00	58.6 PK	74.0	-15.4	1.71 H	54	45.3	13.3
6	7320.00	49.1 AV	54.0	-4.9	1.71 H	54	35.8	13.3
ANTENNA POLARITY & TEST DISTANCE: VERTICAL AT 3 M								
NO.	FREQ. (MHz)	EMISSION LEVEL (dBuV/m)	LIMIT (dBuV/m)	MARGIN (dB)	ANTENNA HEIGHT (m)	TABLE ANGLE (Degree)	RAW VALUE (dBuV)	CORRECTION FACTOR (dB/m)
1	*2440.00	93.7 PK			2.80 V	14	60.7	33.0
2	*2440.00	89.6 AV			2.80 V	14	56.6	33.0
3	4880.00	54.4 PK	74.0	-19.6	1.63 V	3	48.4	6.0
4	4880.00	47.4 AV	54.0	-6.6	1.63 V	3	41.4	6.0
5	7320.00	57.1 PK	74.0	-16.9	2.70 V	328	43.8	13.3
6	7320.00	46.2 AV	54.0	-7.8	2.70 V	328	32.9	13.3

Remarks:

1. Emission Level(dBuV/m) = Raw Value(dBuV) + Correction Factor(dB/m)
2. Correction Factor(dB/m) = Antenna Factor(dB/m) + Cable Factor(dB)
3. The other emission levels were very low against the limit.
4. Margin value = Emission Level – Limit value
5. " \* ": Fundamental frequency.

CHANNEL	TX Channel 39	DETECTOR FUNCTION	Peak (PK)
FREQUENCY RANGE	1GHz ~ 25GHz		Average (AV)

ANTENNA POLARITY & TEST DISTANCE: HORIZONTAL AT 3 M								
NO.	FREQ. (MHz)	EMISSION LEVEL (dBuV/m)	LIMIT (dBuV/m)	MARGIN (dB)	ANTENNA HEIGHT (m)	TABLE ANGLE (Degree)	RAW VALUE (dBuV)	CORRECTION FACTOR (dB/m)
1	*2480.00	96.6 PK			2.25 H	324	63.6	33.0
2	*2480.00	92.0 AV			2.25 H	324	59.0	33.0
3	2483.50	68.0 PK	74.0	-6.0	2.34 H	316	35.0	33.0
4	2483.50	47.8 AV	54.0	-6.2	2.34 H	316	14.8	33.0
5	4960.00	53.1 PK	74.0	-20.9	1.93 H	343	47.0	6.1
6	4960.00	45.8 AV	54.0	-8.2	1.93 H	343	39.7	6.1
7	7440.00	61.5 PK	74.0	-12.5	2.20 H	62	48.0	13.5
<b>8</b>	<b>7440.00</b>	<b>52.8 AV</b>	<b>54.0</b>	<b>-1.2</b>	<b>2.20 H</b>	<b>62</b>	<b>39.3</b>	<b>13.5</b>

ANTENNA POLARITY & TEST DISTANCE: VERTICAL AT 3 M								
NO.	FREQ. (MHz)	EMISSION LEVEL (dBuV/m)	LIMIT (dBuV/m)	MARGIN (dB)	ANTENNA HEIGHT (m)	TABLE ANGLE (Degree)	RAW VALUE (dBuV)	CORRECTION FACTOR (dB/m)
1	*2480.00	89.6 PK			2.31 V	178	56.6	33.0
2	*2480.00	85.5 AV			2.31 V	178	52.5	33.0
3	2483.50	61.6 PK	74.0	-12.4	2.29 V	175	28.6	33.0
4	2483.50	45.8 AV	54.0	-8.2	2.29 V	175	12.8	33.0
5	4960.00	54.1 PK	74.0	-19.9	1.77 V	43	48.0	6.1
6	4960.00	46.8 AV	54.0	-7.2	1.77 V	43	40.7	6.1
7	7440.00	60.3 PK	74.0	-13.7	2.25 V	342	46.8	13.5
8	7440.00	51.0 AV	54.0	-3.0	2.25 V	342	37.5	13.5

Remarks:

1. Emission Level(dBuV/m) = Raw Value(dBuV) + Correction Factor(dB/m)
2. Correction Factor(dB/m) = Antenna Factor(dB/m) + Cable Factor(dB)
3. The other emission levels were very low against the limit.
4. Margin value = Emission Level – Limit value
5. " \* ": Fundamental frequency.

Test Mode C

CHANNEL	TX Channel 0	DETECTOR	Peak (PK)
FREQUENCY RANGE	1GHz ~ 25GHz	FUNCTION	Average (AV)

ANTENNA POLARITY & TEST DISTANCE: HORIZONTAL AT 3 M								
NO.	FREQ. (MHz)	EMISSION LEVEL (dBuV/m)	LIMIT (dBuV/m)	MARGIN (dB)	ANTENNA HEIGHT (m)	TABLE ANGLE (Degree)	RAW VALUE (dBuV)	CORRECTION FACTOR (dB/m)
1	2338.00	57.4 PK	74.0	-16.6	1.86 H	339	24.9	32.5
2	2338.00	45.9 AV	54.0	-8.1	1.86 H	339	13.4	32.5
3	*2402.00	94.4 PK			1.17 H	346	61.6	32.8
4	*2402.00	90.1 AV			1.17 H	346	57.3	32.8
5	4804.00	50.6 PK	74.0	-23.4	1.17 H	45	44.7	5.9
6	4804.00	41.0 AV	54.0	-13.0	1.17 H	45	35.1	5.9
ANTENNA POLARITY & TEST DISTANCE: VERTICAL AT 3 M								
NO.	FREQ. (MHz)	EMISSION LEVEL (dBuV/m)	LIMIT (dBuV/m)	MARGIN (dB)	ANTENNA HEIGHT (m)	TABLE ANGLE (Degree)	RAW VALUE (dBuV)	CORRECTION FACTOR (dB/m)
1	2338.00	56.5 PK	74.0	-17.5	1.66 V	284	24.0	32.5
2	2338.00	45.7 AV	54.0	-8.3	1.66 V	284	13.2	32.5
3	*2402.00	89.9 PK			1.57 V	330	57.1	32.8
4	*2402.00	85.7 AV			1.57 V	330	52.9	32.8
5	4804.00	52.3 PK	74.0	-21.7	1.57 V	328	46.4	5.9
6	4804.00	44.3 AV	54.0	-9.7	1.57 V	328	38.4	5.9

Remarks:

1. Emission Level(dBuV/m) = Raw Value(dBuV) + Correction Factor(dB/m)
2. Correction Factor(dB/m) = Antenna Factor(dB/m) + Cable Factor(dB)
3. The other emission levels were very low against the limit.
4. Margin value = Emission Level – Limit value
5. " \* ": Fundamental frequency.
6. " # ": The radiated frequency is out of the restricted band.



CHANNEL	TX Channel 19	DETECTOR FUNCTION	Peak (PK)
FREQUENCY RANGE	1GHz ~ 25GHz		Average (AV)

**ANTENNA POLARITY & TEST DISTANCE: HORIZONTAL AT 3 M**

NO.	FREQ. (MHz)	EMISSION LEVEL (dBuV/m)	LIMIT (dBuV/m)	MARGIN (dB)	ANTENNA HEIGHT (m)	TABLE ANGLE (Degree)	RAW VALUE (dBuV)	CORRECTION FACTOR (dB/m)
1	*2440.00	95.3 PK			1.28 H	346	62.3	33.0
2	*2440.00	91.4 AV			1.28 H	346	58.4	33.0
3	4880.00	50.8 PK	74.0	-23.2	1.08 H	46	44.8	6.0
4	4880.00	40.9 AV	54.0	-13.1	1.08 H	46	34.9	6.0

**ANTENNA POLARITY & TEST DISTANCE: VERTICAL AT 3 M**

NO.	FREQ. (MHz)	EMISSION LEVEL (dBuV/m)	LIMIT (dBuV/m)	MARGIN (dB)	ANTENNA HEIGHT (m)	TABLE ANGLE (Degree)	RAW VALUE (dBuV)	CORRECTION FACTOR (dB/m)
1	*2440.00	92.5 PK			1.10 V	331	59.5	33.0
2	*2440.00	88.1 AV			1.10 V	331	55.1	33.0
3	4880.00	51.7 PK	74.0	-22.3	1.46 V	324	45.7	6.0
4	4880.00	42.8 AV	54.0	-11.2	1.46 V	324	36.8	6.0

**Remarks:**

1. Emission Level(dBuV/m) = Raw Value(dBuV) + Correction Factor(dB/m)
2. Correction Factor(dB/m) = Antenna Factor(dB/m) + Cable Factor(dB)
3. The other emission levels were very low against the limit.
4. Margin value = Emission Level – Limit value
5. " \* ": Fundamental frequency.

CHANNEL	TX Channel 39	DETECTOR FUNCTION	Peak (PK)
FREQUENCY RANGE	1GHz ~ 25GHz		Average (AV)

**ANTENNA POLARITY & TEST DISTANCE: HORIZONTAL AT 3 M**

NO.	FREQ. (MHz)	EMISSION LEVEL (dBuV/m)	LIMIT (dBuV/m)	MARGIN (dB)	ANTENNA HEIGHT (m)	TABLE ANGLE (Degree)	RAW VALUE (dBuV)	CORRECTION FACTOR (dB/m)
1	*2480.00	96.5 PK			1.92 H	334	63.5	33.0
2	*2480.00	92.5 AV			1.92 H	334	59.5	33.0
3	2483.50	66.8 PK	74.0	-7.2	1.81 H	325	33.8	33.0
4	2483.50	48.3 AV	54.0	-5.7	1.81 H	325	15.3	33.0
5	4960.00	49.8 PK	74.0	-24.2	1.08 H	42	43.7	6.1
6	4960.00	38.6 AV	54.0	-15.4	1.08 H	42	32.5	6.1

**ANTENNA POLARITY & TEST DISTANCE: VERTICAL AT 3 M**

NO.	FREQ. (MHz)	EMISSION LEVEL (dBuV/m)	LIMIT (dBuV/m)	MARGIN (dB)	ANTENNA HEIGHT (m)	TABLE ANGLE (Degree)	RAW VALUE (dBuV)	CORRECTION FACTOR (dB/m)
1	*2480.00	90.0 PK			2.00 V	223	57.0	33.0
2	*2480.00	86.5 AV			2.00 V	223	53.5	33.0
3	2483.50	60.1 PK	74.0	-13.9	1.94 V	222	27.1	33.0
4	2483.50	45.6 AV	54.0	-8.4	1.94 V	222	12.6	33.0
5	4960.00	50.8 PK	74.0	-23.2	1.97 V	306	44.7	6.1
6	4960.00	40.6 AV	54.0	-13.4	1.97 V	306	34.5	6.1

Remarks:

1. Emission Level(dBuV/m) = Raw Value(dBuV) + Correction Factor(dB/m)
2. Correction Factor(dB/m) = Antenna Factor(dB/m) + Cable Factor(dB)
3. The other emission levels were very low against the limit.
4. Margin value = Emission Level – Limit value
5. " \* ": Fundamental frequency.

Below 1GHz worst-case data:

CHANNEL	TX Channel 0	DETECTOR FUNCTION	Quasi-Peak (QP)
FREQUENCY RANGE	9kHz ~ 1GHz		
TEST MODE	A		

ANTENNA POLARITY & TEST DISTANCE: HORIZONTAL AT 3 M

NO.	FREQ. (MHz)	EMISSION LEVEL (dBuV/m)	LIMIT (dBuV/m)	MARGIN (dB)	ANTENNA HEIGHT (m)	TABLE ANGLE (Degree)	RAW VALUE (dBuV)	CORRECTION FACTOR (dB/m)
1	76.56	27.8 QP	40.0	-12.2	1.00 H	140	45.7	-17.9
2	119.34	32.3 QP	43.5	-11.2	1.50 H	95	48.7	-16.4
3	249.60	36.1 QP	46.0	-9.9	1.00 H	136	50.1	-14.0
4	290.43	34.1 QP	46.0	-11.9	1.00 H	177	46.4	-12.3
5	399.31	31.1 QP	46.0	-14.9	2.00 H	145	41.2	-10.1
6	599.58	30.3 QP	46.0	-15.7	2.00 H	109	35.7	-5.4
7	1000.10	36.5 QP	54.0	-17.5	1.50 H	218	34.5	2.0

ANTENNA POLARITY & TEST DISTANCE: VERTICAL AT 3 M

NO.	FREQ. (MHz)	EMISSION LEVEL (dBuV/m)	LIMIT (dBuV/m)	MARGIN (dB)	ANTENNA HEIGHT (m)	TABLE ANGLE (Degree)	RAW VALUE (dBuV)	CORRECTION FACTOR (dB/m)
1	55.18	34.8 QP	40.0	-5.2	1.00 V	35	49.2	-14.4
2	136.84	30.3 QP	43.5	-13.2	1.00 V	159	45.2	-14.9
3	274.88	32.5 QP	46.0	-13.5	1.00 V	63	45.3	-12.8
4	370.15	32.8 QP	46.0	-13.2	1.00 V	250	43.4	-10.6
5	624.85	30.6 QP	46.0	-15.4	1.49 V	182	35.3	-4.7
6	1000.00	35.4 QP	54.0	-18.6	1.00 V	124	33.4	2.0

Remarks:

1. Emission Level(dBuV/m) = Raw Value(dBuV) + Correction Factor(dB/m)
2. Correction Factor(dB/m) = Antenna Factor(dB/m) + Cable Factor(dB)
3. The other emission levels were very low against the limit.
4. Margin value = Emission Level – Limit value

CHANNEL	TX Channel 0	DETECTOR FUNCTION	Quasi-Peak (QP)
FREQUENCY RANGE	9kHz ~ 1GHz		
TEST MODE	B		

**ANTENNA POLARITY & TEST DISTANCE: HORIZONTAL AT 3 M**

NO.	FREQ. (MHz)	EMISSION LEVEL (dBuV/m)	LIMIT (dBuV/m)	MARGIN (dB)	ANTENNA HEIGHT (m)	TABLE ANGLE (Degree)	RAW VALUE (dBuV)	CORRECTION FACTOR (dB/m)
1	30.00	24.1 QP	40.0	-15.9	1.50 H	7	40.4	-16.3
2	97.95	28.4 QP	43.5	-15.1	1.50 H	286	47.5	-19.1
3	500.42	31.4 QP	46.0	-14.6	1.50 H	128	39.3	-7.9
4	599.58	29.6 QP	46.0	-16.4	1.00 H	194	35.0	-5.4
5	799.84	33.5 QP	46.0	-12.5	1.00 H	171	35.0	-1.5
6	1000.00	36.5 QP	54.0	-17.5	1.00 H	150	34.5	2.0

**ANTENNA POLARITY & TEST DISTANCE: VERTICAL AT 3 M**

NO.	FREQ. (MHz)	EMISSION LEVEL (dBuV/m)	LIMIT (dBuV/m)	MARGIN (dB)	ANTENNA HEIGHT (m)	TABLE ANGLE (Degree)	RAW VALUE (dBuV)	CORRECTION FACTOR (dB/m)
1	55.18	33.0 QP	40.0	-7.0	1.00 V	63	47.4	-14.4
2	119.34	28.2 QP	43.5	-15.3	1.49 V	74	44.6	-16.4
3	259.33	34.4 QP	46.0	-11.6	1.00 V	58	48.1	-13.7
4	599.58	28.4 QP	46.0	-17.6	1.00 V	34	33.8	-5.4
5	961.21	32.9 QP	54.0	-21.1	1.49 V	144	31.2	1.7
6	1000.00	34.7 QP	54.0	-19.3	1.49 V	9	32.7	2.0

Remarks:

1. Emission Level(dBuV/m) = Raw Value(dBuV) + Correction Factor(dB/m)
2. Correction Factor(dB/m) = Antenna Factor(dB/m) + Cable Factor(dB)
3. The other emission levels were very low against the limit.
4. Margin value = Emission Level – Limit value

CHANNEL	TX Channel 0	DETECTOR FUNCTION	Quasi-Peak (QP)
FREQUENCY RANGE	9kHz ~ 1GHz		
TEST MODE	C		

**ANTENNA POLARITY & TEST DISTANCE: HORIZONTAL AT 3 M**

NO.	FREQ. (MHz)	EMISSION LEVEL (dBuV/m)	LIMIT (dBuV/m)	MARGIN (dB)	ANTENNA HEIGHT (m)	TABLE ANGLE (Degree)	RAW VALUE (dBuV)	CORRECTION FACTOR (dB/m)
1	47.40	29.9 QP	40.0	-10.1	1.99 H	87	44.4	-14.5
2	96.01	30.8 QP	43.5	-12.7	1.99 H	97	50.2	-19.4
3	191.28	33.4 QP	43.5	-10.1	1.49 H	143	49.7	-16.3
4	288.49	30.6 QP	46.0	-15.4	1.00 H	358	43.0	-12.4
5	624.85	28.7 QP	46.0	-17.3	1.49 H	123	33.4	-4.7
6	700.68	31.2 QP	46.0	-14.8	1.00 H	7	34.8	-3.6

**ANTENNA POLARITY & TEST DISTANCE: VERTICAL AT 3 M**

NO.	FREQ. (MHz)	EMISSION LEVEL (dBuV/m)	LIMIT (dBuV/m)	MARGIN (dB)	ANTENNA HEIGHT (m)	TABLE ANGLE (Degree)	RAW VALUE (dBuV)	CORRECTION FACTOR (dB/m)
1	35.73	37.8 QP	40.0	-2.2	1.00 V	109	53.4	-15.6
2	62.95	36.3 QP	40.0	-3.7	1.00 V	223	51.4	-15.1
3	134.89	28.3 QP	43.5	-15.2	1.00 V	199	43.3	-15.0
4	399.31	26.8 QP	46.0	-19.2	1.49 V	14	36.9	-10.1
5	500.42	30.1 QP	46.0	-15.9	1.00 V	247	38.0	-7.9
6	1000.00	36.5 QP	54.0	-17.5	1.99 V	10	34.5	2.0

Remarks:

1. Emission Level(dBuV/m) = Raw Value(dBuV) + Correction Factor(dB/m)
2. Correction Factor(dB/m) = Antenna Factor(dB/m) + Cable Factor(dB)
3. The other emission levels were very low against the limit.
4. Margin value = Emission Level – Limit value

CHANNEL	TX Channel 0	DETECTOR FUNCTION	Quasi-Peak (QP)
FREQUENCY RANGE	9kHz ~ 1GHz		
TEST MODE	D		

**ANTENNA POLARITY & TEST DISTANCE: HORIZONTAL AT 3 M**

NO.	FREQ. (MHz)	EMISSION LEVEL (dBuV/m)	LIMIT (dBuV/m)	MARGIN (dB)	ANTENNA HEIGHT (m)	TABLE ANGLE (Degree)	RAW VALUE (dBuV)	CORRECTION FACTOR (dB/m)
1	57.12	30.6 QP	40.0	-9.4	1.99 H	268	45.2	-14.6
2	96.01	33.6 QP	43.5	-9.9	1.99 H	258	53.0	-19.4
3	167.94	31.3 QP	43.5	-12.2	1.50 H	278	45.3	-14.0
4	282.66	33.6 QP	46.0	-12.4	1.00 H	139	46.1	-12.5
5	751.23	32.7 QP	46.0	-13.3	1.00 H	159	34.9	-2.2
6	799.84	31.9 QP	46.0	-14.1	1.00 H	166	33.4	-1.5

**ANTENNA POLARITY & TEST DISTANCE: VERTICAL AT 3 M**

NO.	FREQ. (MHz)	EMISSION LEVEL (dBuV/m)	LIMIT (dBuV/m)	MARGIN (dB)	ANTENNA HEIGHT (m)	TABLE ANGLE (Degree)	RAW VALUE (dBuV)	CORRECTION FACTOR (dB/m)
1	35.73	32.6 QP	40.0	-7.4	1.00 V	181	48.2	-15.6
2	70.73	32.2 QP	40.0	-7.8	1.50 V	215	48.7	-16.5
3	290.43	30.7 QP	46.0	-15.3	1.50 V	207	43.0	-12.3
4	624.85	29.3 QP	46.0	-16.7	1.50 V	182	34.0	-4.7
5	700.68	29.0 QP	46.0	-17.0	1.00 V	194	32.6	-3.6
6	998.16	32.7 QP	54.0	-21.3	1.00 V	11	30.7	2.0

Remarks:

1. Emission Level(dBuV/m) = Raw Value(dBuV) + Correction Factor(dB/m)
2. Correction Factor(dB/m) = Antenna Factor(dB/m) + Cable Factor(dB)
3. The other emission levels were very low against the limit.
4. Margin value = Emission Level – Limit value

## 4.2 Conducted Emission Measurement

### 4.2.1 Limits of Conducted Emission Measurement

Frequency (MHz)	Conducted Limit (dBuV)	
	Quasi-peak	Average
0.15 - 0.5	66 - 56	56 - 46
0.50 - 5.0	56	46
5.0 - 30.0	60	50

- Note:** 1. The lower limit shall apply at the transition frequencies.  
 2. The limit decreases in line with the logarithm of the frequency in the range of 0.15 to 0.50MHz.

### 4.2.2 Test Instruments

Description & Manufacturer	Model No.	Serial No.	Cal. Date	Cal. Due
Test Receiver ROHDE & SCHWARZ	ESCI	100613	Nov. 16, 2015	Nov. 15, 2016
RF signal cable (with 10dB PAD) Woken	5D-FB	Cable-cond1-01	Dec. 26, 2015	Dec. 25, 2016
LISN/AMN ROHDE & SCHWARZ (EUT)	ESH3-Z5	835239/001	Feb. 26, 2016	Feb. 25, 2017
LISN/AMN ROHDE & SCHWARZ (Peripheral)	ESH3-Z5	100220	Nov. 13, 2015	Nov. 12, 2016
Software ADT	BV ADT_Cond_ V7.3.7.3	NA	NA	NA

- Note:** 1. The calibration interval of the above test instruments is 12 months and the calibrations are traceable to NML/ROC and NIST/USA.  
 2. The test was performed in HwaYa Shielded Room 1.  
 3. The VCCI Site Registration No. is C-2040.

### 4.2.3 Test Procedures

- The EUT was placed 0.4 meters from the conducting wall of the shielded room with EUT being connected to the power mains through a line impedance stabilization network (LISN). Other support units were connected to the power mains through another LISN. The two LISNs provide 50 ohm/ 50uH of coupling impedance for the measuring instrument.
- Both lines of the power mains connected to the EUT were checked for maximum conducted interference.
- The frequency range from 150kHz to 30MHz was searched. Emission levels under (Limit - 20dB) was not recorded.

**Note:** The resolution bandwidth and video bandwidth of test receiver is 9kHz for quasi-peak detection (QP) and average detection (AV) at frequency 0.15MHz-30MHz.

### 4.2.4 Deviation from Test Standard

No deviation.

### 4.2.5 Test Setup

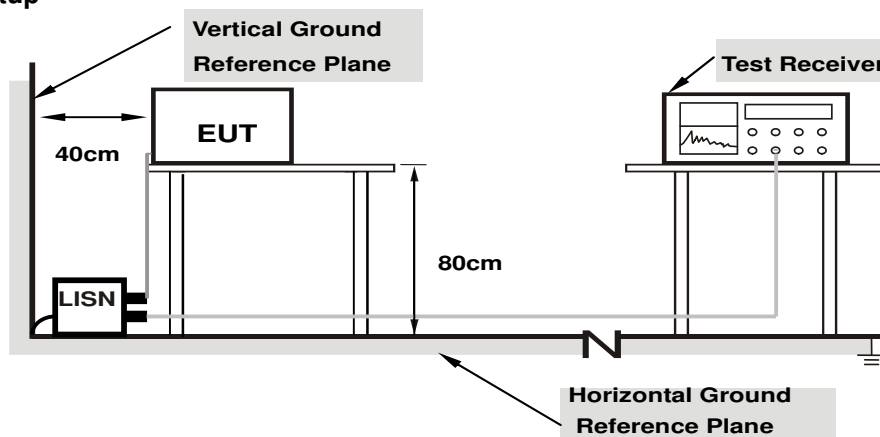

**Note:** 1.Support units were connected to second LISN.

For the actual test configuration, please refer to the attached file (Test Setup Photo).

### 4.2.6 EUT Operating Conditions

Same as 4.1.6.



#### 4.2.7 Test Results

Phase	Line (L)	Detector Function	Quasi-Peak (QP) / Average (AV)
Test Mode	A		

No	Freq. [MHz]	Corr. Factor (dB)	Reading Value		Emission Level		Limit		Margin	
			[dB (uV)]		[dB (uV)]		[dB (uV)]		(dB)	
			Q.P.	AV.	Q.P.	AV.	Q.P.	AV.	Q.P.	AV.
1	0.16569	10.08	32.12	17.44	42.20	27.52	65.17	55.17	-22.97	-27.65
2	0.31813	10.13	32.28	23.70	42.41	33.83	59.76	49.76	-17.35	-15.93
3	0.47039	10.18	26.87	11.67	37.05	21.85	56.51	46.51	-19.46	-24.66
4	0.51363	10.19	33.95	27.04	44.14	37.23	56.00	46.00	-11.86	-8.77
5	0.66605	10.22	22.19	14.99	32.41	25.21	56.00	46.00	-23.59	-20.79
6	18.99229	11.35	20.77	16.24	32.12	27.59	60.00	50.00	-27.88	-22.41

Remarks:

1. Q.P. and AV. are abbreviations of quasi-peak and average individually.
2. The emission levels of other frequencies were very low against the limit.
3. Margin value = Emission level - Limit value
4. Correction factor = Insertion loss + Cable loss
5. Emission Level = Correction Factor + Reading Value.

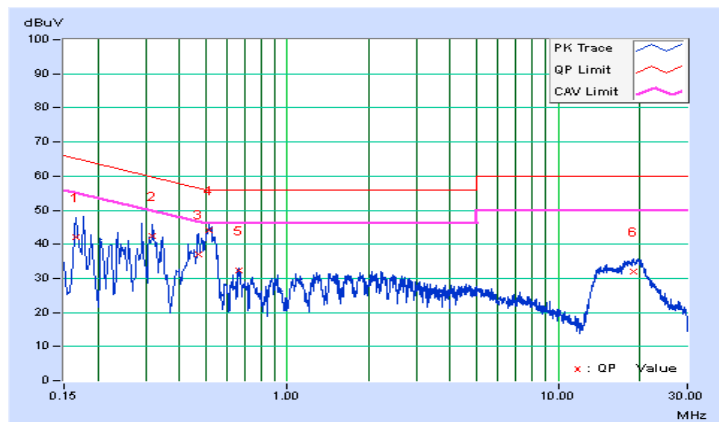

Phase	Neutral (N)	Detector Function	Quasi-Peak (QP) / Average (AV)
Test Mode	A		

No	Freq. [MHz]	Corr. Factor (dB)	Reading Value [dB (uV)]		Emission Level [dB (uV)]		Limit [dB (uV)]		Margin (dB)	
			Q.P.	AV.	Q.P.	AV.	Q.P.	AV.	Q.P.	AV.
			1	0.17328	10.08	37.76	30.38	47.84	40.46	64.80
2	0.25166	10.12	32.49	24.73	42.61	34.85	61.70	51.70	-19.09	-16.85
3	0.28288	10.15	31.53	22.81	41.68	32.96	60.73	50.73	-19.05	-17.77
4	0.47537	10.25	31.35	19.27	41.60	29.52	56.42	46.42	-14.82	-16.90
5	0.51363	10.25	34.93	26.40	45.18	36.65	56.00	46.00	-10.82	-9.35
6	14.47233	11.15	22.18	17.48	33.33	28.63	60.00	50.00	-26.67	-21.37

Remarks:

1. Q.P. and AV. are abbreviations of quasi-peak and average individually.
2. The emission levels of other frequencies were very low against the limit.
3. Margin value = Emission level - Limit value
4. Correction factor = Insertion loss + Cable loss
5. Emission Level = Correction Factor + Reading Value.

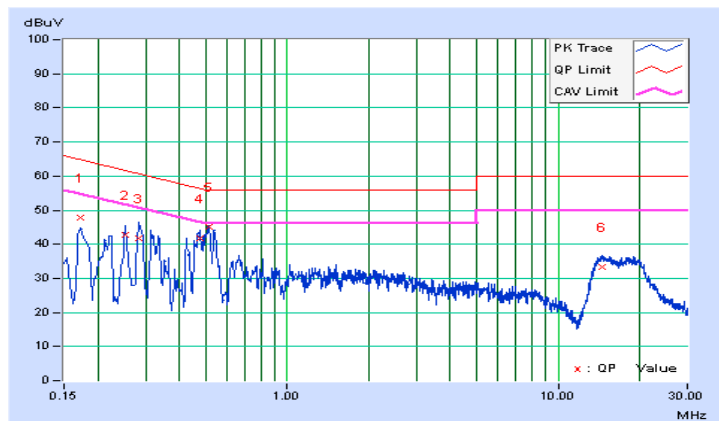

Phase	Line (L)	Detector Function	Quasi-Peak (QP) / Average (AV)
Test Mode	B		

No	Freq. [MHz]	Corr. Factor (dB)	Reading Value [dB (uV)]		Emission Level [dB (uV)]		Limit [dB (uV)]		Margin (dB)	
			Q.P.	AV.	Q.P.	AV.	Q.P.	AV.	Q.P.	AV.
			1	0.15782	10.08	17.49	7.21	27.57	17.29	65.58
2	0.41233	10.17	25.18	16.87	35.35	27.04	57.60	47.60	-22.25	-20.56
3	0.49017	10.19	33.40	27.16	43.59	37.35	56.16	46.16	-12.57	-8.81
4	0.52145	10.19	33.50	24.92	43.69	35.11	56.00	46.00	-12.31	-10.89
5	1.53023	10.33	21.97	13.53	32.30	23.86	56.00	46.00	-23.70	-22.14
6	20.30214	11.44	24.91	19.10	36.35	30.54	60.00	50.00	-23.65	-19.46

Remarks:

1. Q.P. and AV. are abbreviations of quasi-peak and average individually.
2. The emission levels of other frequencies were very low against the limit.
3. Margin value = Emission level - Limit value
4. Correction factor = Insertion loss + Cable loss
5. Emission Level = Correction Factor + Reading Value.

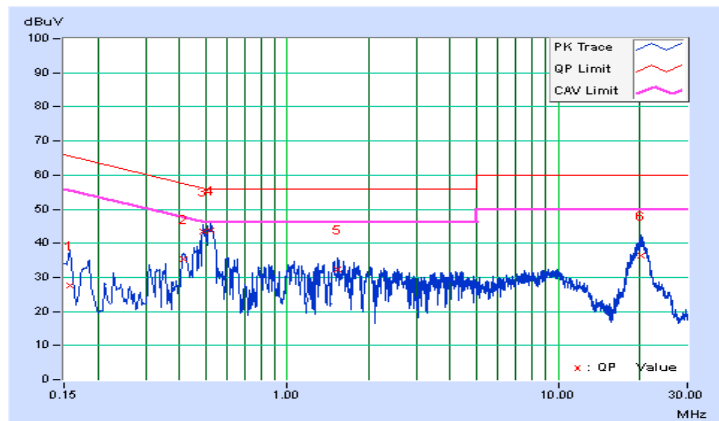

Phase	Neutral (N)	Detector Function	Quasi-Peak (QP) / Average (AV)
Test Mode	B		

No	Freq. [MHz]	Corr. Factor (dB)	Reading Value [dB (uV)]		Emission Level [dB (uV)]		Limit [dB (uV)]		Margin (dB)	
			Q.P.	AV.	Q.P.	AV.	Q.P.	AV.	Q.P.	AV.
			1	0.16564	10.08	27.96	20.44	38.04	30.52	65.18
<b>2</b>	<b>0.49715</b>	<b>10.25</b>	<b>33.21</b>	<b>27.84</b>	<b>43.46</b>	<b>38.09</b>	<b>56.05</b>	<b>46.05</b>	<b>-12.59</b>	<b>-7.96</b>
3	0.51363	10.25	30.45	16.26	40.70	26.51	56.00	46.00	-15.30	-19.49
4	0.65044	10.26	23.42	12.16	33.68	22.42	56.00	46.00	-22.32	-23.58
5	0.86002	10.28	26.31	19.04	36.59	29.32	56.00	46.00	-19.41	-16.68
6	19.39502	11.53	20.68	14.32	32.21	25.85	60.00	50.00	-27.79	-24.15

Remarks:

1. Q.P. and AV. are abbreviations of quasi-peak and average individually.
2. The emission levels of other frequencies were very low against the limit.
3. Margin value = Emission level - Limit value
4. Correction factor = Insertion loss + Cable loss
5. Emission Level = Correction Factor + Reading Value.

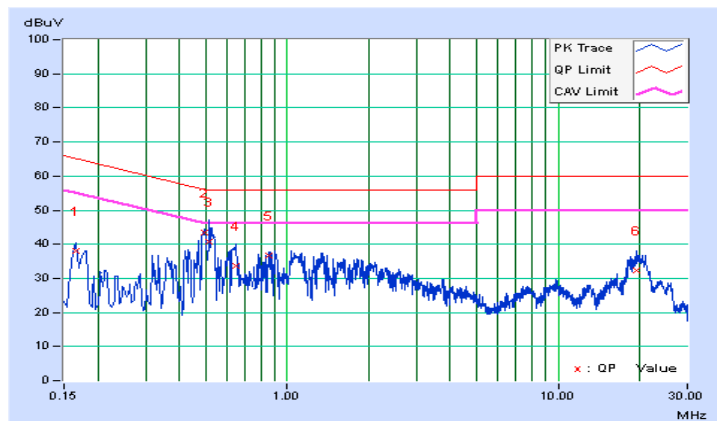

Phase	Line (L)	Detector Function	Quasi-Peak (QP) / Average (AV)
Test Mode	C		

No	Freq. [MHz]	Corr. Factor (dB)	Reading Value [dB (uV)]		Emission Level [dB (uV)]		Limit [dB (uV)]		Margin (dB)	
			Q.P.	AV.	Q.P.	AV.	Q.P.	AV.	Q.P.	AV.
			1	0.16955	10.08	38.61	29.92	48.69	40.00	64.98
2	0.23602	10.10	33.39	24.32	43.49	34.42	62.24	52.24	-18.75	-17.82
3	0.31021	10.13	34.39	26.35	44.52	36.48	59.96	49.96	-15.44	-13.48
4	0.48168	10.19	32.02	26.50	42.21	36.69	56.31	46.31	-14.10	-9.62
5	0.52960	10.20	32.77	21.38	42.97	31.58	56.00	46.00	-13.03	-14.42
6	14.91416	11.06	21.54	16.86	32.60	27.92	60.00	50.00	-27.40	-22.08

Remarks:

1. Q.P. and AV. are abbreviations of quasi-peak and average individually.
2. The emission levels of other frequencies were very low against the limit.
3. Margin value = Emission level - Limit value
4. Correction factor = Insertion loss + Cable loss
5. Emission Level = Correction Factor + Reading Value.

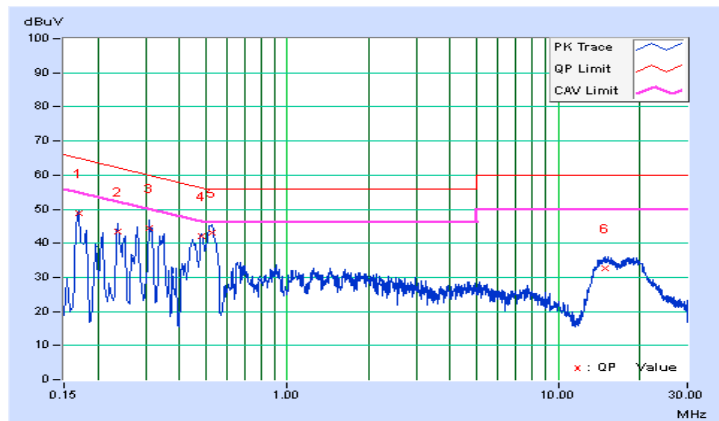

Phase	Neutral (N)	Detector Function	Quasi-Peak (QP) / Average (AV)
Test Mode	C		

No	Freq. [MHz]	Corr. Factor (dB)	Reading Value [dB (uV)]		Emission Level [dB (uV)]		Limit [dB (uV)]		Margin (dB)	
			Q.P.	AV.	Q.P.	AV.	Q.P.	AV.	Q.P.	AV.
			1	0.16955	10.08	38.36	28.61	48.44	38.69	64.98
2	0.21256	10.09	34.88	24.36	44.97	34.45	63.10	53.10	-18.13	-18.65
3	0.23993	10.11	32.53	23.23	42.64	33.34	62.10	52.10	-19.46	-18.76
4	0.29858	10.16	30.18	16.05	40.34	26.21	60.28	50.28	-19.94	-24.07
5	0.51856	10.25	33.67	27.61	43.92	37.86	56.00	46.00	-12.08	-8.14
6	19.45758	11.54	20.23	15.55	31.77	27.09	60.00	50.00	-28.23	-22.91

Remarks:

1. Q.P. and AV. are abbreviations of quasi-peak and average individually.
2. The emission levels of other frequencies were very low against the limit.
3. Margin value = Emission level - Limit value
4. Correction factor = Insertion loss + Cable loss
5. Emission Level = Correction Factor + Reading Value.

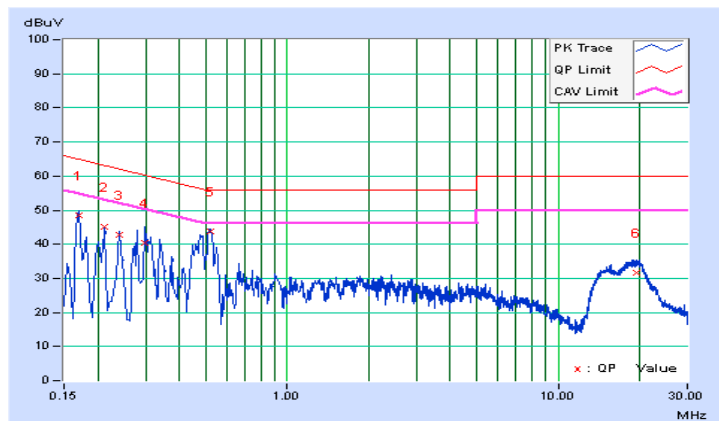

Phase	Line (L)	Detector Function	Quasi-Peak (QP) / Average (AV)
Test Mode	D		

No	Freq. [MHz]	Corr. Factor (dB)	Reading Value [dB (uV)]		Emission Level [dB (uV)]		Limit [dB (uV)]		Margin (dB)	
			Q.P.	AV.	Q.P.	AV.	Q.P.	AV.	Q.P.	AV.
			1	0.18122	10.08	23.27	13.99	33.35	24.07	64.43
2	0.41588	10.17	22.69	10.22	32.86	20.39	57.53	47.53	-24.67	-27.14
3	0.51754	10.19	32.65	20.71	42.84	30.90	56.00	46.00	-13.16	-15.10
4	0.63520	10.22	24.16	16.73	34.38	26.95	56.00	46.00	-21.62	-19.05
5	1.55760	10.33	21.41	13.47	31.74	23.80	56.00	46.00	-24.26	-22.20
6	20.53674	11.45	23.00	17.54	34.45	28.99	60.00	50.00	-25.55	-21.01

Remarks:

1. Q.P. and AV. are abbreviations of quasi-peak and average individually.
2. The emission levels of other frequencies were very low against the limit.
3. Margin value = Emission level - Limit value
4. Correction factor = Insertion loss + Cable loss
5. Emission Level = Correction Factor + Reading Value.

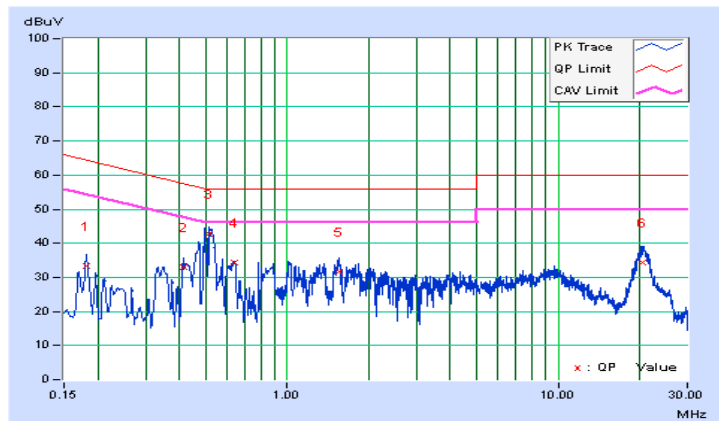

Phase	Neutral (N)	Detector Function	Quasi-Peak (QP) / Average (AV)
Test Mode	D		

No	Freq. [MHz]	Corr. Factor (dB)	Reading Value [dB (uV)]		Emission Level [dB (uV)]		Limit [dB (uV)]		Margin (dB)	
			Q.P.	AV.	Q.P.	AV.	Q.P.	AV.	Q.P.	AV.
			1	0.16569	10.08	27.99	21.58	38.07	31.66	65.17
2	0.34560	10.20	24.47	14.24	34.67	24.44	59.07	49.07	-24.40	-24.63
3	0.52130	10.25	34.15	24.66	44.40	34.91	56.00	46.00	-11.60	-11.09
4	0.61529	10.26	24.96	13.53	35.22	23.79	56.00	46.00	-20.78	-22.21
5	0.86944	10.28	25.29	16.69	35.57	26.97	56.00	46.00	-20.43	-19.03
6	20.53283	11.62	22.13	16.52	33.75	28.14	60.00	50.00	-26.25	-21.86

Remarks:

1. Q.P. and AV. are abbreviations of quasi-peak and average individually.
2. The emission levels of other frequencies were very low against the limit.
3. Margin value = Emission level - Limit value
4. Correction factor = Insertion loss + Cable loss
5. Emission Level = Correction Factor + Reading Value.

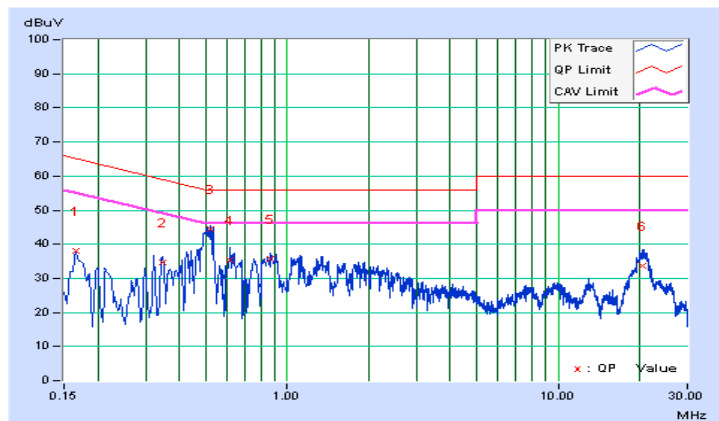



### 4.3 6dB Bandwidth Measurement

#### 4.3.1 Limits of 6dB Bandwidth Measurement

The minimum of 6dB Bandwidth Measurement is 0.5 MHz.

#### 4.3.2 Test Setup

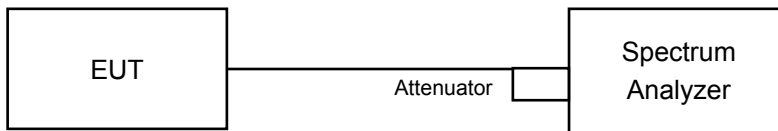

#### 4.3.3 Test Instruments

Refer to section 4.1.2 to get information of above instrument.

#### 4.3.4 Test Procedure

- Set resolution bandwidth (RBW) = 100kHz
- Set the video bandwidth (VBW)  $\geq 3 \times$  RBW, Detector = average.
- Trace mode = max hold.
- Sweep = auto couple.
- Measure the maximum width of the emission that is constrained by the frequencies associated with the two amplitude points (upper and lower) that are attenuated by 6 dB relative to the maximum level measured in the fundamental emission

#### 4.3.5 Deviation from Test Standard

No deviation.

#### 4.3.6 EUT Operating Conditions

The software provided by client to enable the EUT under transmission condition continuously at lowest, middle and highest channel frequencies individually.

### 4.3.7 Test Result

Channel	Frequency (MHz)	6dB Bandwidth (kHz)	Minimum Limit (MHz)	Pass / Fail
0	2402	651.80	0.5	Pass
19	2440	653.96	0.5	Pass
39	2480	653.58	0.5	Pass

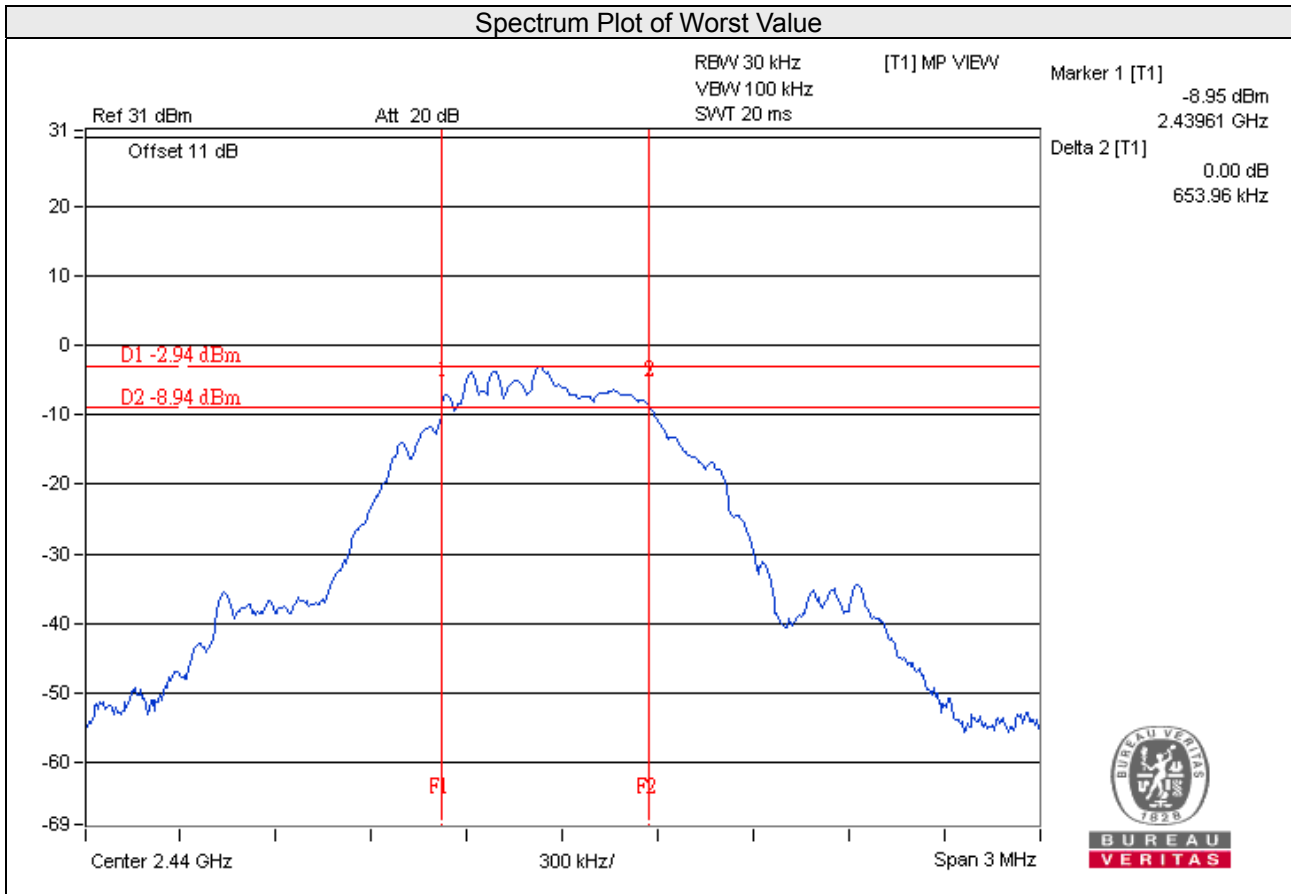

#### 4.4 Conducted Output Power Measurement

##### 4.4.1 Limits of Conducted Output Power Measurement

For systems using digital modulation in the 2400–2483.5 MHz bands: 1 Watt (30dBm)

##### 4.4.2 Test Setup

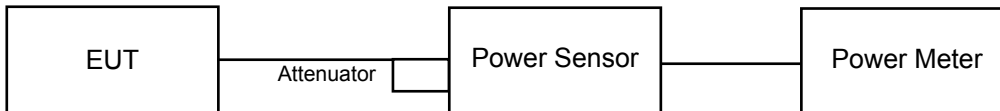

##### 4.4.3 Test Instruments

Refer to section 4.1.2 to get information of above instrument.

##### 4.4.4 Test Procedures

An average power sensor was used on the output port of the EUT. A power meter was used to read the response of the average power sensor. Record the power level.

##### 4.4.5 Deviation from Test Standard

No deviation.

##### 4.4.6 EUT Operating Conditions

Same as Item 4.3.6.

##### 4.4.7 Test Results

Channel	Frequency (MHz)	Average Power (mW)	Average Power (dBm)	Limit (dBm)	Pass/Fail
0	2402	<b>1.026</b>	0.11	30	Pass
19	2440	1.014	0.06	30	Pass
39	2480	0.964	-0.16	30	Pass

## 4.5 Power Spectral Density Measurement

### 4.5.1 Limits of Power Spectral Density Measurement

The Maximum of Power Spectral Density Measurement is 8dBm.

### 4.5.2 Test Setup

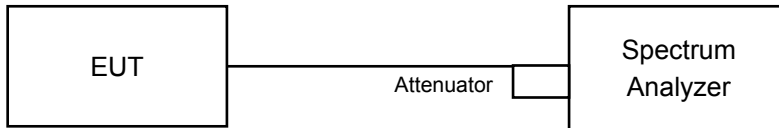

### 4.5.3 Test Instruments

Refer to section 4.1.2 to get information of above instrument.

### 4.5.4 Test Procedure

- a. Measure the duty cycle (x).
- b. Set instrument center frequency to DTS channel center frequency.
- c. Set span to at least 1.5 times the OBW.
- d. Set RBW to:  $3 \text{ kHz} \leq \text{RBW} \leq 100 \text{ kHz}$ .
- e. Set VBW  $\geq 3 \times \text{RBW}$ .
- f. Detector = power averaging (RMS) or sample detector (when RMS not available).
- g. Ensure that the number of measurement points in the sweep  $\geq 2 \times \text{span}/\text{RBW}$ .
- h. Sweep time = auto couple.
- i. Do not use sweep triggering. Allow sweep to "free run".
- j. Employ trace averaging (RMS) mode over a minimum of 100 traces.
- k. Use the peak marker function to determine the maximum amplitude level.
- l. Add  $10 \log (1/x)$ , where x is the duty cycle measured in step (a), to the measured PSD to compute the average PSD during the actual transmission time.

### 4.5.5 Deviation from Test Standard

No deviation.

### 4.5.6 EUT Operating Condition

Same as Item 4.3.6

#### 4.5.7 Test Results

Channel	Frequency (MHz)	PSD w/o Duty Factor (dBm/3kHz)	Duty Factor (dB)	Total PSD With Duty Factor (dBm/3kHz)	Limit (dBm/3kHz)	Pass / Fail
0	2402	-20.34	2.16	-18.18	8.00	Pass
19	2440	-19.67	2.16	-17.51	8.00	Pass
39	2480	-19.52	2.16	-17.36	8.00	Pass

Note: Refer to section 3.3 for duty cycle spectrum plot.

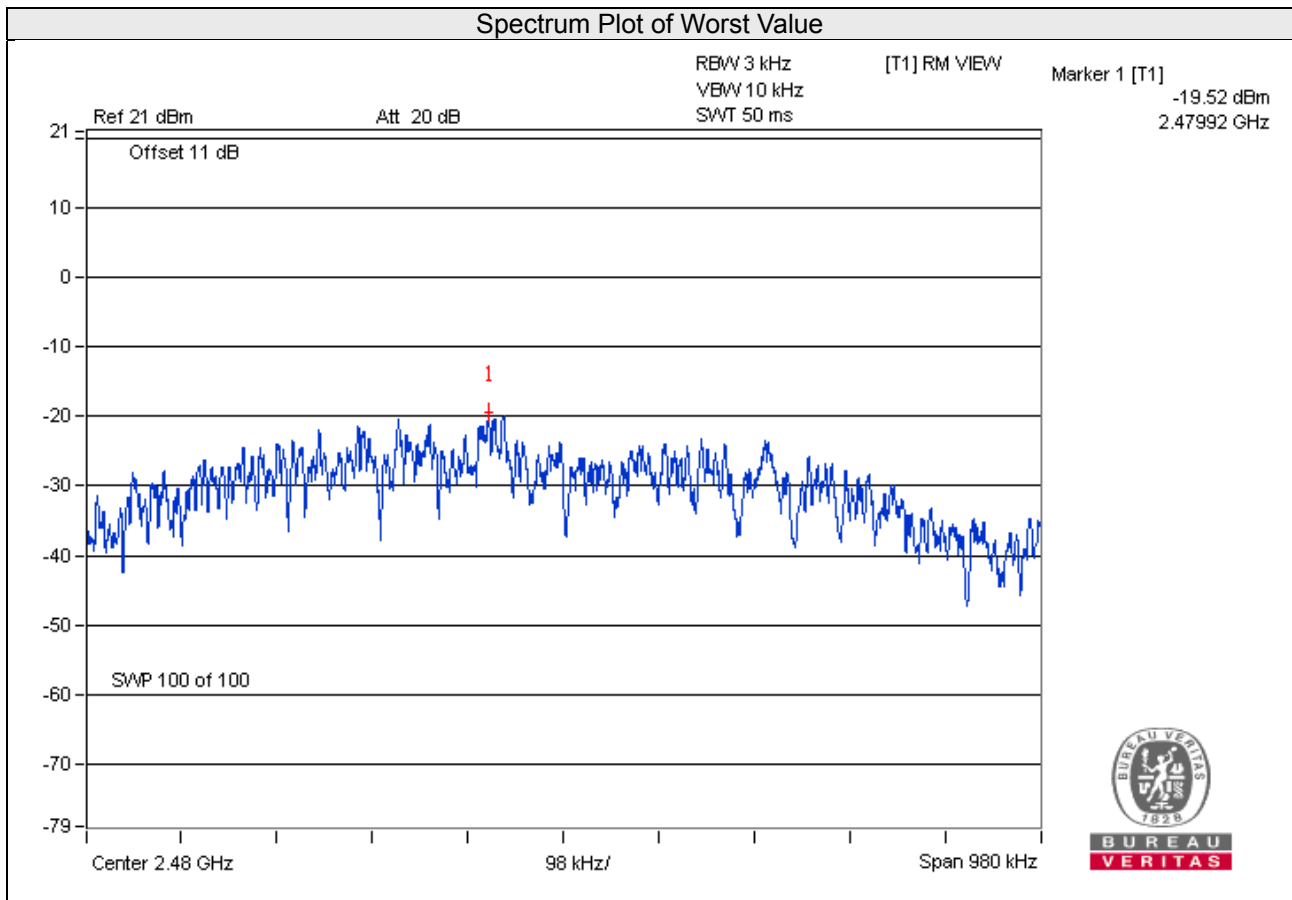

## 4.6 Conducted Out of Band Emission Measurement

### 4.6.1 Limits of Conducted Out of Band Emission Measurement

Below 30dB of the highest emission level of operating band (in 100kHz Resolution Bandwidth).

### 4.6.2 Test Setup

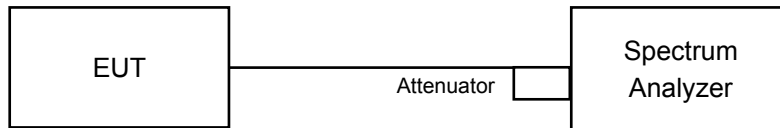

### 4.6.3 Test Instruments

Refer to section 4.1.2 to get information of above instrument.

### 4.6.4 Test Procedure

#### MEASUREMENT PROCEDURE REF

- Set the RBW = 100 kHz.
- Set the VBW  $\geq$  300 kHz.
- Detector = average.
- Sweep time = auto couple.
- Trace mode = max hold.
- Allow trace to fully stabilize.
- Use the peak marker function to determine the maximum power level in any 100 kHz band segment within the fundamental EBW.

#### MEASUREMENT PROCEDURE OOBE

- Set RBW = 100 kHz.
- Set VBW  $\geq$  300 kHz.
- Detector = average.
- Sweep = auto couple.
- Trace Mode = max hold.
- Allow trace to fully stabilize.
- Use the peak marker function to determine the maximum amplitude level.

#### **4.6.5 Deviation from Test Standard**

No deviation.

#### **4.6.6 EUT Operating Condition**

Same as Item 4.3.6

#### **4.6.7 Test Results**

The spectrum plots are attached on the following pages. D1 line indicates the highest level, and D2 line indicates the 30dB offset below D1. It shows compliance with the requirement.

### CH 0

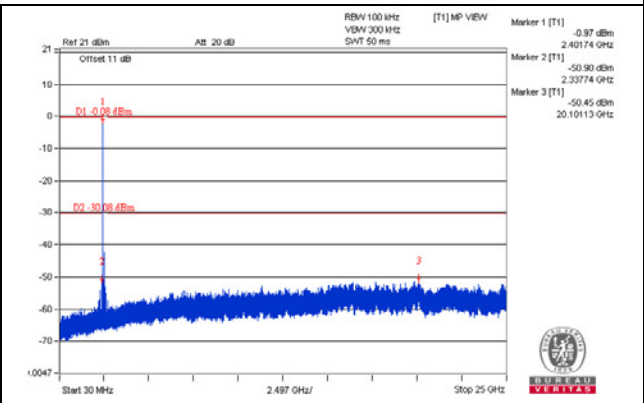
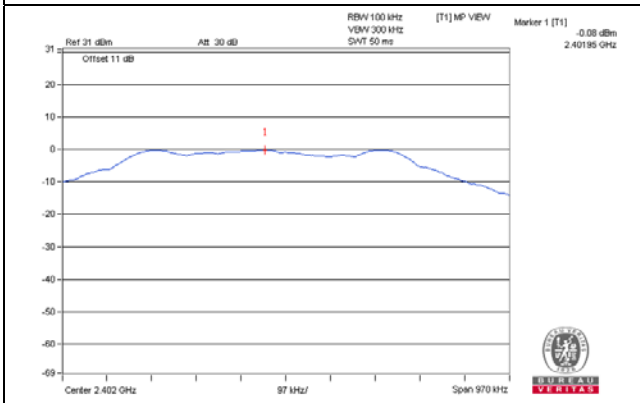

### CH 19

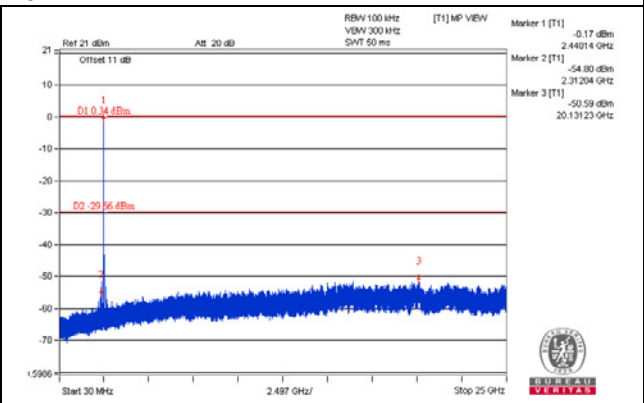
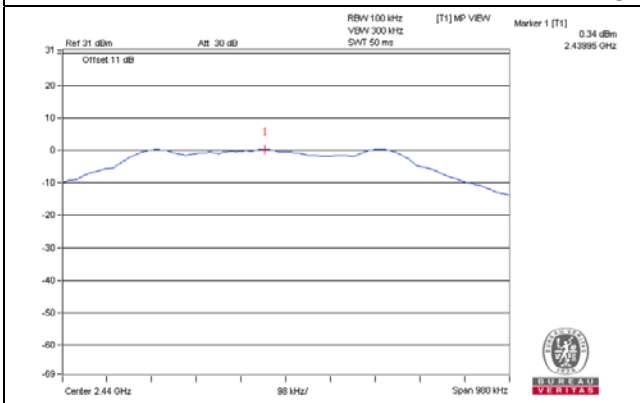

### CH 39

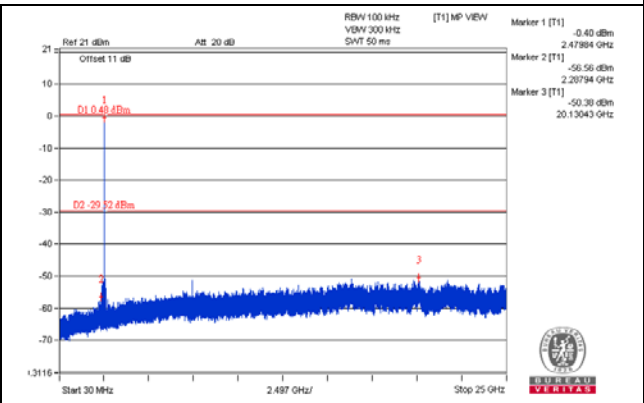
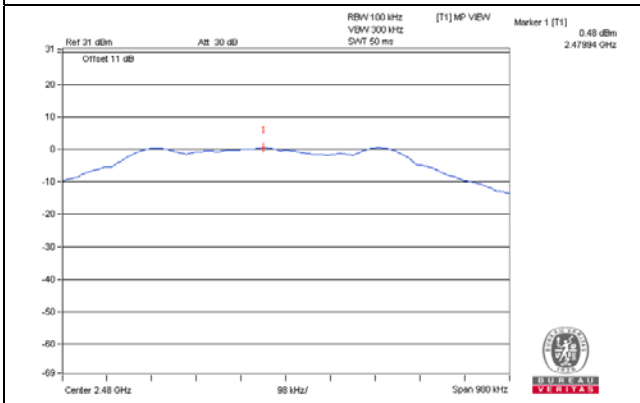

### CH 0 Band edge

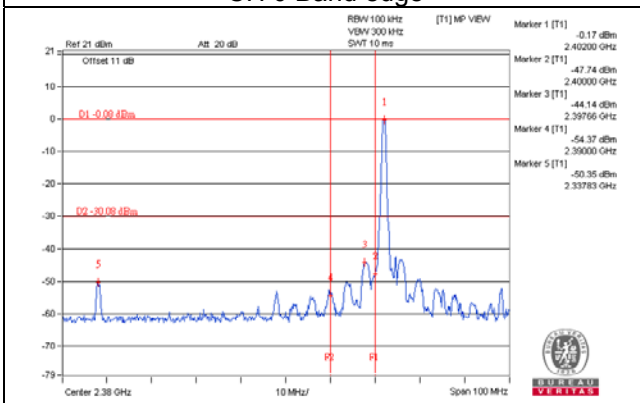

### CH 39 Band edge

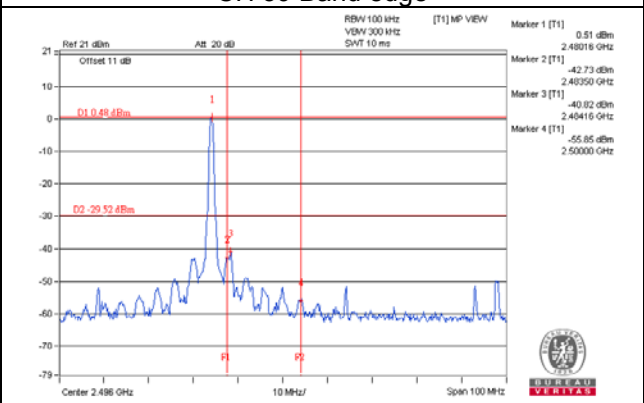



## 5 Pictures of Test Arrangements

Please refer to the attached file (Test Setup Photo).

## Appendix – Information on the Testing Laboratories

We, Bureau Veritas Consumer Products Services (H.K.) Ltd., Taoyuan Branch, were founded in 1988 to provide our best service in EMC, Radio, Telecom and Safety consultation. Our laboratories are accredited and approved according to ISO/IEC 17025.

If you have any comments, please feel free to contact us at the following:

### **Linko EMC/RF Lab**

Tel: 886-2-26052180

Fax: 886-2-26051924

### **Hsin Chu EMC/RF/Telecom Lab**

Tel: 886-3-6668565

Fax: 886-3-6668323

### **Hwa Ya EMC/RF/Safety Lab**

Tel: 886-3-3183232

Fax: 886-3-3270892

**Email:** [service.adt@tw.bureauveritas.com](mailto:service.adt@tw.bureauveritas.com)

**Web Site:** [www.bureauveritas-adt.com](http://www.bureauveritas-adt.com)

The address and road map of all our labs can be found in our web site also.

--- END ---