

# EMC Test Report

**Project Number: 3878032**

**Report Number: 3878032 EMC01**

**Revision Level: 2**

**Client: ADTRAN, Inc.**

**Equipment Under Test: Outdoor Wireless Access Point**

**Model Number: BSAP 2135**

**FCC ID: HDCBSAP2135**

**Applicable Standards: FCC Part 15 Subpart C, § 15.407**

**ANSI C63.10: 2013**

**Report issued on: 03 March 2016**

**Test Result: Compliant**

Tested by:

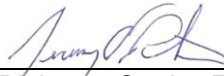
  
\_\_\_\_\_  
Jeremy O. Pickens, Senior EMC Engineer

Reviewed by:

  
\_\_\_\_\_  
David Schramm, EMC/RF/SAR/HAC Manager

**Remarks:**

This report details the results of the testing carried out on one sample, the results contained in this test report do not relate to other samples of the same product. The manufacturer should ensure that all products in series production are in conformity with the product sample detailed in this report.

This report may only be reproduced and distributed in full. If the product in this report is used in any configuration other than that detailed in the report, the manufacturer must ensure the new system complies with all relevant standards. Any mention of SGS International Electrical Approvals or Testing done by SGS International Electrical Approvals in connection with distribution or use of the product described in this report must be approved by SGS international Electrical Approvals in writing.

## Table of Contents

|          |   |           |
|----------|---|-----------|
| <b>1</b> | <b>SUMMARY OF TEST RESULTS</b> .....                      | <b>3</b>  |
| 1.1      | MODIFICATIONS REQUIRED FOR COMPLIANCE .....               | 3         |
| <b>2</b> | <b>GENERAL INFORMATION</b> .....                          | <b>4</b>  |
| 2.1      | CLIENT INFORMATION .....                                  | 4         |
| 2.1      | TEST LABORATORY .....                                     | 4         |
| 2.2      | GENERAL INFORMATION OF EUT .....                          | 4         |
| 2.3      | EUT CONNECTION BLOCK DIAGRAM.....                         | 5         |
| 2.4      | SYSTEM CONFIGURATIONS .....                               | 6         |
| <b>3</b> | <b>UNDESIRABLE EMISSIONS</b> .....                        | <b>7</b>  |
| 3.1      | TEST RESULT.....  | 7         |
| 3.2      | TEST METHOD.....  | 7         |
| 3.3      | TEST SITE .....   | 7         |
| 3.4      | TEST EQUIPMENT .....                                      | 7         |
| 3.5      | TEST DATA – ANTENNA P/N: M6060070MP13620 (1-6GHz) .....   | 8         |
| 3.6      | TEST DATA – ANTENNA P/N: M6060070MP13620 (6-18GHz).....   | 14        |
| 3.7      | TEST DATA – ANTENNA P/N: M6060070MP13620 (18-40GHz).....  | 20        |
| 3.8      | TEST DATA – ANTENNA P/N: M6013070P30006I (1-6GHz) .....   | 26        |
| 3.9      | TEST DATA – ANTENNA P/N: M6013070P30006I (6-18GHz) .....  | 32        |
| 3.10     | TEST DATA – ANTENNA P/N: M6013070P30006I (18-40GHz) ..... | 38        |
| 3.11     | TEST DATA – ANTENNA P/N: M5016019D30006I (1-6GHz).....    | 44        |
| 3.12     | TEST DATA – ANTENNA P/N: M5016019D30006I (6-18GHz).....   | 50        |
| 3.13     | TEST DATA – ANTENNA P/N: M5016019D30006I (18-40GHz).....  | 56        |
| 3.14     | TEST DATA – TABULAR RESULTS.....                          | 62        |
| <b>4</b> | <b>REVISION HISTORY</b> .....                             | <b>63</b> |
|          | <b>APPENDIX A: POWER ADJUSTMENT REQUIREMENTS</b> .....    | <b>64</b> |

## 1 Summary of Test Results

| Test Description            | Test Specification | Test Result |
|-----------------------------|--------------------|-------------|
| Occupied Bandwidth          | 15.407             | NS(1)       |
| Spectral Density            | 15.407(5)          | NS(1)       |
| Peak Power Output           | 15.407(4)          | NS(1)(2)    |
| Peak Excursion              | 15.407(6)          | NS(1)       |
| Radiated Spurious Emissions | 15.407(b)          | Compliant   |

(1) This evaluation is to support a Class II Permissive Change. Refer to original filing for results.

(2) In order to maintain compliance when using the higher gain antennas, the power must be reduced. These calculations are included in Appendix A.

### 1.1 *Modifications Required for Compliance*

None

## 2 General Information

### 2.1 Client Information

Name: ADTRAN, Inc.  
 Address: 901 Explorer Blvd.  
 City, State, Zip, Country: Huntsville, AL 35806

### 2.1 Test Laboratory

Name: SGS North America, Inc.  
 Address: 620 Old Peachtree Road NW, Suite 100  
 City, State, Zip, Country: Suwanee, GA 30024, USA

Accrediting Body: A2LA  
 Type of lab: Testing Laboratory  
 Certificate Number: 3212.01

### 2.2 General Information of EUT

Type of Product: Outdoor Wireless Access Point  
 Model: BSAP-2135  
 Serial Number: 21352615050002

Frequency Range: 5150 to 5250 MHz and 5725 to 5825MHz  
 Data Modes: 802.11a, 802.11n (HT20), 802.11n (HT40), 802.11ac (VHT20), 802.11ac (VHT40), 802.11ac (VHT80)  
 Antenna: TerraWave, 2.4/5 GHz, 6/7 dBi Dual Band MIMO Patch Antenna (P/N: M6060070MP13620)  
 TerraWave, 2.4/5 GHz, 13/7 dBi High Density MIMO Patch Array (P/N: M6013070P30006I)  
 TerraWave, 5 GHz, 19 dBi Triple Polarization Directional Antenna (P/N: M5016019D30006I)

Rated Voltage: 48Vdc (PoE)

Sample Received Date: 16 September 2015  
 Dates of testing: 05 – 27 October 2015

### Operating Modes and Conditions

For spurious emissions measurements, only the worst-case mode with respect to peak power from the original filing was investigated: 802.11a, 6Mbps. Three different antennas (described in Section 2.2) were used to evaluate the low, middle, and high channels in each the 5150-5250MHz band and the 5725-5825MHz band.

Continuous traffic was generated using iPerf software which established communication between a laptop on the wired side of the access point and a second laptop connected wirelessly to the access point. Software was provided that allowed the access point to be fixed on each channel under investigation.

### 2.3 EUT Connection Block Diagram

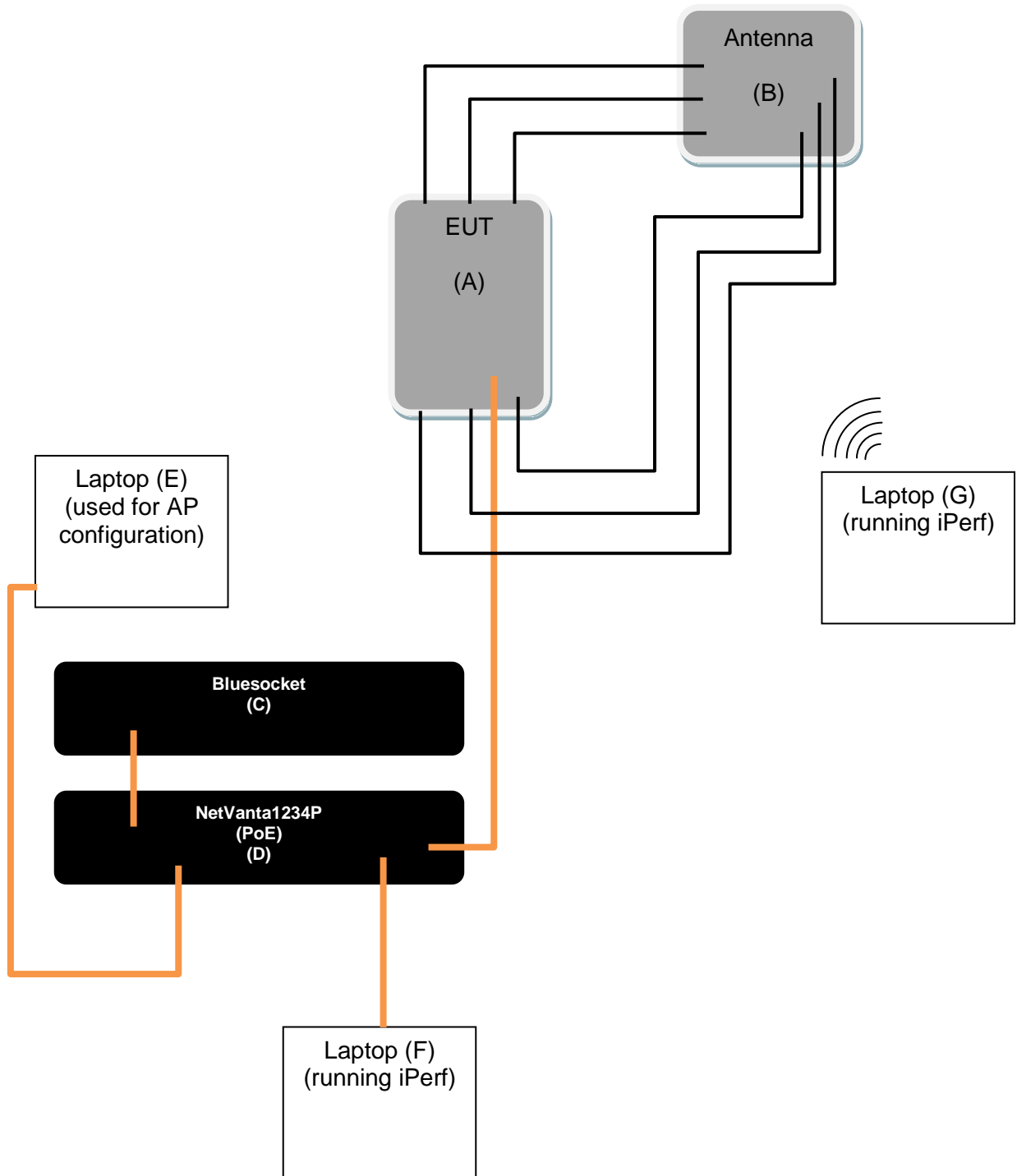

## 2.4 System Configurations

| Device reference | Manufacturer | Description                                 | Model Number    | Serial Number            |
|------------------|--------------|---|-----------------|--------------------------|
| A                | ADTRAN, Inc. | Outdoor Access Point                        | BSAP-2135       | 21352615050002           |
| B                | TerraWave    | Dual Band MIMO Patch                        | M6060070MP13620 | Not Labeled              |
|                  | TerraWave    | High Density MIMO Patch Array               | M6013070P30006I | Not Labeled              |
|                  | TerraWave    | Triple Polarization Directional (5GHz only) | M5016019D30006I | Not Labeled              |
| C                | ADTRAN, Inc. | Bluesocket                                  | 1700900F2       | 80031315020001           |
| D                | ADTRAN, Inc. | NetVanta 1234P                              | 1703595G1       | Not Labeled              |
| E                | Dell         | Laptop                                      | Latitude D610   | CN-0XD762-48643-629-0517 |
| F                | Lenovo       | Laptop                                      | T60             | L3-PV518                 |
| G                | Lenovo       | Laptop                                      | T420            | R8-X9XFV                 |

### 3 Undesirable Emissions

#### 3.1 Test Result

| Test Description   | Test Specification             | Test Result |
|--------------------|--------------------------------|-------------|
| Spurious Emissions | 15.407(b)<br>ANSI C63.10: 2013 | Compliant   |

#### 3.2 Test Method

Testing was performed using the radiated methods defined in ANSI C63.10: 2013 and KDB 789033 D02 General UNII Test Procedures New Rules v01r01

Limit:

The limit is -27dBm/MHz or 68.2 dBuV/m @3m (applying 95.2dB correction)

#### 3.3 Test Site

SGS EMC Laboratory, Suwanee, GA

Environmental Conditions

Temperature: 22.2 – 24.1 °C

Relative Humidity: 32.4 - 42.6 %

#### 3.4 Test Equipment

Final Test Date: 22-Oct-2015

Tester: JOP

| Equipment                          | Model             | Manufacturer    | Asset Number | Cal Due Date |
|------------------------------------|-------------------|-----------------|--------------|--------------|
| EMI TEST RECEIVER                  | ESU8              | ROHDE & SCHWARZ | B085759      | 9-Jul-2016   |
| EMI TEST RECEIVER                  | ESU40             | ROHDE & SCHWARZ | B079629      | 4-Aug-2016   |
| DRG HORN (MEDIUM)                  | 3117              | ETS-LINDGREN    | B079691      | 9-Jul-2016   |
| SMALL HORN ANTENNA                 | LB-180400-20-C-KF | A-INFOMW        | 15007        | 11-Mar-2016  |
| DESKTOP AMPLIFIER 1-18 GHZ         | NSP1800-25-HG     | MITEQ           | B085930      | 30-Mar-2016  |
| PREAMPLIFIER-ANTENNA SYS           | TS-PR18           | ROHDE & SCHWARZ | B094463      | 13-Feb-2016  |
| FIXED GAIN AMPLIFIER               | NSP1840-HG        | MITEQ           | B087572      | 15-Oct-2016  |
| RF CABLE - 7000MM (10KHZ - 18GHZ)  | SF106             | HUBER&SUHNER    | B079712      | 3-Aug-2016   |
| DRG HORN (MEDIUM)                  | 3117              | ETS-LINDGREN    | B079691      | 9-Jul-2016   |
| RF CABLE - 7500MM (10KHZ - 18GHZ)  | SF106             | HUBER&SUHNER    | B079713      | 3-Aug-2016   |
| 10DB ATTENUATOR                    | 10DB              | ROHDE & SCHWARZ | B095594      | 5-Aug-2016   |
| RF CABLE - 12000MM (10KHZ - 18GHZ) | SF106             | HUBER&SUHNER    | B079717      | 3-Aug-2016   |
| COAXIAL CABLE                      | SUCOFLEX 102      | HUBER&SUHNER    | B079824      | 4-Aug-2016   |
| COAXIAL CABLE                      | SUCOFLEX 102      | HUBER&SUHNER    | B079823      | 4-Aug-2016   |
| FILTER                             | HPM50112          | MICRO-TRONICS   | B093647      | 5-Aug-2016   |
| HIGH PASS FILTER                   | HPM50111          | MICRO-TRONICS   | B085747      | 5-Aug-2016   |

Note: The calibration period equipment is 1 year.

### 3.5 Test Data – Antenna P/N: M6060070MP13620 (1-6GHz)

CH 36 6MB/s

Vertical

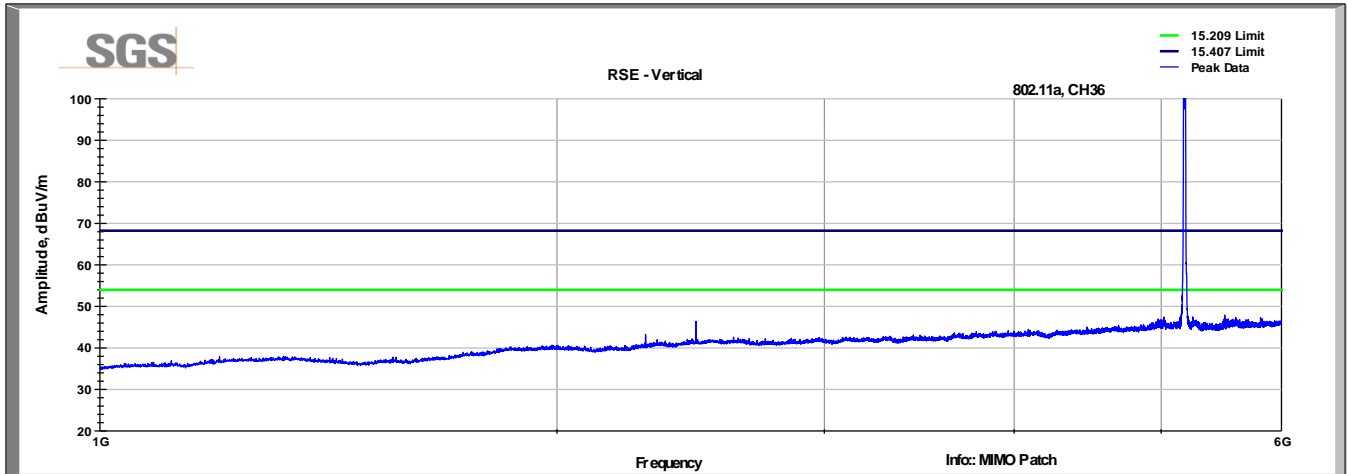

Horizontal

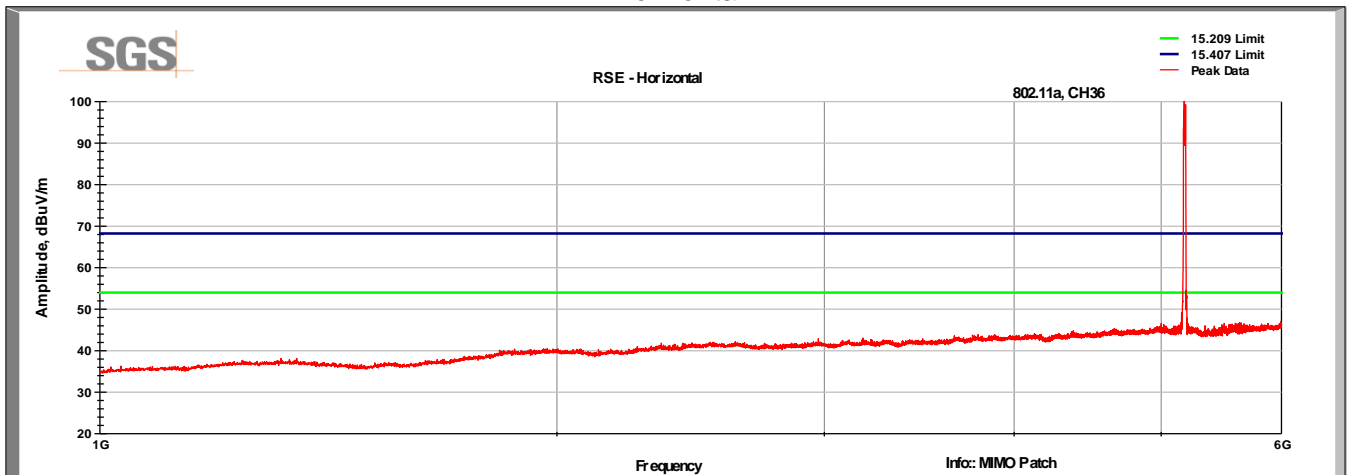



CH 40 6MB/s  
Vertical

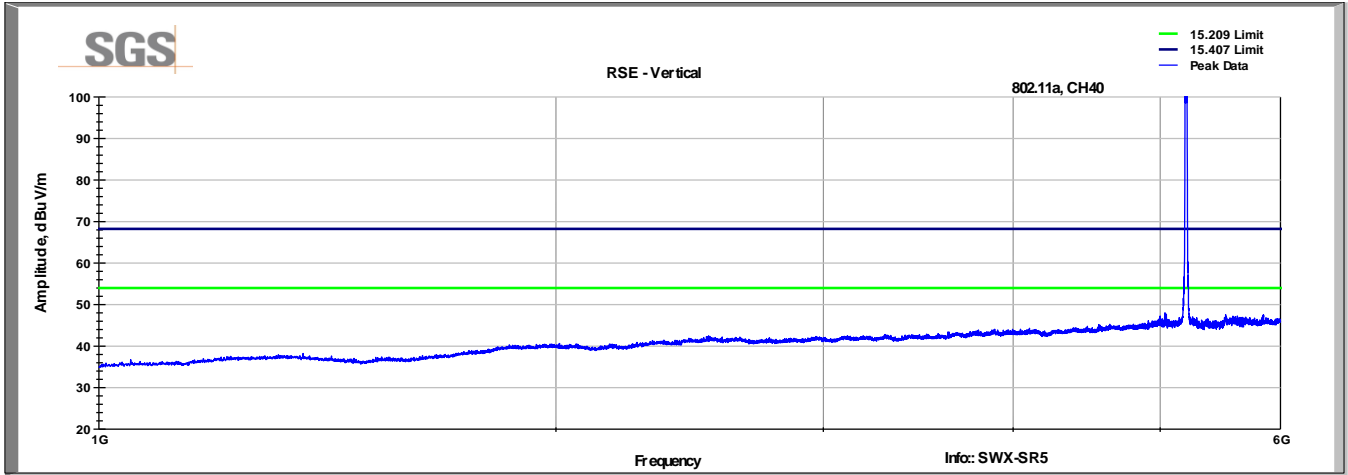

Horizontal

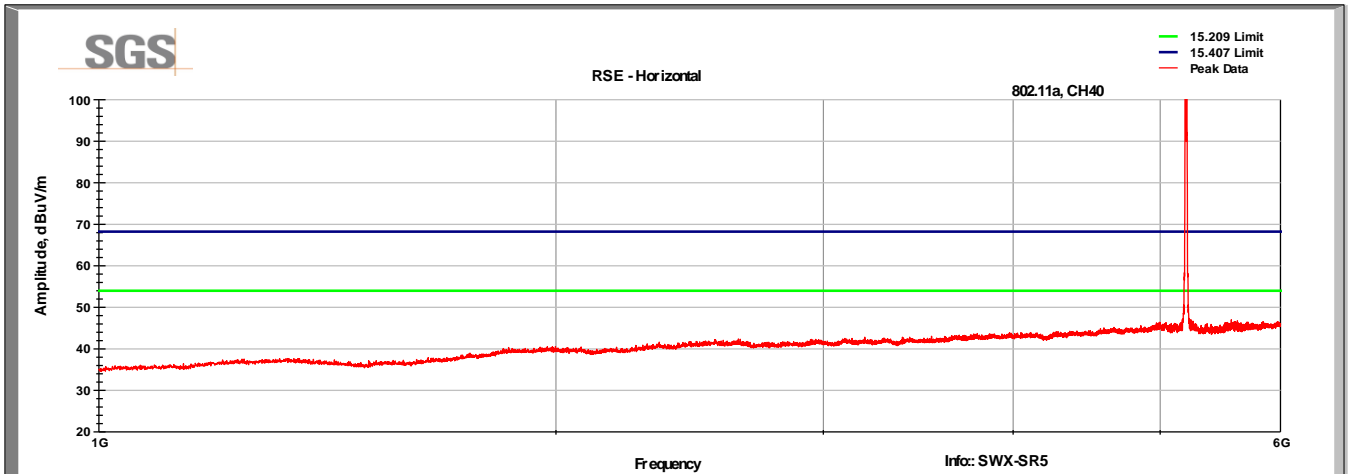

CH 48 6MB/s  
Vertical

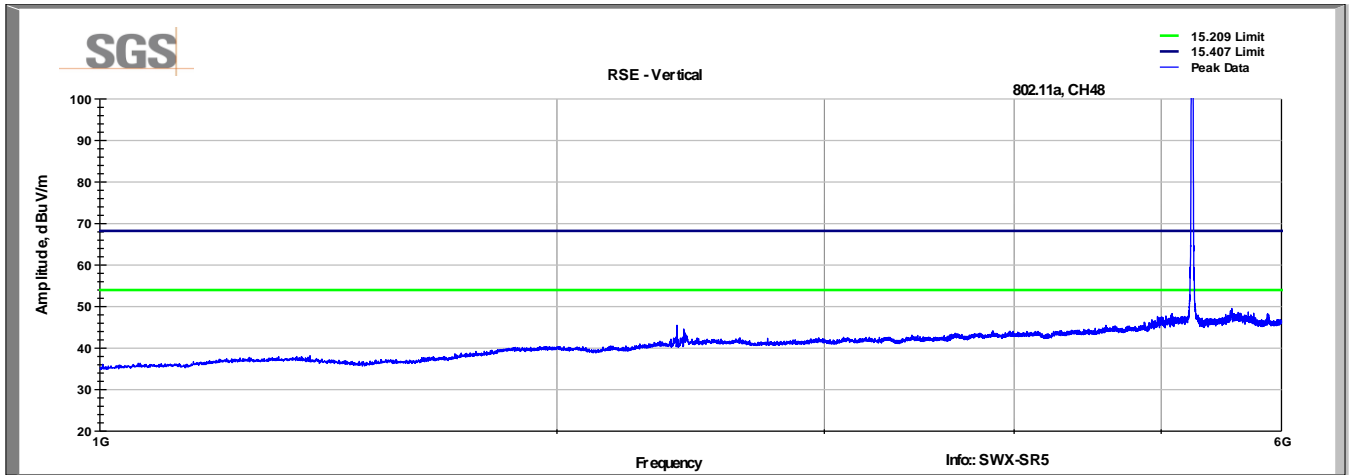

Horizontal

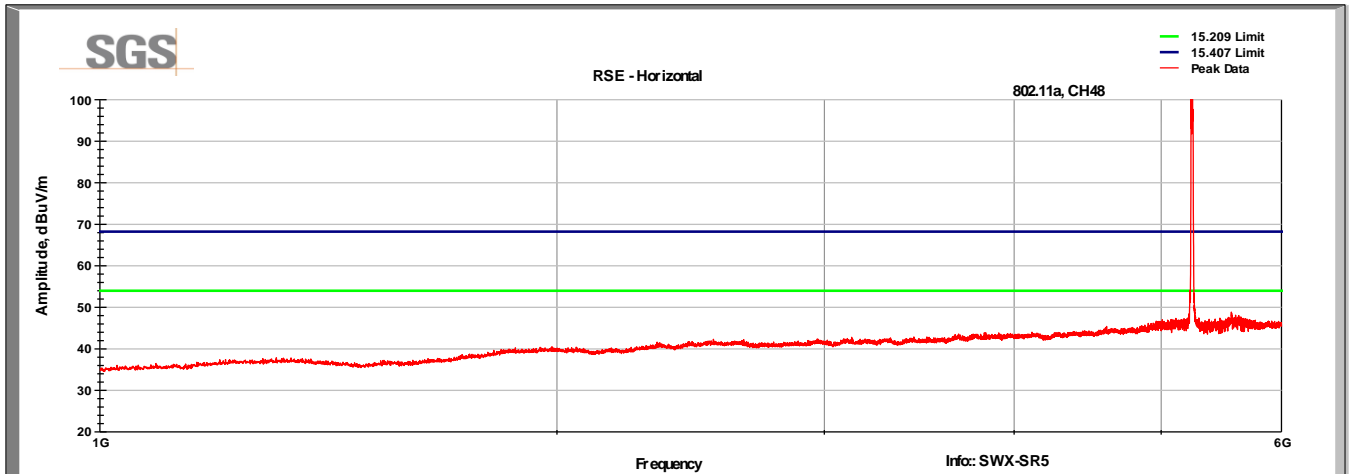

CH 149 6MB/s  
Vertical

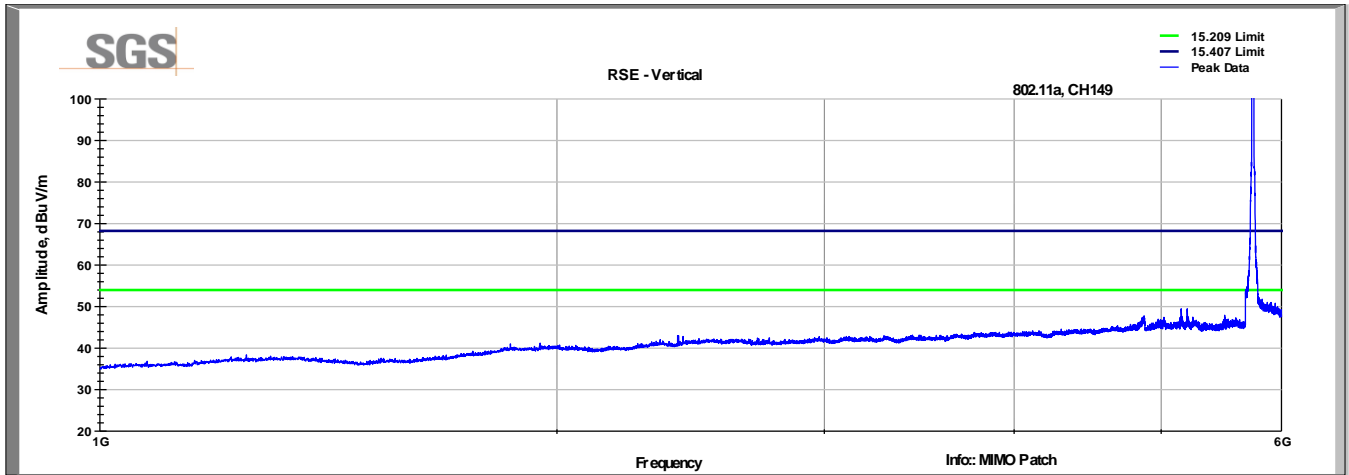

Horizontal

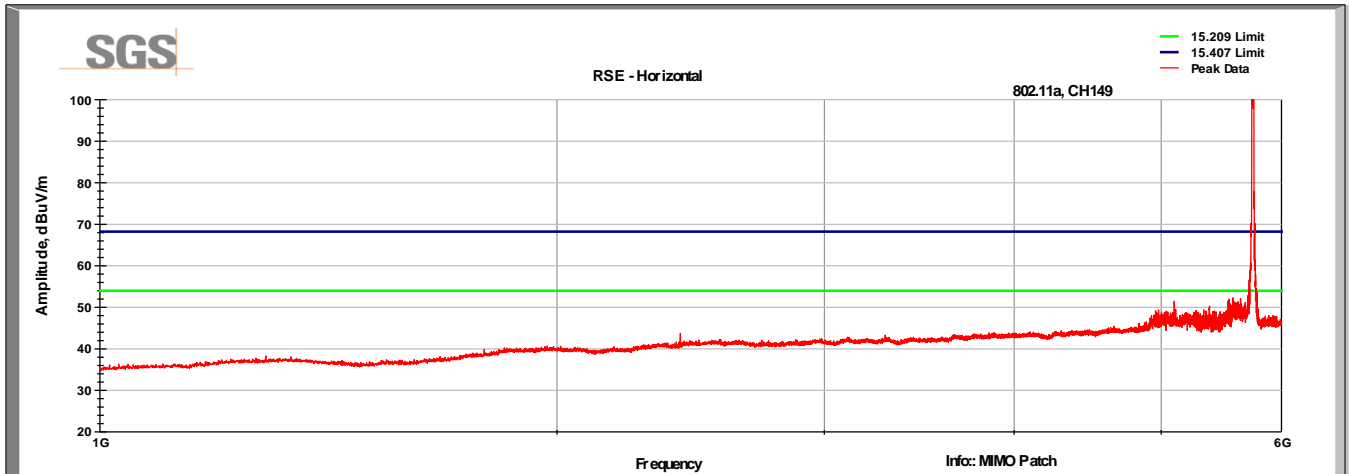

CH 153 6MB/s  
Vertical

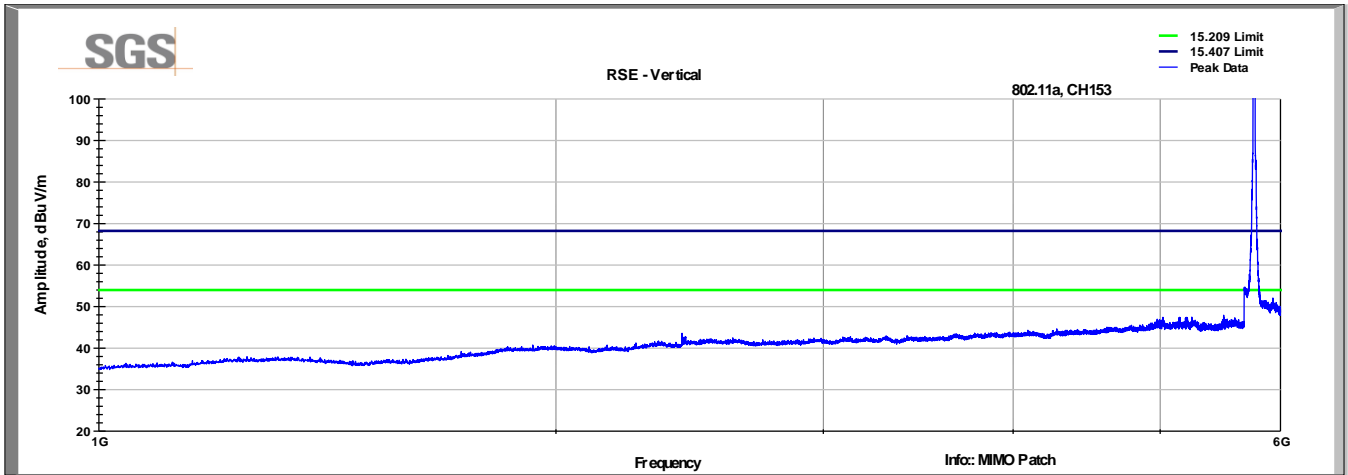

Horizontal

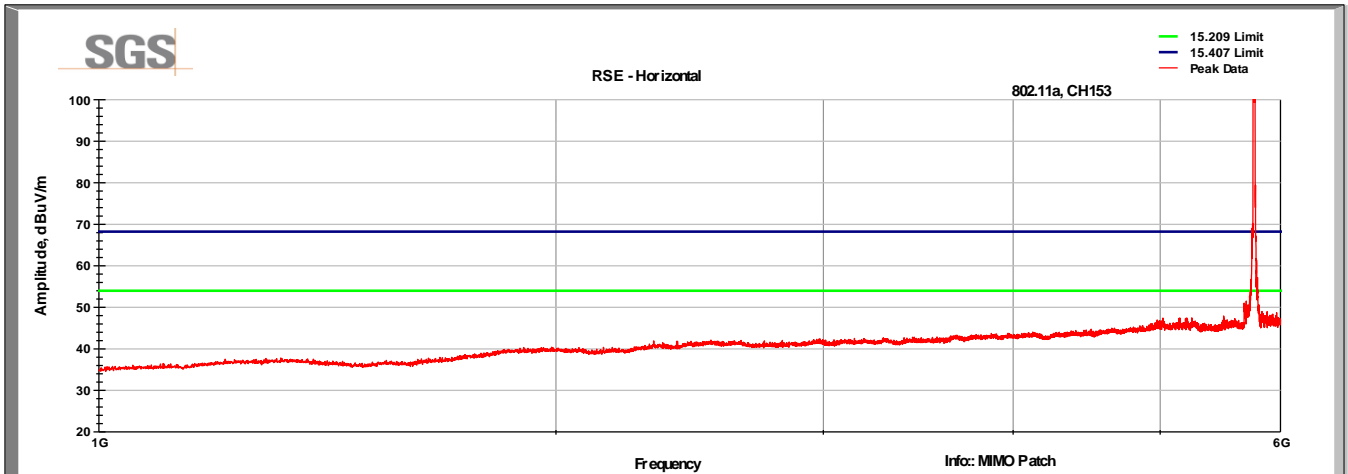

CH 161 6MB/s  
Vertical

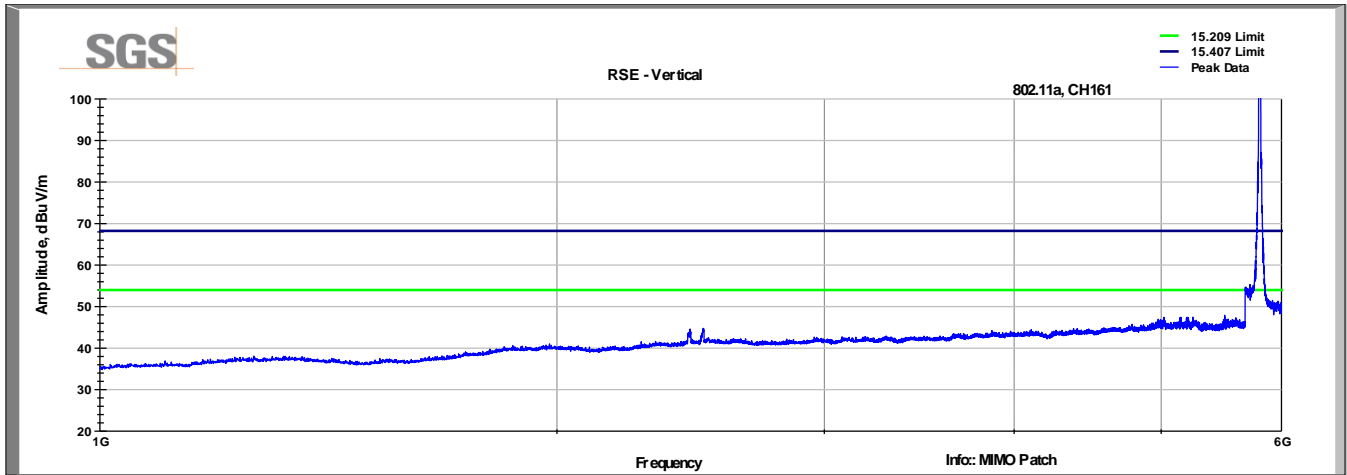

Horizontal

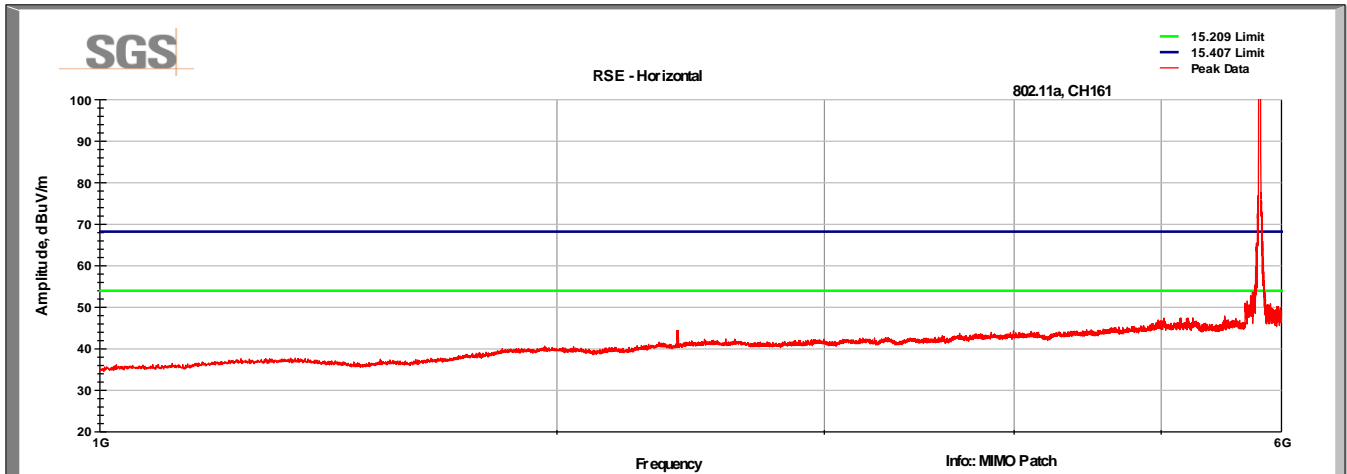

### 3.6 Test Data – Antenna P/N: M6060070MP13620 (6-18GHz)

CH 36 6MB/s

Vertical

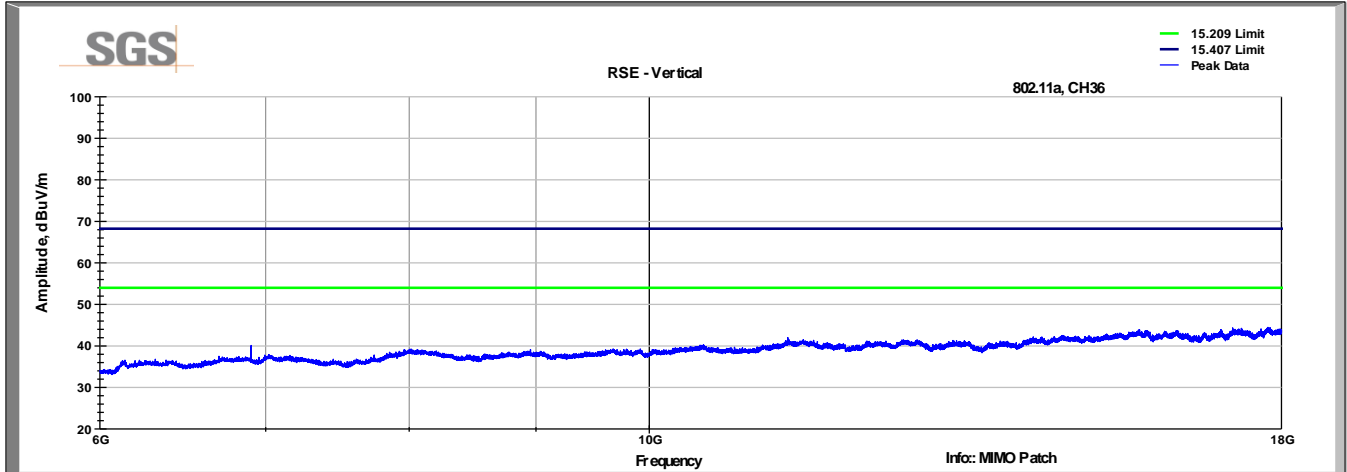

Horizontal

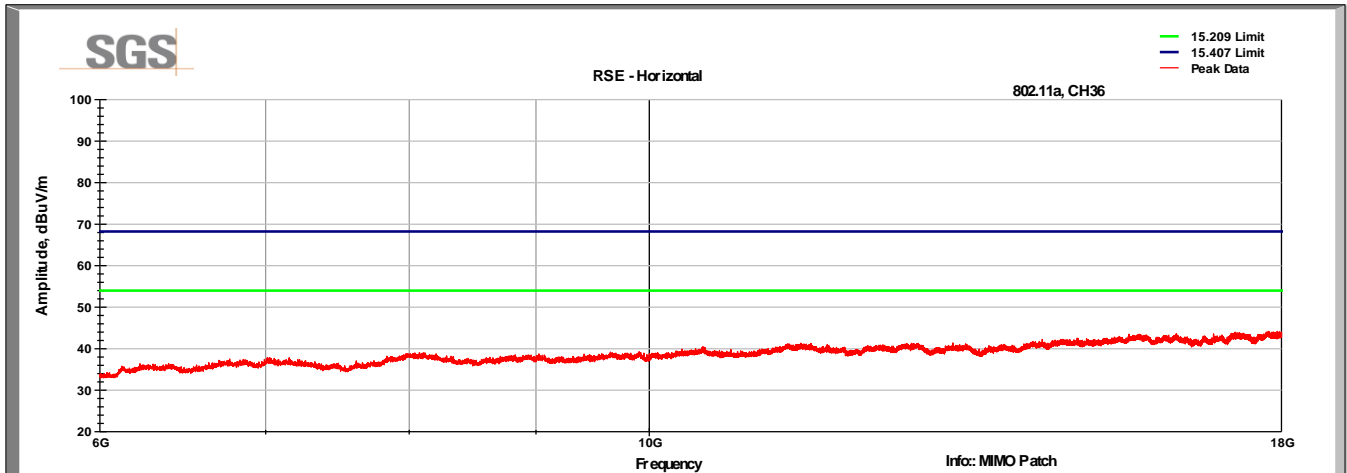

CH 40 6MB/s  
Vertical

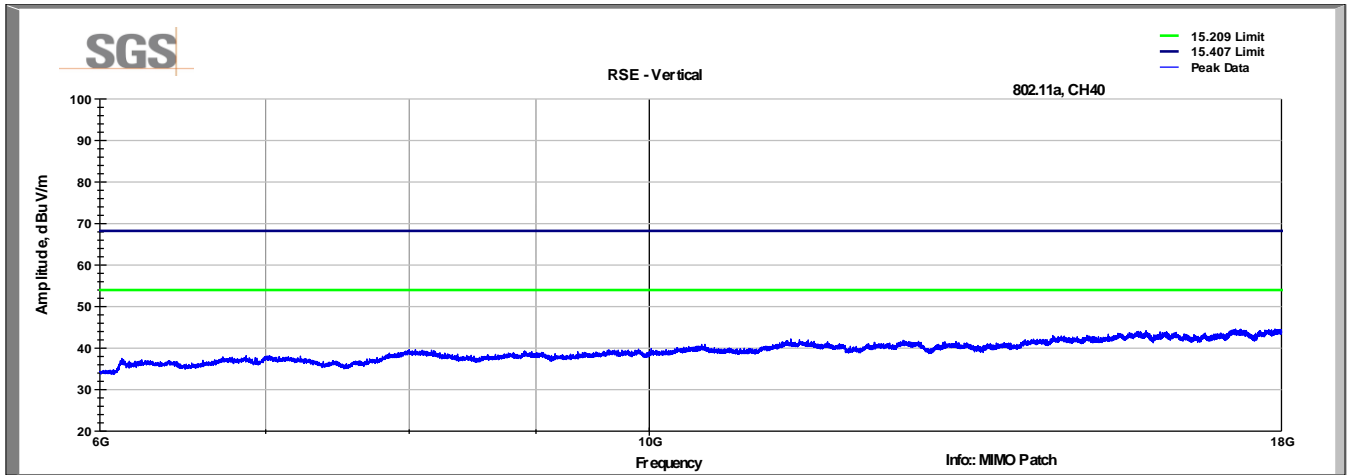

Horizontal

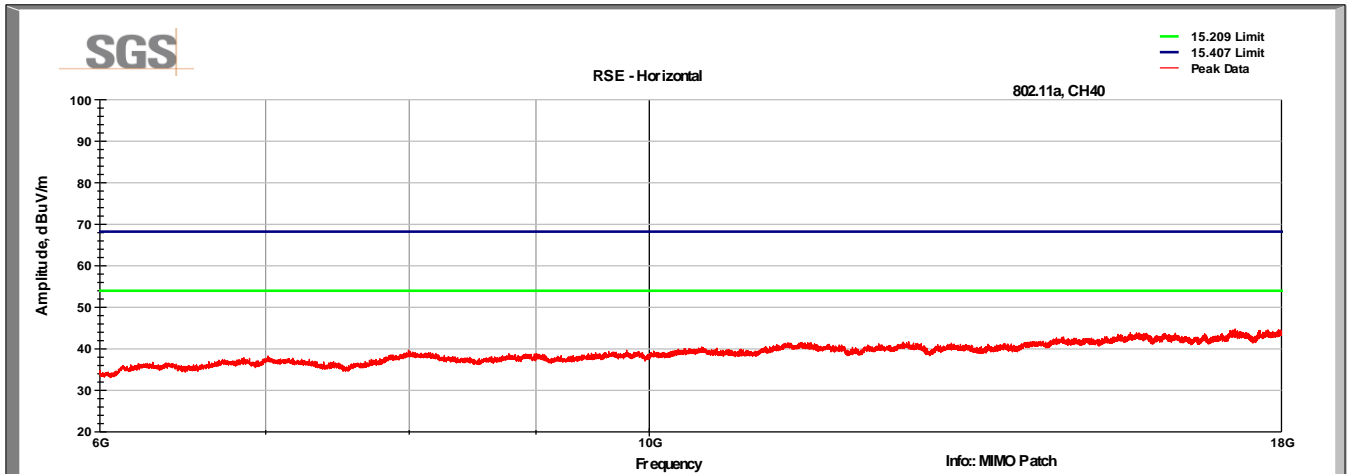

### CH 48 6MB/s Vertical

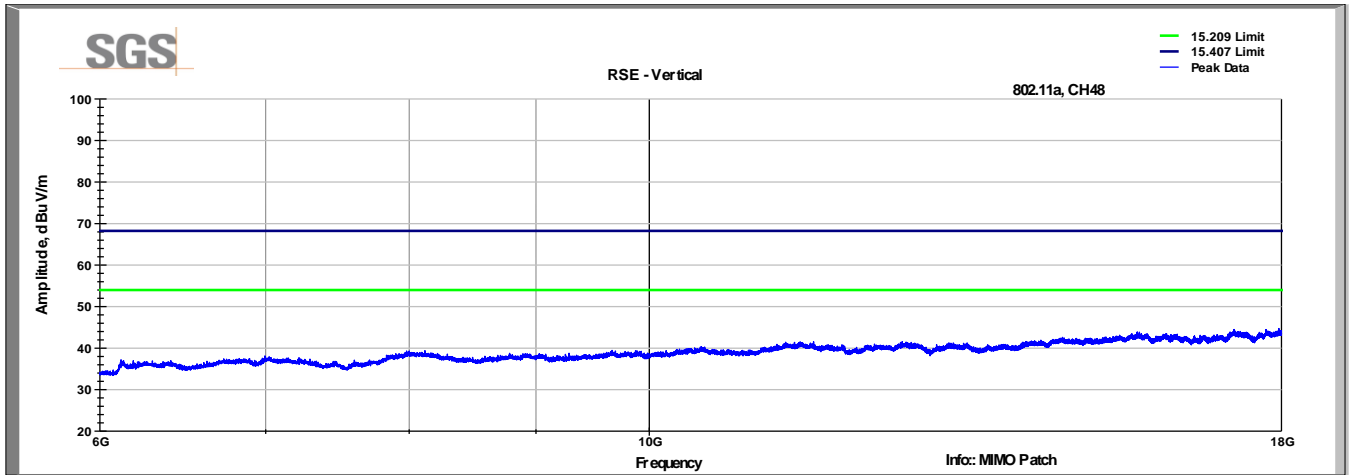

### Horizontal

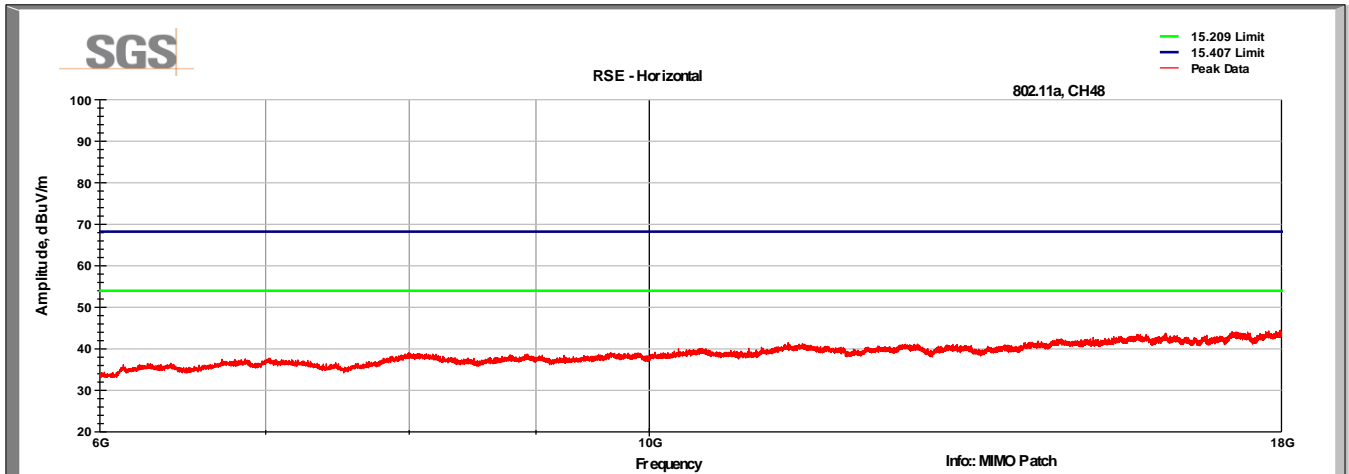



CH 149 6MB/s  
Vertical

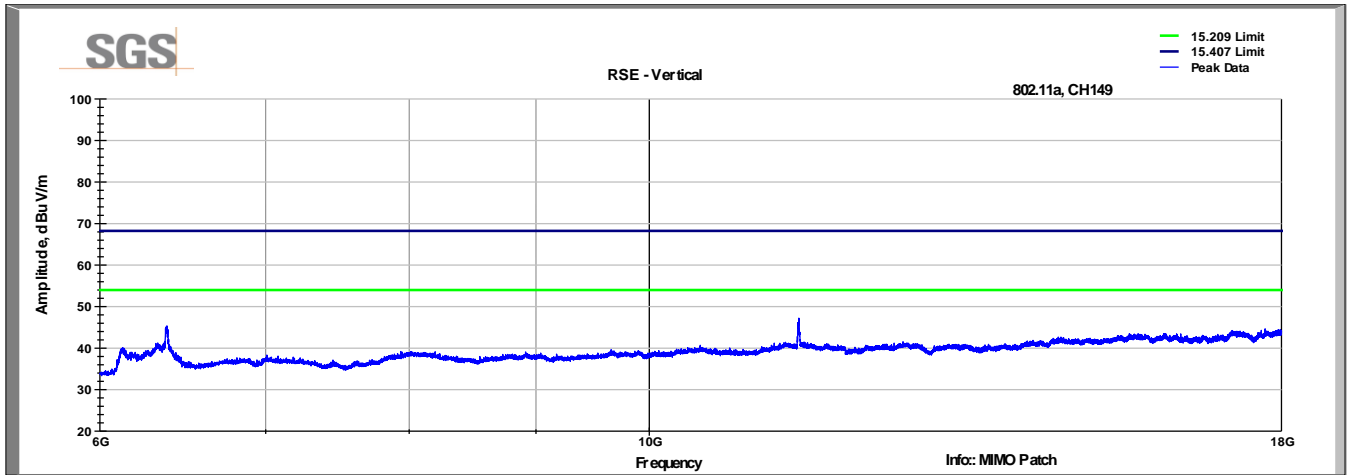

Horizontal

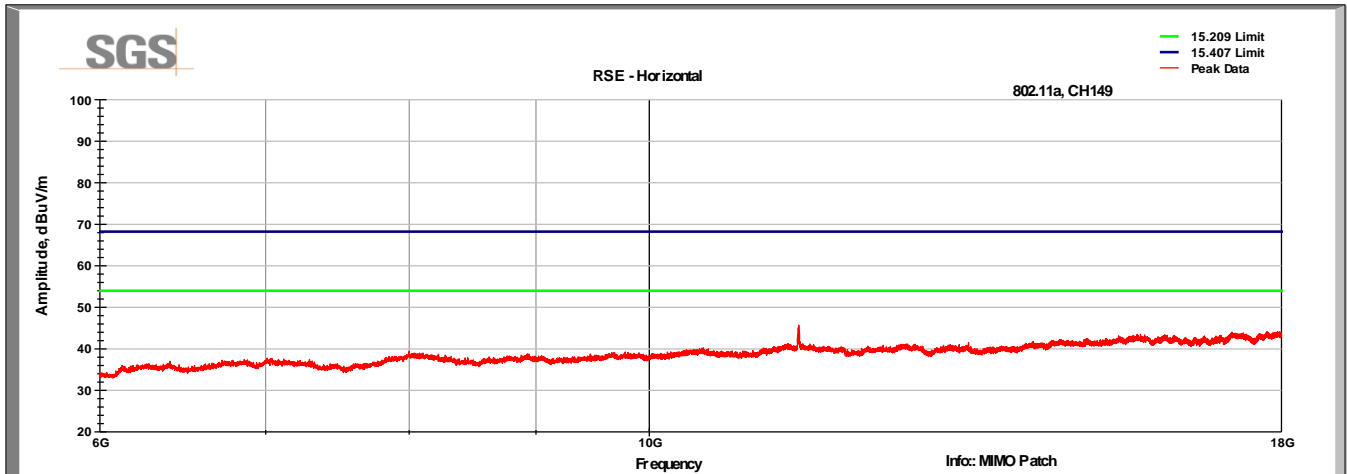

### CH 153 6MB/s Vertical

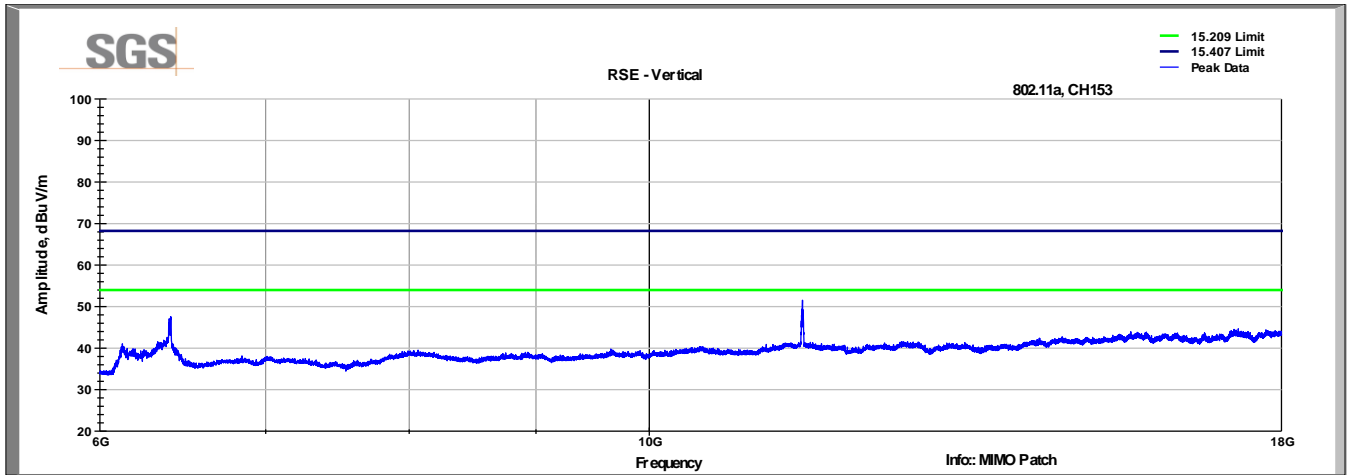

### Horizontal

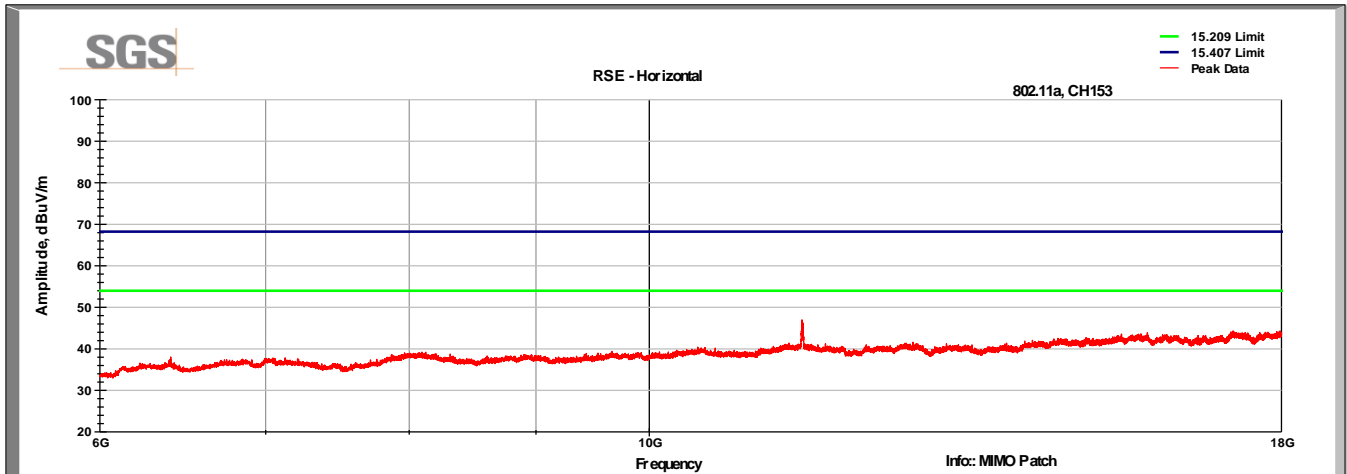

CH 161 6MB/s  
Vertical

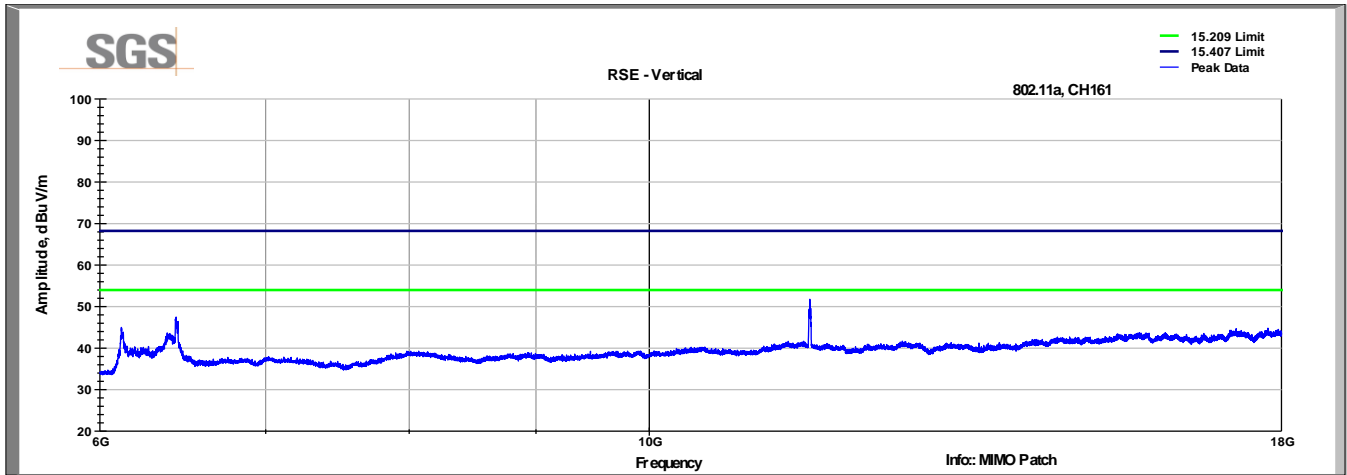

Horizontal

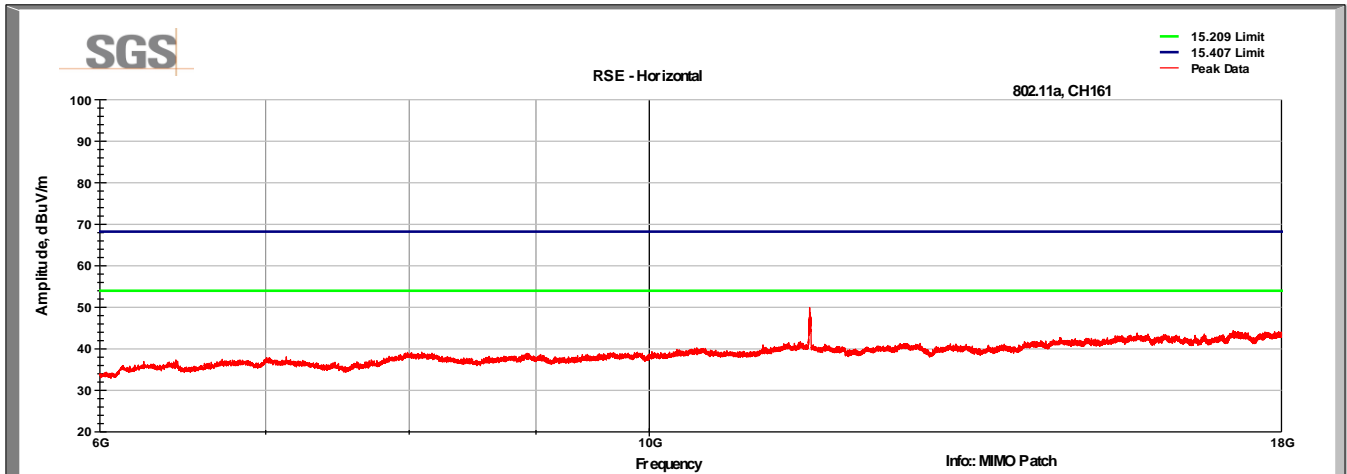

### 3.7 Test Data – Antenna P/N: M6060070MP13620 (18-40GHz)

CH 36 6MB/s

Vertical

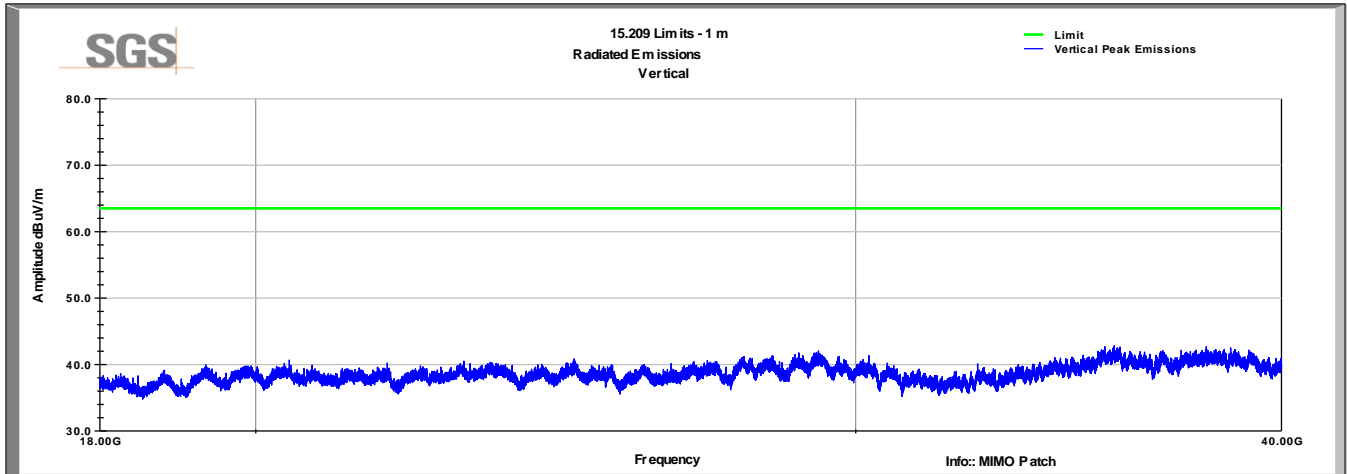

Horizontal

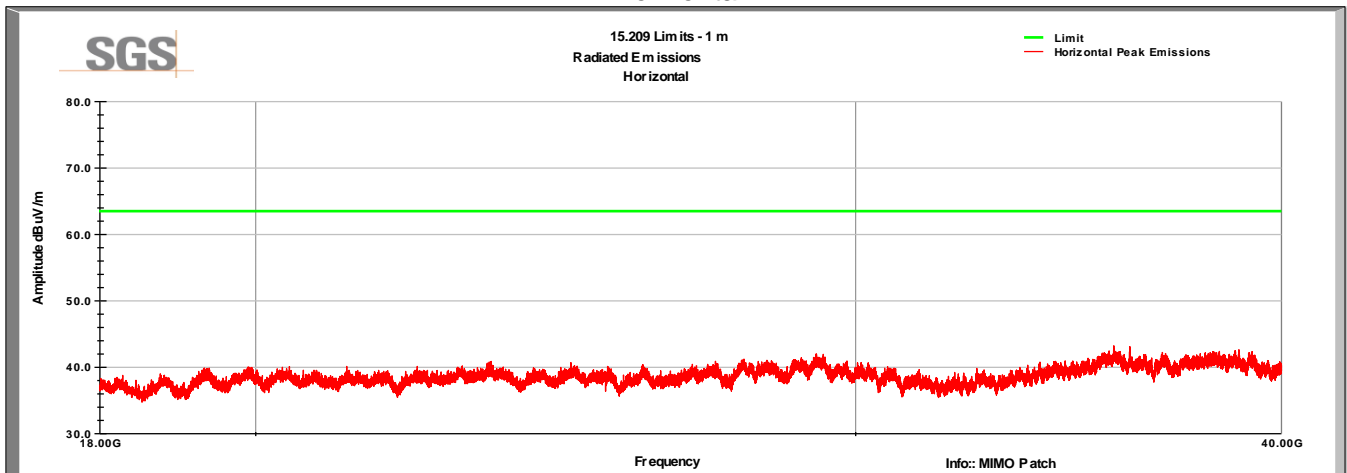

CH 40 6MB/s  
Vertical

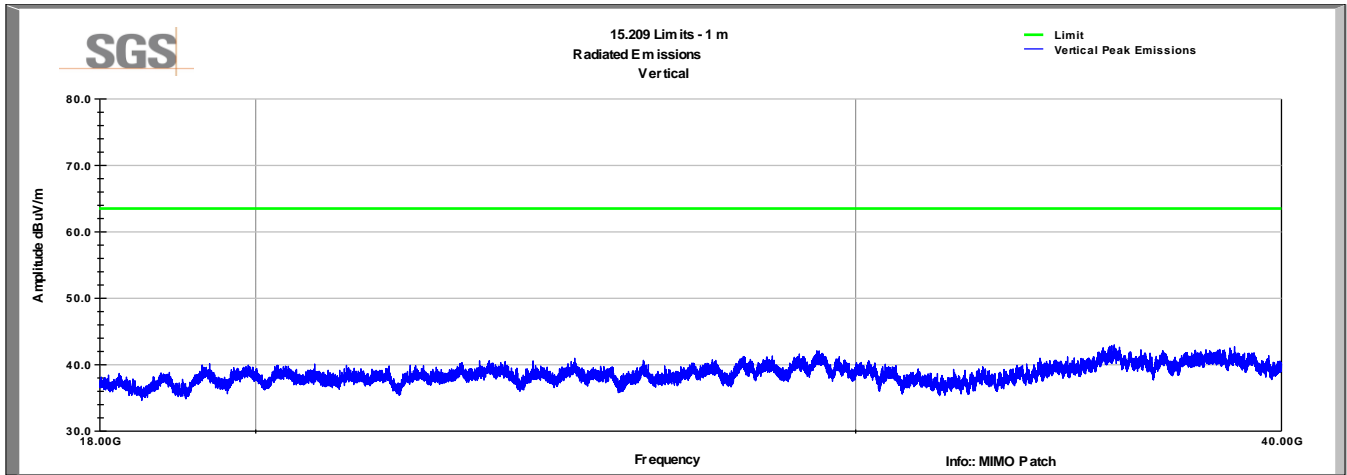

Horizontal

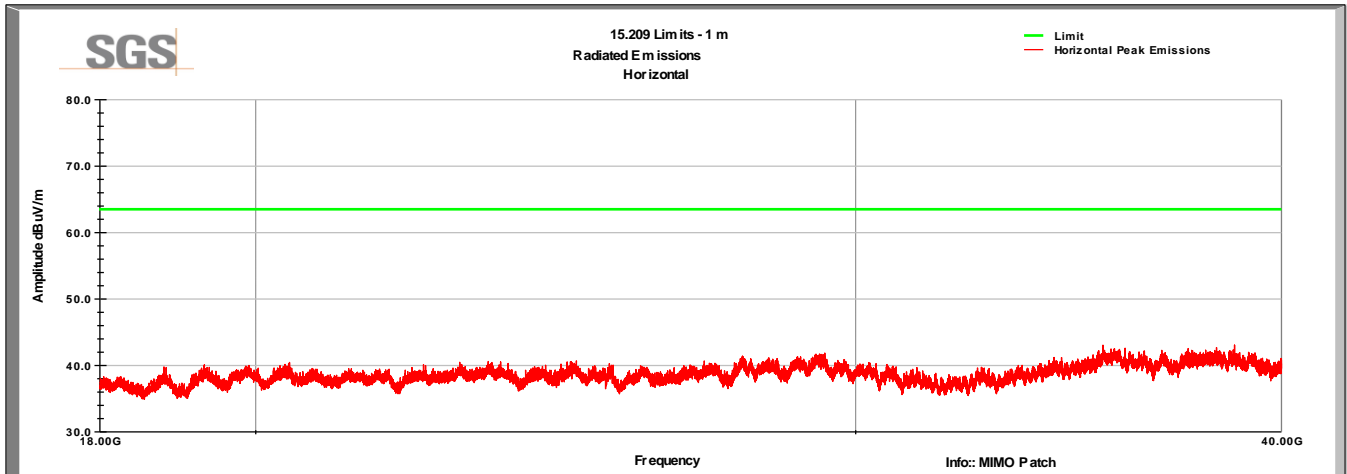

### CH 48 6MB/s Vertical

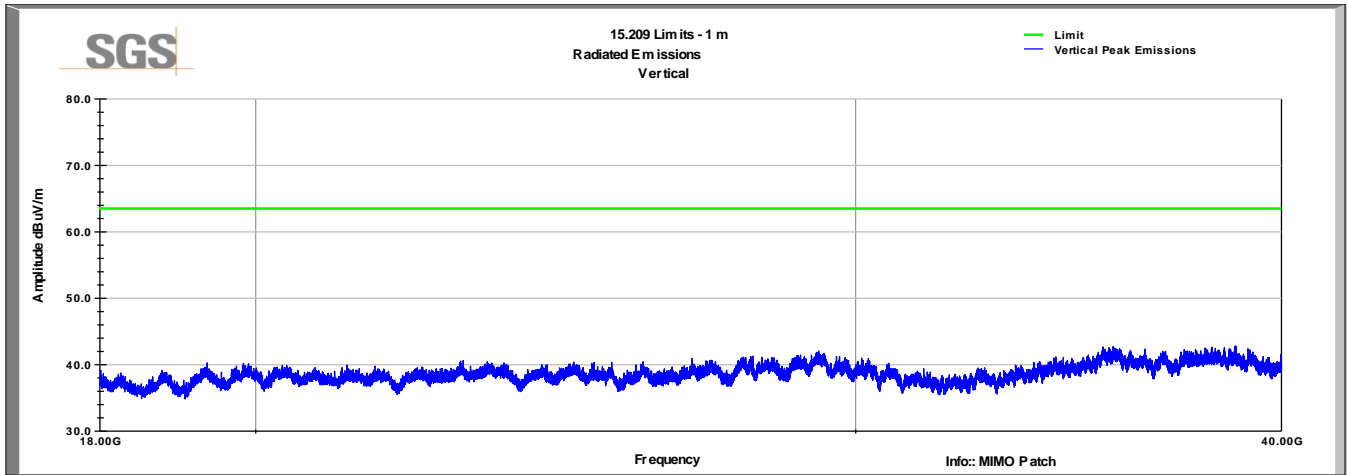

### Horizontal

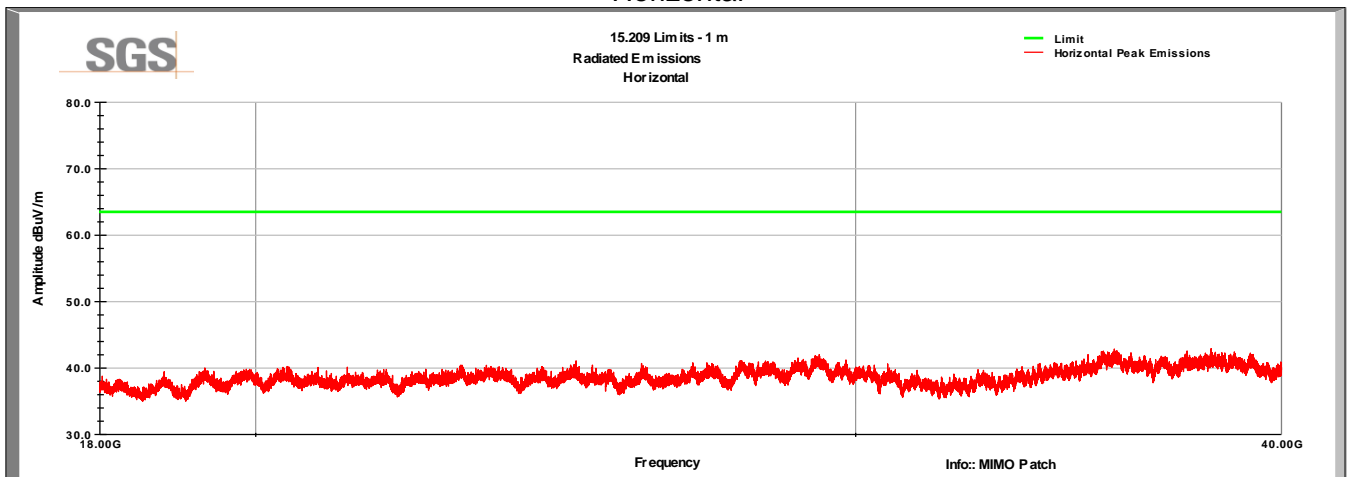

CH 149 6MB/s  
Vertical

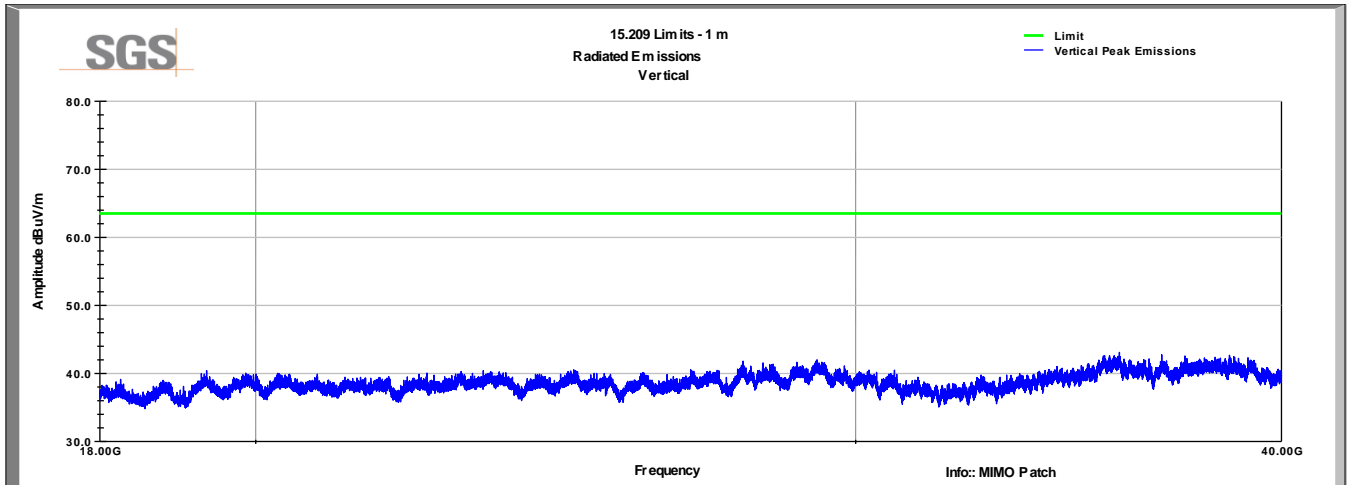

Horizontal

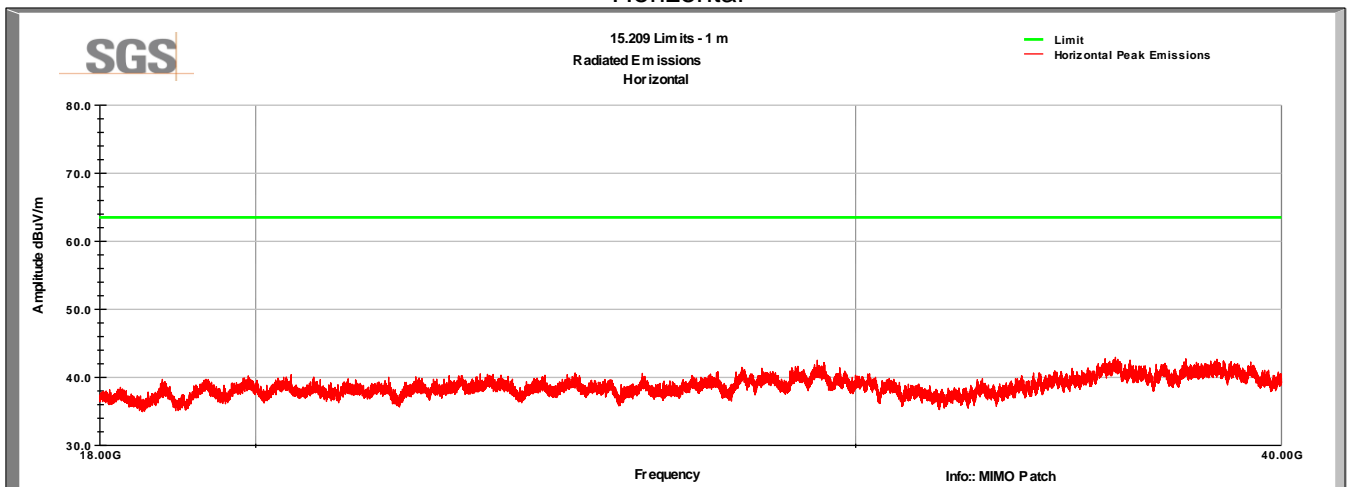

### CH 153 6MB/s Vertical

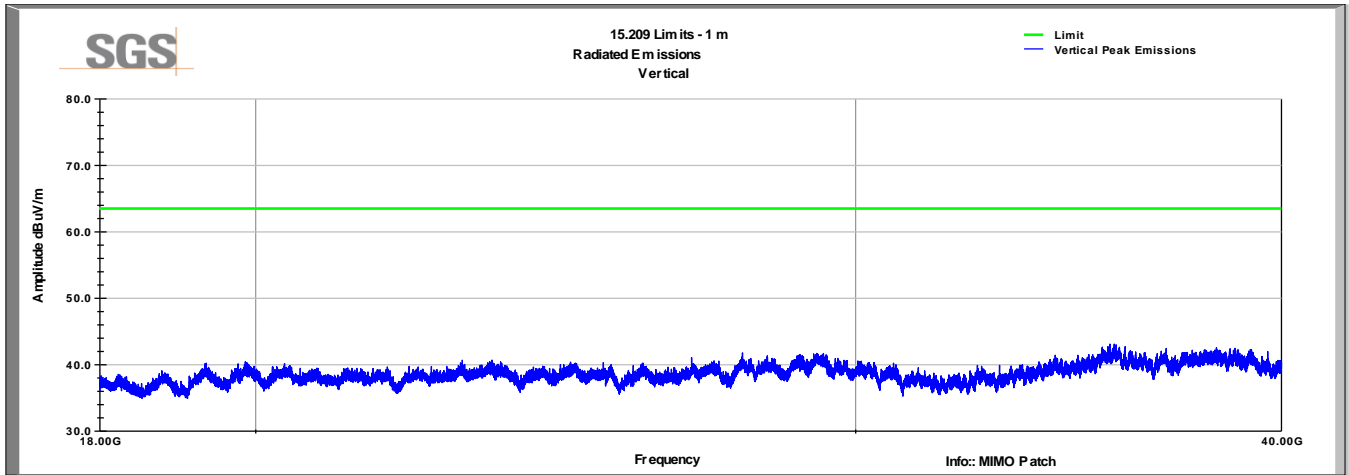

### Horizontal

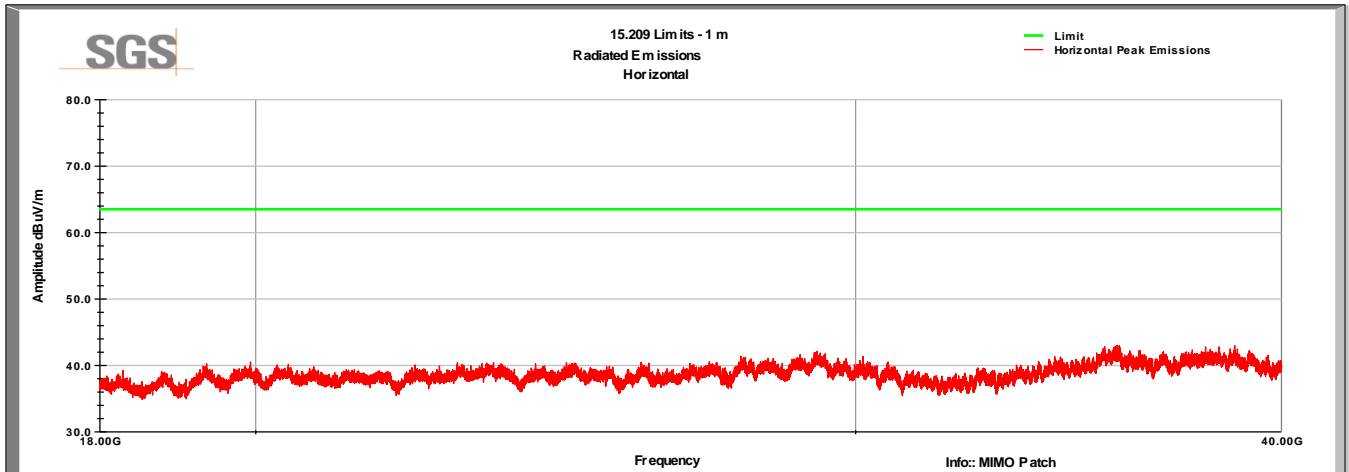



CH 161 6MB/s  
Vertical

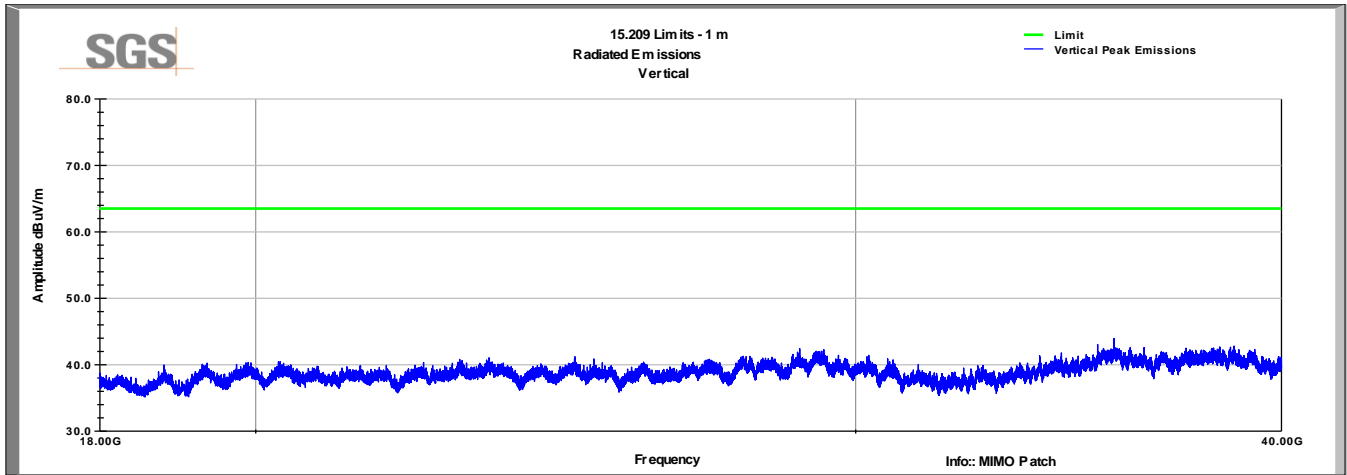

Horizontal

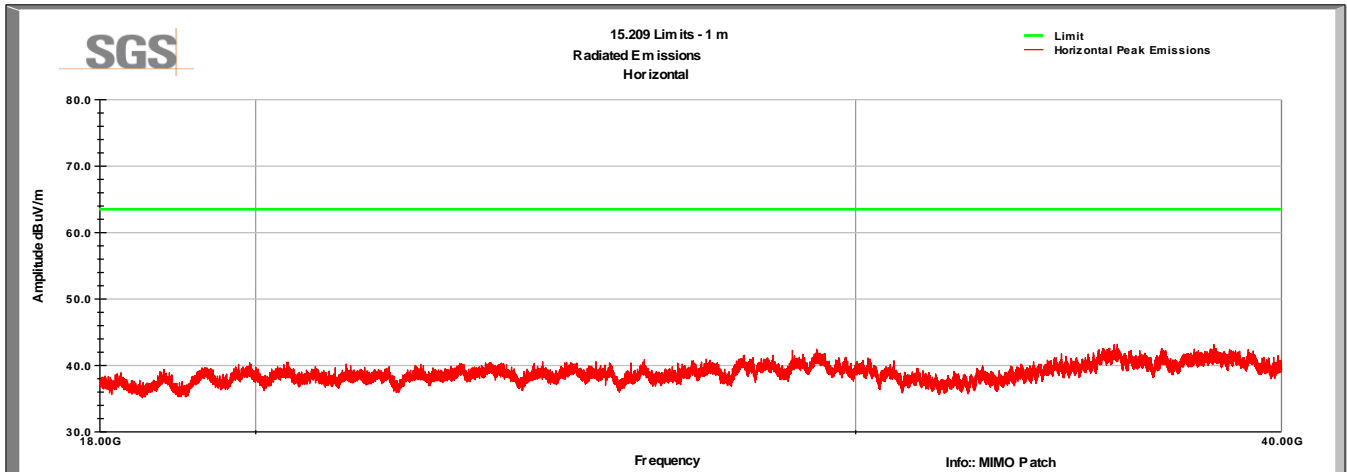

### 3.8 Test Data – Antenna P/N: M6013070P30006I (1-6GHz)

CH 36 6MB/s

Vertical

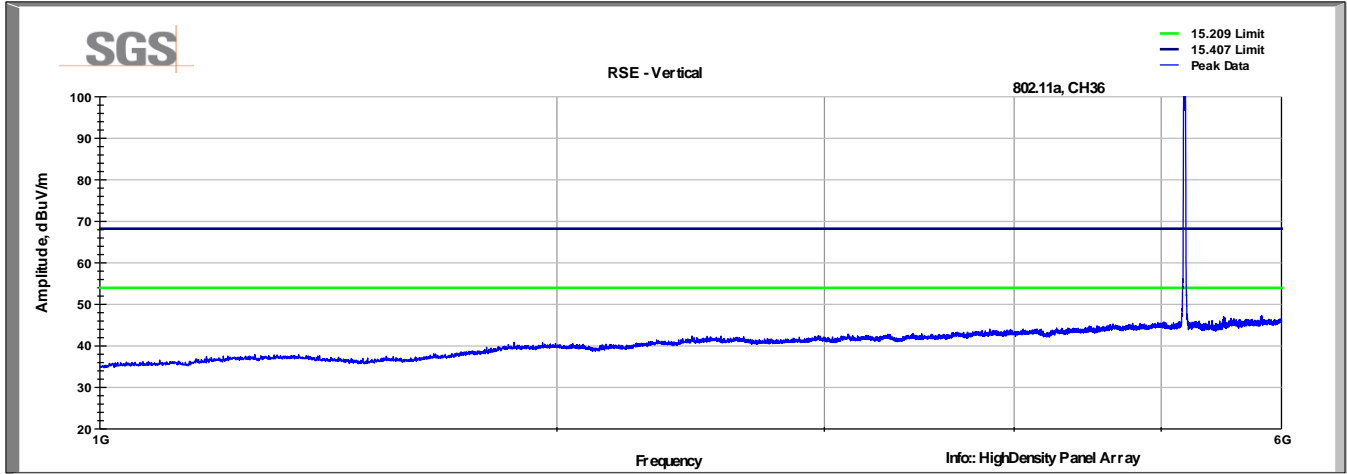

Horizontal

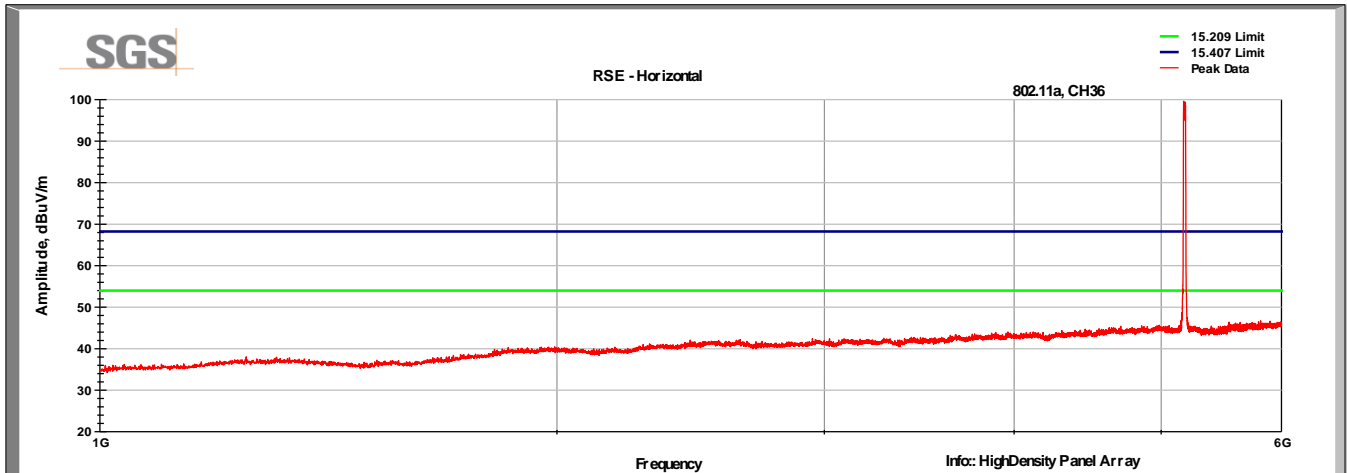

CH 40 6MB/s  
Vertical

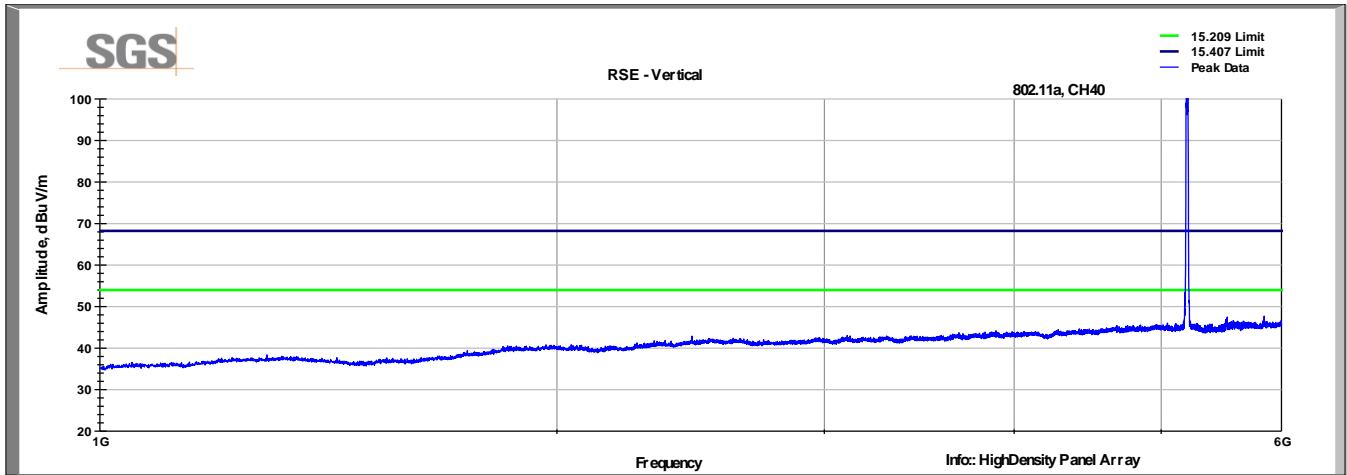

Horizontal

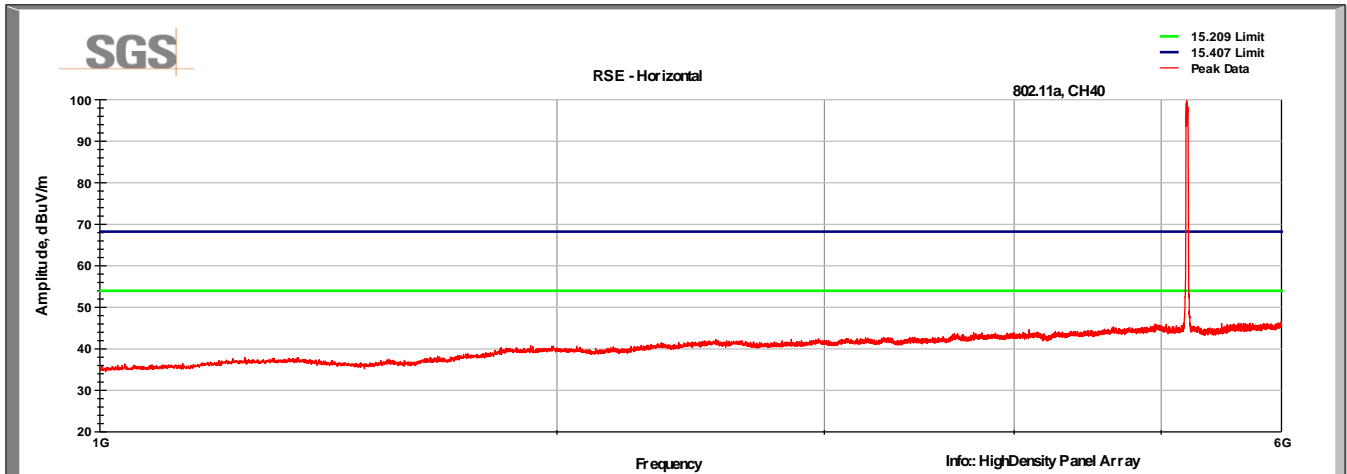

CH 48 6MB/s  
Vertical

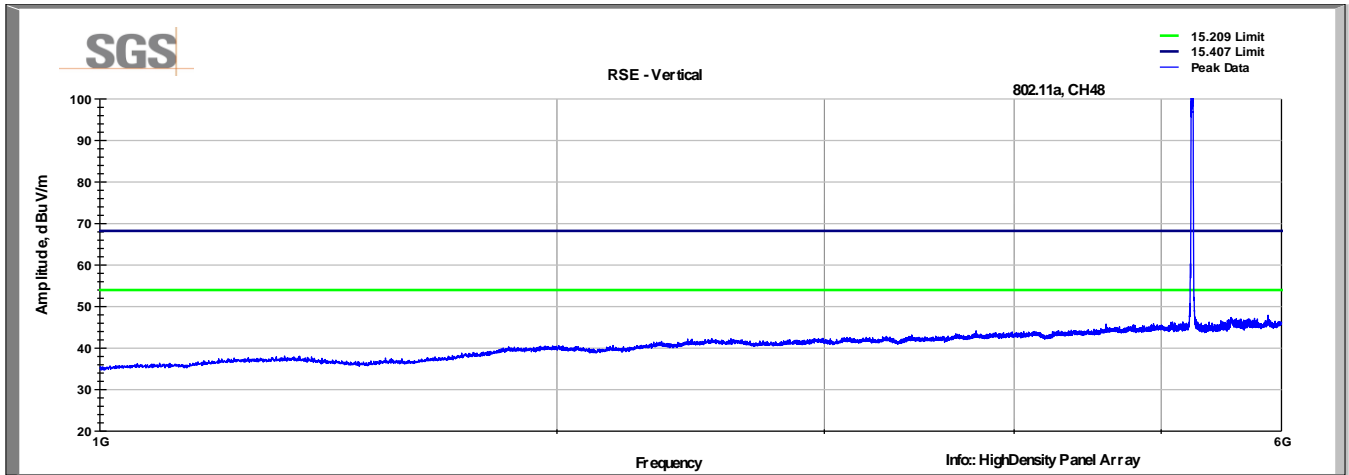

Horizontal

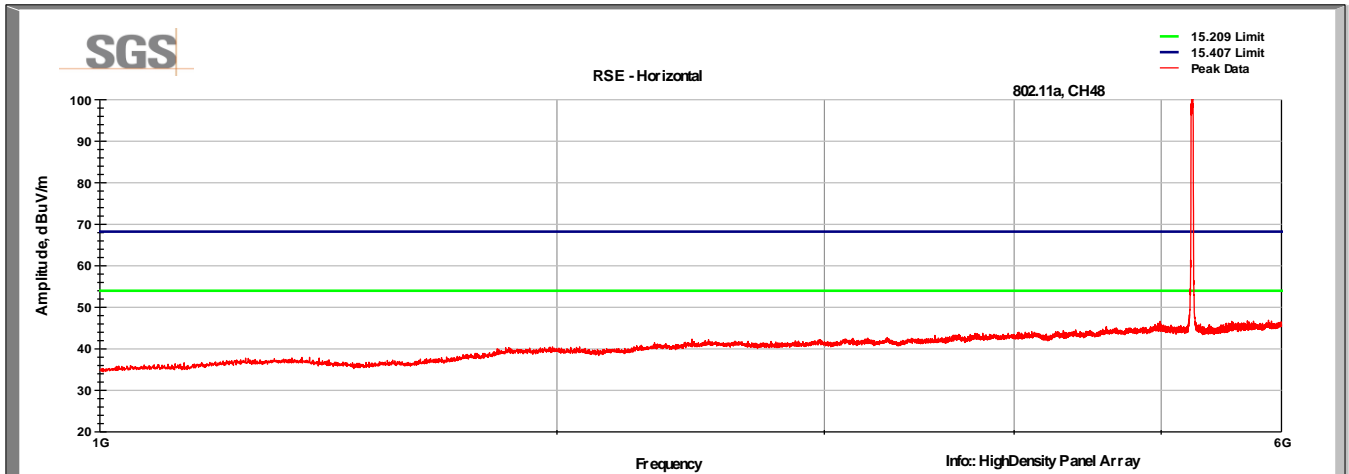

CH 149 6MB/s  
Vertical

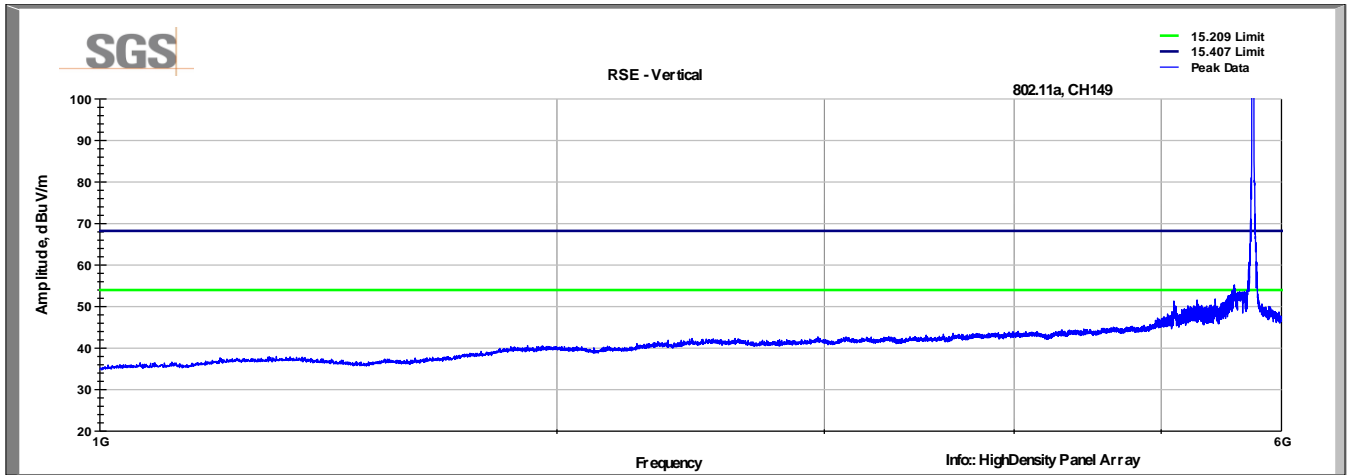

Horizontal

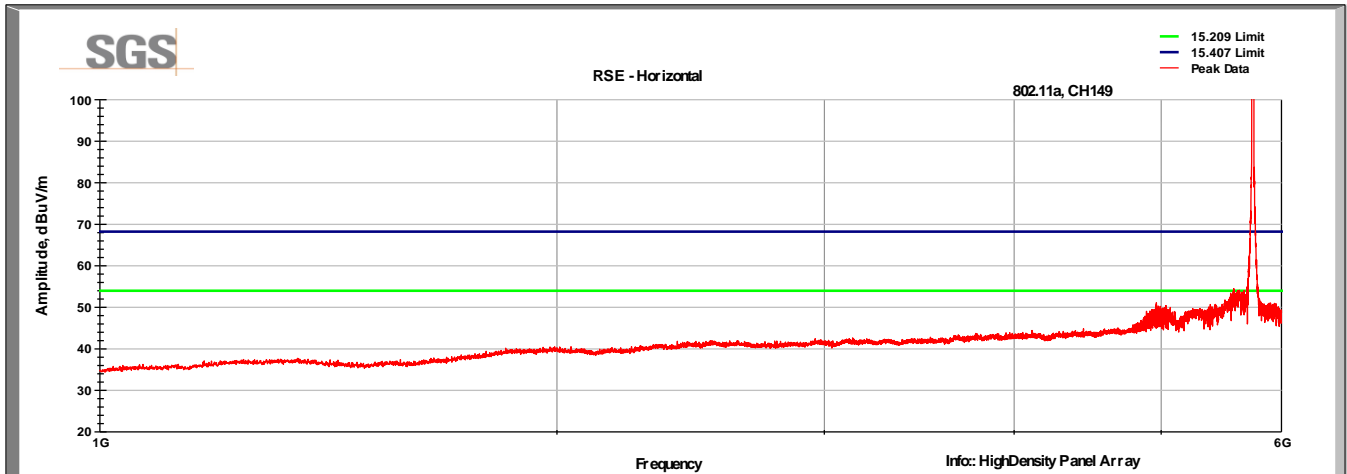

CH 153 6MB/s  
Vertical

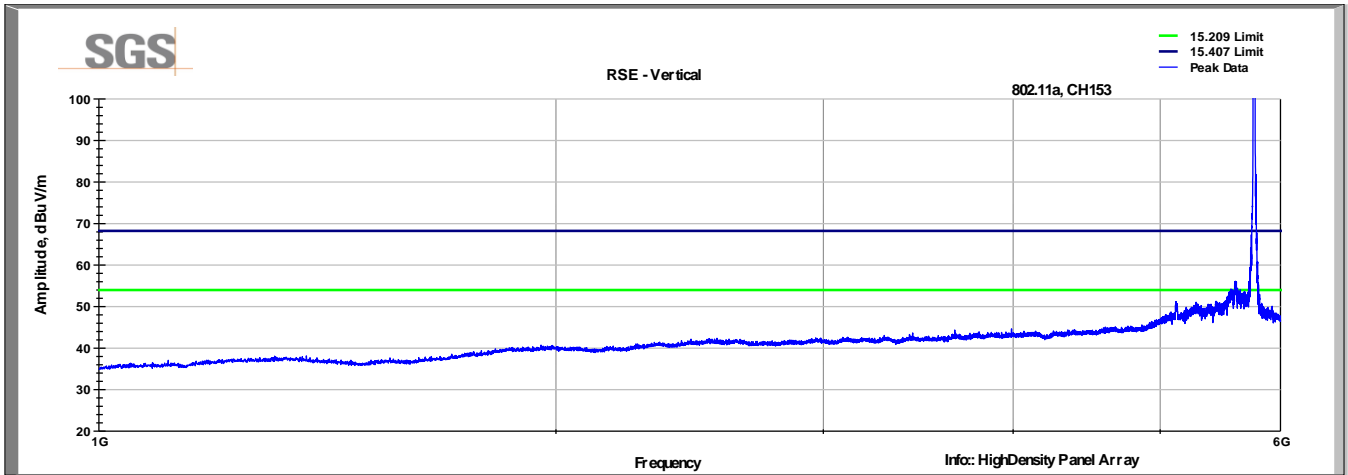

Horizontal

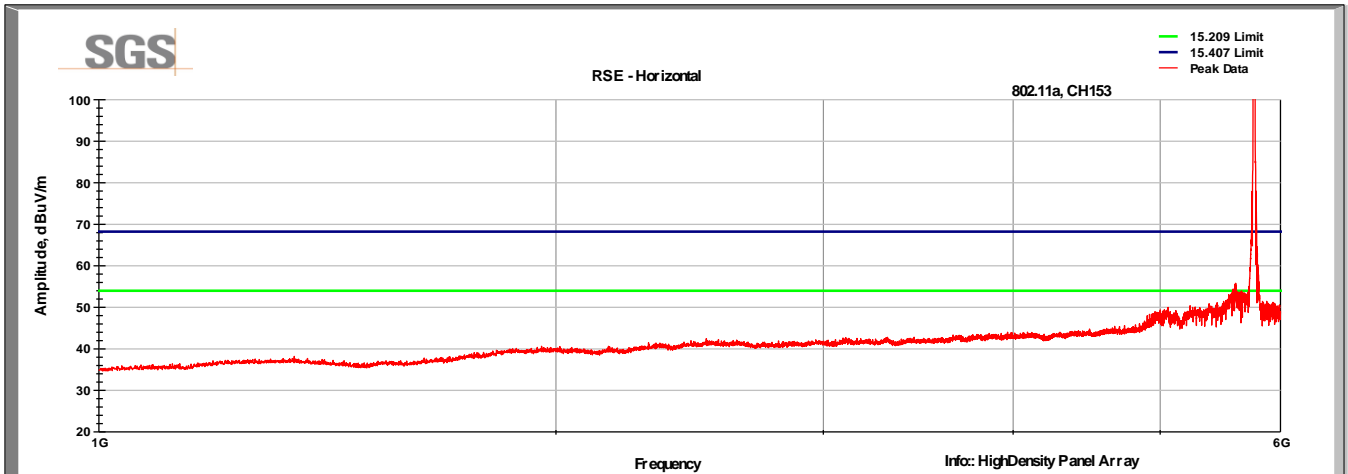

CH 161 6MB/s  
Vertical

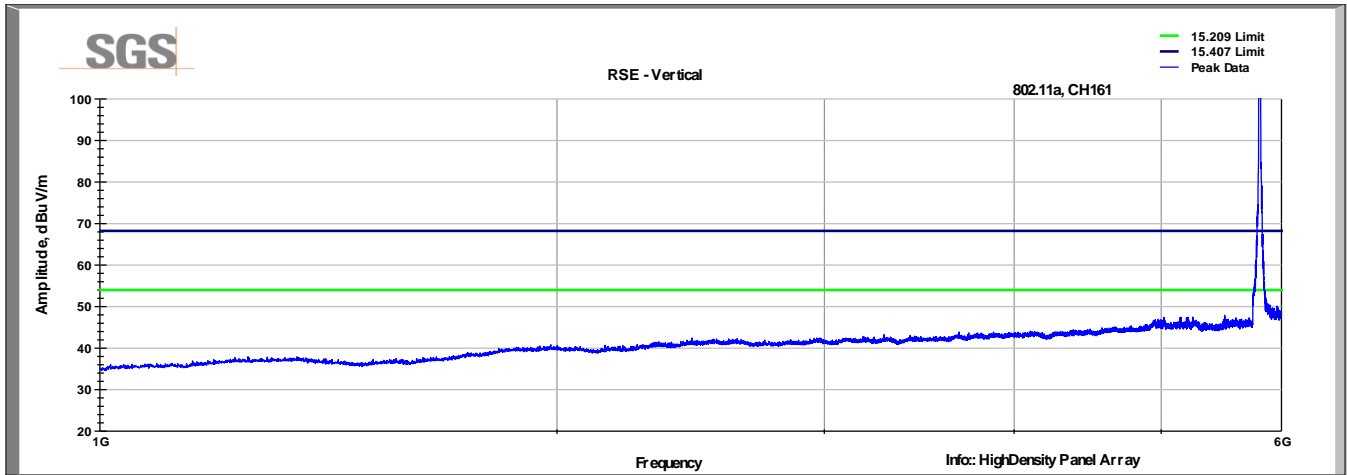

Horizontal

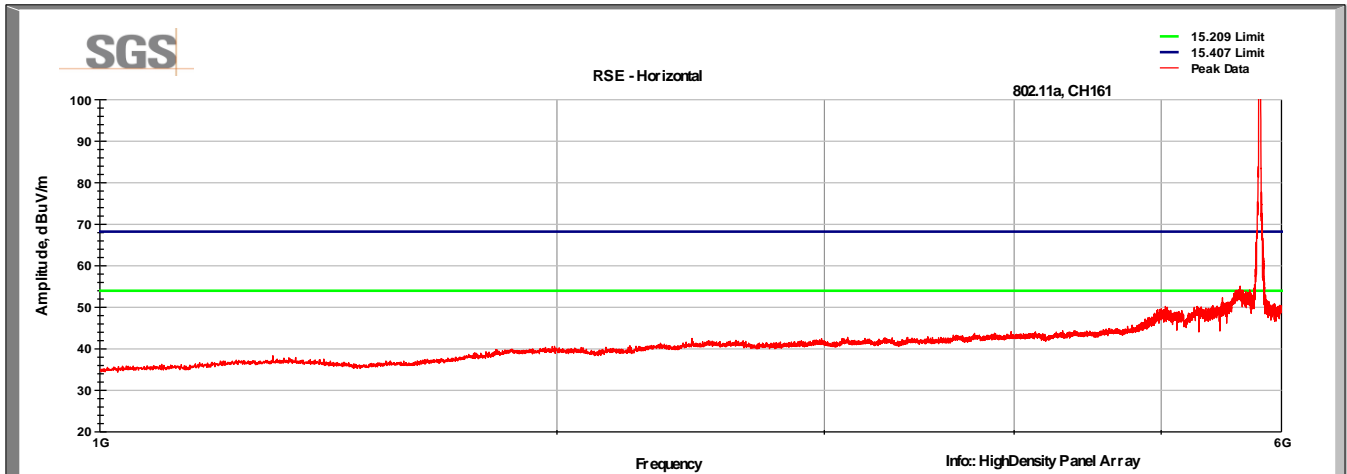

### 3.9 Test Data – Antenna P/N: M6013070P30006I (6-18GHz)

CH 36 6MB/s

Vertical

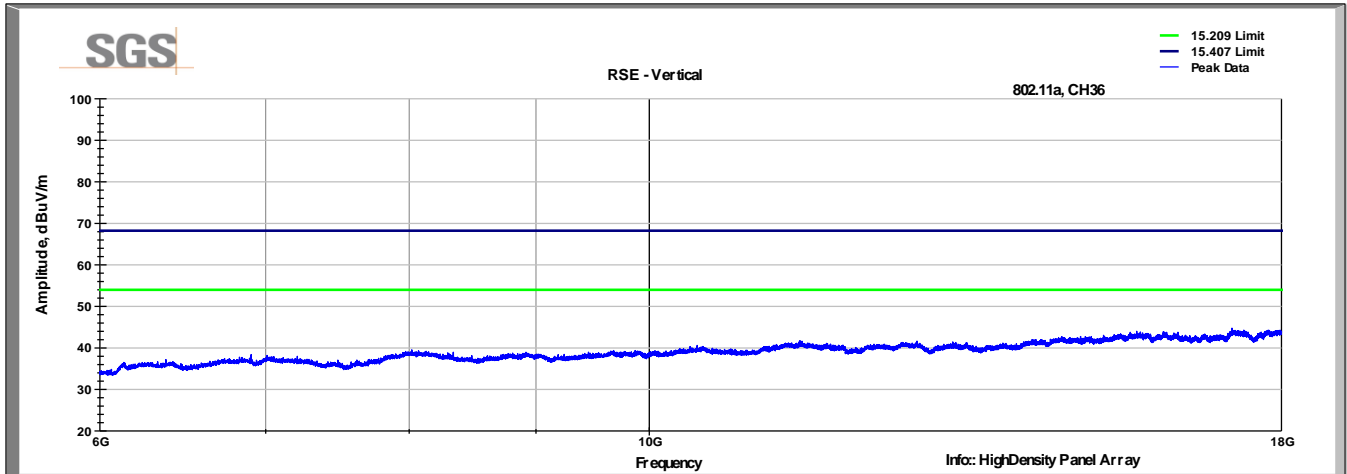

Horizontal

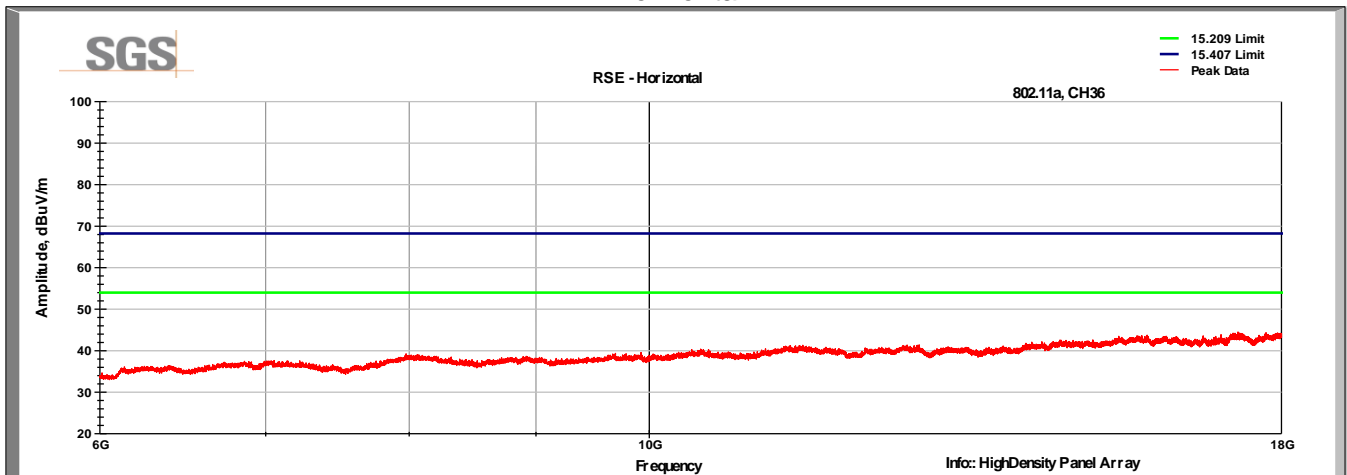



CH 40 6MB/s  
Vertical

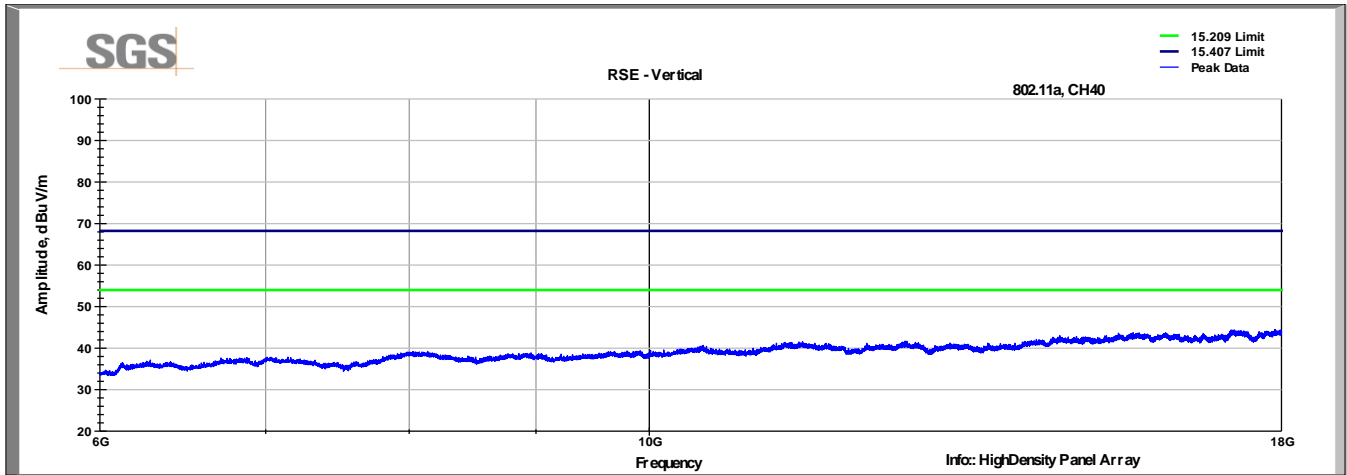

Horizontal

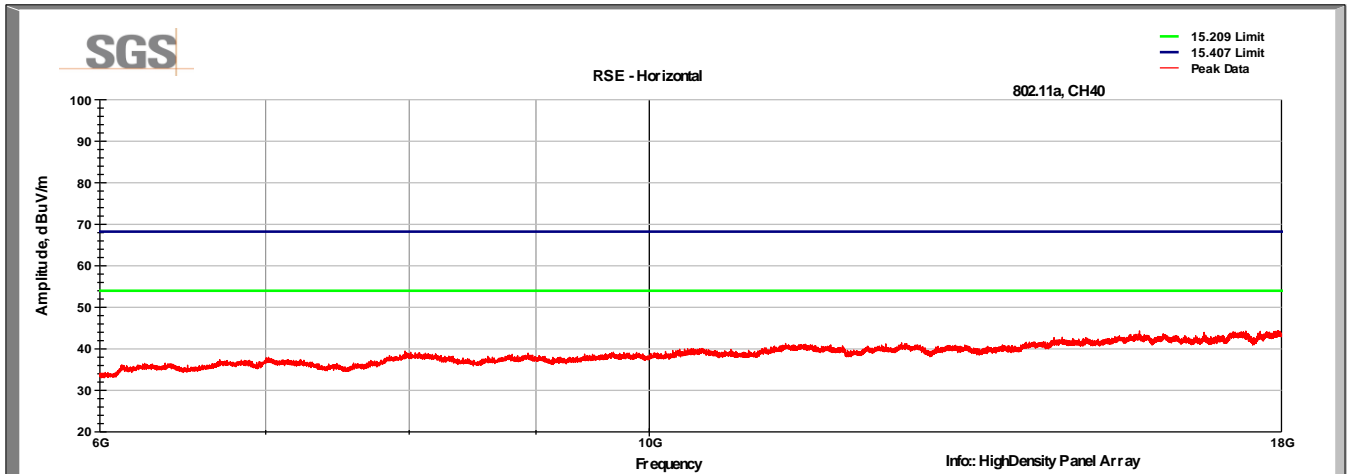

CH 48 6MB/s  
Vertical

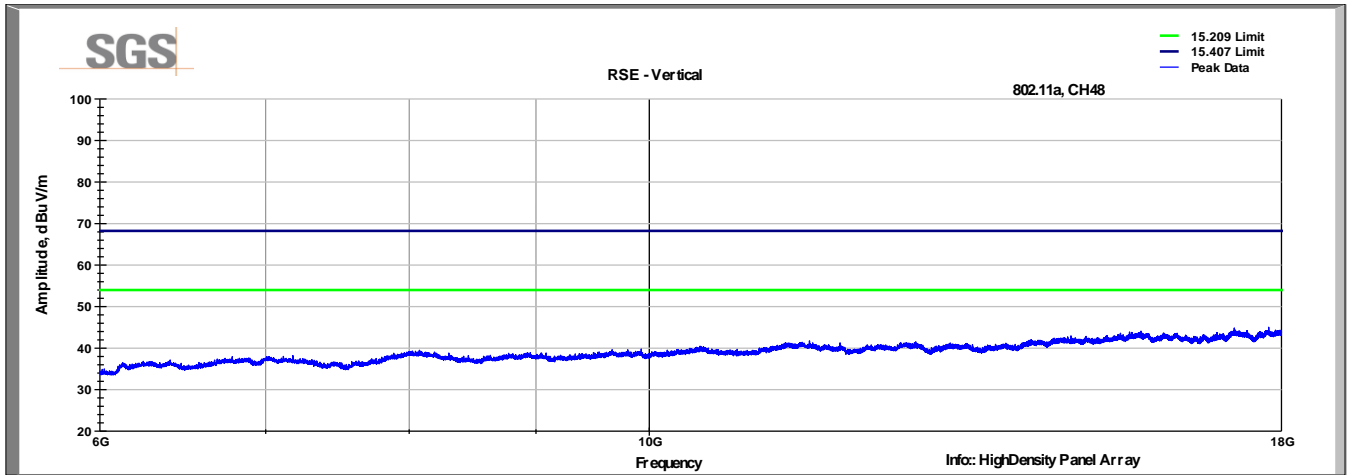

Horizontal

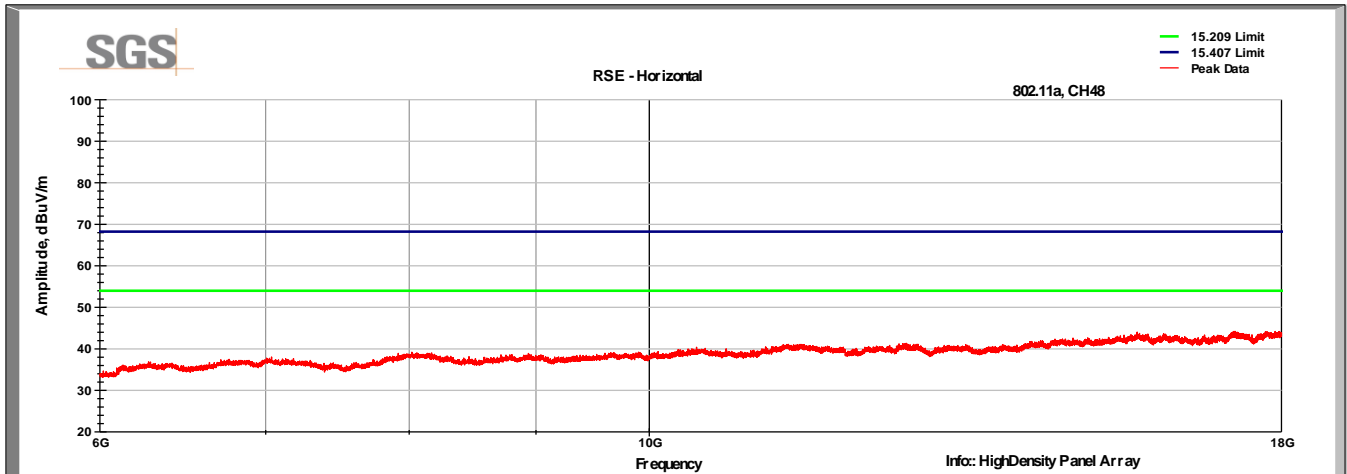

CH 149 6MB/s  
Vertical

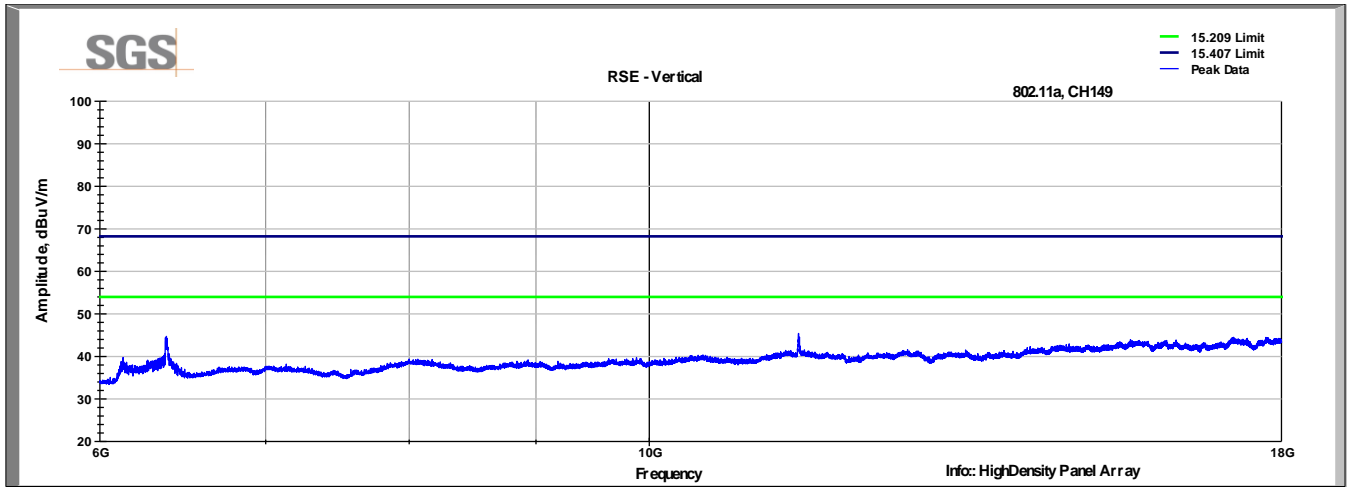

Horizontal

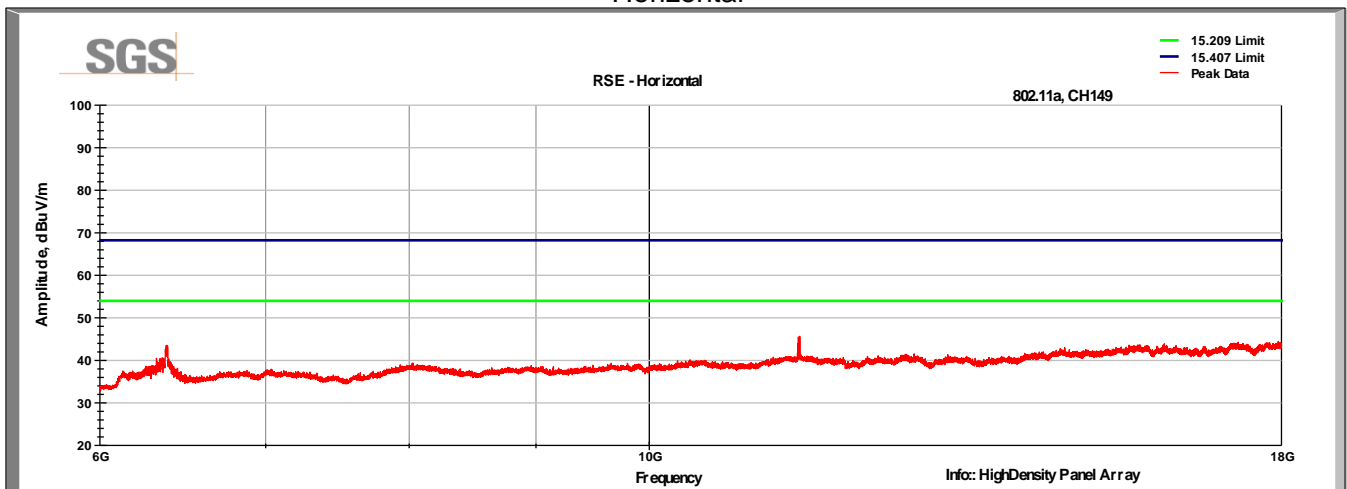

CH 153 6MB/s  
Vertical

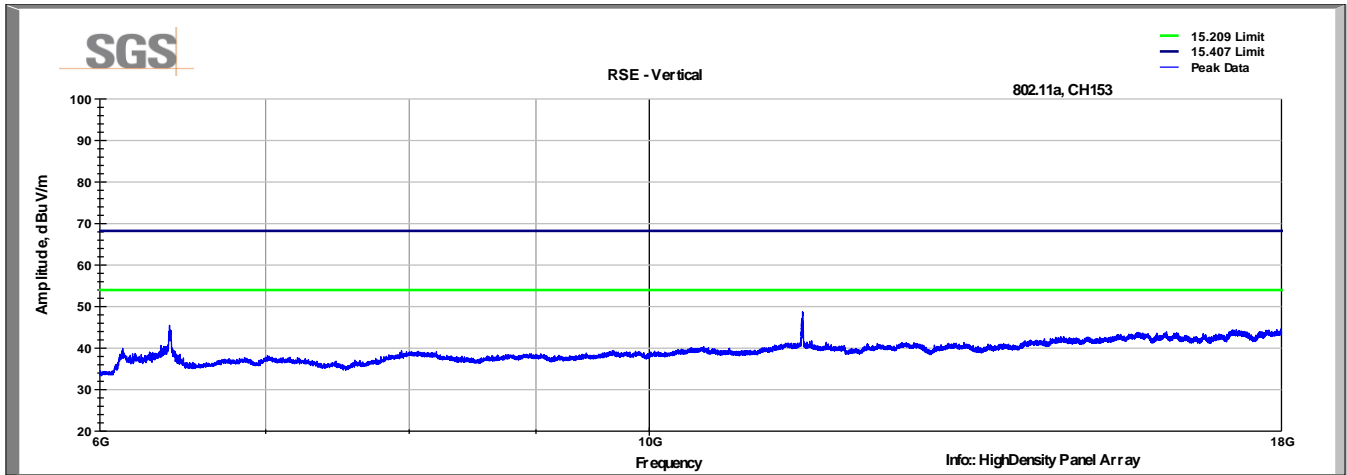

Horizontal

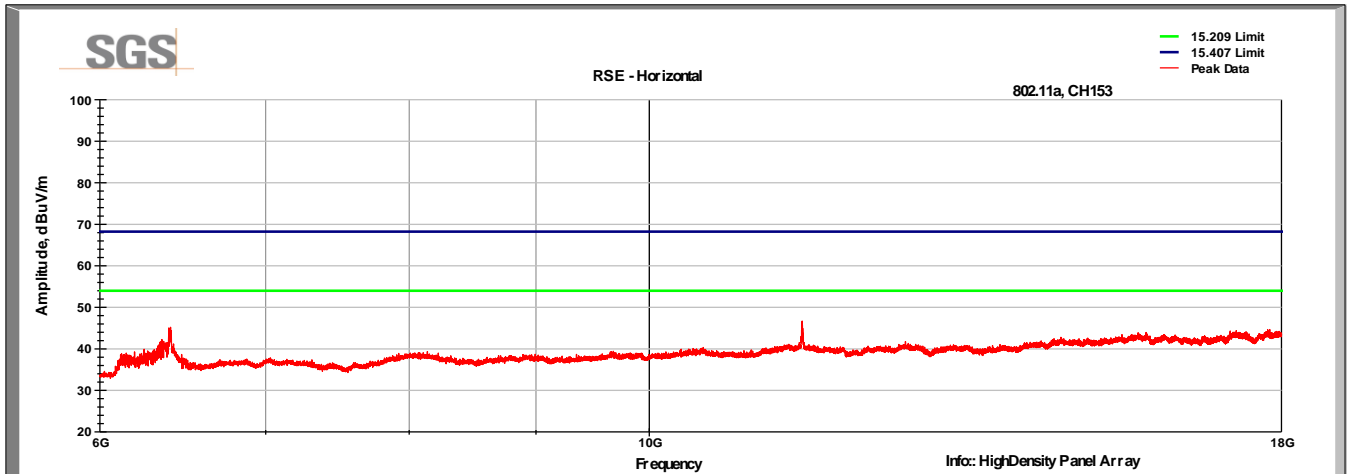

CH 161 6MB/s  
Vertical

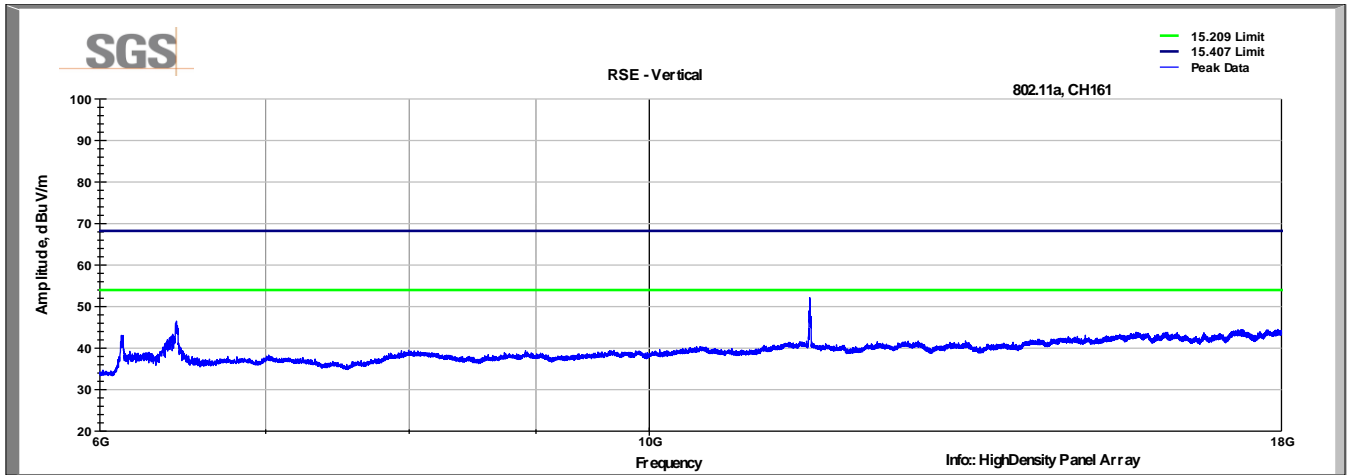

Horizontal

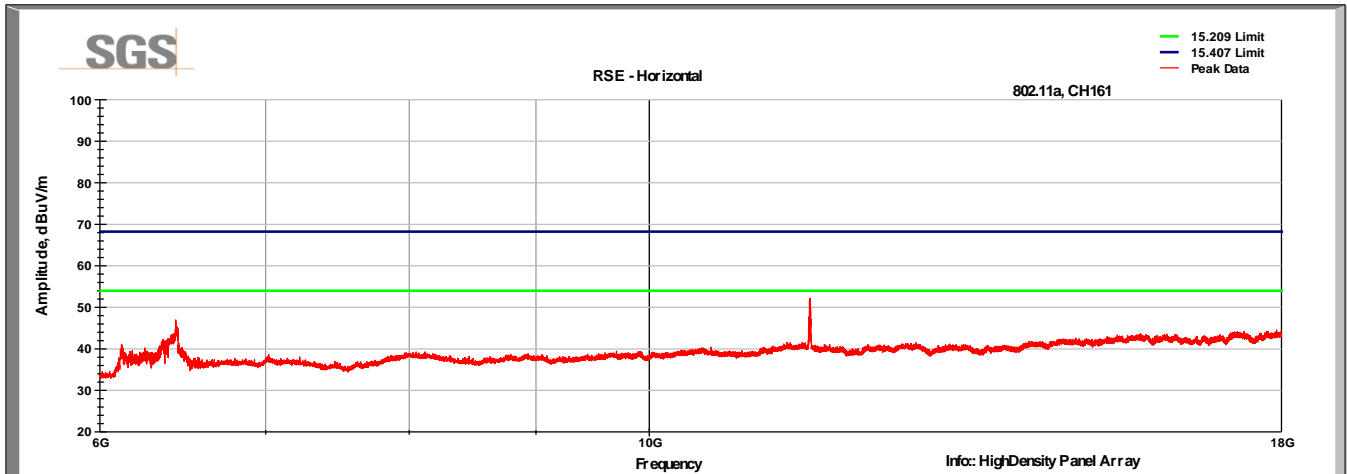

### 3.10 Test Data – Antenna P/N: M6013070P30006I (18-40GHz)

CH 36 6MB/s

Vertical

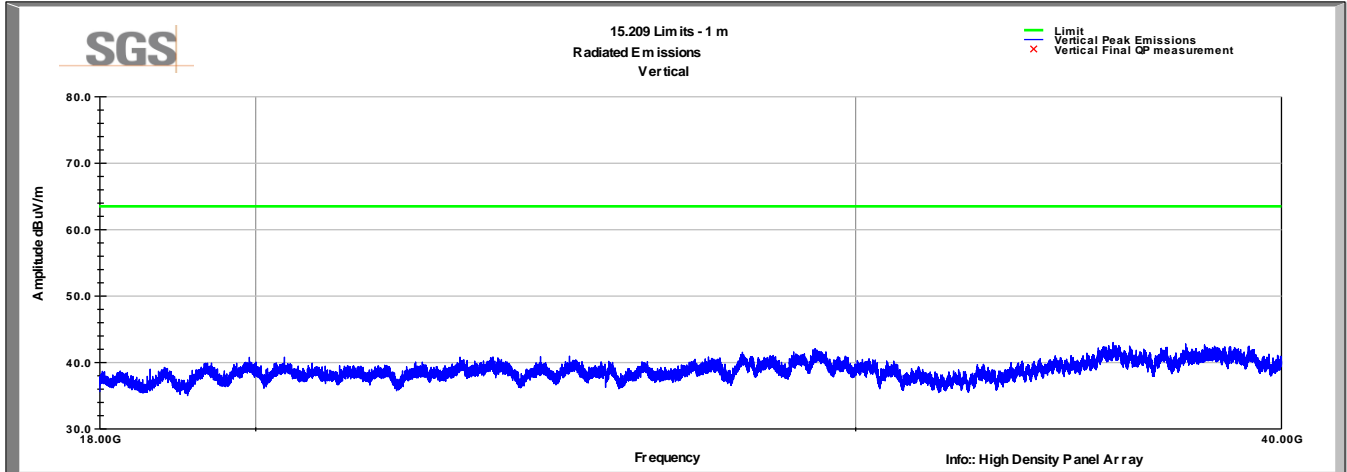

Horizontal

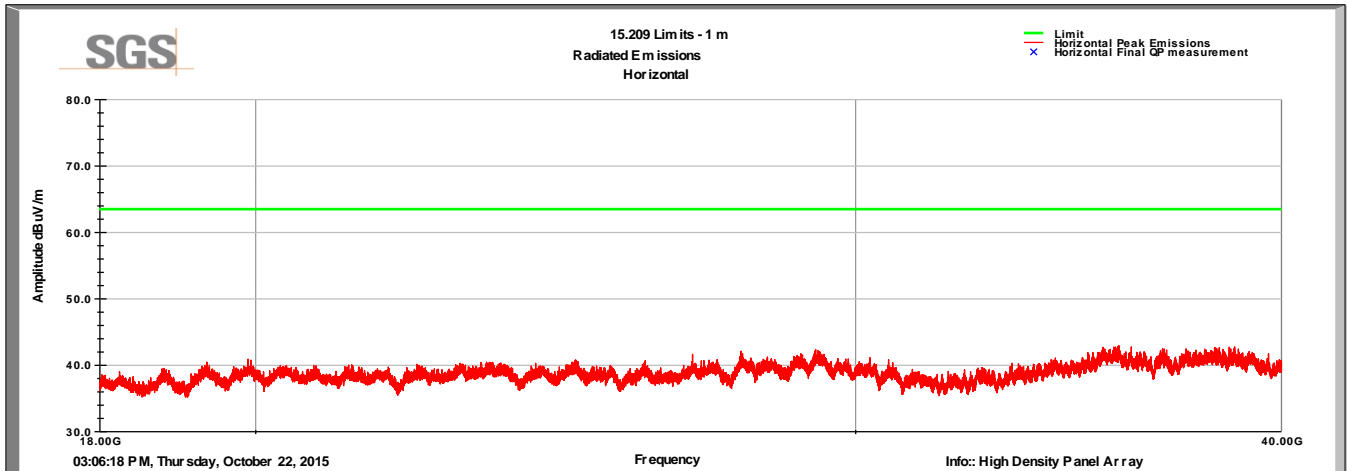

### CH 40 6MB/s Vertical

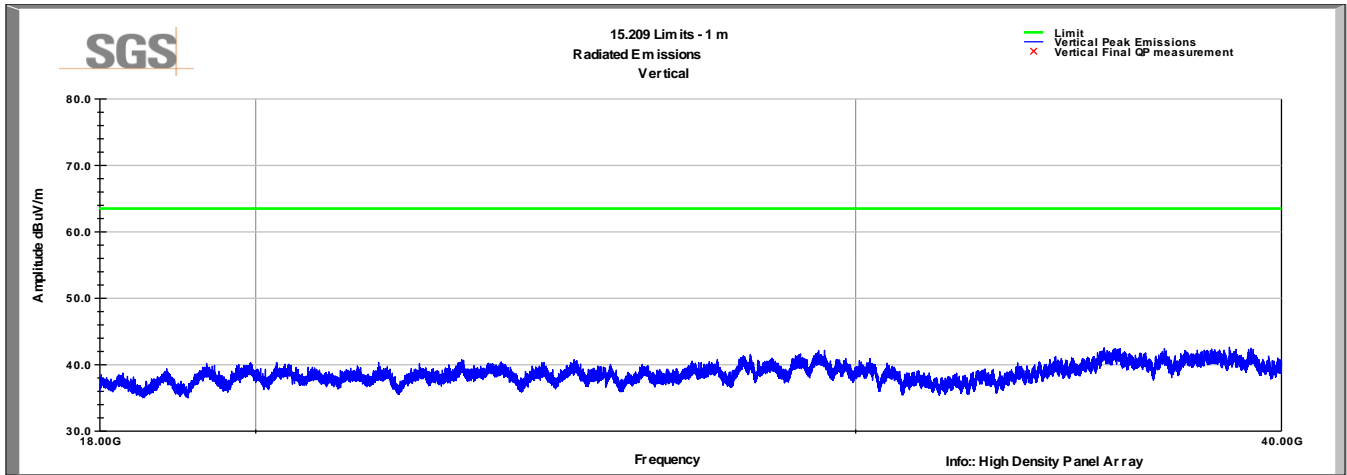

### Horizontal

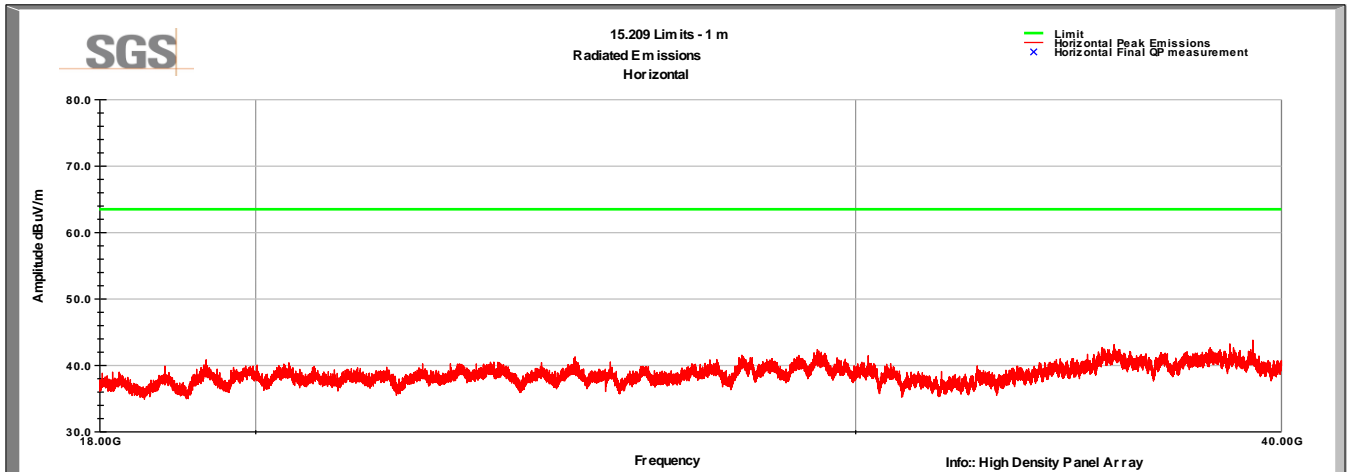

CH 48 6MB/s  
Vertical

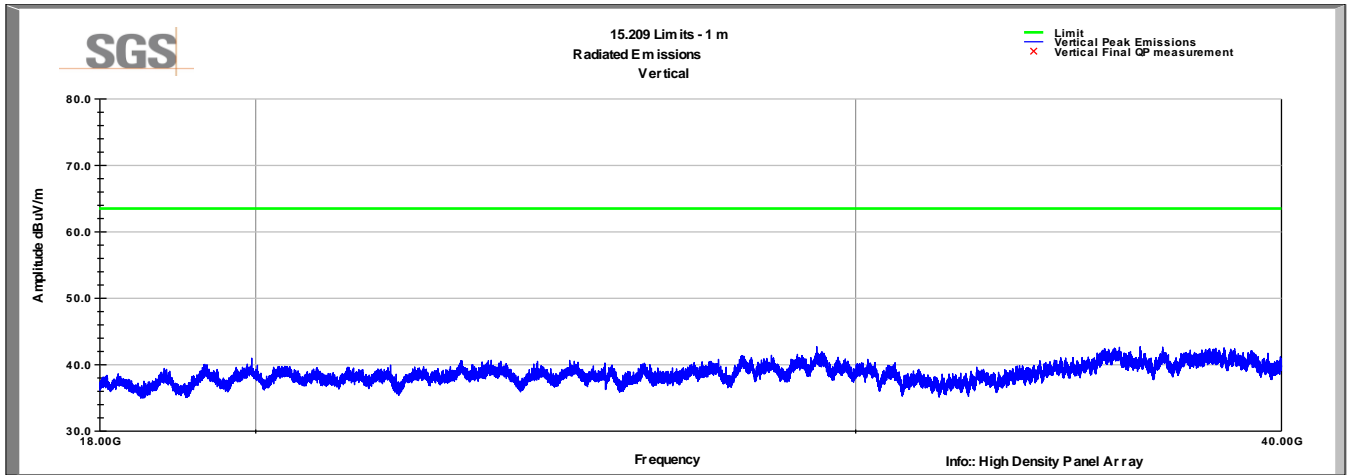

Horizontal

