

FCC Test Report

Report No.: RF150507C23-1

FCC ID: HDCBSAP2135

Test Model: BSAP 2135

Received Date: Apr. 17, 2015

Test Date: Apr. 17 ~ Jun. 05, 2015

Issued Date: Jun. 11, 2015

Applicant: Adtran

Address: 901 Explorer Boulevard, Huntsville Alabama, United States, 35806-2807

Issued By: Bureau Veritas Consumer Products Services (H.K.) Ltd., Taoyuan Branch

Lab Address: No. 47-2, 14th Ling, Chia Pau Vil., Lin Kou Dist., New Taipei City, Taiwan (R.O.C.)

Test Location: No.19, Hwa Ya 2nd Rd., Wen Hwa Vil., Kwei Shan Dist., Taoyuan City 33383, TAIWAN (R.O.C.)



This report is for your exclusive use. Any copying or replication of this report to or for any other person or entity, or use of our name or trademark, is permitted only with our prior written permission. This report sets forth our findings solely with respect to the test samples identified herein. The results set forth in this report are not indicative or representative of the quality or characteristics of the lot from which a test sample was taken or any similar or identical product specifically and expressly noted. Our report includes all of the tests requested by you and the results thereof based upon the information that you provided to us. You have 60 days from date of issuance of this report to notify us of any material error or omission caused by our negligence, provided, however, that such notice shall be in writing and shall specifically address the issue you wish to raise. A failure to raise such issue within the prescribed time shall constitute your unqualified acceptance of the completeness of this report, the tests conducted and the correctness of the report contents. Unless specific mention, the uncertainty of measurement has been explicitly taken into account to declare the compliance or non-compliance to the specification. The report must not be used by the client to claim product certification, approval, or endorsement by TAF or any government agencies.

Table of Contents

Release Control Record	4
1 Certificate of Conformity	5
2 Summary of Test Results	6
2.1 Measurement Uncertainty.....	6
2.2 Modification Record.....	6
3 General Information	7
3.1 General Description of EUT.....	7
3.2 Description of Test Modes.....	9
3.2.1 Test Mode Applicability and Tested Channel Detail.....	10
3.3 Duty Cycle of Test Signal.....	12
3.4 Description of Support Units.....	13
3.4.1 Configuration of System under Test.....	13
3.5 General Description of Applied Standard.....	14
4 Test Types and Results	15
4.1 Radiated Emission and Bandedge Measurement.....	15
4.1.1 Limits of Radiated Emission and Bandedge Measurement.....	15
4.1.2 Test Instruments.....	16
4.1.3 Test Procedure.....	17
4.1.4 Deviation from Test Standard.....	17
4.1.5 Test Setup.....	18
4.1.6 EUT Operating Conditions.....	18
4.1.7 Test Results.....	19
4.2 Conducted Emission Measurement.....	38
4.2.1 Limits of Conducted Emission Measurement.....	38
4.2.2 Test Instruments.....	38
4.2.3 Test Procedure.....	39
4.2.4 Deviation from Test Standard.....	39
4.2.5 Test Setup.....	39
4.2.6 EUT Operating Conditions.....	39
4.2.7 Test Results.....	40
4.3 Transmit Power Measurement.....	42
4.3.1 Limits of Transmit Power Measurement.....	42
4.3.2 Test Setup.....	42
4.3.3 Test Instruments.....	42
4.3.4 Test Procedure.....	43
4.3.5 Deviation from Test Standard.....	43
4.3.6 EUT Operating Conditions.....	43
4.3.7 Test Result.....	44
4.4 Peak Power Spectral Density Measurement.....	51
4.4.1 Limits of Peak Power Spectral Density Measurement.....	51
4.4.2 Test Setup.....	51
4.4.3 Test Instruments.....	51
4.4.4 Test Procedure.....	51
4.4.5 Deviation from Test Standard.....	52
4.4.6 EUT Operating Condition.....	52
4.4.7 Test Results.....	53
4.5 Frequency Stability.....	59
4.5.1 Limits of Frequency Stability Measurement.....	59
4.5.2 Test Setup.....	59
4.5.3 Test Instruments.....	59
4.5.4 Test Procedure.....	59
4.5.5 Deviation from Test Standard.....	59
4.5.6 EUT Operating Condition.....	59

4.5.7 Test Results	60
4.6 6dB Bandwidth Measurement	61
4.6.1 Limits of 6dB Bandwidth Measurement	61
4.6.2 Test Setup	61
4.6.3 Test Instruments	61
4.6.4 Test Procedure	61
4.6.5 Deviation from Test Standard	61
4.6.6 EUT Operating Condition	61
4.6.7 Test Results	62
5 Pictures of Test Arrangements	64
Appendix – Information on the Testing Laboratories	65



A D T

Release Control Record

Issue No.	Description	Date Issued
RF150507C23-1	Original release.	Jun. 11, 2015

1 Certificate of Conformity

Product: Outdoor Wireless Access Point

Brand: Adtran

Test Model: BSAP 2135

Sample Status: Engineering sample

Applicant: Adtran

Test Date: Apr. 17 ~ Jun. 05, 2015

Standard: 47 CFR FCC Part 15, Subpart E (Section 15.407)
ANSI C63.10:2013

The above equipment has been tested by **Bureau Veritas Consumer Products Services (H.K.) Ltd., Taoyuan Branch**, and found compliance with the requirement of the above standards. The test record, data evaluation & Equipment Under Test (EUT) configurations represented herein are true and accurate accounts of the measurements of the sample's EMC characteristics under the Conditions specified in this report.

Prepared by :  , **Date:** Jun. 11, 2015
Polly Chien / Specialist

Approved by :  , **Date:** Jun. 11, 2015
Ken Liu / Senior Manager

2 Summary of Test Results

47 CFR FCC Part 15, Subpart E (Section 15.407)			
FCC Clause	Test Item	Result	Remarks
15.407(b)(6)	AC Power Conducted Emissions	PASS	Meet the requirement of limit. Minimum passing margin is -11.54dB at 6.24870MHz.
15.407(b)(1/2/3/4/6)	Radiated Emissions & Band Edge Measurement	PASS	Meet the requirement of limit. Minimum passing margin is -1.0dB at 5722.00MHz.
15.407(a)(1/2/3)	Max Average Transmit Power	PASS	Meet the requirement of limit.
15.407(a)(1/2/3)	Peak Power Spectral Density	PASS	Meet the requirement of limit.
15.407(e)	6dB bandwidth	PASS	Meet the requirement of limit. (U-NII-3 Band only)
15.407(g)	Frequency Stability	PASS	Meet the requirement of limit.
15.203	Antenna Requirement	PASS	Antenna connector is N-Type. (The device is professionally installed)

2.1 Measurement Uncertainty

Where relevant, the following measurement uncertainty levels have been estimated for tests performed on the EUT as specified in CISPR 16-4-2:

Measurement	Frequency	Expanded Uncertainty (k=2) (\pm)
Conducted Emissions at mains ports	150kHz ~ 30MHz	2.44 dB
Radiated Emissions up to 1 GHz	30MHz ~ 200MHz	3.86 dB
	200MHz ~ 1000MHz	3.87 dB
Radiated Emissions above 1 GHz	1GHz ~ 18GHz	2.29 dB
	18GHz ~ 40GHz	2.29 dB

2.2 Modification Record

There were no modifications required for compliance.

3 General Information

3.1 General Description of EUT

Product	Outdoor Wireless Access Point
Brand	Adtran
Test Model	BSAP 2135
Status of EUT	Engineering sample
Power Supply Rating	56Vdc (POE)
Modulation Type	256QAM, 64QAM, 16QAM, QPSK, BPSK
Modulation Technology	OFDM
Transfer Rate	802.11a: 54.0/ 48.0/ 36.0/ 24.0/ 18.0/ 12.0/ 9.0/ 6.0Mbps 802.11n: up to 450.0Mbps 802.11ac: up to 1300.0Mbps
Operating Frequency	5180 ~ 5240MHz & 5745 ~ 5825MHz
Number of Channel	5180 ~ 5240MHz: 4 for 802.11a, 802.11n (HT20), 802.11ac (VHT20) 2 for 802.11n (HT40), 802.11ac (VHT40) 1 for 802.11ac (VHT80) 5745 ~ 5825MHz: 5 for 802.11a, 802.11n (HT20), 802.11ac (VHT20) 2 for 802.11n (HT40), 802.11ac (VHT40) 1 for 802.11ac (VHT80)
Output Power	5180 ~ 5240MHz: 217.123mW 5745 ~ 5825MHz: 590.530mW
Antenna Type	Dipole antenna with 5.06 and 5.87dBi for NII-1 & 3 band respectively.
Antenna Connector	N-Type (The device is professionally installed)
Accessory Device	NA
Data Cable Supplied	NA

Note:

1. The EUT incorporates a MIMO function. Physically, the EUT provides 3 completed transmitters and 3 receivers.

Modulation Mode	TX Function
802.11a	3TX
802.11n (HT20)	3TX
802.11n (HT40)	3TX
802.11ac (VHT20)	3TX
802.11ac (VHT40)	3TX
802.11ac (VHT80)	3TX

*The modulation and bandwidth are similar for 802.11n mode for 20MHz/40MHz and 802.11ac mode for 20MHz/40MHz, therefore investigated worst case to representative mode in test report. (Final test mode refer section 3.2.1)

2. The EUT consumes power from the following POE. (For support unit)

POE	
Brand	PHIHONG
Model	POE36U-1AT-R
Input Power	100-240Vac, 50-60Hz, 1.0A
Output Power	56Vdc, 0.6A

3. The EUT will install at outdoor area, the highest antenna gain from the horizon above 30 degrees as below, for more detail information please refer to antenna specification and user manual

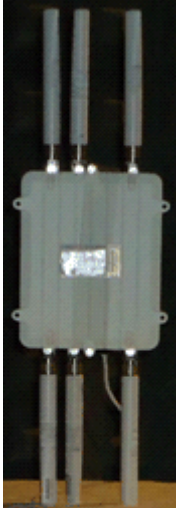
Antenna	Antenna gain	Antenna install degree
Dipole	-2.49 dBi	

4. The above EUT information is declared by manufacturer and for more detailed features description, please refer to the manufacturer's specifications or user's manual.

3.2 Description of Test Modes

FOR 5180 ~ 5240MHz

4 channels are provided for 802.11a, 802.11n (HT20), 802.11ac (VHT20):

Channel	Frequency	Channel	Frequency
36	5180 MHz	44	5220 MHz
40	5200 MHz	48	5240 MHz

2 channels are provided for 802.11n (HT40), 802.11ac (40MHz):

Channel	Frequency	Channel	Frequency
38	5190 MHz	46	5230 MHz

1 channel is provided for 802.11ac (VHT80):

Channel	Frequency
42	5210MHz

FOR 5745 ~ 5825MHz:

5 channels are provided for 802.11a, 802.11n (HT20), 802.11ac (VHT20):

Channel	Frequency	Channel	Frequency
149	5745MHz	161	5805MHz
153	5765MHz	165	5825MHz
157	5785MHz		

2 channels are provided for 802.11n (HT40), 802.11ac (VHT40):

Channel	Frequency	Channel	Frequency
151	5755MHz	159	5795MHz

1 channel is provided for 802.11ac (VHT80):

Channel	Frequency
155	5775MHz

3.2.1 Test Mode Applicability and Tested Channel Detail

EUT CONFIGURE MODE	APPLICABLE TO				DESCRIPTION
	RE≥1G	RE<1G	PLC	APCM	
-	√	√	√	√	-

Where **RE≥1G**: Radiated Emission above 1GHz **RE<1G**: Radiated Emission below 1GHz
PLC: Power Line Conducted Emission **APCM**: Antenna Port Conducted Measurement

NOTE: The EUT had been pre-tested on the positioned of each 3 axis. The worst case was found when positioned on **Y-plane**.

Radiated Emission Test (Above 1GHz):

- Pre-Scan has been conducted to determine the worst-case mode from all possible combinations between available modulations, data rates and antenna ports (if EUT with antenna diversity architecture).
- Following channel(s) was (were) selected for the final test as listed below.

EUT CONFIGURE MODE	MODE	FREQ. BAND (MHz)	AVAILABLE CHANNEL	TESTED CHANNEL	MODULATION TECHNOLOGY	MODULATION TYPE	DATA RATE (Mbps)
-	802.11a	5180-5240	36 to 48	36, 40, 48	OFDM	BPSK	6.0
-	802.11n (HT20)		36 to 48	36, 40, 48	OFDM	BPSK	7.2
-	802.11n (HT40)		38 to 46	38, 46	OFDM	BPSK	15.0
-	802.11ac (VHT80)		42	42	OFDM	BPSK	97.5
-	802.11a	5745-5825	149 to 165	149, 157, 165	OFDM	BPSK	6.0
-	802.11n (HT20)		149 to 165	149, 157, 165	OFDM	BPSK	7.2
-	802.11n (HT40)		151 to 159	151, 159	OFDM	BPSK	15.0
-	802.11ac (VHT80)		155	155	OFDM	BPSK	97.5

Radiated Emission Test (Below 1GHz):

- Pre-Scan has been conducted to determine the worst-case mode from all possible combinations between available modulations, data rates and antenna ports (if EUT with antenna diversity architecture).
- Following channel(s) was (were) selected for the final test as listed below.

EUT CONFIGURE MODE	MODE	FREQ. BAND (MHz)	AVAILABLE CHANNEL	TESTED CHANNEL	MODULATION TECHNOLOGY	MODULATION TYPE	DATA RATE (Mbps)
-	802.11a	5180-5320 5745-5825	36 to 64 149 to 165	157	OFDM	BPSK	6.0

Power Line Conducted Emission Test:

- Pre-Scan has been conducted to determine the worst-case mode from all possible combinations between available modulations, data rates and antenna ports (if EUT with antenna diversity architecture).
- Following channel(s) was (were) selected for the final test as listed below.

EUT CONFIGURE MODE	MODE	FREQ. BAND (MHz)	AVAILABLE CHANNEL	TESTED CHANNEL	MODULATION TECHNOLOGY	MODULATION TYPE	DATA RATE (Mbps)
-	802.11a	5180-5320 5745-5825	36 to 64 149 to 165	157	OFDM	BPSK	6.0

Antenna Port Conducted Measurement:

- This item includes all test value of each mode, but only includes spectrum plot of worst value of each mode.
- Pre-Scan has been conducted to determine the worst-case mode from all possible combinations between available modulations, data rates and antenna ports (if EUT with antenna diversity architecture).
- Following channel(s) was (were) selected for the final test as listed below.

EUT CONFIGURE MODE	MODE	FREQ. BAND (MHz)	AVAILABLE CHANNEL	TESTED CHANNEL	MODULATION TECHNOLOGY	MODULATION TYPE	DATA RATE (Mbps)
-	802.11a	5180-5240	36 to 48	36, 40, 48	OFDM	BPSK	6.0
-	802.11n (HT20)		36 to 48	36, 40, 48	OFDM	BPSK	7.2
-	802.11n (HT40)		38 to 46	38, 46	OFDM	BPSK	15.0
-	802.11ac (VHT80)		42	42	OFDM	BPSK	97.5
-	802.11a	5745-5825	149 to 165	149, 157, 165	OFDM	BPSK	6.0
-	802.11n (HT20)		149 to 165	149, 157, 165	OFDM	BPSK	7.2
-	802.11n (HT40)		151 to 159	151, 159	OFDM	BPSK	15.0
-	802.11ac (VHT80)		155	155	OFDM	BPSK	97.5

Test Condition:

APPLICABLE TO	ENVIRONMENTAL CONDITIONS	INPUT POWER (SYSTEM)	TESTED BY
RE \geq 1G	18deg. C, 70%RH	120Vac, 60Hz	Jones Chang
RE $<$ 1G	18deg. C, 70%RH	120Vac, 60Hz	Nick Hsu
PLC	20deg. C, 70%RH	120Vac, 60Hz	Jones Chang
APCM	25deg. C, 60%RH	120Vac, 60Hz	Antony Lee

3.3 Duty Cycle of Test Signal

Duty cycle of test signal is < 98 %, duty factor is required

802.11a: Duty cycle = $1.975/2.150 = 0.919$, Duty factor = $10 * \log(1/0.919) = 0.37$

802.11n (HT20): Duty cycle = $1.837/1.950 = 0.942$, Duty factor = $10 * \log(1/0.942) = 0.26$

802.11n (HT40): Duty cycle = $0.875/1.037 = 0.844$, Duty factor = $10 * \log(1/0.844) = 0.74$

802.11ac (VHT80): Duty cycle = $0.388/0.513 = 0.756$, Duty factor = $10 * \log(1/0.756) = 1.21$

802.11a **802.11n (HT20)**

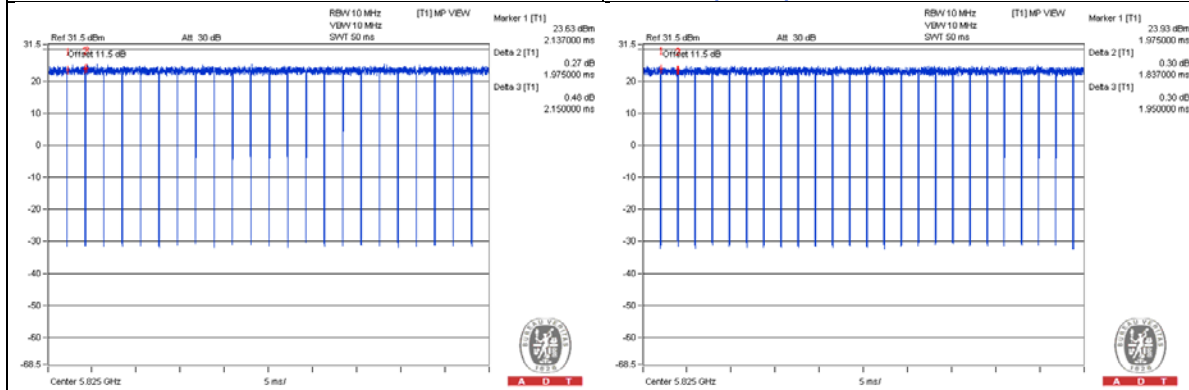

802.11n (HT40) **802.11ac (VHT80)**

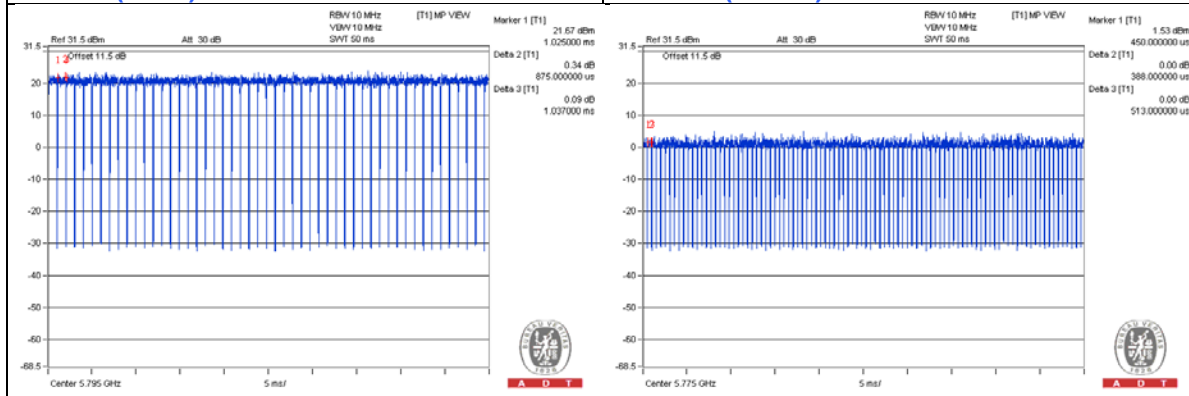

3.4 Description of Support Units

The EUT has been tested as an independent unit together with other necessary accessories or support units. The following support units or accessories were used to form a representative test configuration during the tests.

ID	Product	Brand	Model No.	Serial No.	FCC ID	Remarks
A.	Notebook	DELL	E5410	1HC2XM1	FCC DoC Approved	-
B.	POE	PHIHONG	POE36U-1AT-R	NA	NA	Provided by manufacturer.

Note:

1. All power cords of the above support units are non-shielded (1.8m).
2. Item A acted as a communication partner to transfer data.

ID	Descriptions	Qty.	Length (m)	Shielding (Yes/No)	Cores (Qty.)	Remarks
1.	RJ45 cable	1	3	N	0	-
2.	RJ45 cable	1	1.8	N	0	-

3.4.1 Configuration of System under Test

For Conducted Emission Test

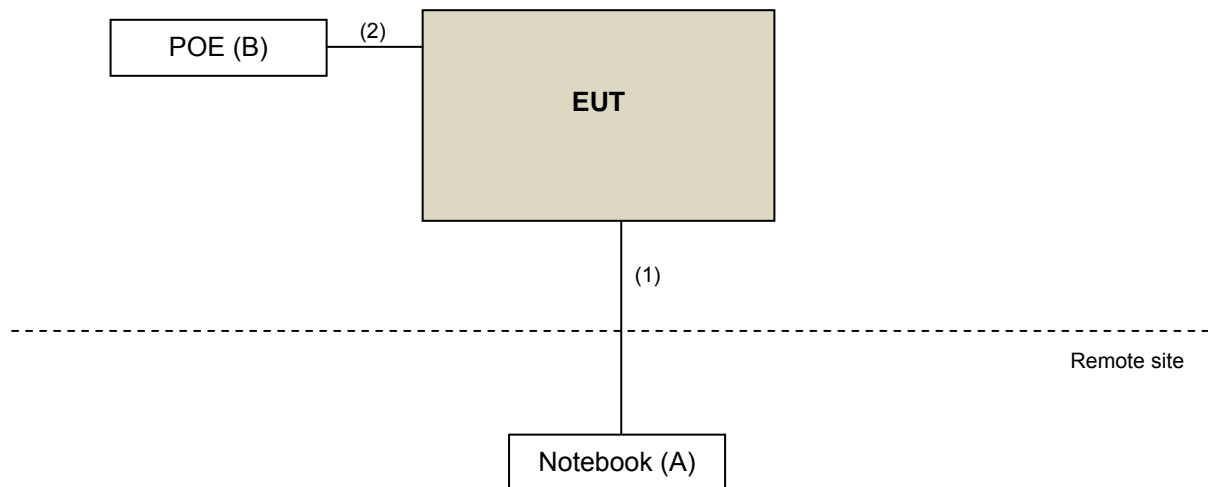

For Radiated Emissions Test

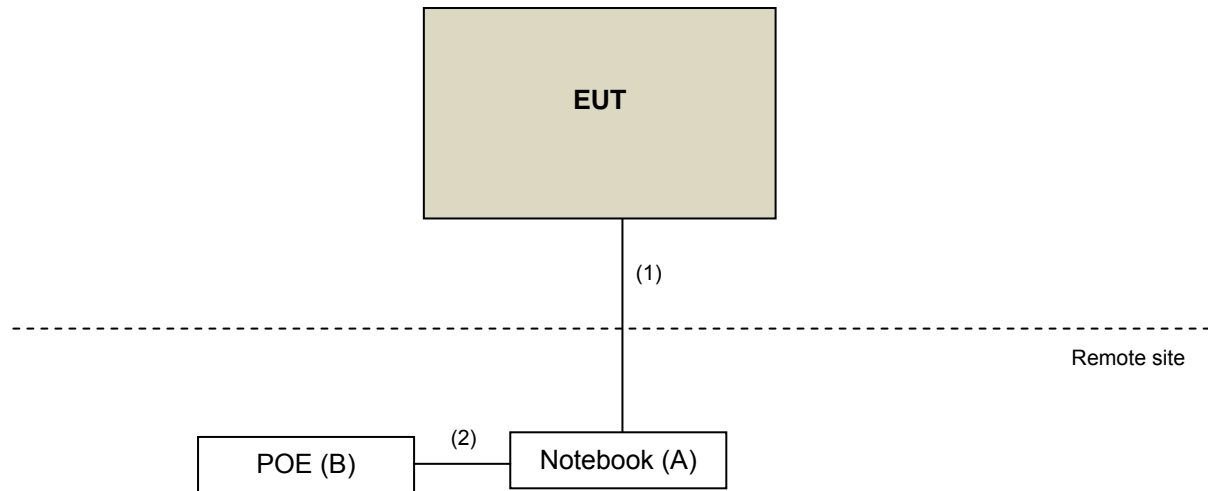

3.5 General Description of Applied Standard

The EUT is a RF Product. According to the specifications of the manufacturer, it must comply with the requirements of the following standards:

FCC Part 15, Subpart E (15.407)
789033 D02 General UNII Test Procedure New Rules v01
662911 D01 Multiple Transmitter Output v02r01
ANSI C63.10-2013

All test items have been performed and recorded as per the above standards.

NOTE: The EUT is also considered as a kind of computer peripheral, because the connection to computer is necessary for typical use. It has been verified to comply with the requirements of FCC Part 15, Subpart B, Class B (DoC). The test report has been issued separately.

4 Test Types and Results

4.1 Radiated Emission and Bandedge Measurement

4.1.1 Limits of Radiated Emission and Bandedge Measurement

Radiated emissions which fall in the restricted bands must comply with the radiated emission limits specified as below table.

Frequencies (MHz)	Field Strength (microvolts/meter)	Measurement Distance (meters)
0.009 ~ 0.490	2400/F(kHz)	300
0.490 ~ 1.705	24000/F(kHz)	30
1.705 ~ 30.0	30	30
30 ~ 88	100	3
88 ~ 216	150	3
216 ~ 960	200	3
Above 960	500	3

NOTE:

1. The lower limit shall apply at the transition frequencies.
2. Emission level (dBuV/m) = 20 log Emission level (uV/m).
3. For frequencies above 1000MHz, the field strength limits are based on average detector, however, the peak field strength of any emission shall not exceed the maximum permitted average limits, specified above by more than 20dB under any Condition of modulation.

LIMITS OF UNWANTED EMISSION OUT OF THE RESTRICTED BANDS

APPLICABLE TO	LIMIT	
789033 D02 General UNII Test Procedure New Rules v01	FIELD STRENGTH AT 3m	
	PK:74 (dBuV/m)	AV:54 (dBuV/m)
APPLICABLE TO	EIRP LIMIT	EQUIVALENT FIELD STRENGTH AT 3m
15.407(b)(1)	PK:-27 (dBm/MHz)	PK:68.2(dBuV/m)
15.407(b)(2)		
15.407(b)(3)		
15.407(b)(4)	PK:-27 (dBm/MHz) ^{*1} PK:-17 (dBm/MHz) ^{*2}	PK: 68.2(dBuV/m) ^{*1} PK:78.2 (dBuV/m) ^{*2}

NOTE: ^{*1} beyond 10MHz of the band edge ^{*2} within 10 MHz of band edge

The following formula is used to convert the equipment isotropic radiated power (eirp) to field strength:

$$E = \frac{1000000\sqrt{30P}}{3} \mu\text{V/m, where } P \text{ is the eirp (Watts).}$$

4.1.2 Test Instruments

Description & Manufacturer	Model No.	Serial No.	Date of Calibration	Due Date of Calibration
Test Receiver ROHDE & SCHWARZ	ESIB7	100187	Apr. 10, 2015	Apr. 09, 2016
Spectrum Analyzer ROHDE & SCHWARZ	FSP40	100041	Aug. 29, 2014	Aug. 28, 2015
BILOG Antenna SCHWARZBECK	VULB9168	9168-160	Feb. 05, 2015	Feb. 04, 2016
HORN Antenna SCHWARZBECK	9120D	209	Feb. 09, 2015	Feb. 08, 2016
HORN Antenna SCHWARZBECK	BBHA 9170	BBHA9170241	Feb. 09, 2015	Feb. 08, 2016
Preamplifier Agilent	8447D	2944A10738	Oct. 18, 2014	Oct. 17, 2015
Preamplifier Agilent	8449B	3008A01964	Aug. 22, 2014	Aug. 21, 2015
RF signal cable HUBER+SUHNNER	SUCOFLEX 104	214378/4	Aug. 22, 2014	Aug. 21, 2015
RF signal cable HUBER+SUHNNER	SUCOFLEX 106	12738/6 +309224/4	Aug. 22, 2014	Aug. 21, 2015
Software BV ADT	ADT_Radiated_ V7.6.15.9.4	NA	NA	NA
Antenna Tower inn-co GmbH	MA 4000	013303	NA	NA
Antenna Tower Controller BV ADT	AT100	AT93021702	NA	NA
Turn Table BV ADT	TT100	TT93021702	NA	NA
Turn Table Controller BV ADT	SC100	SC93021702	NA	NA
High Speed Power Meter	ML2495A	0824011	Jul. 26, 2014	Jul. 25, 2015
Power Sensor	MA2411B	0738171	Jul. 26, 2014	Jul. 25, 2015
26GHz ~ 40GHz Amplifier	EM26400	815221	Oct. 18, 2014	Oct. 17, 2015
WIT Standard Temperature And Humidity Chamber	TH-4S-C	W981030	Jun. 09, 2014	Jun. 08, 2015

- NOTE:**
1. The calibration interval of the above test instruments is 12 months and the calibrations are traceable to NML/ROC and NIST/USA.
 2. The test was performed in HwaYa Chamber 3.
 3. The horn antenna and HP preamplifier (model: 8449B) are used only for the measurement of emission frequency above 1GHz if tested.
 4. The FCC Site Registration No. is 988962.
 5. The IC Site Registration No. is IC 7450F-3.

4.1.3 Test Procedure

- a. The EUT was placed on the top of a rotating table 0.8 meters (for below 1GHz) / 1.5 meters (for above 1GHz) above the ground at 3 meter chamber room for test. The table was rotated 360 degrees to determine the position of the highest radiation.
- b. The EUT was set 3 meters away from the interference-receiving antenna, which was mounted on the top of a variable-height antenna tower.
- c. The height of antenna is varied from one meter to four meters above the ground to determine the maximum value of the field strength. Both horizontal and vertical polarizations of the antenna are set to make the measurement.
- d. For each suspected emission, the EUT was arranged to its worst case and then the antenna was tuned to heights from 1 meter to 4 meters and the rotatable table was turned from 0 degrees to 360 degrees to find the maximum reading.
- e. The test-receiver system was set to quasi-peak detect function and specified bandwidth with maximum hold mode when the test frequency is below 1 GHz.
- f. The test-receiver system was set to peak and average detect function and specified bandwidth with maximum hold mode when the test frequency is above 1 GHz. If the peak reading value also meets average limit, measurement with the average detector is unnecessary.

Note:

1. The resolution bandwidth and video bandwidth of test receiver/spectrum analyzer is 120kHz for Quasi-peak detection (QP) at frequency below 1GHz.
2. The resolution bandwidth of test receiver/spectrum analyzer is 1 MHz and the video bandwidth is 3 MHz for Peak detection (PK) at frequency above 1GHz.
3. The resolution bandwidth of test receiver/spectrum analyzer is 1MHz and the video bandwidth is 3MHz for RMS Average (Duty cycle < 98%) for Average detection (AV) at frequency above 1GHz, then the measurement results was added to a correction factor ($10 \log(1/\text{duty cycle})$).
4. The resolution bandwidth of test receiver/spectrum analyzer is 1MHz and the video bandwidth is 10Hz (Duty cycle $\geq 98\%$) for Average detection (AV) at frequency above 1GHz.
5. All modes of operation were investigated and the worst-case emissions are reported.

4.1.4 Deviation from Test Standard

No deviation.

4.1.5 Test Setup

<Frequency Range 30MHz~1GHz>

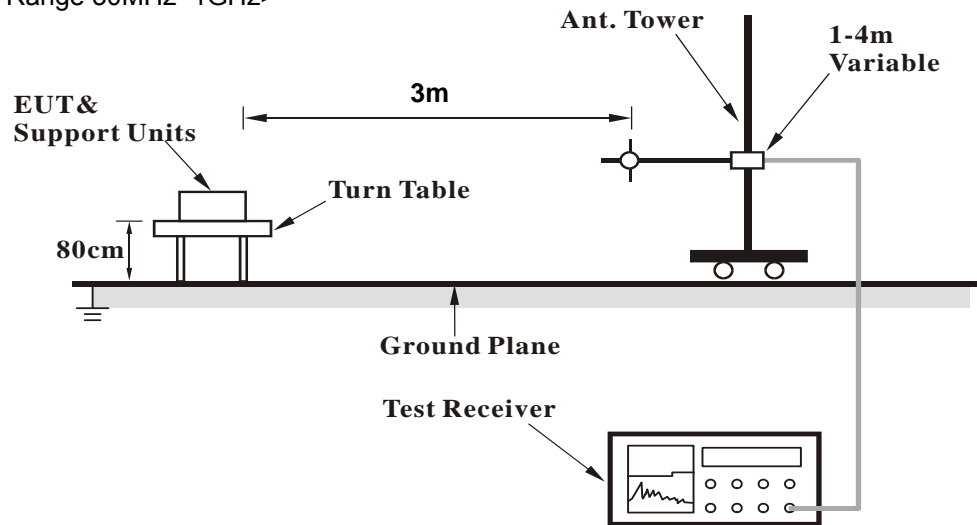

<Frequency Range above 1GHz>

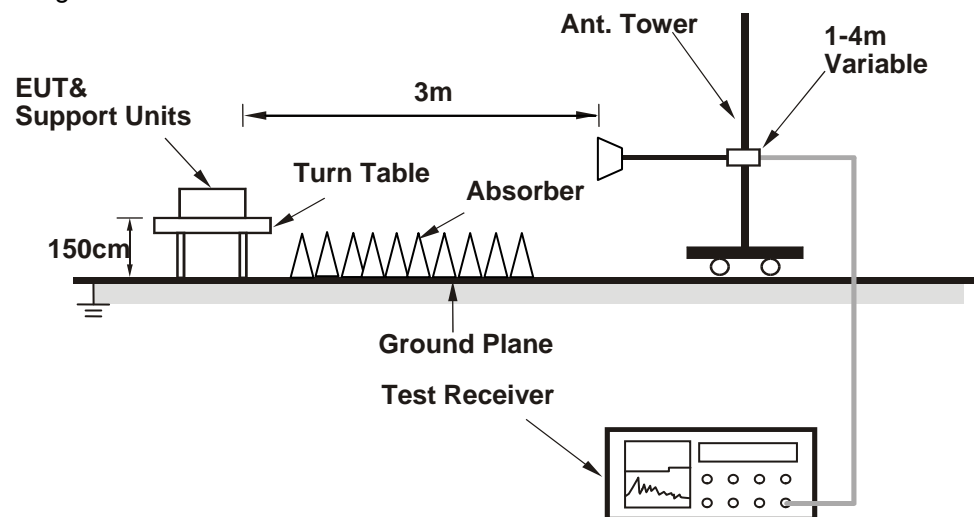

For the actual test configuration, please refer to the attached file (Test Setup Photo).

4.1.6 EUT Operating Conditions

- Placed the EUT on the testing table.
- Prepared a notebook to act as a communication partner and placed it outside of testing area.
- The communication partner connected with EUT via a RJ45 cable and ran a test program (provided by manufacturer) to enable EUT under transmission condition continuously at specific channel frequency.
- The communication partner sent data to EUT by command "PING".

4.1.7 Test Results
ABOVE 1GHz DATA :
802.11a

CHANNEL	TX Channel 36	DETECTOR FUNCTION	Peak (PK)
FREQUENCY RANGE	1GHz ~ 40GHz		Average (AV)

ANTENNA POLARITY & TEST DISTANCE: HORIZONTAL AT 3 M

NO.	FREQ. (MHz)	EMISSION LEVEL (dBuV/m)	LIMIT (dBuV/m)	MARGIN (dB)	ANTENNA HEIGHT (m)	TABLE ANGLE (Degree)	RAW VALUE (dBuV)	CORRECTION FACTOR (dB/m)
1	5150.00	57.8 PK	74.0	-16.2	1.75 H	230	51.80	6.00
2	5150.00	46.8 AV	54.0	-7.2	1.75 H	230	40.80	6.00
3	*5180.00	104.6 PK			1.75 H	17	65.10	39.50
4	*5180.00	93.4 AV			1.75 H	17	53.90	39.50
5	#10360.00	60.5 PK	74.0	-13.5	1.47 H	177	42.10	18.40
6	#10360.00	47.3 AV	54.0	-6.7	1.47 H	177	28.90	18.40

ANTENNA POLARITY & TEST DISTANCE: VERTICAL AT 3 M

NO.	FREQ. (MHz)	EMISSION LEVEL (dBuV/m)	LIMIT (dBuV/m)	MARGIN (dB)	ANTENNA HEIGHT (m)	TABLE ANGLE (Degree)	RAW VALUE (dBuV)	CORRECTION FACTOR (dB/m)
1	5150.00	72.7 PK	74.0	-1.3	1.75 V	183	66.70	6.00
2	5150.00	49.4 AV	54.0	-4.6	1.75 V	183	43.40	6.00
3	*5180.00	119.9 PK			1.54 V	227	80.40	39.50
4	*5180.00	109.2 AV			1.54 V	227	69.70	39.50
5	#10360.00	60.9 PK	74.0	-13.1	1.63 V	138	42.50	18.40
6	#10360.00	47.9 AV	54.0	-6.1	1.63 V	138	29.50	18.40

REMARKS:

1. Emission Level(dBuV/m) = Raw Value(dBuV) + Correction Factor(dB/m)
2. Correction Factor(dB/m) = Antenna Factor(dB/m) + Cable Factor(dB)
– Pre-Amplifier Factor(dB)
3. The other emission levels were very low against the limit.
4. Margin value = Emission Level – Limit value
5. " * ": Fundamental frequency.
6. " # ": The radiated frequency is out of the restricted band.

CHANNEL	TX Channel 40	DETECTOR FUNCTION	Peak (PK)
FREQUENCY RANGE	1GHz ~ 40GHz		Average (AV)

ANTENNA POLARITY & TEST DISTANCE: HORIZONTAL AT 3 M

NO.	FREQ. (MHz)	EMISSION LEVEL (dBuV/m)	LIMIT (dBuV/m)	MARGIN (dB)	ANTENNA HEIGHT (m)	TABLE ANGLE (Degree)	RAW VALUE (dBuV)	CORRECTION FACTOR (dB/m)
1	5040.00	57.8 PK	74.0	-16.2	1.45 H	175	52.10	5.70
2	5040.00	46.3 AV	54.0	-7.7	1.45 H	175	40.60	5.70
3	*5200.00	107.5 PK			1.78 H	19	67.90	39.60
4	*5200.00	96.4 AV			1.78 H	19	56.80	39.60
5	#10400.00	60.4 PK	74.0	-13.6	1.23 H	354	41.90	18.50
6	#10400.00	47.2 AV	54.0	-6.8	1.23 H	354	28.70	18.50

ANTENNA POLARITY & TEST DISTANCE: VERTICAL AT 3 M

NO.	FREQ. (MHz)	EMISSION LEVEL (dBuV/m)	LIMIT (dBuV/m)	MARGIN (dB)	ANTENNA HEIGHT (m)	TABLE ANGLE (Degree)	RAW VALUE (dBuV)	CORRECTION FACTOR (dB/m)
1	5040.00	63.6 PK	74.0	-10.4	1.86 V	259	57.90	5.70
2	5040.00	50.4 AV	54.0	-3.6	1.86 V	259	44.70	5.70
3	*5200.00	124.5 PK			1.89 V	0	84.90	39.60
4	*5200.00	113.9 AV			1.89 V	0	74.30	39.60
5	#10400.00	61.3 PK	74.0	-12.7	1.25 V	207	42.80	18.50
6	#10400.00	48.1 AV	54.0	-5.9	1.25 V	207	29.60	18.50

REMARKS:

1. Emission Level(dBuV/m) = Raw Value(dBuV) + Correction Factor(dB/m)
2. Correction Factor(dB/m) = Antenna Factor(dB/m) + Cable Factor(dB) – Pre-Amplifier Factor(dB)
3. The other emission levels were very low against the limit.
4. Margin value = Emission Level – Limit value
5. " * ": Fundamental frequency.
6. " # ": The radiated frequency is out of the restricted band.



CHANNEL	TX Channel 48	DETECTOR FUNCTION	Peak (PK)
FREQUENCY RANGE	1GHz ~ 40GHz		Average (AV)

ANTENNA POLARITY & TEST DISTANCE: HORIZONTAL AT 3 M

NO.	FREQ. (MHz)	EMISSION LEVEL (dBuV/m)	LIMIT (dBuV/m)	MARGIN (dB)	ANTENNA HEIGHT (m)	TABLE ANGLE (Degree)	RAW VALUE (dBuV)	CORRECTION FACTOR (dB/m)
1	5080.00	57.4 PK	74.0	-16.6	1.71 H	93	51.60	5.80
2	5080.00	46.3 AV	54.0	-7.7	1.71 H	93	40.50	5.80
3	*5240.00	107.5 PK			1.71 H	11	67.90	39.60
4	*5240.00	97.1 AV			1.71 H	11	57.50	39.60
5	5440.00	58.6 PK	74.0	-15.4	1.50 H	183	52.30	6.30
6	5440.00	47.8 AV	54.0	-6.2	1.50 H	183	41.50	6.30
7	#10480.00	60.6 PK	74.0	-13.4	1.39 H	262	41.60	19.00
8	#10480.00	47.4 AV	54.0	-6.6	1.39 H	262	28.40	19.00

ANTENNA POLARITY & TEST DISTANCE: VERTICAL AT 3 M

NO.	FREQ. (MHz)	EMISSION LEVEL (dBuV/m)	LIMIT (dBuV/m)	MARGIN (dB)	ANTENNA HEIGHT (m)	TABLE ANGLE (Degree)	RAW VALUE (dBuV)	CORRECTION FACTOR (dB/m)
1	5080.00	65.2 PK	74.0	-8.8	2.00 V	186	59.40	5.80
2	5080.00	52.1 AV	54.0	-1.9	2.00 V	186	46.30	5.80
3	*5240.00	124.3 PK			1.87 V	2	84.70	39.60
4	*5240.00	113.9 AV			1.87 V	2	74.30	39.60
5	5440.00	62.6 PK	74.0	-11.4	2.01 V	167	56.30	6.30
6	5440.00	51.1 AV	54.0	-2.9	2.01 V	167	44.80	6.30
7	#10480.00	61.9 PK	74.0	-12.1	1.63 V	222	42.90	19.00
8	#10480.00	48.8 AV	54.0	-5.2	1.63 V	222	29.80	19.00

REMARKS:

- Emission Level(dBuV/m) = Raw Value(dBuV) + Correction Factor(dB/m)
- Correction Factor(dB/m) = Antenna Factor(dB/m) + Cable Factor(dB)
– Pre-Amplifier Factor(dB)
- The other emission levels were very low against the limit.
- Margin value = Emission Level – Limit value
- " * ": Fundamental frequency.
- " # ": The radiated frequency is out of the restricted band.



CHANNEL	TX Channel 149	DETECTOR FUNCTION	Peak (PK)
FREQUENCY RANGE	1GHz ~ 40GHz		Average (AV)

ANTENNA POLARITY & TEST DISTANCE: HORIZONTAL AT 3 M

NO.	FREQ. (MHz)	EMISSION LEVEL (dBuV/m)	LIMIT (dBuV/m)	MARGIN (dB)	ANTENNA HEIGHT (m)	TABLE ANGLE (Degree)	RAW VALUE (dBuV)	CORRECTION FACTOR (dB/m)
1	#5714.00	72.6 PK	74.0	-1.4	1.09 H	333	65.80	6.80
2	#5714.00	50.9 AV	54.0	-3.1	1.09 H	333	44.10	6.80
3	#5722.00	75.1 PK	78.2	-3.1	1.00 H	333	68.30	6.80
4	#5725.00	58.8 PK	78.2	-19.4	1.00 H	337	52.00	6.80
5	*5745.00	120.5 PK			1.12 H	333	80.10	40.40
6	*5745.00	110.4 AV			1.12 H	333	70.00	40.40
7	11490.00	59.2 PK	74.0	-14.8	1.17 H	243	40.80	18.40
8	11490.00	46.3 AV	54.0	-7.7	1.17 H	243	27.90	18.40

ANTENNA POLARITY & TEST DISTANCE: VERTICAL AT 3 M

NO.	FREQ. (MHz)	EMISSION LEVEL (dBuV/m)	LIMIT (dBuV/m)	MARGIN (dB)	ANTENNA HEIGHT (m)	TABLE ANGLE (Degree)	RAW VALUE (dBuV)	CORRECTION FACTOR (dB/m)
1	#5714.00	60.9 PK	74.0	-13.1	1.53 V	333	54.10	6.80
2	#5714.00	49.2 AV	54.0	-4.8	1.53 V	333	42.40	6.80
3	#5722.00	62.4 PK	78.2	-15.8	1.78 V	159	55.60	6.80
4	#5725.00	58.3 PK	78.2	-19.9	1.78 V	159	51.50	6.80
5	*5745.00	102.9 PK			1.87 V	158	62.50	40.40
6	*5745.00	93.0 AV			1.87 V	158	52.60	40.40
7	11490.00	60.8 PK	74.0	-13.2	1.68 V	290	42.40	18.40
8	11490.00	47.7 AV	54.0	-6.3	1.68 V	290	29.30	18.40

REMARKS:

- Emission Level(dBuV/m) = Raw Value(dBuV) + Correction Factor(dB/m)
- Correction Factor(dB/m) = Antenna Factor(dB/m) + Cable Factor(dB)
– Pre-Amplifier Factor(dB)
- The other emission levels were very low against the limit.
- Margin value = Emission Level – Limit value
- " * ": Fundamental frequency.
- " # ": The radiated frequency is out of the restricted band.



CHANNEL	TX Channel 157	DETECTOR FUNCTION	Peak (PK)
FREQUENCY RANGE	1GHz ~ 40GHz		Average (AV)

ANTENNA POLARITY & TEST DISTANCE: HORIZONTAL AT 3 M

NO.	FREQ. (MHz)	EMISSION LEVEL (dBuV/m)	LIMIT (dBuV/m)	MARGIN (dB)	ANTENNA HEIGHT (m)	TABLE ANGLE (Degree)	RAW VALUE (dBuV)	CORRECTION FACTOR (dB/m)
1	*5785.00	153.0 PK			1.94 H	333	112.50	40.50
2	*5785.00	141.7 AV			1.94 H	333	101.20	40.50
3	11570.00	63.3 PK	74.0	-10.7	2.04 H	145	44.90	18.40
4	11570.00	50.2 AV	54.0	-3.8	2.04 H	145	31.80	18.40

ANTENNA POLARITY & TEST DISTANCE: VERTICAL AT 3 M

NO.	FREQ. (MHz)	EMISSION LEVEL (dBuV/m)	LIMIT (dBuV/m)	MARGIN (dB)	ANTENNA HEIGHT (m)	TABLE ANGLE (Degree)	RAW VALUE (dBuV)	CORRECTION FACTOR (dB/m)
1	*5785.00	110.9 PK			1.00 V	9	70.40	40.50
2	*5785.00	100.6 AV			1.00 V	9	60.10	40.50
3	11570.00	62.0 PK	74.0	-12.0	1.60 V	144	43.60	18.40
4	11570.00	49.0 AV	54.0	-5.0	1.60 V	144	30.60	18.40

REMARKS:

1. Emission Level(dBuV/m) = Raw Value(dBuV) + Correction Factor(dB/m)
2. Correction Factor(dB/m) = Antenna Factor(dB/m) + Cable Factor(dB)
– Pre-Amplifier Factor(dB)
3. The other emission levels were very low against the limit.
4. Margin value = Emission Level – Limit value
5. " * " : Fundamental frequency.



CHANNEL	TX Channel 165	DETECTOR FUNCTION	Peak (PK)
FREQUENCY RANGE	1GHz ~ 40GHz		Average (AV)

ANTENNA POLARITY & TEST DISTANCE: HORIZONTAL AT 3 M

NO.	FREQ. (MHz)	EMISSION LEVEL (dBuV/m)	LIMIT (dBuV/m)	MARGIN (dB)	ANTENNA HEIGHT (m)	TABLE ANGLE (Degree)	RAW VALUE (dBuV)	CORRECTION FACTOR (dB/m)
1	*5825.00	120.8 PK			2.01 H	330	80.30	40.50
2	*5825.00	111.0 AV			2.01 H	330	70.50	40.50
3	#5850.00	62.4 PK	78.2	-15.8	1.72 H	149	55.50	6.90
4	#5853.00	70.5 PK	78.2	-7.7	1.72 H	149	63.50	7.00
5	#5861.00	71.6 PK	74.0	-2.4	1.96 H	33	64.60	7.00
6	#5861.00	52.1 AV	54.0	-1.9	1.96 H	33	45.10	7.00
7	11650.00	61.6 PK	74.0	-12.4	1.42 H	165	42.70	18.90
8	11650.00	48.4 AV	54.0	-5.6	1.42 H	165	29.50	18.90

ANTENNA POLARITY & TEST DISTANCE: VERTICAL AT 3 M

NO.	FREQ. (MHz)	EMISSION LEVEL (dBuV/m)	LIMIT (dBuV/m)	MARGIN (dB)	ANTENNA HEIGHT (m)	TABLE ANGLE (Degree)	RAW VALUE (dBuV)	CORRECTION FACTOR (dB/m)
1	*5825.00	106.8 PK			1.19 V	2	66.30	40.50
2	*5825.00	96.4 AV			1.19 V	2	55.90	40.50
3	#5850.00	60.3 PK	78.2	-17.9	1.35 V	351	53.40	6.90
4	#5853.00	61.8 PK	78.2	-16.4	1.35 V	351	54.80	7.00
5	#5861.00	59.0 PK	74.0	-15.0	1.19 V	2	52.00	7.00
6	#5861.00	47.8 AV	54.0	-6.2	1.19 V	2	40.80	7.00
7	11650.00	60.8 PK	74.0	-13.2	1.58 V	145	41.90	18.90
8	11650.00	47.9 AV	54.0	-6.1	1.58 V	145	29.00	18.90

REMARKS:

- Emission Level(dBuV/m) = Raw Value(dBuV) + Correction Factor(dB/m)
- Correction Factor(dB/m) = Antenna Factor(dB/m) + Cable Factor(dB)
– Pre-Amplifier Factor(dB)
- The other emission levels were very low against the limit.
- Margin value = Emission Level – Limit value
- " * ": Fundamental frequency.
- " # ": The radiated frequency is out of the restricted band.

802.11n (HT20)

CHANNEL	TX Channel 36	DETECTOR FUNCTION	Peak (PK)
FREQUENCY RANGE	1GHz ~ 40GHz		Average (AV)

ANTENNA POLARITY & TEST DISTANCE: HORIZONTAL AT 3 M

NO.	FREQ. (MHz)	EMISSION LEVEL (dBuV/m)	LIMIT (dBuV/m)	MARGIN (dB)	ANTENNA HEIGHT (m)	TABLE ANGLE (Degree)	RAW VALUE (dBuV)	CORRECTION FACTOR (dB/m)
1	5150.00	57.3 PK	74.0	-16.7	1.71 H	22	51.30	6.00
2	5150.00	46.4 AV	54.0	-7.6	1.71 H	22	40.40	6.00
3	*5180.00	104.2 PK			1.60 H	10	64.70	39.50
4	*5180.00	94.0 AV			1.60 H	10	54.50	39.50
5	#10360.00	59.8 PK	74.0	-14.2	1.50 H	188	41.40	18.40
6	#10360.00	46.9 AV	54.0	-7.1	1.50 H	188	28.50	18.40

ANTENNA POLARITY & TEST DISTANCE: VERTICAL AT 3 M

NO.	FREQ. (MHz)	EMISSION LEVEL (dBuV/m)	LIMIT (dBuV/m)	MARGIN (dB)	ANTENNA HEIGHT (m)	TABLE ANGLE (Degree)	RAW VALUE (dBuV)	CORRECTION FACTOR (dB/m)
1	5150.00	72.8 PK	74.0	-1.2	1.73 V	226	66.80	6.00
2	5150.00	49.7 AV	54.0	-4.3	1.73 V	226	43.70	6.00
3	*5180.00	118.9 PK			1.51 V	204	79.40	39.50
4	*5180.00	108.5 AV			1.51 V	204	69.00	39.50
5	#10360.00	60.1 PK	74.0	-13.9	1.20 V	244	41.70	18.40
6	#10360.00	47.1 AV	54.0	-6.9	1.20 V	244	28.70	18.40

REMARKS:

1. Emission Level(dBuV/m) = Raw Value(dBuV) + Correction Factor(dB/m)
2. Correction Factor(dB/m) = Antenna Factor(dB/m) + Cable Factor(dB)
– Pre-Amplifier Factor(dB)
3. The other emission levels were very low against the limit.
4. Margin value = Emission Level – Limit value
5. " * ": Fundamental frequency.
6. " # ": The radiated frequency is out of the restricted band.

CHANNEL	TX Channel 40	DETECTOR FUNCTION	Peak (PK)
FREQUENCY RANGE	1GHz ~ 40GHz		Average (AV)

ANTENNA POLARITY & TEST DISTANCE: HORIZONTAL AT 3 M

NO.	FREQ. (MHz)	EMISSION LEVEL (dBuV/m)	LIMIT (dBuV/m)	MARGIN (dB)	ANTENNA HEIGHT (m)	TABLE ANGLE (Degree)	RAW VALUE (dBuV)	CORRECTION FACTOR (dB/m)
1	*5200.00	107.4 PK			1.72 H	19	67.80	39.60
2	*5200.00	97.0 AV			1.72 H	19	57.40	39.60
3	#10400.00	60.4 PK	74.0	-13.6	1.52 H	311	41.90	18.50
4	#10400.00	47.4 AV	54.0	-6.6	1.52 H	311	28.90	18.50

ANTENNA POLARITY & TEST DISTANCE: VERTICAL AT 3 M

NO.	FREQ. (MHz)	EMISSION LEVEL (dBuV/m)	LIMIT (dBuV/m)	MARGIN (dB)	ANTENNA HEIGHT (m)	TABLE ANGLE (Degree)	RAW VALUE (dBuV)	CORRECTION FACTOR (dB/m)
1	*5200.00	121.9 PK			1.52 V	216	82.30	39.60
2	*5200.00	111.8 AV			1.52 V	216	72.20	39.60
3	#10400.00	60.7 PK	74.0	-13.3	1.22 V	11	42.20	18.50
4	#10400.00	47.5 AV	54.0	-6.5	1.22 V	11	29.00	18.50

REMARKS:

1. Emission Level(dBuV/m) = Raw Value(dBuV) + Correction Factor(dB/m)
2. Correction Factor(dB/m) = Antenna Factor(dB/m) + Cable Factor(dB)
– Pre-Amplifier Factor(dB)
3. The other emission levels were very low against the limit.
4. Margin value = Emission Level – Limit value
5. " * " : Fundamental frequency.

CHANNEL	TX Channel 48	DETECTOR FUNCTION	Peak (PK)
FREQUENCY RANGE	1GHz ~ 40GHz		Average (AV)

ANTENNA POLARITY & TEST DISTANCE: HORIZONTAL AT 3 M

NO.	FREQ. (MHz)	EMISSION LEVEL (dBuV/m)	LIMIT (dBuV/m)	MARGIN (dB)	ANTENNA HEIGHT (m)	TABLE ANGLE (Degree)	RAW VALUE (dBuV)	CORRECTION FACTOR (dB/m)
1	5080.00	56.4 PK	74.0	-17.6	1.77 H	85	50.60	5.80
2	5080.00	45.3 AV	54.0	-8.7	1.77 H	85	39.50	5.80
3	*5240.00	106.1 PK			1.77 H	10	66.50	39.60
4	*5240.00	96.2 AV			1.77 H	10	56.60	39.60
5	5440.00	58.9 PK	74.0	-15.1	1.60 H	199	52.60	6.30
6	5440.00	47.3 AV	54.0	-6.7	1.60 H	199	41.00	6.30
7	#10480.00	60.1 PK	74.0	-13.9	1.39 H	23	41.10	19.00
8	#10480.00	47.3 AV	54.0	-6.7	1.39 H	23	28.30	19.00

ANTENNA POLARITY & TEST DISTANCE: VERTICAL AT 3 M

NO.	FREQ. (MHz)	EMISSION LEVEL (dBuV/m)	LIMIT (dBuV/m)	MARGIN (dB)	ANTENNA HEIGHT (m)	TABLE ANGLE (Degree)	RAW VALUE (dBuV)	CORRECTION FACTOR (dB/m)
1	5080.00	64.5 PK	74.0	-9.5	1.85 V	174	58.70	5.80
2	5080.00	52.1 AV	54.0	-1.9	1.85 V	174	46.30	5.80
3	*5240.00	124.1 PK			1.79 V	194	84.50	39.60
4	*5240.00	113.4 AV			1.79 V	194	73.80	39.60
5	5440.00	61.4 PK	74.0	-12.6	1.74 V	242	55.10	6.30
6	5440.00	49.7 AV	54.0	-4.3	1.74 V	242	43.40	6.30
7	#10480.00	61.1 PK	74.0	-12.9	1.69 V	223	42.10	19.00
8	#10480.00	48.3 AV	54.0	-5.7	1.69 V	223	29.30	19.00

REMARKS:

1. Emission Level(dBuV/m) = Raw Value(dBuV) + Correction Factor(dB/m)
2. Correction Factor(dB/m) = Antenna Factor(dB/m) + Cable Factor(dB)
– Pre-Amplifier Factor(dB)
3. The other emission levels were very low against the limit.
4. Margin value = Emission Level – Limit value
5. " * ": Fundamental frequency.
6. " # ": The radiated frequency is out of the restricted band.

CHANNEL	TX Channel 149	DETECTOR FUNCTION	Peak (PK)
FREQUENCY RANGE	1GHz ~ 40GHz		Average (AV)

ANTENNA POLARITY & TEST DISTANCE: HORIZONTAL AT 3 M

NO.	FREQ. (MHz)	EMISSION LEVEL (dBuV/m)	LIMIT (dBuV/m)	MARGIN (dB)	ANTENNA HEIGHT (m)	TABLE ANGLE (Degree)	RAW VALUE (dBuV)	CORRECTION FACTOR (dB/m)
1	#5714.00	71.7 PK	74.0	-2.3	1.72 H	151	64.90	6.80
2	#5714.00	52.0 AV	54.0	-2.0	1.72 H	151	45.20	6.80
3	#5722.00	77.2 PK	78.2	-1.0	1.91 H	337	70.40	6.80
4	#5725.00	67.5 PK	78.2	-10.7	1.91 H	337	60.70	6.80
5	*5745.00	119.2 PK			2.04 H	336	78.80	40.40
6	*5745.00	108.9 AV			2.04 H	336	68.50	40.40
7	11490.00	60.4 PK	74.0	-13.6	1.90 H	136	42.00	18.40
8	11490.00	47.6 AV	54.0	-6.4	1.90 H	136	29.20	18.40

ANTENNA POLARITY & TEST DISTANCE: VERTICAL AT 3 M

NO.	FREQ. (MHz)	EMISSION LEVEL (dBuV/m)	LIMIT (dBuV/m)	MARGIN (dB)	ANTENNA HEIGHT (m)	TABLE ANGLE (Degree)	RAW VALUE (dBuV)	CORRECTION FACTOR (dB/m)
1	#5714.00	57.3 PK	74.0	-16.7	1.35 V	336	50.50	6.80
2	#5714.00	46.5 AV	54.0	-7.5	1.35 V	336	39.70	6.80
3	#5722.00	64.3 PK	78.2	-13.9	1.30 V	330	57.50	6.80
4	#5725.00	57.9 PK	78.2	-20.3	1.30 V	330	51.10	6.80
5	*5745.00	105.1 PK			1.35 V	335	64.70	40.40
6	*5745.00	94.3 AV			1.35 V	335	53.90	40.40
7	11490.00	60.3 PK	74.0	-13.7	1.00 V	194	41.90	18.40
8	11490.00	47.2 AV	54.0	-6.8	1.00 V	194	28.80	18.40

REMARKS:

1. Emission Level(dBuV/m) = Raw Value(dBuV) + Correction Factor(dB/m)
2. Correction Factor(dB/m) = Antenna Factor(dB/m) + Cable Factor(dB)
– Pre-Amplifier Factor(dB)
3. The other emission levels were very low against the limit.
4. Margin value = Emission Level – Limit value
5. " * ": Fundamental frequency.
6. " # ": The radiated frequency is out of the restricted band.

CHANNEL	TX Channel 157	DETECTOR FUNCTION	Peak (PK)
FREQUENCY RANGE	1GHz ~ 40GHz		Average (AV)

ANTENNA POLARITY & TEST DISTANCE: HORIZONTAL AT 3 M

NO.	FREQ. (MHz)	EMISSION LEVEL (dBuV/m)	LIMIT (dBuV/m)	MARGIN (dB)	ANTENNA HEIGHT (m)	TABLE ANGLE (Degree)	RAW VALUE (dBuV)	CORRECTION FACTOR (dB/m)
1	*5785.00	124.4 PK			2.12 H	331	83.90	40.50
2	*5785.00	113.8 AV			2.12 H	331	73.30	40.50
3	11570.00	61.5 PK	74.0	-12.5	2.01 H	143	43.10	18.40
4	11570.00	48.4 AV	54.0	-5.6	2.01 H	143	30.00	18.40

ANTENNA POLARITY & TEST DISTANCE: VERTICAL AT 3 M

NO.	FREQ. (MHz)	EMISSION LEVEL (dBuV/m)	LIMIT (dBuV/m)	MARGIN (dB)	ANTENNA HEIGHT (m)	TABLE ANGLE (Degree)	RAW VALUE (dBuV)	CORRECTION FACTOR (dB/m)
1	*5785.00	110.2 PK			1.00 V	1	69.70	40.50
2	*5785.00	99.4 AV			1.00 V	1	58.90	40.50
3	11570.00	61.7 PK	74.0	-12.3	1.56 V	144	43.30	18.40
4	11570.00	48.4 AV	54.0	-5.6	1.56 V	144	30.00	18.40

REMARKS:

1. Emission Level(dBuV/m) = Raw Value(dBuV) + Correction Factor(dB/m)
2. Correction Factor(dB/m) = Antenna Factor(dB/m) + Cable Factor(dB)
– Pre-Amplifier Factor(dB)
3. The other emission levels were very low against the limit.
4. Margin value = Emission Level – Limit value
5. " * ": Fundamental frequency.



CHANNEL	TX Channel 165	DETECTOR FUNCTION	Peak (PK)
FREQUENCY RANGE	1GHz ~ 40GHz		Average (AV)

ANTENNA POLARITY & TEST DISTANCE: HORIZONTAL AT 3 M

NO.	FREQ. (MHz)	EMISSION LEVEL (dBuV/m)	LIMIT (dBuV/m)	MARGIN (dB)	ANTENNA HEIGHT (m)	TABLE ANGLE (Degree)	RAW VALUE (dBuV)	CORRECTION FACTOR (dB/m)
1	*5825.00	120.6 PK			2.04 H	334	80.10	40.50
2	*5825.00	109.8 AV			2.04 H	334	69.30	40.50
3	#5850.00	65.8 PK	78.2	-12.4	2.16 H	37	58.90	6.90
4	#5853.00	73.0 PK	78.2	-5.2	2.16 H	337	66.00	7.00
5	#5861.00	72.1 PK	74.0	-1.9	1.96 H	333	65.10	7.00
6	#5861.00	50.5 AV	54.0	-3.5	1.96 H	333	43.50	7.00
7	11650.00	62.8 PK	74.0	-11.2	2.00 H	150	43.90	18.90
8	11650.00	49.6 AV	54.0	-4.4	2.00 H	150	30.70	18.90

ANTENNA POLARITY & TEST DISTANCE: VERTICAL AT 3 M

NO.	FREQ. (MHz)	EMISSION LEVEL (dBuV/m)	LIMIT (dBuV/m)	MARGIN (dB)	ANTENNA HEIGHT (m)	TABLE ANGLE (Degree)	RAW VALUE (dBuV)	CORRECTION FACTOR (dB/m)
1	*5825.00	105.2 PK			1.27 V	334	64.70	40.50
2	*5825.00	94.8 AV			1.27 V	334	54.30	40.50
3	#5850.00	61.0 PK	78.2	-17.2	1.29 V	340	54.10	6.90
4	#5853.00	63.1 PK	78.2	-15.1	1.29 V	340	56.10	7.00
5	#5861.00	59.1 PK	74.0	-14.9	1.16 V	9	52.10	7.00
6	#5861.00	46.0 AV	54.0	-8.0	1.16 V	9	39.00	7.00
7	11650.00	61.2 PK	74.0	-12.8	1.00 V	19	42.30	18.90
8	11650.00	48.0 AV	54.0	-6.0	1.00 V	19	29.10	18.90

REMARKS:

- Emission Level(dBuV/m) = Raw Value(dBuV) + Correction Factor(dB/m)
- Correction Factor(dB/m) = Antenna Factor(dB/m) + Cable Factor(dB)
– Pre-Amplifier Factor(dB)
- The other emission levels were very low against the limit.
- Margin value = Emission Level – Limit value
- " * ": Fundamental frequency.
- " # ": The radiated frequency is out of the restricted band.

802.11n (HT40)

CHANNEL	TX Channel 38	DETECTOR FUNCTION	Peak (PK)
FREQUENCY RANGE	1GHz ~ 40GHz		Average (AV)

ANTENNA POLARITY & TEST DISTANCE: HORIZONTAL AT 3 M								
NO.	FREQ. (MHz)	EMISSION LEVEL (dBuV/m)	LIMIT (dBuV/m)	MARGIN (dB)	ANTENNA HEIGHT (m)	TABLE ANGLE (Degree)	RAW VALUE (dBuV)	CORRECTION FACTOR (dB/m)
1	5150.00	57.9 PK	74.0	-16.1	1.70 H	150	51.90	6.00
2	5150.00	46.0 AV	54.0	-8.0	1.70 H	150	40.00	6.00
3	*5190.00	95.7 PK			1.69 H	11	56.20	39.50
4	*5190.00	85.4 AV			1.69 H	11	45.90	39.50
5	#10380.00	59.5 PK	74.0	-14.5	1.14 H	332	41.00	18.50
6	#10380.00	46.5 AV	54.0	-7.5	1.14 H	332	28.00	18.50

ANTENNA POLARITY & TEST DISTANCE: VERTICAL AT 3 M								
NO.	FREQ. (MHz)	EMISSION LEVEL (dBuV/m)	LIMIT (dBuV/m)	MARGIN (dB)	ANTENNA HEIGHT (m)	TABLE ANGLE (Degree)	RAW VALUE (dBuV)	CORRECTION FACTOR (dB/m)
1	5150.00	66.1 PK	74.0	-7.9	1.75 V	251	60.10	6.00
2	5150.00	52.1 AV	54.0	-1.9	1.75 V	251	46.10	6.00
3	*5190.00	112.3 PK			1.74 V	191	72.80	39.50
4	*5190.00	101.6 AV			1.74 V	191	62.10	39.50
5	#10380.00	60.0 PK	74.0	-14.0	1.34 V	32	41.50	18.50
6	#10380.00	46.8 AV	54.0	-7.2	1.34 V	32	28.30	18.50

REMARKS:

1. Emission Level(dBuV/m) = Raw Value(dBuV) + Correction Factor(dB/m)
2. Correction Factor(dB/m) = Antenna Factor(dB/m) + Cable Factor(dB) – Pre-Amplifier Factor(dB)
3. The other emission levels were very low against the limit.
4. Margin value = Emission Level – Limit value
5. " * ": Fundamental frequency.
6. " # ": The radiated frequency is out of the restricted band.



CHANNEL	TX Channel 46	DETECTOR FUNCTION	Peak (PK)
FREQUENCY RANGE	1GHz ~ 40GHz		Average (AV)

ANTENNA POLARITY & TEST DISTANCE: HORIZONTAL AT 3 M

NO.	FREQ. (MHz)	EMISSION LEVEL (dBuV/m)	LIMIT (dBuV/m)	MARGIN (dB)	ANTENNA HEIGHT (m)	TABLE ANGLE (Degree)	RAW VALUE (dBuV)	CORRECTION FACTOR (dB/m)
1	5070.00	56.9 PK	74.0	-17.1	1.11 H	117	51.20	5.70
2	5070.00	46.1 AV	54.0	-7.9	1.11 H	117	40.40	5.70
3	*5230.00	103.5 PK			1.78 H	17	63.90	39.60
4	*5230.00	93.2 AV			1.78 H	17	53.60	39.60
5	#10460.00	60.8 PK	74.0	-13.2	1.58 H	326	41.90	18.90
6	#10460.00	47.5 AV	54.0	-6.5	1.58 H	326	28.60	18.90

ANTENNA POLARITY & TEST DISTANCE: VERTICAL AT 3 M

NO.	FREQ. (MHz)	EMISSION LEVEL (dBuV/m)	LIMIT (dBuV/m)	MARGIN (dB)	ANTENNA HEIGHT (m)	TABLE ANGLE (Degree)	RAW VALUE (dBuV)	CORRECTION FACTOR (dB/m)
1	5070.00	61.4 PK	74.0	-12.6	1.57 V	197	55.70	5.70
2	5070.00	49.2 AV	54.0	-4.8	1.57 V	197	43.50	5.70
3	*5230.00	120.9 PK			1.78 V	196	81.30	39.60
4	*5230.00	110.2 AV			1.78 V	196	70.60	39.60
5	#10460.00	61.8 PK	74.0	-12.2	1.38 V	226	42.90	18.90
6	#10460.00	48.5 AV	54.0	-5.5	1.38 V	226	29.60	18.90

REMARKS:

1. Emission Level(dBuV/m) = Raw Value(dBuV) + Correction Factor(dB/m)
2. Correction Factor(dB/m) = Antenna Factor(dB/m) + Cable Factor(dB) – Pre-Amplifier Factor(dB)
3. The other emission levels were very low against the limit.
4. Margin value = Emission Level – Limit value
5. " * ": Fundamental frequency.
6. " # ": The radiated frequency is out of the restricted band.



CHANNEL	TX Channel 151	DETECTOR FUNCTION	Peak (PK)
FREQUENCY RANGE	1GHz ~ 40GHz		Average (AV)

ANTENNA POLARITY & TEST DISTANCE: HORIZONTAL AT 3 M

NO.	FREQ. (MHz)	EMISSION LEVEL (dBuV/m)	LIMIT (dBuV/m)	MARGIN (dB)	ANTENNA HEIGHT (m)	TABLE ANGLE (Degree)	RAW VALUE (dBuV)	CORRECTION FACTOR (dB/m)
1	#5714.00	67.5 PK	74.0	-6.5	1.58 H	6	60.70	6.80
2	#5714.00	52.7 AV	54.0	-1.3	1.58 H	6	45.90	6.80
3	#5722.00	76.4 PK	78.2	-1.8	1.00 H	330	69.60	6.80
4	#5725.00	62.6 PK	78.2	-15.6	1.89 H	3	55.80	6.80
5	*5755.00	111.3 PK			1.00 H	337	70.80	40.50
6	*5755.00	102.5 AV			1.00 H	337	62.00	40.50
7	11510.00	59.1 PK	74.0	-14.9	1.08 H	243	40.80	18.30
8	11510.00	46.6 AV	54.0	-7.4	1.08 H	243	28.30	18.30

ANTENNA POLARITY & TEST DISTANCE: VERTICAL AT 3 M

NO.	FREQ. (MHz)	EMISSION LEVEL (dBuV/m)	LIMIT (dBuV/m)	MARGIN (dB)	ANTENNA HEIGHT (m)	TABLE ANGLE (Degree)	RAW VALUE (dBuV)	CORRECTION FACTOR (dB/m)
1	#5714.00	58.3 PK	74.0	-15.7	1.19 V	341	51.50	6.80
2	#5714.00	47.0 AV	54.0	-7.0	1.19 V	341	40.20	6.80
3	#5722.00	63.5 PK	78.2	-14.7	1.00 V	18	56.70	6.80
4	#5725.00	58.9 PK	78.2	-19.3	1.00 V	18	52.10	6.80
5	*5755.00	98.2 PK			1.00 V	19	57.70	40.50
6	*5755.00	88.2 AV			1.00 V	19	47.70	40.50
7	11510.00	60.4 PK	74.0	-13.6	1.30 V	145	42.10	18.30
8	11510.00	47.2 AV	54.0	-6.8	1.30 V	145	28.90	18.30

REMARKS:

1. Emission Level(dBuV/m) = Raw Value(dBuV) + Correction Factor(dB/m)
2. Correction Factor(dB/m) = Antenna Factor(dB/m) + Cable Factor(dB) – Pre-Amplifier Factor(dB)
3. The other emission levels were very low against the limit.
4. Margin value = Emission Level – Limit value
5. " * ": Fundamental frequency.
6. " # ": The radiated frequency is out of the restricted band.



CHANNEL	TX Channel 159	DETECTOR FUNCTION	Peak (PK)
FREQUENCY RANGE	1GHz ~ 40GHz		Average (AV)

ANTENNA POLARITY & TEST DISTANCE: HORIZONTAL AT 3 M

NO.	FREQ. (MHz)	EMISSION LEVEL (dBuV/m)	LIMIT (dBuV/m)	MARGIN (dB)	ANTENNA HEIGHT (m)	TABLE ANGLE (Degree)	RAW VALUE (dBuV)	CORRECTION FACTOR (dB/m)
1	*5795.00	116.3 PK			1.00 H	330	75.80	40.50
2	*5795.00	106.8 AV			1.00 H	330	66.30	40.50
3	#5850.00	59.9 PK	78.2	-18.3	1.56 H	330	53.00	6.90
4	#5852.00	63.9 PK	78.2	-14.3	1.56 H	330	56.90	7.00
5	#5861.00	72.1 PK	74.0	-1.9	1.46 H	9	65.10	7.00
6	#5861.00	50.8 AV	54.0	-3.2	1.46 H	9	43.80	7.00
7	11590.00	60.9 PK	74.0	-13.1	1.28 H	323	42.40	18.50
8	11590.00	48.0 AV	54.0	-6.0	1.28 H	323	29.50	18.50

ANTENNA POLARITY & TEST DISTANCE: VERTICAL AT 3 M

NO.	FREQ. (MHz)	EMISSION LEVEL (dBuV/m)	LIMIT (dBuV/m)	MARGIN (dB)	ANTENNA HEIGHT (m)	TABLE ANGLE (Degree)	RAW VALUE (dBuV)	CORRECTION FACTOR (dB/m)
1	*5795.00	104.3 PK			1.18 V	191	63.80	40.50
2	*5795.00	94.0 AV			1.18 V	191	53.50	40.50
3	#5850.00	61.4 PK	78.2	-16.8	1.18 V	191	54.50	6.90
4	#5853.00	57.7 PK	78.2	-20.5	1.18 V	191	50.70	7.00
5	#5861.00	57.7 PK	74.0	-16.3	1.22 V	333	50.70	7.00
6	#5861.00	46.7 AV	54.0	-7.3	1.22 V	333	39.70	7.00
7	11590.00	60.2 PK	74.0	-13.8	1.31 V	155	41.70	18.50
8	11590.00	47.2 AV	54.0	-6.8	1.31 V	155	28.70	18.50

REMARKS:

- Emission Level(dBuV/m) = Raw Value(dBuV) + Correction Factor(dB/m)
- Correction Factor(dB/m) = Antenna Factor(dB/m) + Cable Factor(dB)
– Pre-Amplifier Factor(dB)
- The other emission levels were very low against the limit.
- Margin value = Emission Level – Limit value
- " * ": Fundamental frequency.
- " # ": The radiated frequency is out of the restricted band.

802.11ac (VHT80)

CHANNEL	TX Channel 42	DETECTOR FUNCTION	Peak (PK)
FREQUENCY RANGE	1GHz ~ 40GHz		Average (AV)

ANTENNA POLARITY & TEST DISTANCE: HORIZONTAL AT 3 M								
NO.	FREQ. (MHz)	EMISSION LEVEL (dBuV/m)	LIMIT (dBuV/m)	MARGIN (dB)	ANTENNA HEIGHT (m)	TABLE ANGLE (Degree)	RAW VALUE (dBuV)	CORRECTION FACTOR (dB/m)
1	5150.00	56.4 PK	74.0	-17.6	1.51 H	343	50.40	6.00
2	5150.00	45.4 AV	54.0	-8.6	1.51 H	343	39.40	6.00
3	*5210.00	87.1 PK			1.24 H	160	47.50	39.60
4	*5210.00	77.9 AV			1.24 H	160	38.30	39.60
5	#10420.00	59.4 PK	74.0	-14.6	1.31 H	77	40.80	18.60
6	#10420.00	46.4 AV	54.0	-7.6	1.31 H	77	27.80	18.60

ANTENNA POLARITY & TEST DISTANCE: VERTICAL AT 3 M								
NO.	FREQ. (MHz)	EMISSION LEVEL (dBuV/m)	LIMIT (dBuV/m)	MARGIN (dB)	ANTENNA HEIGHT (m)	TABLE ANGLE (Degree)	RAW VALUE (dBuV)	CORRECTION FACTOR (dB/m)
1	5150.00	68.0 PK	74.0	-6.0	2.01 V	24	62.00	6.00
2	5150.00	52.9 AV	54.0	-1.1	2.01 V	24	46.90	6.00
3	*5210.00	102.1 PK			2.00 V	0	62.50	39.60
4	*5210.00	92.3 AV			2.00 V	0	52.70	39.60
5	#10420.00	59.8 PK	74.0	-14.2	1.01 V	176	41.20	18.60
6	#10420.00	46.6 AV	54.0	-7.4	1.01 V	176	28.00	18.60

REMARKS:

1. Emission Level(dBuV/m) = Raw Value(dBuV) + Correction Factor(dB/m)
2. Correction Factor(dB/m) = Antenna Factor(dB/m) + Cable Factor(dB) – Pre-Amplifier Factor(dB)
3. The other emission levels were very low against the limit.
4. Margin value = Emission Level – Limit value
5. " * ": Fundamental frequency.
6. " # ": The radiated frequency is out of the restricted band.

CHANNEL	TX Channel 155	DETECTOR FUNCTION	Peak (PK)
FREQUENCY RANGE	1GHz ~ 40GHz		Average (AV)

ANTENNA POLARITY & TEST DISTANCE: HORIZONTAL AT 3 M

NO.	FREQ. (MHz)	EMISSION LEVEL (dBuV/m)	LIMIT (dBuV/m)	MARGIN (dB)	ANTENNA HEIGHT (m)	TABLE ANGLE (Degree)	RAW VALUE (dBuV)	CORRECTION FACTOR (dB/m)
1	#5714.00	66.5 PK	74.0	-7.5	1.53 H	338	59.70	6.80
2	#5714.00	52.8 AV	54.0	-1.2	1.53 H	338	46.00	6.80
3	#5722.00	74.5 PK	78.2	-3.7	2.32 H	334	67.70	6.80
4	#5725.00	59.9 PK	78.2	-18.3	2.30 H	333	53.10	6.80
5	*5775.00	100.7 PK			1.21 H	334	60.20	40.50
6	*5775.00	91.3 AV			1.21 H	334	50.80	40.50
7	11550.00	59.7 PK	74.0	-14.3	1.10 H	267	41.30	18.40
8	11550.00	46.9 AV	54.0	-7.1	1.10 H	267	28.50	18.40

ANTENNA POLARITY & TEST DISTANCE: VERTICAL AT 3 M

NO.	FREQ. (MHz)	EMISSION LEVEL (dBuV/m)	LIMIT (dBuV/m)	MARGIN (dB)	ANTENNA HEIGHT (m)	TABLE ANGLE (Degree)	RAW VALUE (dBuV)	CORRECTION FACTOR (dB/m)
1	#5714.00	57.1 PK	74.0	-16.9	1.30 V	191	50.30	6.80
2	#5714.00	45.8 AV	54.0	-8.2	1.30 V	191	39.00	6.80
3	#5722.00	61.5 PK	78.2	-16.7	1.40 V	202	54.70	6.80
4	#5725.00	57.8 PK	78.2	-20.4	1.40 V	202	51.00	6.80
5	*5775.00	86.6 PK			1.30 V	191	46.10	40.50
6	*5775.00	76.0 AV			1.30 V	191	35.50	40.50
7	11550.00	59.4 PK	74.0	-14.6	1.23 V	165	41.00	18.40
8	11550.00	46.5 AV	54.0	-7.5	1.23 V	165	28.10	18.40

REMARKS:

- Emission Level(dBuV/m) = Raw Value(dBuV) + Correction Factor(dB/m)
- Correction Factor(dB/m) = Antenna Factor(dB/m) + Cable Factor(dB)
– Pre-Amplifier Factor(dB)
- The other emission levels were very low against the limit.
- Margin value = Emission Level – Limit value
- " * ": Fundamental frequency.
- " # ": The radiated frequency is out of the restricted band.

Below 1GHz Worst-Case Data:
802.11a

CHANNEL	TX Channel 157	DETECTOR FUNCTION	Quasi-Peak (QP)
FREQUENCY RANGE	30MHz ~ 1GHz		

ANTENNA POLARITY & TEST DISTANCE: HORIZONTAL AT 3 M

NO.	FREQ. (MHz)	EMISSION LEVEL (dBuV/m)	LIMIT (dBuV/m)	MARGIN (dB)	ANTENNA HEIGHT (m)	TABLE ANGLE (Degree)	RAW VALUE (dBuV)	CORRECTION FACTOR (dB/m)
1	29.90	30.3 QP	40.0	-9.7	1.00 H	93	46.00	-15.70
2	37.68	32.2 QP	40.0	-7.8	2.00 H	70	47.50	-15.30
3	113.50	28.7 QP	43.5	-14.8	1.47 H	148	45.80	-17.10
4	160.17	30.4 QP	43.5	-13.1	1.49 H	137	44.30	-13.90
5	311.82	27.0 QP	46.0	-19.0	1.00 H	119	39.30	-12.30
6	333.21	26.9 QP	46.0	-19.1	1.00 H	45	38.60	-11.70

ANTENNA POLARITY & TEST DISTANCE: VERTICAL AT 3 M

NO.	FREQ. (MHz)	EMISSION LEVEL (dBuV/m)	LIMIT (dBuV/m)	MARGIN (dB)	ANTENNA HEIGHT (m)	TABLE ANGLE (Degree)	RAW VALUE (dBuV)	CORRECTION FACTOR (dB/m)
1	38.00	38.0 QP	40.0	-2.0	1.00 V	176	53.30	-15.30
2	62.95	38.0 QP	40.0	-2.0	1.00 V	353	53.20	-15.20
3	113.50	30.6 QP	43.5	-12.9	1.00 V	209	47.70	-17.10
4	138.78	28.7 QP	43.5	-14.8	1.00 V	152	43.50	-14.80
5	169.89	26.8 QP	43.5	-16.7	1.00 V	145	41.00	-14.20
6	249.60	23.7 QP	46.0	-22.3	1.00 V	273	38.10	-14.40

REMARKS:

1. Emission Level(dBuV/m) = Raw Value(dBuV) + Correction Factor(dB/m)
2. Correction Factor(dB/m) = Antenna Factor(dB/m) + Cable Factor(dB)
– Pre-Amplifier Factor(dB)
3. The other emission levels were very low against the limit.
4. Margin value = Emission Level – Limit value

4.2 Conducted Emission Measurement

4.2.1 Limits of Conducted Emission Measurement

Frequency (MHz)	Conducted Limit (dBuV)	
	Quasi-peak	Average
0.15 - 0.5	66 - 56	56 - 46
0.50 - 5.0	56	46
5.0 - 30.0	60	50

Note: 1. The lower limit shall apply at the transition frequencies.

2. The limit decreases in line with the logarithm of the frequency in the range of 0.15 to 0.50MHz.

4.2.2 Test Instruments

Description & Manufacturer	Model No.	Serial No.	Date of Calibration	Due Date of Calibration
Test Receiver ROHDE & SCHWARZ	ESCS30	100288	Apr. 27, 2015	Apr. 26, 2016
RF signal cable Woken	5D-FB	Cable-HYCO2-01	Dec. 26, 2014	Dec. 25, 2015
LISN ROHDE & SCHWARZ (EUT)	ESH2-Z5	100100	Dec. 30, 2014	Dec. 29, 2015
LISN ROHDE & SCHWARZ (Peripheral)	ESH3-Z5	100312	Jul. 10, 2014	Jul. 09, 2015
Software ADT	BV ADT_Cond_ V7.3.7.3	NA	NA	NA

NOTE: 1. The calibration interval of the above test instruments is 12 months and the calibrations are traceable to NML/ROC and NIST/USA.

2. The test was performed in HwaYa Shielded Room 2.

3. The VCCI Site Registration No. is C-2047.

4.2.3 Test Procedure

- a. The EUT was placed 0.4 meters from the conducting wall of the shielded room with EUT being connected to the power mains through a line impedance stabilization network (LISN). Other support units were connected to the power mains through another LISN. The two LISNs provide 50 ohm/ 50uH of coupling impedance for the measuring instrument.
- b. Both lines of the power mains connected to the EUT were checked for maximum conducted interference.
- c. The frequency range from 150kHz to 30MHz was searched. Emission levels under (Limit - 20dB) was not recorded.

NOTE: The resolution bandwidth and video bandwidth of test receiver is 9kHz for quasi-peak detection (QP) and average detection (AV) at frequency 0.15MHz-30MHz.

4.2.4 Deviation from Test Standard

No deviation.

4.2.5 Test Setup

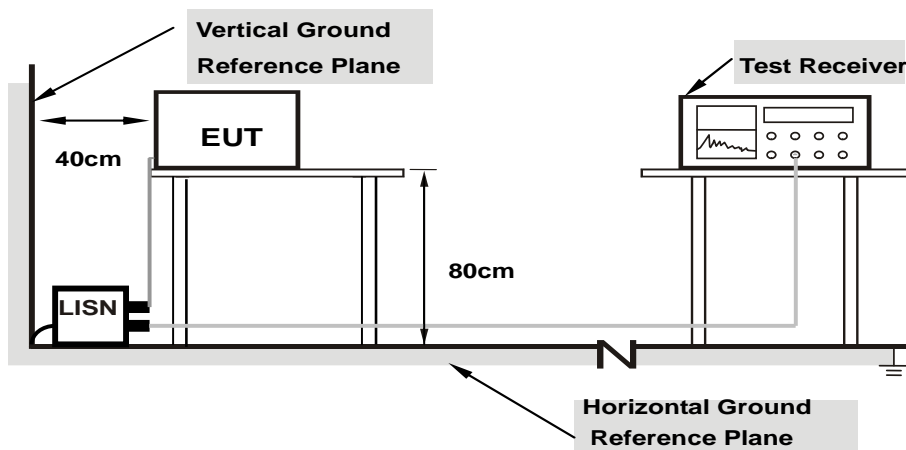

- Note:**
- 1.Support units were connected to second LISN.
 - 2.Both of LISNs (AMN) are 80 cm from EUT and at least 80 from other units and other metal planes

For the actual test configuration, please refer to the attached file (Test Setup Photo).

4.2.6 EUT Operating Conditions

Same as 4.1.6.

4.2.7 Test Results

Phase	Line (L)	Detector Function	Quasi-Peak (QP) / Average (AV)
-------	----------	-------------------	--------------------------------

No	Freq. [MHz]	Corr. Factor (dB)	Reading Value [dB (uV)]		Emission Level [dB (uV)]		Limit [dB (uV)]		Margin (dB)	
			Q.P.	AV.	Q.P.	AV.	Q.P.	AV.	Q.P.	AV.
			1	0.15000	0.16	51.48	22.12	51.64	22.28	66.00
2	0.18125	0.17	50.97	42.41	51.14	42.58	64.43	54.43	-13.29	-11.85
3	0.67734	0.20	30.94	30.57	31.14	30.77	56.00	46.00	-24.86	-15.23
4	0.94688	0.23	30.20	30.16	30.43	30.39	56.00	46.00	-25.57	-15.61
5	2.25781	0.28	31.14	27.47	31.42	27.75	56.00	46.00	-24.58	-18.25
6	18.22230	0.59	39.57	36.83	40.16	37.42	60.00	50.00	-19.84	-12.58

REMARKS:

1. Q.P. and AV. are abbreviations of quasi-peak and average individually.
2. The emission levels of other frequencies were very low against the limit.
3. Margin value = Emission level - Limit value
4. Correction factor = Insertion loss + Cable loss
5. Emission Level = Correction Factor + Reading Value.

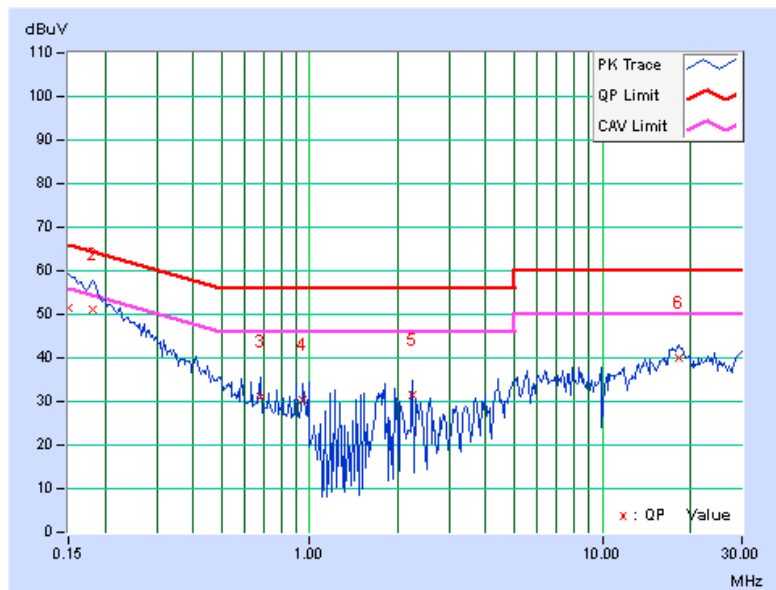

Phase	Neutral (N)	Detector Function	Quasi-Peak (QP) / Average (AV)
-------	-------------	-------------------	--------------------------------

No	Freq. [MHz]	Corr. Factor (dB)	Reading Value		Emission Level		Limit		Margin	
			[dB (uV)]		[dB (uV)]		[dB (uV)]		(dB)	
			Q.P.	AV.	Q.P.	AV.	Q.P.	AV.	Q.P.	AV.
1	0.15000	0.17	51.52	22.34	51.69	22.51	66.00	56.00	-14.31	-33.49
2	0.17734	0.18	48.91	38.55	49.09	38.73	64.61	54.61	-15.52	-15.88
3	0.22900	0.18	43.22	33.44	43.40	33.62	62.49	52.49	-19.08	-18.86
4	0.26719	0.19	39.31	25.80	39.50	25.99	61.20	51.20	-21.71	-25.22
5	0.95078	0.24	22.88	20.65	23.12	20.89	56.00	46.00	-32.88	-25.11
6	6.24870	0.44	40.24	38.02	40.68	38.46	60.00	50.00	-19.32	-11.54

REMARKS:

1. Q.P. and AV. are abbreviations of quasi-peak and average individually.
2. The emission levels of other frequencies were very low against the limit.
3. Margin value = Emission level - Limit value
4. Correction factor = Insertion loss + Cable loss
5. Emission Level = Correction Factor + Reading Value.

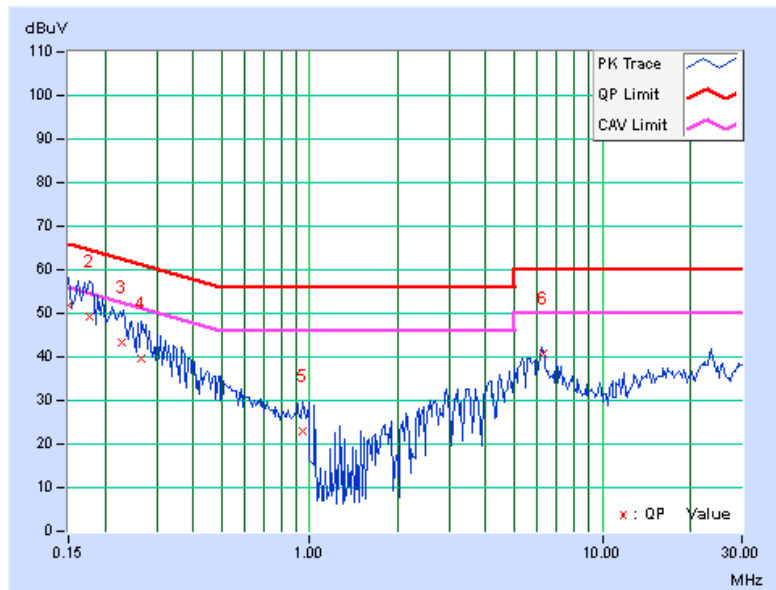

4.3 Transmit Power Measurement

4.3.1 Limits of Transmit Power Measurement

Operation Band	EUT Category		LIMIT
U-NII-1	√	Outdoor Access Point	1 Watt (30 dBm) (Max. e.i.r.p \leq 125mW(21 dBm) at any elevation angle above 30 degrees as measured from the horizon)
		Fixed point-to-point Access Point	1 Watt (30 dBm)
		Indoor Access Point	1 Watt (30 dBm)
		Mobile and Portable client device	250mW (24 dBm)
U-NII-2A	---		250mW (24 dBm) or 11 dBm+10 log B*
U-NII-2C	---		250mW (24 dBm) or 11 dBm+10 log B*
U-NII-3	√		1 Watt (30 dBm)

*B is the 26 dB emission bandwidth in megahertz

Per KDB 662911 Method of conducted output power measurement on IEEE 802.11 devices,

Array Gain = 0 dB (i.e., no array gain) for $N_{ANT} \leq 4$;

Array Gain = 0 dB (i.e., no array gain) for channel widths ≥ 40 MHz for any N_{ANT} ;

Array Gain = $5 \log(N_{ANT}/N_{SS})$ dB or 3 dB, whichever is less for 20-MHz channel widths with $N_{ANT} \geq 5$.

For power measurements on all other devices: Array Gain = $10 \log(N_{ANT}/N_{SS})$ dB.

4.3.2 Test Setup

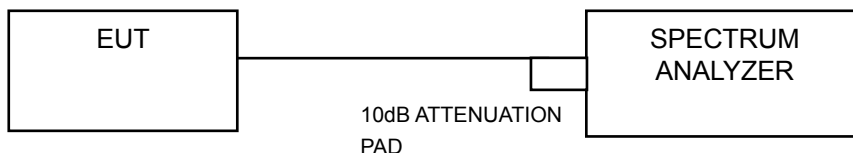
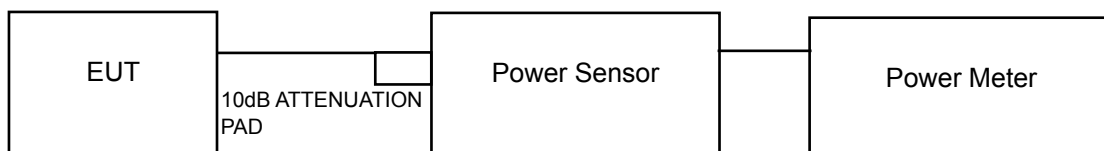

4.3.3 Test Instruments

Refer to section 4.1.2 to get information of above instrument.

4.3.4 Test Procedure

FOR AVERAGE POWER MEASUREMENT

For 802.11a, 802.11n (HT20), 802.11n (HT40)

Method PM is used to perform output power measurement, trigger and gating function of wide band power meter is enabled to measure max output power of TX on burst. Duty factor is not added to measured value.

For 802.11ac (VHT80)

- 1) Set span to encompass the entire 26 dB EBW (or, alternatively, the entire 99% occupied bandwidth) of the signal.
- 2) Set sweep trigger to "free run".
- 3) Set RBW = 1 MHz.
- 4) Set VBW \geq 3 MHz
- 5) Number of points in sweep \geq 2 Span / RBW.
- 6) Sweep time \leq (number of points in sweep) * T
- 7) Using emission bandwidth to determine the frequency span for integration the channel bandwidth.
- 8) Detector = RMS.
- 9) Trace mode = max hold.
- 10) Allow max hold to run for at least 60 seconds, or longer as needed to allow the trace to stabilize.

FOR OCCUPIED BANDWIDTH

The transmitter output was connected to the spectrum analyzer through an attenuator. The bandwidth of the fundamental frequency was measured by spectrum analyzer with 300 kHz RBW and 1MHz VBW. The width of a frequency band such that, below the lower and above the upper frequency limits, the mean powers emitted are each equal to a specified percentage 0.5 % of the total mean power of a given emission.

4.3.5 Deviation from Test Standard

No deviation.

4.3.6 EUT Operating Conditions

The software provided by client to enable the EUT under transmission Condition continuously at lowest, middle and highest channel frequencies individually.

4.3.7 Test Result

Conducted Power:

For U-NII-1 Band (Outdoor Access Point)

802.11a

Chan.	Freq. (MHz)	Conducted Power (dBm)			Total Power (mW)	Total Power (dBm)	Power Limit (dBm)	Pass / Fail
		Chain 0	Chain 1	Chain 2				
36	5180	16.04	16.67	16.02	126.625	21.03	30	PASS
40	5200	18.46	17.54	18.62	199.678	23.00	30	PASS
48	5240	18.51	18.26	18.56	209.725	23.22	30	PASS

Note:

Gain = 5.06 < 6dBi, so the conducted power limit is not reduced.

802.11n (HT20)

Chan.	Freq. (MHz)	Conducted Power (dBm)			Total Power (mW)	Total Power (dBm)	Power Limit (dBm)	Pass / Fail
		Chain 0	Chain 1	Chain 2				
36	5180	16.73	16.19	16.15	129.899	21.14	30	PASS
40	5200	18.47	17.77	18.12	195.011	22.90	30	PASS
48	5240	18.41	18.21	18.43	205.228	23.12	30	PASS

Note:

Gain = 5.06 < 6dBi, so the conducted power limit is not reduced.

802.11n (HT40)

Chan.	Freq. (MHz)	Conducted Power (dBm)			Total Power (mW)	Total Power (dBm)	Power Limit (dBm)	Pass / Fail
		Chain 0	Chain 1	Chain 2				
38	5190	11.83	11.16	12.01	44.188	16.45	30	PASS
46	5230	18.88	17.94	18.90	217.123	23.37	30	PASS

Note:

Gain = 5.06 < 6dBi, so the conducted power limit is not reduced.

802.11ac (VHT80)

Chan.	Freq. (MHz)	Conducted Power (dBm)			Total Power (mW)	Total Power (dBm)	Power Limit (dBm)	Pass / Fail
		Chain 0	Chain 1	Chain 2				
42	5210	5.10	4.57	5.39	9.559	9.80	30	PASS

Note:

Gain = 5.06 < 6dBi, so the conducted power limit is not reduced.

Max. e.i.r.p at any elevation angle above 30 degrees:
For U-NII-1 Band (Outdoor Access Point)
802.11a

Chan.	Freq. (MHz)	Conducted Power (mW)	Conducted Power (dBm)	Max Antenna Gain above 30 degrees from the horizon (dBi)	EIRP (dBm)	EIRP limit (dBm)	Pass / Fail
36	5180	126.625	21.03	-2.49	18.54	21	PASS
40	5200	199.678	23.00	-2.49	20.51	21	PASS
48	5240	209.725	23.22	-2.49	20.73	21	PASS

Note:

Gain = -2.49dBi (-2.49dBi is the max gain for the EUT above 30 degrees from the horizon),
 EIRP = conducted power + antenna gain (-2.49dBi) + array gain = 0 dB (i.e., no array gain) for $N_{ANT} \leq 4$.

802.11n (HT20)

Chan.	Freq. (MHz)	Conducted Power (mW)	Conducted Power (dBm)	Max Antenna Gain above 30 degrees from the horizon (dBi)	EIRP (dBm)	EIRP limit (dBm)	Pass / Fail
36	5180	129.899	21.14	-2.49	18.65	21	PASS
40	5200	195.011	22.90	-2.49	20.41	21	PASS
48	5240	205.228	23.12	-2.49	20.63	21	PASS

Note:

Gain = -2.49dBi (-2.49dBi is the max gain for the EUT above 30 degrees from the horizon),
 EIRP = conducted power + antenna gain (-2.49dBi) + array gain = 0 dB (i.e., no array gain) for $N_{ANT} \leq 4$.

802.11n (HT40)

Chan.	Freq. (MHz)	Conducted Power (mW)	Conducted Power (dBm)	Max Antenna Gain above 30 degrees from the horizon (dBi)	EIRP (dBm)	EIRP limit (dBm)	Pass / Fail
38	5190	44.188	16.45	-2.49	13.96	21	PASS
46	5230	217.123	23.37	-2.49	20.88	21	PASS

Note:

Gain = -2.49dBi (-2.49dBi is the max gain for the EUT above 30 degrees from the horizon),
 EIRP = conducted power + antenna gain (-2.49dBi) + array gain = 0 dB (i.e., no array gain) for $N_{ANT} \leq 4$.

802.11ac (VHT80)

Chan.	Freq. (MHz)	Conducted Power (mW)	Conducted Power (dBm)	Max Antenna Gain above 30 degrees from the horizon (dBi)	EIRP (dBm)	EIRP limit (dBm)	Pass / Fail
42	5210	9.559	9.80	-2.49	7.31	21	PASS

Note:

Gain = -2.49dBi (-2.49dBi is the max gain for the EUT above 30 degrees from the horizon),
 EIRP = conducted power + antenna gain (-2.49dBi) + array gain = 0 dB (i.e., no array gain) for $N_{ANT} \leq 4$.

**For U-NII-3 Band
802.11a**

Channel	Channel Frequency (MHz)	Maximum Conducted Power (dBm)			Total Power (mW)	Total Power (dBm)	Power Limit (dBm)	Pass / Fail
		Chain 0	Chain 1	Chain 2				
149	5745	16.34	17.91	17.68	163.469	22.13	30	PASS
157	5785	22.96	23.24	22.60	590.530	27.71	30	PASS
165	5825	18.52	19.39	19.29	242.935	23.85	30	PASS

802.11n (HT20)

Channel	Channel Frequency (MHz)	Maximum Conducted Power (dBm)			Total Power (mW)	Total Power (dBm)	Power Limit (dBm)	Pass / Fail
		Chain 0	Chain 1	Chain 2				
149	5745	16.55	17.59	17.90	164.258	22.16	30	PASS
157	5785	22.41	23.18	22.61	564.541	27.52	30	PASS
165	5825	18.67	18.86	19.11	232.004	23.65	30	PASS

802.11n (HT40)

Channel	Channel Frequency (MHz)	Maximum Conducted Power (dBm)			Total Power (mW)	Total Power (dBm)	Power Limit (dBm)	Pass / Fail
		Chain 0	Chain 1	Chain 2				
151	5755	14.27	15.69	15.60	100.106	20.00	30	PASS
159	5795	19.02	20.05	19.74	275.146	24.40	30	PASS

802.11ac (VHT80)

Channel	Channel Frequency (MHz)	Maximum Conducted Power (dBm)			Total Power (mW)	Total Power (dBm)	Power Limit (dBm)	Pass / Fail
		Chain 0	Chain 1	Chain 2				
155	5775	4.81	6.14	5.45	10.646	10.27	30	PASS

26dB BANDWIDTH:
802.11a

Channel	Channel Frequency (MHz)	26dBc Bandwidth (MHz)			Pass / Fail
		Chain 0	Chain 1	Chain 2	
36	5180	23.86	23.85	24.76	Pass
40	5200	24.59	24.81	24.76	Pass
48	5240	23.96	24.50	24.08	Pass

802.11n (HT20)

Channel	Channel Frequency (MHz)	26dBc Bandwidth (MHz)			Pass / Fail
		Chain 0	Chain 1	Chain 2	
36	5180	24.99	23.65	24.88	Pass
40	5200	25.49	25.81	25.04	Pass
48	5240	23.54	23.73	25.82	Pass

802.11n (HT40)

Channel	Channel Frequency (MHz)	26dBc Bandwidth (MHz)			Pass / Fail
		Chain 0	Chain 1	Chain 2	
38	5190	49.01	48.99	47.42	Pass
46	5230	47.17	48.15	48.83	Pass

802.11ac (VHT80)

Channel	Channel Frequency (MHz)	26dBc Bandwidth (MHz)			Pass / Fail
		Chain 0	Chain 1	Chain 2	
42	5210	94.30	96.56	94.15	Pass

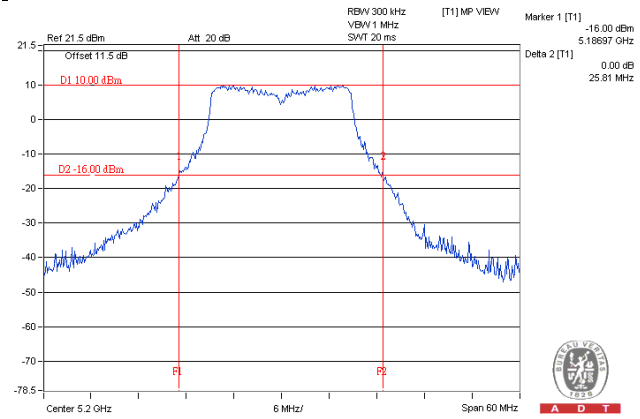
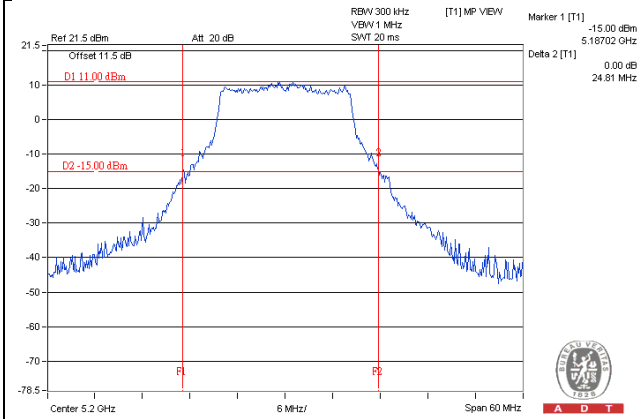
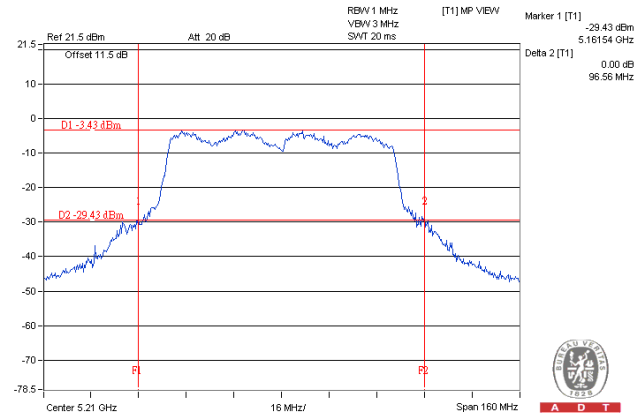
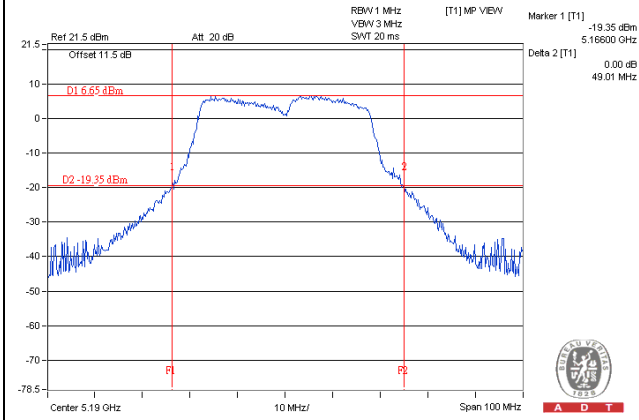
SPECTRUM PLOT OF WORST VALUE**802.11a****802.11n (HT20)****802.11n (HT40)****802.11ac (VHT80)**

Occupied Bandwidth:
802.11a

Channel	Channel Frequency (MHz)	Occupied Bandwidth (MHz)			Pass / Fail
		Chain 0	Chain 1	Chain 2	
36	5180	17.04	16.80	16.92	Pass
40	5200	17.04	17.16	16.92	Pass
48	5240	16.92	16.92	16.80	Pass
149	5745	16.92	16.92	16.80	Pass
157	5785	20.52	21.48	21.12	Pass
165	5825	16.80	16.92	16.80	Pass

802.11n (HT20)

Channel	Channel Frequency (MHz)	Occupied Bandwidth (MHz)			Pass / Fail
		Chain 0	Chain 1	Chain 2	
36	5180	18.12	17.88	17.88	Pass
40	5200	18.24	18.24	18.00	Pass
48	5240	17.76	17.88	18.24	Pass
149	5745	18.12	17.88	18.00	Pass
157	5785	21.12	21.00	21.96	Pass
165	5825	17.88	18.00	18.00	Pass

802.11n (HT40)

Channel	Channel Frequency (MHz)	Occupied Bandwidth (MHz)			Pass / Fail
		Chain 0	Chain 1	Chain 2	
38	5190	36.72	37.20	36.96	Pass
46	5230	36.84	36.96	36.84	Pass
151	5755	36.96	36.84	36.84	Pass
159	5795	36.60	36.96	36.96	Pass

802.11ac (VHT80)

Channel	Channel Frequency (MHz)	Occupied Bandwidth (MHz)			Pass / Fail
		Chain 0	Chain 1	Chain 2	
42	5210	76.08	76.32	76.08	Pass
155	5775	75.84	75.84	76.08	Pass



A D T

SPECTRUM PLOT OF WORST VALUE

802.11a

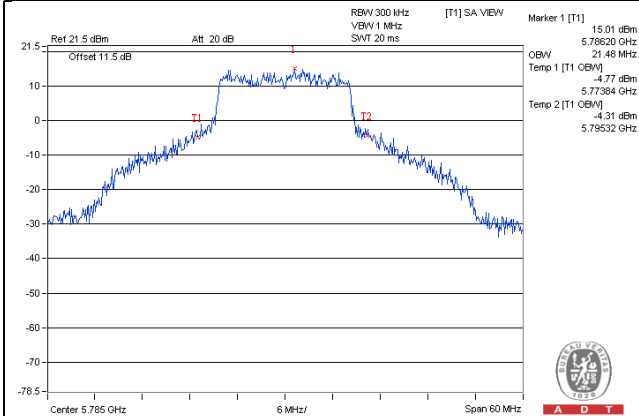

802.11n (HT20)

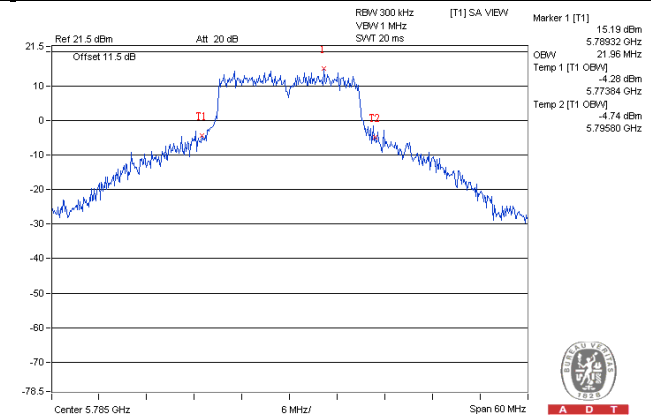

802.11n (HT40)

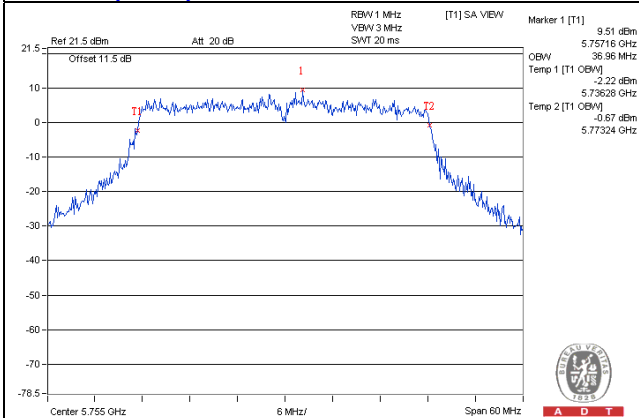

802.11ac (VHT80)

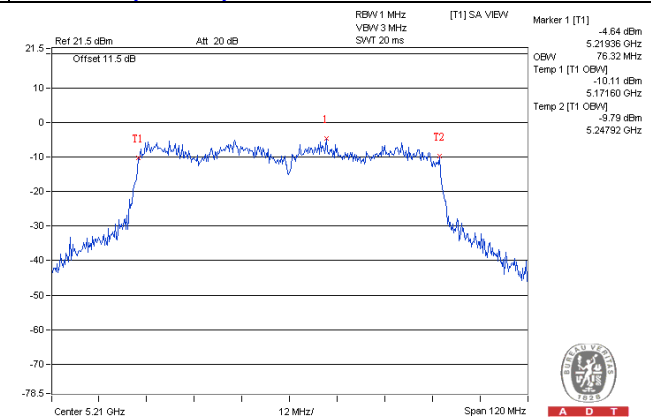

4.4 Peak Power Spectral Density Measurement

4.4.1 Limits of Peak Power Spectral Density Measurement

Operation Band	EUT Category		LIMIT
U-NII-1	√	Outdoor Access Point	17dBm/ MHz
		Fixed point-to-point Access Point	
		Indoor Access Point	
		Mobile and Portable client device	11dBm/ MHz
U-NII-2A	---		11dBm/ MHz
U-NII-2C	---		11dBm/ MHz
U-NII-3	√		30dBm/ 500kHz

4.4.2 Test Setup

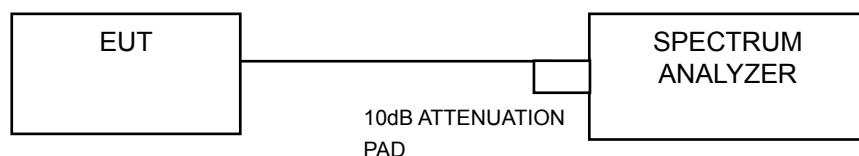

4.4.3 Test Instruments

Refer to section 4.1.2 to get information of above instrument.

4.4.4 Test Procedure

For U-NII-1 band:

Using method SA-2 alternative

- 1) Set span to encompass the entire emission bandwidth (EBW) of the signal.
- 2) Set RBW = 30 kHz, Set VBW ≥ 1 MHz, Detector = RMS
- 3) Set Channel power measure = 1MHz
- 4) Sweep time = 20ms.
- 5) Perform a single sweep.
- 6) Record the max value and add 10 log (1/duty cycle)

For U-NII-3 band:

1. Set span to encompass the entire emission bandwidth (EBW) of the signal.
2. Set RBW = 300 kHz, Set VBW ≥ 1 MHz, Detector = RMS
3. Use the peak marker function to determine the maximum power level in any 300 kHz band segment within the fundamental EBW.
4. Scale the observed power level to an equivalent value in 500 kHz by adjusting (reducing) the measured power by a bandwidth correction factor (BWCF) where $BWCF = 10\log(500\text{ kHz}/300\text{ kHz})$
5. Sweep time = auto, trigger set to "free run".
6. Trace average at least 100 traces in power averaging mode.
7. Record the max value and add 10 log (1/duty cycle)

4.4.5 Deviation from Test Standard

No deviation.

4.4.6 EUT Operating Condition

Same as Item 4.3.6.

4.4.7 Test Results

For U-NII-1 Band

802.11a

Chan.	Freq. (MHz)	PSD (dBm)			Total PSD w/o duty factor (dBm)	Duty factor	Total PSD with duty factor (dBm)	Max. Limit (dBm)	Pass / Fail
		Chain 0	Chain 1	Chain 2					
36	5180	4.28	3.75	4.24	8.86	0.37	9.23	13.17	Pass
40	5200	6.65	5.58	6.97	11.21	0.37	11.58	13.17	Pass
48	5240	6.97	6.74	7.41	11.82	0.37	12.19	13.17	Pass

NOTE:

- Method 1 of power density measurement of KDB 662911 is using for calculating total power density. Total power density is summing entire spectra across corresponding frequency bins on the various outputs by computer.
- Directional gain = $5.06\text{dBi} + 10\log(3) = 9.83\text{dBi} > 6\text{dBi}$, so the power density limit shall be reduced to $17 - (9.83 - 6) = 13.17\text{dBm}$.
- Refer to section 3.3 for duty cycle spectrum plot.

802.11n (HT20)

Chan.	Freq. (MHz)	PSD (dBm)			Total PSD w/o duty factor (dBm)	Duty factor	Total PSD with duty factor (dBm)	Max. Limit (dBm)	Pass / Fail
		Chain 0	Chain 1	Chain 2					
36	5180	4.04	3.54	3.99	8.63	0.26	8.89	13.17	Pass
40	5200	6.08	4.92	6.62	10.70	0.26	10.96	13.17	Pass
48	5240	6.78	6.35	7.30	11.60	0.26	11.86	13.17	Pass

NOTE:

- Method 1 of power density measurement of KDB 662911 is using for calculating total power density. Total power density is summing entire spectra across corresponding frequency bins on the various outputs by computer.
- Directional gain = $5.06\text{dBi} + 10\log(3) = 9.83\text{dBi} > 6\text{dBi}$, so the power density limit shall be reduced to $17 - (9.83 - 6) = 13.17\text{dBm}$.
- Refer to section 3.3 for duty cycle spectrum plot.

802.11n (HT40)

Chan.	Freq. (MHz)	PSD (dBm)			Total PSD w/o duty factor (dBm)	Duty factor	Total PSD with duty factor (dBm)	Max. Limit (dBm)	Pass / Fail
		Chain 0	Chain 1	Chain 2					
38	5190	-4.79	-5.77	-4.74	-0.31	0.74	0.43	13.17	Pass
46	5230	3.31	3.12	3.16	7.97	0.74	8.71	13.17	Pass

NOTE:

- Method 1 of power density measurement of KDB 662911 is using for calculating total power density. Total power density is summing entire spectra across corresponding frequency bins on the various outputs by computer.
- Directional gain = $5.06\text{dBi} + 10\log(3) = 9.83\text{dBi} > 6\text{dBi}$, so the power density limit shall be reduced to $17 - (9.83 - 6) = 13.17\text{dBm}$.
- Refer to section 3.3 for duty cycle spectrum plot.

802.11ac (VHT80)

Chan.	Freq. (MHz)	PSD (dBm)			Total PSD w/o duty factor (dBm)	Duty factor	Total PSD with duty factor (dBm)	Max. Limit (dBm)	Pass / Fail
		Chain 0	Chain 1	Chain 2					
42	5210	-15.31	-15.13	-15.18	-10.43	1.21	-9.22	13.17	Pass

NOTE:

- Method 1 of power density measurement of KDB 662911 is using for calculating total power density. Total power density is summing entire spectra across corresponding frequency bins on the various outputs by computer.
- Directional gain = $5.06\text{dBi} + 10\log(3) = 9.83\text{dBi} > 6\text{dBi}$, so the power density limit shall be reduced to $17 - (9.83 - 6) = 13.17\text{dBm}$.
- Refer to section 3.3 for duty cycle spectrum plot.

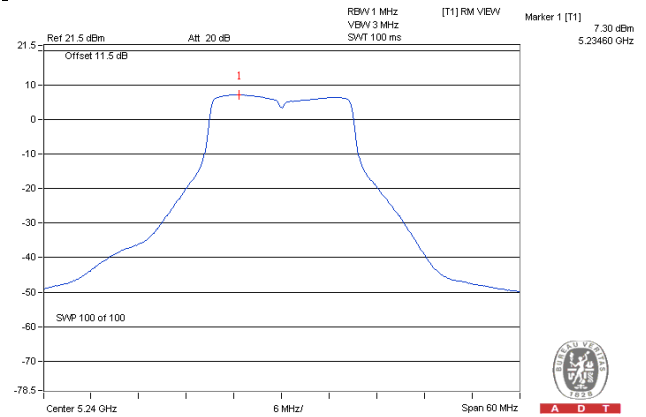
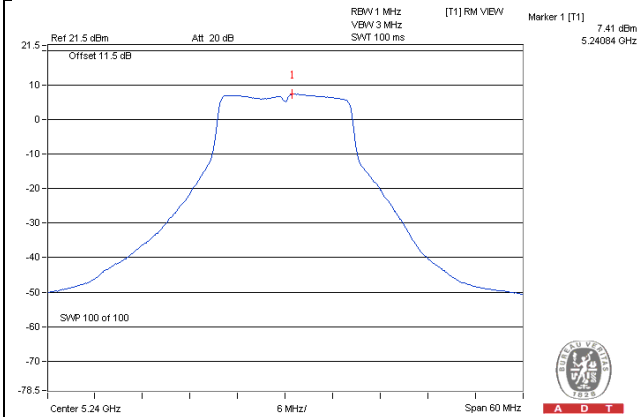
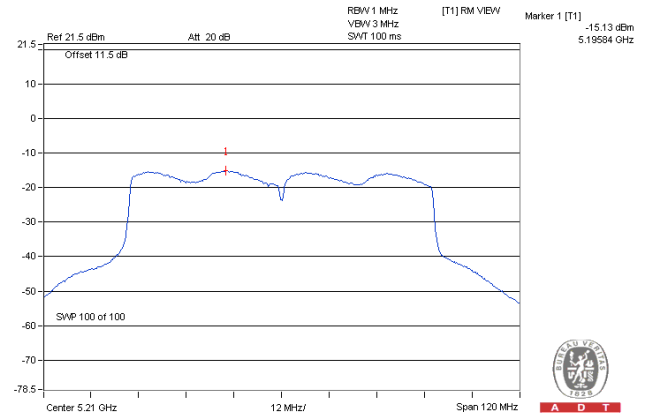
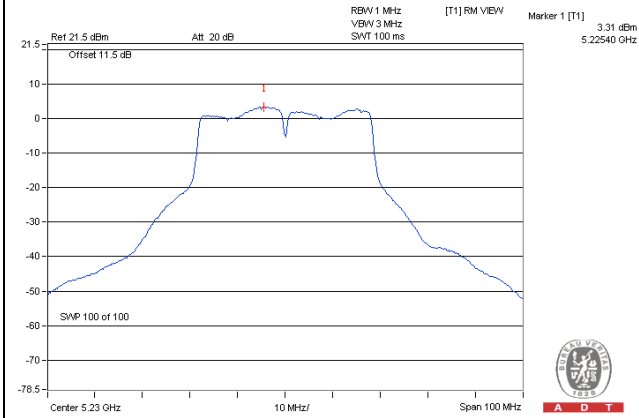
SPECTRUM PLOT OF WORST VALUE**802.11a****802.11n (HT20)****802.11n (HT40)****802.11ac (VHT80)**

For U-NII-3 Band

802.11a

TX chain	Channel	Freq. (MHz)	PSD (dBm/300kHz)	PSD (dBm/500kHz)	10 log (N=3) dB	Duty factor	Total PSD (dBm/500kHz)	Limit (dBm/500kHz)	Pass /Fail
0	149	5745	-2.53	-0.31	4.77	0.37	4.83	25.36	Pass
	157	5785	2.75	4.97	4.77	0.37	10.11	25.36	Pass
	165	5825	-0.75	1.47	4.77	0.37	6.61	25.36	Pass
1	149	5745	-0.89	1.33	4.77	0.37	6.47	25.36	Pass
	157	5785	2.92	5.14	4.77	0.37	10.28	25.36	Pass
	165	5825	-0.15	2.07	4.77	0.37	7.21	25.36	Pass
2	149	5745	-0.85	1.37	4.77	0.37	6.51	25.36	Pass
	157	5785	2.22	4.44	4.77	0.37	9.58	25.36	Pass
	165	5825	-1.18	1.04	4.77	0.37	6.18	25.36	Pass

NOTE:

- Method 1 of power density measurement of KDB 662911 is using for calculating total power density. Total power density is summing entire spectra across corresponding frequency bins on the various outputs by computer.
- Directional gain = $5.87\text{dBi} + 10\log(3) = 10.64\text{dBi} > 6\text{dBi}$, so the power density limit shall be reduced to $30 - (10.64 - 6) = 25.36\text{dBm}$.
- Refer to section 3.3 for duty cycle spectrum plot.

802.11n (HT20)

TX chain	Channel	Freq. (MHz)	PSD (dBm/300kHz)	PSD (dBm/500kHz)	10 log (N=3) dB	Duty factor	Total PSD (dBm/500kHz)	Limit (dBm/500kHz)	Pass /Fail
0	149	5745	-2.72	-0.50	4.77	0.26	4.53	25.36	Pass
	157	5785	2.70	4.92	4.77	0.26	9.95	25.36	Pass
	165	5825	-1.15	1.07	4.77	0.26	6.10	25.36	Pass
1	149	5745	-1.31	0.91	4.77	0.26	5.94	25.36	Pass
	157	5785	2.54	4.76	4.77	0.26	9.79	25.36	Pass
	165	5825	-0.74	1.48	4.77	0.26	6.51	25.36	Pass
2	149	5745	-1.67	0.55	4.77	0.26	5.58	25.36	Pass
	157	5785	1.99	4.21	4.77	0.26	9.24	25.36	Pass
	165	5825	-1.25	0.97	4.77	0.26	6.00	25.36	Pass

NOTE:

- Method 1 of power density measurement of KDB 662911 is using for calculating total power density. Total power density is summing entire spectra across corresponding frequency bins on the various outputs by computer.
- Directional gain = $5.87\text{dBi} + 10\log(3) = 10.64\text{dBi} > 6\text{dBi}$, so the power density limit shall be reduced to $30 - (10.64 - 6) = 25.36\text{dBm}$.
- Refer to section 3.3 for duty cycle spectrum plot.

802.11n (HT40)

TX chain	Channel	Freq. (MHz)	PSD (dBm/300kHz)	PSD (dBm/500kHz)	10 log (N=3) dB	Duty factor	Total PSD (dBm/500kHz)	Limit (dBm/500kHz)	Pass /Fail
0	151	5755	-9.95	-7.73	4.77	0.74	-2.22	25.36	Pass
	159	5795	-3.71	-1.49	4.77	0.74	4.02	25.36	Pass
1	151	5755	-8.72	-6.50	4.77	0.74	-0.99	25.36	Pass
	159	5795	-2.74	-0.52	4.77	0.74	4.99	25.36	Pass
2	151	5755	-9.07	-6.85	4.77	0.74	-1.34	25.36	Pass
	159	5795	-3.78	-1.56	4.77	0.74	3.95	25.36	Pass

NOTE:

- Method 1 of power density measurement of KDB 662911 is using for calculating total power density. Total power density is summing entire spectra across corresponding frequency bins on the various outputs by computer.
- Directional gain = $5.87\text{dBi} + 10\log(3) = 10.64\text{dBi} > 6\text{dBi}$, so the power density limit shall be reduced to $30 - (10.64 - 6) = 25.36\text{dBm}$.
- Refer to section 3.3 for duty cycle spectrum plot.

802.11ac (VHT80)

TX chain	Channel	Freq. (MHz)	PSD (dBm/300kHz)	PSD (dBm/500kHz)	10 log (N=3) dB	Duty factor	Total PSD (dBm/500kHz)	Limit (dBm/500kHz)	Pass /Fail
0	155	5775	-23.47	-21.25	4.77	1.21	-15.27	25.36	Pass
1	155	5775	-21.06	-18.84	4.77	1.21	-12.86	25.36	Pass
2	155	5775	-22.57	-20.35	4.77	1.21	-14.37	25.36	Pass

NOTE:

- Method 1 of power density measurement of KDB 662911 is using for calculating total power density. Total power density is summing entire spectra across corresponding frequency bins on the various outputs by computer.
- Directional gain = $5.87\text{dBi} + 10\log(3) = 10.64\text{dBi} > 6\text{dBi}$, so the power density limit shall be reduced to $30 - (10.64 - 6) = 25.36\text{dBm}$.
- Refer to section 3.3 for duty cycle spectrum plot.

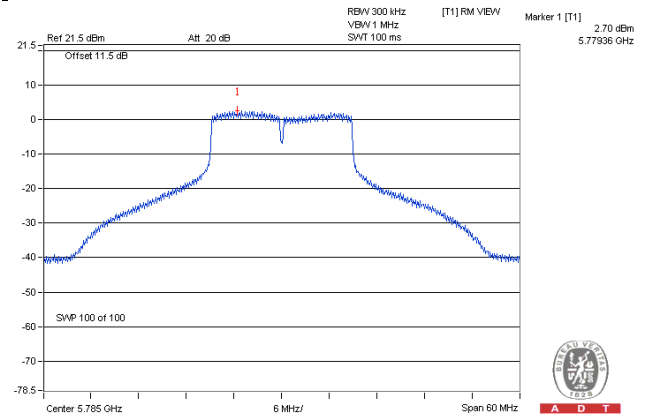
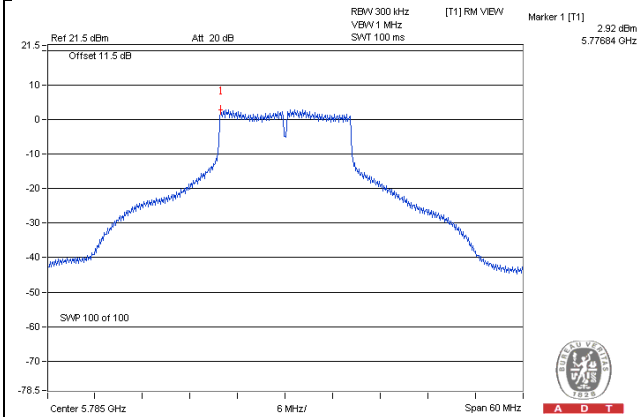
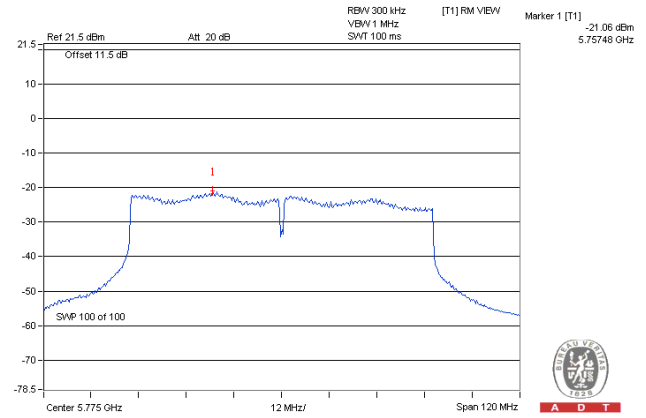
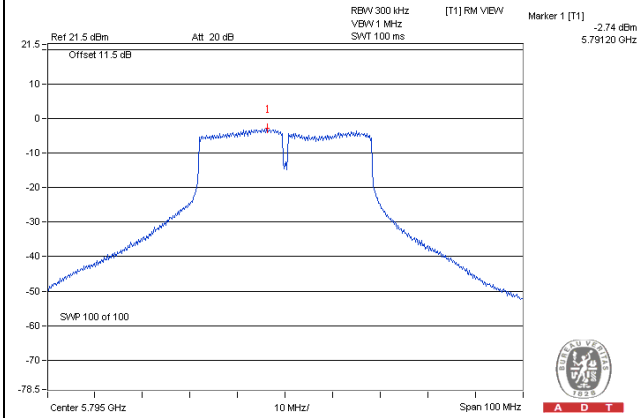
SPECTRUM PLOT OF WORST VALUE**802.11a****802.11n (HT20)****802.11n (HT40)****802.11ac (VHT80)**

4.5 Frequency Stability

4.5.1 Limits of Frequency Stability Measurement

The frequency of the carrier signal shall be maintained within band of operation

4.5.2 Test Setup

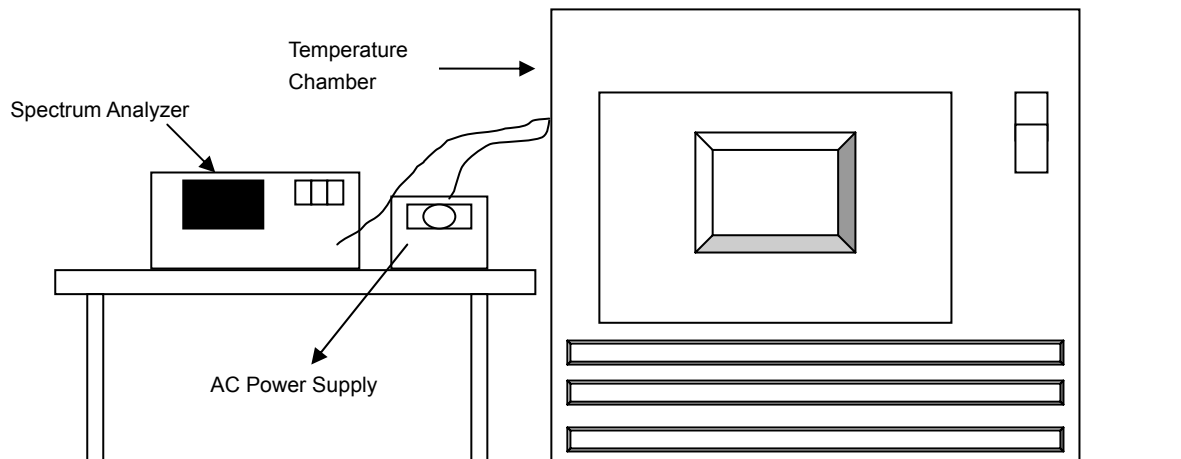

4.5.3 Test Instruments

Refer to section 4.1.2 to get information of above instrument.

4.5.4 Test Procedure

- The EUT was placed inside the environmental test chamber and powered by nominal AC voltage.
- Turn the EUT on and couple its output to a spectrum analyzer.
- Turn the EUT off and set the chamber to the highest temperature specified.
- Allow sufficient time (approximately 30 min) for the temperature of the chamber to stabilize, turn the EUT on and measure the operating frequency after 2, 5, and 10 minutes.
- Repeat step 2 and 3 with the temperature chamber set to the lowest temperature.
- The test chamber was allowed to stabilize at +20 degree C for a minimum of 30 minutes. The supply voltage was then adjusted on the EUT from 85% to 115% and the frequency record.

4.5.5 Deviation from Test Standard

No deviation.

4.5.6 EUT Operating Condition

Set the EUT transmit at un-modulation mode to test frequency stability.

4.5.7 Test Results

FREQUENCY STABILITY VERSUS TEMP.									
OPERATING FREQUENCY: 5240MHz									
TEMP. (°C)	POWER SUPPLY (Vac)	0 MINUTE		2 MINUTE		5 MINUTE		10 MINUTE	
		Measured Frequency (MHz)	Frequency Drift (%)	Measured Frequency (MHz)	Frequency Drift (%)	Measured Frequency (MHz)	Frequency Drift (%)	Measured Frequency (MHz)	Frequency Drift (%)
50	120	5239.9786	-0.00041	5239.9818	-0.00035	5239.9786	-0.00041	5239.978	-0.00042
40	120	5239.9981	-0.00004	5240.0003	0.00001	5239.9998	0.00000	5239.9983	-0.00003
30	120	5239.9784	-0.00041	5239.9778	-0.00042	5239.9779	-0.00042	5239.9788	-0.00040
20	120	5240.0203	0.00039	5240.0164	0.00031	5240.0192	0.00037	5240.0187	0.00036
10	120	5239.9788	-0.00040	5239.9803	-0.00038	5239.9799	-0.00038	5239.9778	-0.00042
0	120	5239.9959	-0.00008	5239.9999	0.00000	5239.9962	-0.00007	5239.9982	-0.00003
-10	120	5240.0153	0.00029	5240.0126	0.00024	5240.0159	0.00030	5240.0112	0.00021
-20	120	5239.9857	-0.00027	5239.9836	-0.00031	5239.9846	-0.00029	5239.9840	-0.00031
-30	120	5239.9905	-0.00018	5239.9915	-0.00016	5239.9924	-0.00015	5239.9922	-0.00015

FREQUENCY STABILITY VERSUS TEMP.									
OPERATING FREQUENCY: 5240MHz									
TEMP. (°C)	POWER SUPPLY (Vac)	0 MINUTE		2 MINUTE		5 MINUTE		10 MINUTE	
		Measured Frequency (MHz)	Frequency Drift (%)	Measured Frequency (MHz)	Frequency Drift (%)	Measured Frequency (MHz)	Frequency Drift (%)	Measured Frequency (MHz)	Frequency Drift (%)
20	138	5240.0200	0.00038	5240.0164	0.00031	5240.0191	0.00036	5240.0191	0.00036
	120	5240.0203	0.00039	5240.0164	0.00031	5240.0192	0.00037	5240.0187	0.00036
	102	5240.0209	0.00040	5240.0171	0.00033	5240.0201	0.00038	5240.0186	0.00035

4.6 6dB Bandwidth Measurement

4.6.1 Limits of 6dB Bandwidth Measurement

The minimum of 6dB Bandwidth Measurement is 0.5MHz.

4.6.2 Test Setup

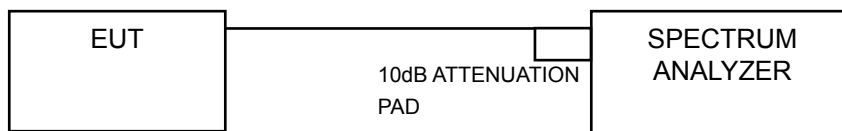

4.6.3 Test Instruments

Refer to section 4.1.2 to get information of above instrument.

4.6.4 Test Procedure

- a. Set resolution bandwidth (RBW) = 100kHz
- b. Set the video bandwidth (VBW) $\geq 3 \times$ RBW, Detector = Peak.
- c. Trace mode = max hold.
- d. Sweep = auto couple.
- e. Measure the maximum width of the emission that is constrained by the frequencies associated with the two amplitude points (upper and lower) that are attenuated by 6 dB relative to the maximum level measured in the fundamental emission

4.6.5 Deviation from Test Standard

No deviation.

4.6.6 EUT Operating Condition

The software provided by client to enable the EUT under transmission Condition continuously at lowest, middle and highest channel frequencies individually.

4.6.7 Test Results

802.11a

Channel	Frequency (MHz)	6dB Bandwidth (MHz)			Minimum Limit (MHz)	Pass / Fail
		Chain 0	Chain 1	Chain 2		
149	5745	16.41	16.40	16.40	0.5	Pass
157	5785	16.36	16.44	16.38	0.5	Pass
165	5825	16.38	16.37	16.40	0.5	Pass

802.11n (HT20)

Channel	Frequency (MHz)	6dB Bandwidth (MHz)			Minimum Limit (MHz)	Pass / Fail
		Chain 0	Chain 1	Chain 2		
149	5745	17.57	17.21	17.63	0.5	Pass
157	5785	17.64	17.57	17.64	0.5	Pass
165	5825	16.92	17.61	17.63	0.5	Pass

802.11n (HT40)

Channel	Frequency (MHz)	6dB Bandwidth (MHz)			Minimum Limit (MHz)	Pass / Fail
		Chain 0	Chain 1	Chain 2		
151	5755	36.48	36.32	36.36	0.5	Pass
159	5795	35.62	36.34	35.88	0.5	Pass

802.11ac (VHT80)

Channel	Frequency (MHz)	6dB Bandwidth (MHz)			Minimum Limit (MHz)	Pass / Fail
		Chain 0	Chain 1	Chain 2		
155	5775	69.12	70.90	73.31	0.5	Pass

SPECTRUM PLOT OF WORST VALUE

802.11a

802.11n (HT20)

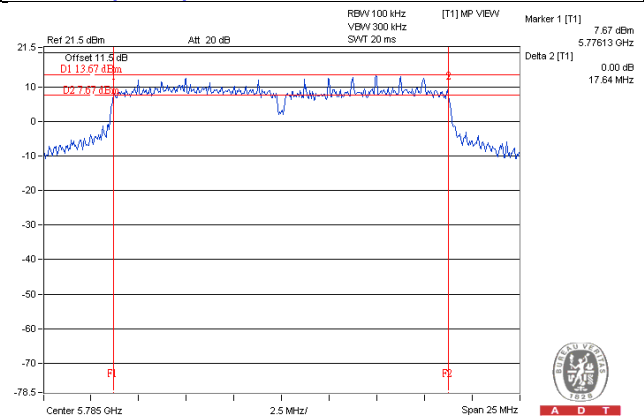
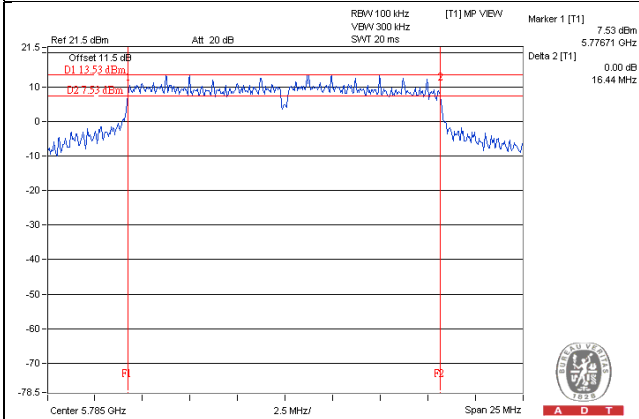

802.11n (HT40)

802.11ac (VHT80)

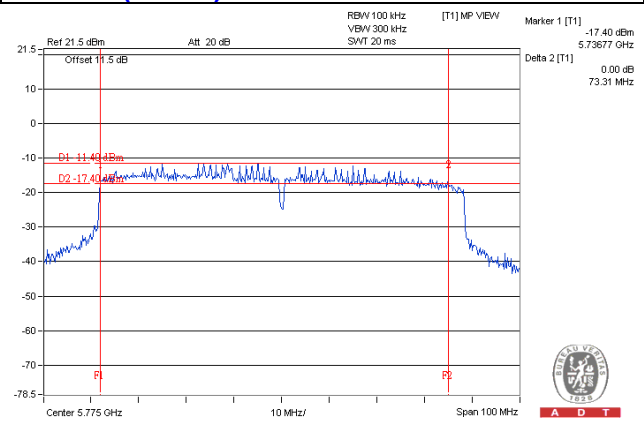
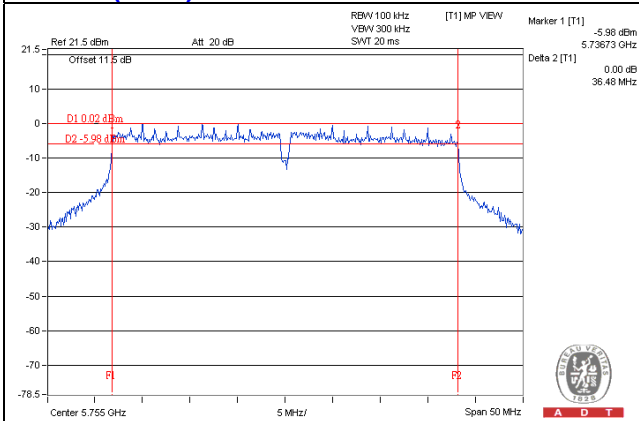

5 Pictures of Test Arrangements

Please refer to the attached file (Test Setup Photo).



Appendix – Information on the Testing Laboratories

We, Bureau Veritas Consumer Products Services (H.K.) Ltd., Taoyuan Branch, were founded in 1988 to provide our best service in EMC, Radio, Telecom and Safety consultation. Our laboratories are accredited and approved according to ISO/IEC 17025.

If you have any comments, please feel free to contact us at the following:

Linko EMC/RF Lab

Tel: 886-2-26052180

Fax: 886-2-26051924

Hsin Chu EMC/RF Lab/Telecom Lab

Tel: 886-3-5935343

Fax: 886-3-5935342

Hwa Ya EMC/RF/Safety

Tel: 886-3-3183232

Fax: 886-3-3270892

Email: service.adt@tw.bureauveritas.com

Web Site: www.bureauveritas-adt.com

The address and road map of all our labs can be found in our web site also.

--- END ---