

SAR MEASUREMENT REPORT

FCC ID: HD5-CK62X00
Applicant: Honeywell International Inc
Honeywell Safety and Productivity Solutions
Product: Mobile Computer
Model No.: CK62X00
Brand Name: Honeywell
FCC Rule Part(s): FCC 47 CFR Part 2.1093
Result: Complies
Received Date: 2024-06-04
Test Date: 2024-07-12 ~ 2024-07-19

Reviewed By:

Ada Zhang

Approved By:

Robin Wu



The test results relate only to the samples tested.

This equipment has been shown to be capable of compliance with the applicable technical standards as indicated in the measurement report and was tested in accordance with the measurement procedures specified in IEEE1528, KDB 447498 and KDB 865664. Test results reported herein relate only to the item(s) tested.

The test report shall not be reproduced except in full without the written approval of MRT Technology (Suzhou) Co., Ltd.

Revision History

Report No.	Version	Description	Issue Date	Note
2406RSU006-U7	V01	Initial Report	2024-08-16	Valid

CONTENTS

Description	Page
1. General Information	5
1.1. Applicant	5
1.2. Manufacturer	5
1.3. Testing Facility	5
1.4. Product Information	6
1.5. Radio Specification under Test	7
1.6. Antennas Details	8
2. Summary of Test Result	9
2.1. Test Standards	9
2.2. Environment Condition	9
2.3. RF Exposure Limits below 6GHz	10
2.4. RF Exposure Limits above 6GHz	10
2.5. Test Result Summary	11
3. Specific Absorption Rate (SAR)	12
3.1. Introduction	12
3.2. Definition	12
4. DASY6 Measurement System	13
4.1. Introduction	13
4.2. DASY6 Measurement System Diagram	13
4.3. System Components Details	15
5. The SAR Measurement Procedure	28
5.1. Measurement Process Diagram	28
5.2. Test Position Definition	29
5.3. Test Procedure	32
6. System Verificaiton	35
6.1. SAR Tissue Check	35
6.2. SAR System Check	38
6.3. PD System Check	40
7. Analysis and Results	41
7.1. Antenna Location	41
7.2. Conducted Power	42
7.3. Body-worn SAR Test Results	50
7.4. Extremity SAR Test Results	54
7.5. PD Test Results	61
8. Simultaneous Transmission Analysis	62
9. Measuring Instrument	65

10. Measurement Uncertainty.....	66
Annex A - System Check Result	71
Annex B - Test Data Plots	79
Annex C - SAR Test Setup Photograph.....	111
Annex D - EUT Photograph	112
Annex E - Equipment Calibration Report.....	113

1.4. Product Information

Product Name	Mobile Computer
Model No.	CK62X00
EUT Identification No.	20240604Sample#17 (Sample 1#) 20240604Sample#16 (Sample 2#)
Brand Name	Honeywell
Antenna Information	Refer to section 1.6
EUT Type	Portable Device
Exposure Category	General Population/Uncontrolled Exposure
Accessory	
Rechargeable Li-ion Battery	Model No.: CK65-BTSC Nominal Voltage: 3.6V Rated Capacity: 6800mAh Nominal Capacity: 7000mAh/25.2Wh
<p>Notes:</p> <ol style="list-style-type: none"> The information of EUT was provided by the manufacturer, and the accuracy of the information shall be the responsibility of the manufacturer. The Mobile Computer has two types of image engines (S0703 and S0803/N6803) and two types of keypads (Numeric and Alpha numeric). Full SAR test is performed on Mobile Computer with S0703 image engine and Alpha numeric keypad (Sample 1#), highest reported SAR for each frequency band is repeated on Mobile Computer with S0803/N6803 image engine and Numeric keypad (Sample 2#). 	

1.5. Radio Specification under Test

Wi-Fi Specification	
Frequency Range	<p><u>For 2.4GHz Wi-Fi</u></p> <p>802.11b/g/n-HT20/ax-HE20 & VHT20: 2412 ~ 2462MHz</p> <p>802.11n-HT40/ax-HE40 & VHT40: 2422 ~ 2452MHz</p> <p><u>For 5GHz Wi-Fi</u></p> <p>802.11a/n-HT20/ac-VHT20/ax-HE20:</p> <p>5180 ~ 5240 MHz, 5260 ~ 5320 MHz, 5500 ~ 5720 MHz, 5745 ~ 5825 MHz</p> <p>802.11n-HT40/ac-VHT40/ax-HE40:</p> <p>5190 ~ 5230 MHz, 5270 ~ 5310 MHz, 5510 ~ 5710 MHz, 5755 ~ 5795 MHz</p> <p>802.11ac-VHT80/ax-HE80:</p> <p>5210 MHz, 5290 MHz, 5530 MHz, 5610 MHz, 5690MHz, 5775 MHz</p> <p><u>For 6GHz Wi-Fi</u></p> <p>802.11ax-HE20: 5955 ~ 7115MHz</p> <p>802.11ax-HE40: 5965 ~ 7085 MHz</p> <p>802.11ax-HE80: 5985 ~ 7025 MHz</p> <p>802.11ax-HE160: 6025 ~ 6985MHz</p>
Channel Number	<p><u>For 2.4GHz Wi-Fi</u></p> <p>802.11b/g/n-HT20/ax-HE20 & VHT20: 11</p> <p>802.11n-HT40/ax-HE40 & VHT40: 7</p> <p><u>For 5GHz Wi-Fi</u></p> <p>802.11a/n-HT20/ac-VHT20/ax-HE20: 25</p> <p>802.11n-HT40/ac-VHT40/ax-HE40: 12</p> <p>802.11ac-VHT80/ax-HE80: 6</p> <p><u>For 6GHz Wi-Fi</u></p> <p>802.11ax-HE20: 59</p> <p>802.11ax-HE40: 29</p> <p>802.11ax-HE80: 14</p> <p>802.11ax-HE160: 7</p>
Type of Modulation	<p>802.11b: DSSS</p> <p>802.11a/g/n/ac & VHT: OFDM</p> <p>802.11ax: OFDMA</p>

Data Rate	802.11b: 1/2/5.5/11Mbps 802.11a/g: 6/9/12/18/24/36/48/54Mbps 802.11n: up to 300Mbps 802.11ac: up to 866.7Mbps 802.11ax: up to 2402Mbps	
Support RU	<input checked="" type="checkbox"/> Full RU	<input checked="" type="checkbox"/> Partial RU
Bluetooth Specification		
Frequency Range	2402MHz~ 2480MHz	
Channel Number	For Bluetooth: 79 For BT-LE: 40	
Channel Spacing	For Bluetooth: 1MHz For BT-LE: 2MHz	
Type of Modulation	For Bluetooth: 1Mbps (GFSK), 2Mbps (Pi/4 DQPSK), 3Mbps (8DPSK) For BT-LE: 1Mbps & 2Mbps & 125kbps & 500kbps (GFSK)	

Note: 802.11ax supports partial RU and full RU configuration, the maximum power of partial RU configuration is small than full configuration, therefore SAR is only performed in full RU configuration.

1.6. Antennas Details

Operating Condition	Ant 3	Bluetooth BR/EDR/LE (1Tx, 1Rx)
	Ant 3 + Ant 2	802.11b/g/n/ax & VHT for 2.4GHz Wi-Fi (2Tx, 2Rx) 802.11a/n/ac/ax for 5GHz Wi-Fi (2Tx, 2Rx)
Antenna Type	PIFA Antenna	
Simultaneously Transmitting Scenarios	Wi-Fi (Ant 3 + Ant 2) transmit simultaneously; BT (Ant 3) cannot transmit simultaneously with Wi-Fi (Ant 2).	

2. Summary of Test Result

2.1. Test Standards

No.	Identity	Document Title
1	47 CFR Part 2.1093	Radiofrequency radiation exposure evaluation: portable devices
2	IEEE 1528-2013	IEEE Recommended Practice for Determining the Peak Spatial-Average Specific Absorption Rate (SAR) in the Human Head from Wireless Communications Devices: Measurement Techniques
3	IEC/IEEE 62209-1528:2020 ED1	IEC/IEEE International Standard - Measurement procedure for the assessment of specific absorption rate of human exposure to radio frequency fields from hand-held and body-mounted wireless communication devices – Part 1528: Human models, instrumentation, and procedures (Frequency range of 4 MHz to 10 GHz)
4	IEC 62479:2010 ED1	Assessment of the compliance of low-power electronic and electrical equipment with the basic restrictions related to human exposure to electromagnetic fields (10 MHz to 300 GHz)
5	IEC TR 63170:2018 ED1	Measurement procedure for the evaluation of power density related to human exposure to radio frequency fields from wireless communication devices operating between 6 GHz and 100 GHz
6	IEC/IEEE 63195-1:2022 ED1	Assessment of power density of human exposure to radio frequency fields from wireless devices in close proximity to the head and body (frequency range of 6 GHz to 300 GHz) - Part 1: Measurement procedure
7	KDB 447498 D04 v01	Interim General RF Exposure Guidance
8	KDB 865664 D01 v01r04	SAR Measurement 100 MHz to 6 GHz
9	KDB 865664 D02 v01r02	RF Exposure Reporting
10	KDB 248227 D01 v02r02	SAR Guidance for IEEE 802.11 (Wi-Fi) Transmitter
11	KDB 388624 D02 v18r06	Pre-Approval Guidance List

2.2. Environment Condition

Ambient Temperature	20.5°C~24.0°C
Temperature of Simulant	20.0°C~23.5°C
Relative Humidity	38%RH ~55%RH

2.3. RF Exposure Limits below 6GHz

Human Exposure	Basic restrictions for electric, magnetic and electromagnetic fields. (Unit in mW/g or W/kg)
Spatial Peak SAR ¹ (Head and Body)	1.60
Spatial Average SAR ² (Whole Body)	0.08
Spatial Peak SAR ³ (Arms and Legs)	4.00

Notes:

1. The Spatial Peak value of the SAR averaged over any 1gram of tissue (defined as a tissue volume in the shape of a cube) and over the appropriate averaging time.
2. The Spatial Average value of the SAR averaged over the whole body.
3. The Spatial Peak value of the SAR averaged over any 1 gram of tissue (defined as a tissue volume in the shape of a cube) and over appropriate averaging time.

2.4. RF Exposure Limits above 6GHz

Frequency Range (MHz)	Electric Field Strength (V/m)	Magnetic Field Strength (A/m)	Power Density (mW/cm ²)	Average Time (Minutes)
(A) Limits for Occupational/ Control Exposures				
0.3-3.0	614	1.63	*(100)	≤6
3.0-30	1842/f	4.89/f	*(900/f ²)	<6
30-300	61.4	0.163	1.0	<6
300-1,500	--	--	f/300	<6
1,500-100,000	--	--	5	<6
(B) Limits for General Population/ Uncontrolled Exposures				
0.3-1.34	614	1.63	*(100)	<30
1.34-30	824/f	2.19/f	*(180/f ²)	<30
30-300	27.5	0.073	0.2	<30
300-1,500	--	--	f/1500	<30
1,500-100,000	--	--	1.0	<30

Notes:

1. Peak Spatially Averaged Power Density was evaluated over a square area of 4cm² per interim FCC Guidance for near-field power density evaluations.
2. 1.0 mW/cm² is 10 W/m².

2.5. Test Result Summary

Worst SAR/PD List

Highest Reported SAR		Body-worn 1g SAR (W/kg)	Extremity 10g SAR (W/kg)
Ant 3	DTS Band Wi-Fi	0.22	2.32
	U-NII-1 Band Wi-Fi	0.34	2.32
	U-NII-2A Band Wi-Fi	0.31	2.10
	U-NII-2C Band Wi-Fi	0.44	1.67
	U-NII-3 Band Wi-Fi	0.30	2.51
	U-NII-5&6&7&8 Band Wi-Fi	0.06	0.34
	Bluetooth	0.03	0.32
Ant 2	DTS Band Wi-Fi	0.38	1.27
	U-NII-1 Band Wi-Fi	0.83	0.70
	U-NII-2A Band Wi-Fi	0.82	0.60
	U-NII-2C Band Wi-Fi	0.51	0.94
	U-NII-3 Band Wi-Fi	0.47	0.74
	U-NII-5&6&7&8 Band Wi-Fi	0.11	0.18

Highest Simultaneous SAR/PD

Highest Reported SAR	Body-worn 1g SAR (W/kg)	Extremity 10g SAR (W/kg)	psPD (W/m ²)
DTS Band Wi-Fi MIMO	0.43	3.59	--
U-NII-1 Band Wi-Fi MIMO	1.17	2.89	--
U-NII-2A Band Wi-Fi MIMO	1.13	2.64	--
U-NII-2C Band Wi-Fi MIMO	0.95	2.04	--
U-NII-3 Band Wi-Fi MIMO	0.77	2.90	--
U-NII-5&6&7&8 Band Wi-Fi MIMO	0.16	0.52	8.84

3. Specific Absorption Rate (SAR)

3.1. Introduction

SAR is related to the rate at which energy is absorbed per unit mass in an object exposed to a radio field. The SAR distribution in a biological body is complicated and is usually carried out by experimental techniques or numerical modeling. The standard recommends limits for two tiers of groups, occupational /controlled and general population/uncontrolled, based on a person's awareness and ability to exercise control over his or her exposure. In general, occupational/controlled exposure limits are higher than the limits for general population/uncontrolled.

3.2. Definition

The SAR in the tissue-equivalent liquid can be determined by the rate of temperature increase or by E-field measurements, according to Formulas (1) or (2):

$$SAR = \frac{\sigma E^2}{\rho} \quad (1)$$

$$SAR = c_h \left. \frac{dT}{dt} \right|_{t=0} \quad (2)$$

where

SAR is the specific absorption rate in W/kg;

E is the rms value of the electric field strength in the tissue medium in V/m;

σ is the electrical conductivity of the tissue medium in S/m;

ρ is the mass density of the tissue medium in kg/m³;

c_h is the specific heat capacity of the tissue medium in J/(kg K);

$\left. \frac{dT}{dt} \right|_{t=0}$ is the initial time derivative of temperature in the tissue medium in K/s.

4. DASY6 Measurement System

4.1. Introduction

DASY6 is the latest generation of the Dosimetric Assessment System optimized for specific absorption rate (SAR) measurements, SAR compliance. DASY6 builds on the power of our industry - leading dosimetric and near-field evaluation system, DASY52. Running on a significantly more robust platform and a more powerful measurement server, DASY6 offers much faster scanning with no sacrifice of measurement precision. All hardware and software are fully compatible with DASY52. The new system seamlessly integrates two software solutions, the novel cDASY V6.6 - optimized for SAR compliance testing to significantly reduce SAR assessment costs - and the widely used DASY V5.2 for generalized near-field evaluations with maximized flexibility.

4.2. DASY6 Measurement System Diagram

The DASY6 system in cDASY6/DASY5 V5.2 SAR Configuration is shown below:

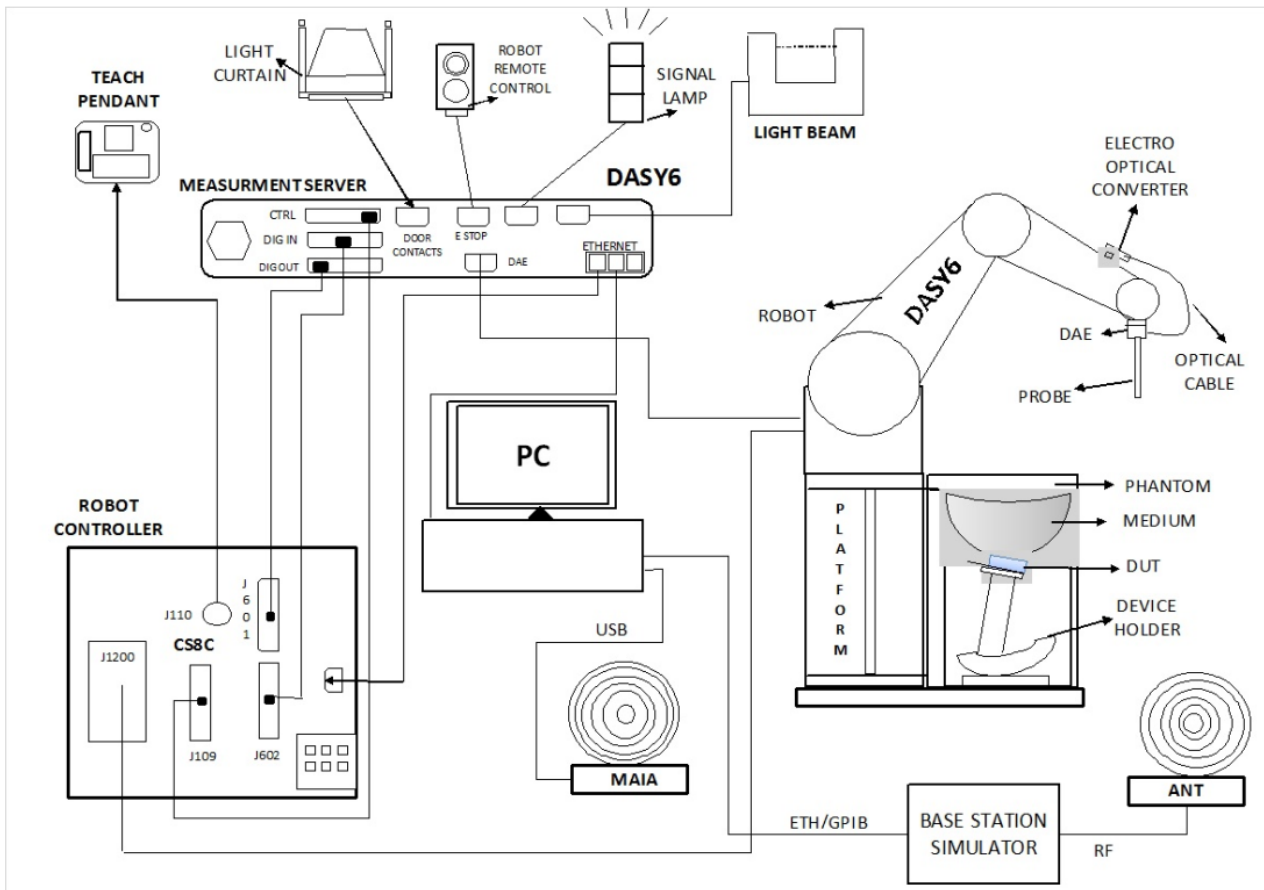

The System consist of the following components:

DASY6 Measurement Server, Data Acquisition Electronics (DAE), Probes, Light-Beam Unit, Phantoms, Media, Device Holder for SAM-Twin Phantom, Laptop Extension Kit to Mounting Device, Robot System Platform & Pedestal, Verification of the Parameters with the Dielectric Assessment Kit (DAK), Modulation and Interference Analyzer (MAIA), Omni-Directional Ultra-Wideband Antenna (ANT), cDASY6 software, DASY5 NEO software and SEMCAD data evaluation software.

Typical setup for PD measurement with DASY6:

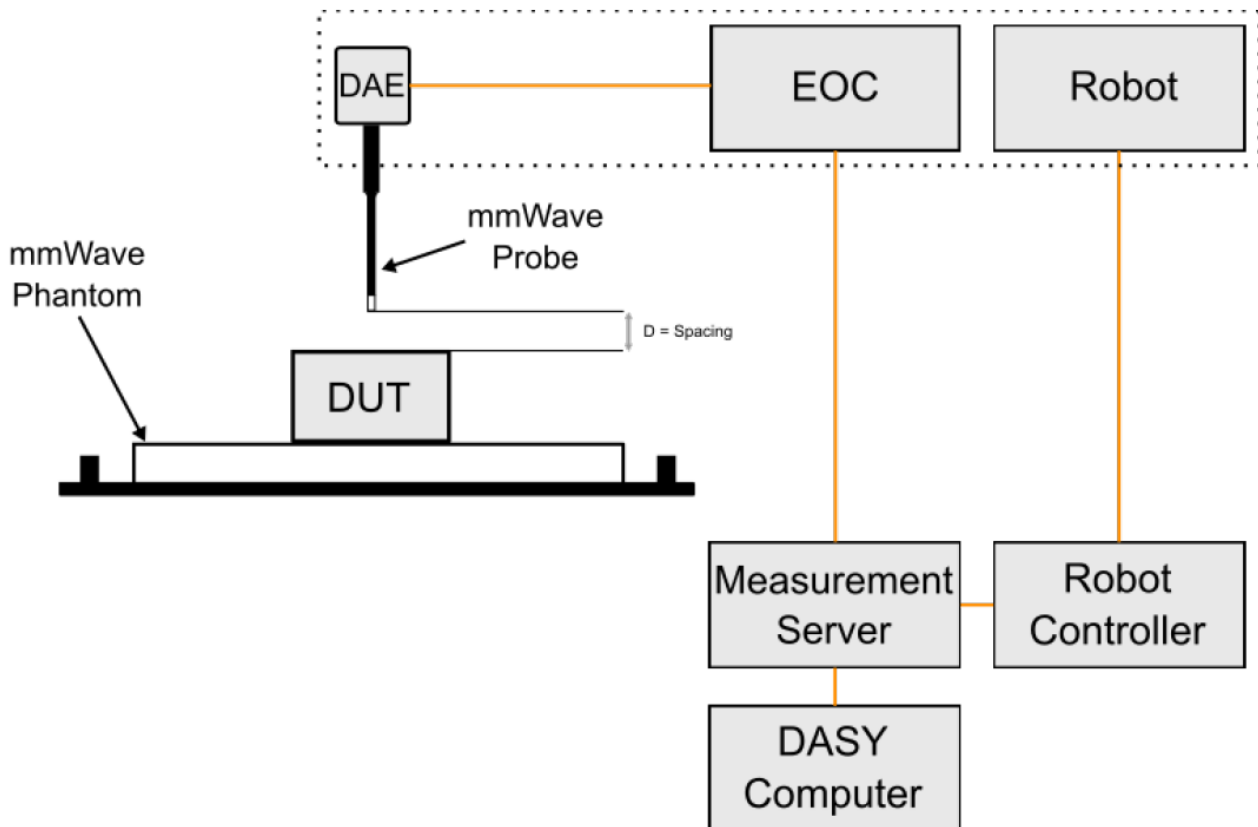

A typical DASY6 system for PD measurements consists of:

- 6-axis robotic arm (Stäubli TX-60L/ TX-90XL) for positioning the probe
- Mounting Platform for maintaining the phantoms at a fixed location relative to the robot
- Measurement Server that handles all time-critical tasks, such as measurement data acquisition and supervision of safety features
- Electrical to Optical Converter (EOC) for converting the optical signal from the DAE to electrical before being transmitted to the measurement server
- Light Beam unit for probe alignment (measurement of the exact probe length and eccentricity)
- millimeter Wave (mmWave) probe (EummWVx) for measuring the E-field magnitude. The polarization ellipses and the power density are then derived.
- mmWave phantom used as the test bed
- DAE that reads the probe voltages and transmits it to the DASY6 PC
- mmWave Device Holder for positioning the EUT on top of the phantom
- operator PC that runs the DASY6 software for defining/executing the measurements
- verification sources for system performance checks.

4.3. System Components Details

DASY6 Platforms MP6E-TX60L

MP6E-TX60L platform is a compact cost-effective platform based on TX60L. It consists of:

- a stable non-metallic platform for the TX60L robot
- a frame for two standard-size phantoms (1.0 × 0.5 m)
- a frame for one half-size phantom (0.5 × 0.5 m)

It includes two easily moveable trolleys for the phone and tablet/computer positioner and two platforms for positioning dipoles and other antennas.

Material The beams consist of a composite of wood and epoxy (permittivity of 3.3 and loss tangent of <0.07)

Size The footprint of the platform is 1590 mm × 1060 mm.

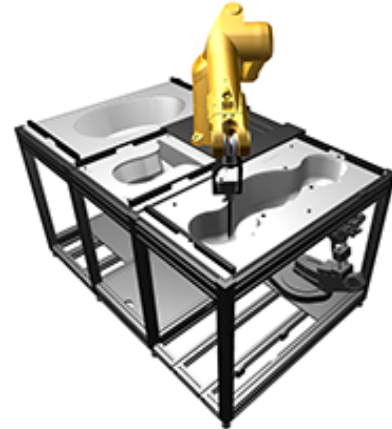

Robots -TX60L

The MRT DASY6 system uses the high-precision industrial robots TX60L from Staubli SA (France). The TX robot family - the successor of the well-known RX robot family - continues to offer the features important for DASY6 applications:

- High precision (repeatability 0.02mm)
- High reliability (industrial design)
- Low maintenance costs (virtually maintenance-free as all gears are direct drive, no belt drives)
- Jerk-free straight movements (brushless synchron motors, no stepper motors)
- Low extremely low frequency (ELF) interference (motor control fields are shielded by the closed metallic construction)

The robots are controlled by the Staubli CS8c robot controllers. All information regarding the use and maintenance of the robot arm and the robot controller is provided on CDs delivered with the robot. Paper manuals are available directly from Staubli upon request.



DASY6 Measurement Server

The DASY6 measurement server is based on a PC/104 CPU board with a 400MHz intel ULV Celeron, 128MB chip-disk and 128MB RAM. The necessary circuits for communication with the DAE4 electronics box, as well as the 16-bit AD converter system for optical detection and digital I/O interface are contained on the DASY6 I/O board, which is directly connected to the PC/104 bus of the CPU board. The measurement server performs all real-time data evaluations of field measurements and surface detection, controls robot movements, and handles safety operations.



Data Acquisition Electronics (DAE)

The data acquisition electronics (DAE4) consist of a highly sensitive electrometer-grade preamplifier with auto-zeroing, a channel and gain-switching multiplexer, a fast 16-bit AD-converter, and a command decoder with a control logic unit. Transmission to the measurement server is accomplished through an optical downlink for data and status information, as well as an optical uplink for commands and the clock.

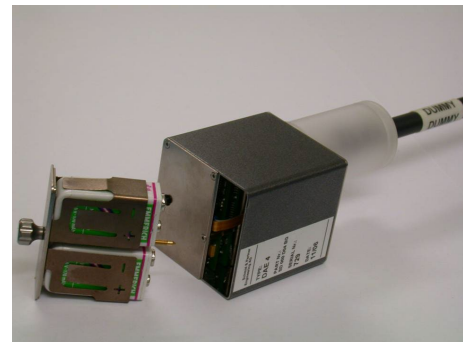

Probes

E-Field Probe(EX3DV4)

The SAR measurement is conducted with the dosimetric probe manufactured by SPEAG. The probe is specially designed and calibrated for use in liquid with high permittivity. The dosimetric probe has special calibration in liquid at different frequency. SPEAG conducts the probe calibration in compliance with international and national standards (e.g. IEEE 1528, EN 62209-1, IEC 62209, etc.) under ISO 17025.

Construction:

Symmetric design with triangular core Built-in shielding against static charges PEEK enclosure material (resistant to organic solvents, e.g., DGBE)

Frequency: 4 MHz ~ 10 GHz

Linearity: ± 0.2 dB (30 MHz ~ 10 GHz)

Directivity:

± 0.1 dB in TSL (rotation around probe axis)

± 0.3 dB in TSL (rotation normal to probe axis)

Dynamic Range: 10 μ W/g to 100 mW/g; Linearity: ± 0.2 dB (noise: typically < 1 μ W/g)

Dimensions:

Overall length: 337 mm (Tip: 20 mm)

Tip diameter: 2.5 mm (Body: 12 mm)

Typical distance from probe tip to dipole centers: 1 mm

Applications:

High precision dosimetric measurements in any exposure scenario (e.g., very strong gradient fields); the only probe that enables compliance testing for frequencies up to 6 GHz with precision of better than 30%.



MSTV1 (Mother Scan Teaching V1) Electronics & TP6V2 (Teaching Probe 6V2) Probe

MSTV1 (Mother Scan Teaching V1) electronics together with the TP6V2 (Teaching Probe 6V2) probe is used for mother scan of DASY6 system. This probe uses a 3D Renishaw LP2 sensor which ensures accurate detection of any shape and a measurement repeatability of 8 μ m.



mmWave Probe (EUmmWV4)

The EUmmWV4 probe is based on the pseudo-vector probe design, which not only measures the field magnitude but also derives its polarization ellipse. This probe concept is advantageous because the sensor angle errors or distortions of the field by the substrate can be largely nullified by calibration. This is particularly important as field distortions by the substrate are dependent on the wavelength at these very high frequencies. The probe contains two small 0.8mm dipole sensors mechanically protected by high-density foam, printed on both sides of a 0.9mm wide and 0.12mm thick glass substrate. The body of the probe is specifically constructed to minimize distortion by the scattered fields.

The sensitivity of the probe sensors, which is dependent on frequency, is calibrated during exposure to E-fields of known amplitude. The frequency response of the sensor is smooth over the entire frequency and can be approximated with a lumped element model of five elements. During a pre-calibration step using the same setup as for calibration, we determine the values of the lumped elements. The evaluation method is based on a least-squares optimization and it increases the precision of the calibration. It also provides reliable sensitivity parameters over the entire calibration frequency range, covering the gaps between the calibration bands. The stated uncertainty is therefore also valid for the entire frequency range from 750MHz to 110 GHz.

calibrated frequencies

calibration antenna frequency bands

validation / verification frequencies

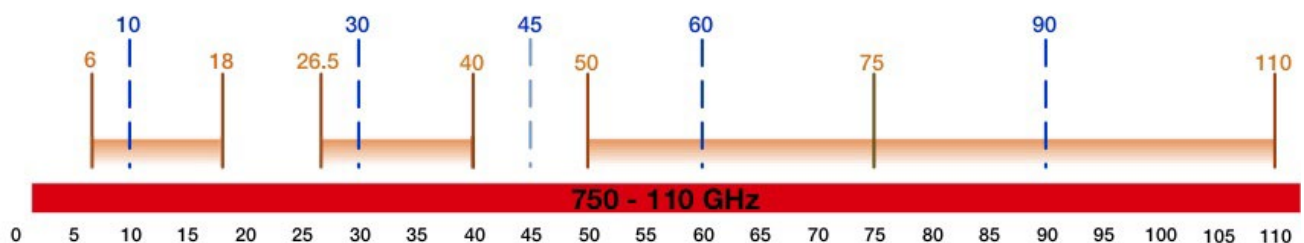

Calibration bands and frequencies from 6–110 GHz.

The probe design allows measurements at distances as small as 2mm from the sensors to the surface of the DUT. The typical sensor to the probe tip distance is 1.5 mm. The exact distance is calibrated.



Light-Beam Unit

The light beam switch allows automatic "tooling" of the probe. During the process, the actual position of the probe tip with respect to the robot arm, as well as the probe length and the horizontal probe offset, are measured. The software then corrects all movements within the measurement jobs, such that the robot coordinates are valid for the probe tip.



The repeatability of this process is better than 0.1 mm. If a position has been taught with an aligned probe, the same position will be reached with another aligned probe within 0.1 mm, even if the other probe has different dimensions. During probe rotations, the probe tip will keep its actual position.

mmWave Device Holder (mmWDH)

mmWave Device Holder (mmWDH) is designed to ease positioning of the DUT of various sizes when measuring PD along an edge. It is made of low loss Rohacell material and meets the standard requirements. It is provided with an additional spacer to accommodate devices with smaller form factors.



Verification Sources

The horn antenna-based verification sources are used for regular system verification. They are available at five different frequencies: 10 GHz, 30 GHz, 45 GHz, 60GHz, and 90 GHz (see Figure 3.13.1. The 10 GHz source has a SMA connector and can be connected to any supply generator. The other sources comprise a Gunn oscillator.

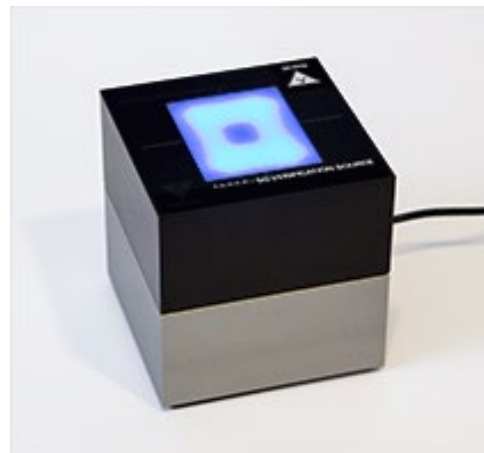
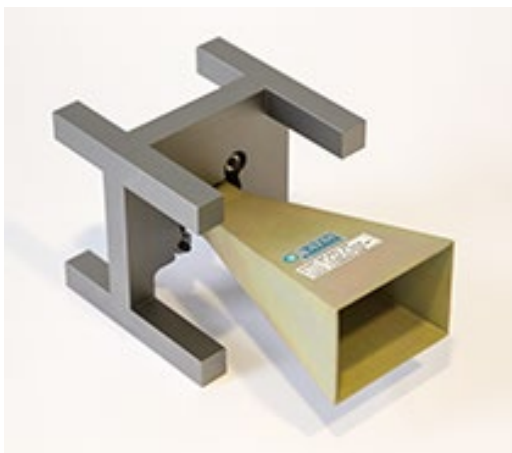

Phantoms

SAM-Twin Phantom

The shell corresponds to the specifications of the Specific Anthropomorphic Mannequin (SAM) phantom defined in IEEE 1528 and IEC 62209-1. It enables the dosimetric evaluation of left and right hand phone usage as well as body-mounted usage at the flat phantom region. A cover prevents evaporation of the liquid. Reference markings on the phantom allow the complete setup of all predefined phantom positions and measurement grids by teaching three points with the robot.

SAM-Twin V5.0 and higher has the same shell geometry and is manufactured from the same material as SAM-Twin V4.0, but with the top structure reinforced.

Material Vinyl ester, fiberglass reinforced (VE-GF)
The phantom shell is compatible with SPEAG tissue simulating liquids (sugar and oil based).

Liquid Compatibility Use of other liquids may render the phantom warranty void (see note or consult SPEAG support).

Shell Thickness 2 ± 0.2 mm (6 ± 0.2 mm at ear point)

Dimensions Length: 1000 mm

(incl. Wooden Width: 500 mm

Support) Height: adjustable feet

Filling Volume approx. 25 liters

Support DASY6: standard-size platform slot

DASY52 stand-alone: SPEAG standard phantom table

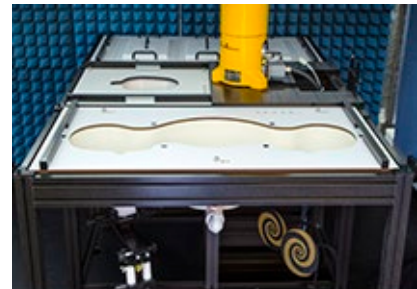

ELI phantom

The ELI phantom is used for compliance testing of handheld and body-mounted wireless devices in the frequency range of 30 MHz to 6 GHz. ELI is fully compatible with the IEC 62209-2 standard and all known tissue simulating liquids. ELI has been optimized regarding its performance and can be integrated into our standard phantom tables. A cover prevents evaporation of the liquid. Reference markings on the phantom allow installation of the complete setup, including all predefined phantom positions and measurement grids, by teaching three points. The phantom is compatible with all SPEAG dosimetric probes and dipoles.

ELI V5.0 and higher has the same shell geometry and is manufactured from the same material as ELI V4.0, but has reinforced top structure. ELI V6.0, released in August 2014, has the same shell geometry as ELI V4.0 but offers increased longterm stability.

Material	Vinyl ester, fiberglass reinforced (VE-GF)
Liquid Compatibility	The phantom shell is compatible with SPEAG tissue simulating liquids (sugar and oil based). Use of other liquids may render the phantom warranty void (see note or consult SPEAG support).
Shell Thickness	2.0 ± 0.2 mm (bottom plate)
Dimensions	Major axis: 600 mm Minor axis: 400 mm
Filling Volume	approx. 30 liters
Support	DASY6: standard-size platform slot DASY52 stand-alone: SPEAG standard phantom table

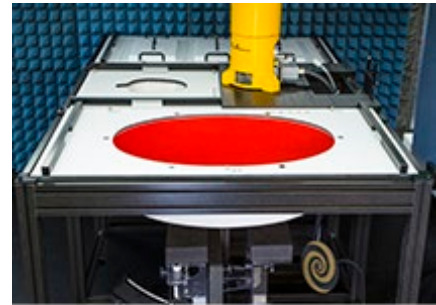

SAM Face Down Phantom

The SAM Face Down Phantom V10 allows assessment of the exposure of the face and in particular the eyes for handheld devices operated in front of the face. e.g., video phones, cameras, organizers, etc. It is manufactured from high precision injection molded polypropylene. The Mounting Device for Transmitters including extensions kit can be used to position the device.

Material	Epoxy based
Liquid Compatibility	The phantom shell is compatible with SPEAG tissue simulating liquids (sugar and oil based). Use of other liquids may render the phantom warranty void (see note or consult SPEAG support).
Shell Thickness	2 ± 0.2 mm (6 mm at ear point)
Head Shape	Standard compatible SAM head.

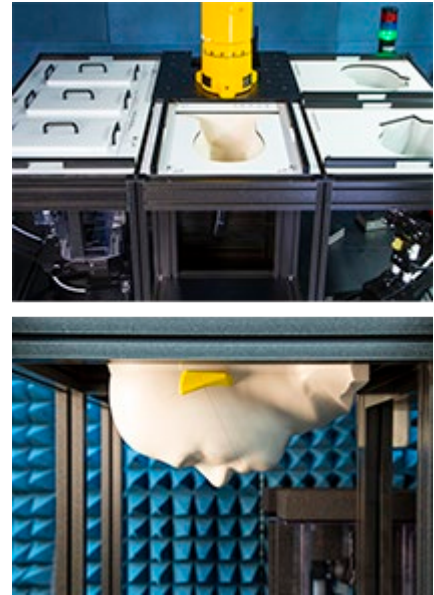

SAM Head Stand Phantom

The SAM Head Stand Phantom V10 allows assessment of the exposure of the top-head or around-the-head wireless accessories, e.g., head-belts, etc. It is manufactured from high precision injection molded polypropylene. The Mounting Device for Transmitters including extensions kit can be used to position the device.

Material	Epoxy based
Liquid Compatibility	The phantom shell is compatible with SPEAG tissue simulating liquids (sugar and oil based). Use of other liquids may render the phantom warranty void (see note or consult SPEAG support).
Shell Thickness	2 ± 0.2 mm (6 mm at ear point)
Head Shape	Standard compatible SAM head.



Wrist Phantom

The Wrist Phantom V10 is shape-compatible with the CTIA approved OTA GFPC-V1 and optimized for SAR evaluation of watches and other wireless hand accessories.

Material	Epoxy based The phantom shell is compatible with SPEAG tissue simulating liquids (sugar and oil based). Use of other liquids may render the phantom warranty void (see note or consult SPEAG support).
Liquid Compatibility	
Shell Thickness	Shell Thickness
Wrist Shape	Design compatible with CTIA forearm.



mmWave Phantoms

The mmWave Phantom approximates free-space conditions, allowing for the evaluation of the antenna side of the device and the front (screen) side or any opposite-radiating side of wireless devices operating above 10 GHz without distorting the RF field. It consists of a 40mm thick Rohacell plate used as a test bed, which has a loss tangent ($\tan \delta$) ≤ 0.05 and a relative permittivity (ϵ_r) ≤ 1.2 . High-performance RF absorbers are placed below the foam.

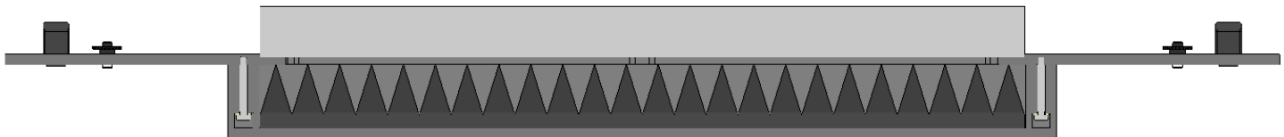

Cross section of the mmWave phantom

The reflectivity performance of the mmWave phantom has been evaluated in comparison to the predecessor 5G Phantom and a total reflective backside of the foam.

The reflectivity of both phantoms was measured with a method similar to the NRL arch approach, except that the phantoms under study were placed in the near-fields of the transmitting antenna and the receiving antenna.

The reflectivity measurement was performed at 10, 30, 60, and 90 GHz. At each frequency, a corresponding pair of pyramidal horns was used as the transmitting antenna and the receiving antenna. The continuous-wave (CW) signal fed into the transmitting antenna was generated by a signal generator at 10 GHz and a Gunn oscillator at 30, 60, and 90 GHz. The power captured by the receiving antenna was measured by a thermal power sensor. The transmitting antenna and the receiving antenna were placed symmetrically to the normal of the metal plate. The antennas were further oriented to provide perpendicular polarization and to roughly meet the specular-reflection law (since either the transmitting antenna or the receiving antenna may be moved slightly around their initial positions to capture the maximum reflected power and/or the casing of the antennas and the power sensor makes it impossible to move the antennas close enough for very small incident angles). Three incident angles, varying from $< 10^\circ$ to approx. 45° , were studied at each frequency. The reflectivity of the phantom is quantified by the difference between the reflected power exclusively from the metal plate and the reflected power from the phantom placed on the same metal plate. The results demonstrate that the reflectivity of the mmWave phantom is reduced by more than 20 dB between 10 and 90 GHz compared to the predecessor 5G phantom and better than 20 dB with respect to a phantom with total reflections (i.e., the foam with a large metal plate on its backside).

The mmWave phantom meets all the requirements for accurate exposure evaluations of any device operating at >10 GHz. The 5G phantom should only be used if the device radiates away from the phantom.

Device Holder for SAM-Twin Phantom

The SAR in the phantom is approximately inversely proportional to the square of the distance between the source and the liquid surface. For a source at 5mm distance, a positioning uncertainty of $\pm 0.5\text{mm}$ would produce uncertainty in the SAR of $\pm 20\%$. Accurate device positioning is therefore crucial for accurate and repeatable measurements. The positions at which the devices must be measured are defined by the standards.

MD4HHTV5 - Mounting Device for Hand-Held Transmitters

In combination with the Twin SAM V5.0/V5.0c or ELI phantoms, the Mounting Device for Hand-Held Transmitters enables rotation of the mounted transmitter device to specified spherical coordinates. At the heads, the rotation axis is at the ear opening. Transmitter devices can be easily and accurately positioned according to IEC 62209-1, IEEE 1528, FCC, or other specifications. The device holder can be locked for positioning at different phantom sections (left head, right head, flat).

Material: Polyoxymethylene (POM)



MDA4WTV5 - Mounting Device Adaptor for Ultra Wide Transmitters

An upgrade kit to Mounting Device to enable easy mounting of wider devices like big smart-phones, e-books, small tablets, etc. It holds devices with width up to 140 mm.

Material: Polyoxymethylene (POM)



MDA4SPV6 - Mounting Device Adaptor for Smart Phones

The solid low-density MDA4SPV6 adaptor assuring no impact on the DUT radiation performance and is conform with any DUT design and shape.

Material: ROHACELL



MD4LAPV5 - Mounting Device for Laptops and other Body-Worn Transmitters

In combination with the Twin SAM V5.0/V5.0c or ELI phantoms, the Mounting Device (Body-Worn) enables testing of transmitter devices according to IEC 62209-2 specifications. The device holder can be locked for positioning at a flat phantom section.

Material: Polyoxymethylene (POM), PET-G, Foam



MDA4LAP - Mounting Device Adaptor for Laptops

A simple but effective and easy-to-use extension for the Mounting Device; facilitates testing of larger devices (e.g., laptops, cameras, etc.) according to IEC 62209-2; lightweight and fits easily on the upper part of the Mounting Device in place of the phone positioner. The extension is fully compatible with the Twin SAM as well as ELI and other Flat Phantoms.

Material: Polyoxymethylene (POM), PET-G, Foam



Modulation and Interference Analyzer(MAIA)

MAIA is a hardware interface used to evaluate the modulation and audio interference characteristics of RF signals in the frequency range 698 - 6000 MHz. DASY6 evaluates the time-domain and frequency domain properties of the uplink signal transmitted by the DUT during SAR measurement with MAIA. MAIA uses USB powered active electronics to identify the modulation of the DUT. It can be operated over the air interface using the built-in ultra-broadband planar log spiral antenna (698 - 6000 MHz) or in conducted mode using the coaxial SMA 50 Ohm connector (300 - 6000 MHz).



To prevent damage in conducted mode due to high peak power, an external RF attenuator may be mounted. The LED on the MAIA hardware also indicates whether it is connected.

DAK-3.5 (200MHz – 20GHz)

This precision dielectric measurement system is designed to cover the 200MHz – 20GHz frequency range with a single open-ended coaxial dielectric probe. The system uses advanced algorithms and novel hardware to measure the dielectric properties of liquids, solids, and semi-solids over a broad range of parameters. The measurement method is fast and non-destructive to the material under test.



Evaluation of reference liquids over a broad frequency range for specific absorption rate (SAR) measurements, in accordance with IEC 62209, IEEE 1528, and several federal regulations.

Evaluating Software: DAK software version 2.0

MRT simulating liquid

Product	Test Frequency (MHz)	Main Ingredients
HSL450	400 – 500	Water, Sucrose, NaCl
MSL450	400 – 500	Water, Sucrose, NaCl

Speag Broad-Band simulating liquid

Product	Test Frequency (MHz)	Main Ingredients
HBBL600-10000V6	600 – 10000	Water, Oil
MBBL600-6000V6	600 – 6000	Water, Oil

5. The SAR Measurement Procedure

5.1. Measurement Process Diagram

General Procedure

For IEEE1528-2013 Head SAR

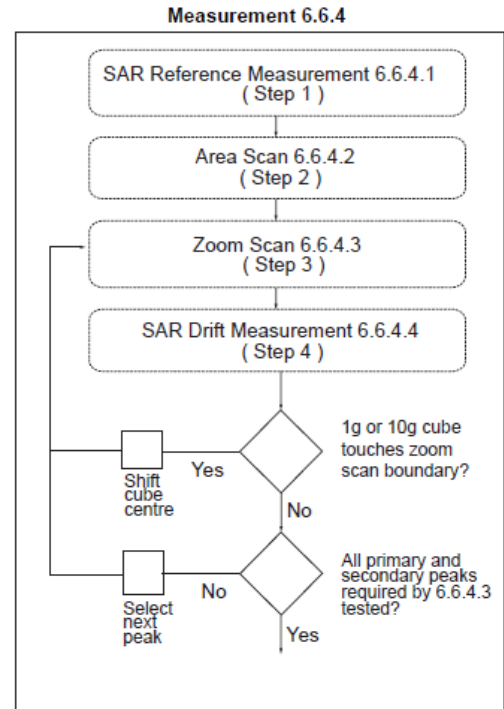
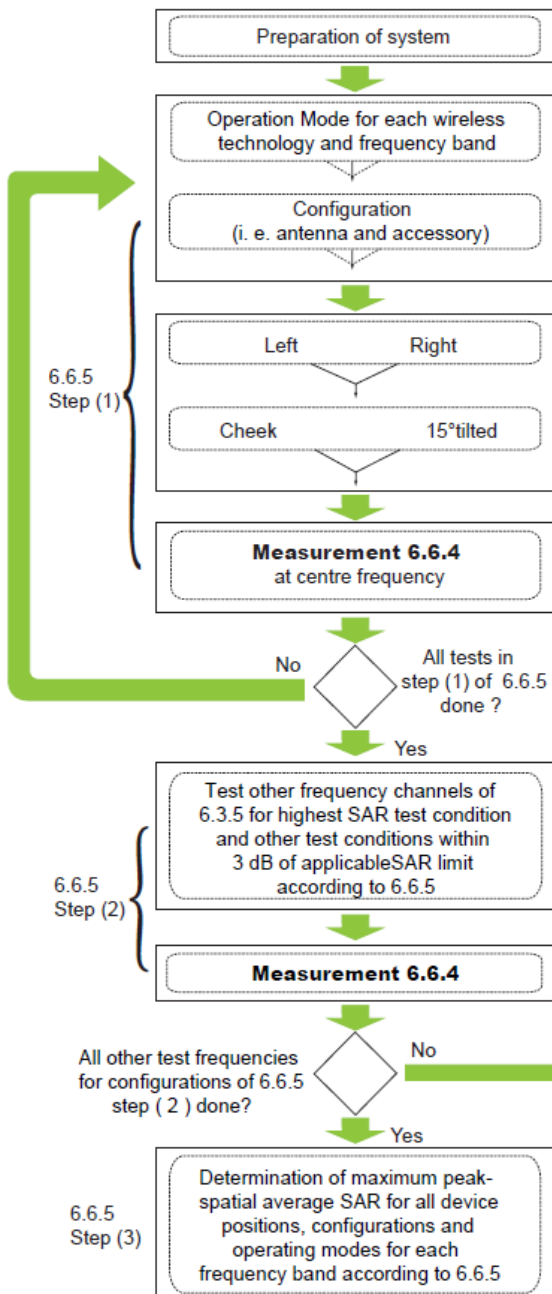

For Body SAR

SAR scan procedures described in section 2.7 of KDB 865664 D01 v01r04 should be applied to body SAR test.

5.2. Test Position Definition

■ Head SAR Test Position

Define two imaginary lines on the handset—the vertical centerline and the horizontal line. The vertical centerline passes through two points on the front side of the handset—the midpoint of the width w_t of the handset at the level of the acoustic output [point A in Fixed case and Clamshell case], and the midpoint of the width w_b at the bottom of the handset (point B). The horizontal line is perpendicular to the vertical centerline and passes through the center of the acoustic output [see Fixed case]. The horizontal line is also tangential to the face of the handset at point A. The two lines intersect at point A. Note that for many handsets, point A coincides with the center of the acoustic output; however, the acoustic output may be located elsewhere on the horizontal line. Also note that the vertical centerline is not necessarily parallel to the front face of the handset [see Clamshell case], especially for clamshell handsets, handsets with flip covers, and other irregularly-shaped handsets, the vertical centerline passes through point A but not the tip edge of the phone.

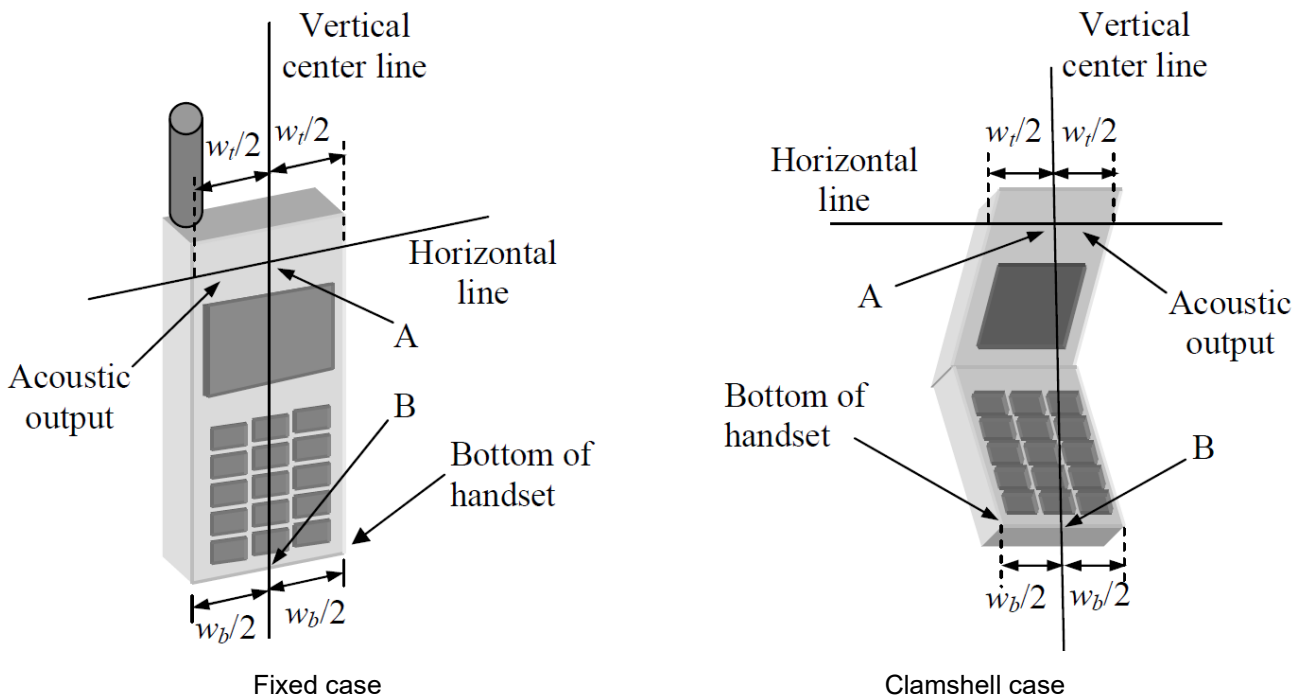

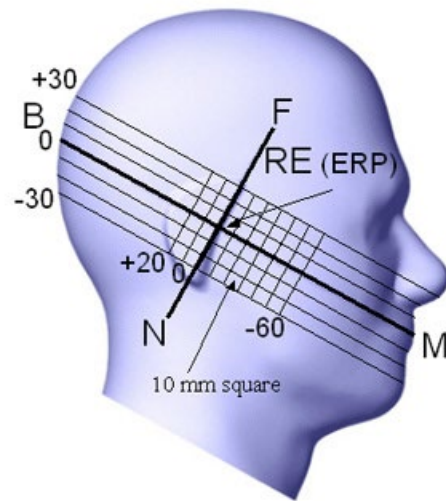
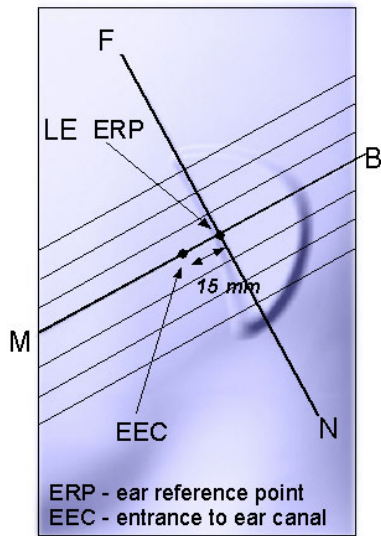
Key

- B Direction of B-M line back endpoint
- F Direction of N-F line front endpoint
- N Direction of N-F line neck endpoint
- M Mouth reference point
- LE Left ear reference point (ERP)

Key

- B Line B-M back endpoint
- M Line B-M front endpoint
- N Line N-F neck endpoint
- F Line N-F front endpoint
- RE Right ear reference point (ERP)

Cheek Position

The cheek position has the following characteristics, based on the geometrical lines described above:

- The N-F line (see above) is in the plane defined by the handset vertical centerline and horizontal line
- Handset touches the pinna
- The handset vertical centerline is aligned with the Reference Plane.

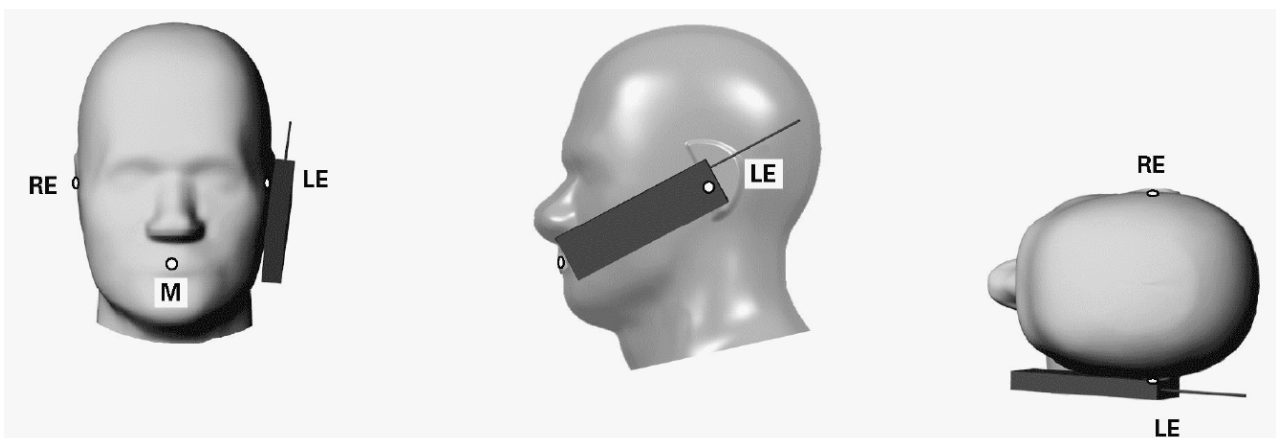

Key

- M Mouth reference point
- LE Left ear reference point
- RE Right ear reference point

Tilt Position

The tilt position is established as follows:

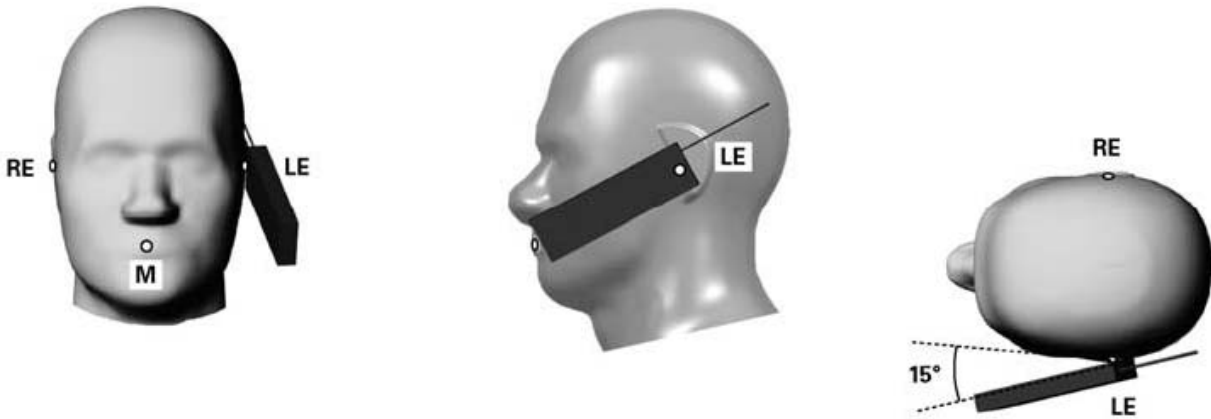
- Repeat the steps to place the device in the cheek position.
- While maintaining the orientation of the handset, move the handset away from the pinna along the line passing through RE and LE far enough to allow a rotation of the handset away from the cheek by 15°.
- Rotate the handset around the horizontal line by 15°.
- While maintaining the orientation of the handset, move the handset towards the phantom on the line passing through RE and LE until any part of the handset touches the ear. The tilt position is obtained when the contact point is on the pinna. If contact occurs at any location other than the pinna, e.g., the antenna at the back of the phantom head, the angle of the handset shall be reduced. In this case, the tilt position is obtained if any point on the handset is in contact with the pinna and a second point on the handset is in contact with the phantom, e.g., the antenna with the back of the head.



Key

- M Mouth reference point
- LE Left ear reference point
- RE Right ear reference point

■ Body SAR Test Position

For body-worn accessory, hotspot mode and other exposure conditions to human body should be conducted pursuant to the test position requirements of SAR KDBs for certain product.

5.3. Test Procedure

Step 1 Setup a Connection

First, engineer should record the conducted power before the test. Then establish a call in handset at the maximum power level with a base station simulator via air interface, or make the EUT establish transmission by itself in testing band. Place the EUT to certain test position.

Step 2 Power Reference Measurements

To measure the local E-field value at a fixed location which value will be taken as a reference value for calculating a possible power drift.

Step 3 Area Scan

The Area Scan is used as a fast scan in two dimensions to find the area of high field values, before doing a fine measurement around the hot spot. The sophisticated interpolation routines implemented in DASYS software can find the maximum locations even in relatively coarse grids. When an Area Scan has measured all reachable points, it computes the field maximal found in the scanned area, within a range of the global maximum. The range (in dB) is specified in the standards for compliance testing. For example, a 2 dB range is required in IEEE Standard 1528 and IEC 62209 standards, whereby 3 dB is a requirement when compliance is assessed in accordance with the ARIB standard (Japan). If only one Zoom Scan follows the Area Scan, then only the absolute maximum will be taken as reference. For cases where multiple maximums are detected, the number of Zoom Scans has to be increased accordingly.

Area Scan Parameters extracted from KDB 865664 D01v01r04

	≤ 3 GHz	> 3 GHz
Maximum distance from closest measurement point (geometric center of probe sensors) to phantom surface	5 mm ± 1 mm	$\frac{1}{2} \cdot \delta \cdot \ln(2)$ mm ± 0.5 mm
Maximum probe angle from probe axis to phantom surface normal at the measurement location	30° ± 1°	20° ± 1°
Maximum area scan spatial resolution: Δx_{Area} , Δy_{Area}	≤ 2 GHz: ≤ 15 mm 2 - 3 GHz: ≤ 12 mm	3 - 4 GHz: ≤ 12 mm 4 - 6 GHz: ≤ 10 mm
	When the x or y dimension of the test device, in the measurement plane orientation, is smaller than the above, the measurement resolution must be ≤ the corresponding x or y dimension of the test device with at least one measurement point on the test device.	
Note: δ is the penetration depth of a plane-wave at normal incidence to the tissue medium; see IEEE Std 1528-2013 for details.		

Step 4 Zoom Scan

Zoom Scans are used to assess the peak spatial SAR values within a cubic averaging volume containing 1 g and 10 g of simulated tissue. The Zoom Scan measures points (refer to table below) within a cube whose base faces are centered on the maxima found in a preceding area scan job within the same procedure. When the measurement is done, the Zoom Scan evaluates the averaged SAR for 1 g and 10 g and displays these values next to the job's label.

Zoom Scan Parameters extracted from KDB 865664 D01 v01r04

			≤ 3 GHz	> 3 GHz
Maximum zoom scan spatial resolution: $\Delta x_{\text{Zoom}}, \Delta y_{\text{Zoom}}$			≤ 2 GHz: ≤ 8 mm 2 - 3 GHz: ≤ 5 mm*	3 - 4 GHz: ≤ 5 mm* 4 - 6 GHz: ≤ 4 mm*
Maximum zoom scan spatial resolution, normal to phantom surface	uniform grid: $\Delta z_{\text{Zoom}}(n)$		≤ 5 mm	3 - 4 GHz: ≤ 4 mm 4 - 5 GHz: ≤ 3 mm 5 - 6 GHz: ≤ 2 mm
	graded grid	$\Delta z_{\text{Zoom}}(1)$: between 1 st two points closest to phantom surface	≤ 4 mm	3 - 4 GHz: ≤ 3 mm 4 - 5 GHz: ≤ 2.5 mm 5 - 6 GHz: ≤ 2 mm
		$\Delta z_{\text{Zoom}}(n>1)$: between subsequent points	≤ 1.5 · $\Delta z_{\text{Zoom}}(n-1)$ mm	
Minimum zoom scan volume	x, y, z		≥ 30 mm	3-4 GHz: ≥ 28 mm 4-5 GHz: ≥ 25 mm 5-6 GHz: ≥ 22 mm
Note: * When zoom scan is required and the reported SAR from the area scan based 1-g SAR estimation procedures of KDB Publication 447498 is ≤ 1.4 W/kg, ≤ 8 mm, ≤ 7 mm and ≤ 5 mm zoom scan resolution may be applied, respectively, for 2 GHz to 3 GHz, 3 GHz to 4 GHz and 4 GHz to 6 GHz.				

Step 5 Power Drift Measurements

Repetition of the E-field measurement at the fixed location mentioned in Step 1 to make sure the two results differ by less than ± 0.2 dB.

Step 6 Test Data

After the test, SAR test data should be exported by SEMCAD.

6. System Verificaiton

6.1. SAR Tissue Check

- Refer to KDB 865664 D01 v01r04, the depth of tissue-equivalent liquid in a phantom must be ≥ 15.0 cm with $\leq \pm 0.5$ cm variation for SAR measurements ≤ 3 GHz and ≥ 10.0 cm with $\leq \pm 0.5$ cm variation for measurements > 3 GHz.

15cm Depth Head Tissue for ELI Phantom

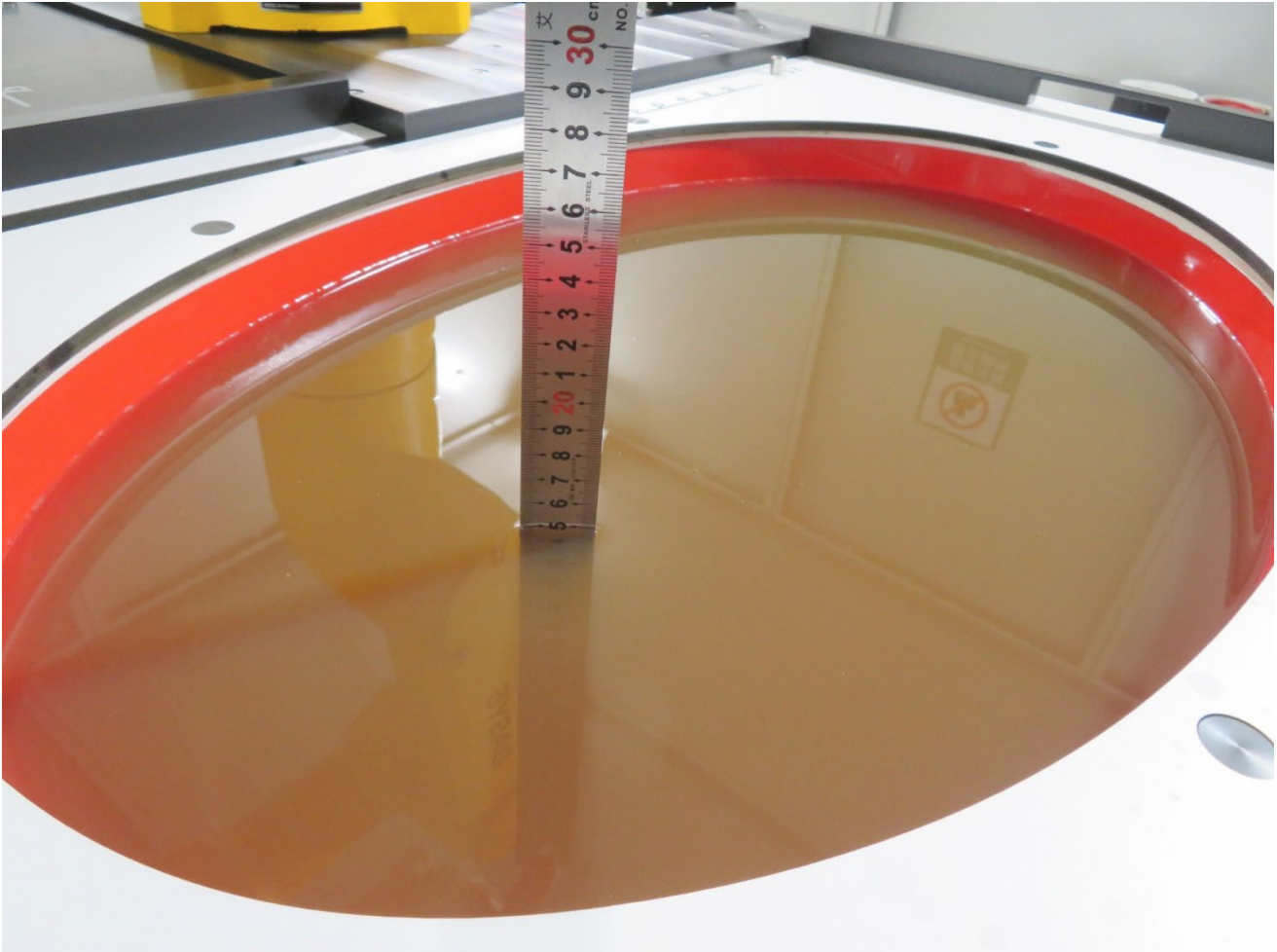

■ Dielectric properties of the head tissue-equivalent liquid

Frequency MHz	Relative Permittivity ϵ_r	Conductivity (σ) S/m
300	45.3	0.87
450	43.5	0.87
750	41.9	0.89
835	41.5	0.90
900	41.5	0.97
1 450	40.5	1.20
1 500	40.4	1.23
1 640	40.2	1.31
1 750	40.1	1.37
1 800	40.0	1.40
1 900	40.0	1.40
2 000	40.0	1.40
2 100	39.8	1.49
2 300	39.5	1.67
2 450	39.2	1.80
2 600	39.0	1.96
3 000	38.5	2.40
3 500	37.9	2.91
4 000	37.4	3.43
4 500	36.8	3.94
5 000	36.2	4.45
5 200	36.0	4.66
5 400	35.8	4.86
5 600	35.5	5.07
5 800	35.3	5.27
6 000	35.1	5.48
6 500	34.5	6.07
7 000	33.9	6.65
7 500	33.3	7.24
8 000	32.7	7.84
8 500	32.1	8.46
9 000	31.6	9.08
9 500	31.0	9.71
1 0000	30.4	10.40

Note: For convenience, permittivity and conductivity values are linearly interpolated for frequencies that are not a part of the original data from Drossos et al. [2]. They are shown in italics in Table 2. The italicized values are linearly interpolated (below 5 800 MHz) or extrapolated (above 5 800 MHz) from the non-italicized values that are immediately above and below these values.

■ Tissue Calibration Result

The dielectric parameters of the liquids were verified prior to the SAR evaluation using DASY6 Dielectric Assessment Kit and keysight PNA-L Network Analyzer N5234B.

Freq. (MHz)	Perm.	Cond.	Target Perm.	Target Cond.	Deviation Perm. %	Deviation Cond. %	Tissue Temperature	Test Date
2450	40.57	1.78	39.20	1.80	3.49	-1.11	22.5°C	2024.07.12
5250	35.88	4.50	35.93	4.71	-0.14	-4.46	22.5°C	2024.07.15
5600	35.26	4.89	35.53	5.07	-0.76	-3.55	22.5°C	2024.07.16
5750	34.99	5.06	35.36	5.22	-1.05	-3.07	22.5°C	2024.07.16
6500	33.70	5.93	34.50	6.07	-2.32	-2.31	22.5°C	2024.07.17

Note: The $\pm 5\%$ deviation of tissue parameter is recommended.

6.2. SAR System Check

■ Purpose

The purpose of the system check is to verify that the system operates within its specifications at the device test frequencies. System check verifies the measurement repeatability of a SAR system before compliance testing and is not a validation of all system specifications. The latter is not required for testing a device but is mandatory before the system is deployed.

■ System Performance Check Setup Diagram

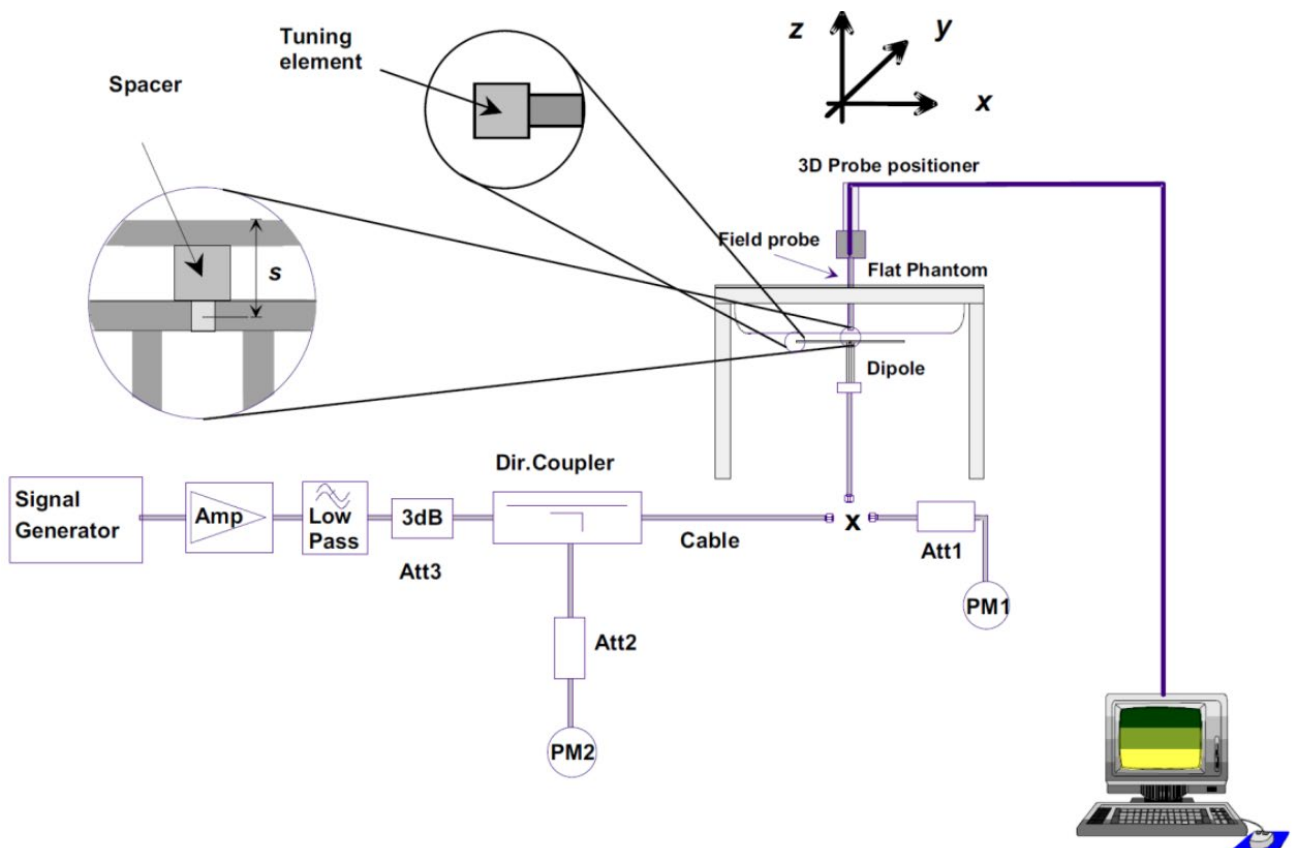

■ System Check Procedure

The system check procedure is a complete 1g and 10g peak spatial-average SAR measurement using a source having a previously determined system check target value. The measured 1g and 10g SAR are normalized to the target input power of the specific source and compared to their respective target values. A description of the different measurement tasks to be performed is given below, together with the information that can be deduced from their results:

- a. The Power Reference Measurement and Power Drift Measurement are located at the beginning and end of the batch process. They measure the field drift at one single point in the liquid over the complete procedure. The indicated drift is mainly the variation of the amplifier output power. If it is too high (above ± 0.1 dB), the

system check should be repeated; some amplifiers have very high drift during warm-up. A stable amplifier gives drift results in the DASY6 system below ± 0.02 dB.

b. The second step is optional. For probes with integrated optical surface detection sensor this step must be conducted, otherwise the step can be skipped. The Surface Check tests the optical surface detection system of the DASY6 system by repeatedly detecting the surface with the optical and mechanical surface detector and comparing the results. The output gives the detecting heights of both systems, the difference between the two systems and the standard deviation of the detection repeatability. Air bubbles or refraction in the liquid due to separation of the sugar-water mixture gives poor repeatability (above ± 0.1 mm). In that case it is better to abort the system check and stir the liquid.

c. The Area Scan measures the SAR above the dipole on a plane parallel to the surface. It is used to locate the approximate location of the peak SAR. The proposed scan uses large grid spacing for faster measurement; due to the symmetric field, the peak detection is reliable. If a finer graphic is desired, the grid spacing can be reduced. Grid spacing and orientation have no influence on the SAR result.

d. The Zoom Scan measures the field in a volume around the peak SAR value assessed in the previous Area Scan.

If the system check gives reasonable results, the SAR peak, 1 g and 10 g spatial average SAR values normalized to 1 W dipole input power give reference data for comparisons. The next sections analyze the expected uncertainties of these values, as well as additional checks for further information or troubleshooting.

■ Result of System Performance Check

Freq. (MHz)	1g SAR (W/kg)	10g SAR (W/kg)	Target 1g SAR (W/kg)	Target 10g SAR (W/kg)	Deviation 1g SAR (%)	Deviation 10g SAR (%)	Tissue Temp.	Test Date
2450	50.40	24.04	53.00	24.70	-4.91	-2.67	22.5°C	2024.07.12
5250	80.30	23.30	76.90	21.80	4.42	6.88	22.5°C	2024.07.15
5600	83.00	23.80	79.90	22.60	3.88	5.31	22.5°C	2024.07.16
5750	80.40	23.20	76.90	21.50	4.55	7.91	22.5°C	2024.07.16
6500	305.00	57.90	291.00	53.30	4.81	8.63	22.5°C	2024.07.17

Notes:

1. The $\pm 10\%$ deviation of system check result is required.
2. System check value listed above has been harmonized to 1W.

6.3. PD System Check

■ System Check Diagram

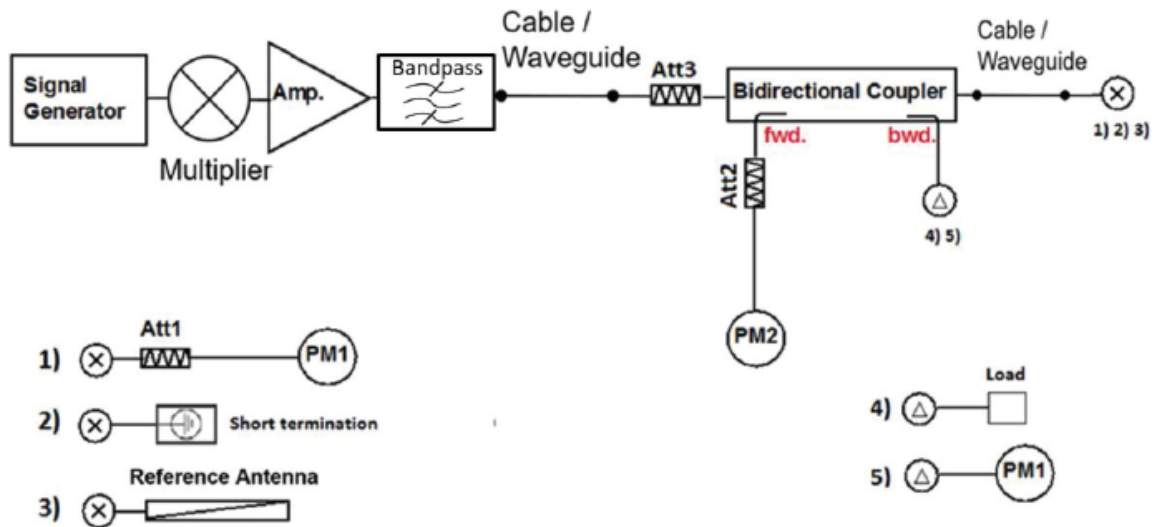

■ Result of System Performance Check

Freq. (GHz)	Measured PD averaged over 4 cm ² (W/m ²)	Target PD averaged over 4 cm ² (W/m ²)	Deviation (%)	Test Date
10	165	180	-8.33	2024.07.18

Note: The $\pm 14\%$ deviation of system check result is required.

7. Analysis and Results

7.1. Antenna Location

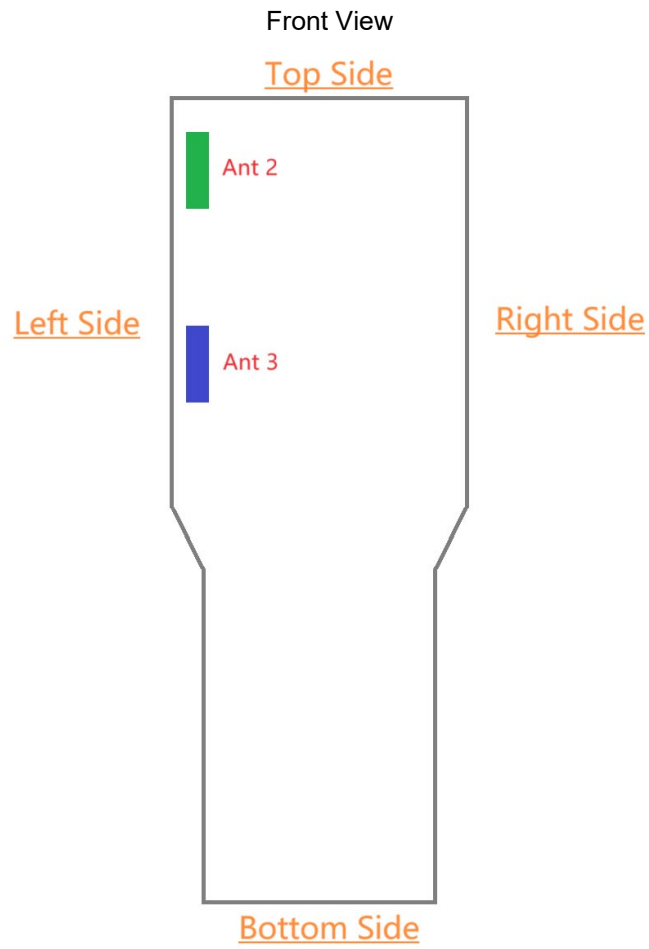

7.2. Conducted Power

■ DTS Band Wi-Fi

Mode	CH.	Freq. (MHz)	ANT 3 Average Power (dBm)	ANT3 Max. Tune-up Power (dBm)	ANT 2 Average Power (dBm)	ANT2 Max. Tune-up Power (dBm)	Total Average Power (dBm)	Total Max. Tune-up Power (dBm)	Duty Cycle %
b	1	2412	17.83	18.0	18.50	19.0	21.19	21.5	98.14
	6	2437	17.32	17.5	17.95	18.5	20.66	21.0	
	11	2462	17.93	18.5	17.95	18.5	20.95	21.5	
g	1	2412	15.72	16.0	16.64	17.0	19.21	19.5	99.29
	6	2437	16.31	16.5	16.86	17.0	19.60	20.0	
	11	2462	16.07	16.5	16.93	17.5	19.53	20.0	
n-HT20	1	2412	15.68	16.0	16.69	17.0	19.22	19.5	98.45
	6	2437	16.28	16.5	16.86	17.0	19.59	20.0	
	11	2462	16.07	16.5	16.83	17.0	19.48	20.0	
n-HT40	3	2422	16.74	17.0	16.98	17.5	19.87	20.0	98.12
	6	2437	16.16	16.5	16.93	17.5	19.57	20.0	
	9	2452	16.07	16.5	16.73	17.0	19.42	20.0	
ax-HE20	1	2412	15.63	16.0	16.63	17.0	19.17	19.5	99.73
	6	2437	16.21	16.5	16.85	17.0	19.55	20.0	
	11	2462	16.01	16.5	16.81	17.0	19.44	20.0	
ax-HE40	3	2422	16.62	17.0	16.86	17.0	19.75	20.0	99.74
	6	2437	16.07	16.5	16.89	17.5	19.51	20.0	
	9	2452	15.87	16.0	16.54	17.0	19.23	19.5	
VHT20	1	2412	15.63	16.0	16.64	17.0	19.17	19.5	99.69
	6	2437	16.04	16.5	16.78	17.0	19.44	20.0	
	11	2462	16.05	16.5	16.84	17.0	19.47	20.0	
VHT40	3	2422	16.73	17.0	16.92	17.5	19.84	20.0	99.72
	6	2437	16.23	16.5	16.91	17.5	19.59	20.0	
	9	2452	16.11	16.5	16.73	17.0	19.44	20.0	

■ U-NII-1 Band Wi-Fi

Mode	CH.	Freq. (MHz)	ANT 3 Average Power (dBm)	ANT3 Max. Tune-up Power (dBm)	ANT 2 Average Power (dBm)	ANT2 Max. Tune-up Power (dBm)	Total Average Power (dBm)	Total Max. Tune-up Power (dBm)	Duty Cycle %
a	36	5180	15.16	15.5	15.72	16.0	18.46	19.0	99.29
	44	5220	15.41	16.0	15.73	16.0	18.58	19.0	
	48	5240	15.90	16.5	15.85	16.0	18.89	19.5	
ac-VHT20	36	5180	15.22	15.5	15.70	16.0	18.48	19.0	99.69
	44	5220	15.43	16.0	15.71	16.0	18.58	19.0	
	48	5240	15.88	16.0	15.87	16.0	18.89	19.5	
ac-VHT40	38	5190	13.05	13.5	13.72	14.0	16.41	17.0	99.69
	46	5230	15.52	16.0	15.56	16.0	18.55	19.0	
ac-VHT80	42	5210	15.30	15.5	15.56	16.0	18.44	19.0	99.72
ax-HE20	36	5180	13.02	13.5	13.65	14.0	16.36	16.5	99.71
	44	5220	13.73	14.0	13.93	14.5	16.84	17.0	
	48	5240	13.66	14.0	13.63	14.0	16.66	17.0	
ax-HE40	38	5190	13.52	14.0	13.82	14.0	16.68	17.0	99.67
	46	5230	13.71	14.0	13.90	14.5	16.82	17.0	
ax-HE80	42	5210	13.76	14.0	13.98	14.5	16.88	17.0	99.71

■ U-NII-2A Band Wi-Fi

Mode	CH.	Freq. (MHz)	ANT 3 Average Power (dBm)	ANT3 Max. Tune-up Power (dBm)	ANT 2 Average Power (dBm)	ANT2 Max. Tune-up Power (dBm)	Total Average Power (dBm)	Total Max. Tune-up Power (dBm)	Duty Cycle %
a	52	5260	15.87	16.0	15.83	16.0	18.86	19.0	99.29
	60	5300	15.98	16.5	15.01	15.5	18.53	19.0	
	64	5320	14.08	14.5	12.49	13.0	16.37	16.5	
ac-VHT20	52	5260	15.93	16.5	15.85	16.0	18.90	19.5	99.69
	60	5300	15.70	16.0	14.47	15.0	18.14	18.5	
	64	5320	15.66	16.0	14.45	15.0	18.11	18.5	
ac-VHT40	54	5270	15.98	16.5	15.60	16.0	18.80	19.0	99.69
	62	5310	14.12	14.5	11.98	12.5	16.19	16.5	
ac-VHT80	58	5290	12.80	13.0	12.06	12.5	15.46	16.0	99.72
ax-HE20	52	5260	13.61	14.0	12.82	13.0	16.24	16.5	99.71
	60	5300	13.72	14.0	11.39	12.0	15.72	16.0	
	64	5320	13.70	14.0	11.41	12.0	15.71	16.0	
ax-HE40	54	5270	13.85	14.0	13.49	14.0	16.68	17.0	99.67
	62	5310	13.68	14.0	11.48	12.0	15.73	16.0	
ax-HE80	58	5290	13.04	13.5	12.19	12.5	15.65	16.0	99.71

■ U-NII-2C Band Wi-Fi

Mode	CH.	Freq. (MHz)	ANT 3 Average Power (dBm)	ANT3 Max. Tune-up Power (dBm)	ANT 2 Average Power (dBm)	ANT2 Max. Tune-up Power (dBm)	Total Average Power (dBm)	Total Max. Tune-up Power (dBm)	Duty Cycle %
a	100	5500	15.76	16.0	14.82	15.0	18.33	18.5	99.29
	116	5580	15.96	16.5	14.52	15.0	18.31	18.5	
	140	5700	15.71	16.0	14.16	14.5	18.01	18.5	
	144	5720	15.69	16.0	14.16	14.5	18.00	18.5	
ac-VHT20	100	5500	15.98	16.5	15.13	15.5	18.59	19.0	99.69
	116	5580	15.95	16.5	14.49	15.0	18.29	18.5	
	140	5700	15.72	16.0	14.13	14.5	18.01	18.5	
	144	5720	15.70	16.0	14.15	14.5	18.00	18.5	
ac-VHT40	102	5510	14.52	15.0	13.26	13.5	16.95	17.5	99.69
	110	5550	15.69	16.0	14.49	15.0	18.14	18.5	
	134	5670	15.97	16.5	15.06	15.5	18.55	19.0	
	142	5710	15.96	16.5	14.35	14.5	18.24	18.5	
ac-VHT80	106	5530	15.58	16.0	14.38	14.5	18.03	18.5	99.72
	122	5610	15.89	16.5	15.12	15.5	18.53	19.0	
	138	5690	15.77	16.0	13.48	14.0	17.78	18.0	
ax-HE20	100	5500	13.66	14.0	11.73	12.0	15.81	16.0	99.71
	116	5580	13.58	14.0	11.77	12.0	15.78	16.0	
	140	5700	13.60	14.0	11.15	11.5	15.56	16.0	
	144	5720	13.61	14.0	11.66	12.0	15.75	16.0	
ax-HE40	102	5510	13.55	14.0	12.21	12.5	15.94	16.5	99.67
	110	5550	13.60	14.0	12.12	12.5	15.93	16.5	
	134	5670	13.93	14.5	12.00	12.5	16.08	16.5	
	142	5710	13.52	14.0	11.21	11.5	15.53	16.0	
ax-HE80	106	5530	13.77	14.0	12.19	12.5	16.06	16.5	99.71
	122	5610	13.95	14.5	12.59	13.0	16.33	16.5	
	138	5690	13.93	14.5	11.80	12.0	16.00	16.5	

■ U-NII-3 Band Wi-Fi

Mode	CH.	Freq. (MHz)	ANT 3 Average Power (dBm)	ANT3 Max. Tune-up Power (dBm)	ANT 2 Average Power (dBm)	ANT2 Max. Tune-up Power (dBm)	Total Average Power (dBm)	Total Max. Tune-up Power (dBm)	Duty Cycle %
a	149	5745	15.82	16.0	13.79	14.0	17.93	18.5	99.29
	157	5785	15.81	16.0	14.25	14.5	18.11	18.5	
	165	5825	15.76	16.0	13.72	14.0	17.87	18.0	
ac-VHT20	149	5745	15.82	16.0	13.89	14.5	17.97	18.5	99.69
	157	5785	15.78	16.0	14.23	14.5	18.08	18.5	
	165	5825	15.71	16.0	13.78	14.0	17.86	18.0	
ac-VHT40	151	5755	15.78	16.0	14.55	15.0	18.22	18.5	99.69
	159	5795	15.89	16.5	14.45	15.0	18.24	18.5	
ac-VHT80	155	5775	15.56	16.0	14.31	14.5	17.99	18.5	99.72
ax-HE20	149	5745	13.85	14.0	11.97	12.5	16.02	16.5	99.71
	157	5785	13.56	14.0	11.31	11.5	15.59	16.0	
	165	5825	13.84	14.0	12.01	12.5	16.03	16.5	
ax-HE40	151	5755	13.84	14.0	12.41	13.0	16.19	16.5	99.67
	159	5795	13.54	14.0	11.41	12.0	15.61	16.0	
ax-HE80	155	5775	13.93	14.5	12.42	13.0	16.25	16.5	99.71

■ U-NII-5&6&7&8 Band Wi-Fi

Mode	CH.	Freq. (MHz)	ANT 3 Average Power (dBm)	ANT3 Max. Tune-up Power (dBm)	ANT 2 Average Power (dBm)	ANT2 Max. Tune-up Power (dBm)	Total Average Power (dBm)	Total Max. Tune-up Power (dBm)	Duty Cycle %
ax-HE20	1	5955	-3.29	-3.0	-3.49	-3.0	-0.38	0.0	99.67
	49	6195	-3.69	-3.5	-2.58	-2.0	-0.09	0.5	
	93	6415	-5.01	-4.5	-2.77	-2.5	-0.74	-0.5	
	97	6435	-2.45	-2.0	-0.87	-0.5	1.42	2.0	
	105	6475	-1.81	-1.5	-0.69	-0.5	1.80	2.0	
	113	6515	-1.67	-1.5	-0.87	-0.5	1.76	2.0	
	117	6535	-1.15	-1.0	-1.95	-1.5	1.48	2.0	
	149	6695	-1.22	-1.0	-1.21	-1.0	1.80	2.0	
	181	6855	-1.06	-0.5	-1.71	-1.5	1.64	2.0	
	185	6875	-1.13	-1.0	-1.55	-1.0	1.68	2.0	
	189	6895	-0.76	-0.5	-0.49	0.0	2.39	2.5	
	209	6995	-0.67	-0.5	-0.30	0.0	2.53	3.0	
	229	7095	-1.12	-1.0	-0.59	0.0	2.16	2.5	
233	7115	-1.23	-1.0	-1.05	-0.5	1.87	2.0		
ax-HE40	3	5965	-0.25	0.0	-0.46	0.0	2.66	3.0	99.71
	51	6205	-0.62	-0.5	0.42	1.0	2.94	3.5	
	91	6405	-0.86	-0.5	0.43	1.0	2.84	3.0	
	99	6445	1.11	1.5	2.42	3.0	4.82	5.0	
	107	6485	0.94	1.5	2.35	2.5	4.71	5.0	
	115	6525	1.36	1.5	2.11	2.5	4.76	5.0	
	123	6565	1.31	1.5	1.28	1.5	4.31	4.5	
	147	6685	1.95	2.5	1.87	2.0	4.92	5.5	
	179	6845	1.87	2.0	0.96	1.5	4.45	5.0	
	187	6885	2.32	2.5	0.82	1.0	4.64	5.0	
	195	6925	2.89	3.5	2.21	2.5	5.57	6.0	
	211	7005	2.56	3.0	2.45	3.0	5.52	6.0	
227	7085	2.18	2.5	2.17	2.5	5.19	5.5		

<Continue>

ax-HE80	7	5985	2.57	3.0	2.13	2.5	5.37	5.5	99.67
	55	6225	2.72	3.0	3.89	4.5	6.35	6.5	
	87	6385	1.96	2.5	3.41	4.0	5.76	6.0	
	103	6465	4.52	5.0	4.52	5.0	7.53	8.0	
	119	6545	4.82	5.0	2.87	3.0	6.96	7.5	
	135	6625	5.23	5.5	2.94	3.5	7.24	7.5	
	151	6705	4.92	5.5	3.38	3.5	7.23	7.5	
	167	6785	5.06	5.5	2.71	3.0	7.05	7.5	
	183	6865	5.69	6.0	2.67	3.0	7.45	8.0	
	199	6945	6.58	7.0	4.23	4.5	8.57	9.0	
	215	7025	5.72	6.0	3.83	4.0	7.89	8.5	
ax-HE160	15	6025	5.96	6.5	4.52	5.0	8.31	8.5	99.74
	47	6185	5.72	6.0	4.83	5.0	8.31	8.5	
	79	6345	5.55	6.0	4.96	5.5	8.28	8.5	
	111	6505	6.26	6.5	6.61	7.0	9.45	10.0	
	143	6665	7.53	8.0	5.13	5.5	9.50	10.0	
	175	6825	7.58	8.0	5.83	6.0	9.80	10.0	
	207	6985	7.66	8.0	6.71	7.0	10.22	10.5	

■ Bluetooth

Mode	CH.	Freq. (MHz)	Average Power (dBm)	Max. Tune-up Power (dBm)	Duty Cycle %
DH5	0	2402	7.42	8.0	76.74
	39	2441	6.84	7.0	
	78	2480	8.42	9.0	
2DH5	0	2402	8.07	8.5	77.07
	39	2441	9.04	9.5	
	78	2480	9.05	9.5	
3DH5	0	2402	7.82	8.0	76.80
	39	2441	8.10	8.5	
	78	2480	8.67	9.0	
BLE_1M	0	2402	7.60	8.0	62.15
	19	2440	7.13	7.5	
	39	2480	5.80	6.0	
BLE_2M	0	2402	7.66	8.0	32.85
	19	2440	7.17	7.5	
	39	2480	5.83	6.0	
BLE_S2	0	2402	7.62	8.0	62.15
	19	2440	7.20	7.5	
	39	2480	5.88	6.0	
BLE_S8	0	2402	7.67	8.0	32.85
	19	2440	7.18	7.5	
	39	2480	5.69	6.0	

7.3. Body-worn SAR Test Results

General notes:

1. When the highest reported SAR for DSSS is adjusted by the ratio of OFDM to DSSS specified maximum output power and the adjusted SAR is ≤ 1.2 W/kg, 802.11g/n OFDM SAR is not required, per KDB248227 D01 v02r02 section 5.2.2 b).
2. For devices that operate in both U-NII bands using the same transmitter and antenna(s), SAR test reduction is determined according to the following, per KDB248227 D01 v02r02 section 5.3.1:
 - a) When the same maximum output power is specified for both bands, begin SAR measurement in U-NII-2A band by applying the OFDM SAR requirements. If the highest reported SAR for a test configuration is ≤ 1.2 W/kg, SAR is not required for U-NII-1 band for that configuration (802.11 mode and exposure condition); otherwise, each band is tested independently for SAR.
 - b) When different maximum output power is specified for the bands, begin SAR measurement in the band with higher specified maximum output power. The highest reported SAR for the tested configuration is adjusted by the ratio of lower to higher specified maximum output power for the two bands. When the adjusted SAR is ≤ 1.2 W/kg, SAR is not required for the band with lower maximum output power in that test configuration; otherwise, each band is tested independently for SAR.
3. When multiple transmission modes (802.11a/g/n/ac) have the same specified maximum output power, largest channel bandwidth, lowest order modulation and lowest data rate, the lowest order 802.11 mode is selected; i.e., 802.11a is chosen over 802.11n then 802.11ac or 802.11g is chosen over 802.11n, per KDB248227 D01 v02r02 section 5.3.2.
4. When the highest reported SAR for the initial test configuration (when applicable, include subsequent highest output channels), according to the initial test position or fixed exposure position requirements, is adjusted by the ratio of the subsequent test configuration to initial test configuration specified maximum output power and the adjusted SAR is ≤ 1.2 W/kg, SAR is not required for that subsequent test configuration, per KDB248227 D01 v02r02 section 5.3.4 b).
5. When the original highest measured SAR is ≥ 0.80 W/kg, only one repeated measurement is required, if the measured SAR value of the initial repeated measurement is < 1.45 W/kg with $\leq 20\%$ variation, per KDB 865664 D01 v01r04 section 2.8.1.
6. Per KDB 447498 D04 v01 section 4.4.3 a), testing of other required channels within the operating mode of a frequency band is not required when the reported 1-g or 10-g SAR for the mid-band or highest output power channel is ≤ 0.8 W/kg or 2.0 W/kg, for 1-g or 10-g respectively, when the transmission band is ≤ 100 MHz.
7. For Front / Back positions, there are two definitive hotspots correspond to two antennas, we zoom scan each hotspot individually.

■ Ant 3

Band	Mode	CH.	Freq. (MHz)	Test Position	Dist. (mm)	Cond. Power (dBm)	Tune-up Power (dBm)	Scaling Factor	Duty Cycle %	Duty Cycle Factor	Meas. SAR-1g (W/kg)	Reported SAR-1g (W/kg)	SAR Plot #
DTS	b	1	2412	Front	5	17.83	18.0	1.04	98.14	1.02	0.05	0.05	
				Back	5	17.83	18.0	1.04	98.14	1.02	0.16	0.17	
				Back*	5	17.83	18.0	1.04	98.14	1.02	0.21	0.22	1
U-NII-1	a	48	5240	Front	5	15.90	16.5	1.15	99.29	1.01	0.03	0.03	
				Back	5	15.90	16.5	1.15	99.29	1.01	0.18	0.21	
				Back*	5	15.90	16.5	1.15	99.29	1.01	0.29	0.34	2
U-NII-2A	ac-VHT20	52	5260	Front	5	15.93	16.5	1.14	99.69	1.00	0.03	0.03	
				Back	5	15.93	16.5	1.14	99.69	1.00	0.24	0.27	
				Back*	5	15.93	16.5	1.14	99.69	1.00	0.27	0.31	3
U-NII-2C	ac-VHT20	100	5500	Front	5	15.98	16.5	1.13	99.69	1.00	0.09	0.10	
				Back	5	15.98	16.5	1.13	99.69	1.00	0.25	0.28	
				Back*	5	15.98	16.5	1.13	99.69	1.00	0.39	0.44	4
U-NII-3	ac-VHT40	159	5795	Front	5	15.89	16.5	1.15	99.69	1.00	0.11	0.13	
				Back	5	15.89	16.5	1.15	99.69	1.00	0.26	0.30	5
				Back*	5	15.89	16.5	1.15	99.69	1.00	0.18	0.21	
BT	2DH5	78	2480	Front	5	9.05	9.5	1.11	77.07	1.30	0.01	0.01	
				Back	5	9.05	9.5	1.11	77.07	1.30	0.02	0.03	7
				Back*	5	9.05	9.5	1.11	77.07	1.30	0.02	0.03	

Note: " * ", SAR worst-case retest with Sample 2#.

Band	Mode	CH.	Freq. (MHz)	Test Position	Dist. (mm)	Cond. Power (dBm)	Tune-up Power (dBm)	Scaling Factor	Duty Cycle %	Duty Cycle Factor	Meas. SAR-1g (W/kg)	Reported SAR-1g (W/kg)	Meas. APD-4cm ² , sq (W/m ²)	Reported APD-4cm ² , sq (W/m ²)	SAR Plot #
U-NII-5&6&7 &8	ax-HE 160	15	6025	Back	5	5.96	6.5	1.13	99.74	1.00	0.04	0.05	0.33	0.37	
		47	6185	Back	5	5.72	6.0	1.07	99.74	1.00	0.06	0.06	0.49	0.52	6
		47	6185	Back*	5	5.72	6.0	1.07	99.74	1.00	0.06	0.04	0.49	0.35	
		111	6505	Back	5	6.26	6.5	1.06	99.74	1.00	0.04	0.04	0.41	0.43	
		175	6825	Back	5	7.58	8.0	1.10	99.74	1.00	0.04	0.04	0.36	0.40	
		207	6985	Front	5	7.66	8.0	1.08	99.74	1.00	0.01	0.01	0.01	0.01	
				Back	5	7.66	8.0	1.08	99.74	1.00	0.05	0.05	0.43	0.47	

Note: " * ", SAR worst-case retest with Sample 2#.

■ Ant 2

Band	Mode	CH.	Freq. (MHz)	Test Position	Dist. (mm)	Cond. Power (dBm)	Tune-up Power (dBm)	Scaling Factor	Duty Cycle %	Duty Cycle Factor	Meas. SAR-1g (W/kg)	Reported SAR-1g (W/kg)	SAR Plot #
DTS	b	1	2412	Front	5	18.50	19.0	1.12	98.14	1.02	0.19	0.22	
				Front*	5	18.50	19.0	1.12	98.14	1.02	0.33	0.38	8
				Back	5	18.50	19.0	1.12	98.14	1.02	0.08	0.09	
U-NII-1	a	36	5180	Back	5	15.72	16.0	1.07	99.29	1.01	0.61	0.66	
		44	5220	Back	5	15.73	16.0	1.06	99.29	1.01	0.67	0.72	
		48	5240	Front	5	15.85	16.0	1.04	99.29	1.01	0.16	0.17	
				Back	5	15.85	16.0	1.04	99.29	1.01	0.80	0.83	9
				Back**	5	15.85	16.0	1.04	99.29	1.01	0.76	0.79	
				Back*	5	15.85	16.0	1.04	99.29	1.01	0.32	0.33	
U-NII-2A	ac-VHT20	52	5260	Front	5	15.85	16.0	1.04	99.69	1.00	0.17	0.18	
				Back	5	15.85	16.0	1.04	99.69	1.00	0.79	0.82	10
				Back*	5	15.85	16.0	1.04	99.69	1.00	0.31	0.32	
		60	5300	Back	5	14.47	15.0	1.13	99.69	1.00	0.65	0.74	
		64	5320	Back	5	14.45	15.0	1.14	99.69	1.00	0.66	0.75	
U-NII-2C	ac-VHT20	100	5500	Front	5	15.13	15.5	1.09	99.69	1.00	0.10	0.11	
				Back	5	15.13	15.5	1.09	99.69	1.00	0.45	0.49	
				Back*	5	15.13	15.5	1.09	99.69	1.00	0.47	0.51	11
U-NII-3	ac-VHT40	159	5795	Front	5	14.45	15.0	1.14	99.69	1.00	0.08	0.09	
				Back	5	14.45	15.0	1.14	99.69	1.00	0.41	0.47	12
				Back*	5	14.45	15.0	1.14	99.69	1.00	0.32	0.36	

Notes:

1. “*”, SAR worst-case retest with Sample 2#.
2. “**”, repeated SAR measurement.

Band	Mode	CH.	Freq. (MHz)	Test Position	Dist. (mm)	Cond. Power (dBm)	Tune-up Power (dBm)	Scaling Factor	Duty Cycle %	Duty Cycle Factor	Meas. SAR-1g (W/kg)	Reported SAR-1g (W/kg)	Meas. APD-4cm ² , sq (W/m ²)	Reported APD-4cm ² , sq (W/m ²)	SAR Plot #
U-NII-5&6&7 &8	ax-HE 160	15	6025	Back	5	4.52	5.0	1.12	99.74	1.00	0.06	0.07	0.50	0.56	
		47	6185	Back	5	4.83	5.0	1.04	99.74	1.00	0.06	0.06	0.49	0.51	
		111	6505	Back	5	6.61	7.0	1.09	99.74	1.00	0.06	0.07	0.51	0.56	
		175	6825	Back	5	5.83	6.0	1.04	99.74	1.00	0.08	0.08	0.60	0.63	
		207	6985	Front	5	6.71	7.0	1.07	99.74	1.00	0.01	0.01	0.06	0.06	
				Back	5	6.71	7.0	1.07	99.74	1.00	0.10	0.11	0.67	0.72	13
				Back*	5	6.71	7.0	1.07	99.74	1.00	0.08	0.09	0.60	0.64	

Note: " * ", SAR worst-case retest with Sample 2#.

7.4. Extremity SAR Test Results

General notes:

1. When the highest reported SAR for DSSS is adjusted by the ratio of OFDM to DSSS specified maximum output power and the adjusted SAR is ≤ 3.0 W/kg, 802.11g/n OFDM SAR is not required, per KDB248227 D01 v02r02 section 5.2.2 b).
2. For devices that operate in both U-NII bands using the same transmitter and antenna(s), SAR test reduction is determined according to the following, per KDB248227 D01 v02r02 section 5.3.1:
 - a) When the same maximum output power is specified for both bands, begin SAR measurement in U-NII-2A band by applying the OFDM SAR requirements. If the highest reported SAR for a test configuration is ≤ 1.2 W/kg, SAR is not required for U-NII-1 band for that configuration (802.11 mode and exposure condition); otherwise, each band is tested independently for SAR.
 - b) When different maximum output power is specified for the bands, begin SAR measurement in the band with higher specified maximum output power. The highest reported SAR for the tested configuration is adjusted by the ratio of lower to higher specified maximum output power for the two bands. When the adjusted SAR is ≤ 3.0 W/kg, SAR is not required for the band with lower maximum output power in that test configuration; otherwise, each band is tested independently for SAR.
3. When multiple transmission modes (802.11a/g/n/ac) have the same specified maximum output power, largest channel bandwidth, lowest order modulation and lowest data rate, the lowest order 802.11 mode is selected; i.e., 802.11a is chosen over 802.11n then 802.11ac or 802.11g is chosen over 802.11n, per KDB248227 D01 v02r02 section 5.3.2.
4. When the highest reported SAR for the initial test configuration (when applicable, include subsequent highest output channels), according to the initial test position or fixed exposure position requirements, is adjusted by the ratio of the subsequent test configuration to initial test configuration specified maximum output power and the adjusted SAR is 3.0 W/kg, SAR is not required for that subsequent test configuration, per KDB248227 D01 v02r02 section 5.3.4 b).
5. When the original highest measured SAR is ≥ 2.0 W/kg, only one repeated measurement is required, if the measured SAR value of the initial repeated measurement is < 3.625 W/kg with $\leq 20\%$ variation, per KDB 865664 D01 v01r04 section 2.8.1.
6. Per KDB 447498 D04 v01 section 4.4.3 a), testing of other required channels within the operating mode of a frequency band is not required when the reported 1-g or 10-g SAR for the mid-band or highest output power channel is ≤ 0.8 W/kg or 2.0 W/kg, for 1-g or 10-g respectively, when the transmission band is ≤ 100 MHz.
7. For Front / Back / Back_Left / Back_Right / Left / Right /positions, there are two definitive hotspots correspond to two antennas, we zoom scan each hotspot individually; for Top / Bottom positions, two antenna hotspots are overlapping, so we take it as the result of both antennas and it is also the result of simultaneous transmissions.

■ Ant 3

Band	Mode	CH.	Freq. (MHz)	Test Position	Dist. (mm)	Cond. Power (dBm)	Tune-up Power (dBm)	Scaling Factor	Duty Cycle %	Duty Cycle Factor	Meas. SAR-10g (W/kg)	Reported SAR-10g (W/kg)	SAR Plot #
DTS	b	1	2412	Front	0	17.83	18.0	1.04	98.14	1.02	0.05	0.05	
				Back	0	17.83	18.0	1.04	98.14	1.02	0.09	0.10	
				Back_Left	0	17.83	18.0	1.04	98.14	1.02	1.29	1.37	
				Back_Right	0	17.83	18.0	1.04	98.14	1.02	0.02	0.02	
				Left	0	17.83	18.0	1.04	98.14	1.02	2.19	2.32	14
				Left*	0	17.83	18.0	1.04	98.14	1.02	1.45	1.54	
				Right	0	17.83	18.0	1.04	98.14	1.02	0.02	0.02	
				Top	0	17.83	18.0	1.04	98.14	1.02	0.18	0.19	
				Bottom	0	17.83	18.0	1.04	98.14	1.02	0.02	0.02	
		6	2437	Left	0	17.32	17.5	1.04	98.14	1.02	2.10	2.23	
		11	2462	Left	0	17.93	18.5	1.14	98.14	1.02	1.85	2.15	
U-NII-1	a	36	5180	Left	0	15.16	15.5	1.08	99.29	1.01	1.27	1.38	
		44	5220	Left	0	15.41	16.0	1.15	99.29	1.01	1.54	1.78	
		48	5240	Front	0	15.90	16.5	1.15	99.29	1.01	0.12	0.14	
				Back	0	15.90	16.5	1.15	99.29	1.01	0.13	0.15	
				Back_Left	0	15.90	16.5	1.15	99.29	1.01	0.89	1.03	
				Back_Right	0	15.90	16.5	1.15	99.29	1.01	0.06	0.07	
				Left	0	15.90	16.5	1.15	99.29	1.01	2.01	2.32	15
				Left**	0	15.90	16.5	1.15	99.29	1.01	1.97	2.28	
				Left*	0	15.90	16.5	1.15	99.29	1.01	1.49	1.72	
				Right	0	15.90	16.5	1.15	99.29	1.01	0.05	0.06	
				Top	0	15.90	16.5	1.15	99.29	1.01	0.17	0.20	
Bottom	0	15.90	16.5	1.15	99.29	1.01	0.01	0.01					

<Continue>

U-NII-2A	ac-VHT20	52	5260	Front	0	15.93	16.5	1.14	99.69	1.00	0.12	0.14	
				Back	0	15.93	16.5	1.14	99.69	1.00	0.13	0.15	
				Back_Left	0	15.93	16.5	1.14	99.69	1.00	0.58	0.66	
				Back_Right	0	15.93	16.5	1.14	99.69	1.00	0.06	0.07	
				Left	0	15.93	16.5	1.14	99.69	1.00	1.84	2.10	16
				Left*	0	15.93	16.5	1.14	99.69	1.00	1.28	1.46	
				Right	0	15.93	16.5	1.14	99.69	1.00	0.06	0.07	
				Top	0	15.93	16.5	1.14	99.69	1.00	0.17	0.19	
				Bottom	0	15.93	16.5	1.14	99.69	1.00	0.01	0.01	
				60	5300	Left	0	15.70	16.0	1.07	99.69	1.00	1.65
		64	5320	Left	0	15.66	16.0	1.08	99.69	1.00	1.58	1.71	
U-NII-2C	ac-VHT20	100	5500	Front	0	15.98	16.5	1.13	99.69	1.00	0.09	0.10	
				Back	0	15.98	16.5	1.13	99.69	1.00	0.14	0.16	
				Back_Left	0	15.98	16.5	1.13	99.69	1.00	0.97	1.10	
				Back_Right	0	15.98	16.5	1.13	99.69	1.00	0.05	0.06	
				Left	0	15.98	16.5	1.13	99.69	1.00	1.48	1.67	17
				Left*	0	15.98	16.5	1.13	99.69	1.00	1.23	1.39	
				Right	0	15.98	16.5	1.13	99.69	1.00	0.02	0.02	
				Top	0	15.98	16.5	1.13	99.69	1.00	0.10	0.11	
				Bottom	0	15.98	16.5	1.13	99.69	1.00	0.01	0.01	
U-NII-3	ac-VHT40	151	5755	Left*	0	15.78	16.0	1.05	99.69	1.00	2.14	2.26	
		159	5795	Front	0	15.89	16.5	1.15	99.69	1.00	0.09	0.10	
				Back	0	15.89	16.5	1.15	99.69	1.00	0.15	0.17	
				Back_Left	0	15.89	16.5	1.15	99.69	1.00	1.05	1.21	
				Back_Right	0	15.89	16.5	1.15	99.69	1.00	0.09	0.10	
				Left	0	15.89	16.5	1.15	99.69	1.00	1.72	1.99	
				Left*	0	15.89	16.5	1.15	99.69	1.00	2.17	2.51	18
				Left**	0	15.89	16.5	1.15	99.69	1.00	2.13	2.46	
				Right	0	15.89	16.5	1.15	99.69	1.00	0.02	0.02	
				Top	0	15.89	16.5	1.15	99.69	1.00	0.08	0.09	
Bottom	0	15.89	16.5	1.15	99.69	1.00	0.01	0.01					

<Continue>

BT	2DH5	78	2480	Front	0	9.05	9.5	1.11	77.07	1.30	0.01	0.01	
				Back	0	9.05	9.5	1.11	77.07	1.30	0.02	0.03	
				Back_Left	0	9.05	9.5	1.11	77.07	1.30	0.19	0.27	
				Back_Right	0	9.05	9.5	1.11	77.07	1.30	0.01	0.01	
				Left	0	9.05	9.5	1.11	77.07	1.30	0.22	0.32	20
				Left*	0	9.05	9.5	1.11	77.07	1.30	0.14	0.20	
				Right	0	9.05	9.5	1.11	77.07	1.30	0.01	0.01	
				Top	0	9.05	9.5	1.11	77.07	1.30	0.01	0.01	
				Bottom	0	9.05	9.5	1.11	77.07	1.30	0.01	0.01	

Notes:

1. " * ", SAR worst-case retest with Sample 2#.
2. " * * ", repeated SAR measurement.

Band	Mode	CH.	Freq. (MHz)	Test Position	Dist. (mm)	Cond. Power (dBm)	Tune-up Power (dBm)	Scaling Factor	Duty Cycle %	Duty Cycle Factor	Meas. SAR-10g (W/kg)	Reported SAR-10g (W/kg)	Meas. APD-4cm ² , sq (W/m ²)	Reported APD-4cm ² , sq (W/m ²)	SAR Plot #
U-NII-5&6&7 &8	ax-HE 160	15	6025	Left	0	5.96	6.5	1.13	99.74	1.00	0.17	0.19	3.95	4.48	
		47	6185	Left	0	5.72	6.0	1.07	99.74	1.00	0.17	0.18	4.09	4.37	
		111	6505	Left	0	6.26	6.5	1.06	99.74	1.00	0.30	0.32	7.08	7.50	
		175	6825	Left	0	7.58	8.0	1.10	99.74	1.00	0.30	0.33	7.07	7.81	
		207	6985	Front	0	7.66	8.0	1.08	99.74	1.00	0.02	0.02	0.38	0.41	
				Back	0	7.66	8.0	1.08	99.74	1.00	0.01	0.01	0.27	0.29	
				Back_Left	0	7.66	8.0	1.08	99.74	1.00	0.11	0.12	2.59	2.81	
				Back_Right	0	7.66	8.0	1.08	99.74	1.00	0.01	0.01	0.16	0.17	
				Left	0	7.66	8.0	1.08	99.74	1.00	0.31	0.34	7.25	7.86	19
				Left*	0	7.66	8.0	1.08	99.74	1.00	0.24	0.26	5.69	6.17	
				Right	0	7.66	8.0	1.08	99.74	1.00	0.01	0.01	0.10	0.11	
				Top	0	7.66	8.0	1.08	99.74	1.00	0.01	0.01	0.12	0.13	
		Bottom	0	7.66	8.0	1.08	99.74	1.00	0.01	0.01	0.04	0.04			

Note: " * ", SAR worst-case retest with Sample 2#.

■ Ant 2

Band	Mode	CH.	Freq. (MHz)	Test Position	Dist. (mm)	Cond. Power (dBm)	Tune-up Power (dBm)	Scaling Factor	Duty Cycle %	Duty Cycle Factor	Meas. SAR-10g (W/kg)	Reported SAR-10g (W/kg)	SAR Plot #
DTS	b	1	2412	Front	0	18.50	19.0	1.12	98.14	1.02	0.18	0.21	
				Back	0	18.50	19.0	1.12	98.14	1.02	0.08	0.09	
				Back_Left	0	18.50	19.0	1.12	98.14	1.02	0.56	0.64	
				Back_Right	0	18.50	19.0	1.12	98.14	1.02	0.03	0.03	
				Left	0	18.50	19.0	1.12	98.14	1.02	1.11	1.27	21
				Left*	0	18.50	19.0	1.12	98.14	1.02	0.82	0.94	
				Right	0	18.50	19.0	1.12	98.14	1.02	0.01	0.01	
				Top	0	18.50	19.0	1.12	98.14	1.02	0.18	0.21	
				Bottom	0	18.50	19.0	1.12	98.14	1.02	0.02	0.02	
U-NII-1	a	48	5240	Front	0	15.85	16.0	1.04	99.29	1.01	0.08	0.08	
				Back	0	15.85	16.0	1.04	99.29	1.01	0.39	0.41	
				Back_Left	0	15.85	16.0	1.04	99.29	1.01	0.67	0.70	22
				Back_Left*	0	15.85	16.0	1.04	99.29	1.01	0.44	0.46	
				Back_Right	0	15.85	16.0	1.04	99.29	1.01	0.09	0.09	
				Left	0	15.85	16.0	1.04	99.29	1.01	0.55	0.57	
				Right	0	15.85	16.0	1.04	99.29	1.01	0.02	0.02	
				Top	0	15.85	16.0	1.04	99.29	1.01	0.17	0.18	
				Bottom	0	15.85	16.0	1.04	99.29	1.01	0.01	0.01	
U-NII-2A	ac-VHT20	52	5260	Front	0	15.85	16.0	1.04	99.69	1.00	0.07	0.07	
				Back	0	15.85	16.0	1.04	99.69	1.00	0.38	0.39	
				Back_Left	0	15.85	16.0	1.04	99.69	1.00	0.58	0.60	23
				Back_Left*	0	15.85	16.0	1.04	99.69	1.00	0.45	0.47	
				Back_Right	0	15.85	16.0	1.04	99.69	1.00	0.09	0.09	
				Left	0	15.85	16.0	1.04	99.69	1.00	0.52	0.54	
				Right	0	15.85	16.0	1.04	99.69	1.00	0.01	0.01	
				Top	0	15.85	16.0	1.04	99.69	1.00	0.17	0.18	
				Bottom	0	15.85	16.0	1.04	99.69	1.00	0.01	0.01	

<Continue>

U-NII-2C	ac-VHT20	100	5500	Front	0	15.13	15.5	1.09	99.69	1.00	0.04	0.04	
				Back	0	15.13	15.5	1.09	99.69	1.00	0.21	0.23	
				Back_Left	0	15.13	15.5	1.09	99.69	1.00	0.48	0.52	
				Back_Left*	0	15.13	15.5	1.09	99.69	1.00	0.86	0.94	24
				Back_Right	0	15.13	15.5	1.09	99.69	1.00	0.05	0.05	
				Left	0	15.13	15.5	1.09	99.69	1.00	0.20	0.22	
				Right	0	15.13	15.5	1.09	99.69	1.00	0.02	0.02	
				Top	0	15.13	15.5	1.09	99.69	1.00	0.10	0.11	
				Bottom	0	15.85	16.0	1.04	99.69	1.00	0.01	0.01	
U-NII-3	ac-VHT40	159	5795	Front	0	14.45	15.0	1.14	99.69	1.00	0.01	0.01	
				Back	0	14.45	15.0	1.14	99.69	1.00	0.23	0.26	
				Back_Left	0	14.45	15.0	1.14	99.69	1.00	0.49	0.56	
				Back_Left*	0	14.45	15.0	1.14	99.69	1.00	0.65	0.74	25
				Back_Right	0	14.45	15.0	1.14	99.69	1.00	0.05	0.06	
				Left	0	14.45	15.0	1.14	99.69	1.00	0.34	0.39	
				Right	0	14.45	15.0	1.14	99.69	1.00	0.01	0.01	
				Top	0	14.45	15.0	1.14	99.69	1.00	0.08	0.09	
				Bottom	0	14.45	15.0	1.14	99.69	1.00	0.01	0.01	

Note: " * ", SAR worst-case retest with Sample 2#.

Band	Mode	CH.	Freq. (MHz)	Test Position	Dist. (mm)	Cond. Power (dBm)	Tune-up Power (dBm)	Scaling Factor	Duty Cycle %	Duty Cycle Factor	Meas. SAR-10g (W/kg)	Reported SAR-10g (W/kg)	Meas. APD-4cm ² , sq (W/m ²)	Reported APD-4cm ² , sq (W/m ²)	SAR Plot #
U-NII-5&6&7 &8	ax-HE 160	15	6025	Left	0	4.52	5.0	1.12	99.74	1.00	0.05	0.06	1.28	1.43	
		47	6185	Left	0	4.83	5.0	1.04	99.74	1.00	0.07	0.07	1.75	1.82	
		111	6505	Left	0	6.61	7.0	1.09	99.74	1.00	0.12	0.13	2.89	3.17	
		175	6825	Left	0	5.83	6.0	1.04	99.74	1.00	0.12	0.13	2.92	3.04	
		207	6985	Front	0	6.71	7.0	1.07	99.74	1.00	0.01	0.01	0.18	0.19	
				Back	0	6.71	7.0	1.07	99.74	1.00	0.04	0.04	0.82	0.88	
				Back_Left	0	6.71	7.0	1.07	99.74	1.00	0.09	0.10	1.98	2.12	
				Back_Right	0	6.71	7.0	1.07	99.74	1.00	0.01	0.01	0.24	0.26	
				Left	0	6.71	7.0	1.07	99.74	1.00	0.15	0.16	3.40	3.64	
				Left*	0	6.71	7.0	1.07	99.74	1.00	0.17	0.18	3.97	4.26	26
				Right	0	6.71	7.0	1.07	99.74	1.00	0.01	0.01	0.08	0.09	
				Top	0	6.71	7.0	1.07	99.74	1.00	0.01	0.01	0.12	0.13	
				Bottom	0	6.71	7.0	1.07	99.74	1.00	0.01	0.01	0.04	0.04	

Note: “ * ”, SAR worst-case retest with Sample 2#.

7.5. PD Test Results

Band	Mode	CH.	Freq. (MHz)	Test Position	Dist. (mm)	Cond. Power (dBm)	Tune-up Power (dBm)	Scaling Factor	Duty Cycle %	Duty Cycle Factor	Uncertainty Scaling Factor	Total psPD 4cm ² , sq (W/m ²)	Scaled Total psPD 4cm ² , sq (W/m ²)	Data Plot #
U-NII-5&6&7&8	ax-HE 160	15	6025	Left	0	8.31	8.5	1.04	99.74	1.00	1.12	3.55	4.16	
		47	6185	Left	0	8.31	8.5	1.04	99.74	1.00	1.12	2.47	2.90	
		111	6505	Left	0	9.45	10.0	1.14	99.74	1.00	1.12	6.81	8.68	
		175	6825	Left	0	9.80	10.0	1.05	99.74	1.00	1.12	4.07	4.79	
		207	6985	Front	0	10.22	10.5	1.07	99.74	1.00	1.12	1.90	2.28	
				Back	0	10.22	10.5	1.07	99.74	1.00	1.12	1.23	1.47	
				Back_Left	0	10.22	10.5	1.07	99.74	1.00	1.12	2.84	3.40	
				Back_Right	0	10.22	10.5	1.07	99.74	1.00	1.12	0.41	0.49	
				Left	0	10.22	10.5	1.07	99.74	1.00	1.12	7.38	8.84	27
				Left*	0	10.22	10.5	1.07	99.74	1.00	1.12	3.72	4.46	
				Right	0	10.22	10.5	1.07	99.74	1.00	1.12	0.31	0.37	
				Top	0	10.22	10.5	1.07	99.74	1.00	1.12	0.97	1.16	
		Bottom	0	10.22	10.5	1.07	99.74	1.00	1.12	0.01	0.01			

Notes:

1. “ * ”, SAR worst-case retest with Sample 2#.
2. Total expanded uncertainty of 1.51 dB (41.6%) was used to determine the psPD measurement scaling factor.

8. Simultaneous Transmission Analysis

■ Body-worn

Test Band	Test Position	Ant 3 Reported SAR-1g (W/kg)	Ant 2 Reported SAR-1g (W/kg)	Summed SAR (W/kg)
DTS	Front	0.05	0.38	0.43
	Back	0.22	0.09	0.31
U-NII-1	Front	0.03	0.17	0.20
	Back	0.34	0.83	1.17
U-NII-2A	Front	0.03	0.18	0.21
	Back	0.31	0.82	1.13
U-NII-2C	Front	0.10	0.11	0.21
	Back	0.44	0.51	0.95
U-NII-3	Front	0.13	0.09	0.22
	Back	0.30	0.47	0.77
U-NII-5&6&7&8	Front	0.01	0.01	0.02
	Back	0.05	0.11	0.16

■ Extremity

Test Band	Test Position	Ant 3 Reported SAR-10g (W/kg)	Ant 2 Reported SAR-10g (W/kg)	Summed SAR (W/kg)
DTS	Front	0.05	0.21	0.26
	Back	0.10	0.09	0.19
	Back_Left	1.37	0.64	2.01
	Back_Right	0.02	0.03	0.05
	Left	2.32	1.27	3.59
	Right	0.02	0.01	0.03
	Top	0.19	0.21	0.40
	Bottom	0.02	0.02	0.04
U-NII-1	Front	0.14	0.08	0.22
	Back	0.15	0.41	0.56
	Back_Left	1.03	0.70	1.73
	Back_Right	0.07	0.09	0.16
	Left	2.32	0.57	2.89
	Right	0.06	0.02	0.08
	Top	0.20	0.18	0.20
	Bottom	0.01	0.01	0.01
U-NII-2A	Front	0.14	0.07	0.21
	Back	0.15	0.39	0.54
	Back_Left	0.66	0.60	1.26
	Back_Right	0.07	0.09	0.16
	Left	2.10	0.54	2.64
	Right	0.07	0.01	0.08
	Top	0.19	0.18	0.19
	Bottom	0.01	0.01	0.01
U-NII-2C	Front	0.10	0.04	0.14
	Back	0.16	0.23	0.39
	Back_Left	1.10	0.94	2.04
	Back_Right	0.06	0.05	0.11
	Left	1.67	0.22	1.89
	Right	0.02	0.02	0.04
	Top	0.11	0.11	0.11
	Bottom	0.01	0.01	0.01

<Continue>

U-NII-3	Front	0.10	0.01	0.11
	Back	0.17	0.26	0.43
	Back_Left	1.19	0.74	1.93
	Back_Right	0.10	0.06	0.16
	Left	2.51	0.39	2.90
	Right	0.02	0.01	0.03
	Top	0.09	0.09	0.09
	Bottom	0.01	0.01	0.01
U-NII-5&6&7&8	Front	0.02	0.01	0.03
	Back	0.01	0.04	0.05
	Back_Left	0.12	0.10	0.22
	Back_Right	0.01	0.01	0.02
	Left	0.34	0.18	0.52
	Right	0.01	0.01	0.02
	Top	0.01	0.01	0.01
	Bottom	0.01	0.01	0.01

The above numerical summed SAR results for all the worst-case simultaneous transmission conditions were below the SAR limit. Therefore, the above analysis is sufficient to determine that simultaneous transmission cases will not exceed the SAR limit and therefore no measured volumetric simultaneous SAR summation is required per FCC KDB Publication 447498 D04v01.

9. Measuring Instrument

Instrument	Manufacturer	Type No.	Asset No.	Cali. Interval	Cali. Due Date
Stäubli Robot TX60L	Stäubli	TX60L	MRTSUE06412	N/A	N/A
Robot Controller	Stäubli	CS8C	MRTSUE06412	N/A	N/A
ELI Phantom Shell	Speag	V8	MRTSUE06420	N/A	N/A
mmWave Phantom	Speag	--	MRTSUE07015	N/A	N/A
DAK	Speag	DAK-3.5	MRTSUE06435	N/A	N/A
Dipole Validation Kits	Speag	D2450V2	MRTSUE06430	3 years	2027/05/06
Dipole Validation Kits	Speag	D5GHzV2	MRTSUE06434	3 years	2025/03/27
Dipole Validation Kits	Speag	D6.5GHzV2	MRTSUE06999	3 years	2024/09/01
Verification Source	Speag	10GHz	MRTSUE07010	3 years	2027/02/13
DAE4	Speag	1552	MRTSUE06414	1 year	2025/05/13
E-Field Probe	Speag	EX3DV4(SN 7768)	MRTSUE07058	1 year	2024/12/05
mmWave Probe	Speag	EUmmWV4	MRTSUE07009	1 year	2025/02/07
Network Analyzer	Keysight	N5234B	MRTSUE06454	1 year	2025/05/08
Directional Coupler	Agilent	778D	MRTSUE06083	1 year	2025/03/05
Directional Coupler	Agilent	87301DOPT 292	MRTSUE06082	1 year	2025/03/05
Signal Generator	Keysight	N5183B	MRTSUE06197	1 year	2025/06/03
Power Sensor	Keysight	U2021XA	MRTSUE06446	1 year	2025/05/08
Thermohygrometer	Testo	622	MRTSUE06361	1 year	2025/05/22

Software	Version	Function
DASY NEO	52.10.4.1535	SAR Test Software for below 6GHz
cADSY6 Module SAR	16.2.4.2524	SAR Test Software for above 6GHz
cDASY6 Module mmWave	3.2.2.2358	PD Test software

10. Measurement Uncertainty

DASY6 Uncertainty Budget, according to IEEE 1528 (0.3 - 3 GHz range)								
Error Description	Uncert. value	Prob. Dist.	Div.	(ci) 1g	(ci) 10g	Std. Unc. (1g)	Std. Unc. (10g)	(vi) v _{eff}
Measurement System								
Probe Calibration	±6.0 %	N	1	1	1	±6.0 %	±6.0 %	∞
Axial Isotropy	±4.7 %	R	$\sqrt{3}$	0.7	0.7	±1.9 %	±1.9 %	∞
Hemispherical Isotropy	±9.6 %	R	$\sqrt{3}$	0.7	0.7	±3.9 %	±3.9 %	∞
Boundary Effects	±1.0 %	R	$\sqrt{3}$	1	1	±0.6 %	±0.6 %	∞
Linearity	±4.7 %	R	$\sqrt{3}$	1	1	±2.7 %	±2.7 %	∞
System Detection Limits	±1.0 %	R	$\sqrt{3}$	1	1	±0.6 %	±0.6 %	∞
Modulation Response	±2.4 %	R	$\sqrt{3}$	1	1	±1.4 %	±1.4 %	∞
Readout Electronics	±0.3 %	N	1	1	1	±0.3 %	±0.3 %	∞
Response Time	±0.8 %	R	$\sqrt{3}$	1	1	±0.5 %	±0.5 %	∞
Integration Time	±2.6 %	R	$\sqrt{3}$	1	1	±1.5 %	±1.5 %	∞
RF Ambient Noise	±3.0 %	R	$\sqrt{3}$	1	1	±1.7 %	±1.7 %	∞
RF Ambient Reflections	±3.0 %	R	$\sqrt{3}$	1	1	±1.7 %	±1.7 %	∞
Probe Positioner	±0.02 %	R	$\sqrt{3}$	1	1	±0.0 %	±0.0 %	∞
Probe Positioning	±0.4 %	R	$\sqrt{3}$	1	1	±0.2 %	±0.2 %	∞
Max. SAR Eval.	±2.0 %	R	$\sqrt{3}$	1	1	±1.2 %	±1.2 %	∞
Test Sample Related								
Device Positioning	±2.9%	N	1	1	1	±2.9 %	±2.9 %	145
Device Holder	±3.6%	N	1	1	1	±3.6 %	±3.6 %	5
Power Drift	±5.0%	R	$\sqrt{3}$	1	1	±2.9 %	±2.9 %	∞
Power Scaling	±0%	R	$\sqrt{3}$	1	1	±0.0 %	±0.0 %	∞
Phantom and Setup								
Phantom Uncertainty	±6.1%	R	$\sqrt{3}$	1	1	±3.5 %	±3.5 %	∞
SAR correction	±1.9%	N	1	1	0.84	±1.9 %	±1.6 %	∞
Liquid Cond. (mea.) ^{DAK}	±2.5%	N	1	0.78	0.71	±2.0 %	±1.8 %	∞
Liquid Perm. (mea.) ^{DAK}	±2.5%	N	1	0.23	0.26	±0.6 %	±0.7 %	∞
Temp. unc. – Conductivity	±3.4%	R	$\sqrt{3}$	0.78	0.71	±1.5 %	±1.4 %	∞
Temp. unc. – Permittivity	±0.4%	R	$\sqrt{3}$	0.23	0.26	±0.1 %	±0.1 %	∞
Combined Std. Uncertainty						±11.3%	±11.2%	459
Expanded STD Uncertainty						±22.6%	±22.4%	

DASY6 Uncertainty Budget, according to IEEE 1528 (3 - 6 GHz range)								
Error Description	Uncert. value	Prob. Dist.	Div.	(ci) 1g	(ci) 10g	Std. Unc. (10g)	Std. Unc. (10g)	(vi) v _{eff}
Measurement System								
Probe Calibration	±6.55 %	N	1	1	1	±6.55 %	±6.55 %	∞
Axial Isotropy	±4.7 %	R	$\sqrt{3}$	0.7	0.7	±1.9 %	±1.9 %	∞
Hemispherical Isotropy	±9.6 %	R	$\sqrt{3}$	0.7	0.7	±3.9 %	±3.9 %	∞
Boundary Effects	±2.0 %	R	$\sqrt{3}$	1	1	±1.2 %	±1.2 %	∞
Linearity	±4.7 %	R	$\sqrt{3}$	1	1	±2.7 %	±2.7 %	∞
System Detection Limits	±1.0 %	R	$\sqrt{3}$	1	1	±0.6 %	±0.6 %	∞
Modulation Response	±2.4 %	R	$\sqrt{3}$	1	1	±1.4 %	±1.4 %	∞
Readout Electronics	±0.3 %	N	1	1	1	±0.3 %	±0.3 %	∞
Response Time	±0.8 %	R	$\sqrt{3}$	1	1	±0.5 %	±0.5 %	∞
Integration Time	±2.6 %	R	$\sqrt{3}$	1	1	±1.5 %	±1.5 %	∞
RF Ambient Noise	±3.0 %	R	$\sqrt{3}$	1	1	±1.7 %	±1.7 %	∞
RF Ambient Reflections	±3.0 %	R	$\sqrt{3}$	1	1	±1.7 %	±1.7 %	∞
Probe Positioner	±0.04 %	R	$\sqrt{3}$	1	1	±0.0 %	±0.0 %	∞
Probe Positioning	±0.8 %	R	$\sqrt{3}$	1	1	±0.5 %	±0.5 %	∞
Max. SAR Eval.	±4.0 %	R	$\sqrt{3}$	1	1	±2.3 %	±2.3 %	∞
Test Sample Related								
Device Positioning	±2.9%	N	1	1	1	±2.9 %	±2.9 %	145
Device Holder	±3.6%	N	1	1	1	±3.6 %	±3.6 %	5
Power Drift	±5.0%	R	$\sqrt{3}$	1	1	±2.9 %	±2.9 %	∞
Power Scaling	±0%	R	$\sqrt{3}$	1	1	±0.0 %	±0.0 %	∞
Phantom and Setup								
Phantom Uncertainty	±6.6%	R	$\sqrt{3}$	1	1	±3.8 %	±3.8 %	∞
SAR correction	±1.9%	N	1	1	0.84	±1.9 %	±1.6 %	∞
Liquid Cond. (mea.) ^{DAK}	±2.5%	N	1	0.78	0.71	±2.0 %	±1.8 %	∞
Liquid Perm. (mea.) ^{DAK}	±2.5%	N	1	0.23	0.26	±0.6 %	±0.7 %	∞
Temp. unc. – Conductivity	±3.4%	R	$\sqrt{3}$	0.78	0.71	±1.5 %	±1.4 %	∞
Temp. unc. – Permittivity	±0.4%	R	$\sqrt{3}$	0.23	0.26	±0.1 %	±0.1 %	∞
Combined Std. Uncertainty						±11.9%	±11.8%	569
Expanded STD Uncertainty						±23.8%	±23.6%	

DASY6 Uncertainty Budget, according to IEC 62209-1528 (6 - 10 GHz range)							
Error Description	Uncert. value	Prob. Dist.	Div.	(ci) 1g	(ci) 10g	Std. Unc. (1g)	Std. Unc. (10g)
Measurement System							
Probe Calibration	±18.6 %	N	2	1	1	±9.3 %	±9.3 %
Probe Calibration Drift	±1.7 %	R	$\sqrt{3}$	1	1	±1.0 %	±1.0 %
Probe Linearity	±4.7 %	R	$\sqrt{3}$	1	1	±2.7 %	±2.7 %
Broadband Signal	±2.8 %	R	$\sqrt{3}$	1	1	±1.6 %	±1.6 %
Probe Isotropy	±7.6 %	R	$\sqrt{3}$	1	1	±4.4 %	±4.4 %
Data Acquisition	±0.3 %	N	1	1	1	±0.3 %	±0.3 %
RF Ambient	±1.8 %	N	1	1	1	±1.8 %	±1.8 %
Probe Positioning	±0.005 mm	N	1	0.5	0.5	±0.25 %	±0.25 %
Data Processing	±3.5 %	N	1	1	1	±3.5 %	±3.5 %
Phantom and Device							
Conductivity (meas.) ^{DAK}	±2.5 %	N	1	0.78	0.71	±2.0%	±1.8 %
Conductivity (temp.) ^{BB}	±2.4 %	R	$\sqrt{3}$	0.78	0.71	±1.1 %	±1.0 %
Phantom Permittivity	±14.0%	R	$\sqrt{3}$	0.5	0.5	±4.0 %	±4.0 %
Distance DUT - TSL	±2.0 %	N	1	2	2	±4.0 %	±4.0 %
Device Positioning	±1.0 %	N	1	1	1	±1.0 %	±1.0 %
Device Holder	±3.6 %	N	1	1	1	±3.6 %	±3.6 %
DUT Modulation ^m	±2.4 %	R	$\sqrt{3}$	1	1	±1.4 %	±1.4 %
Time-average SAR	±1.7 %	R	$\sqrt{3}$	1	1	±1.0 %	±1.0 %
DUT drift	±2.5 %	N	1	1	1	±2.5 %	±2.5 %
Val Antenna Unc. ^{val}	±0 %	N	1	1	1	±0 %	±0 %
Unc. Input Power ^{val}	±0 %	N	1	1	1	±0 %	±0 %
Correction to the SAR results							
Deviation to Target	±1.9 %	N	1	1	0.84	±1.9 %	±1.6 %
SAR scaling ^p	±0 %	R	$\sqrt{3}$	1	1	±0 %	±0 %
Combined Std. Uncertainty						±14.0 %	±13.9 %
Expanded STD Uncertainty						±28.0 %	±27.9 %

DASY6 Uncertainty Budget for PD (avg $\geq 1 \text{ cm}^2$) Evaluation Distances to the Antennas $\geq \lambda/25$ in Compliance with IEC/IEEE 63195

Error Description		Unc. Value (\pm dB)	Probsb. Distri.	Div.	(ci)	Std. Unc. (\pm dB)	(vi) v _{eff}
Uncertainty terms dependent on the measurement system							
CAL	Calibration	0.49	N	1	1	0.49	∞
COR	Probe correction	0	R	$\sqrt{3}$	1	0	∞
FRS	Frequency response (BW ≤ 1 GHz)	0.20	R	$\sqrt{3}$	1	0.12	∞
SCC	Sensor cross coupling	0	R	$\sqrt{3}$	1	0	∞
ISO	Isotropy	0.50	R	$\sqrt{3}$	1	0.29	∞
LIN	Linearity	0.20	R	$\sqrt{3}$	1	0.12	∞
PSC	Probe scattering	0	R	$\sqrt{3}$	1	0	∞
PPO	Probe positioning offset	0.30	R	$\sqrt{3}$	1	0.17	∞
PPR	Probe positioning repeatability	0.04	R	$\sqrt{3}$	1	0.02	∞
SMO	Sensor mechanical offset	0	R	$\sqrt{3}$	1	0	∞
PSR	Probe spatial resolution	0	R	$\sqrt{3}$	1	0	∞
FLD	Field impedance dependence	0	R	$\sqrt{3}$	1	0	∞
MED	Measurement drift	0.05	R	$\sqrt{3}$	1	0.03	∞
APN	Amplitude and phase noise	0.04	R	$\sqrt{3}$	1	0.02	∞
TR	Measurement area truncation	0	R	$\sqrt{3}$	1	0	∞
DAQ	Data acquisition	0.03	N	1	1	0.03	∞
SMP	Sampling	0	R	$\sqrt{3}$	1	0	∞
REC	Field reconstruction	0.60	R	$\sqrt{3}$	1	0.35	∞
SNR	Signal-to-Noise Ratio	0	R	$\sqrt{3}$	1	0	
TRA	FTE/MEO	0	R	$\sqrt{3}$	1	0 (0)	∞
SCA	Power density scaling	–	R	$\sqrt{3}$	1	–	∞
SAV	Spatial averaging	0.10	R	$\sqrt{3}$	1	0.06	∞
Uncertainty terms dependent on the DUT and environmental factors							
PC	Probe coupling with DUT	0	R	$\sqrt{3}$	1	0	∞
MOD	Modulation response	0.40	R	$\sqrt{3}$	1	0.23	∞
IT	Integration time	0	R	$\sqrt{3}$	1	0	∞
RT	Response time	0	R	$\sqrt{3}$	1	0	∞
DH	Device holder influence	0.10	R	$\sqrt{3}$	1	0.06	∞
DA	DUT alignment	0	R	$\sqrt{3}$	1	0	∞
AC	RF ambient conditions	0.04	R	$\sqrt{3}$	1	0.02	∞
TEM	Laboratory Temperature	0.05	R	$\sqrt{3}$	1	0.03	∞
REF	Laboratory Reflections	0.04	R	$\sqrt{3}$	1	0.02	∞

MSI	Immunity / secondary reception	0	R	$\sqrt{3}$	1	0	∞
DRI	Drift of the DUT	–	R	$\sqrt{3}$	1	–	∞
Combined Std Uncertainty (w/ FTE/MEO)						0.75	∞
Expanded Std Uncertainty (w/FTE/MEO)						1.51	

Annex A - System Check Result

Test Date: 2024/07/12

SystemPerformanceCheck-SAM2-D2450HSL

DUT: Dipole 2450 MHz D2450V2; Type: D2450V2

Communication System: CW; Frequency: 2450 MHz; Duty Cycle: 1:1

 Medium parameters used: $f = 2450$ MHz; $\sigma = 1.78$ S/m; $\epsilon_r = 40.57$; $\rho = 1000$ kg/m³

Phantom section: Flat Section

DASY5 Configuration:

- Probe: EX3DV4 - SN7856; ConvF(7.08, 7.12, 7.02) @ 2450 MHz; Calibrated: 2023/12/6
- Sensor-Surface: 1.4mm (Mechanical Surface Detection)
- Electronics: DAE4 Sn1552; Calibrated: 2024/5/14
- Phantom: SAM2; Type: QD OVA 004 AA; Serial: 2089
- Measurement SW: DASY52, Version 52.10 (4); SEMCAD X Version 14.6.14 (7501)

configuration/d=10mm, Pin=250mW, dist=1.4mm (EX-Probe)/Area Scan (7x9x1): Measurement grid:

dx=12mm, dy=12mm; Maximum value of SAR (measured) = 19.8 W/kg

configuration/d=10mm, Pin=250mW, dist=1.4mm (EX-Probe)/Zoom Scan (7x7x7)/Cube 0: Measurement

grid: dx=5mm, dy=5mm, dz=5mm; Reference Value = 103.9 V/m; Power Drift = -0.01 dB

Peak SAR (extrapolated) = 24.6 W/kg

SAR(1 g) = 12.6 W/kg; SAR(10 g) = 6.01 W/kg

Smallest distance from peaks to all points 3 dB below = 9 mm

Ratio of SAR at M2 to SAR at M1 = 51.5%

Maximum value of SAR (measured) = 20.3 W/kg

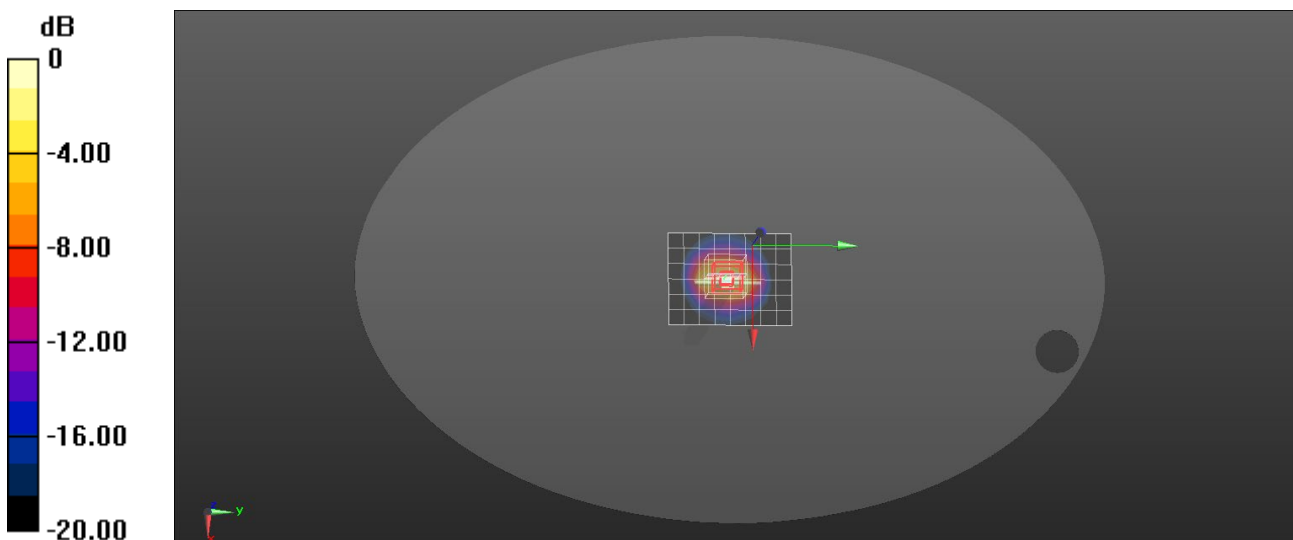

0 dB = 20.3 W/kg = 13.07 dBW/kg

Test Date: 2024/07/15

SystemPerformanceCheck-SAM2-D5250HSL
DUT: Dipole D5GHzV2; Type: D5GHzV2

Communication System: CW; Frequency: 5250 MHz; Duty Cycle: 1:1

 Medium parameters used: $f = 5250$ MHz; $\sigma = 4.5$ S/m; $\epsilon_r = 35.88$; $\rho = 1000$ kg/m³

Phantom section: Flat Section

DASY5 Configuration:

- Probe: EX3DV4 - SN7856; ConvF(5, 5.07, 4.96) @ 5250 MHz; Calibrated: 2023/12/6
- Sensor-Surface: 1.4mm (Mechanical Surface Detection)
- Electronics: DAE4 Sn1552; Calibrated: 2024/5/14
- Phantom: SAM2; Type: QD OVA 004 AA; Serial: 2089
- Measurement SW: DASY52, Version 52.10 (4); SEMCAD X Version 14.6.14 (7501)

Configuration/d=10mm, Pin=100mW, dist=1.4mm (EX-Probe)/Area Scan (7x7x1): Measurement grid:

dx=10mm, dy=10mm; Maximum value of SAR (measured) = 16.5 W/kg

Configuration/d=10mm, Pin=100mW, dist=1.4mm (EX-Probe)/Zoom Scan (8x8x8) (8x8x7)/Cube 0:

Measurement grid: dx=4mm, dy=4mm, dz=1.4mm; Reference Value = 58.65 V/m; Power Drift = -0.04 dB

Peak SAR (extrapolated) = 31.2 W/kg

SAR(1 g) = 8.03 W/kg; SAR(10 g) = 2.33 W/kg

Smallest distance from peaks to all points 3 dB below = 7.5 mm

Ratio of SAR at M2 to SAR at M1 = 65.9%

Maximum value of SAR (measured) = 19.8 W/kg

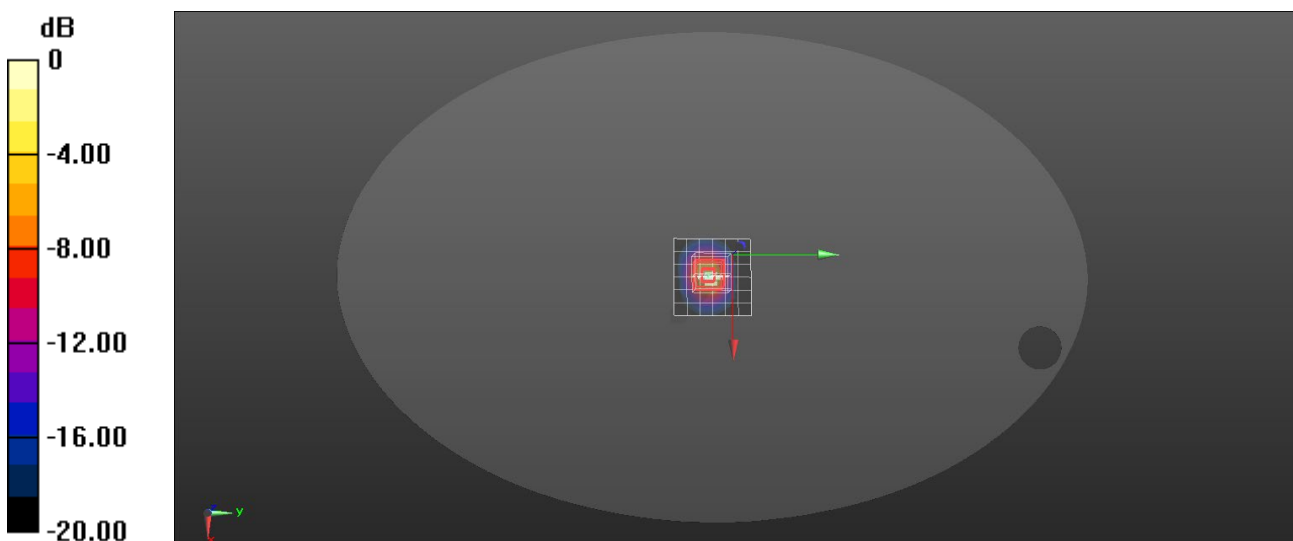

0 dB = 19.8 W/kg = 12.97 dBW/kg

Test Date: 2024/07/16

SystemPerformanceCheck-SAM2-D5600HSL
DUT: Dipole D5GHzV2; Type: D5GHzV2

Communication System: CW; Frequency: 5600 MHz; Duty Cycle: 1:1

 Medium parameters used: $f = 5600$ MHz; $\sigma = 4.89$ S/m; $\epsilon_r = 35.26$; $\rho = 1000$ kg/m³

Phantom section: Flat Section

DASY5 Configuration:

- Probe: EX3DV4 - SN7856; ConvF(4.3, 4.33, 4.21) @ 5600 MHz; Calibrated: 2023/12/6
- Sensor-Surface: 1.4mm (Mechanical Surface Detection)
- Electronics: DAE4 Sn1552; Calibrated: 2024/5/14
- Phantom: SAM2; Type: QD OVA 004 AA; Serial: 2089
- Measurement SW: DASY52, Version 52.10 (4); SEMCAD X Version 14.6.14 (7501)

Configuration/d=10mm, Pin=100mW, dist=1.4mm (EX-Probe)/Area Scan (7x9x1): Measurement grid:

 $dx=10$ mm, $dy=10$ mm; Maximum value of SAR (measured) = 18.7 W/kg

Configuration/d=10mm, Pin=100mW, dist=1.4mm (EX-Probe)/Zoom Scan (8x8x8) (9x9x7)/Cube 0:

 Measurement grid: $dx=4$ mm, $dy=4$ mm, $dz=1.4$ mm; Reference Value = 60.04 V/m; Power Drift = -0.04 dB

Peak SAR (extrapolated) = 34.1 W/kg

SAR(1 g) = 8.3 W/kg; SAR(10 g) = 2.38 W/kg

Smallest distance from peaks to all points 3 dB below = 7.4 mm

Ratio of SAR at M2 to SAR at M1 = 63.8%

Maximum value of SAR (measured) = 20.9 W/kg

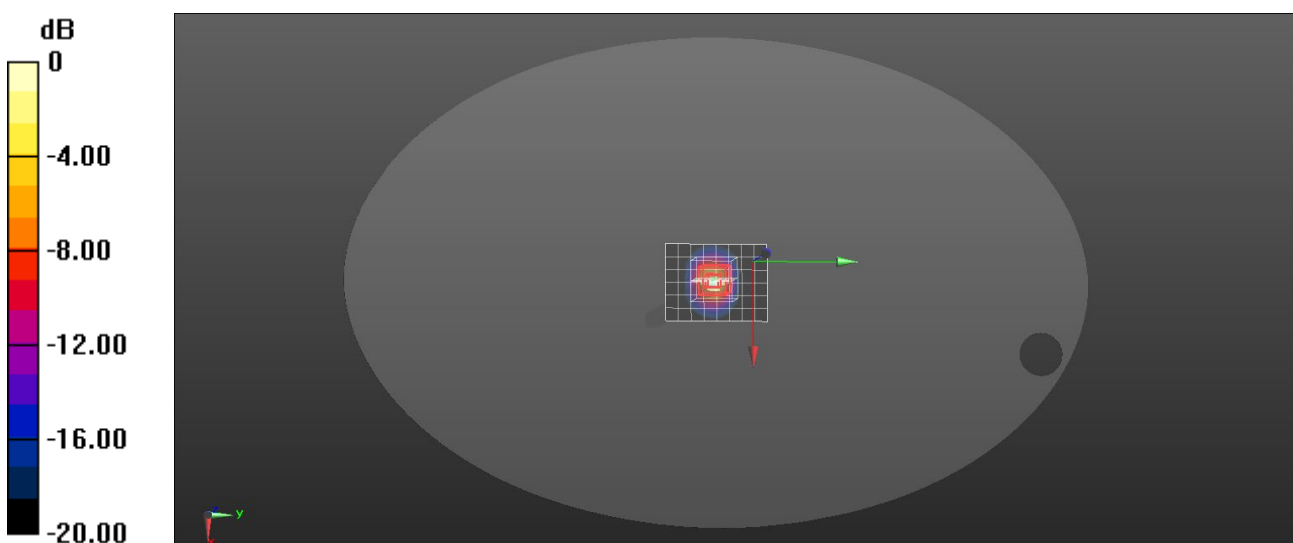
 0 dB = 20.9 W/kg = 13.20 dBW/kg

Test Date: 2024/07/16

SystemPerformanceCheck-SAM2-D5750HSL
DUT: Dipole D5GHzV2; Type: D5GHzV2

Communication System: CW; Frequency: 5750 MHz; Duty Cycle: 1:1

 Medium parameters used: $f = 5750$ MHz; $\sigma = 5.06$ S/m; $\epsilon_r = 34.99$; $\rho = 1000$ kg/m³

Phantom section: Flat Section

DASY5 Configuration:

- Probe: EX3DV4 - SN7856; ConvF(4.26, 4.29, 4.21) @ 5750 MHz; Calibrated: 2023/12/6
- Sensor-Surface: 1.4mm (Mechanical Surface Detection)
- Electronics: DAE4 Sn1552; Calibrated: 2024/5/14
- Phantom: SAM2; Type: QD OVA 004 AA; Serial: 2089
- Measurement SW: DASY52, Version 52.10 (4); SEMCAD X Version 14.6.14 (7501)

Configuration/d=10mm, Pin=100 mW, dist=1.4mm (EX-Probe)/Area Scan (7x9x1): Measurement grid:

dx=10mm, dy=10mm; Maximum value of SAR (measured) = 18.3 W/kg

Configuration/d=10mm, Pin=100 mW, dist=1.4mm (EX-Probe)/Zoom Scan (8x8x8) (7x7x7)/Cube 0:

Measurement grid: dx=4mm, dy=4mm, dz=1.4mm; Reference Value = 58.79 V/m; Power Drift = -0.02 dB

Peak SAR (extrapolated) = 34.2 W/kg

SAR(1 g) = 8.04 W/kg; SAR(10 g) = 2.32 W/kg

Smallest distance from peaks to all points 3 dB below = 7.2 mm

Ratio of SAR at M2 to SAR at M1 = 62.7%

Maximum value of SAR (measured) = 20.7 W/kg

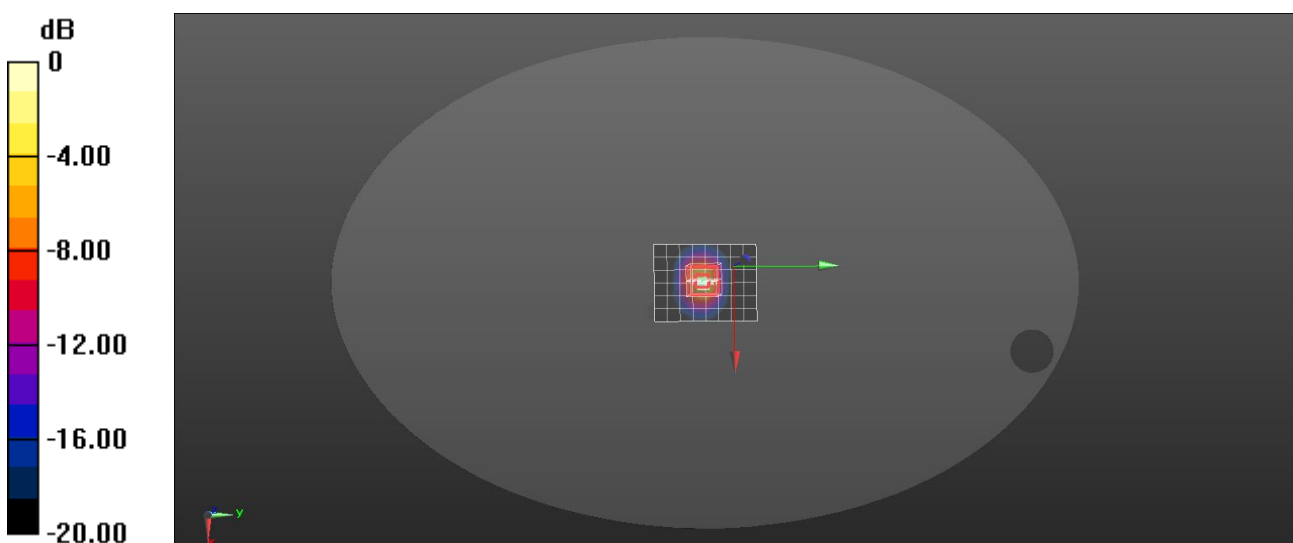

0 dB = 20.7 W/kg = 13.16 dBW/kg

SystemPerformanceCheck-SAM2-D6500HSL
Summary

Dipole	Frequency [MHz]	TSL	Power [dBm]	Dev. 1g [%]	Dev. 10g [%]	Dev. Peak [%]	Iso. Error [%]
D6.5GHzV2 - SN1040	6500.0	HSL	20.0	4.8	8.6	n/a	-2.8

Exposure Conditions

Phantom Section, TSL	Test Distance [mm]	Band	Group, UID	Frequency [MHz], Channel Number	Conversion Factor	TSL Conductivity [S/m]	TSL Permittivity
Flat, HSL	5		CW, 0--	6500.000, 0	4.76	5.93	33.7

Hardware Setup

Phantom	TSL, Measured Date	Probe, Calibration Date	DAE, Calibration Date
ELI V8.0 (20deg probe tilt) - 2089	HBBL-600-10000 Charge:xxxx	EX3DV4 - SN7856, 2023-12-06	DAE4 Sn1552, 2024-05-14

Scans Setup

	Area Scan	Zoom Scan
Grid Extents [mm]	51.0 x 85.0	22.0 x 22.0 x 22.0
Grid Steps [mm]	8.5 x 8.5	3.4 x 3.4 x 1.4
Sensor Surface [mm]	3.0	1.4
Graded Grid	N/A	Yes
Grading Ratio	N/A	1.4
MAIA	N/A	N/A
Surface Detection	VMS + 6p	VMS + 6p
Scan Method	Measured	Measured

Measurement Results

	Area Scan	Zoom Scan
Date	2024-07-17	2024-07-17

psSAR1g [W/Kg]	25.1	30.5
psSAR10g [W/Kg]	5.38	5.79
psAPD (1.0cm2, sq) [W/m2]		305
psAPD (4.0cm2, sq) [W/m2]		141
Power Drift [dB]	0.03	-0.00
Power Scaling	Disabled	Disabled
Scaling Factor [dB]		
TSL Correction	No correction	No correction

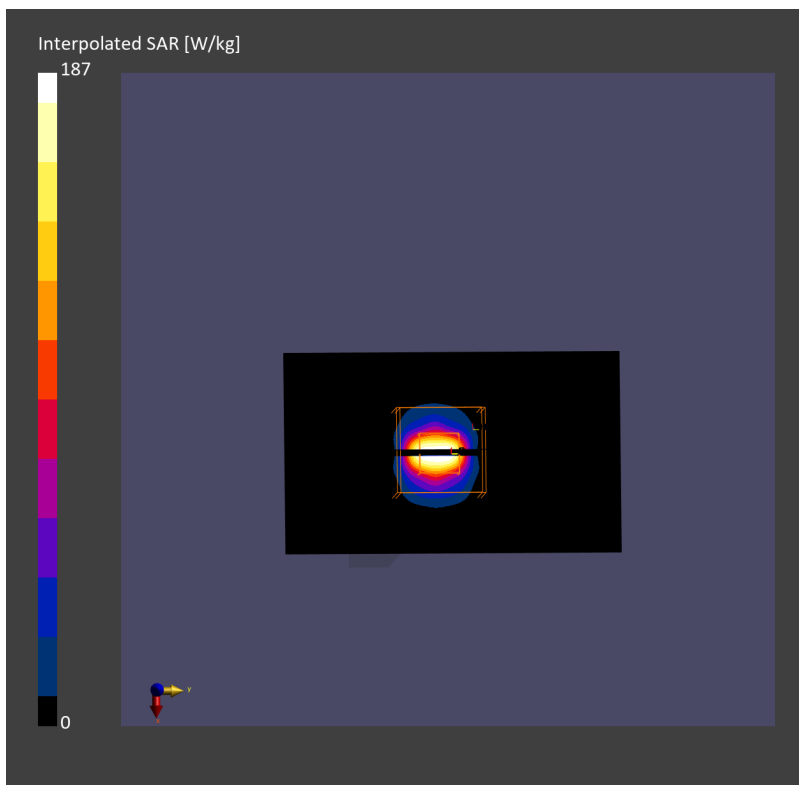

Measurement Report for Device, FRONT, Validation band, CW, Channel 10000 (10000.0 MHz)
Device Under Test Properties

Model, Manufacturer	Dimensions [mm]	IMEI	DUT Type
Device,	100.0 x 100.0 x 100.0		Phone

Exposure Conditions

Phantom Section	Position, Test Distance [mm]	Band	Group, UID	Frequency [MHz], Channel Number	Conversion Factor
5G	FRONT, 10.00	Validation band	CW, 0--	10000.0, 10000	1.0

Hardware Setup

Phantom	Medium	Probe, Calibration Date	DAE, Calibration Date
mmWave - 1086	Air -	EUmmWV4 - SN9596_F1-55GHz, 2024-02-08	DAE4 Sn1552, 2024-05-14

Scans Setup

Scan Type	5G Scan
Grid Extents [mm]	50.0 x 50.0
Grid Steps [lambda]	0.125 x 0.125
Sensor Surface [mm]	10.0
MAIA	N/A

Measurement Results

Scan Type	5G Scan
Date	2024-07-18
Avg. Area [cm ²]	4.00
psPDn+ [W/m ²]	155
psPDtot+ [W/m ²]	161
psPDmod+ [W/m ²]	165
E _{max} [V/m]	281

Power Drift [dB]	-0.00
------------------	-------

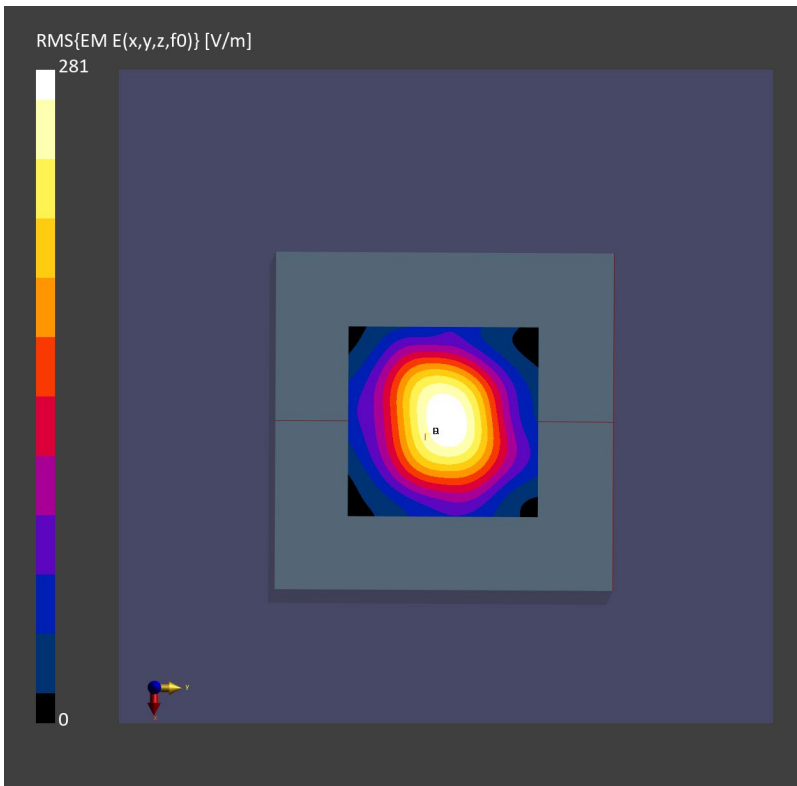

Annex B - Test Data Plots

Plot 1#

Test Date: 2024/07/12

DUT: Mobile Computer; Type: CK62X00

Procedure Name: 802.11b 2412MHz Body Back

Communication System: 802.11b; Frequency: 2412 MHz

Medium parameters used: $f = 2412$ MHz; $\sigma = 1.76$ S/m; $\epsilon_r = 40.64$; $\rho = 1000$ kg/m³; Tissue Temp (celsius)-22.5°C; Phantom section: Flat Section

DASY5 Configuration:

- Probe: EX3DV4 - SN7856; ConvF(7.08, 7.12, 7.02) @ 2412 MHz; Calibrated: 2023/12/6
- Sensor-Surface: 1.4mm (Mechanical Surface Detection)
- Electronics: DAE4 Sn1552; Calibrated: 2024/5/14
- Phantom: SAM2; Type: QD OVA 004 AA; Serial: 2089
- Measurement SW: DASY52, Version 52.10 (4); SEMCAD X Version 14.6.14 (7501)

Configuration/802.11b 2412MHz Body Back/Area Scan (11x11x1): Measurement grid: dx=12mm, dy=12mm; Maximum value of SAR (measured) = 0.319 W/kg

Configuration/802.11b 2412MHz Body Back/Zoom Scan (7x7x7)/Cube 0: Measurement grid: dx=5mm, dy=5mm, dz=5mm; Reference Value = 10.29 V/m; Power Drift = -0.11 dB

Peak SAR (extrapolated) = 0.392 W/kg

SAR(1 g) = 0.214 W/kg; SAR(10 g) = 0.110 W/kg

Smallest distance from peaks to all points 3 dB below = 11.7 mm

Ratio of SAR at M2 to SAR at M1 = 54.7%

Maximum value of SAR (measured) = 0.328 W/kg

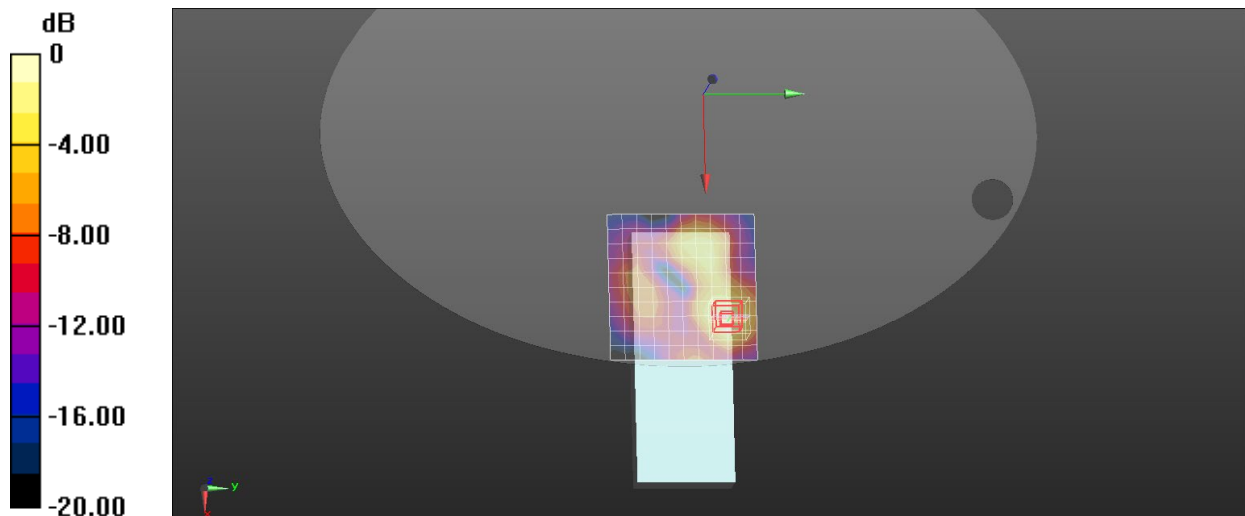

0 dB = 0.328 W/kg = -4.84 dBW/kg

Plot 2#

Test Date: 2024/07/15

DUT: Mobile Computer; Type: CK62X00
Procedure Name: 802.11a 5240MHz Body Back

Communication System: 802.11a; Frequency: 5240 MHz; Duty Cycle: 1:1

 Medium parameters used: $f = 5240$ MHz; $\sigma = 4.49$ S/m; $\epsilon_r = 35.9$; $\rho = 1000$ kg/m³; Tissue Temp (celsius)-22.5°C; Phantom section: Flat Section

DASY5 Configuration:

- Probe: EX3DV4 - SN7856; ConvF(5, 5.07, 4.96) @ 5240 MHz; Calibrated: 2023/12/6
- Sensor-Surface: 1.4mm (Mechanical Surface Detection)
- Electronics: DAE4 Sn1552; Calibrated: 2024/5/14
- Phantom: SAM2; Type: QD OVA 004 AA; Serial: 2089
- Measurement SW: DASY52, Version 52.10 (4); SEMCAD X Version 14.6.14 (7501)

Configuration/802.11a 5240MHz Body Back/Area Scan (14x13x1): Measurement grid: dx=10mm, dy=10mm; Maximum value of SAR (measured) = 0.616 W/kg

Configuration/802.11a 5240MHz Body Back/Zoom Scan (9x9x7)/Cube 1: Measurement grid: dx=4mm, dy=4mm, dz=1.4mm; Reference Value = 11.75 V/m; Power Drift = -0.10 dB

Peak SAR (extrapolated) = 0.940 W/kg

SAR(1 g) = 0.289 W/kg; SAR(10 g) = 0.119 W/kg

Smallest distance from peaks to all points 3 dB below = 11.9 mm

Ratio of SAR at M2 to SAR at M1 = 67.1%

Maximum value of SAR (measured) = 0.624 W/kg

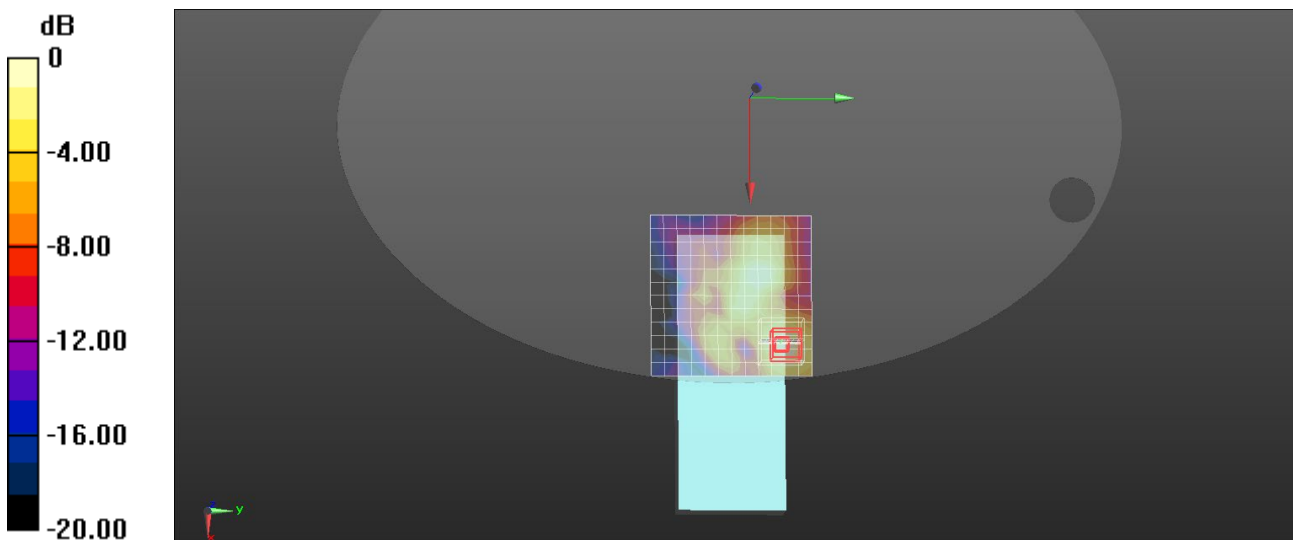

0 dB = 0.624 W/kg = -2.05 dBW/kg

Plot 3#

Test Date: 2024/07/15

DUT: Mobile Computer; Type: CK62X00**Procedure Name: 802.11ac-VHT20 5260MHz Body Back**

Communication System: 802.11ac; Frequency: 5260 MHz

Medium parameters used: $f = 5260$ MHz; $\sigma = 4.51$ S/m; $\epsilon_r = 35.87$; $\rho = 1000$ kg/m³; Tissue Temp (celsius)-22.5°C; Phantom section: Flat Section

DASY5 Configuration:

- Probe: EX3DV4 - SN7856; ConvF(5, 5.07, 4.96) @ 5260 MHz; Calibrated: 2023/12/6
- Sensor-Surface: 1.4mm (Mechanical Surface Detection)
- Electronics: DAE4 Sn1552; Calibrated: 2024/5/14
- Phantom: SAM2; Type: QD OVA 004 AA; Serial: 2089
- Measurement SW: DASY52, Version 52.10 (4); SEMCAD X Version 14.6.14 (7501)

Configuration/802.11ac-VHT20 5260MHz Body Back/Area Scan (13x13x1): Measurement grid: dx=10mm, dy=10mm; Maximum value of SAR (measured) = 0.631 W/kg**Configuration/802.11ac-VHT20 5260MHz Body Back/Zoom Scan (7x7x7)/Cube 1:** Measurement grid: dx=4mm, dy=4mm, dz=1.4mm; Reference Value = 10.59 V/m; Power Drift = -0.05 dB

Peak SAR (extrapolated) = 0.894 W/kg

SAR(1 g) = 0.269 W/kg; SAR(10 g) = 0.110 W/kg

Smallest distance from peaks to all points 3 dB below = 13.6 mm

Ratio of SAR at M2 to SAR at M1 = 66.2%

Maximum value of SAR (measured) = 0.584 W/kg

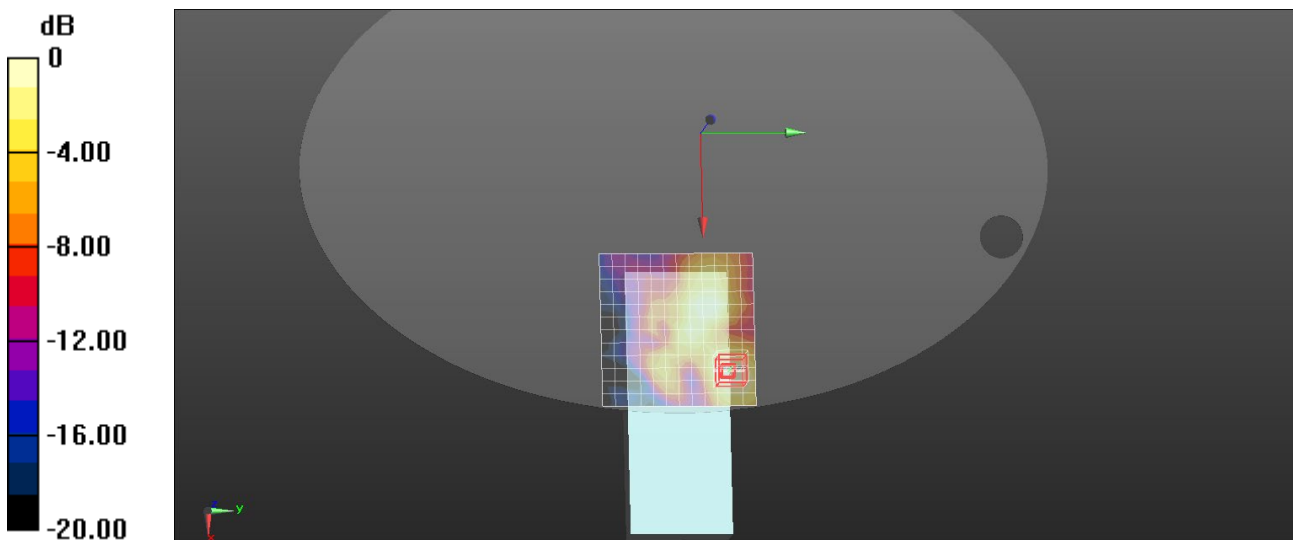

0 dB = 0.584 W/kg = -2.34 dBW/kg

Plot 4#

Test Date: 2024/07/16

DUT: Mobile Computer; Type: CK62X00

Procedure Name: 802.11ac-VHT20 5500MHz Body Back

Communication System: 802.11ac; Frequency: 5500 MHz; Duty Cycle: 1:1

Medium parameters used: $f = 5500$ MHz; $\sigma = 4.77$ S/m; $\epsilon_r = 35.44$; $\rho = 1000$ kg/m³; Tissue Temp (celsius)-22.5°C; Phantom section: Flat Section

DASY5 Configuration:

- Probe: EX3DV4 - SN7856; ConvF(4.3, 4.33, 4.21) @ 5500 MHz; Calibrated: 2023/12/6
- Sensor-Surface: 1.4mm (Mechanical Surface Detection)
- Electronics: DAE4 Sn1552; Calibrated: 2024/5/14
- Phantom: SAM2; Type: QD OVA 004 AA; Serial: 2089
- Measurement SW: DASY52, Version 52.10 (4); SEMCAD X Version 14.6.14 (7501)

Configuration/802.11ac-VHT20 5500MHz Body Back/Area Scan (14x13x1): Measurement grid: dx=10mm, dy=10mm; Maximum value of SAR (measured) = 1.03 W/kg

Configuration/802.11ac-VHT20 5500MHz Body Back/Zoom Scan (9x9x7)/Cube 1: Measurement grid: dx=4mm, dy=4mm, dz=1.4mm; Reference Value = 12.24 V/m; Power Drift = 0.12 dB

Peak SAR (extrapolated) = 1.30 W/kg

SAR(1 g) = 0.389 W/kg; SAR(10 g) = 0.160 W/kg

Smallest distance from peaks to all points 3 dB below = 13.6 mm

Ratio of SAR at M2 to SAR at M1 = 65.5%

Maximum value of SAR (measured) = 0.839 W/kg

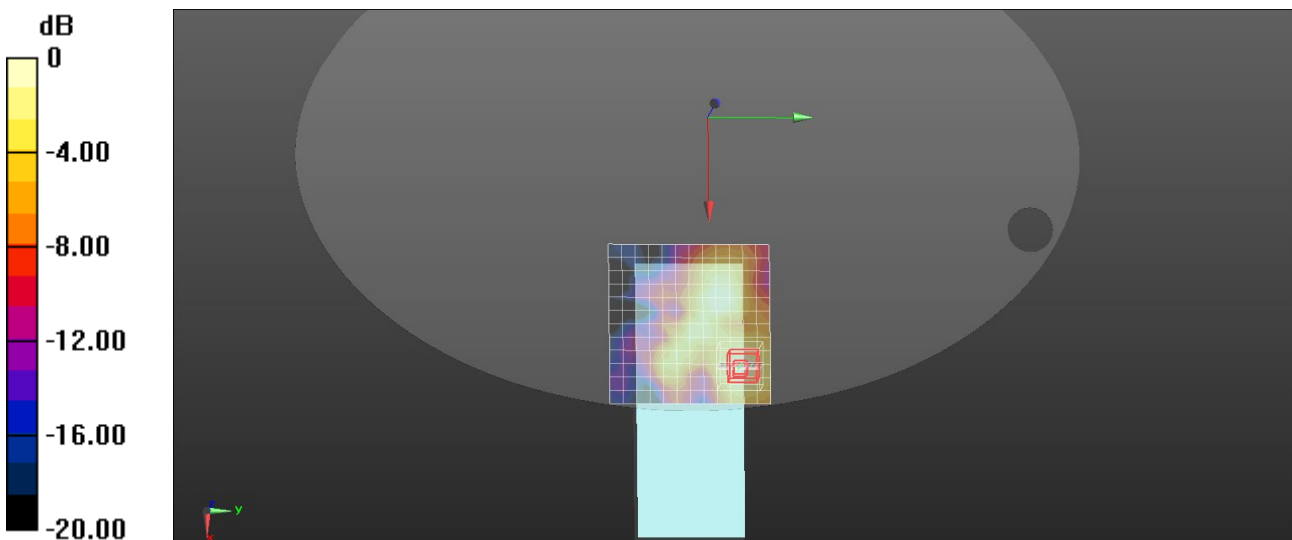

0 dB = 0.839 W/kg = -0.76 dBW/kg

Plot 5#

Test Date: 2024/07/16

DUT: Mobile Computer; Type: CK62X00
Procedure Name: 802.11ac-VHT40 5795MHz Body Back

Communication System: 802.11ac; Frequency: 5795 MHz; Duty Cycle: 1:1

 Medium parameters used: $f = 5795$ MHz; $\sigma = 5.12$ S/m; $\epsilon_r = 34.91$; $\rho = 1000$ kg/m³; Tissue Temp (celsius)-22.5°C; Phantom section: Flat Section

DASY5 Configuration:

- Probe: EX3DV4 - SN7856; ConvF(4.26, 4.29, 4.21) @ 5795 MHz; Calibrated: 2023/12/6
- Sensor-Surface: 1.4mm (Mechanical Surface Detection)
- Electronics: DAE4 Sn1552; Calibrated: 2024/5/14
- Phantom: SAM2; Type: QD OVA 004 AA; Serial: 2089
- Measurement SW: DASY52, Version 52.10 (4); SEMCAD X Version 14.6.14 (7501)

Configuration/802.11ac-VHT40 5795MHz Body Back/Area Scan (14x13x1): Measurement grid: dx=10mm, dy=10mm; Maximum value of SAR (measured) = 0.919 W/kg

Configuration/802.11ac-VHT40 5795MHz Body Back/Zoom Scan (9x9x7)/Cube 1: Measurement grid: dx=4mm, dy=4mm, dz=1.4mm; Reference Value = 10.57 V/m; Power Drift = -0.08 dB

Peak SAR (extrapolated) = 0.977 W/kg

SAR(1 g) = 0.257 W/kg; SAR(10 g) = 0.102 W/kg

Smallest distance from peaks to all points 3 dB below = 11.5 mm

Ratio of SAR at M2 to SAR at M1 = 61.9%

Maximum value of SAR (measured) = 0.596 W/kg

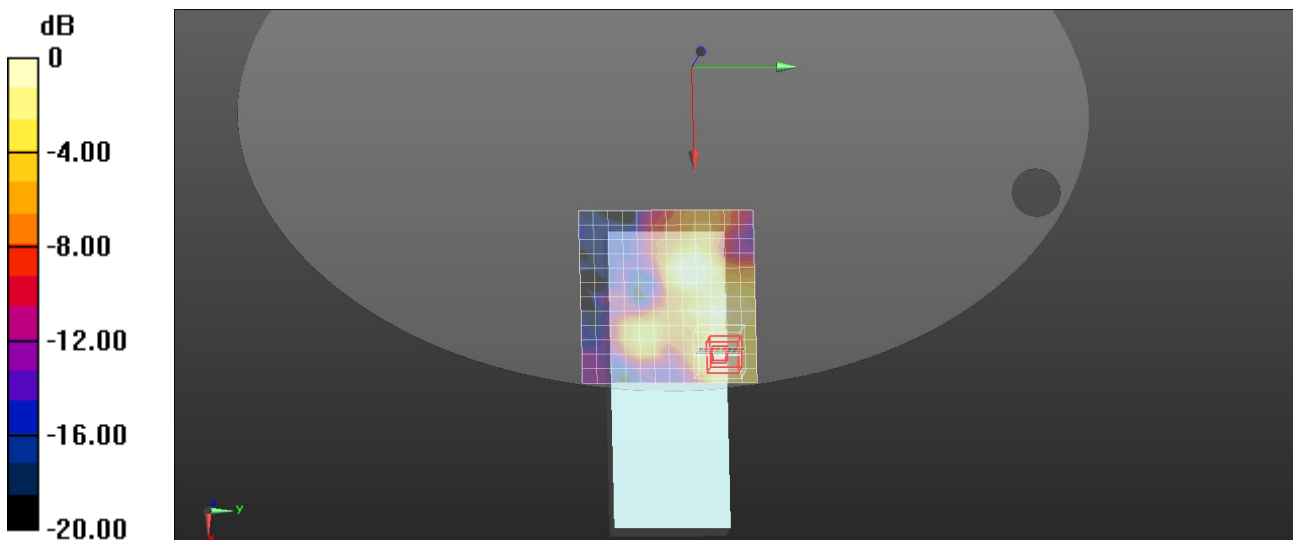

0 dB = 0.596 W/kg = -2.25 dBW/kg

Plot 6#

Measurement Report for CK62X00, BACK, U-NII-5, IEEE 802.11ax (160MHz, MCS0, 99pc duty cycle), Channel 47 (6185.000 MHz)
Device Under Test Properties

Model, Manufacturer	Dimensions [mm]	IMEI	DUT Type
CK62X00,	80.0 x 206.0 x 30.0		Phone

Exposure Conditions

Phantom Section, TSL	Position, Test Distance [mm]	Band	Group, UID	Frequency [MHz], Channel Number	Conversion Factor	TSL Conductivity [S/m]	TSL Permittivity
Flat, HSL	BACK, 5.00	U-NII-5	WLAN, 10755-AAC	6185.000, 47	4.76	5.57	34.2

Hardware Setup

Phantom	TSL, Measured Date	Probe, Calibration Date	DAE, Calibration Date
ELI V8.0 (20deg probe tilt) - 2089	HBBL-600-10000 Charge:xxxx,	EX3DV4 - SN7856, 2023-12-06	DAE4 Sn1552, 2024-05-14

Scans Setup

	Area Scan	Zoom Scan
Grid Extents [mm]	119.0 x 119.0	22.0 x 22.0 x 22.0
Grid Steps [mm]	8.5 x 8.5	3.4 x 3.4 x 1.4
Sensor Surface [mm]	3.0	1.4
Graded Grid	N/A	Yes
Grading Ratio	N/A	1.4
MAIA	Y	Y
Surface Detection	VMS + 6p	VMS + 6p
Scan Method	Measured	Measured

Measurement Results

	Area Scan	Zoom Scan
Date	2024-07-17	2024-07-17
psSAR1g [W/kg]	0.057	0.061
psSAR10g [W/kg]	0.020	0.022
psAPD (1.0cm ² , sq) [W/m ²]		0.606
psAPD (4.0cm ² , sq) [W/m ²]		0.494
Power Drift [dB]	0.39	-0.05
Power Scaling	Disabled	Disabled
Scaling Factor [dB]		
TSL Correction	No correction	No correction
M2/M1 [%]		60.2
Dist 3dB Peak [mm]		8.6

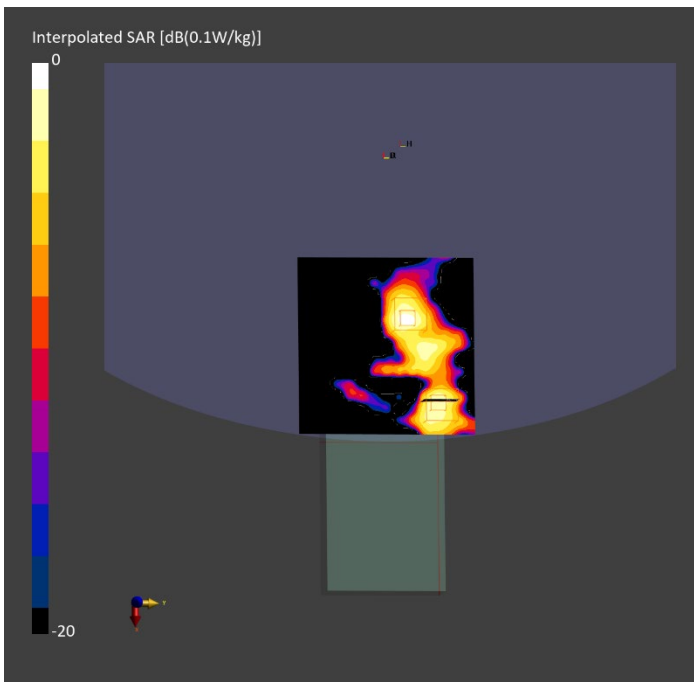

Plot 7#

Test Date: 2024/07/12

DUT: Mobile Computer; Type: CK62X00

Procedure Name: Bluetooth 2DH5 2480MHz Body Back

Communication System: Bluetooth; Frequency: 2480 MHz; Duty Cycle: 1:1

Medium parameters used: $f = 2480$ MHz; $\sigma = 1.8$ S/m; $\epsilon_r = 40.53$; $\rho = 1000$ kg/m³; Tissue Temp (celsius)-22.5°C; Phantom section: Flat Section

DASY5 Configuration:

- Probe: EX3DV4 - SN7856; ConvF(7.08, 7.12, 7.02) @ 2480 MHz; Calibrated: 2023/12/6
- Sensor-Surface: 1.4mm (Mechanical Surface Detection)
- Electronics: DAE4 Sn1552; Calibrated: 2024/5/14
- Phantom: SAM2; Type: QD OVA 004 AA; Serial: 2089
- Measurement SW: DASY52, Version 52.10 (4); SEMCAD X Version 14.6.14 (7501)

Configuration/Bluetooth 2DH5 2480MHz Body Back/Area Scan (11x11x1): Measurement grid: dx=12mm, dy=12mm; Maximum value of SAR (measured) = 0.0383 W/kg

Configuration/Bluetooth 2DH5 2480MHz Body Back/Zoom Scan (7x7x7)/Cube 0: Measurement grid: dx=5mm, dy=5mm, dz=5mm; Reference Value = 0.913 V/m; Power Drift = 0.16 dB

Peak SAR (extrapolated) = 0.0480 W/kg

SAR(1 g) = 0.024 W/kg; SAR(10 g) = 0.011 W/kg

Smallest distance from peaks to all points 3 dB below: Larger than measurement grid (> 15 mm)

Ratio of SAR at M2 to SAR at M1 = 49.3%

Maximum value of SAR (measured) = 0.0387 W/kg

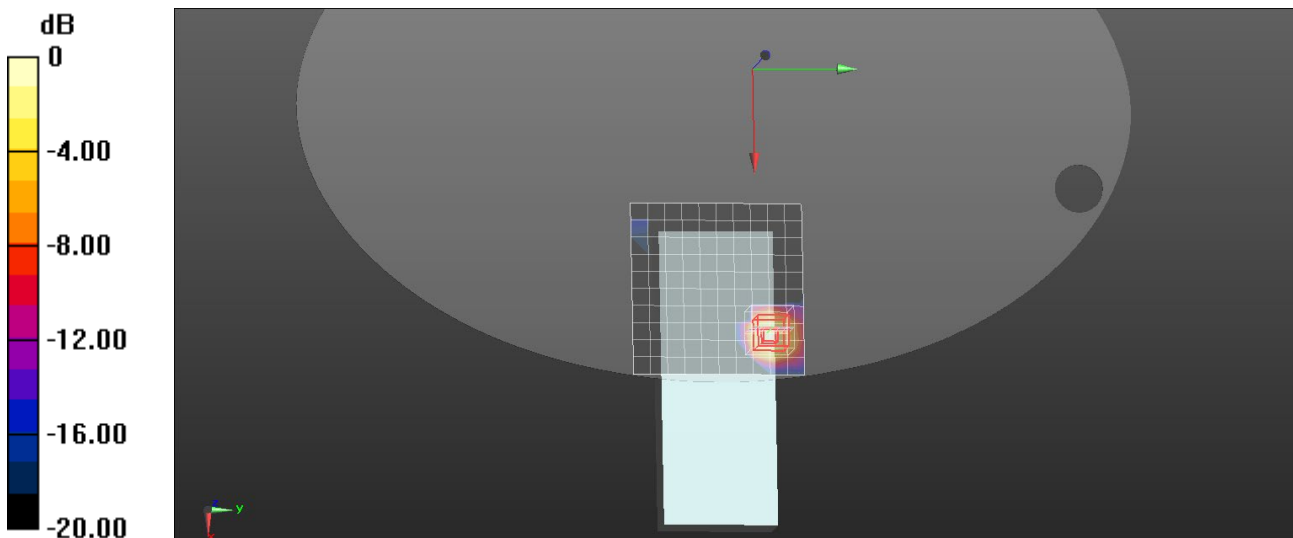

0 dB = 0.0387 W/kg = -14.12 dBW/kg

Plot 8#

Test Date: 2024/07/12

DUT: Mobile Computer; Type: CK62X00
Procedure Name: 802.11b 2412MHz Body Front

Communication System: 802.11b; Frequency: 2412 MHz; Duty Cycle: 1:1

 Medium parameters used: $f = 2412$ MHz; $\sigma = 1.76$ S/m; $\epsilon_r = 40.64$; $\rho = 1000$ kg/m³; Tissue Temp (celsius)-22.5°C; Phantom section: Flat Section

DASY5 Configuration:

- Probe: EX3DV4 - SN7856; ConvF(7.08, 7.12, 7.02) @ 2412 MHz; Calibrated: 2023/12/6
- Sensor-Surface: 1.4mm (Mechanical Surface Detection)
- Electronics: DAE4 Sn1552; Calibrated: 2024/5/14
- Phantom: SAM2; Type: QD OVA 004 AA; Serial: 2089
- Measurement SW: DASY52, Version 52.10 (4); SEMCAD X Version 14.6.14 (7501)

Configuration/802.11b 2412MHz Body Front/Area Scan (11x11x1): Measurement grid: dx=12mm, dy=12mm; Maximum value of SAR (measured) = 0.448 W/kg

Configuration/802.11b 2412MHz Body Front/Zoom Scan (7x7x7)/Cube 0: Measurement grid: dx=5mm, dy=5mm, dz=5mm; Reference Value = 1.478 V/m; Power Drift = 0.16 dB

Peak SAR (extrapolated) = 0.598 W/kg

SAR(1 g) = 0.326 W/kg; SAR(10 g) = 0.172 W/kg

Smallest distance from peaks to all points 3 dB below = 14.6 mm

Ratio of SAR at M2 to SAR at M1 = 54.9%

Maximum value of SAR (measured) = 0.498 W/kg

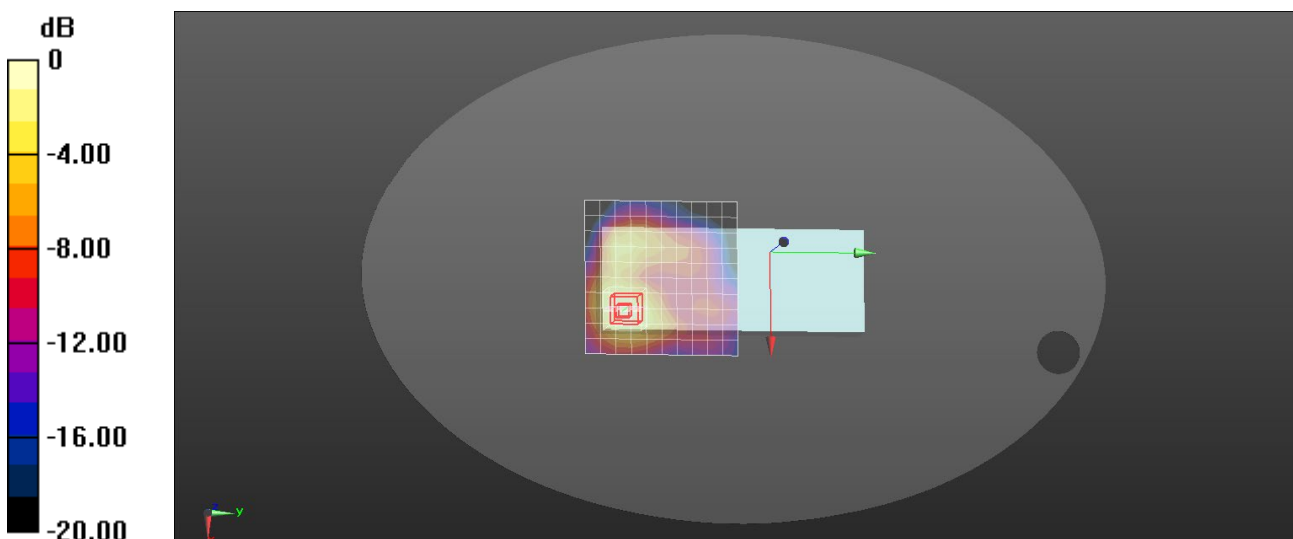

0 dB = 0.498 W/kg = -3.03 dBW/kg

Plot 9#

Test Date: 2024/07/15

DUT: Mobile Computer; Type: CK62X00
Procedure Name: 802.11a 5240MHz Body Back

Communication System: 802.11a; Frequency: 5240 MHz; Duty Cycle: 1:1

 Medium parameters used: $f = 5240$ MHz; $\sigma = 4.49$ S/m; $\epsilon_r = 35.9$; $\rho = 1000$ kg/m³; Tissue Temp (celsius)-22.5°C; Phantom section: Flat Section

DASY5 Configuration:

- Probe: EX3DV4 - SN7856; ConvF(5, 5.07, 4.96) @ 5240 MHz; Calibrated: 2023/12/6
- Sensor-Surface: 1.4mm (Mechanical Surface Detection)
- Electronics: DAE4 Sn1552; Calibrated: 2024/5/14
- Phantom: SAM2; Type: QD OVA 004 AA; Serial: 2089
- Measurement SW: DASY52, Version 52.10 (4); SEMCAD X Version 14.6.14 (7501)

Configuration/802.11a 5240MHz Body Back/Area Scan (14x13x1): Measurement grid: dx=10mm, dy=10mm; Maximum value of SAR (measured) = 1.54 W/kg

Configuration/802.11a 5240MHz Body Back/Zoom Scan (9x9x7)/Cube 0: Measurement grid: dx=4mm, dy=4mm, dz=1.4mm; Reference Value = 18.39 V/m; Power Drift = -0.17 dB

Peak SAR (extrapolated) = 2.55 W/kg

SAR(1 g) = 0.804 W/kg; SAR(10 g) = 0.315 W/kg

Smallest distance from peaks to all points 3 dB below = 10.7 mm

Ratio of SAR at M2 to SAR at M1 = 68.1%

Maximum value of SAR (measured) = 1.70 W/kg

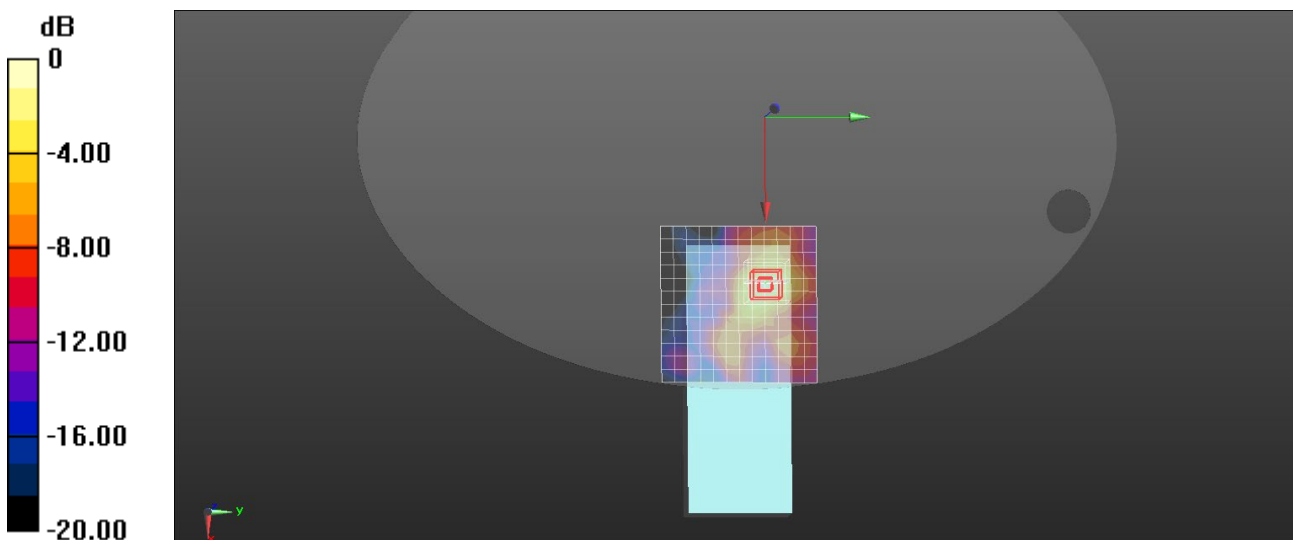

0 dB = 1.70 W/kg = 2.30 dBW/kg

Plot 10#

Test Date: 2024/07/15

DUT: Mobile Computer; Type: CK62X00**Procedure Name: 802.11ac-VHT20 5260MHz Body Back**

Communication System: 802.11ac; Frequency: 5260 MHz; Duty Cycle: 1:1

Medium parameters used: $f = 5260$ MHz; $\sigma = 4.51$ S/m; $\epsilon_r = 35.87$; $\rho = 1000$ kg/m³; Tissue Temp (celsius)-22.5°C; Phantom section: Flat Section

DASY5 Configuration:

- Probe: EX3DV4 - SN7856; ConvF(5, 5.07, 4.96) @ 5260 MHz; Calibrated: 2023/12/6
- Sensor-Surface: 1.4mm (Mechanical Surface Detection)
- Electronics: DAE4 Sn1552; Calibrated: 2024/5/14
- Phantom: SAM2; Type: QD OVA 004 AA; Serial: 2089
- Measurement SW: DASY52, Version 52.10 (4); SEMCAD X Version 14.6.14 (7501)

Configuration/802.11ac-VHT20 5260MHz Body Back/Area Scan (14x13x1): Measurement grid: dx=10mm, dy=10mm; Maximum value of SAR (measured) = 1.58 W/kg**Configuration/802.11ac-VHT20 5260MHz Body Back/Zoom Scan (8x8x7)/Cube 0:** Measurement grid: dx=4mm, dy=4mm, dz=1.4mm; Reference Value = 18.16 V/m; Power Drift = -0.02 dB

Peak SAR (extrapolated) = 2.54 W/kg

SAR(1 g) = 0.785 W/kg; SAR(10 g) = 0.300 W/kg

Smallest distance from peaks to all points 3 dB below = 10.7 mm

Ratio of SAR at M2 to SAR at M1 = 67.2%

Maximum value of SAR (measured) = 1.68 W/kg

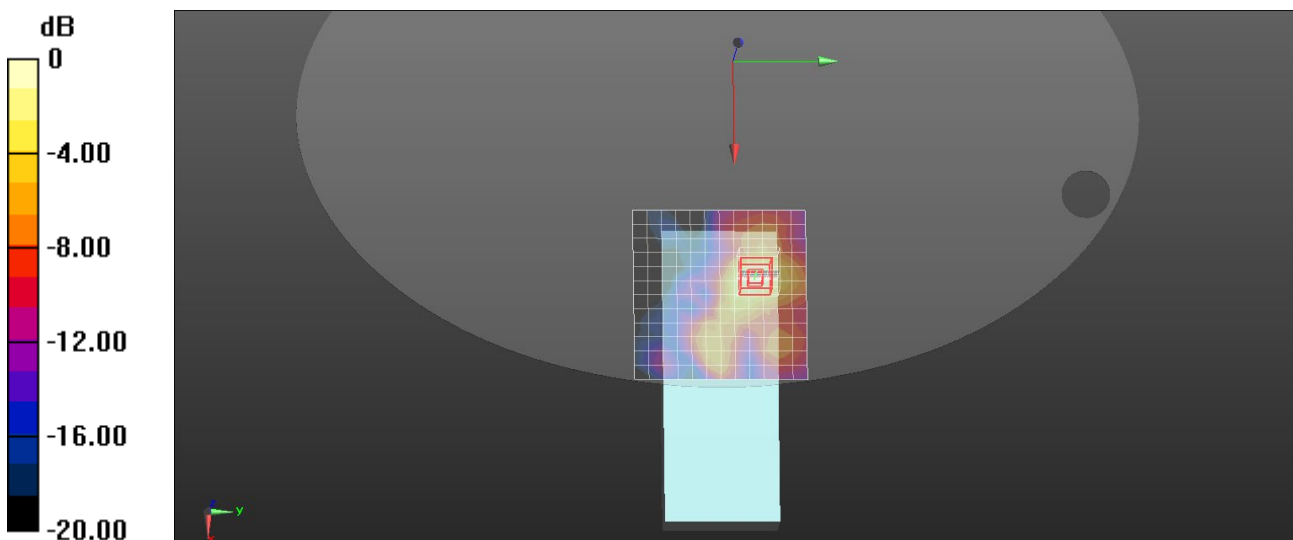

0 dB = 1.68 W/kg = 2.25 dBW/kg

Plot 11#

Test Date: 2024/07/16

DUT: Mobile Computer; Type: CK62X00**Procedure Name: 802.11ac-VHT20 5500MHz Body Back**

Communication System: 802.11ac; Frequency: 5500 MHz; Duty Cycle: 1:1

Medium parameters used: $f = 5500$ MHz; $\sigma = 4.77$ S/m; $\epsilon_r = 35.44$; $\rho = 1000$ kg/m³; Tissue Temp (celsius)-22.5°C; Phantom section: Flat Section

DASY5 Configuration:

- Probe: EX3DV4 - SN7856; ConvF(4.3, 4.33, 4.21) @ 5500 MHz; Calibrated: 2023/12/6
- Sensor-Surface: 1.4mm (Mechanical Surface Detection)
- Electronics: DAE4 Sn1552; Calibrated: 2024/5/14
- Phantom: SAM2; Type: QD OVA 004 AA; Serial: 2089
- Measurement SW: DASY52, Version 52.10 (4); SEMCAD X Version 14.6.14 (7501)

Configuration/802.11ac-VHT20 5500MHz Body Back/Area Scan (14x13x1): Measurement grid: dx=10mm, dy=10mm; Maximum value of SAR (measured) = 1.03 W/kg**Configuration/802.11ac-VHT20 5500MHz Body Back/Zoom Scan (9x9x7)/Cube 0:** Measurement grid: dx=4mm, dy=4mm, dz=1.4mm; Reference Value = 12.24 V/m; Power Drift = 0.12 dB

Peak SAR (extrapolated) = 1.67 W/kg

SAR(1 g) = 0.473 W/kg; SAR(10 g) = 0.173 W/kg

Smallest distance from peaks to all points 3 dB below = 11.3 mm

Ratio of SAR at M2 to SAR at M1 = 65.1%

Maximum value of SAR (measured) = 1.07 W/kg

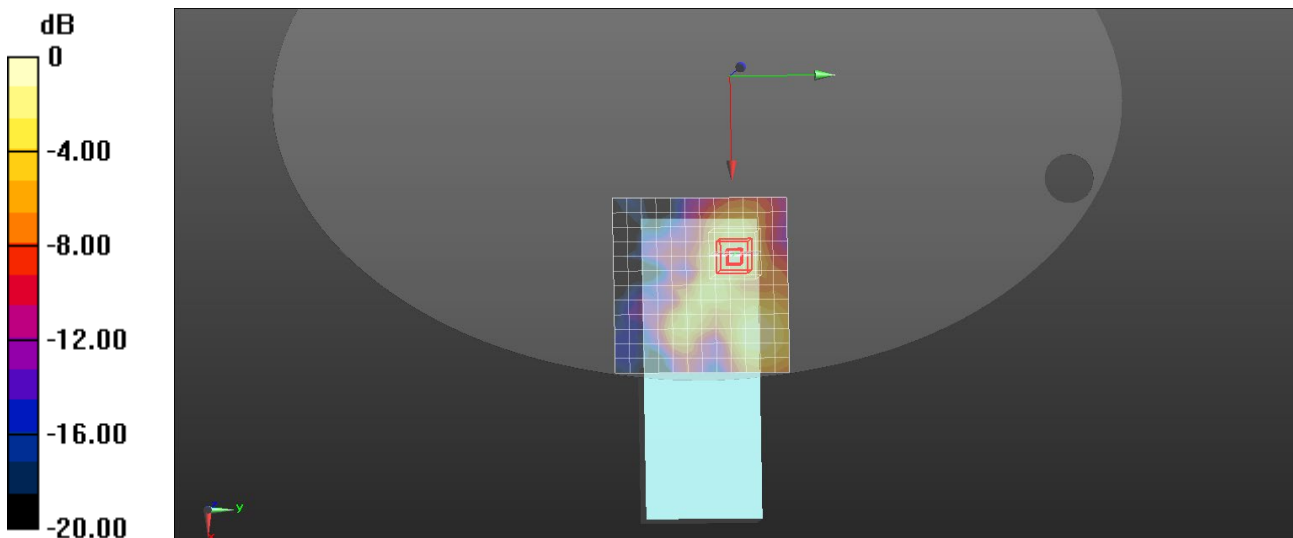

0 dB = 1.07 W/kg = 0.29 dBW/kg

Plot 12#

Test Date: 2024/07/16

DUT: Mobile Computer; Type: CK62X00
Procedure Name: 802.11ac-VHT40 5795MHz Body Back

Communication System: 802.11ac; Frequency: 5795 MHz; Duty Cycle: 1:1

 Medium parameters used: $f = 5795$ MHz; $\sigma = 5.12$ S/m; $\epsilon_r = 34.91$; $\rho = 1000$ kg/m³; Tissue Temp (celsius)-22.5°C; Phantom section: Flat Section

DASY5 Configuration:

- Probe: EX3DV4 - SN7856; ConvF(4.26, 4.29, 4.21) @ 5795 MHz; Calibrated: 2023/12/6
- Sensor-Surface: 1.4mm (Mechanical Surface Detection)
- Electronics: DAE4 Sn1552; Calibrated: 2024/5/14
- Phantom: SAM2; Type: QD OVA 004 AA; Serial: 2089
- Measurement SW: DASY52, Version 52.10 (4); SEMCAD X Version 14.6.14 (7501)

Configuration/802.11ac-VHT40 5795MHz Body Back/Area Scan (14x13x1): Measurement grid: dx=10mm, dy=10mm; Maximum value of SAR (measured) = 0.919 W/kg

Configuration/802.11ac-VHT40 5795MHz Body Back/Zoom Scan (9x9x7)/Cube 0: Measurement grid: dx=4mm, dy=4mm, dz=1.4mm; Reference Value = 10.57 V/m; Power Drift = -0.08 dB

Peak SAR (extrapolated) = 1.53 W/kg

SAR(1 g) = 0.412 W/kg; SAR(10 g) = 0.142 W/kg

Smallest distance from peaks to all points 3 dB below = 9.7 mm

Ratio of SAR at M2 to SAR at M1 = 63.7%

Maximum value of SAR (measured) = 0.959 W/kg

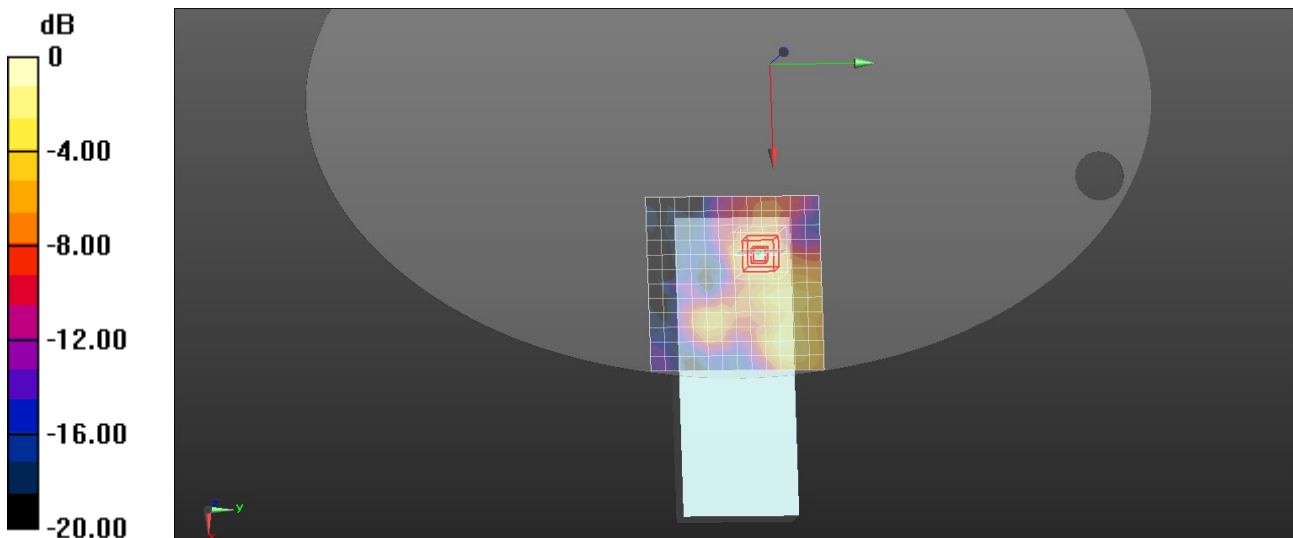

0 dB = 0.959 W/kg = -0.18 dBW/kg

Plot 13#

Measurement Report for CK62X00, BACK, U-NII-8, IEEE 802.11ax (160MHz, MCS0, 99pc duty cycle), Channel 207 (6985.000 MHz)
Device Under Test Properties

Model, Manufacturer	Dimensions [mm]	IMEI	DUT Type
CK62X00,	80.0 x 206.0 x 30.0		Phone

Exposure Conditions

Phantom Section, TSL	Position, Test Distance [mm]	Band	Group, UID	Frequency [MHz], Channel Number	Conversion Factor	TSL Conductivity [S/m]	TSL Permittivity
Flat, HSL	BACK, 0.00	U-NII-8	WLAN, 10755-AAC	6985.000, 207	4.76	6.50	32.9

Hardware Setup

Phantom	TSL, Measured Date	Probe, Calibration Date	DAE, Calibration Date
ELI V8.0 (20deg probe tilt) - 2089	HBBL-600-10000 Charge:xxxx,	EX3DV4 - SN7856, 2023-12-06	DAE4 Sn1552, 2024-05-14

Scans Setup

	Area Scan	Zoom Scan
Grid Extents [mm]	119.0 x 119.0	22.0 x 22.0 x 22.0
Grid Steps [mm]	8.5 x 8.5	3.4 x 3.4 x 1.4
Sensor Surface [mm]	3.0	1.4
Graded Grid	N/A	Yes
Grading Ratio	N/A	1.4
MAIA	Y	Y
Surface Detection	VMS + 6p	VMS + 6p
Scan Method	Measured	Measured

Measurement Results

	Area Scan	Zoom Scan
Date	2024-07-17	2024-07-17
psSAR1g [W/kg]	0.090	0.095
psSAR10g [W/kg]	0.028	0.033
psAPD (1.0cm ² , sq) [W/m ²]		0.950
psAPD (4.0cm ² , sq) [W/m ²]		0.667
Power Drift [dB]	-0.10	-0.13
Power Scaling	Disabled	Disabled
Scaling Factor [dB]		
TSL Correction	No correction	No correction
M2/M1 [%]		61.9
Dist 3dB Peak [mm]		10.4

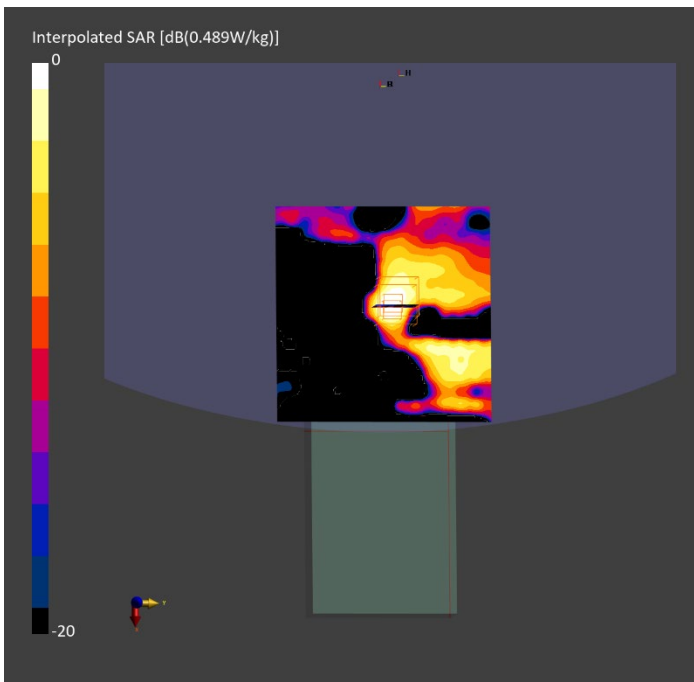

Plot 14#

Test Date: 2024/07/12

DUT: Mobile Computer; Type: CK62X00**Procedure Name: 802.11b 2412MHz Extremity Left**

Communication System: 802.11b; Frequency: 2412 MHz; Duty Cycle: 1:1

Medium parameters used: $f = 2412$ MHz; $\sigma = 1.76$ S/m; $\epsilon_r = 40.64$; $\rho = 1000$ kg/m³; Tissue Temp (celsius)-22.5°C; Phantom section: Flat Section

DASY5 Configuration:

- Probe: EX3DV4 - SN7856; ConvF(7.08, 7.12, 7.02) @ 2412 MHz; Calibrated: 2023/12/6
- Sensor-Surface: 1.4mm (Mechanical Surface Detection)
- Electronics: DAE4 Sn1552; Calibrated: 2024/5/14
- Phantom: SAM2; Type: QD OVA 004 AA; Serial: 2089
- Measurement SW: DASY52, Version 52.10 (4); SEMCAD X Version 14.6.14 (7501)

Configuration/802.11b 2412MHz Extremity Left/Area Scan (7x11x1): Measurement grid: dx=12mm, dy=12mm; Maximum value of SAR (measured) = 11.6 W/kg**Configuration/802.11b 2412MHz Extremity Left/Zoom Scan (7x7x7)/Cube 0:** Measurement grid: dx=5mm, dy=5mm, dz=5mm; Reference Value = 11.00 V/m; Power Drift = 0.18 dB

Peak SAR (extrapolated) = 19.4 W/kg

SAR(1 g) = 6.6 W/kg; SAR(10 g) = 2.19 W/kg

Smallest distance from peaks to all points 3 dB below = 5.5 mm

Ratio of SAR at M2 to SAR at M1 = 36.6%

Maximum value of SAR (measured) = 13.6 W/kg

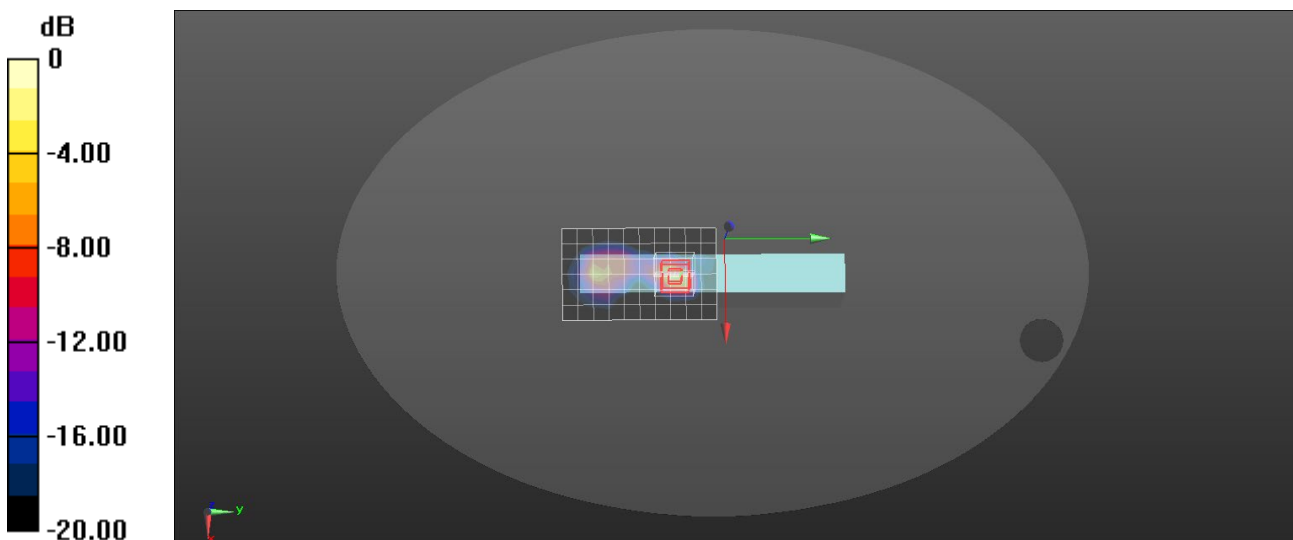

0 dB = 13.6 W/kg = 11.34 dBW/kg

Plot 15#

Test Date: 2024/07/15

DUT: Mobile Computer; Type: CK62X00
Procedure Name: 802.11a 5240MHz Extremity Left

Communication System: 802.11a; Frequency: 5240 MHz; Duty Cycle: 1:1

 Medium parameters used: $f = 5240$ MHz; $\sigma = 4.49$ S/m; $\epsilon_r = 35.9$; $\rho = 1000$ kg/m³; Tissue Temp (celsius)-22.5°C; Phantom section: Flat Section

DASY5 Configuration:

- Probe: EX3DV4 - SN7856; ConvF(5, 5.07, 4.96) @ 5240 MHz; Calibrated: 2023/12/6
- Sensor-Surface: 1.4mm (Mechanical Surface Detection)
- Electronics: DAE4 Sn1552; Calibrated: 2024/5/14
- Phantom: SAM2; Type: QD OVA 004 AA; Serial: 2089
- Measurement SW: DASY52, Version 52.10 (4); SEMCAD X Version 14.6.14 (7501)

Configuration/802.11a 5240MHz Extremity Left/Area Scan (9x14x1): Measurement grid: dx=10mm, dy=10mm; Maximum value of SAR (measured) = 14.5 W/kg

Configuration/802.11a 5240MHz Extremity Left/Zoom Scan (9x9x7)/Cube 0: Measurement grid: dx=4mm, dy=4mm, dz=1.4mm; Reference Value = 6.022 V/m; Power Drift = 0.11 dB

Peak SAR (extrapolated) = 48.2 W/kg

SAR(1 g) = 9.11 W/kg; SAR(10 g) = 2.01 W/kg

Smallest distance from peaks to all points 3 dB below = 4.3 mm

Ratio of SAR at M2 to SAR at M1 = 62.9%

Maximum value of SAR (measured) = 28.4 W/kg

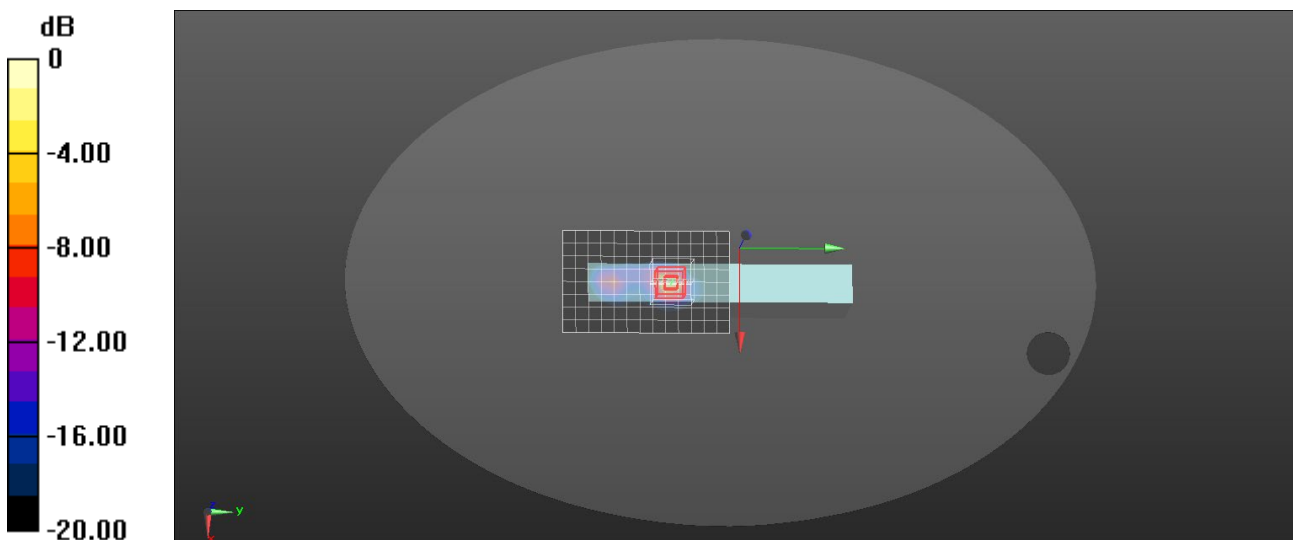

0 dB = 28.4 W/kg = 14.53 dBW/kg

Plot 16#

Test Date: 2024/07/15

DUT: Mobile Computer; Type: CK62X00**Procedure Name: 802.11ac-VHT20 5260MHz Extremity Left**

Communication System: 802.11ac; Frequency: 5260 MHz; Duty Cycle: 1:1

Medium parameters used: $f = 5260$ MHz; $\sigma = 4.51$ S/m; $\epsilon_r = 35.87$; $\rho = 1000$ kg/m³; Tissue Temp (celsius)-22.5°C; Phantom section: Flat Section

DASY5 Configuration:

- Probe: EX3DV4 - SN7856; ConvF(5, 5.07, 4.96) @ 5260 MHz; Calibrated: 2023/12/6
- Sensor-Surface: 1.4mm (Mechanical Surface Detection)
- Electronics: DAE4 Sn1552; Calibrated: 2024/5/14
- Phantom: SAM2; Type: QD OVA 004 AA; Serial: 2089
- Measurement SW: DASY52, Version 52.10 (4); SEMCAD X Version 14.6.14 (7501)

Configuration/802.11ac-VHT20 5260MHz Extremity Left/Area Scan (9x15x1): Measurement grid:

dx=10mm, dy=10mm; Maximum value of SAR (measured) = 12.4 W/kg

Configuration/802.11ac-VHT20 5260MHz Extremity Left/Zoom Scan (9x9x7)/Cube 0: Measurement grid:

dx=4mm, dy=4mm, dz=1.4mm; Reference Value = 5.367 V/m; Power Drift = 0.17 dB

Peak SAR (extrapolated) = 43.3 W/kg

SAR(1 g) = 8.36 W/kg; SAR(10 g) = 1.84 W/kg

Smallest distance from peaks to all points 3 dB below = 4.5 mm

Ratio of SAR at M2 to SAR at M1 = 63.8%

Maximum value of SAR (measured) = 25.9 W/kg

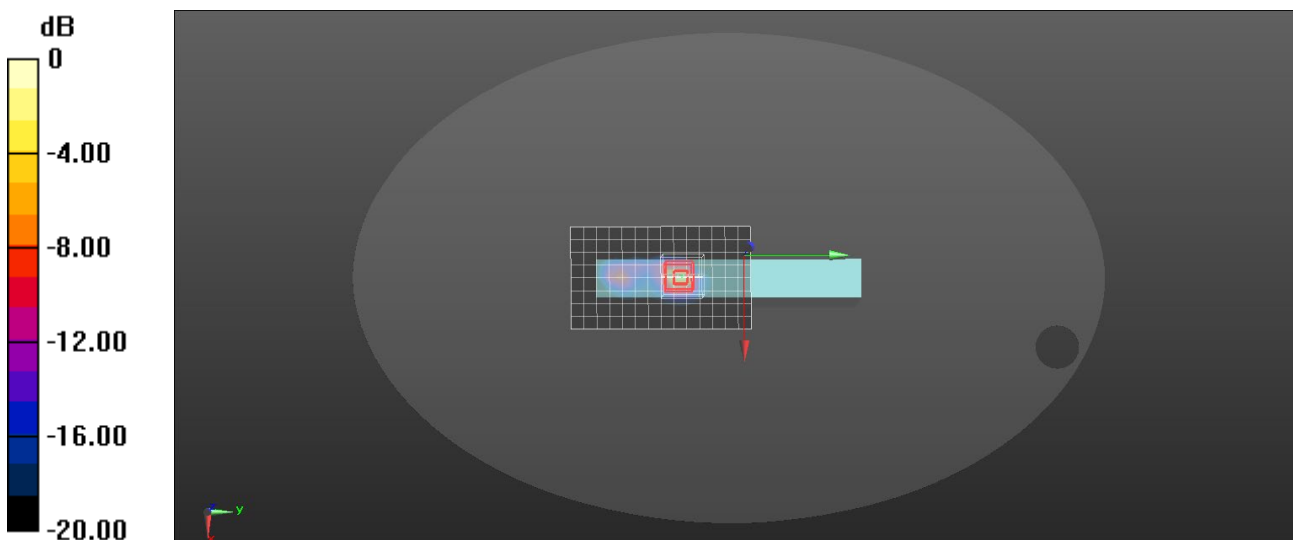

0 dB = 25.9 W/kg = 14.13 dBW/kg

Plot 17#

Test Date: 2024/07/16

DUT: Mobile Computer; Type: CK62X00
Procedure Name: 802.11ac-VHT20 5500MHz Extremity Left

Communication System: 802.11ac; Frequency: 5500 MHz; Duty Cycle: 1:1

 Medium parameters used: $f = 5500$ MHz; $\sigma = 4.77$ S/m; $\epsilon_r = 35.44$; $\rho = 1000$ kg/m³; Tissue Temp (celsius)-22.5°C; Phantom section: Flat Section

DASY5 Configuration:

- Probe: EX3DV4 - SN7856; ConvF(4.3, 4.33, 4.21) @ 5500 MHz; Calibrated: 2023/12/6
- Sensor-Surface: 1.4mm (Mechanical Surface Detection)
- Electronics: DAE4 Sn1552; Calibrated: 2024/5/14
- Phantom: SAM2; Type: QD OVA 004 AA; Serial: 2089
- Measurement SW: DASY52, Version 52.10 (4); SEMCAD X Version 14.6.14 (7501)

Configuration/802.11ac-VHT20 5500MHz Extremity Left/Area Scan (9x15x1): Measurement grid:

 $dx=10$ mm, $dy=10$ mm; Maximum value of SAR (measured) = 10.4 W/kg

Configuration/802.11ac-VHT20 5500MHz Extremity Left/Zoom Scan (9x9x7)/Cube 0: Measurement grid:

 $dx=4$ mm, $dy=4$ mm, $dz=1.4$ mm; Reference Value = 1.669 V/m; Power Drift = 0.15 dB

Peak SAR (extrapolated) = 34.5 W/kg

SAR(1 g) = 6.67 W/kg; SAR(10 g) = 1.48 W/kg

Smallest distance from peaks to all points 3 dB below = 4.5 mm

Ratio of SAR at M2 to SAR at M1 = 63.3%

Maximum value of SAR (measured) = 20.7 W/kg

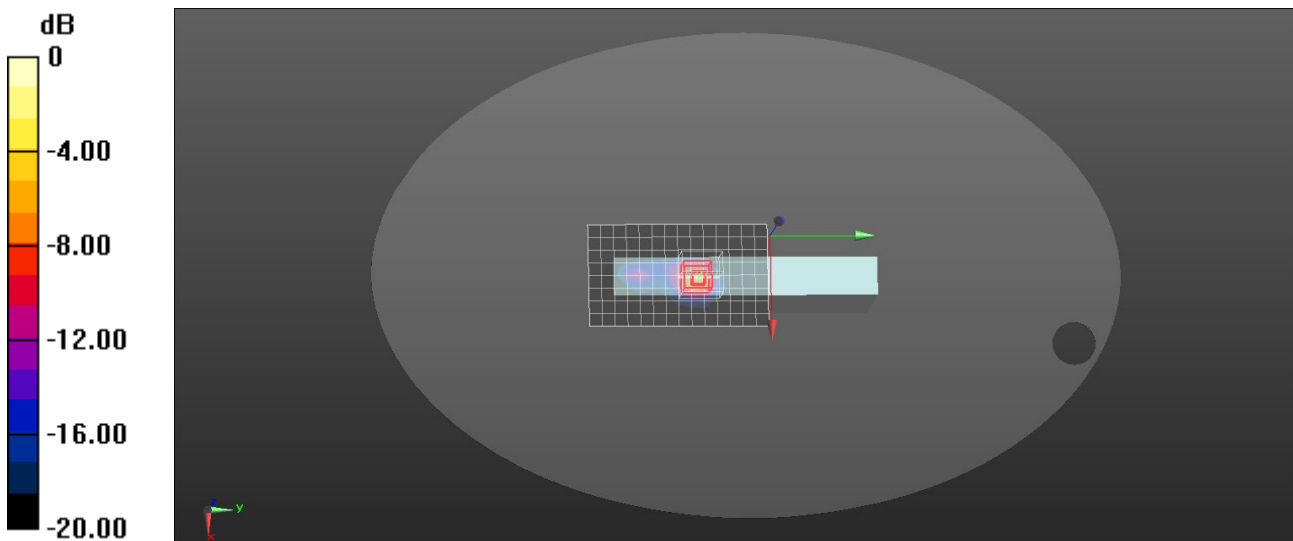

0 dB = 20.7 W/kg = 13.16 dBW/kg

Plot 18#

Test Date: 2024/07/16

DUT: Mobile Computer; Type: CK62X00**Procedure Name: 802.11ac-VHT40 5795MHz Extremity Left**

Communication System: 802.11ac; Frequency: 5795 MHz; Duty Cycle: 1:1

Medium parameters used: $f = 5795$ MHz; $\sigma = 5.12$ S/m; $\epsilon_r = 34.91$; $\rho = 1000$ kg/m³; Tissue Temp (celsius)-22.5°C; Phantom section: Flat Section

DASY5 Configuration:

- Probe: EX3DV4 - SN7856; ConvF(4.26, 4.29, 4.21) @ 5795 MHz; Calibrated: 2023/12/6
- Sensor-Surface: 1.4mm (Mechanical Surface Detection)
- Electronics: DAE4 Sn1552; Calibrated: 2024/5/14
- Phantom: SAM2; Type: QD OVA 004 AA; Serial: 2089
- Measurement SW: DASY52, Version 52.10 (4); SEMCAD X Version 14.6.14 (7501)

Configuration/802.11ac-VHT40 5795MHz Extremity Left/Area Scan (9x14x1): Measurement grid:

dx=10mm, dy=10mm; Maximum value of SAR (measured) = 20.4 W/kg

Configuration/802.11ac-VHT40 5795MHz Extremity Left/Zoom Scan (9x9x7)/Cube 0: Measurement grid:

dx=4mm, dy=4mm, dz=1.4mm; Reference Value = 6.352 V/m; Power Drift = -0.05 dB

Peak SAR (extrapolated) = 62.4 W/kg

SAR(1 g) = 10.2 W/kg; SAR(10 g) = 2.17 W/kg

Smallest distance from peaks to all points 3 dB below = 5 mm

Ratio of SAR at M2 to SAR at M1 = 61.2%

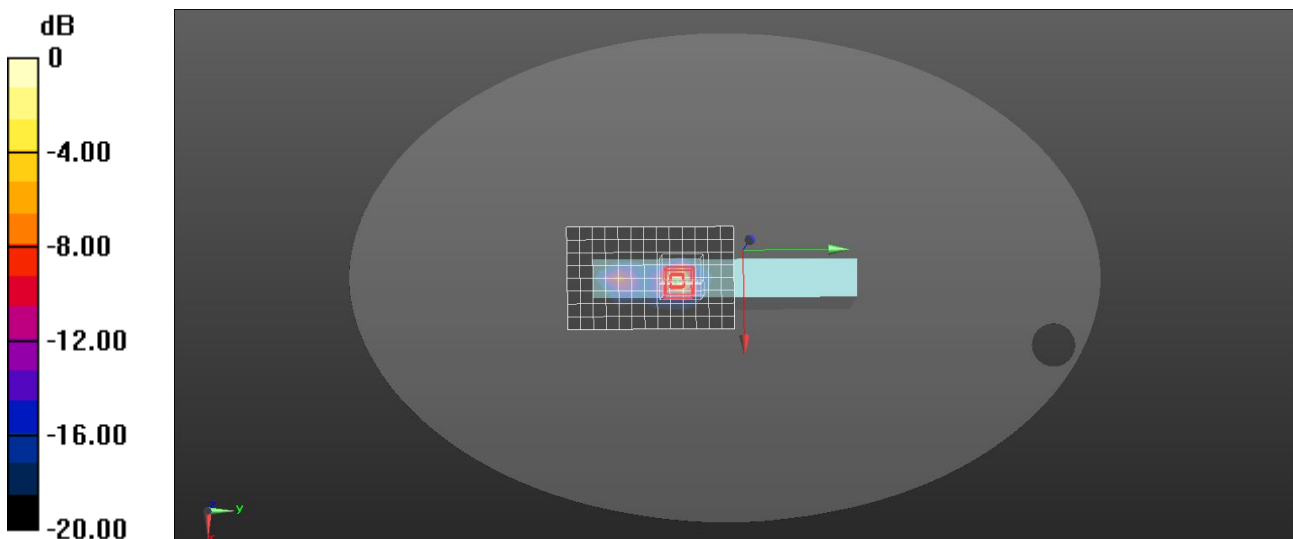

0 dB = 29.7 W/kg = 14.73 dBW/kg

Plot 19#

Measurement Report for CK62X00, EDGE LEFT, U-NII-8, IEEE 802.11ax (160MHz, MCS0, 99pc duty cycle), Channel 207 (6985.000 MHz)
Device Under Test Properties

Model, Manufacturer	Dimensions [mm]	IMEI	DUT Type
CK62X00,	206.0 x 80.0 x 30.0		Phone

Exposure Conditions

Phantom Section, TSL	Position, Test Distance [mm]	Band	Group, UID	Frequency [MHz], Channel Number	Conversion Factor	TSL Conductivity [S/m]	TSL Permittivity
Flat, HSL	EDGE LEFT, 15.00	U-NII-8	WLAN, 10755-AAC	6985.000, 207	4.76	6.50	32.9

Hardware Setup

Phantom	TSL, Measured Date	Probe, Calibration Date	DAE, Calibration Date
ELI V8.0 (20deg probe tilt) - 2089	HBBL-600-10000 Charge:xxxx,	EX3DV4 - SN7856, 2023-12-06	DAE4 Sn1552, 2024-05-14

Scans Setup

	Area Scan	Zoom Scan
Grid Extents [mm]	68.0 x 136.0	22.0 x 22.0 x 22.0
Grid Steps [mm]	8.5 x 8.5	2.8 x 2.8 x 1.2
Sensor Surface [mm]	3.0	1.4
Graded Grid	N/A	Yes
Grading Ratio	N/A	1.2
MAIA	N/A	N/A
Surface Detection	VMS + 6p	VMS + 6p
Scan Method	Measured	Measured

Measurement Results

	Area Scan	Zoom Scan
Date	2024-07-17	2024-07-17
psSAR1g [W/kg]	1.18	0.526
psSAR10g [W/kg]	0.302	0.146
psAPD (1.0cm ² , sq) [W/m ²]		5.26
psAPD (4.0cm ² , sq) [W/m ²]		3.40
Power Drift [dB]	0.10	-0.04
Power Scaling	Disabled	Disabled
Scaling Factor [dB]		
TSL Correction	No correction	No correction
M2/M1 [%]		45.2
Dist 3dB Peak [mm]		3.8

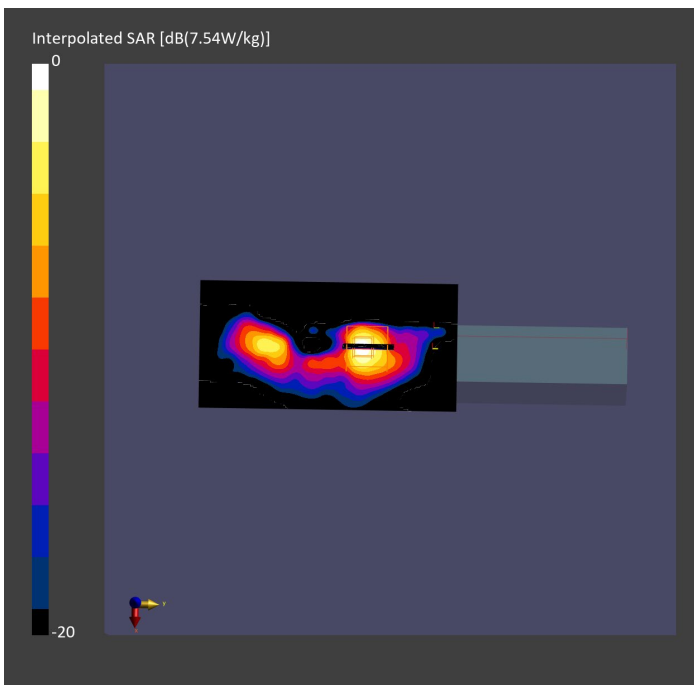

Plot 20#

Test Date: 2024/07/12

DUT: Mobile Computer; Type: CK62X00**Procedure Name: Bluetooth 2DH5 2480MHz Extremity Left**

Communication System: Bluetooth; Frequency: 2480 MHz; Duty Cycle: 1:1

Medium parameters used: $f = 2480$ MHz; $\sigma = 1.8$ S/m; $\epsilon_r = 40.53$; $\rho = 1000$ kg/m³; Tissue Temp (celsius)-22.5°C; Phantom section: Flat Section

DASY5 Configuration:

- Probe: EX3DV4 - SN7856; ConvF(7.08, 7.12, 7.02) @ 2480 MHz; Calibrated: 2023/12/6
- Sensor-Surface: 1.4mm (Mechanical Surface Detection)
- Electronics: DAE4 Sn1552; Calibrated: 2024/5/14
- Phantom: SAM2; Type: QD OVA 004 AA; Serial: 2089
- Measurement SW: DASY52, Version 52.10 (4); SEMCAD X Version 14.6.14 (7501)

Configuration/Bluetooth 2DH5 2480MHz Extremity Left/Area Scan (7x11x1): Measurement grid:

dx=12mm, dy=12mm; Maximum value of SAR (measured) = 1.27 W/kg

Configuration/Bluetooth 2DH5 2480MHz Extremity Left/Zoom Scan (7x7x7)/Cube 0: Measurement grid:

dx=5mm, dy=5mm, dz=5mm; Reference Value = 0.913 V/m; Power Drift = 0.11 dB

Peak SAR (extrapolated) = 1.88 W/kg

SAR(1 g) = 0.661 W/kg; SAR(10 g) = 0.223 W/kg

Smallest distance from peaks to all points 3 dB below = 5.8 mm

Ratio of SAR at M2 to SAR at M1 = 39.5%

Maximum value of SAR (measured) = 1.32 W/kg

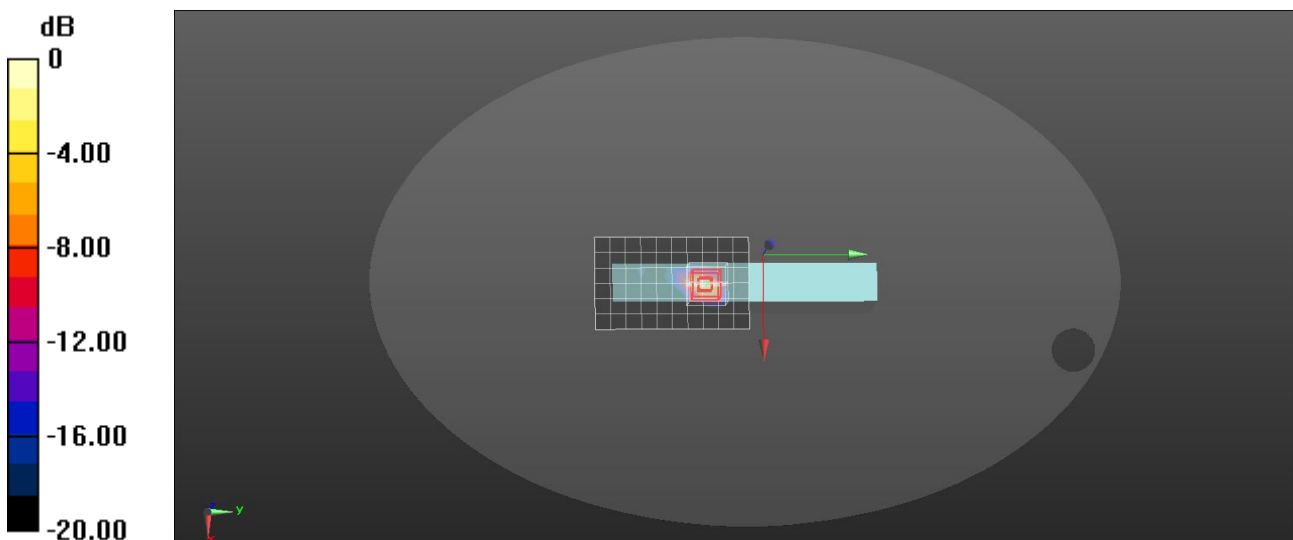

0 dB = 1.32 W/kg = 1.21 dBW/kg

Plot 21#

Test Date: 2024/07/12

DUT: Mobile Computer; Type: CK62X00

Procedure Name: 802.11b 2412MHz Extremity Left

Communication System: 802.11b; Frequency: 2412 MHz; Duty Cycle: 1:1

Medium parameters used: $f = 2412$ MHz; $\sigma = 1.76$ S/m; $\epsilon_r = 40.64$; $\rho = 1000$ kg/m³; Tissue Temp (celsius)-22.5°C; Phantom section: Flat Section

DASY5 Configuration:

- Probe: EX3DV4 - SN7856; ConvF(7.08, 7.12, 7.02) @ 2412 MHz; Calibrated: 2023/12/6
- Sensor-Surface: 1.4mm (Mechanical Surface Detection)
- Electronics: DAE4 Sn1552; Calibrated: 2024/5/14
- Phantom: SAM2; Type: QD OVA 004 AA; Serial: 2089
- Measurement SW: DASY52, Version 52.10 (4); SEMCAD X Version 14.6.14 (7501)

Configuration/802.11b 2412MHz Extremity Left/Area Scan (7x11x1): Measurement grid: dx=12mm, dy=12mm; Maximum value of SAR (measured) = 11.6 W/kg

Configuration/802.11b 2412MHz Extremity Left/Zoom Scan (7x7x7)/Cube 1: Measurement grid: dx=5mm, dy=5mm, dz=5mm; Reference Value = 11.00 V/m; Power Drift = 0.18 dB

Peak SAR (extrapolated) = 7.87 W/kg

SAR(1 g) = 2.82 W/kg; SAR(10 g) = 1.11 W/kg

Smallest distance from peaks to all points 3 dB below = 5.1 mm

Ratio of SAR at M2 to SAR at M1 = 44.8%

Maximum value of SAR (measured) = 4.84 W/kg

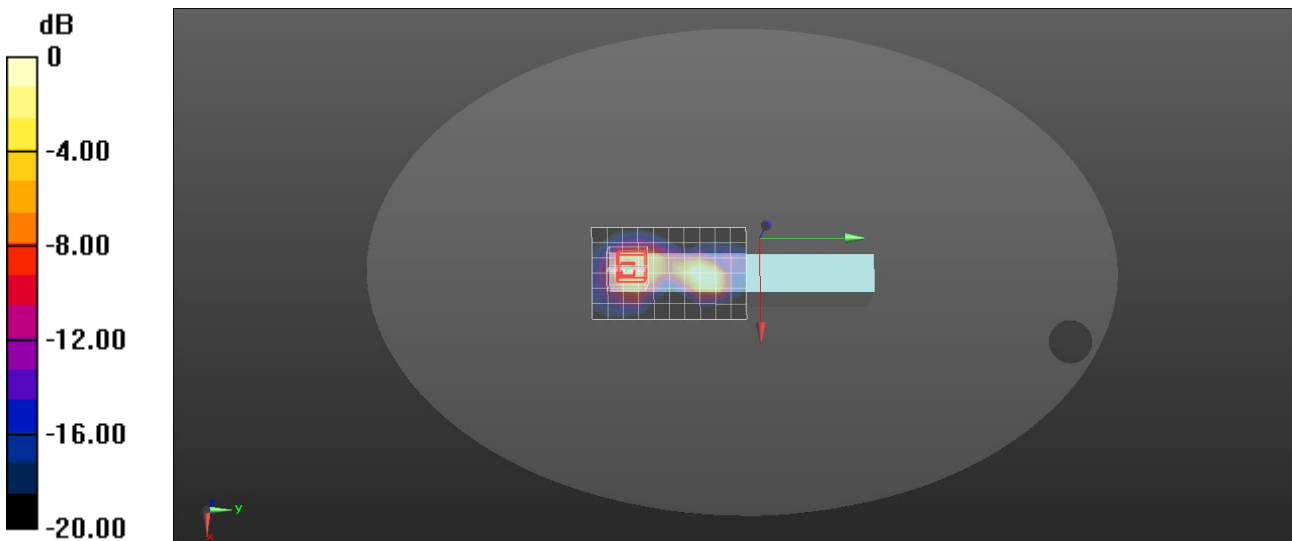

0 dB = 4.84 W/kg = 6.85 dBW/kg

Plot 22#

Test Date: 2024/07/15

DUT: Mobile Computer; Type: CK62X00
Procedure Name: 802.11a 5240MHz Extremity Back_Left

Communication System: 802.11a; Frequency: 5240 MHz; Duty Cycle: 1:1

 Medium parameters used: $f = 5240$ MHz; $\sigma = 4.49$ S/m; $\epsilon_r = 35.9$; $\rho = 1000$ kg/m³; Tissue Temp (celsius)-22.5°C; Phantom section: Flat Section

DASY5 Configuration:

- Probe: EX3DV4 - SN7856; ConvF(5, 5.07, 4.96) @ 5240 MHz; Calibrated: 2023/12/6
- Sensor-Surface: 1.4mm (Mechanical Surface Detection)
- Electronics: DAE4 Sn1552; Calibrated: 2024/5/14
- Phantom: SAM2; Type: QD OVA 004 AA; Serial: 2089
- Measurement SW: DASY52, Version 52.10 (4); SEMCAD X Version 14.6.14 (7501)

Configuration/802.11a 5240MHz Extremity Back_Left/Area Scan (13x14x1): Measurement grid:

 $dx=10$ mm, $dy=10$ mm; Maximum value of SAR (measured) = 4.93 W/kg

Configuration/802.11a 5240MHz Extremity Back_Left/Zoom Scan (8x8x7)/Cube 0: Measurement grid:

 $dx=4$ mm, $dy=4$ mm, $dz=1.4$ mm; Reference Value = 4.07 V/m; Power Drift = 0.16 dB

Peak SAR (extrapolated) = 7.55 W/kg

SAR(1 g) = 2.01 W/kg; SAR(10 g) = 0.672 W/kg

Smallest distance from peaks to all points 3 dB below = 5.8 mm

Ratio of SAR at M2 to SAR at M1 = 67.5%

Maximum value of SAR (measured) = 4.91 W/kg

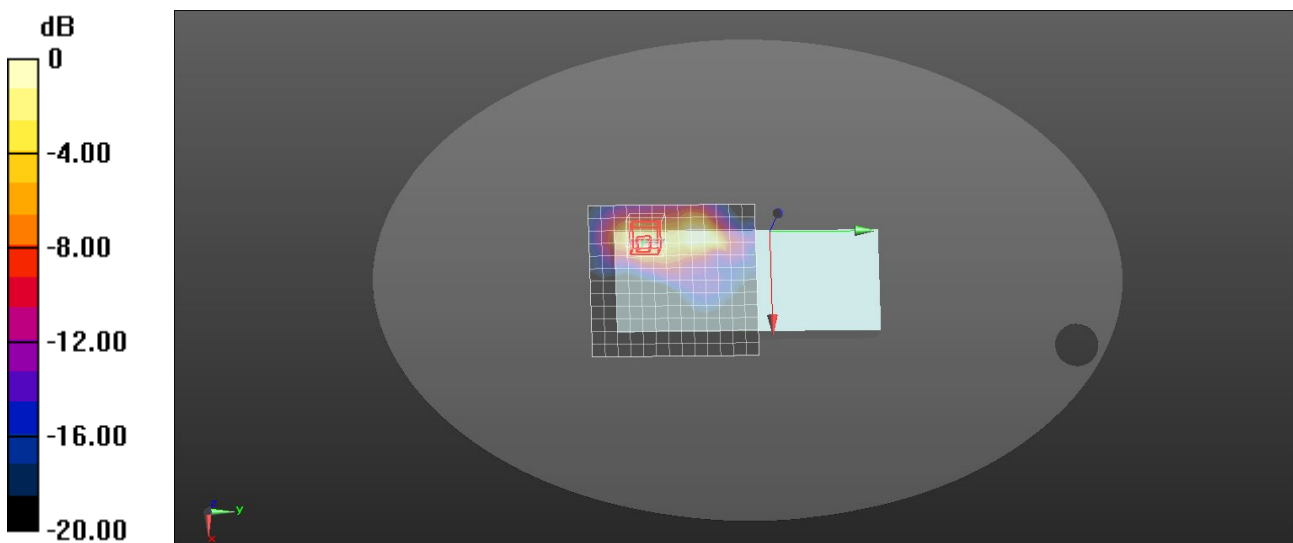

0 dB = 4.91 W/kg = 6.91 dBW/kg

Plot 23#

Test Date: 2024/07/15

DUT: Mobile Computer; Type: CK62X00**Procedure Name: 802.11ac-VHT20 5260MHz Extremity Back_Left**

Communication System: 802.11ac; Frequency: 5260 MHz; Duty Cycle: 1:1

Medium parameters used: $f = 5260$ MHz; $\sigma = 4.51$ S/m; $\epsilon_r = 35.87$; $\rho = 1000$ kg/m³; Tissue Temp (celsius)-22.5°C; Phantom section: Flat Section

DASY5 Configuration:

- Probe: EX3DV4 - SN7856; ConvF(5, 5.07, 4.96) @ 5260 MHz; Calibrated: 2023/12/6
- Sensor-Surface: 1.4mm (Mechanical Surface Detection)
- Electronics: DAE4 Sn1552; Calibrated: 2024/5/14
- Phantom: SAM2; Type: QD OVA 004 AA; Serial: 2089
- Measurement SW: DASY52, Version 52.10 (4); SEMCAD X Version 14.6.14 (7501)

Configuration/802.11ac-VHT20 5260MHz Extremity Back_Left/Area Scan (13x14x1): Measurement grid: dx=10mm, dy=10mm; Maximum value of SAR (measured) = 5.19 W/kg**Configuration/802.11ac-VHT20 5260MHz Extremity Back_Left/Zoom Scan (7x7x7)/Cube 1:**

Measurement grid: dx=4mm, dy=4mm, dz=1.4mm; Reference Value = 3.504 V/m; Power Drift = 0.12 dB

Peak SAR (extrapolated) = 6.30 W/kg

SAR(1 g) = 1.73 W/kg; SAR(10 g) = 0.575 W/kg

Smallest distance from peaks to all points 3 dB below = 5.4 mm

Ratio of SAR at M2 to SAR at M1 = 68.6%

Maximum value of SAR (measured) = 4.01 W/kg

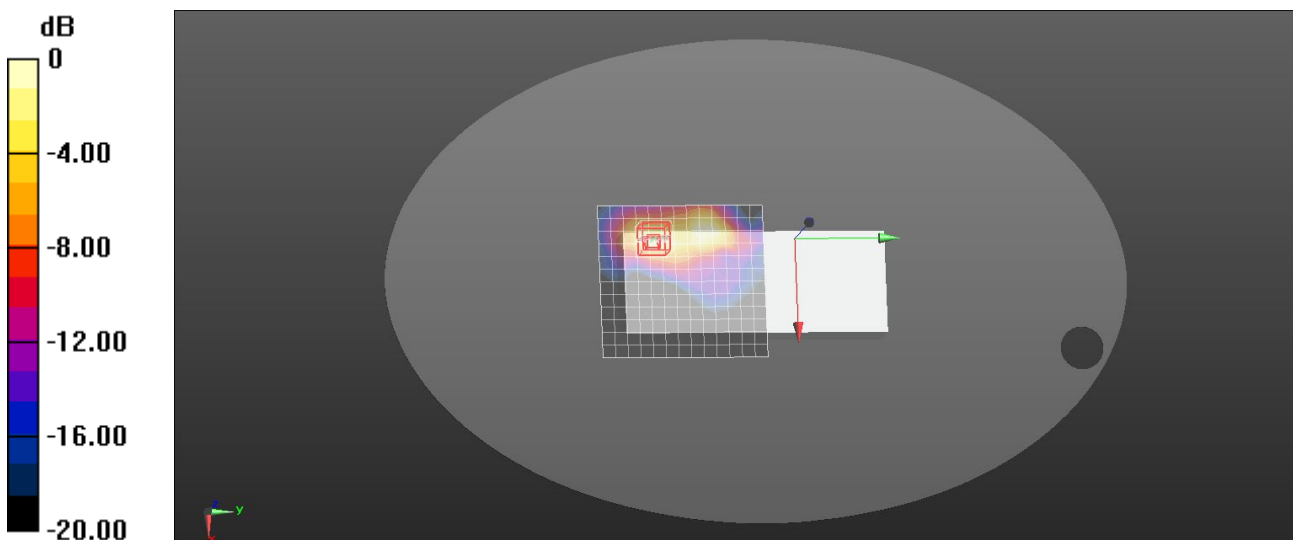

0 dB = 4.01 W/kg = 6.03 dBW/kg

Plot 24#

Test Date: 2024/07/16

DUT: Mobile Computer; Type: CK62X00

Procedure Name: 802.11ac-VHT20 5500MHz Extremity Back_Left

Communication System: 802.11ac; Frequency: 5500 MHz; Duty Cycle: 1:1

Medium parameters used: $f = 5500$ MHz; $\sigma = 4.77$ S/m; $\epsilon_r = 35.44$; $\rho = 1000$ kg/m³; Tissue Temp (celsius)-22.5°C; Phantom section: Flat Section

DASY5 Configuration:

- Probe: EX3DV4 - SN7856; ConvF(4.3, 4.33, 4.21) @ 5500 MHz; Calibrated: 2023/12/6
- Sensor-Surface: 1.4mm (Mechanical Surface Detection)
- Electronics: DAE4 Sn1552; Calibrated: 2024/5/14
- Phantom: SAM2; Type: QD OVA 004 AA; Serial: 2089
- Measurement SW: DASY52, Version 52.10 (4); SEMCAD X Version 14.6.14 (7501)

Configuration/802.11ac-VHT20 5500MHz Extremity Back_Left/Area Scan (13x14x1): Measurement grid: dx=10mm, dy=10mm; Maximum value of SAR (measured) = 7.49 W/kg

Configuration/802.11ac-VHT20 5500MHz Extremity Back_Left/Zoom Scan (8x8x7)/Cube 0:

Measurement grid: dx=4mm, dy=4mm, dz=1.4mm; Reference Value = 0.7280 V/m; Power Drift = 0.16 dB

Peak SAR (extrapolated) = 12.2 W/kg

SAR(1 g) = 2.94 W/kg; SAR(10 g) = 0.856 W/kg

Smallest distance from peaks to all points 3 dB below = 4.9 mm

Ratio of SAR at M2 to SAR at M1 = 67.3%

Maximum value of SAR (measured) = 7.48 W/kg

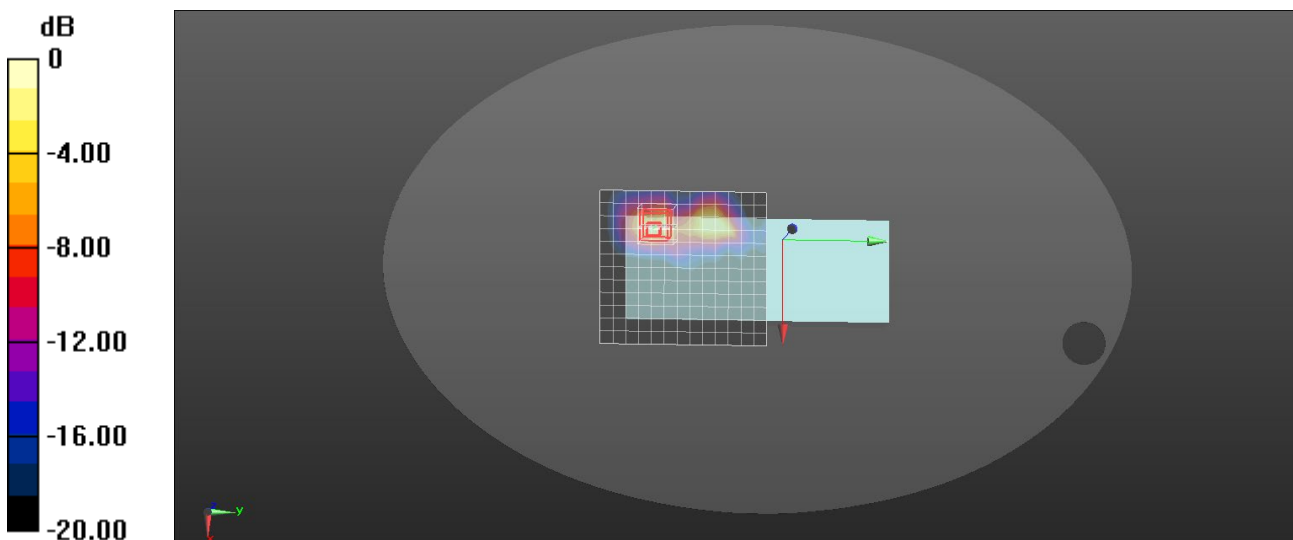

0 dB = 7.48 W/kg = 8.74 dBW/kg

Plot 25#

Test Date: 2024/07/16

DUT: Mobile Computer; Type: CK62X00

Procedure Name: 802.11ac-VHT40 5795MHz Extremity Back_Left

Communication System: 802.11ac; Frequency: 5795 MHz; Duty Cycle: 1:1

Medium parameters used: $f = 5795$ MHz; $\sigma = 5.12$ S/m; $\epsilon_r = 34.91$; $\rho = 1000$ kg/m³; Tissue Temp (celsius)-22.5°C; Phantom section: Flat Section

DASY5 Configuration:

- Probe: EX3DV4 - SN7856; ConvF(4.26, 4.29, 4.21) @ 5795 MHz; Calibrated: 2023/12/6
- Sensor-Surface: 1.4mm (Mechanical Surface Detection)
- Electronics: DAE4 Sn1552; Calibrated: 2024/5/14
- Phantom: SAM2; Type: QD OVA 004 AA; Serial: 2089
- Measurement SW: DASY52, Version 52.10 (4); SEMCAD X Version 14.6.14 (7501)

Configuration/802.11ac-VHT40 5795MHz Extremity Back_Left/Area Scan (13x14x1): Measurement grid:

$dx=10$ mm, $dy=10$ mm; Maximum value of SAR (measured) = 10.4 W/kg

Configuration/802.11ac-VHT40 5795MHz Extremity Back_Left/Zoom Scan (9x9x7)/Cube 0:

Measurement grid: $dx=4$ mm, $dy=4$ mm, $dz=1.4$ mm

Reference Value = 2.043 V/m; Power Drift = 0.07 dB

Peak SAR (extrapolated) = 11.6 W/kg

SAR(1 g) = 2.36 W/kg; SAR(10 g) = 0.649 W/kg

Smallest distance from peaks to all points 3 dB below = 4.8 mm

Ratio of SAR at M2 to SAR at M1 = 61.9%

Maximum value of SAR (measured) = 6.79 W/kg

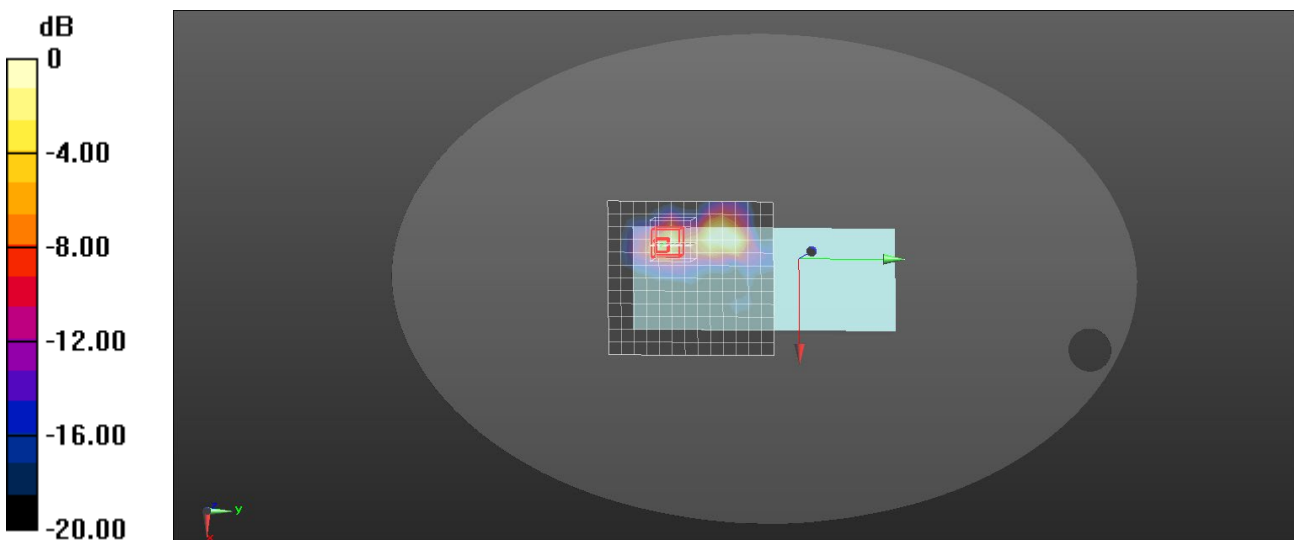

0 dB = 6.79 W/kg = 8.32 dBW/kg

Plot 26#

Measurement Report for CK62X00, EDGE LEFT, U-NII-8, IEEE 802.11ax (160MHz, MCS0, 99pc duty cycle), Channel 207 (6985.000 MHz)
Device Under Test Properties

Model, Manufacturer	Dimensions [mm]	IMEI	DUT Type
CK62X00,	206.0 x 80.0 x 30.0		Phone

Exposure Conditions

Phantom Section, TSL	Position, Test Distance [mm]	Band	Group, UID	Frequency [MHz], Channel Number	Conversion Factor	TSL Conductivity [S/m]	TSL Permittivity
Flat, HSL	EDGE LEFT, 15.00	U-NII-8	WLAN, 10755-AAC	6985.000, 207	4.76	6.50	32.9

Hardware Setup

Phantom	TSL, Measured Date	Probe, Calibration Date	DAE, Calibration Date
ELI V8.0 (20deg probe tilt) - 2089	HBBL-600-10000 Charge:xxxx,	EX3DV4 - SN7856, 2023-12-06	DAE4 Sn1552, 2024-05-14

Scans Setup

	Area Scan	Zoom Scan
Grid Extents [mm]	68.0 x 136.0	22.0 x 22.0 x 22.0
Grid Steps [mm]	8.5 x 8.5	3.4 x 3.4 x 1.4
Sensor Surface [mm]	3.0	1.4
Graded Grid	N/A	Yes
Grading Ratio	N/A	1.4
MAIA	Y	N/A
Surface Detection	VMS + 6p	VMS + 6p
Scan Method	Measured	Measured

Measurement Results

	Area Scan	Zoom Scan
Date	2024-07-17	2024-07-17
psSAR1g [W/kg]	0.962	0.670
psSAR10g [W/kg]	0.251	0.168
psAPD (1.0cm ² , sq) [W/m ²]		6.70
psAPD (4.0cm ² , sq) [W/m ²]		3.97
Power Drift [dB]	-0.15	-0.03
Power Scaling	Disabled	Disabled
Scaling Factor [dB]		
TSL Correction	No correction	No correction
M2/M1 [%]		49.3
Dist 3dB Peak [mm]		3.4

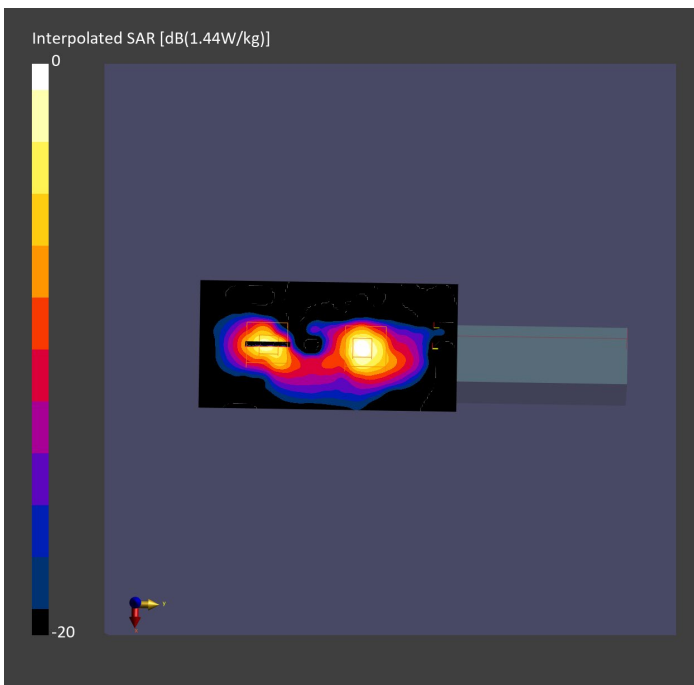

Plot 27#

Measurement Report for CK62X00, EDGE LEFT, U-NII-8, IEEE 802.11ax (160MHz, MCS0, 99pc duty cycle), Channel 207 (6985.0 MHz)
Device Under Test Properties

Model, Manufacturer	Dimensions [mm]	IMEI	DUT Type
CK62-0,	206.0 x 80.0 x 30.0		Phone

Exposure Conditions

Phantom Section	Position, Test Distance [mm]	Band	Group, UID	Frequency [MHz], Channel Number	Conversion Factor
5G	EDGE LEFT, 2.00	U-NII-8	WLAN, 10755-AAC	6985.0, 207	1.0

Hardware Setup

Phantom	Medium	Probe, Calibration Date	DAE, Calibration Date
mmWave - 1086	Air -	EUmmWV4 - SN9596_F1-55GHz, 2024-02-08	DAE4 Sn1552, 2024-05-14

Scans Setup

Scan Type	5G Scan
Grid Extents [mm]	30.0 x 30.0
Grid Steps [lambda]	0.047559807339951216 x 0.047559807339951216
Sensor Surface [mm]	2.0
MAIA	Y

Measurement Results

Scan Type	5G Scan
Date	2024-07-18
Avg. Area [cm ²]	4.00
psPDn+ [W/m ²]	2.21
psPDtot+ [W/m ²]	3.88

psPDmod+ [W/m ²]	7.38
E _{max} [V/m]	70.1
Power Drift [dB]	0.12

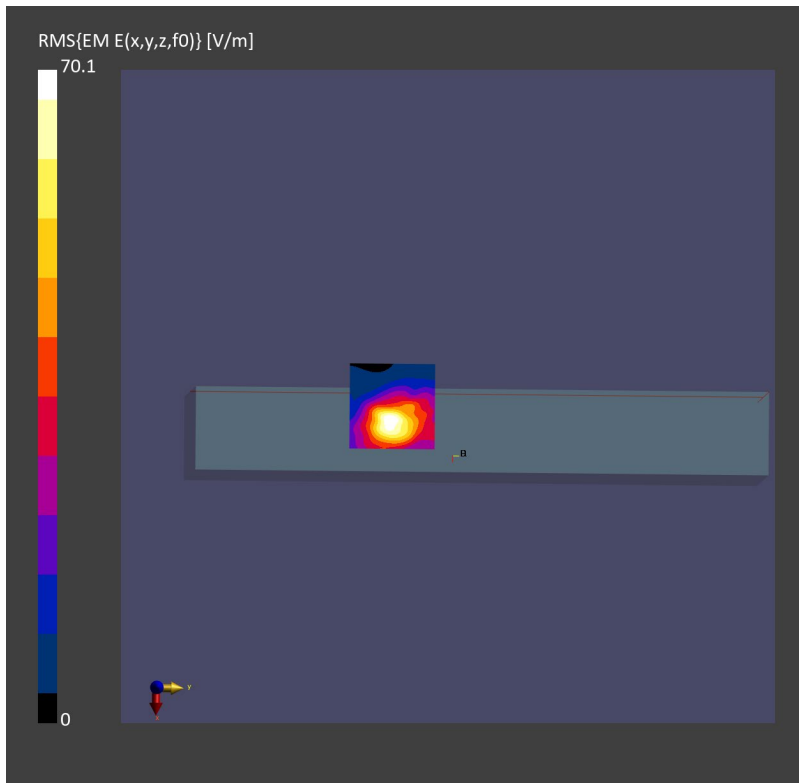

Annex C - SAR Test Setup Photograph

Please refer to "2406RSU006-UT".

Annex D - EUT Photograph

Please refer to "2406RSU006-UE".

Annex E - Equipment Calibration Report

Please refer to document "Annex E - Equipment Calibration Report.pdf".

————— The End —————