



Certificate No. : 4271.01

**Prüfbericht – Produkte**

Test Report - Products

Prüfbericht-Nr.: <i>Test report no.:</i>	IN2391GP 001	Auftrags-Nr.: <i>Order no.:</i>	146742972 0010	Seite 1 von 229 Page 1 of 229	
Kunden-Referenz-Nr.: <i>Client reference no.:</i>	2119359	Auftragsdatum: <i>Order date:</i>	2022-12-06		
Auftraggeber: <i>Client:</i>	HONEYWELL INTERNATIONAL INC, Honeywell Safety and Productivity Solutions 9680 OLD BAILES RD, FORT MILL, SC 29707, USA				
Prüfgegenstand: <i>Test item:</i>	HWBPC11AX-PRTM	Product Type	Wi-Fi BT Module		
Bezeichnung.: <i>Identification.:</i>	HWBPC11AX-PRT				
Auftrags-Inhalt: <i>Order content:</i>	Testing and issue of Test Report and Grant Certificate				
Prüfgrundlage: <i>Test specification:</i>	FCC Part 15 Subpart C 15.247, 15.207, 15.205 & 15.209 RSS 247 Issue 2 and RSS GEN Issue 5				
Wareneingangsdatum: <i>Date of sample receipt:</i>	2022-12-07				
Prüfmuster-Nr & Serien-Nr.: <i>Test sample no & serial no.:</i>	A003385546-022 & A003385546-04 2022120701 & 2022120702				
Prüfzeitraum: <i>Testing period:</i>	2022-12-07 - 2023-01-06				
Ort der Prüfung: <i>Place of testing:</i>	Wireless laboratory, Bangalore				
Prüflaboratorium: <i>Testing laboratory:</i>	TÜV Rheinland (India) Pvt.Ltd., 27/B, 2nd Cross, Electronic City Phase1 Bangalore -560 100, India FCC Test site registration number: 496599 ISED Test site registration number: 3466E-1				
Prüfergebnis*: <i>Test result*:</i>	Pass				
geprüft von: <i>tested by:</i>		genehmigt von: <i>authorized by:</i>			
Datum: <i>Date:</i>	2023-01-07	Ausstattatum: <i>Issue date:</i>	2023-02-28		
Stellung / Position:	Likhithesh M D Senior Engineer	Stellung / Position:	Madhu K.N Senior Engineer		
Sonstiges / Other:	FCC ID: HD5-PC11AX IC: 1693B-PC11AX				
Zustand des Prüfgegenstandes bei Anlieferung: <i>Condition of the test item at delivery:</i>	Prüfmuster vollständig und unbeschädigt Test item complete and undamaged				
* Legende:	1 = sehr gut P(ass) = entspricht o.g. Prüfgrundlage(n)	2 = gut F(ail) = entspricht nicht o.g. Prüfgrundlage(n)	3 = befriedigend F(ail) = entspricht nicht o.g. Prüfgrundlage(n)	4 = ausreichend N/A = nicht anwendbar	5 = N/T = nicht getestet 5 = poor N/T = not tested
* Legend:	1 = very good P(ass) = passed a.m. test specification(s)	2 = good F(ail) = failed a.m. test specification(s)	3 = satisfactory F(ail) = failed a.m. test specification(s)	4 = sufficient N/A = not applicable	
Dieser Prüfbericht bezieht sich nur auf das o.g. Prüfmuster und darf ohne Genehmigung der Prüfstelle nicht auszugsweise vervielfältigt werden. Dieser Bericht berechtigt nicht zur Verwendung eines Prüfzeichens. <i>This test report only relates to the a. m. test sample. Without permission of the test center this test report is not permitted to be duplicated in extracts. This test report does not entitle to carry any test mark.</i>					

v05

Prüfbericht - Nr.:
Test Report No.:

IN2391GP 001

Seite 2 von 229
Page 2 of 229

TEST SUMMARY

Test Item	Applicable Standard		Result
	FCC	ISED	
Maximum conducted output power	FCC 15.247(b)(3)	RSS 247 Issue 2, Section 5.4 (d)	Pass
Maximum Power Spectral Density	FCC 15.247(e)	RSS 247 Issue 2, Section 5.2 (b)	Pass
DTS Bandwidth	FCC 15.247(a)(2)	RSS 247 Issue 2, Section 5.2 (a)	Pass
Emissions in non-restricted frequency bands	FCC 15.247(d)	RSS 247 Issue 2, Section 5.5	Pass
Spurious Radiated Emissions and Restricted Bands of Operation	FCC 15.209 / FCC 15.205	RSS-Gen Issue 5, Section 8.9 / 8.10	Pass
Conducted Emissions on a.c Power Lines	FCC 15.207	RSS-Gen Issue 5, Section 8.8	Pass

Product Category: Electronics Testing
Test Discipline: EMC Test Facility

Compliance statement for Part 15.203:

"THE ANTENNA WITH A STANDARD CONNECTOR (U.FL) USED, WITH NO POSSIBILITY OF REPLACEMENT WITH A NON-APPROVED ANTENNA BY THE END-USER. THEREFORE, THE EUT IS CONSIDERED TO COMPLY WITH THIS PROVISION."

Prüfbericht - Nr.:
Test Report No.:

IN2391GP 001

Seite 3 von 229
Page 3 of 229

REVISION HISTORY OF THIS REPORT

Report Number	Version	Description	Issue date
IN2391GP 001	01	Initial Issue of Test Report	14-02-2023
IN2391GP 001	01	Updated Reviewer Comments	28-02-2023

Table of Contents

1	GENERAL REMARKS.....	6
1.1	Attachments	6
2	TEST SITES.....	7
2.1	Testing Facilities	7
2.2	List of Test and Measurement Instruments	7
3	GENERAL PRODUCT INFORMATION	8
3.1	Product Function and Intended Use	8
3.2	Ratings and System Details of Equipment under Test	8
3.3	Measurement Uncertainty:.....	9
4	TEST SET-UP AND OPERATION MODE.....	10
4.1	Principle of Configuration Selection.....	10
4.2	UUT Operation and Software	10
4.3	Special Accessories and Auxiliary Equipment	10
4.4	Simultaneous Transmission.....	10
4.5	Countermeasures to achieve EMC Compliance	10
4.6	List of frequencies	10
4.7	Report references.....	11
5	Operational Description	12
6	TEST METHODOLOGY.....	13
6.1	Conducted Spurious Emission Test on AC Power Line.....	13
6.1.1	Test Setup Configuration.....	13
6.2	Radiated Emission Test.....	14
6.2.1	Test Setup Configuration.....	14
7	TEST RESULTS FOR WI-FI.....	16
7.1	Maximum Average Conducted Output Power.....	16
7.2	Maximum Power Spectral Density.....	40
7.3	DTS Bandwidth & 99% Bandwidth	74
7.4	Emissions in non-restricted frequency bands and Conducted Spurious Emission	113
7.4.1	Out-Of-Band Emissions	114
7.5	Spurious Radiated Emissions & Restricted Bands of Operation	141

8	TEST RESULTS FOR BLUETOOTH LOW ENERGY	198
8.1	Maximum Peak Conducted Output Power	198
8.2	Maximum Power Spectral Density	201
8.3	DTS Bandwidth & 99% Bandwidth	204
8.4	Emissions in non-restricted frequency bands and Conducted Spurious Emission	206
8.4.1	Out-Of-Band Emissions	207
8.4.2	Band edge and reference plots	209
8.4.3	Out-Of-Band Emissions	210
8.5	Spurious Radiated Emissions & Restricted Bands of Operation	212
9	Conducted Spurious Emission Test on AC Power Line	225
10	LIST OF TABLES	228
11	LIST OF FIGURES	228
12	Power level used for testing	228

1 GENERAL REMARKS

1.1 Attachments

All attachments are part of this test report and are issued in separate document

- 1: TEST SETUP PHOTOS
- 2: EUT EXTERNAL PHOTOS
- 3: EUT INTERNAL PHOTOS
- 4: FCC LABEL AND LABEL LOCATION
- 5: BLOCK DIAGRAM
- 6: SPECIFICATION OF EUT
- 7: SCHEMATIC DIAGRAM
- 8: BILL OF MATERIAL
- 9: USER MANUAL
- 10: MAXIMUM PERMISSIBLE EXPOSURE INFORMATION

2 TEST SITES

2.1 Testing Facilities

- | | |
|--|---|
| <p>1. TÜV Rheinland (India) Pvt.Ltd.,
27/B, 2nd Cross,
ElectronicCityPhase1
Bangalore – 560 100,
India</p> | <p>2. TUV Rheinland (India) Pvt.Ltd.,
108 , Beside ISBR Business School,
Electronic city Phase I
Bangalore - 560 100.
India</p> |
|--|---|

Radiated Measurement site type :
Fully anechoic chamber (used for above 1 GHz measurements)

Radiated Measurement site type :
Semi anechoic chamber (used for below 1 GHz measurements)

2.2 List of Test and Measurement Instruments

Table 1: List of test and measurement instruments

Equipment	Manufacturer	Model Name	Serial Number	Firmware Versions	Calibration Due Date	Periodicity	Test Facility
EMI Receiver	Rohde & Schwarz	ESW 44	101732	4.73 SP5	04.08.2023	Yearly	Radiated Spurious Emission
Active loop antenna	Frankonia	LAX-10	LAX-10-800	-	31.01.2023	Yearly	
Baloon and Biconical Antenna	Schw arzbeck mess-elektronik	VHBB-9124 / BBA-9106	01028	-	03.02.2023	Yearly	
Log-Periodic Antenna	Schw arzbeck mess-elektronik	VUSLP-9111B	9111B-111	-	26.01.2023	Yearly	
Horn Antenna	Schw arzbeck	BBHA 9120 D	9120D-01944	-	11.10.2023	Yearly	
EMI Test Receiver	Rohde & Schwarz	ESW44	101773	1.72.SP1	12.02.2023	Yearly	
Semi Anechoic Chamber	Frankonia	-	-	-	-	-	
Fully Anechoic Chamber	Albatross	-	-	-	-	-	
Spectrum Analyzer	Agilent	E4407B	US41192772	A.14.07	21-12-2023	Yearly	Conducted Test Parameters
Signal Analyser	Rohde & Schwarz	FSV7	101644	FW 3.40	25-01-2023	Yearly	
Signal Analyser	Anritsu Corporation	MS2830A	6261983953	-	18-10-2023	Yearly	
EMI Receiver	Rohde & Schwarz	ESR7	101133	3.48 SP3	22.07.2023	Yearly	Conducted AC Power line Test
Line Impedance Stabilization Network	Rohde & Schwarz	ENV 216	101434	-	11.04.2023	Yearly	
Pulse Limiter	Rohde & Schwarz	ESH3-Z2	100811	-	12.07.2023	Yearly	

Table 2: Instrument application Software versions

SL. No.	Test Type	Application software	Version
1	Radiated spurious emission measurement in 10mtr-SAC	BAT EMC	3.20.0.17
2	Radiated spurious emission measurement in FAC	EMC 32	10.60.20
3	Conducted Mesaurment	WMS 32	11.10.00

3 GENERAL PRODUCT INFORMATION

3.1 Product Function and Intended Use

HWBPC11AX-PRTM is a carrier board with System on Module. The module to be used inside the Honeywell Products. The Module has Dual Band WIFI (2.4GHz & 5GHz) and BLUETOOTH radio interface. This module communicates with external host using SDIO interface for WIFI and UART for BLUETOOTH.

This Module supports 802.11a/b/g/n/ac/ax for WIFI and Supports BT (Basic , EDR & BLE) The module will act as Access Point / Master only in NON - DFS bands. In the DFS band, the Module acts as Slave /Station device which do not have Radar detection functionality.

Powered with BC43752, **HWBPC11AX-PRTM** achieve the best possible connectivity and performance in RF Environment.

This Module will be used to provide the WIFI & BLUETOOTH wireless connectivity for Honeywell Products

3.2 Ratings and System Details of Equipment under Test

Table 3: Ratings and System Details as declared by Client*

Radio Protocol	Wi-Fi	BLE
Operating Frequency Range	2412MHz to 2462MHz	2402MHz to 2480MHz
No. of Channels	11 (Refer Table 5)	40 (Refer Table 6)
Channel Spacing	5MHz	2MHz
Transmitting Power Level	Refer clause 11	
Maximum Measured Power (e.i.r.p)	1001932PT(Flex/PCB Antenna) 26.70 dBm (802.11ax_HE40 _MCS0 2437MHz) FPA3020-10A (Flex/PCB Antenna) 28.64 dBm (802.11ac_VHT40 _MCS0 2437MHz)	1001932PT(Flex/PCB Antenna) 10.41 dBm(1 Mbps 2440MHz) FPA3020-10A (Flex/PCB Antenna) 12.14 dBm(1 Mbps 2440MHz)
Modulation	20MHz: 802.11b: DSSS (1Mbps,11Mbps) 802.11g: OFDM (6Mbps, 54Mbps) 802.11n: OFDM (20MHz: MCS0, MCS7) 802.11ac:OFDM (20MHz: MCS0, MCS8) 802.11ax:OFDM (20MHz: MCS0, MCS11) 40MHz: 802.11n: OFDM (40MHz: MCS0, MCS7) 802.11ac:OFDM (40MHz: MCS0, MCS8) 802.11ax:OFDM (40MHz: MCS0, MCS11)	GFSK
Number of antennas	2	
	1001932PT(Flex/PCB Antenna)	2.50dBi
	FPA3020-10A (Flex/PCB Antenna)	4.23dBi
Supply Voltage to Product	3.3VDC through AC/DC Adapter , < 2.0A	
Environmental conditions	Storage	-20degC to +70degC Relative Humidity <95%
	Operating	-20degC to +60degC Relative Humidity <95%
EUT Dimension	2.5 x 2.5 x 0.3 CM (L x W x H)	

Prüfbericht - Nr.:
Test Report No.:

IN2391GP 001

Seite 9 von 229
Page 9 of 229

***Disclaimer:** The information/data is supplied by the client and the same is considered to arrive at the final value. Any changes made apart from the specified specification, can directly impact on the tests results. Refer the products user manual for more details.

Note: Product **HWBPC11AX-PRTM** has multiple protocols. All the supported wireless protocols and their respective test results are issued in separate test reports, refer clause 4.7 Report references

3.3 Measurement Uncertainty:

Reported uncertainties represent expanded uncertainties expressed at approximately the 95% confidence level using a coverage factor of $k = 2$

Table 4: Measurement Uncertainty

Parameter	Uncertainty
Occupied Channel Bandwidth	±5 %
RF output power, conducted	±1.5 dB
Power Spectral Density, conducted	±3 dB
Unwanted Emissions, conducted	±3 dB
All emissions, radiated	±6 dB
Temperature	±3 °C
Supply Voltages	±3 %
Time	±5 %

Note: The Listed Measurement Uncertainties are the worst-case uncertainty, for the respective test cases. Above Table is for reporting purpose only and not used in determining Final Pass/Fail verdict.

4 TEST SET-UP AND OPERATION MODE

4.1 Principle of Configuration Selection

Transmission was enabled with highest possible duty cycle on low, mid and high channels

4.2 UUT Operation and Software

Hardware Version Identification number (HVIN) : 3008-8482-001
Software version : 18.35.387.23.1301.62

4.3 Special Accessories and Auxiliary Equipment

Test laptop (Tera Term VT ver 4.105),
LAN cable

4.4 Simultaneous Transmission

This product supports Simultaneous transmission

4.5 Countermeasures to achieve EMC Compliance

- None

4.6 List of frequencies

Frequency Band (MHz)	Channel No.	Channel Frequency (MHz)
2412 – 2462	1	2412
	2	2417
	3	2422
	4	2427
	5	2432
	6	2437
	7	2442
	8	2447
	9	2452
	10	2457
	11	2462

Table 5: List of Wi-Fi center Frequencies

Channel used for Wi-Fi 2.4GHz testing

Protocol: WLAN 802.11b

Channel Low : 2412 MHz
Channel Mid : 2437 MHz
Channel High : 2462 MHz

Protocol: WLAN 802.11g

Channel Low : 2412 MHz
Channel Mid : 2437 MHz
Channel High : 2462 MHz

Protocol: WLAN 802.11n_20MHz

Channel Low : 2412 MHz
Channel Mid : 2437 MHz
Channel High : 2462 MHz

Protocol: WLAN 802.11n_40MHz

Channel Low : 2422 MHz
Channel Mid : 2437 MHz
Channel High : 2452 MHz

Protocol: WLAN 802.11ac_20MHz

Channel Low : 2412 MHz
Channel Mid : 2437 MHz
Channel High : 2462 MHz

Protocol: WLAN 802.11ac_40MHz

Channel Low : 2422 MHz
Channel Mid : 2437 MHz
Channel High : 2452 MHz

Prüfbericht - Nr.:
Test Report No.:

IN2391GP 001

Seite 11 von 229
Page 11 of 229

Protocol: WLAN 802.11ax_20MHz **Protocol: WLAN 802.11ax_40MHz**

Channel Low : 2412 MHz

Channel Low : 2422 MHz

Channel Mid : 2437 MHz

Channel Mid : 2437 MHz

Channel High : 2462 MHz

Channel High : 2452 MHz

Frequency Band (GHz)	Channel No.	Frequency (MHz)
BLE (2.4-2.4835)	0	2402
	1	2404
	2	2406
	3	2408
	:	:
	:	:
	18	2438
	19	2440
	20	2437
	:	:
	:	:
	36	2474
	37	2476
	38	2478
39	2480	

Table 6: List of BLE Center frequencies

Channel used for BLE testing

Channel low : 2402MHz

Channel mid : 2440MHz

Channel High : 2480MHz

Note:

TUV Sample Identification number : A003385546-022– Radiated test Sample
A003385546-04– Conducted test Sample

4.7 Report references

Note: Product **HWBPC11AX-PRTM** has multiple protocols. All the supported wireless protocols and their respective test results are issued in separate test reports, following table lists the report numbers.

Radio Protocol	Report Number
RF test report for Wi-Fi (2.4GHz) & BLE (2.4GHz) – (This report)	IN2391GP 001
RF test report for Bluetooth (2.4GHz)	IN23ZC8W 001
RF test report for Wi-Fi (5GHz)	IN23VER9 001

5 Operational Description

This **HWBPC11AX-PRTM** module is a Wi-Fi, BT system on module which will be placed inside the Honeywell products like printers, barcode scanners, RFID readers etc. to enable wireless connectivity.

This module includes MAC & physical layer of 802.11a/b/g/n/ac/ax and the Bluetooth modem.

This module operates on 3.3VDC Power supply with internal on-board regulation for 3.3vdc for powering ON all the circuits.

The module uses internal power amplifier and LNA for 2.4GHz frequency band and an external front end chip for 5GHz frequency band.

All filters and diplexers are included in the module to ensure maximum power flatness and optimum VSWR.

The module has one antenna chain for 2X2 output for Wi-Fi.

The module shall use WM-BAX-BM-57 USI SiP module with Broadcom BCM43752 chipset which includes LNA, switch, and internal power amplifier (iPA) for small form factor and optimum performance. All filters and diplexers will be included in the module to ensure maximum power flatness and optimum VSWR. The module will perform with all legacy hardware having data rates as low as 1Mbps. When running 802.11 ac in 2 x 2 MIMO mode, data rates are expected to reach 1200 Mbps or more.

This chipset also supports concurrent operation of Bluetooth (Version 5.1) for wireless connectivity during browsing or other device applications. Along with both standard and high speed (HS) Bluetooth data rates, Bluetooth low energy modes are also supported.

Hardware WAPI acceleration engine, AES, TKIP, WPA and WPA2 are supported to provide the latest security requirement on your network

The Device communicates with HOST using SDIO interface for WIFI and UART interface for BLUETOOTH.

6 TEST METHODOLOGY

6.1 Conducted Spurious Emission Test on AC Power Line

Measured levels of ac power-line conducted emission across the 50 Ω LISN port (to which the EUT is connected). All emission voltage and current measurements shall be made on each current-carrying conductor at the plug end of the EUT power cord by the use of mating plugs and receptacles on the LISN, if used. Equipment shall be tested with power cords that are normally supplied or recommended by the manufacturer and that have electrical and shielding characteristics that are the same as those cords normally supplied or recommended by the manufacturer.

The device is placed on the test table, raised 80cm above the reference ground plane. The vertical conducting plane is located 40cm to the rear of the device. AC Conducted emission measurement is made over frequency range from 150kHz to 30MHz, this measurement was performed with EUT powered with an AC adaptor with 110V AC 60Hz supply.

6.1.1 Test Setup Configuration

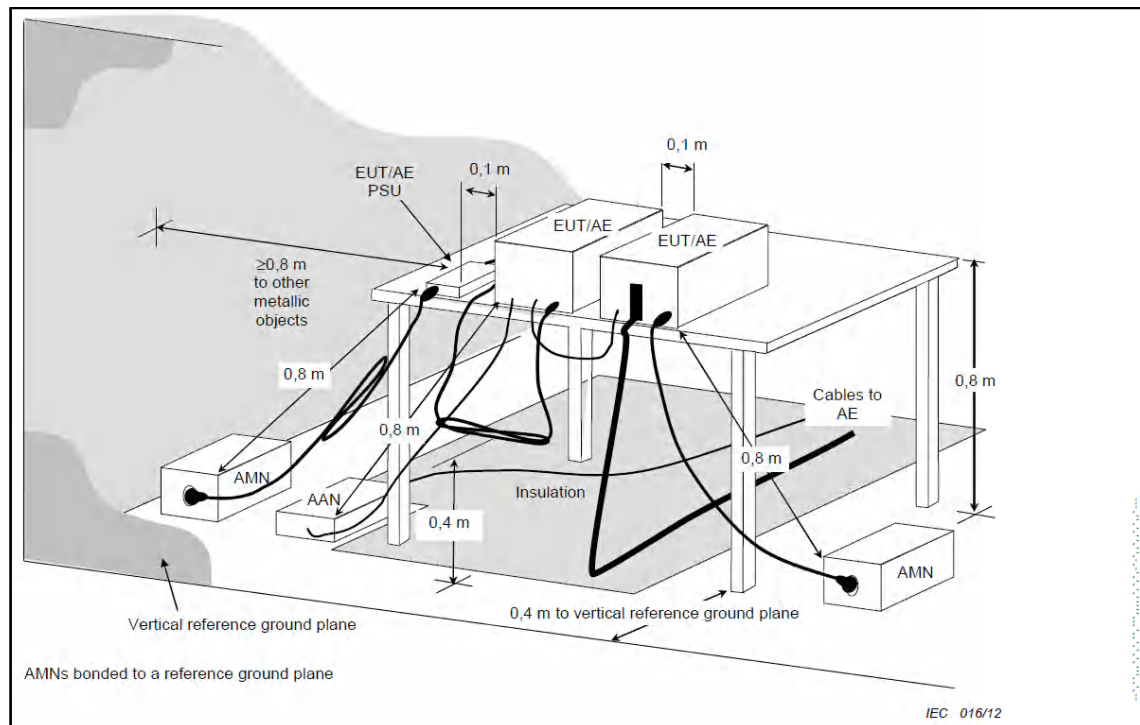

6.2 Radiated Emission Test

The radiated emission measurement was performed according to the procedures in ANSI C63.10-2013. The equipment under test (EUT) was placed at the middle of the 80 cm high turntable for below 1 GHz & 1.5 m height for above 1 GHz measurement, and the EUT is 3 meters far from the measuring antenna. The turntable was rotated 360° for obtaining the maximum emission. The height of the measuring antennas was scanned between 1 m and 4 m, and the antenna rotated to repeat the measurements for both the horizontal and vertical antenna polarizations. Repeat the measurement steps until the maximum emissions were obtained. The measurement above 1000 MHz was performed by horn antenna, The measurement below 30 MHz was performed by loop antenna, Measurement from 30 MHz to 200 MHz was performed by Baloon and Biconical Antenna, and measurement from 200 MHz to 1 GHz was performed by Log-Periodic Antenna.

The EUT was rotated around the X-, Y-, and Z-Axis and the results from worst case axis are recorded

6.2.1 Test Setup Configuration

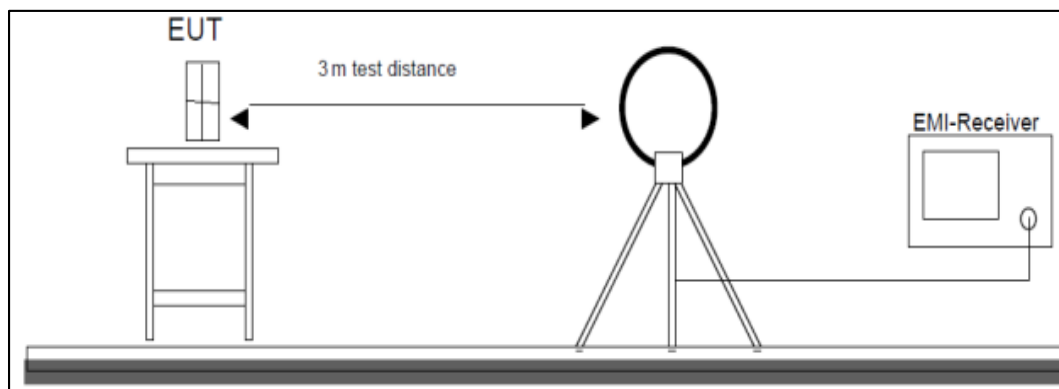

Figure 1: Frequency Range 9 kHz- 30 MHz

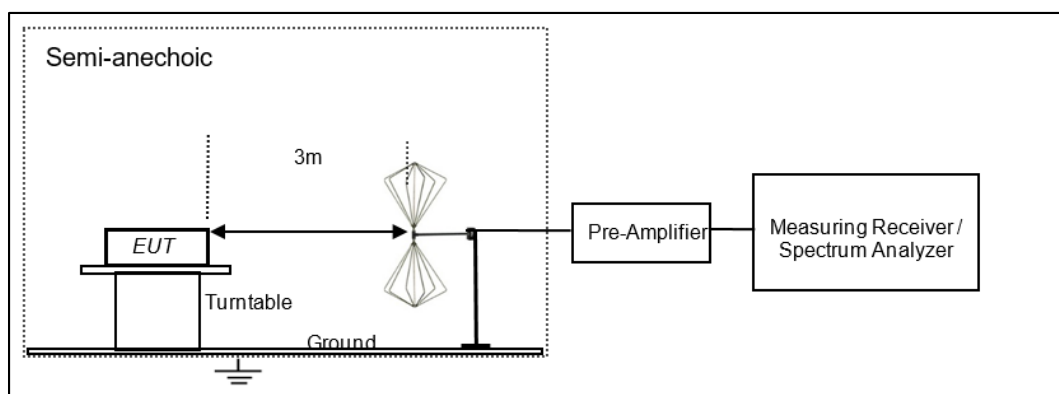

Figure 2: Frequency Range 30 MHz – 200 MHz

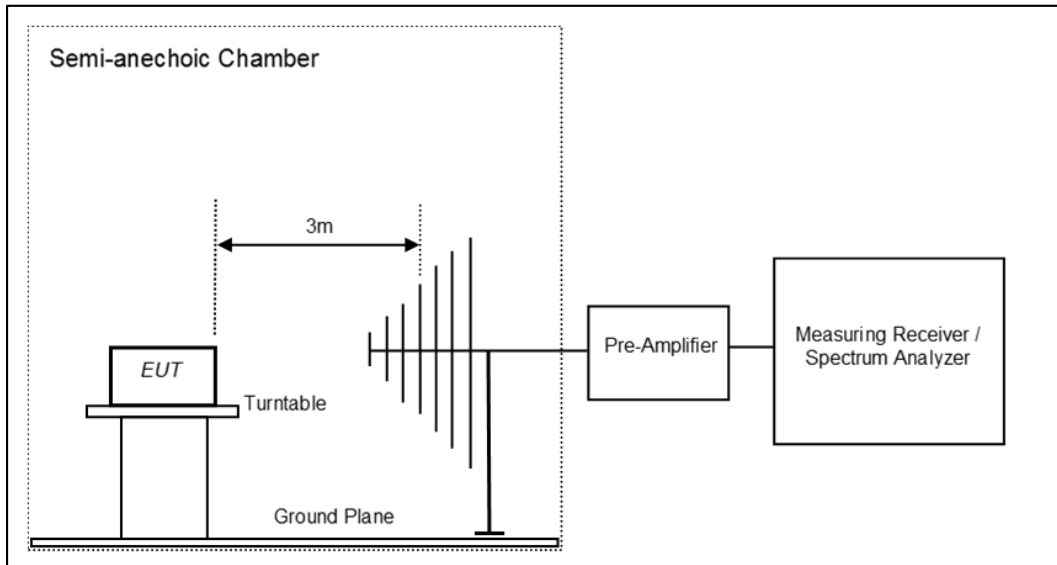

Figure 3: Frequency Range 200 MHz - 1GHz

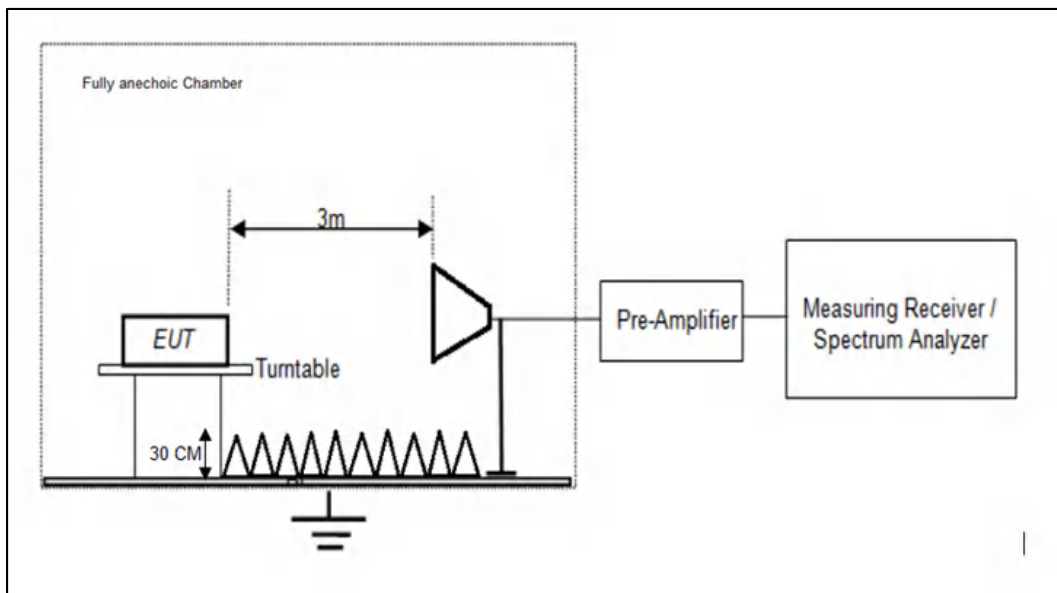

Figure 4: Frequency Range above 1 GHz

7 TEST RESULTS FOR WI-FI

7.1 Maximum Average Conducted Output Power

Result

Pass

Test Specification	FCC part 15 Subpart C 15.247 (b)(3) / RSS 247 Issue 2, Section 5.4 (d)
Test Method	Subclause 11.9.2.2.2 of ANSI C63.10
Detector	Average (Gated RMS)
Port of testing	Antenna port
Requirement	Power \leq 1 W (30 dBm) & e.i.r.p \leq 4 W (36 dBm)

Test Method

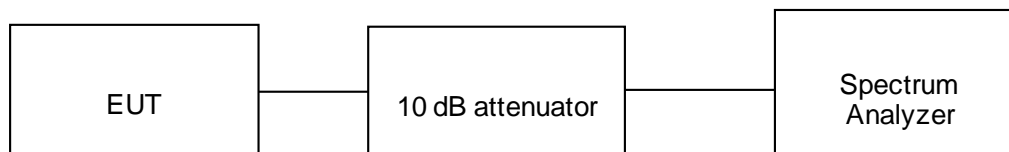

Test Condition

Normal Test Condition:

Temperature (Norm) = + 25 °C Voltage = 3.3 V DC through AC to Dc adaptor Relative humidity: 62%

KDB Guidelines applied:

Measurements were made as per section 8.3.2.2 in KDB 558074 D01 15.247 Measurement Guidance v05r02.

Prüfbericht - Nr.:
Test Report No.:

IN2391GP 001

Seite 17 von 229
Page 17 of 229

Test results:

Note:

1. All the losses are included during measurement and final values are mentioned in the test report.
2. Total Average Output power (dBm) = Measured Average power (dBm) + Attenuator factor (10dB) + Cable loss (0.5dB)
3. This product do not support additional beamforming gain / directional gain, it uses signal antenna and hence directional gain of the single antenna is 2.50 dBi
4. Maximum (e.i.r.p) = Maximum Average output power (dBm) + antenna gain (2.50 dBi)

Antenna Type: 1001932PT (PCB/Flex) MIMO Antenna Results

Modulation: 802.11b

Data rate (Mbps)	Channel Frequency (MHz)	Maximum Average output power (dBm)	Maximum (e.i.r.p) (dBm)	Power Limit (dBm)	e.i.r.p Limit (dBm)
1Mbps	2412	21.25	23.75	30	36
	2437	23.18	25.68	30	36
	2462	23.44	25.94	30	36
11Mbps	2412	21.84	24.34	30	36
	2437	23.38	25.88	30	36
	2462	23.15	25.65	30	36

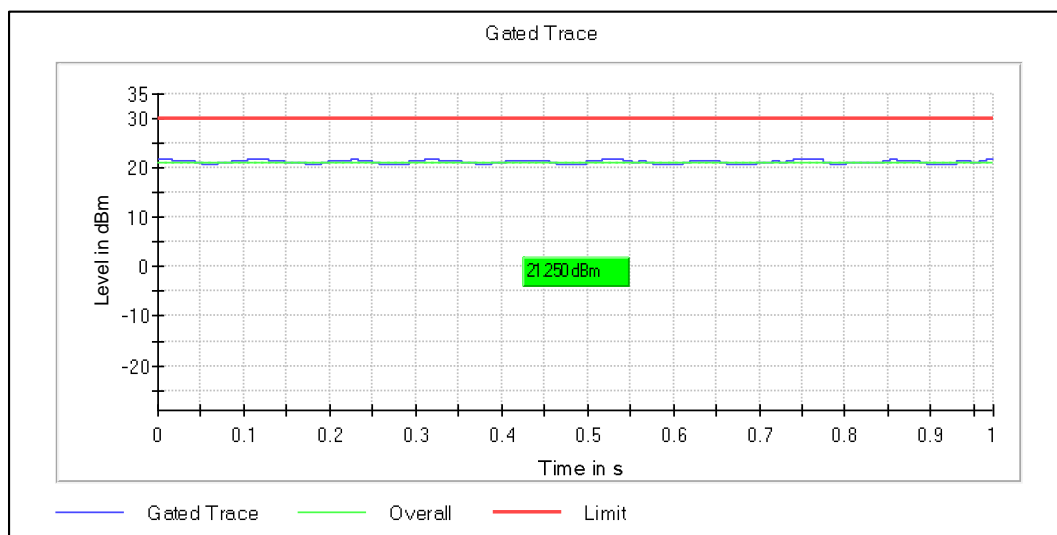

Data Rate: 1 Mbps

Channel Frequency: 2412MHz

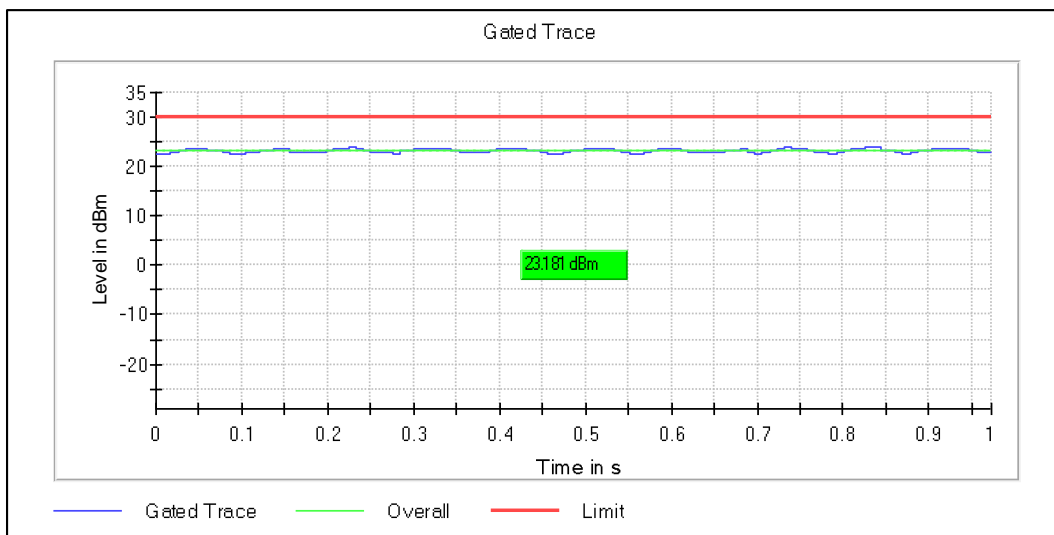

Data Rate: 1 Mbps

Channel Frequency: 2437MHz

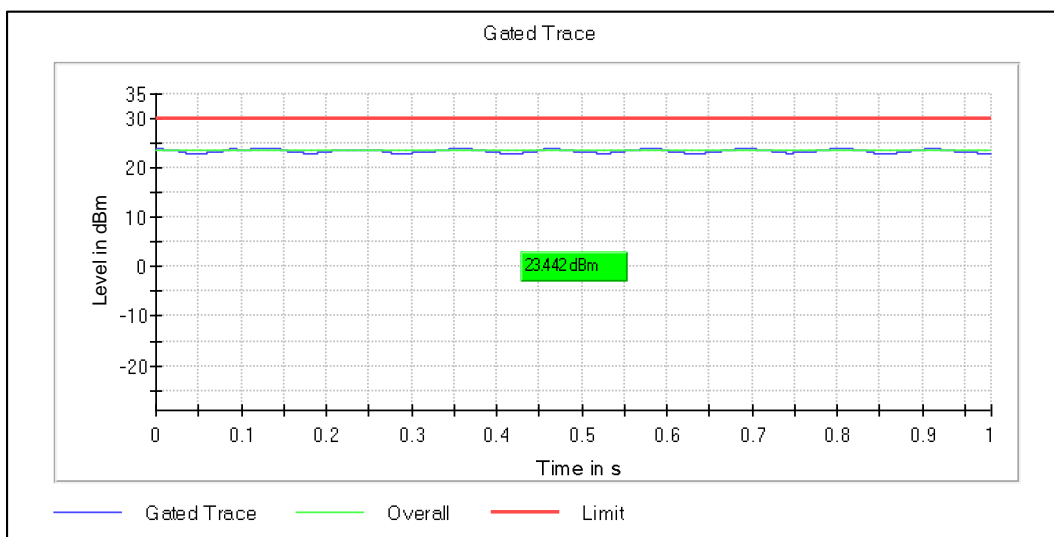

Data Rate: 1 Mbps

Channel Frequency: 2462MHz

Modulation: 802.11g

Data rate (Mbps)	Channel Frequency (MHz)	Maximum Average output power (dBm)	Maximum (e.i.r.p) (dBm)	Power Limit (dBm)	e.i.r.p Limit (dBm)
6Mbps	2412	21.17	23.67	30	36
	2437	23.25	25.75	30	36
	2462	20.31	22.81	30	36
54Mbps	2412	19.86	22.36	30	36
	2437	20.73	23.23	30	36
	2462	20.86	23.36	30	36

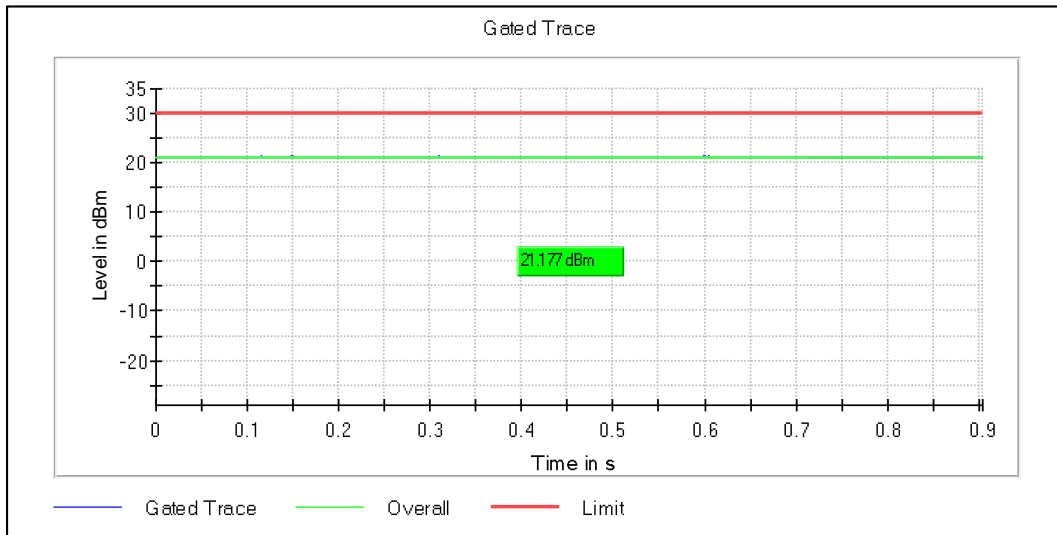

Data Rate: 6 Mbps

Channel Frequency: 2412MHz

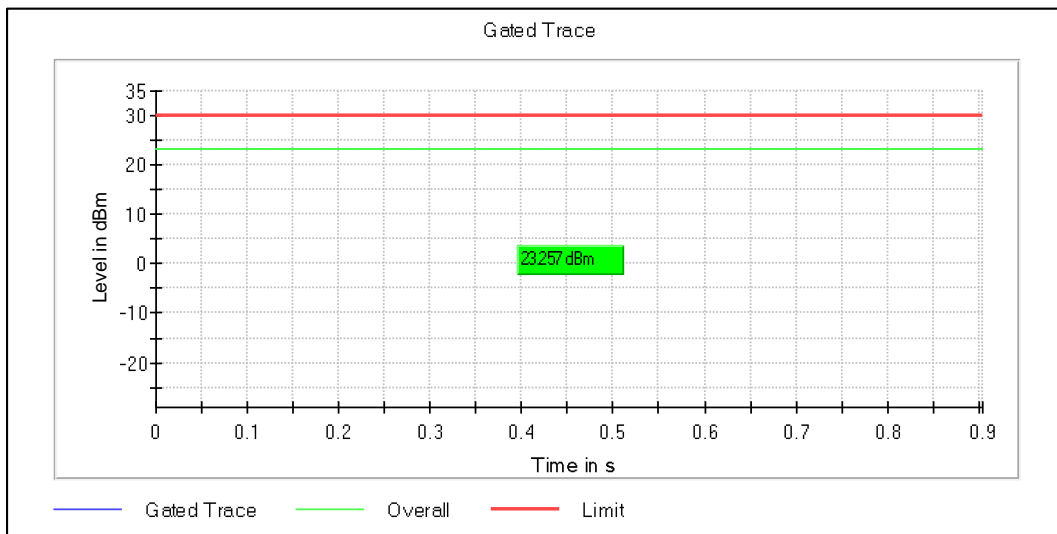

Data Rate: 6 Mbps

Channel Frequency: 2437MHz

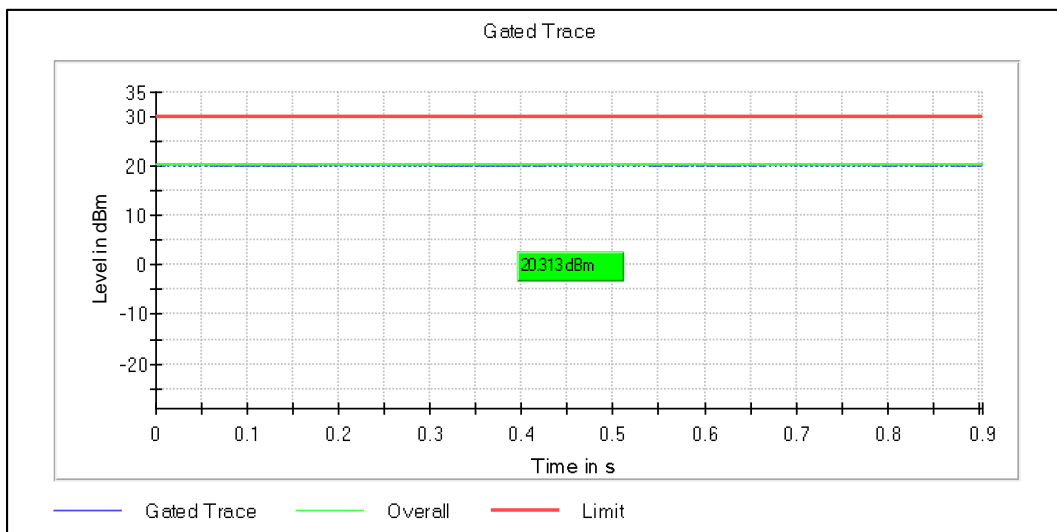

Data Rate: 6 Mbps

Channel Frequency: 2462MHz

Modulation: 802.11n_HT20

Data rate (Mbps)	Channel Frequency (MHz)	Maximum Average output power (dBm)	Maximum (e.i.r.p) (dBm)	Power Limit (dBm)	e.i.r.p Limit (dBm)
MCS0	2412	18.97	21.47	30	36
	2437	23.13	25.63	30	36
	2462	18.34	20.84	30	36
MCS7	2412	18.89	21.39	30	36
	2437	19.86	22.36	30	36
	2462	18.73	21.23	30	36

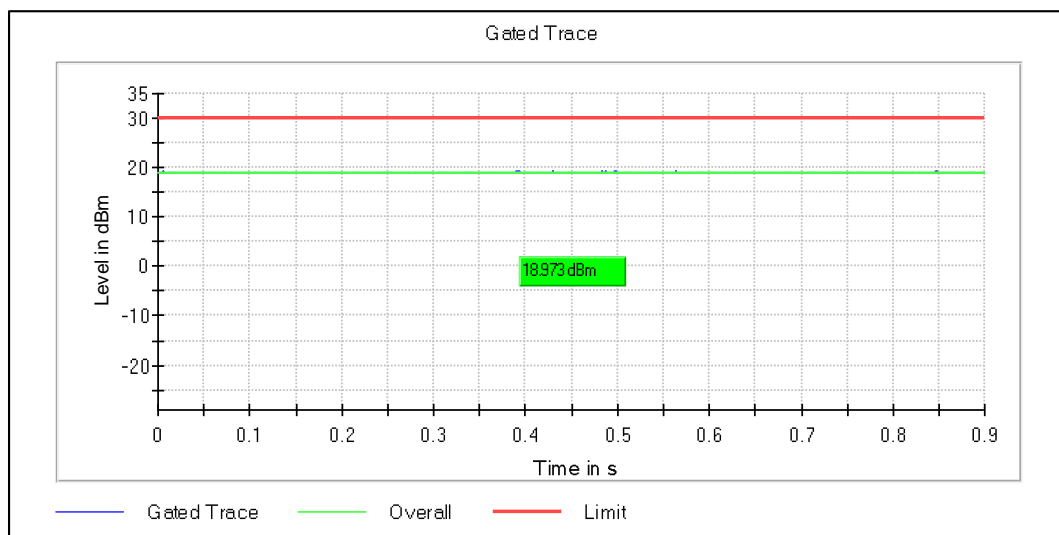

Data Rate: MCS0

Channel Frequency: 2412MHz

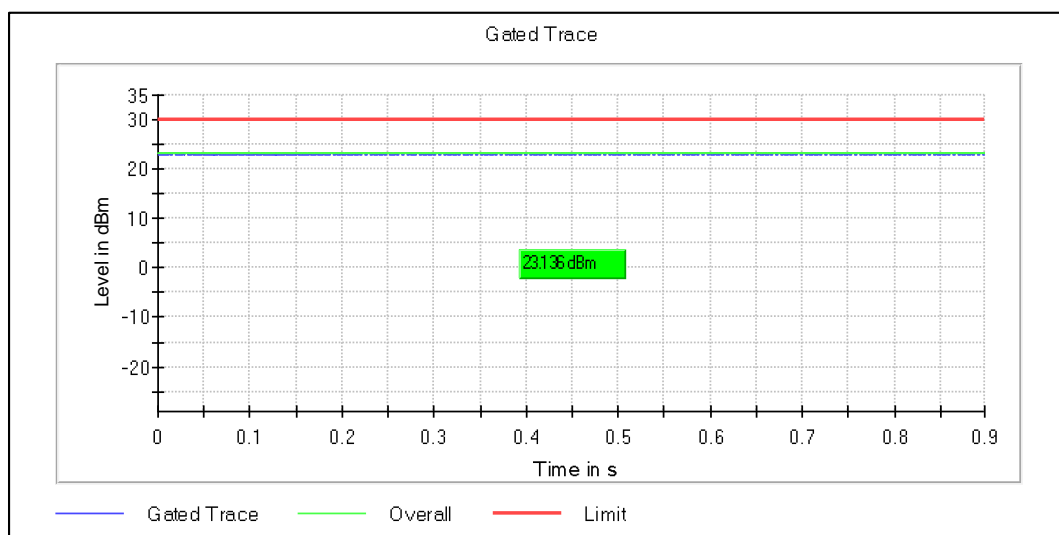

Data Rate: MCS0

Channel Frequency: 2437MHz

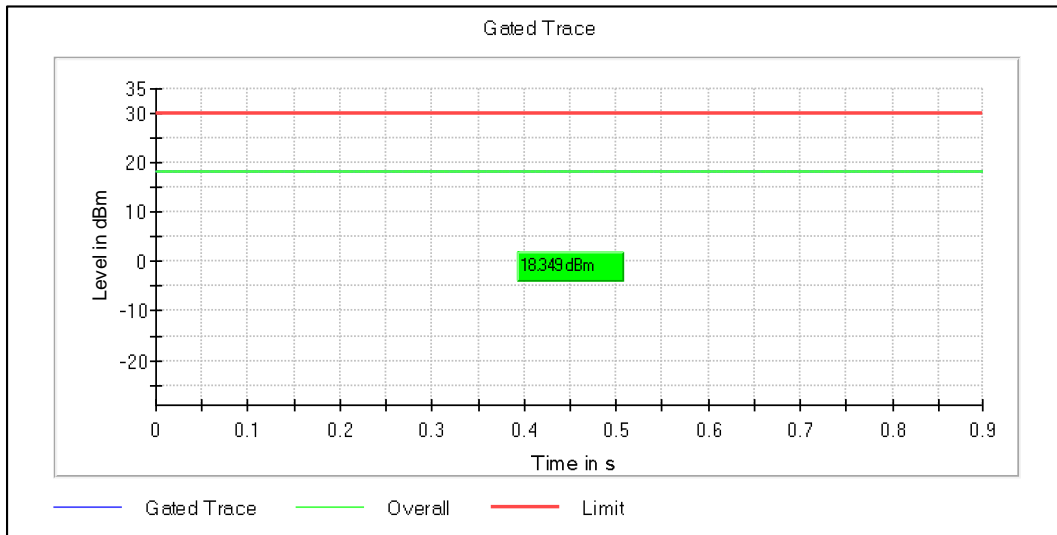

Data Rate: MCS0

Channel Frequency: 2462MHz

Modulation: 802.11ac_VHT20

Data rate (Mbps)	Channel Frequency (MHz)	Maximum Average output power (dBm)	Maximum (e.i.r.p) (dBm)	Power Limit (dBm)	e.i.r.p Limit (dBm)
MCS0	2412	19.77	22.27	30	36
	2437	23.09	25.59	30	36
	2462	18.36	20.86	30	36
MCS8	2412	18.04	20.54	30	36
	2437	18.82	21.32	30	36
	2462	18.69	21.19	30	36

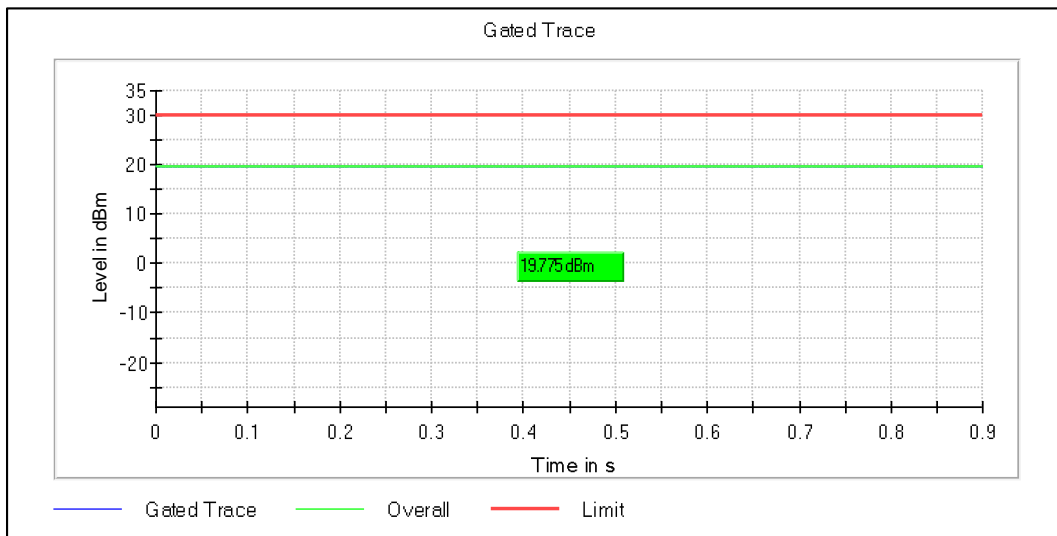

Data Rate: MCS0

Channel Frequency: 2412MHz

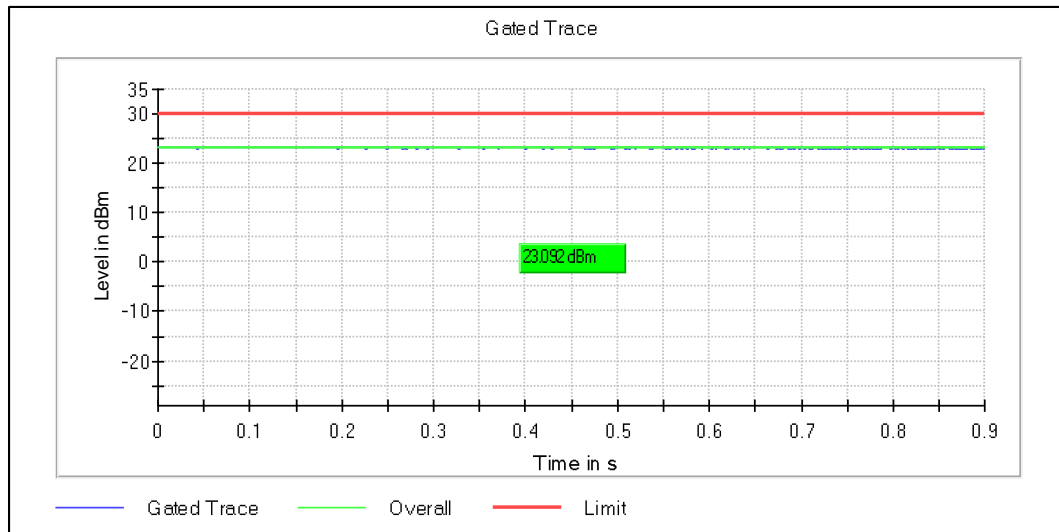

Data Rate: MCS0

Channel Frequency: 2437MHz

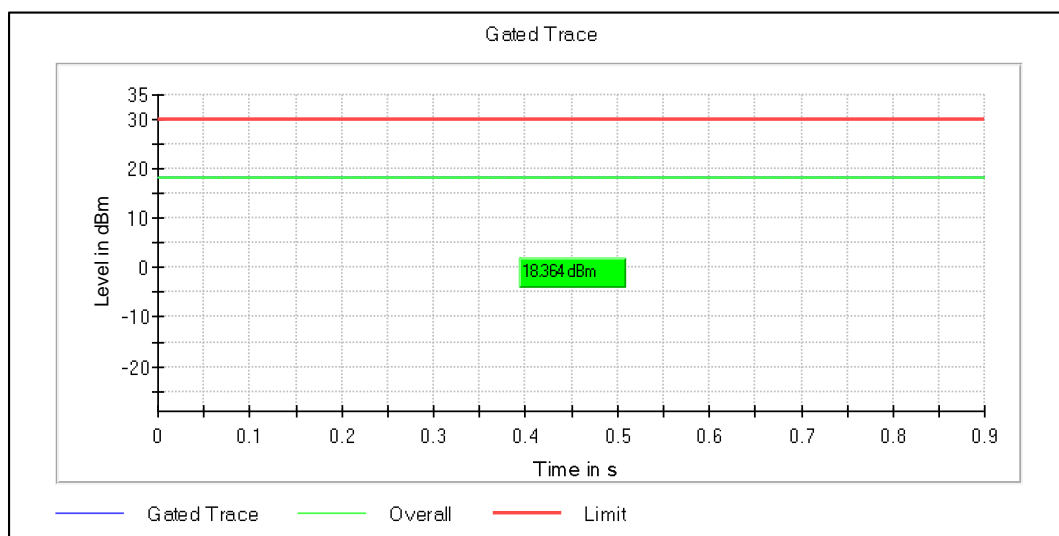

Data Rate: MCS0

Channel Frequency: 2462MHz

Modulation: 802.11ax_HE20

Data rate (Mbps)	Channel Frequency (MHz)	Maximum Average output power (dBm)	Maximum (e.i.r.p) (dBm)	Power Limit (dBm)	e.i.r.p Limit (dBm)
MCS0	2412	17.34	19.84	30	36
	2437	23.26	25.76	30	36
	2462	18.52	21.02	30	36
MCS11	2412	17.44	19.94	30	36
	2437	18.21	20.71	30	36
	2462	18.03	20.53	30	36

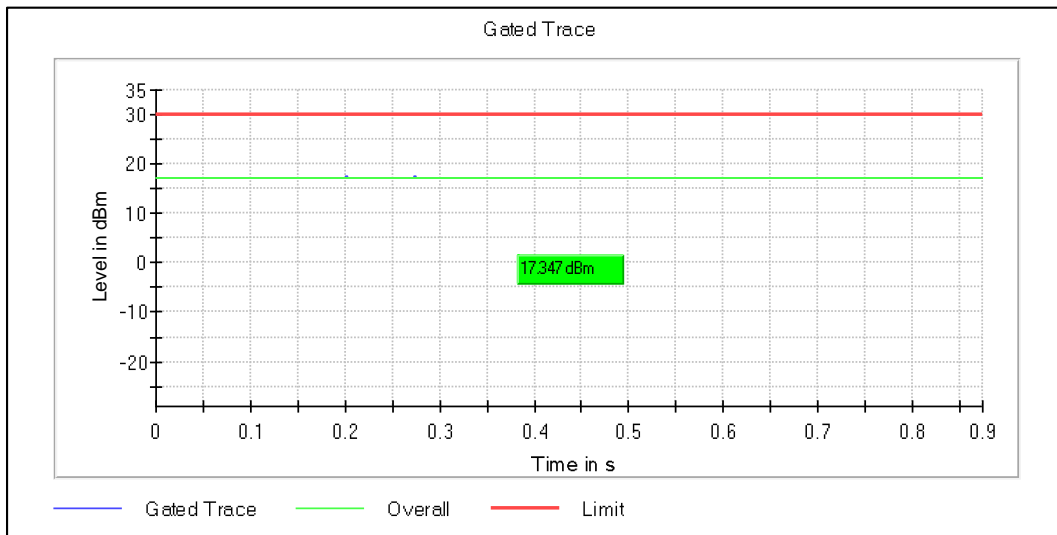

Data Rate: MCS0

Channel Frequency: 2412MHz

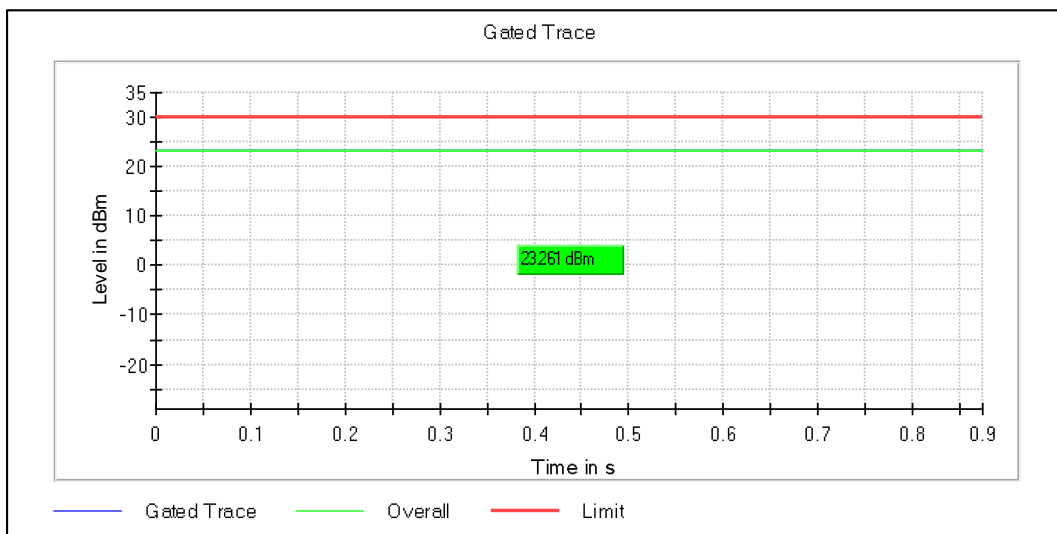

Data Rate: MCS0

Channel Frequency: 2437MHz

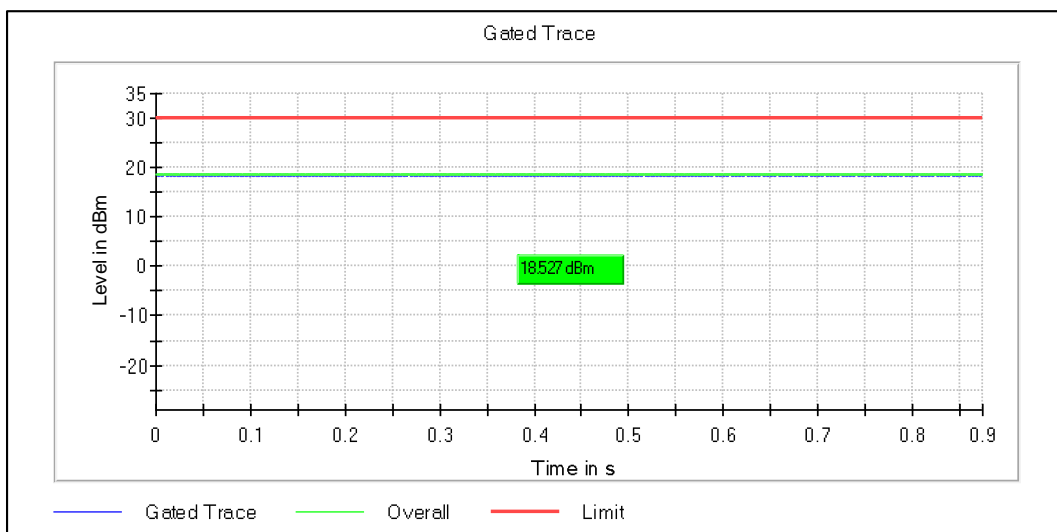

Data Rate: MCS0

Channel Frequency: 2462MHz

Modulation: 802.11n_HT40

Data rate (Mbps)	Channel Frequency (MHz)	Maximum Average output power (dBm)	Maximum (e.i.r.p) (dBm)	Power Limit (dBm)	e.i.r.p Limit (dBm)
MCS0	2422	17.01	19.51	30	36
	2437	23.96	26.46	30	36
	2452	17.05	19.55	30	36
MCS7	2422	20.15	22.65	30	36
	2437	19.90	22.40	30	36
	2452	16.54	19.04	30	36

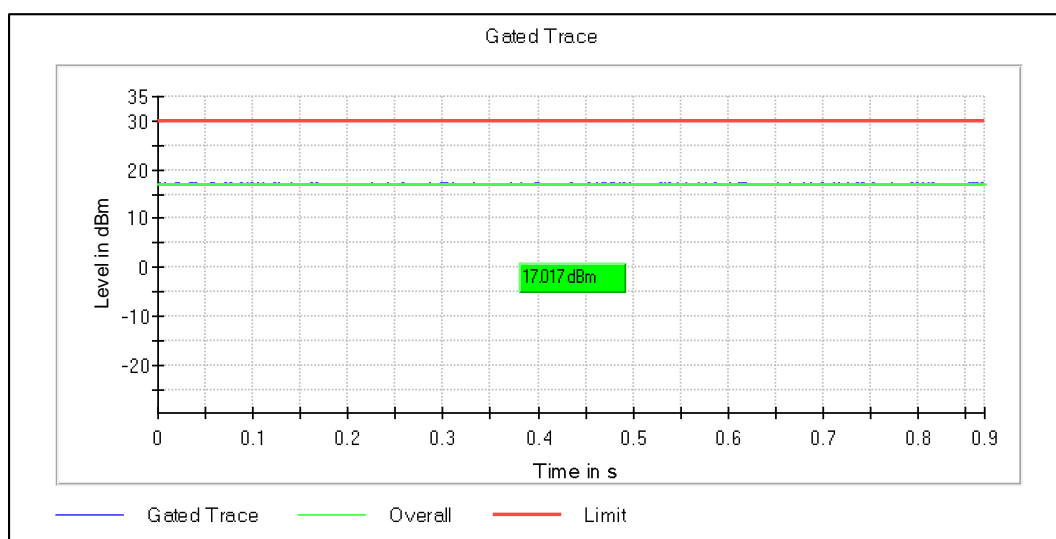

Data Rate: MCS0

Channel Frequency: 2422MHz

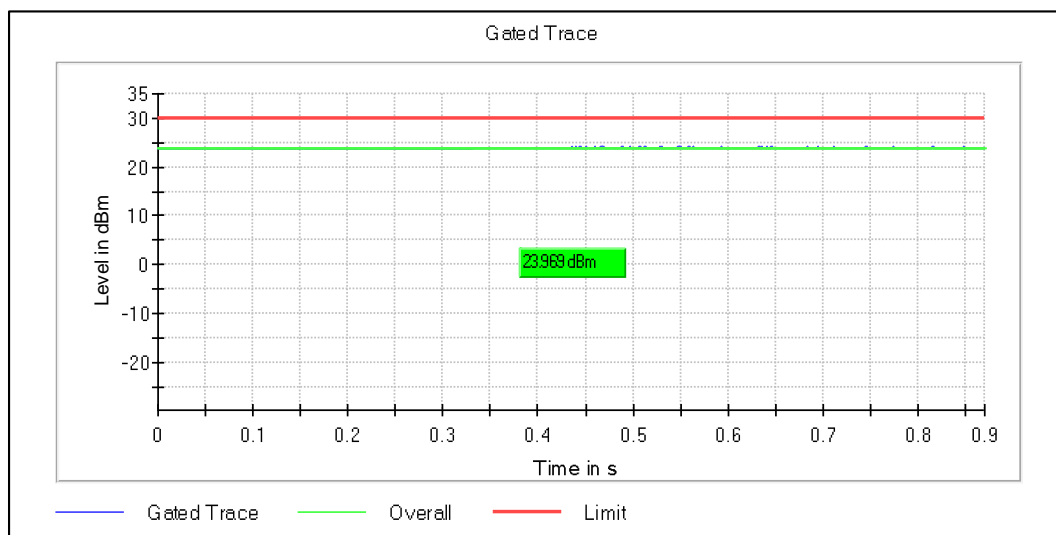

Data Rate: MCS0

Channel Frequency: 2437MHz

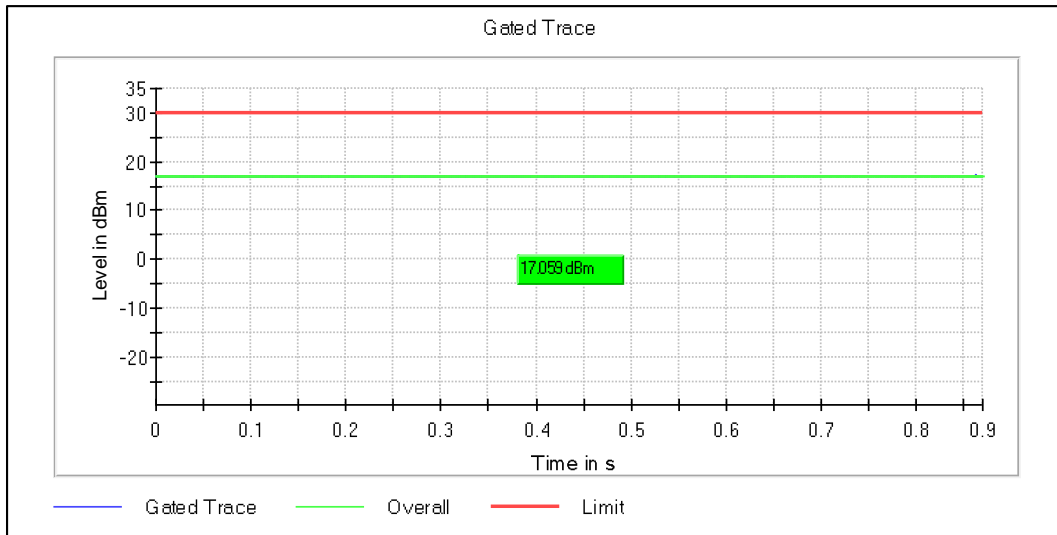

Data Rate: MCS0

Channel Frequency: 2452MHz

Modulation: 802.11ac_VHT40

Data rate (Mbps)	Channel Frequency (MHz)	Maximum Average output power (dBm)	Maximum (e.i.r.p) (dBm)	Power Limit (dBm)	e.i.r.p Limit (dBm)
MCS0	2422	19.26	21.76	30	36
	2437	24.15	26.65	30	36
	2452	17.21	19.71	30	36
MCS8	2422	18.84	21.34	30	36
	2437	18.70	21.20	30	36
	2452	18.52	21.02	30	36

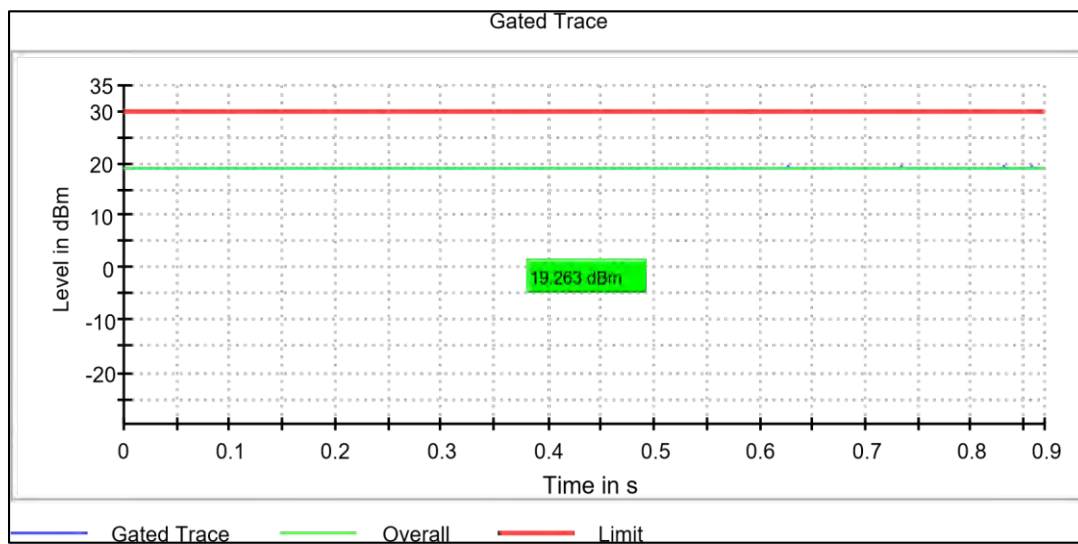

Data Rate: MCS0

Channel Frequency: 2422MHz

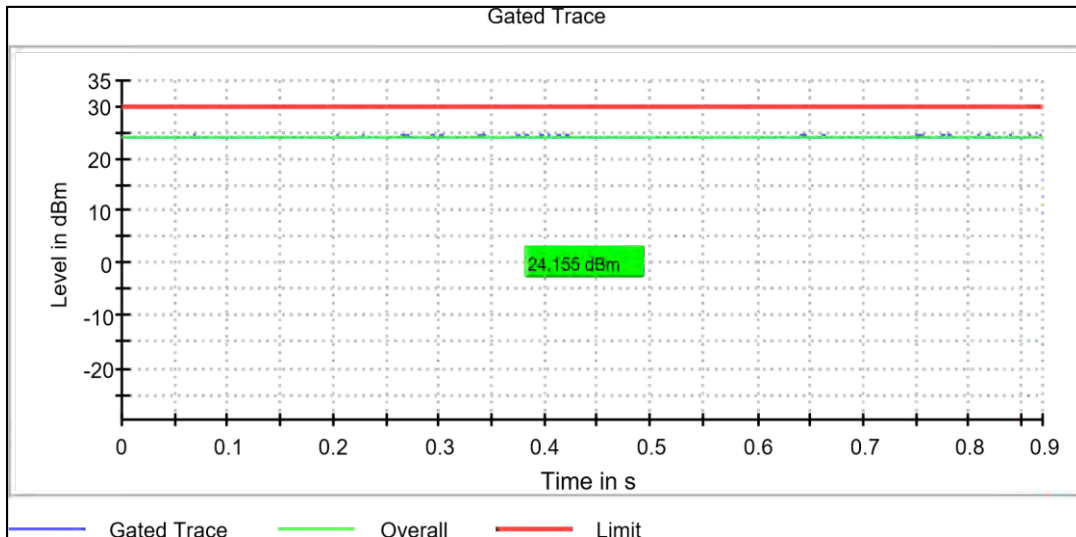

Data Rate: MCS0

Channel Frequency: 2437MHz

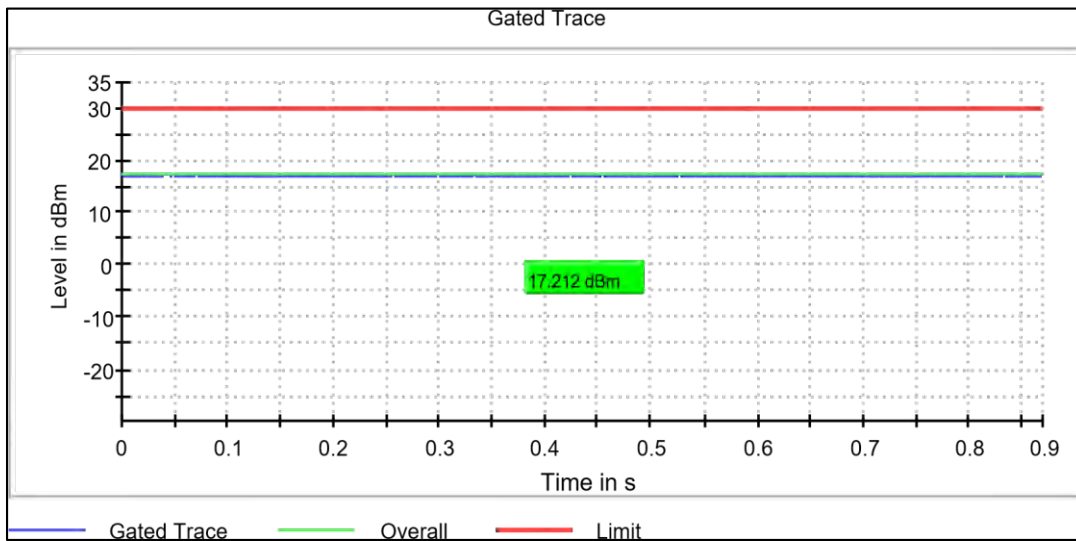

Data Rate: MCS0

Channel Frequency: 2452MHz

Modulation: 802.11ax_HE40

Data rate (Mbps)	Channel Frequency (MHz)	Maximum Average output power (dBm)	Maximum (e.i.r.p) (dBm)	Power Limit (dBm)	e.i.r.p Limit (dBm)
MCS0	2422	18.34	20.84	30	36
	2437	24.20	26.70	30	36
	2452	16.54	19.04	30	36
MCS11	2422	17.12	19.62	30	36
	2437	17.92	20.42	30	36
	2452	17.70	20.20	30	36

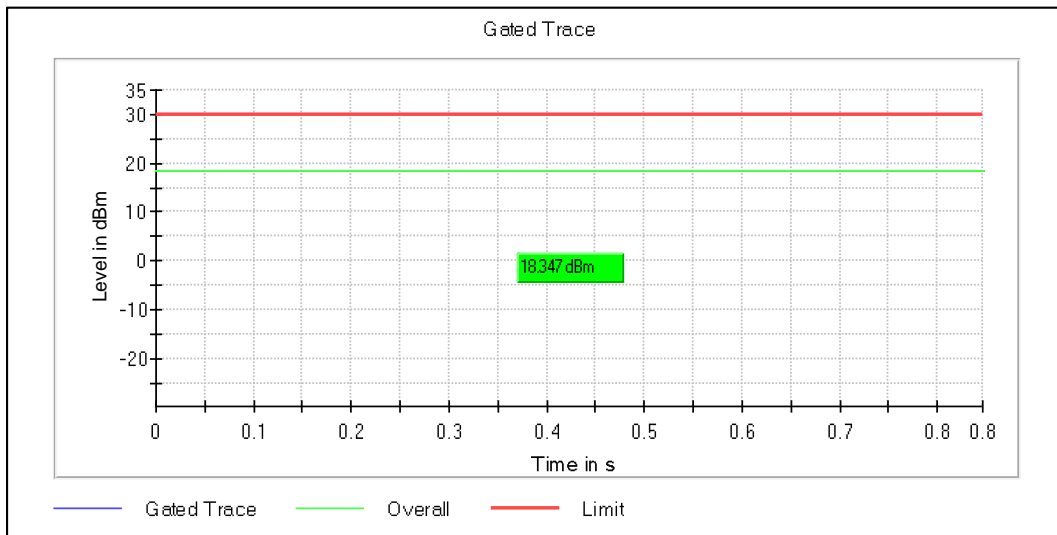

Data Rate: MCS0

Channel Frequency: 2422MHz

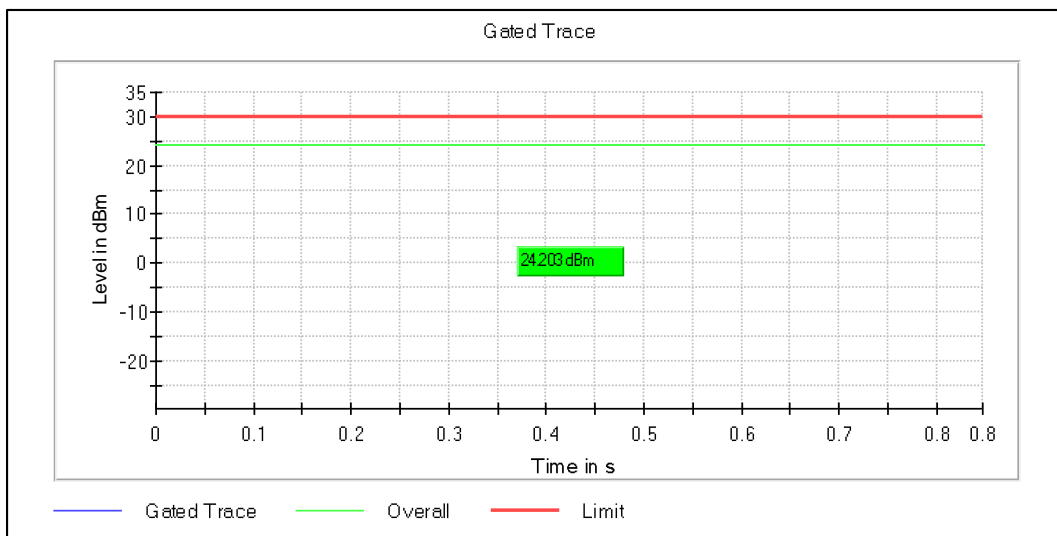

Data Rate: MCS0

Channel Frequency: 2437MHz

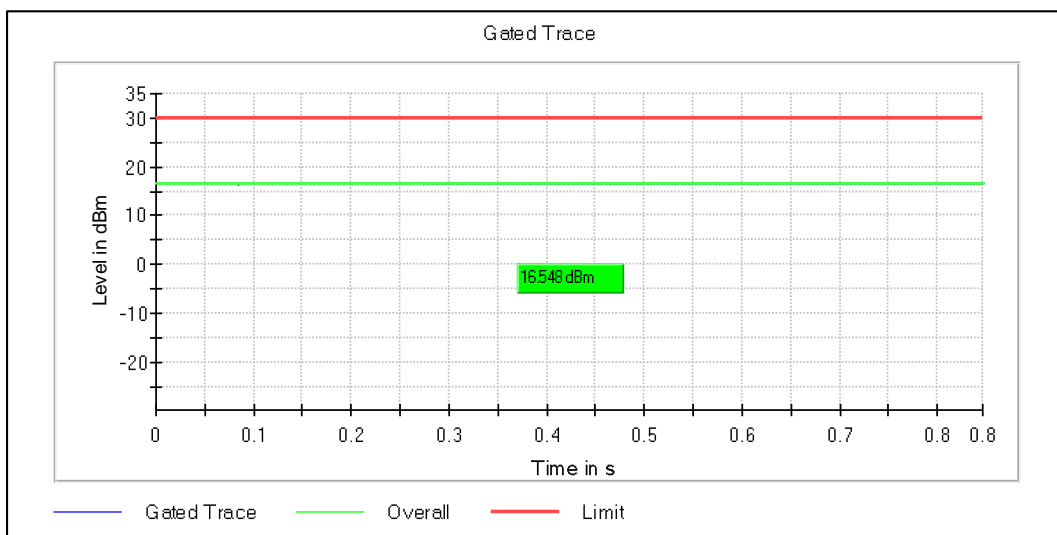

Data Rate: MCS0

Channel Frequency: 2452MHz

Prüfbericht - Nr.:
Test Report No.:

IN2391GP 001

Seite 28 von 229
Page 28 of 229

Test results:

Note:

1. All the losses are included during measurement and final values are mentioned in the test report.
2. Total Average Output power (dBm) = Measured Average power (dBm) + Attenuator factor (10dB) + Cable loss (0.5dB)
3. This product do not support additional beamforming gain / directional gain, it uses signal antenna and hence directional gain of the single antenna is 4.23 dBi
4. Maximum (e.i.r.p) = Maximum Average output power (dBm) + antenna gain (dBi)

Antenna Type: FPA3020-10A (PCB/Flex) MIMO Antenna Results

Modulation: 802.11b

Data rate (Mbps)	Channel Frequency (MHz)	Maximum Average output power (dBm)	Maximum (e.i.r.p) (dBm)	Power Limit (dBm)	e.i.r.p Limit (dBm)
1Mbps	2412	21.25	25.48	30	36
	2437	23.18	27.41	30	36
	2462	23.44	27.67	30	36
11Mbps	2412	21.84	26.07	30	36
	2437	23.38	27.61	30	36
	2462	23.15	27.38	30	36

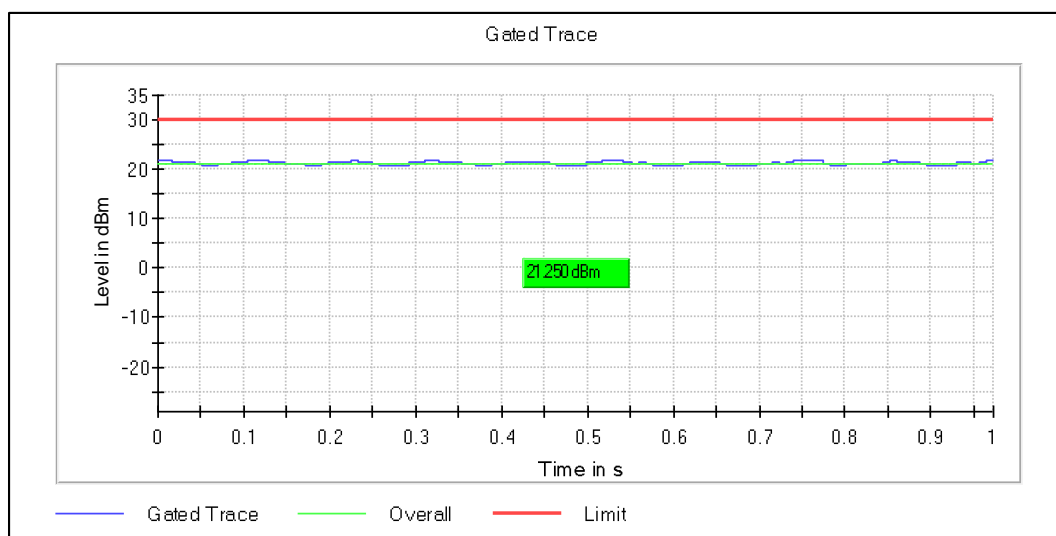

Data Rate: 1 Mbps

Channel Frequency: 2412MHz

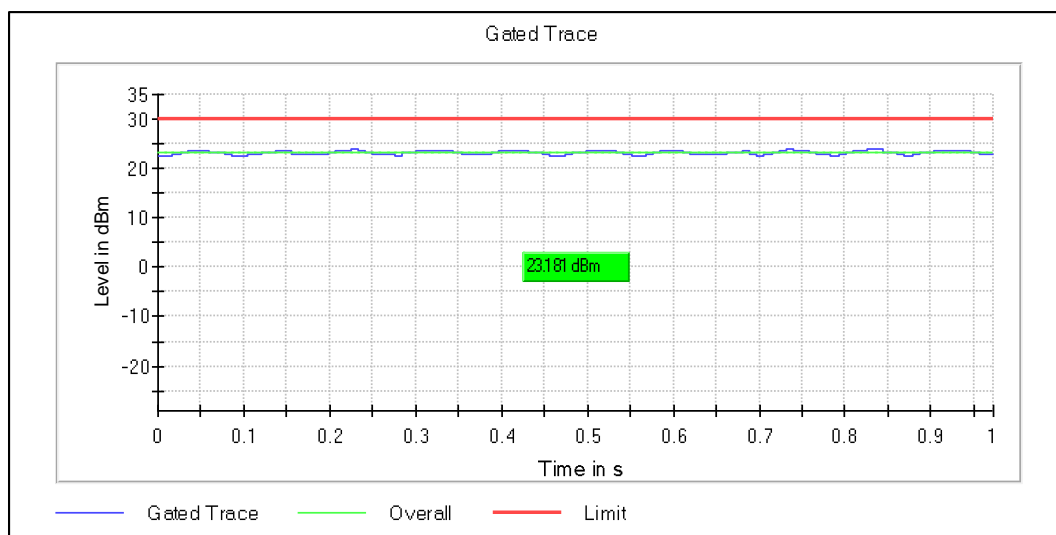

Data Rate: 1 Mbps

Channel Frequency: 2437MHz

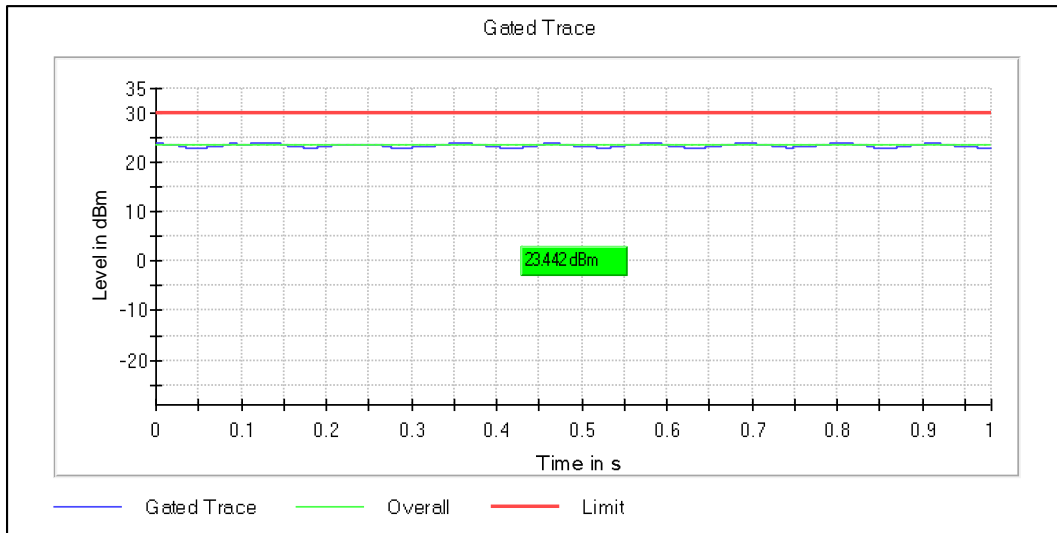

Data Rate: 1 Mbps

Channel Frequency: 2462MHz

Modulation: 802.11g

Data rate (Mbps)	Channel Frequency (MHz)	Maximum Average output power (dBm)	Maximum (e.i.r.p) (dBm)	Power Limit (dBm)	e.i.r.p Limit (dBm)
6Mbps	2412	20.75	24.98	30	36
	2437	23.30	27.53	30	36
	2462	22.39	26.62	30	36
54Mbps	2412	19.86	24.09	30	36
	2437	20.73	24.96	30	36
	2462	20.86	25.09	30	36

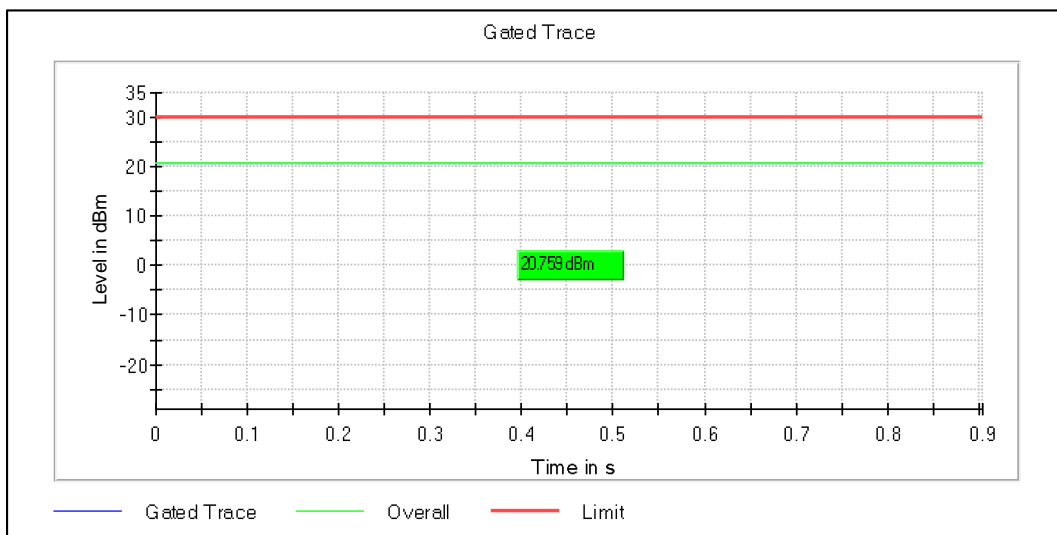

Data Rate: 6 Mbps

Channel Frequency: 2412MHz

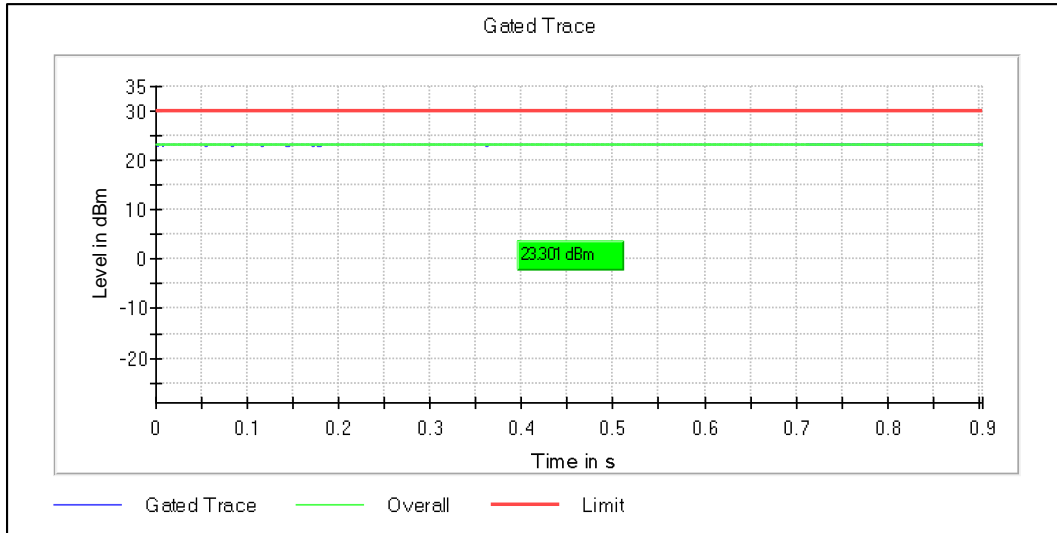

Data Rate: 6 Mbps

Channel Frequency: 2437MHz

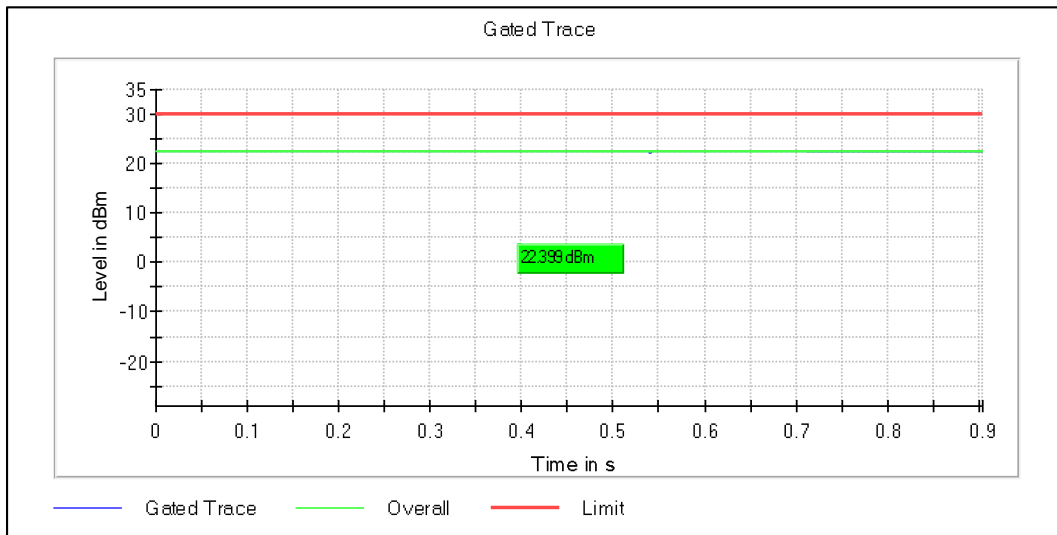

Data Rate: 6 Mbps

Channel Frequency: 2462MHz

Modulation: 802.11n_HT20

Data rate (Mbps)	Channel Frequency (MHz)	Maximum Average output power (dBm)	Maximum (e.i.r.p) (dBm)	Power Limit (dBm)	e.i.r.p Limit (dBm)
MCS0	2412	22.26	26.49	30	36
	2437	23.20	27.43	30	36
	2462	21.08	25.31	30	36
MCS7	2412	18.80	23.03	30	36
	2437	19.77	24.00	30	36
	2462	19.67	23.90	30	36

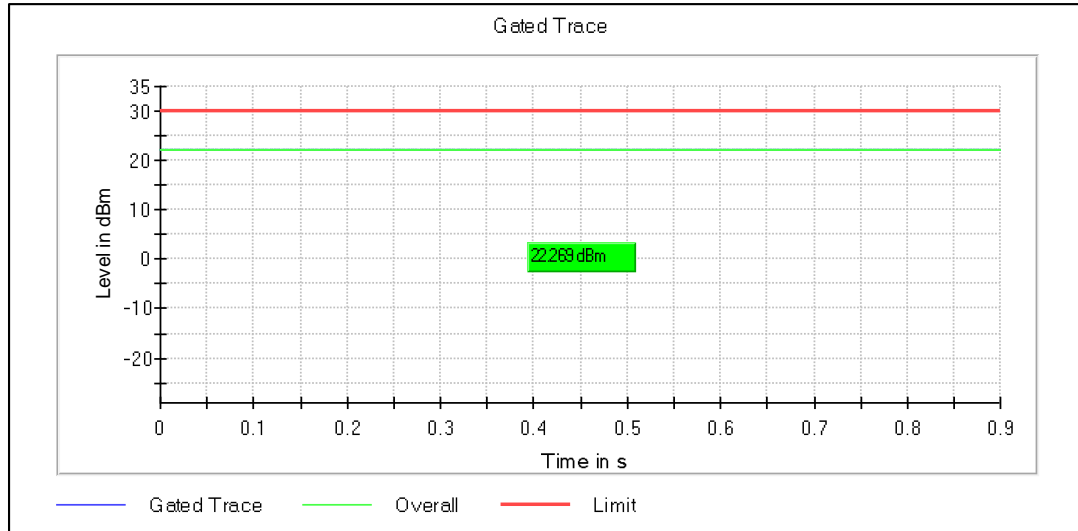

Data Rate: MCS0

Channel Frequency: 2412MHz

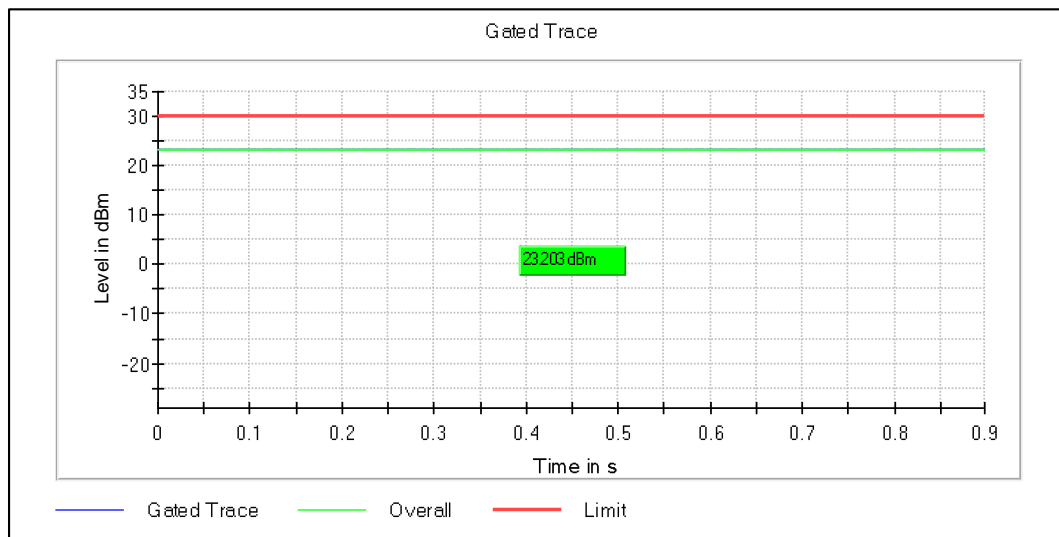

Data Rate: MCS0

Channel Frequency: 2437MHz

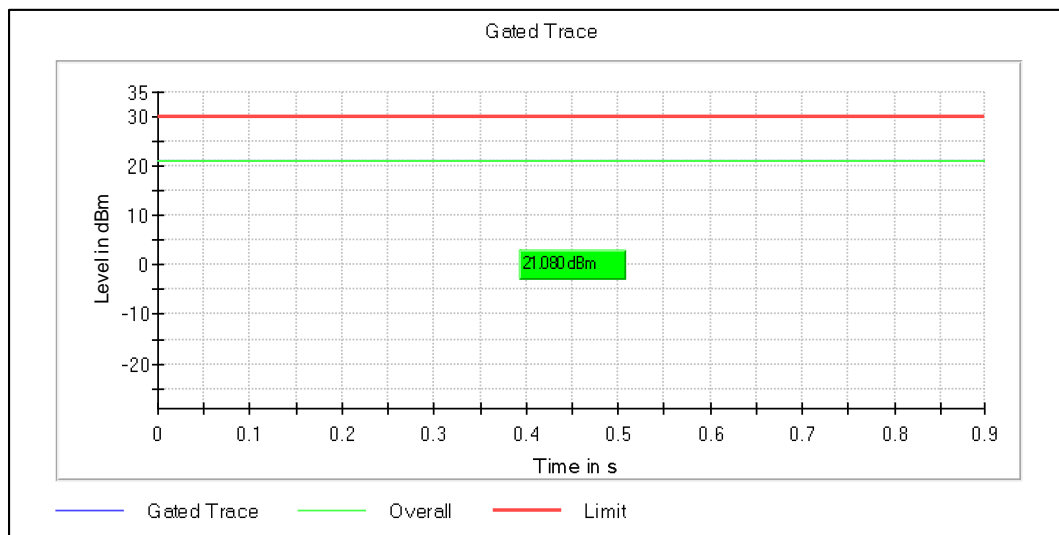

Data Rate: MCS0

Channel Frequency: 2462MHz

Modulation: 802.11ac_VHT20

Data rate (Mbps)	Channel Frequency (MHz)	Maximum Average output power (dBm)	Maximum (e.i.r.p) (dBm)	Power Limit (dBm)	e.i.r.p Limit (dBm)
MCS0	2412	21.92	26.15	30	36
	2437	23.24	27.47	30	36
	2462	21.16	25.39	30	36
MCS8	2412	18.04	22.27	30	36
	2437	18.82	23.05	30	36
	2462	18.69	22.92	30	36

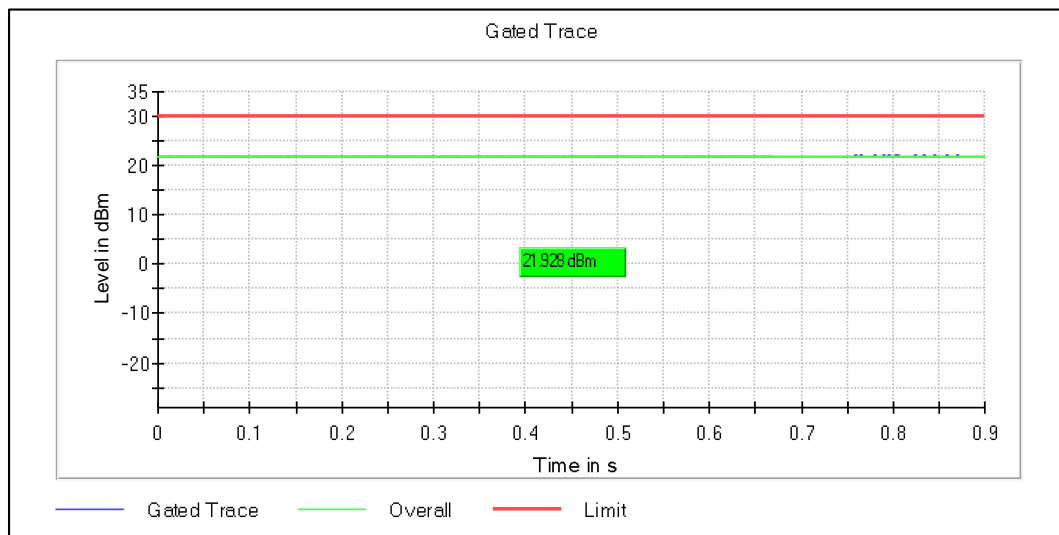

Data Rate: MCS0

Channel Frequency: 2412MHz

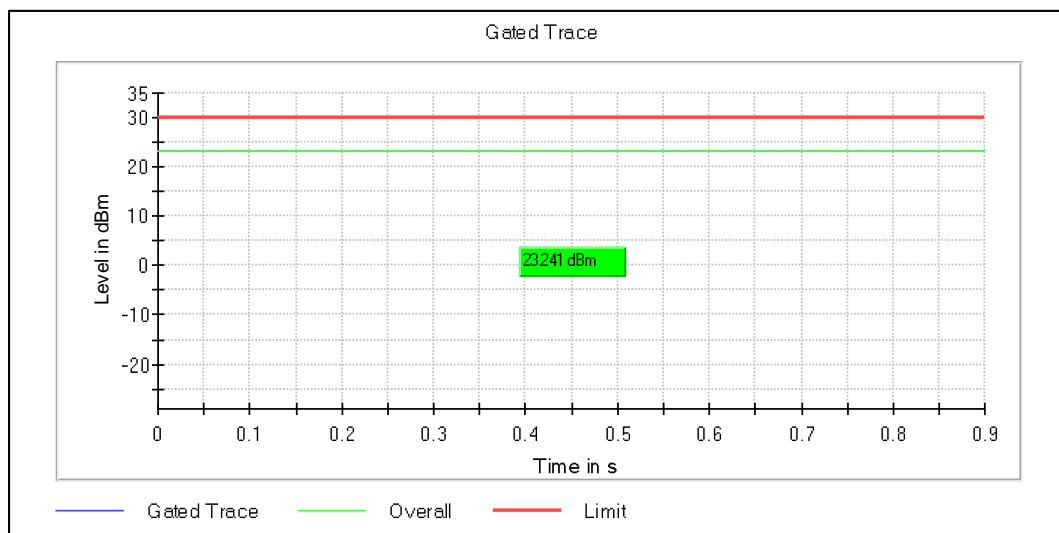

Data Rate: MCS0

Channel Frequency: 2437MHz

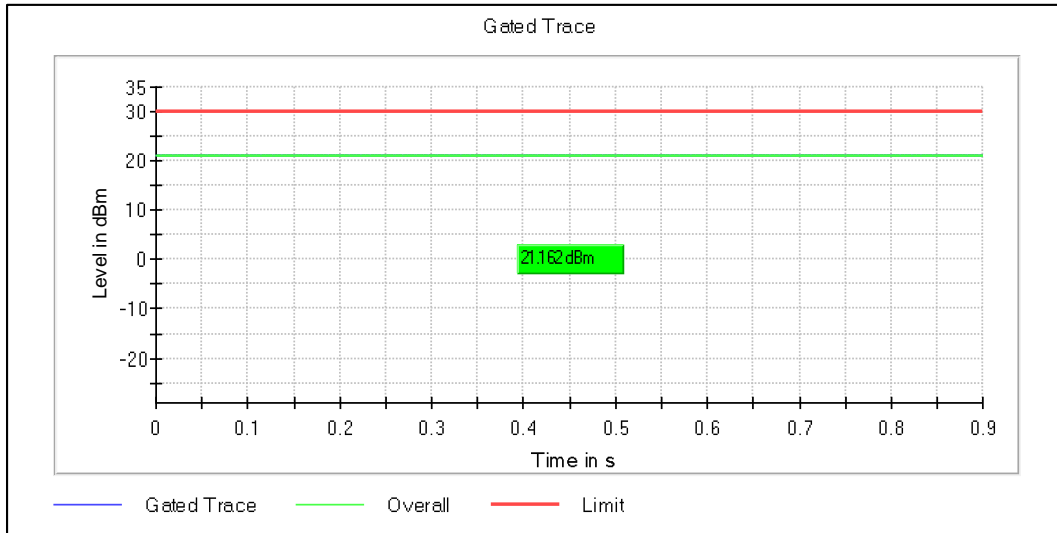

Data Rate: MCS0

Channel Frequency: 2462MHz

Modulation: 802.11ax_HE20

Data rate (Mbps)	Channel Frequency (MHz)	Maximum Average output power (dBm)	Maximum (e.i.r.p) (dBm)	Power Limit (dBm)	e.i.r.p Limit (dBm)
MCS0	2412	21.34	25.57	30	36
	2437	23.39	27.62	30	36
	2462	20.37	24.60	30	36
MCS11	2412	17.44	21.67	30	36
	2437	18.21	22.44	30	36
	2462	18.03	22.26	30	36

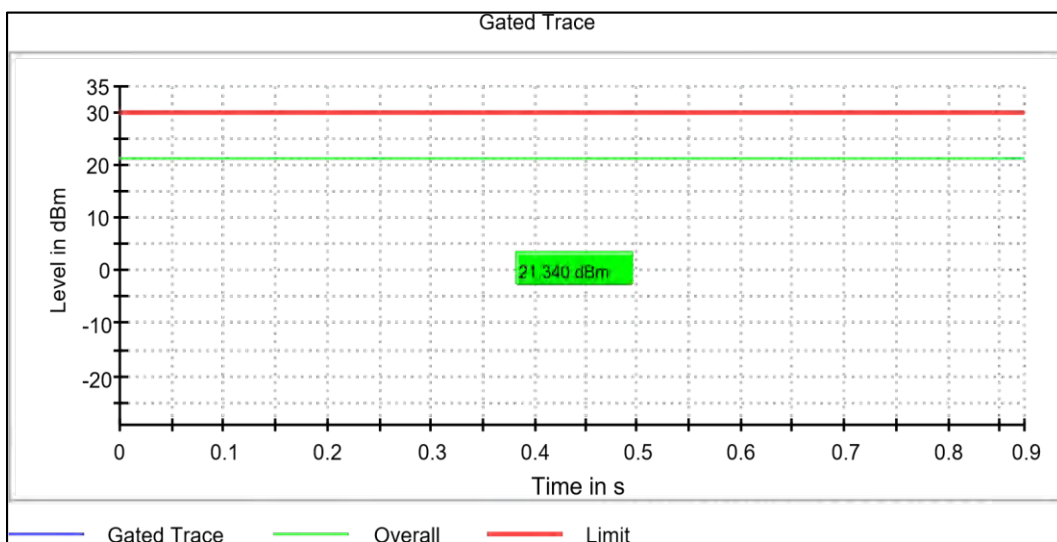

Data Rate: MCS0

Channel Frequency: 2412MHz

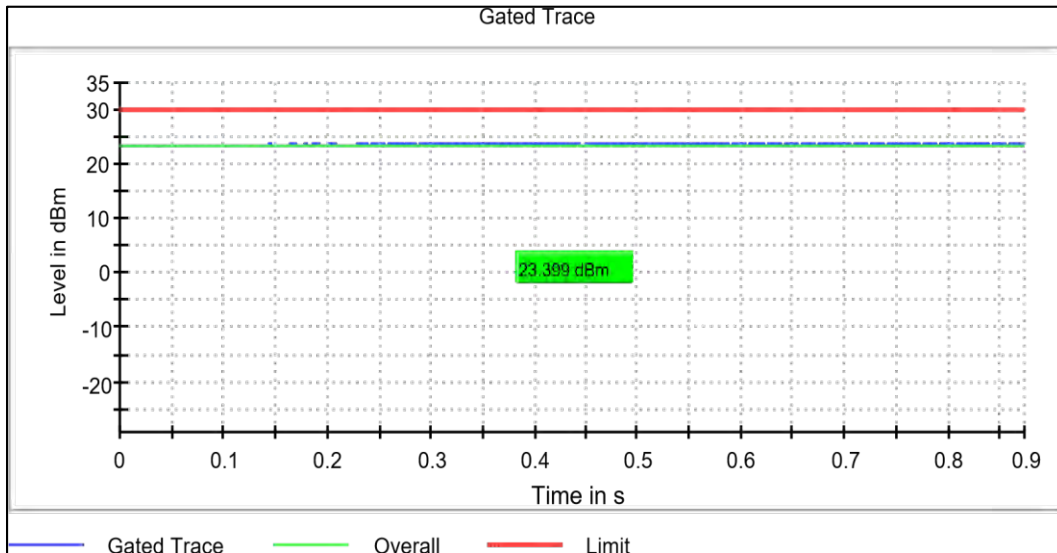

Data Rate: MCS0

Channel Frequency: 2437MHz

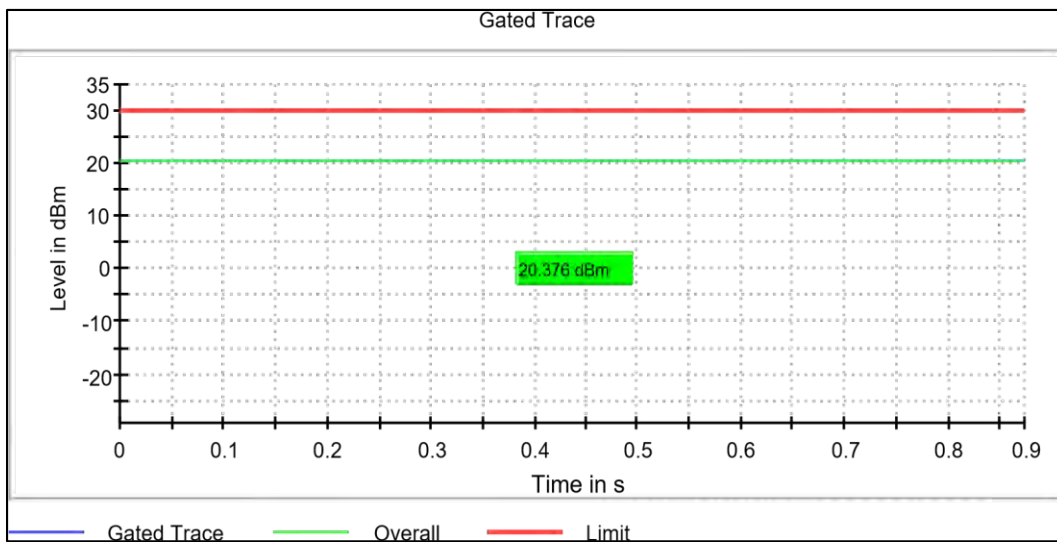

Data Rate: MCS0

Channel Frequency: 2462MHz

Modulation: 802.11n_HT40

Data rate (Mbps)	Channel Frequency (MHz)	Maximum Average output power (dBm)	Maximum (e.i.r.p) (dBm)	Power Limit (dBm)	e.i.r.p Limit (dBm)
MCS0	2422	20.27	24.50	30	36
	2437	24.16	28.39	30	36
	2452	19.15	23.38	30	36
MCS7	2422	20.15	24.38	30	36
	2437	23.74	27.97	30	36
	2452	20.89	25.12	30	36

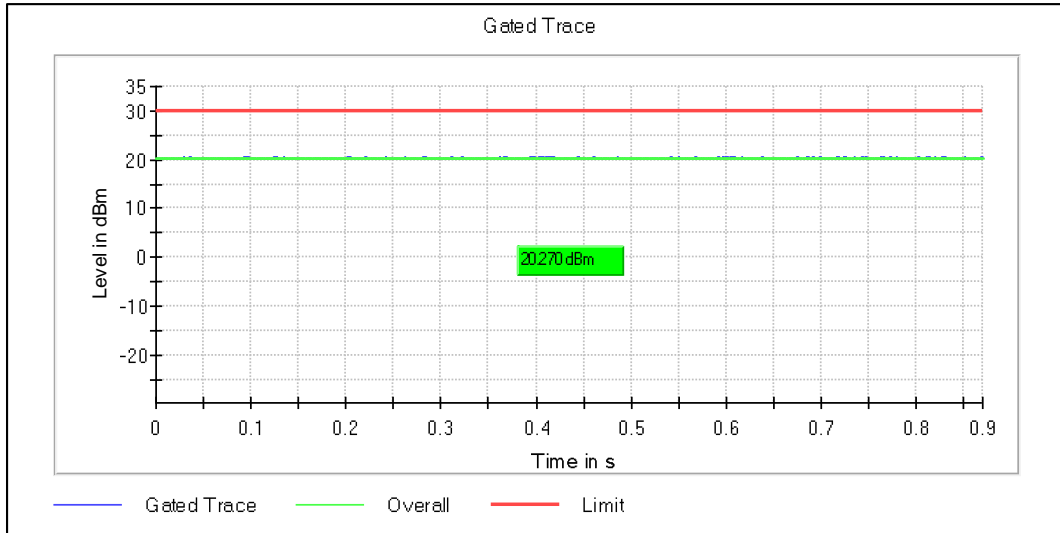

Data Rate: MCS0

Channel Frequency: 2422MHz

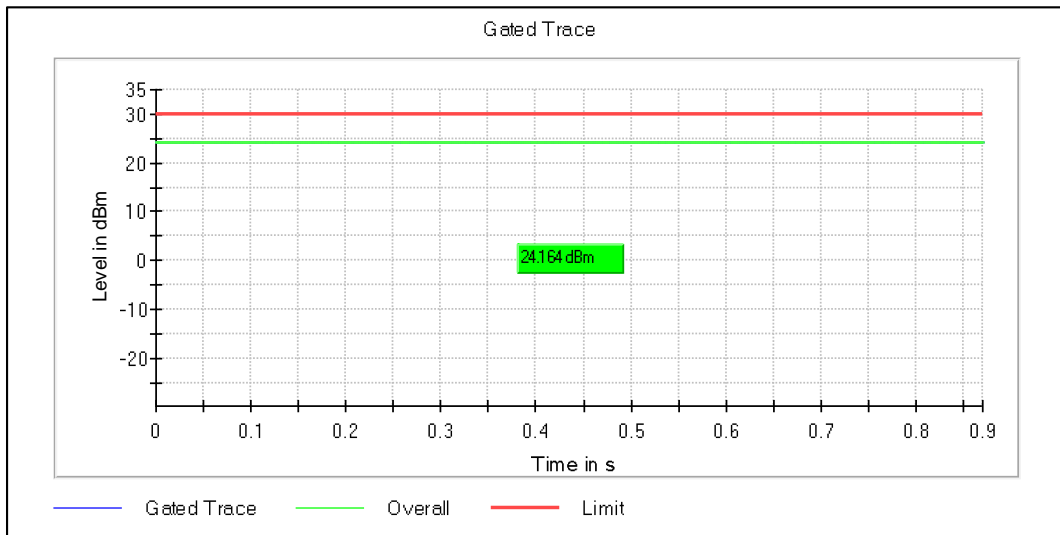

Data Rate: MCS0

Channel Frequency: 2437MHz

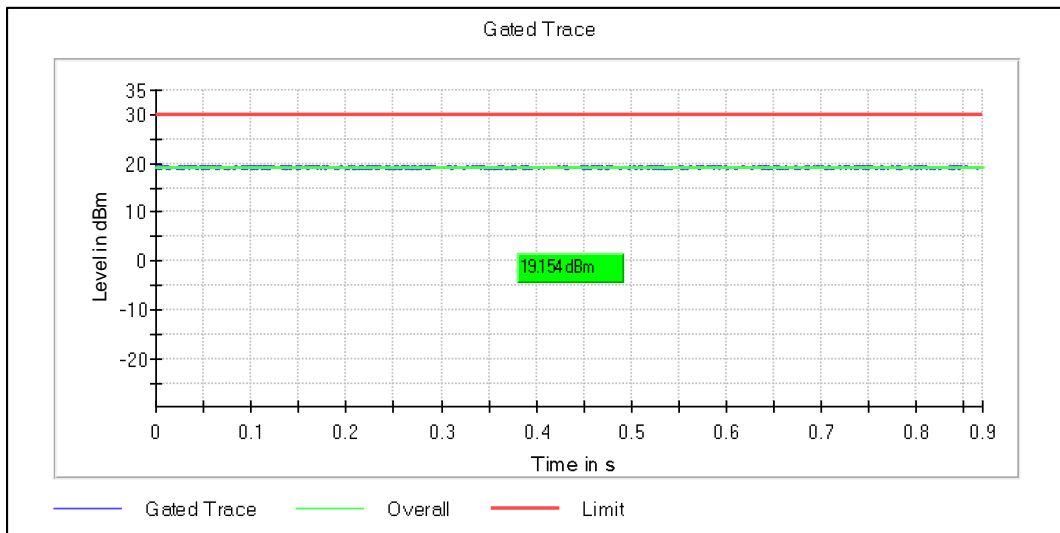

Data Rate: MCS0

Channel Frequency: 2452MHz

Modulation: 802.11ac_VHT40

Data rate (Mbps)	Channel Frequency (MHz)	Maximum Average output power (dBm)	Maximum (e.i.r.p) (dBm)	Power Limit (dBm)	e.i.r.p Limit (dBm)
MCS0	2422	21.83	26.06	30	36
	2437	24.41	28.64	30	36
	2452	19.23	23.46	30	36
MCS8	2422	21.35	25.58	30	36
	2437	23.75	27.98	30	36
	2452	18.61	22.84	30	36

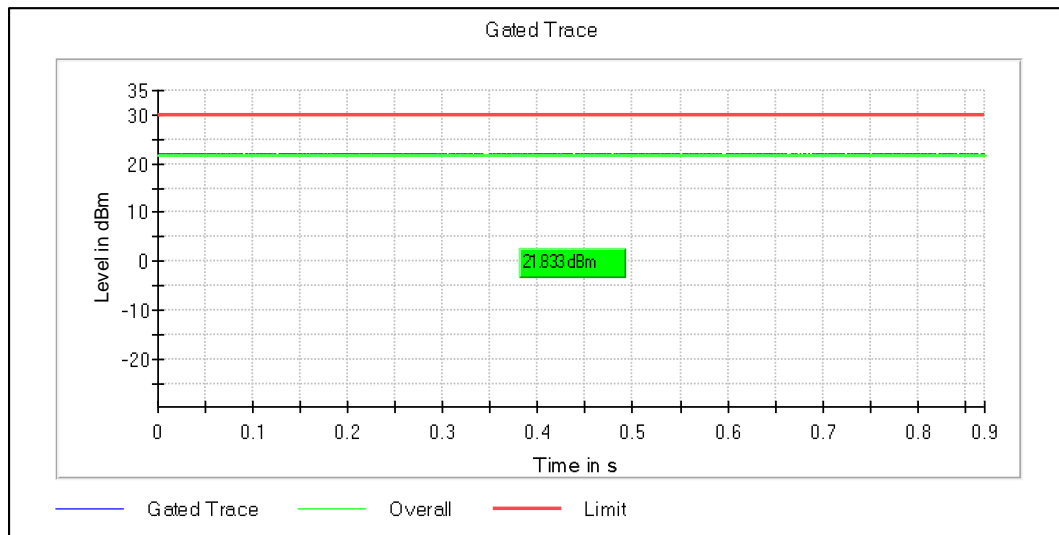

Data Rate: MCS0

Channel Frequency: 2422MHz

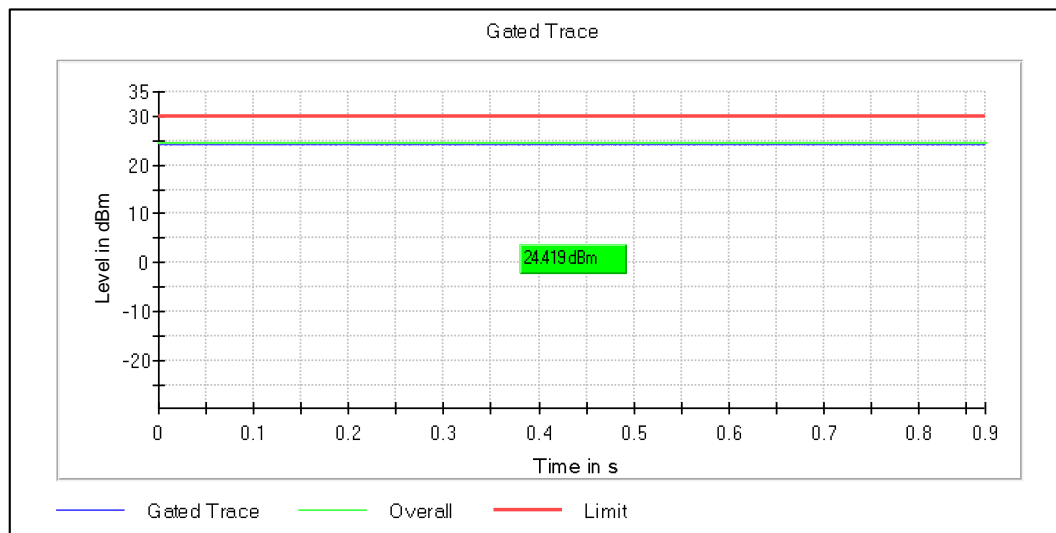

Data Rate: MCS0

Channel Frequency: 2437MHz

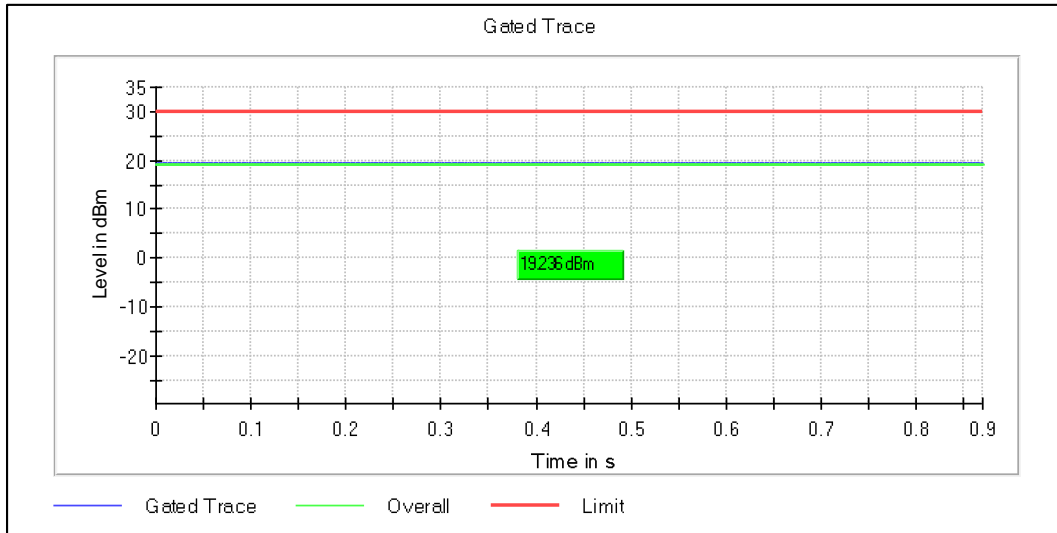

Data Rate: MCS0

Channel Frequency: 2452MHz

Modulation: 802.11ax_HE40

Data rate (Mbps)	Channel Frequency (MHz)	Maximum Average output power (dBm)	Maximum (e.i.r.p) (dBm)	Power Limit (dBm)	e.i.r.p Limit (dBm)
MCS0	2422	18.48	22.71	30	36
	2437	24.29	28.52	30	36
	2452	16.53	20.76	30	36
MCS11	2422	17.16	21.39	30	36
	2437	17.95	22.18	30	36
	2452	17.70	21.93	30	36

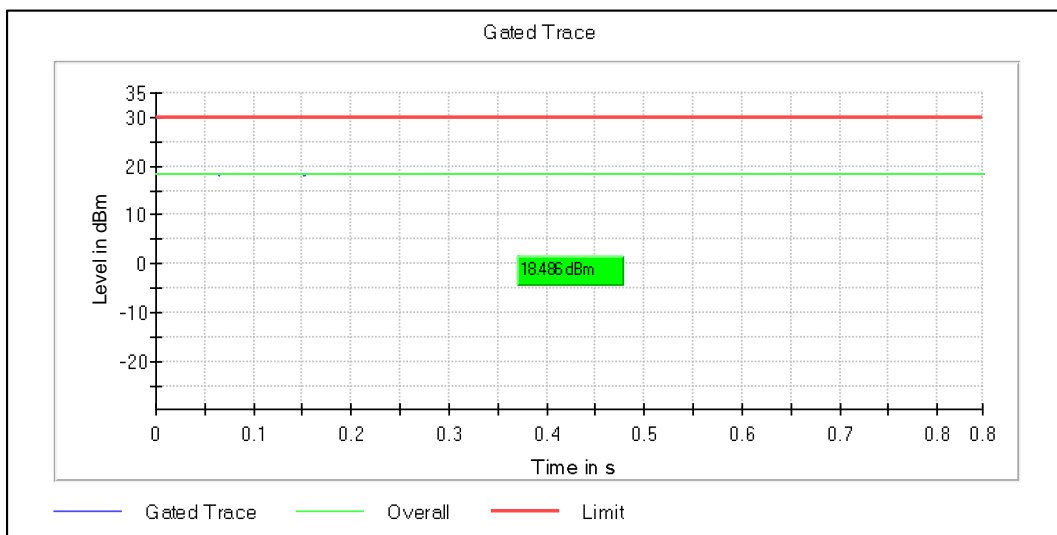

Data Rate: MCS0

Channel Frequency: 2422MHz

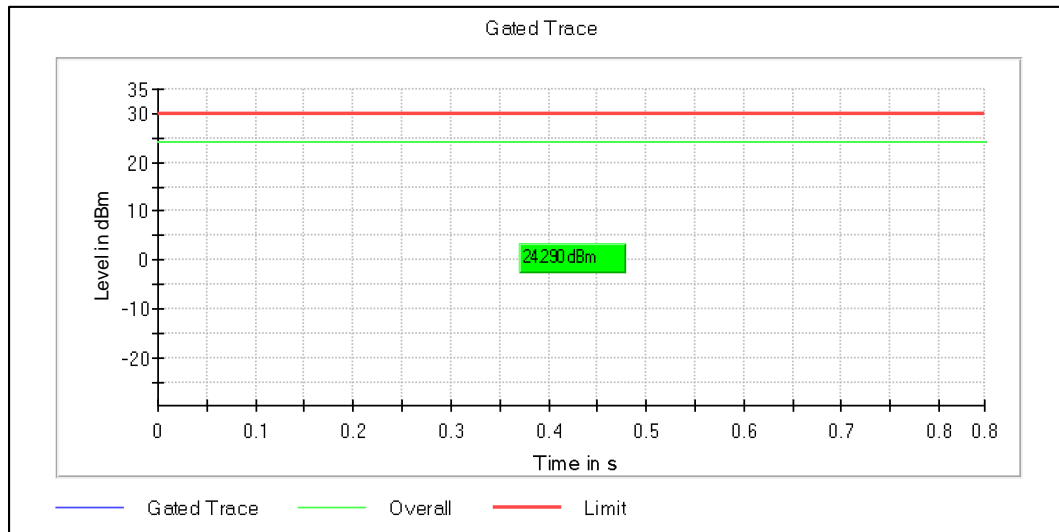

Data Rate: MCS0

Channel Frequency: 2437MHz

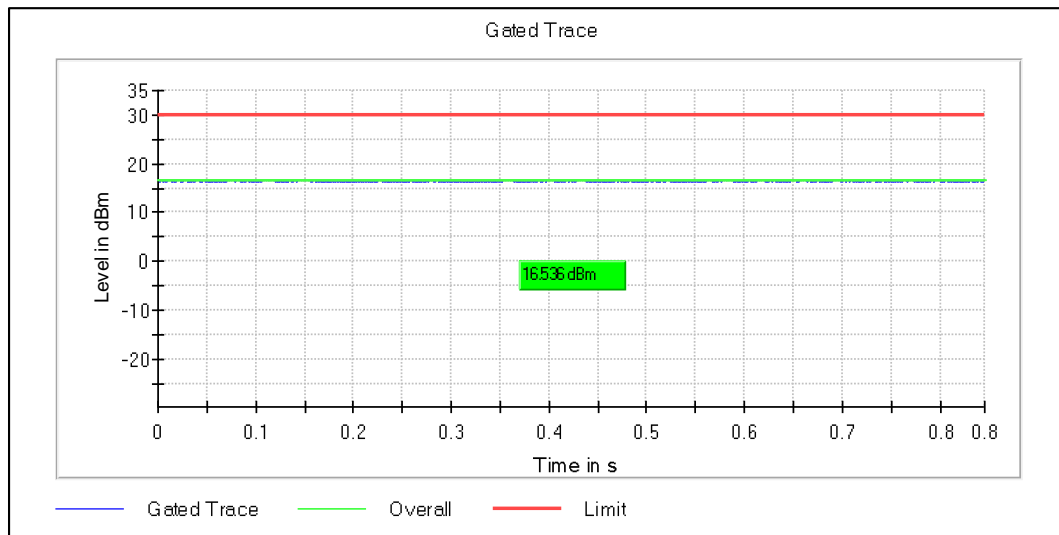

Data Rate: MCS0

Channel Frequency: 2452MHz

Prüfbericht - Nr.:
Test Report No.:

IN2391GP 001

Seite 40 von 229
Page 40 of 229

7.2 Maximum Power Spectral Density

Result

Pass

Test Specification	FCC part 15 Subpart C 15.247 (e) / RSS 247 Issue 2, Section 5.2 (b)
Test Method	Subclause 11.10.3 of ANSI C63.10
Measurement Bandwidth	30 kHz/10kHz/100kHz
Detector	Average sample detector mode
Port of testing	Antenna port
Requirement	For digitally modulated systems, the power spectral density conducted from the intentional radiator to the antenna shall not be greater than 8 dBm

Test Method:

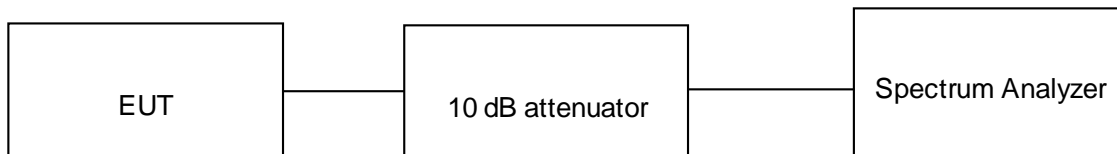

Test Condition

Normal Test Condition:

Temperature (Norm) = + 25°C Voltage = 3.3 V DC through AC to Dc adaptor Relative humidity: 62 %

KDB Guidelines applied:

Measurements were made as per section 8.4 in KDB 558074 D01 15.247 Measurement Guidance v05r02.

Prüfbericht - Nr.:
Test Report No.:

IN2391GP 001

Seite 41 von 229
Page 41 of 229

Antenna Type: 1001932PT (PCB/Flex) MIMO Antenna Results

Note:

1. All the losses are included during measurement and final values are mentioned in the test report.
2. Total Average PSD (dBm/Hz) = Measured Average PSD (dBm/Hz) + Attenuator factor (10dB) + Cable loss (0.4dB)
3. This product do not support additional beamforming gain / directional gain, it uses signal antenna and hence directional gain of the single antenna is 2.50 dBi

Modulation: 802.11b

Data rate (Mbps)	Channel Frequency (MHz)	PSD (dBm/kHz) Chain 1	PSD (dBm/kHz) Chain 2	U.FL Cable loss	PSD (dBm/kHz) Chain1	PSD (dBm/kHz) Chain2	Duty cycle correction factor (dB)	Total PSD (dBm/kHz)	PSD Limit (dBm/kHz)
1Mbps	2412	-5.82	-5.78	1.70	-4.12	-4.08	0.07	-1.02	8.00
	2437	-4.71	-5.74	1.70	-3.01	-4.04	0.07	-0.41	8.00
	2462	-5.18	-4.89	1.70	-3.48	-3.19	0.07	-0.25	8.00
11Mbps	2412	-6.29	-5.98	1.70	-4.59	-4.28	0.66	-0.76	8.00
	2437	-5.48	-5.81	1.70	-3.78	-4.11	0.66	-0.27	8.00
	2462	-6.35	-4.91	1.70	-4.65	-3.21	0.66	-0.20	8.00

*Note: Duty Cycle Correction Factor Calculation

10*LOG (1/X) Where X is Duty Cycle is considered in below results

Duty cycle correction Factor is considered in Final Average PSD

A cable loss Correction factor of **1.70dB** was added to the measured value Chain 1 and Chain 2 results.

Prüfbericht - Nr.:
Test Report No.:

IN2391GP 001

Seite 42 von 229
Page 42 of 229

Chain 1:

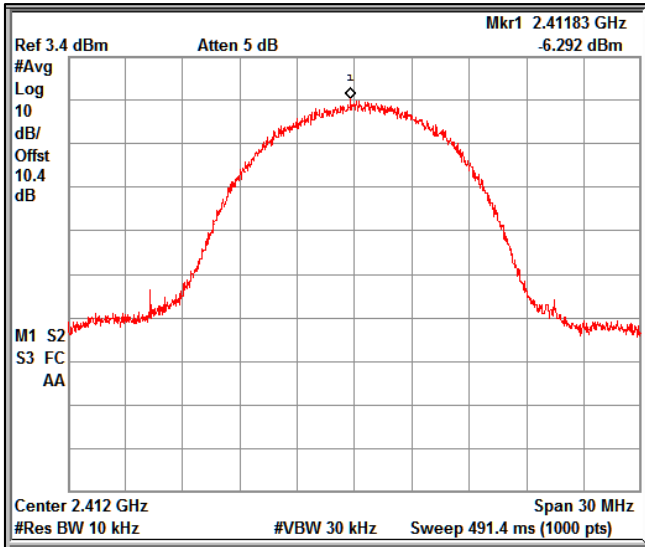

Data Rate: 11Mbps Channel Frequency: 2412MHz

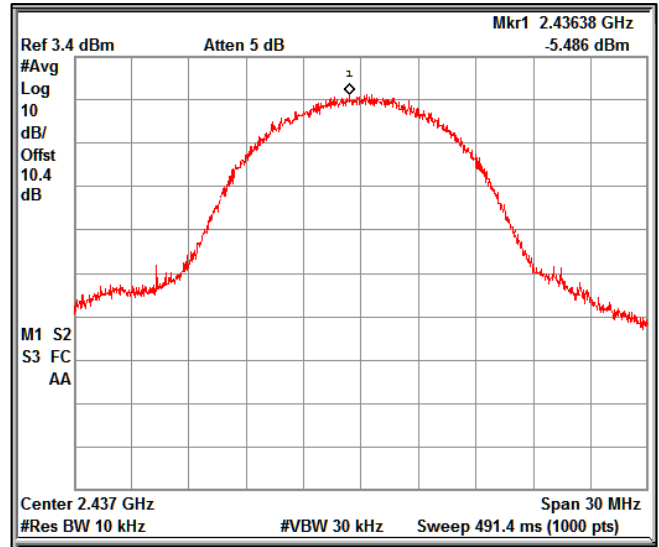

Data Rate: 11Mbps Channel Frequency: 2437MHz

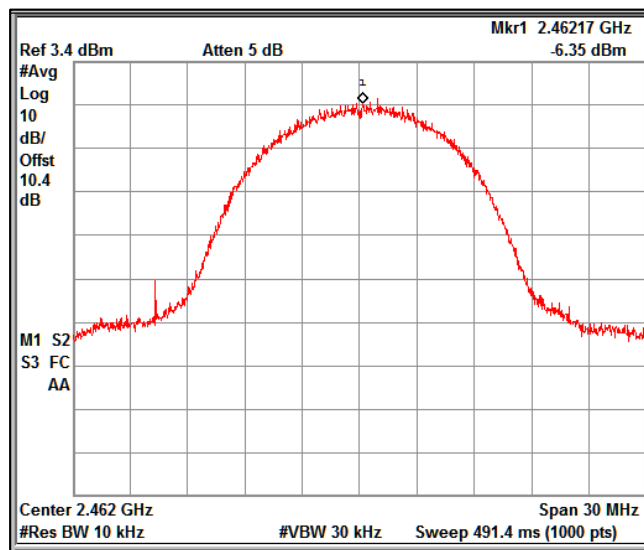

Data Rate: 11Mbps Channel Frequency: 2462MHz

Prüfbericht - Nr.:
Test Report No.:

IN2391GP 001

Seite 43 von 229
Page 43 of 229

Chain 2:

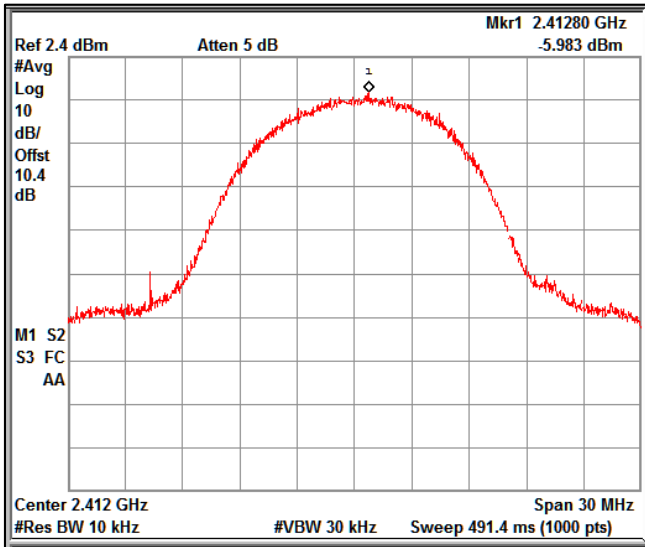

Data Rate: 11Mbps Channel Frequency: 2412MHz

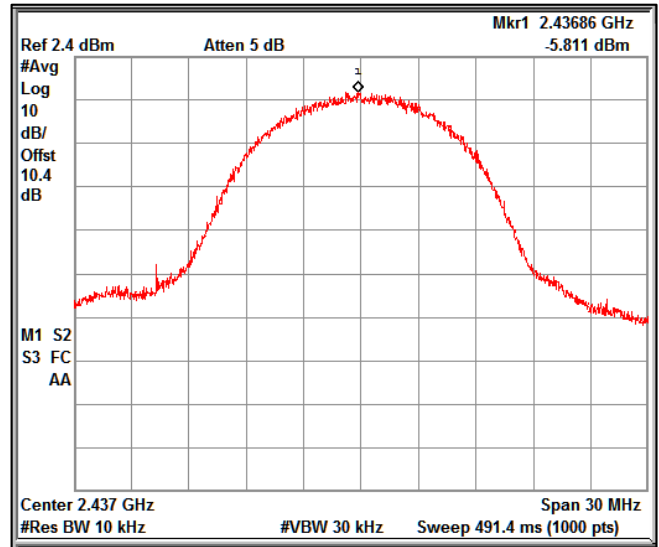

Data Rate: 11Mbps Channel Frequency: 2437MHz

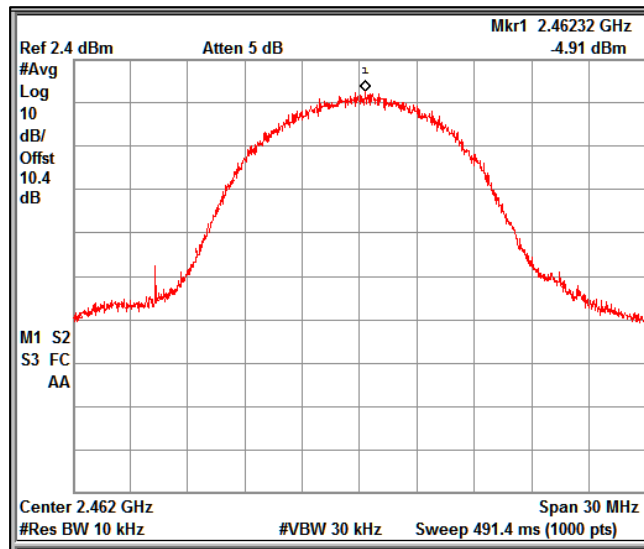

Data Rate: 11Mbps Channel Frequency: 2462MHz

Modulation: 802.11g

Data rate (Mbps)	Channel Frequency (MHz)	PSD (dBm/kHz) Chain1	PSD (dBm/kHz) Chain2	U.FL Cable loss	PSD (dBm/kHz) Chain1	PSD (dBm/kHz) Chain2	Duty cycle correction factor (dB)	Total PSD (dBm/kHz)	PSD Limit (dBm/kHz)
6Mbps	2412	-9.82	-9.36	1.70	-8.12	-7.66	0.43	-4.45	8.00
	2437	-6.61	-7.13	1.70	-4.91	-5.43	0.43	-1.73	8.00
	2462	-10.90	-8.69	1.70	-9.20	-6.99	0.43	-4.52	8.00
54Mbps	2412	-11.23	-10.53	1.70	-9.53	-8.83	2.58	-3.58	8.00
	2437	-11.28	-11.38	1.70	-9.58	-9.68	2.58	-4.04	8.00
	2462	-11.51	-10.59	1.70	-9.81	-8.89	2.58	-3.73	8.00

*Note: Duty Cycle Correction Factor Calculation

$10 \cdot \text{LOG} (1/X)$ Where X is Duty Cycle is considered in below results

Duty cycle correction Factor is considered in Final Average PSD

A cable loss Correction factor of **1.70dB** was added to the measured value Chain 1 and Chain 2 results.

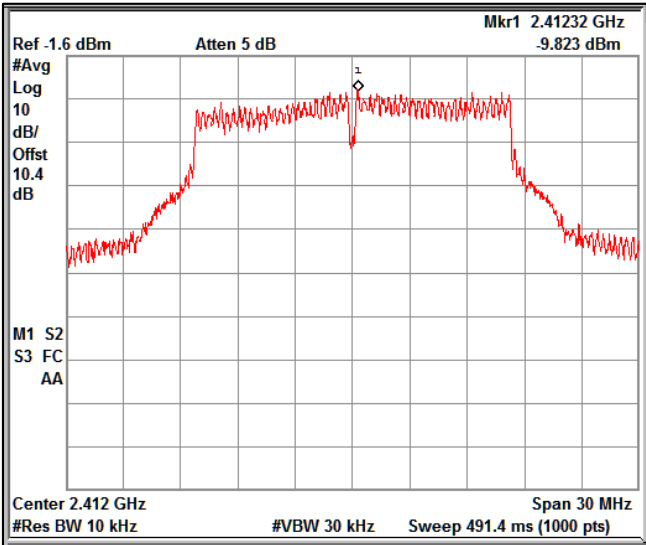
Chain 1:

Data Rate: 6Mbps Channel Frequency: 2412MHz

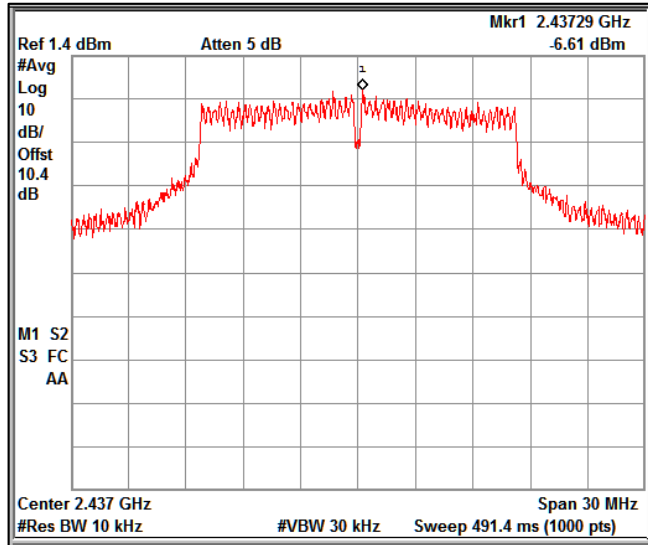

Data Rate: 6Mbps Channel Frequency: 2437MHz

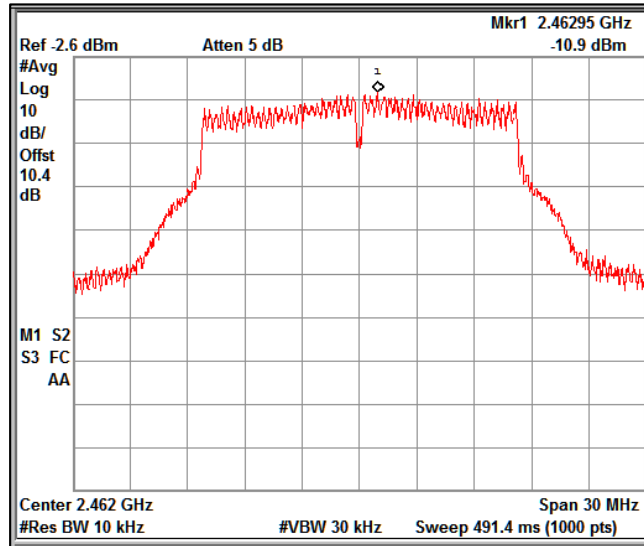

Data Rate: 6Mbps Channel Frequency: 2462MHz

Chain 2:

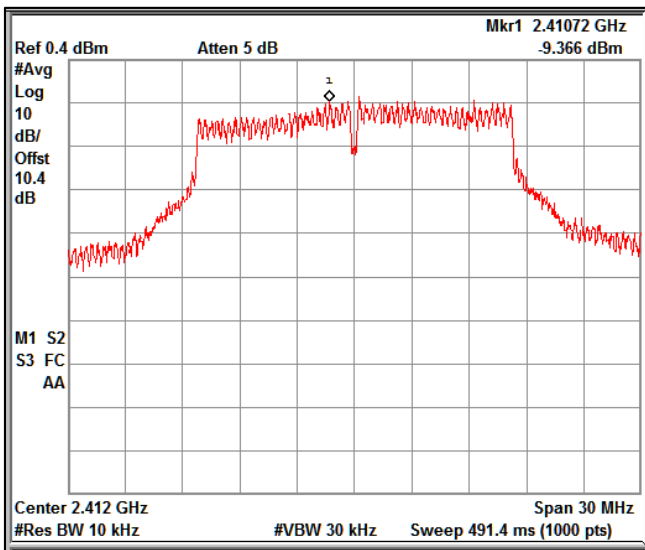

Data Rate: 6Mbps Channel Frequency: 2412MHz

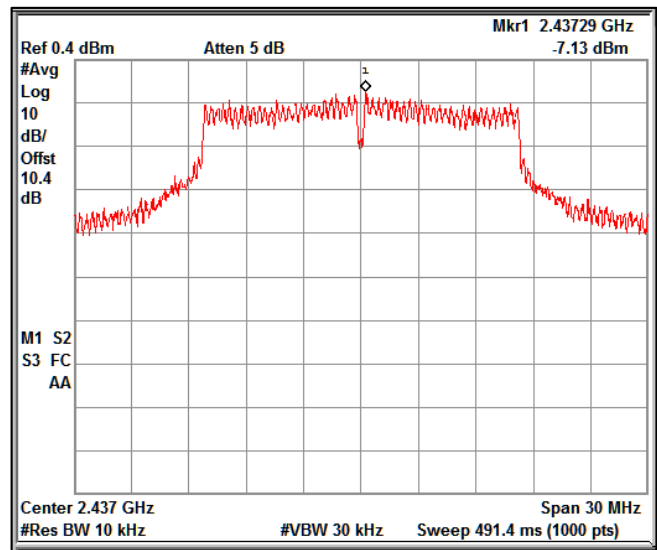

Data Rate: 6Mbps Channel Frequency: 2437MHz

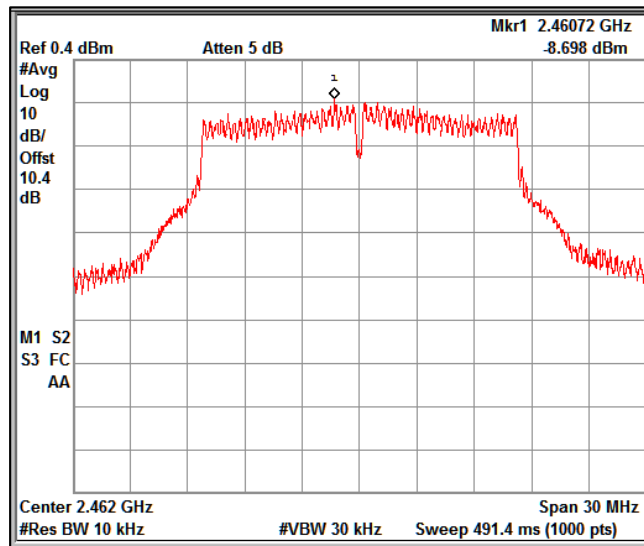

Data Rate: 6Mbps Channel Frequency: 2462MHz

Modulation: 802.11n_HT20

Data rate (Mbps)	Channel Frequency (MHz)	PSD (dBm/kHz) Chain1	PSD (dBm/kHz) Chain2	U.FL Cable loss	PSD (dBm/kHz) Chain1	PSD (dBm/kHz) Chain2	Duty cycle correction factor (dB)	Total PSD (dBm/kHz)	PSD Limit (dBm/kHz)
MCS0	2412	-12.05	-10.82	1.70	-10.35	-9.12	0.46	-6.23	8.00
	2437	-8.64	-7.13	1.70	-6.94	-5.43	0.46	-2.65	8.00
	2462	-11.58	-8.69	1.70	-9.88	-6.99	0.46	-4.73	8.00
MCS7	2412	-12.92	-9.83	1.70	-11.22	-8.13	2.72	-3.68	8.00
	2437	-11.95	-10.65	1.70	-10.25	-8.95	2.72	-3.82	8.00
	2462	-12.77	-12.88	1.70	-11.07	-11.18	2.72	-5.39	8.00

*Note: Duty Cycle Correction Factor Calculation

10*LOG (1/X) Where X is Duty Cycle is considered in below results

Duty cycle correction Factor is considered in Final Average PSD

A cable loss Correction factor of **1.70dB** was added to the measured value Chain 1 and Chain 2 results.

Chain 1:

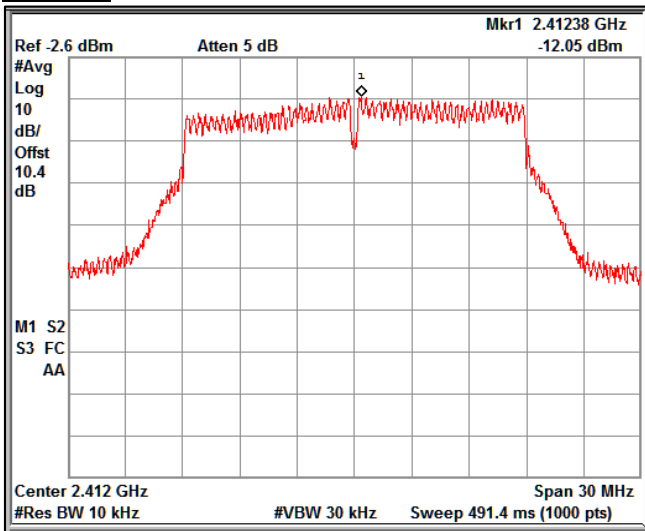

Data Rate: MCS0 Channel Frequency: 2412MHz

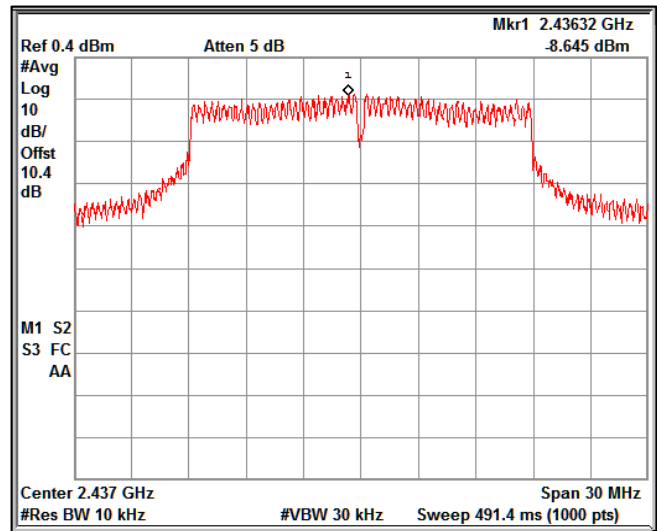

Data Rate: MCS0 Channel Frequency: 2437MHz

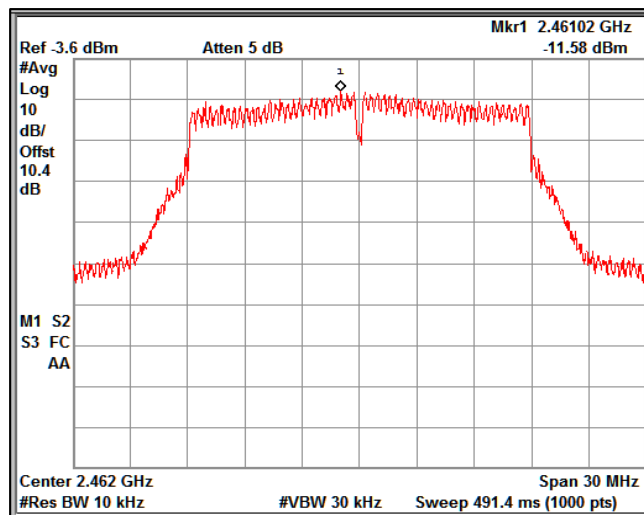

Data Rate: MCS0 Channel Frequency: 2462MHz

Prüfbericht - Nr.:
Test Report No.:

IN2391GP 001

Seite 48 von 229
Page 48 of 229

Modulation: 802.11ac_VHT20

Data rate (Mbps)	Channel Frequency (MHz)	PSD (dBm/kHz) Chain1	PSD (dBm/kHz) Chain2	U.FL Cable loss	PSD (dBm/kHz) Chain1	PSD (dBm/kHz) Chain2	Duty cycle correction factor (dB)	Total PSD (dBm/kHz)	PSD Limit (dBm/kHz)
MCS0	2412	-9.64	-9.07	1.70	-7.94	-7.37	0.45	-4.18	8.00
	2437	-6.87	-7.51	1.70	-5.17	-5.81	0.45	-2.02	8.00
	2462	-12.38	-10.86	1.70	-10.68	-9.16	0.45	-6.39	8.00
MCS8	2412	-14.06	-12.91	1.70	-12.36	-11.21	2.92	-5.81	8.00
	2437	-12.93	-12.81	1.70	-11.23	-11.11	2.92	-5.23	8.00
	2462	-13.37	-12.33	1.70	-11.67	-10.63	2.92	-5.18	8.00

*Note: Duty Cycle Correction Factor Calculation

$10 \cdot \text{LOG} (1/X)$ Where X is Duty Cycle is considered in below results

Duty cycle correction Factor is considered in Final Average PSD

A cable loss Correction factor of **1.70dB** was added to the measured value Chain 1 and Chain 2 results.

Chain 1:

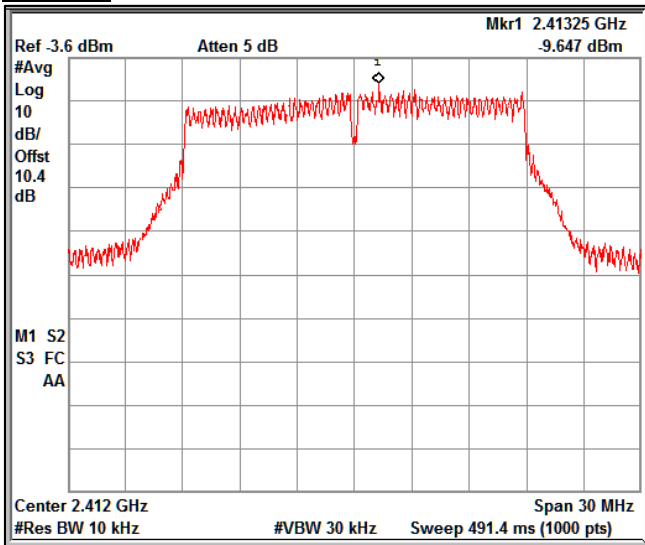

Data Rate: MCS0 Channel Frequency: 2412MHz

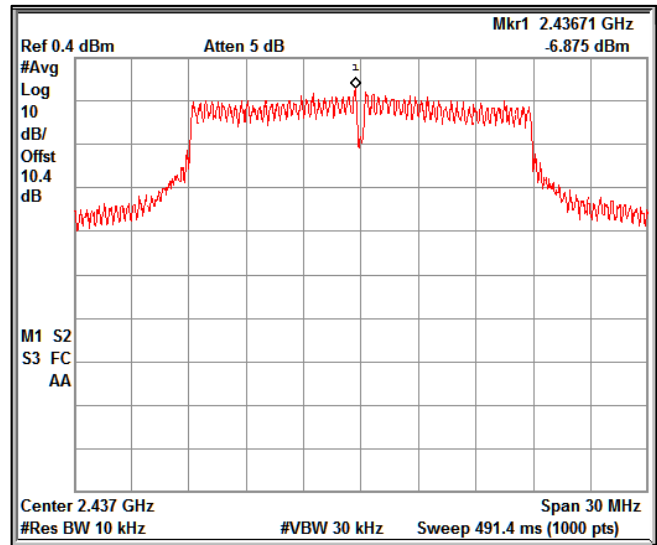

Data Rate: MCS0 Channel Frequency: 2437MHz

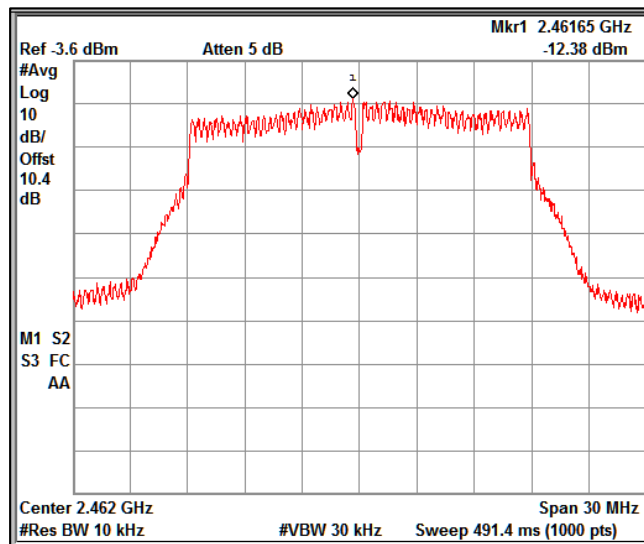

Data Rate: MCS0 Channel Frequency: 2462MHz

Chain 2:

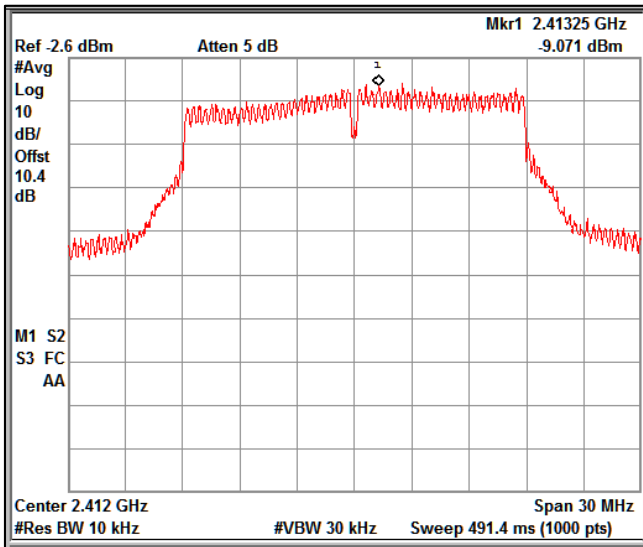

Data Rate: MCS0 Channel Frequency: 2412MHz

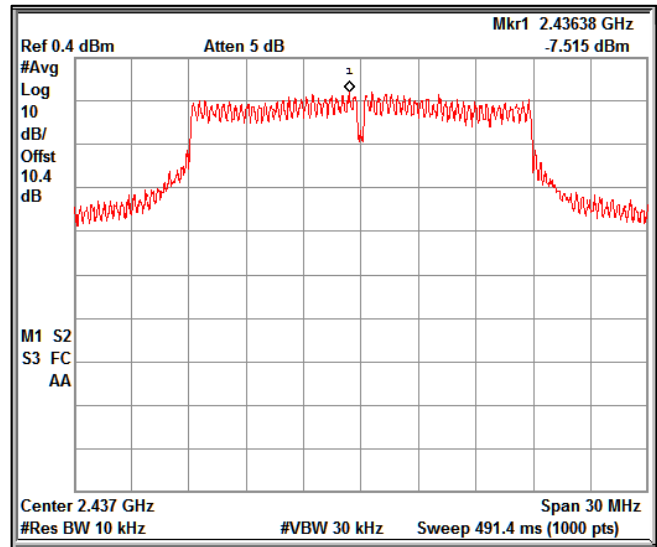

Data Rate: MCS0 Channel Frequency: 2437MHz

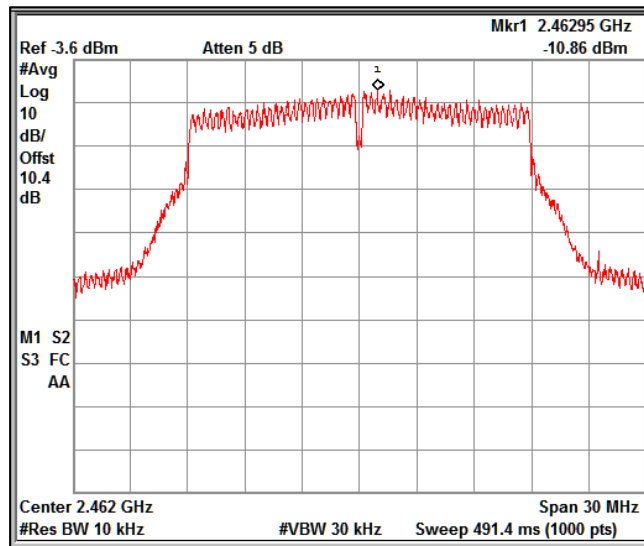

Data Rate: MCS0 Channel Frequency: 2462MHz

Modulation: 802.11ax_HE20

Data rate (Mbps)	Channel Frequency (MHz)	PSD (dBm/kHz) Chain1	PSD (dBm/kHz) Chain2	U.FL Cable loss	PSD (dBm/kHz) Chain1	PSD (dBm/kHz) Chain2	Duty cycle correction factor (dB)	Total PSD (dBm/kHz)	PSD Limit (dBm/kHz)
MCS0	2412	-14.04	-12.53	1.70	-12.34	-10.83	0.57	-7.94	8.00
	2437	-7.61	-8.48	1.70	-5.91	-6.78	0.57	-2.74	8.00
	2462	-13.47	-12.13	1.70	-11.77	-10.43	0.57	-7.46	8.00
MCS11	2412	-15.58	-13.70	1.70	-13.88	-12.00	3.47	-6.36	8.00
	2437	-14.73	-14.45	1.70	-13.03	-12.75	3.47	-6.41	8.00
	2462	-14.83	-14.02	1.70	-13.13	-12.32	3.47	-6.22	8.00

*Note: Duty Cycle Correction Factor Calculation

$10 \cdot \text{LOG} (1/X)$ Where X is Duty Cycle is considered in below results

Duty cycle correction Factor is considered in Final Average PSD

A cable loss Correction factor of **1.70dB** was added to the measured value Chain 1 and Chain 2 results.

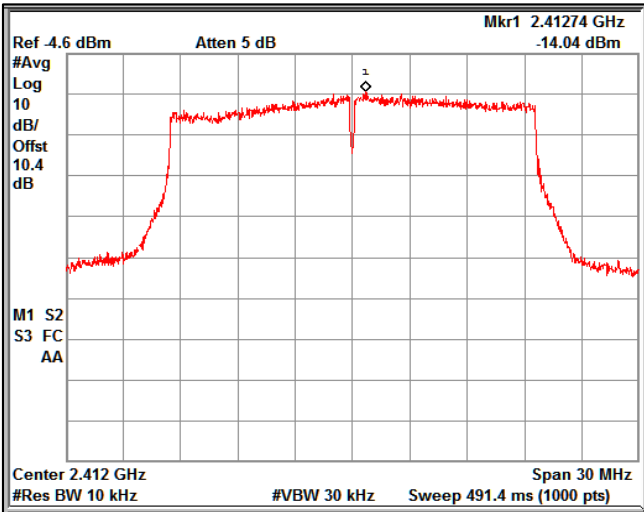
Chain 1:

Data Rate: MCS0 Channel Frequency: 2412MHz

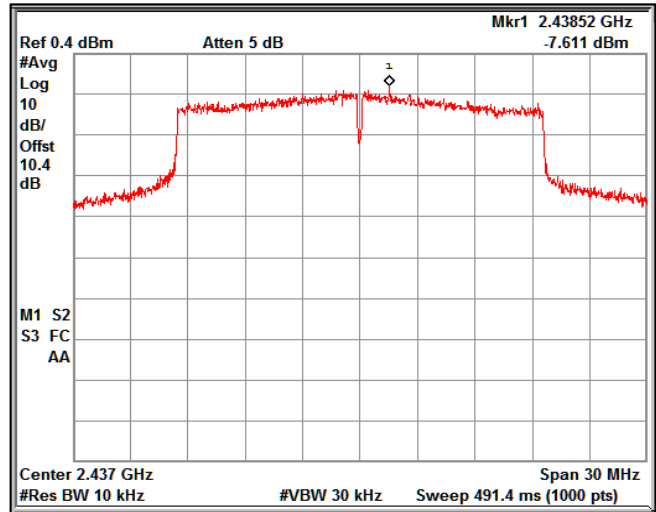

Data Rate: MCS0 Channel Frequency: 2437MHz

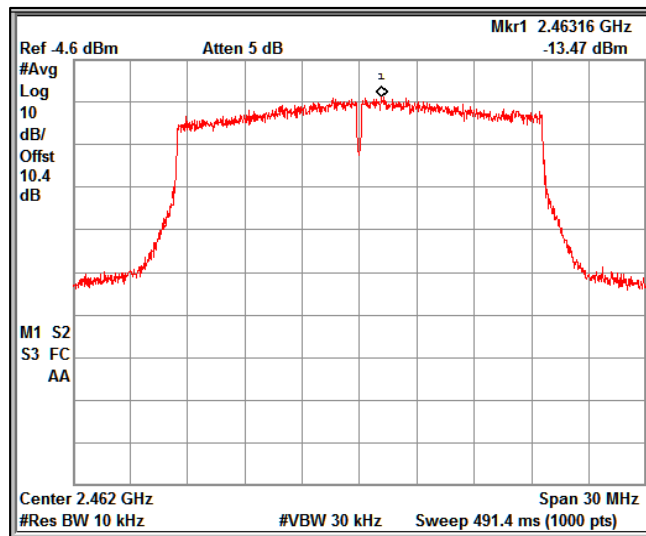

Data Rate: MCS0 Channel Frequency: 2462MHz

Chain 2:

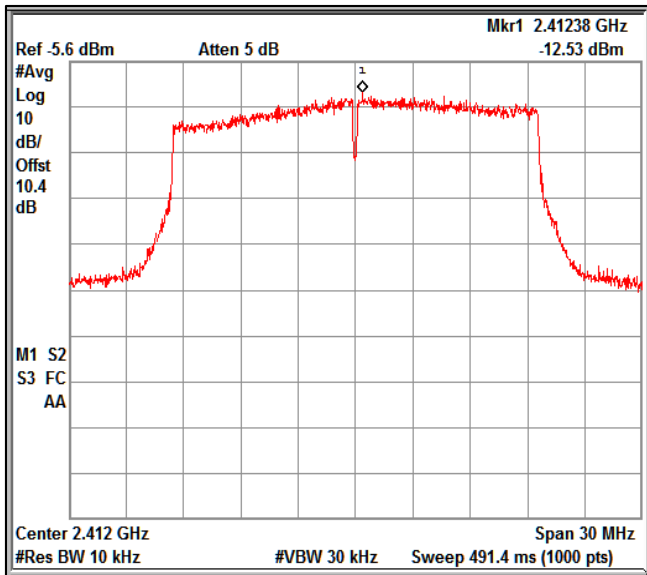

Data Rate: MCS0 Channel Frequency: 2412MHz

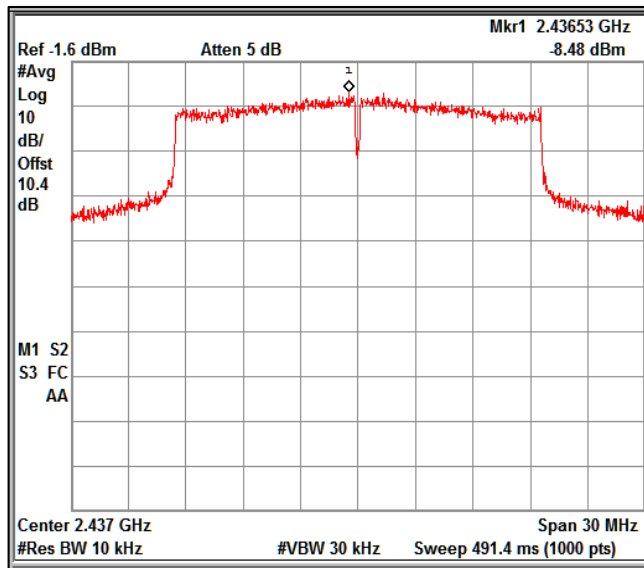

Data Rate: MCS0 Channel Frequency: 2437MHz

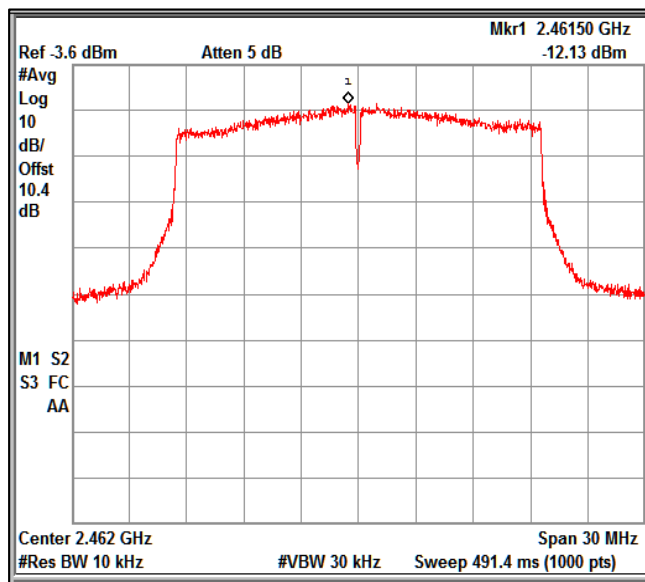

Data Rate: MCS0 Channel Frequency: 2462MHz

Modulation: 802.11n_HT40

Data rate (Mbps)	Channel Frequency (MHz)	PSD (dBm/kHz) Chain1	PSD (dBm/kHz) Chain2	U.FL Cable loss	PSD (dBm/kHz) Chain1	PSD (dBm/kHz) Chain2	Duty cycle correction factor (dB)	Total PSD (dBm/kHz)	PSD Limit (dBm/kHz)
MCS0	2422	-8.75	-8.79	1.70	-7.05	-7.09	0.46	-3.60	8.00
	2437	-3.23	-2.17	1.70	-1.53	-0.47	0.46	2.50	8.00
	2452	-9.42	-9.53	1.70	-7.72	-7.83	0.46	-4.31	8.00
MCS7	2422	-12.05	-11.36	1.70	-10.35	-9.66	2.72	-4.26	8.00
	2437	-9.49	-9.87	1.70	-7.79	-8.17	2.72	-2.25	8.00
	2452	-12.59	-11.83	1.70	-10.89	-10.13	2.72	-4.76	8.00

*Note: Duty Cycle Correction Factor Calculation

$10 \cdot \text{LOG} (1/X)$ Where X is Duty Cycle is considered in below results

Duty cycle correction Factor is considered in Final Average PSD

A cable loss Correction factor of **1.70dB** was added to the measured value Chain 1 and Chain 2 results.

Chain 1:

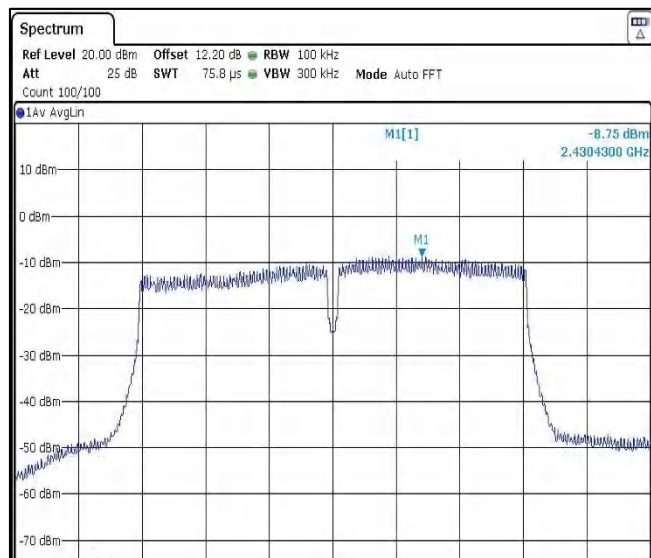

Data Rate: MCS0 Channel Frequency: 2422MHz

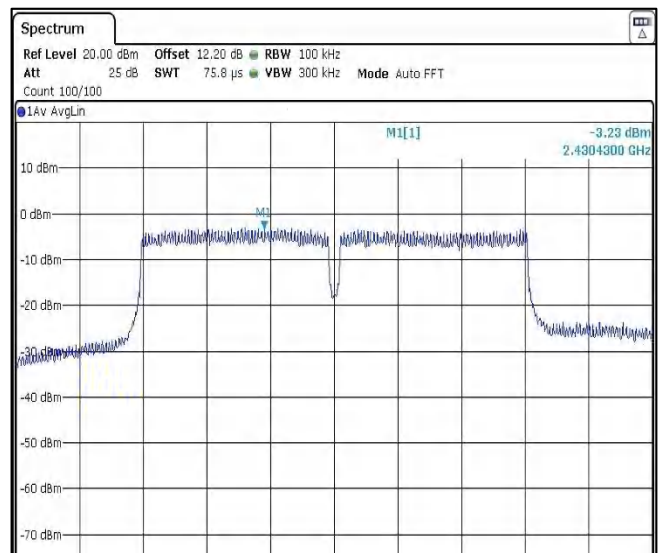

Data Rate: MCS0 Channel Frequency: 2437MHz

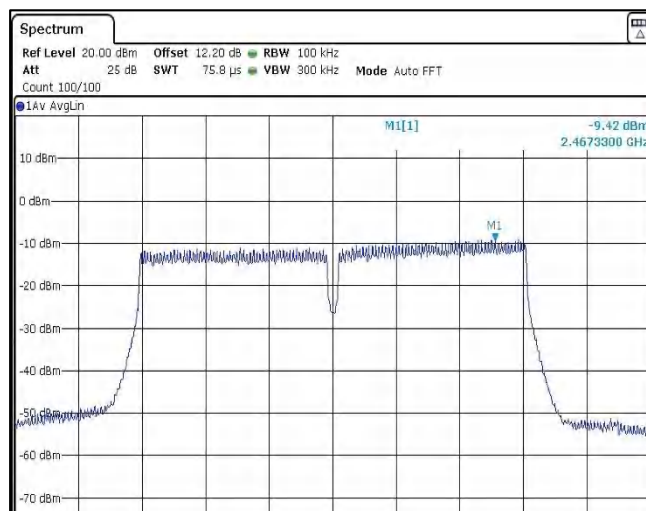

Data Rate: MCS0 Channel Frequency: 2452MHz

Chain 2:

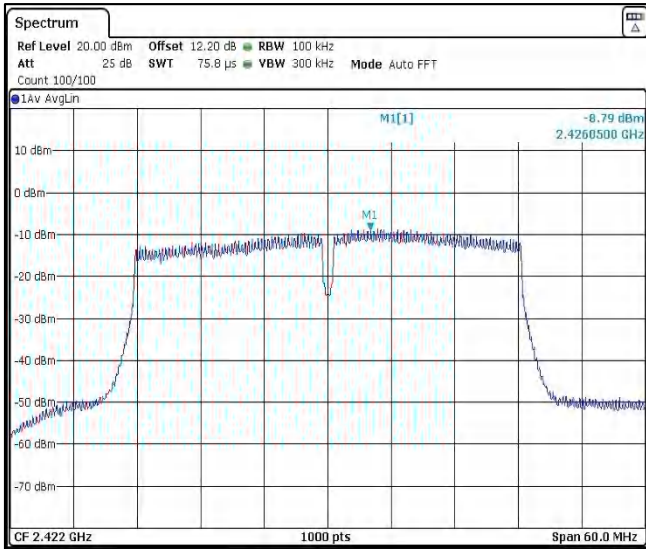

Data Rate: MCS0 Channel Frequency: 2422MHz

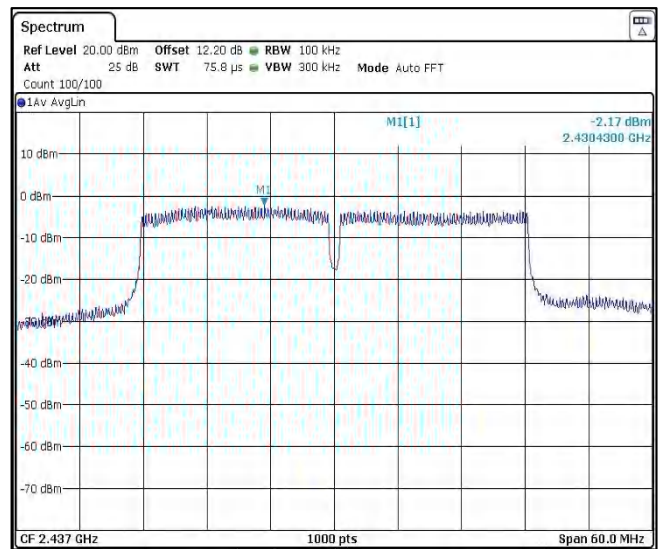

Data Rate: MCS0 Channel Frequency: 2437MHz

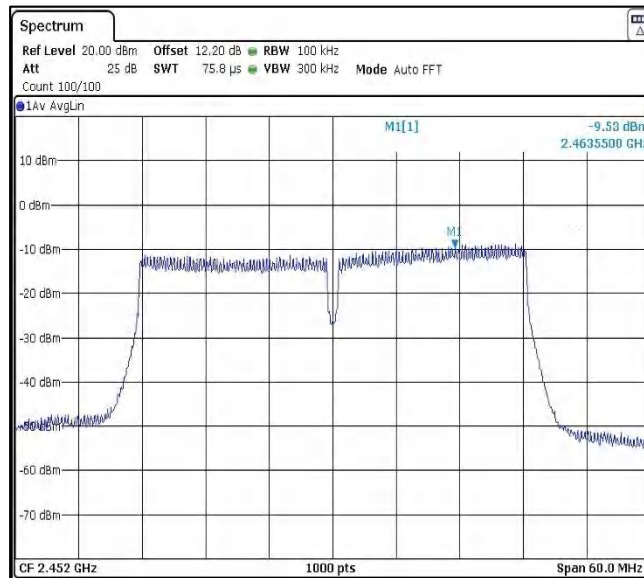

Data Rate: MCS0 Channel Frequency: 2452MHz

Prüfbericht - Nr.:
Test Report No.:

IN2391GP 001

Seite 54 von 229
Page 54 of 229

Modulation: 802.11ac_VHT40

Data rate (Mbps)	Channel Frequency (MHz)	PSD (dBm/kHz) Chain1	PSD (dBm/kHz) Chain2	U.FL Cable loss	PSD (dBm/kHz) Chain1	PSD (dBm/kHz) Chain2	Duty cycle correction factor (dB)	Total PSD (dBm/kHz)	PSD Limit (dBm/kHz)
MCS0	2422	-7.29	-7.44	1.70	-5.59	-5.74	0.45	-2.20	8.00
	2437	-3.43	-2.57	1.70	-1.73	-0.87	0.45	2.18	8.00
	2452	-9.54	-9.29	1.70	-7.84	-7.59	0.45	-4.25	8.00
MCS8	2422	-11.95	-10.76	1.70	-10.25	-9.06	2.92	-3.68	8.00
	2437	-12.34	-13.69	1.70	-10.64	-11.99	2.92	-5.33	8.00
	2452	-11.42	-11.95	1.70	-9.72	-10.25	2.92	-4.04	8.00

*Note: Duty Cycle Correction Factor Calculation

10*LOG (1/X) Where X is Duty Cycle is considered in below results

Duty cycle correction Factor is considered in Final Average PSD

A cable loss Correction factor of **1.70dB** was added to the measured value Chain 1 and Chain 2 results.

Chain 1:

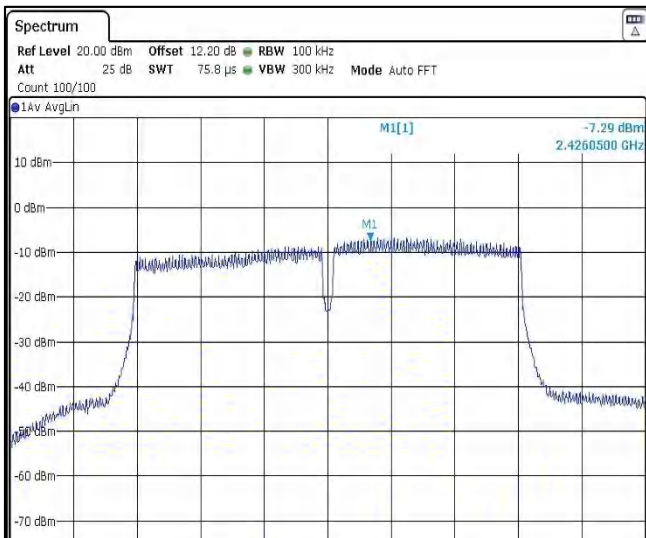

Data Rate: MCS0 Channel Frequency: 2422MHz

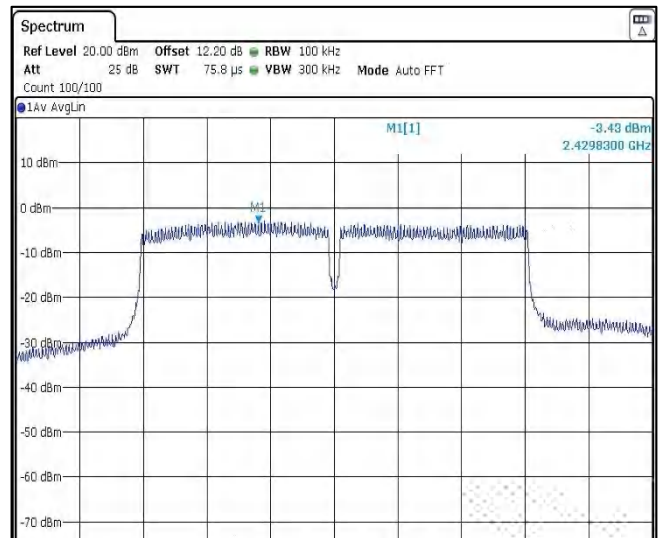

Data Rate: MCS0 Channel Frequency: 2437MHz

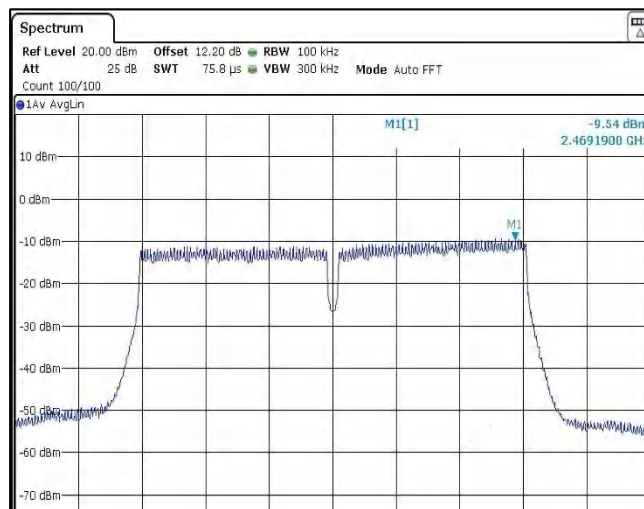

Data Rate: MCS0 Channel Frequency: 2452MHz

Chain 2:

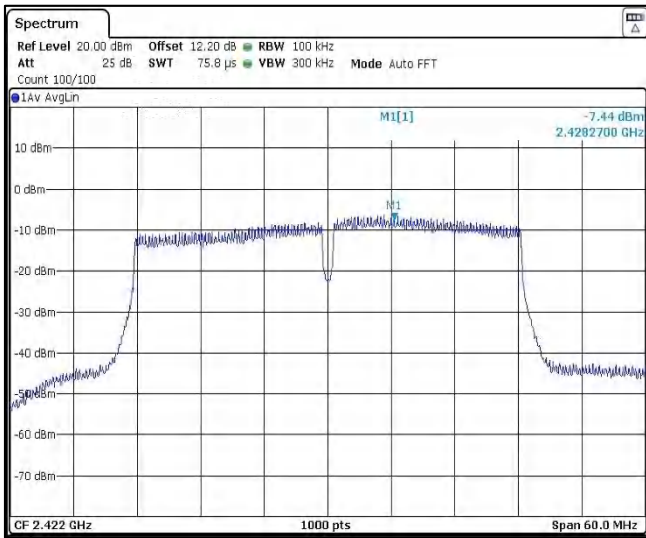

Data Rate: MCS0 Channel Frequency: 2422MHz

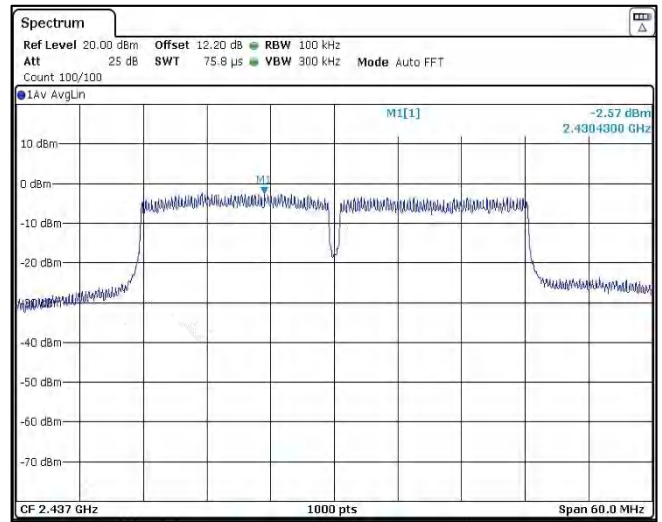

Data Rate: MCS0 Channel Frequency: 2437MHz

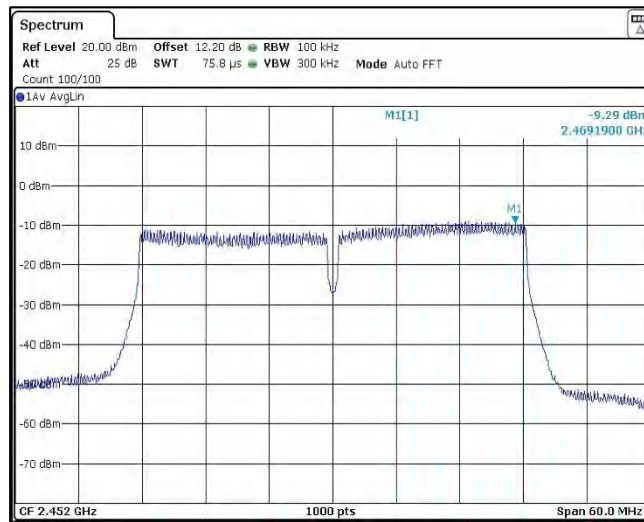

Data Rate: MCS0 Channel Frequency: 2452MHz

Modulation: 802.11ax_HE40

Data rate (Mbps)	Channel Frequency (MHz)	PSD (dBm/kHz) Chain1	PSD (dBm/kHz) Chain2	U.FL Cable loss	PSD (dBm/kHz) Chain1	PSD (dBm/kHz) Chain2	Duty cycle correction factor (dB)	Total PSD (dBm/kHz)	PSD Limit (dBm/kHz)
MCS0	2422	-9.27	-8.83	1.70	-7.57	-7.13	0.57	-3.76	8.00
	2437	-3.62	-3.86	1.70	-1.92	-2.16	0.57	1.55	8.00
	2452	-11.37	-11.67	1.70	-9.67	-9.97	0.57	-6.23	8.00
MCS11	2422	-11.79	-12.60	1.70	-10.09	-10.90	3.47	-4.00	8.00
	2437	-11.78	-14.11	1.70	-10.08	-12.41	3.47	-4.61	8.00
	2452	-10.82	-12.86	1.70	-9.12	-11.16	3.47	-3.54	8.00

*Note: Duty Cycle Correction Factor Calculation

$10 \cdot \text{LOG}(1/X)$ Where X is Duty Cycle is considered in below results

Duty cycle correction Factor is considered in Final Average PSD

A cable loss Correction factor of **1.70dB** was added to the measured value Chain 1 and Chain 2 results.

Chain 1:

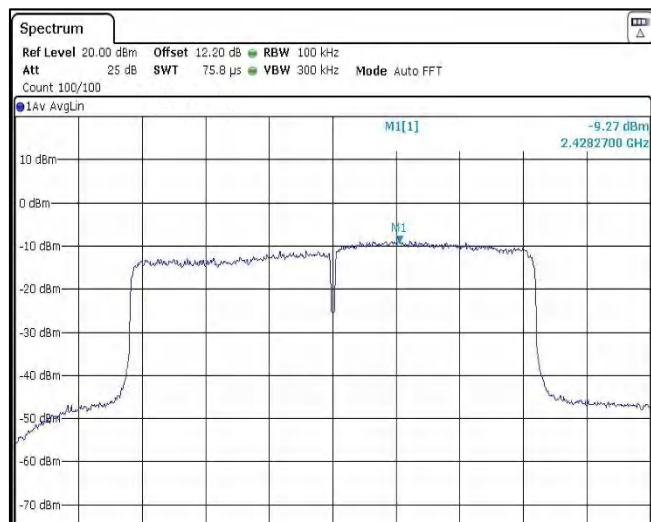

Data Rate: MCS0 Channel Frequency: 2422MHz

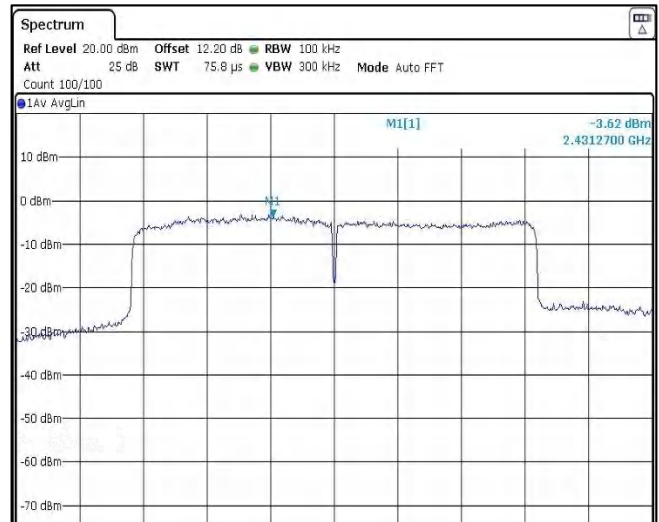

Data Rate: MCS0 Channel Frequency: 2437MHz

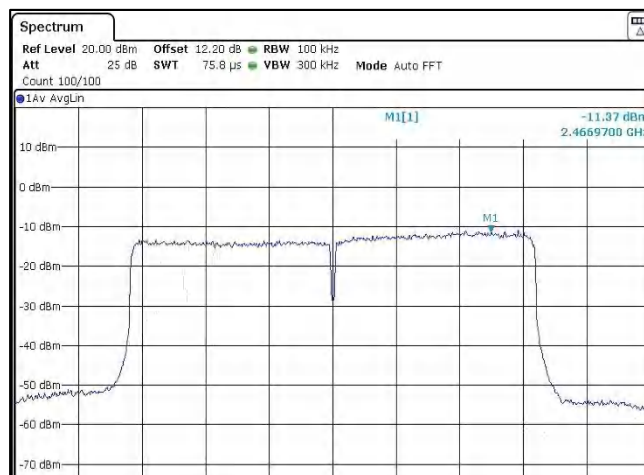

Data Rate: MCS0 Channel Frequency: 2452MHz

Chain 2:

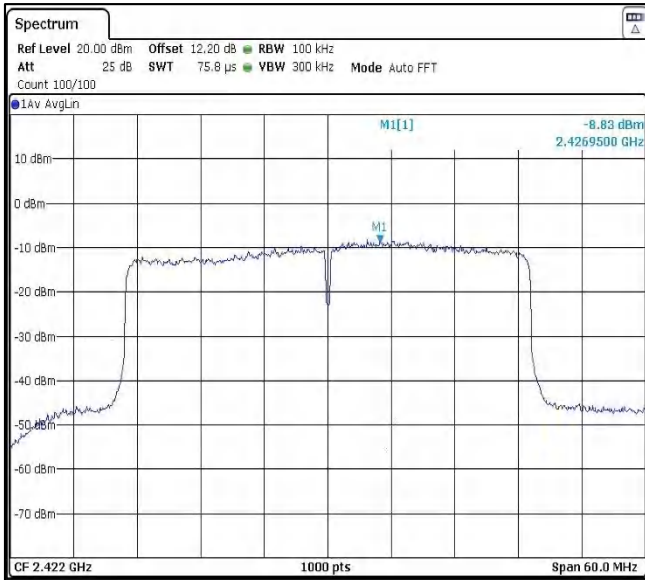

Data Rate: MCS0 Channel Frequency: 2422MHz

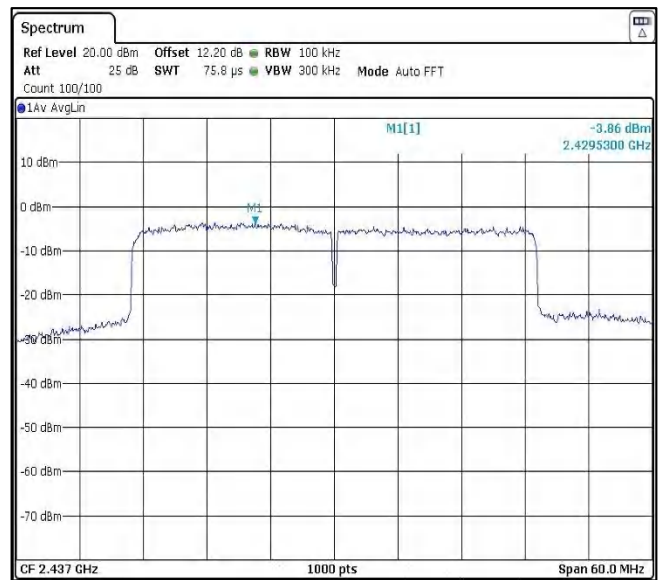

Data Rate: MCS0 Channel Frequency: 2437MHz

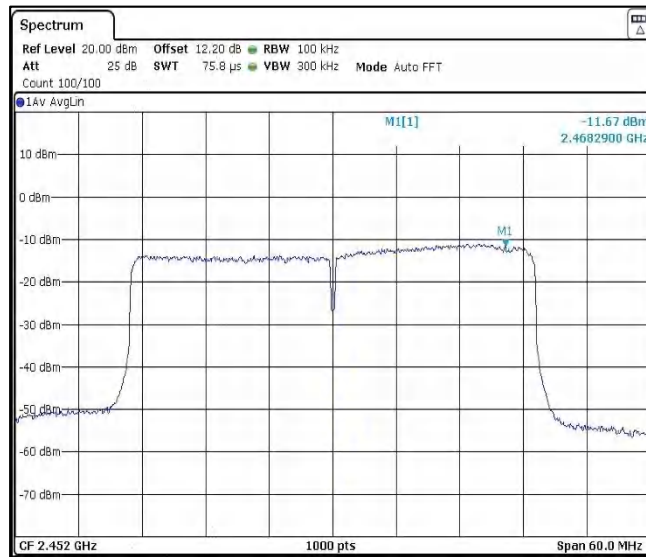

Data Rate: MCS0 Channel Frequency: 2452MHz

Prüfbericht - Nr.:
Test Report No.:

IN2391GP 001

Seite 58 von 229
Page 58 of 229

Antenna Type: FPA3020-10A (PCB/Flex) MIMO Antenna Results

Note:

1. All the losses are included during measurement and final values are mentioned in the test report.
2. Total Average PSD (dBm) = Measured Average PSD (dBm) + Attenuator factor (10dB) + Cable loss (0.4dB)
3. This product do not support additional beamforming gain / directional gain, it uses signal antenna and hence directional gain of the single antenna is 4.23 dBi

Modulation: 802.11b

Data rate (Mbps)	Channel Frequency (MHz)	PSD (dBm/kHz) Chain1	PSD (dBm/kHz) Chain2	U.FL Cable loss	PSD (dBm/kHz) Chain1	PSD (dBm/kHz) Chain2	Duty cycle correction factor (dB)	Total PSD (dBm/kHz)	PSD Limit (dBm/kHz)
1Mbps	2412	-5.82	-5.78	1.70	-4.12	-4.08	0.07	-1.02	8.00
	2437	-4.71	-5.74	1.70	-3.01	-4.04	0.07	-0.41	8.00
	2462	-5.18	-4.89	1.70	-3.48	-3.19	0.07	-0.25	8.00
11Mbps	2412	-6.29	-5.98	1.70	-4.59	-4.28	0.66	-0.76	8.00
	2437	-5.48	-5.81	1.70	-3.78	-4.11	0.66	-0.27	8.00
	2462	-6.35	-4.91	1.70	-4.65	-3.21	0.66	-0.20	8.00

*Note: Duty Cycle Correction Factor Calculation

10*LOG (1/X) Where X is Duty Cycle is considered in below results

Duty cycle correction Factor is considered in Final Average PSD

A cable loss Correction factor of **1.70dB** was added to the measured value Chain 1 and Chain 2 results.

Chain 1:

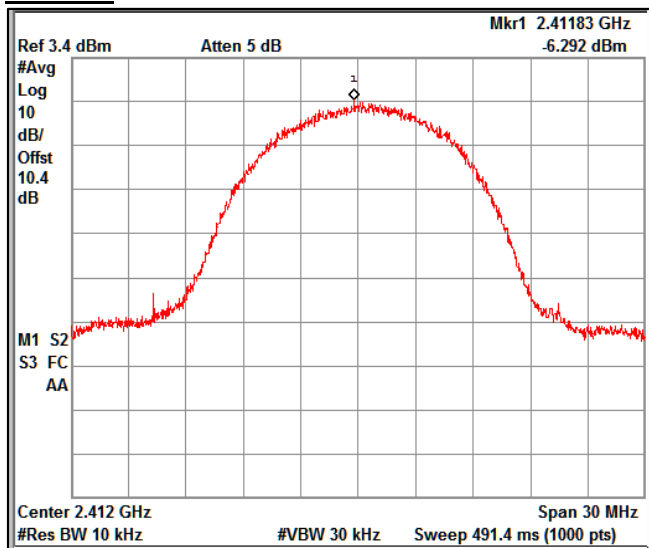

Data Rate: 11Mbps Channel Frequency: 2412MHz

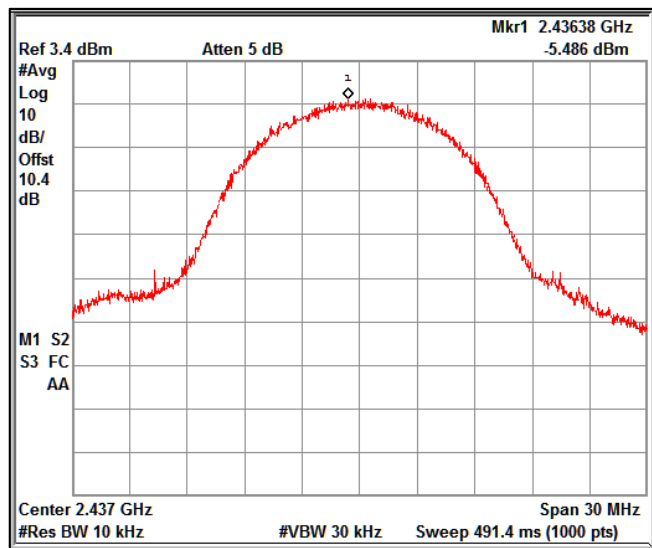

Data Rate: 11Mbps Channel Frequency: 2437MHz

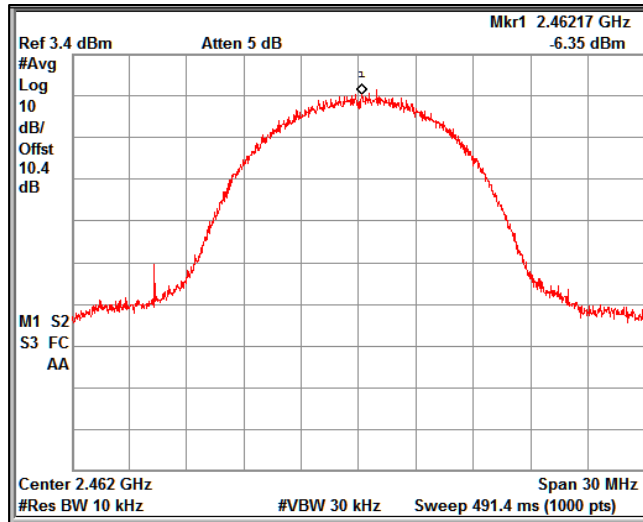

Data Rate: 11Mbps Channel Frequency: 2462MHz

Chain 2:

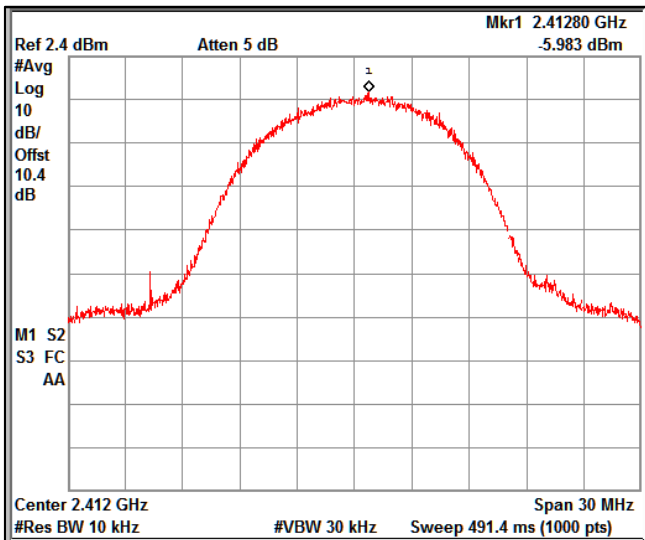

Data Rate: 11Mbps Channel Frequency: 2412MHz

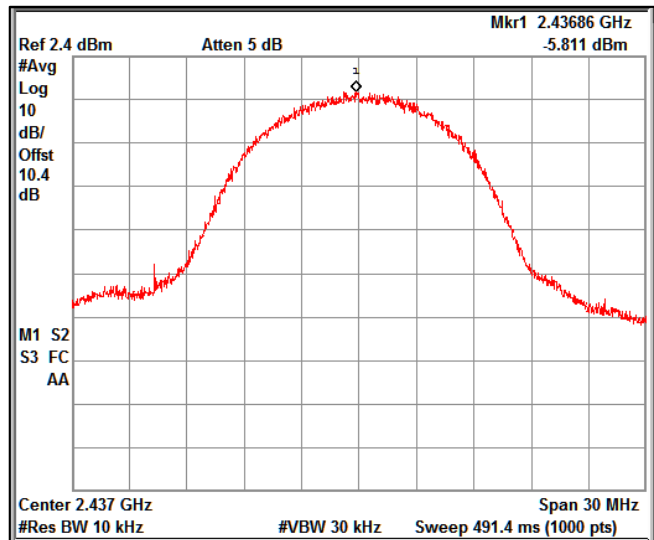

Data Rate: 11Mbps Channel Frequency: 2437MHz

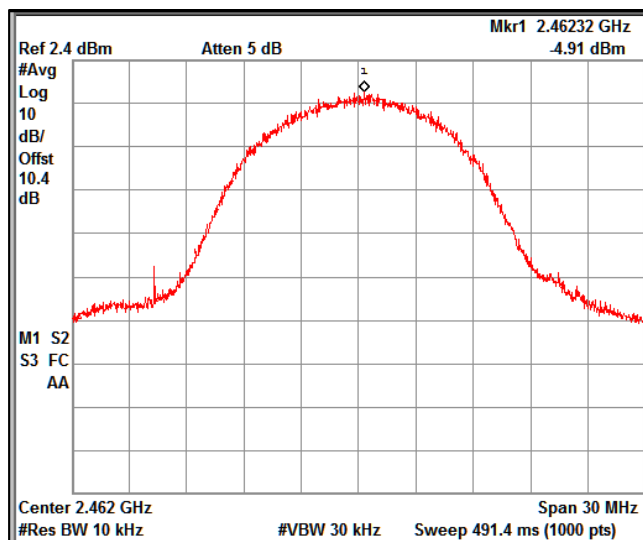

Data Rate: 11Mbps Channel Frequency: 2462MHz

Modulation: 802.11g

Data rate (Mbps)	Channel Frequency (MHz)	PSD (dBm/kHz) Chain1	PSD (dBm/kHz) Chain2	U.FL Cable loss	PSD (dBm/kHz) Chain1	PSD (dBm/kHz) Chain2	Duty cycle correction factor (dB)	Total PSD (dBm/kHz)	PSD Limit (dBm/kHz)
6Mbps	2412	-8.89	-8.76	1.70	-7.19	-7.06	0.43	-3.69	8.00
	2437	-7.98	-7.64	1.70	-6.28	-5.94	0.43	-2.67	8.00
	2462	-6.05	-8.86	1.70	-4.35	-7.16	0.43	-2.10	8.00
54Mbps	2412	-11.23	-10.53	1.70	-9.53	-8.83	2.58	-3.58	8.00
	2437	-11.28	-11.38	1.70	-9.58	-9.68	2.58	-4.04	8.00
	2462	-11.51	-10.59	1.70	-9.81	-8.89	2.58	-3.73	8.00

*Note: Duty Cycle Correction Factor Calculation

10*LOG (1/X) Where X is Duty Cycle is considered in below results

Duty cycle correction Factor is considered in Final Average PSD

A cable loss Correction factor of **1.70dB** was added to the measured value Chain 1 and Chain 2 results.

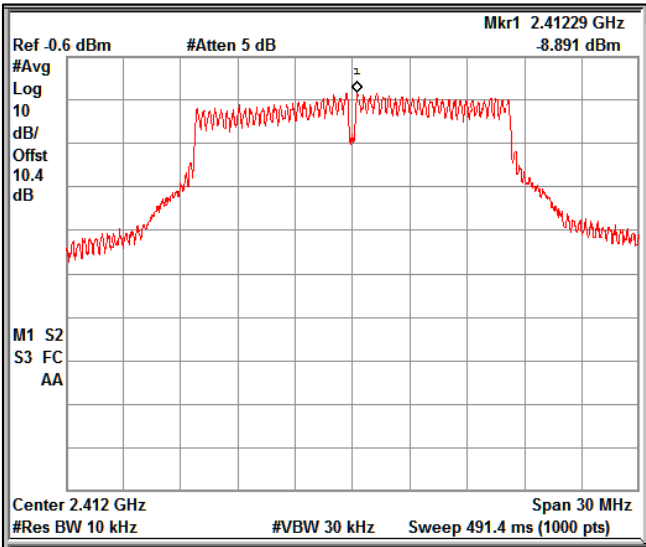
Chain 1:

Data Rate: 6Mbps Channel Frequency: 2412MHz

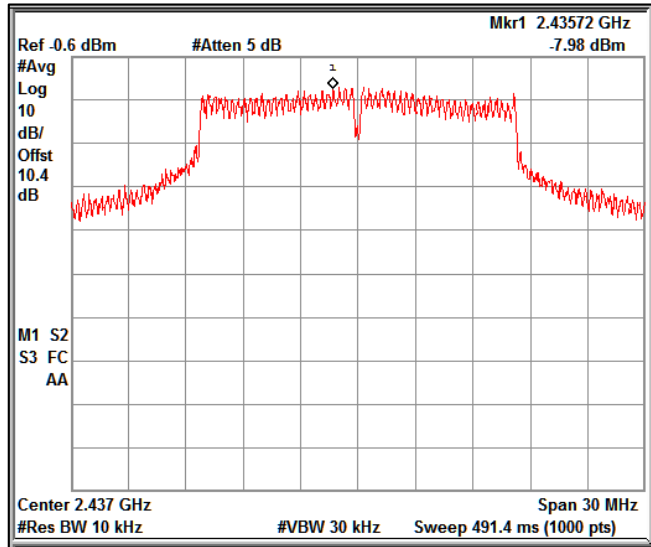

Data Rate: 6Mbps Channel Frequency: 2437MHz

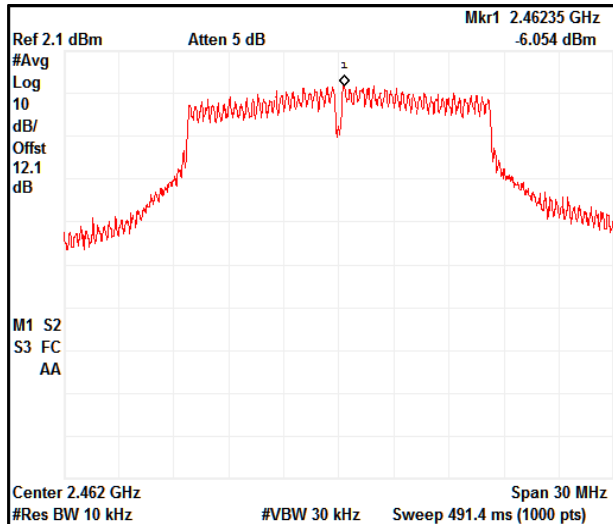

Data Rate: 6Mbps Channel Frequency: 2462MHz

Chain 2:

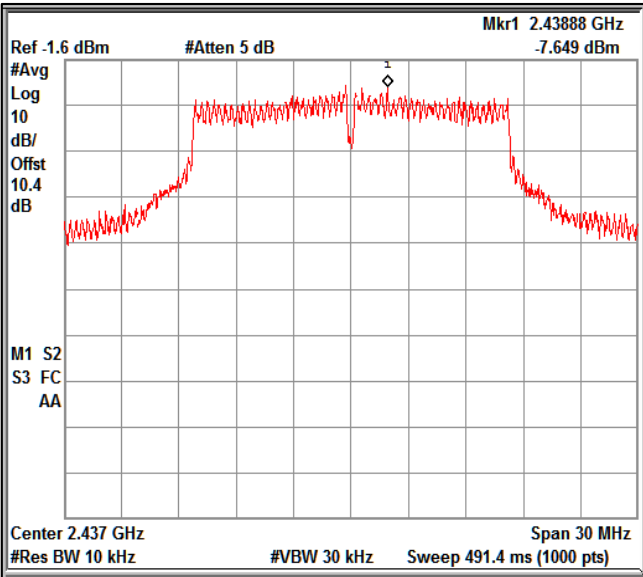
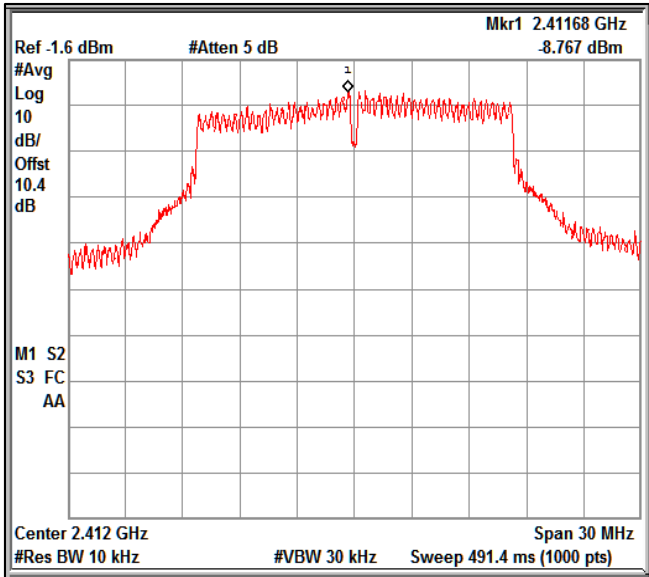

Data Rate: 6Mbps

Channel Frequency: 2412MHz

Data Rate: 6Mbps

Channel Frequency: 2437MHz

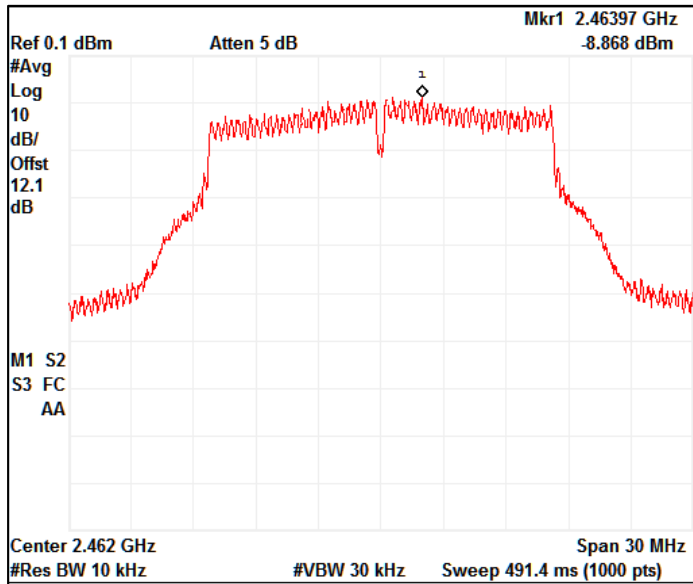

Data Rate: 6Mbps

Channel Frequency: 2462MHz

Modulation: 802.11n_HT20

Data rate (Mbps)	Channel Frequency (MHz)	PSD (dBm/kHz) Chain1	PSD (dBm/kHz) Chain2	U.FL Cable loss	PSD (dBm/kHz) Chain1	PSD (dBm/kHz) Chain2	Duty cycle correction factor (dB)	Total PSD (dBm/kHz)	PSD Limit (dBm/kHz)
MCS0	2412	-8.76	-7.73	1.70	-7.06	-6.03	0.45	-3.05	8.00
	2437	-8.35	-8.39	1.70	-6.65	-6.69	0.45	-3.21	8.00
	2462	-9.23	-8.94	1.70	-7.53	-7.24	0.45	-3.92	8.00
MCS7	2412	-12.60	-10.86	1.70	-10.90	-9.16	2.72	-4.21	8.00
	2437	-12.08	-11.77	1.70	-10.38	-10.07	2.72	-4.49	8.00
	2462	-12.74	-12.16	1.70	-11.04	-10.46	2.72	-5.01	8.00

*Note: Duty Cycle Correction Factor Calculation

$10 \cdot \text{LOG} (1/X)$ Where X is Duty Cycle is considered in below results

Duty cycle correction Factor is considered in Final Average PSD

A cable loss Correction factor of **1.70dB** was added to the measured value Chain 1 and Chain 2 results

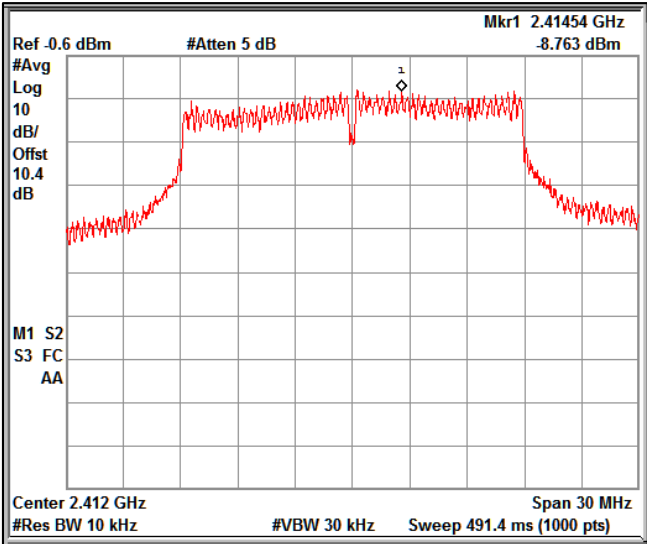
Chain 1:

Data Rate: MCS0

Channel Frequency: 2412MHz

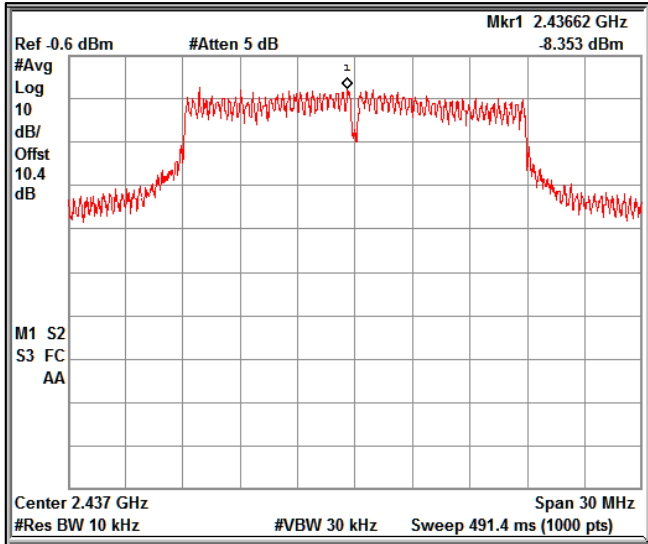

Data Rate: MCS0

Channel Frequency: 2437MHz

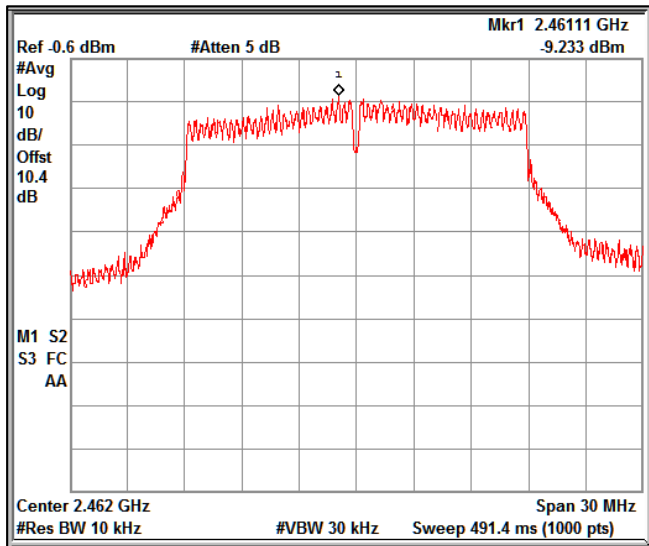

Data Rate: MCS0

Channel Frequency: 2462MHz

Chain 2:

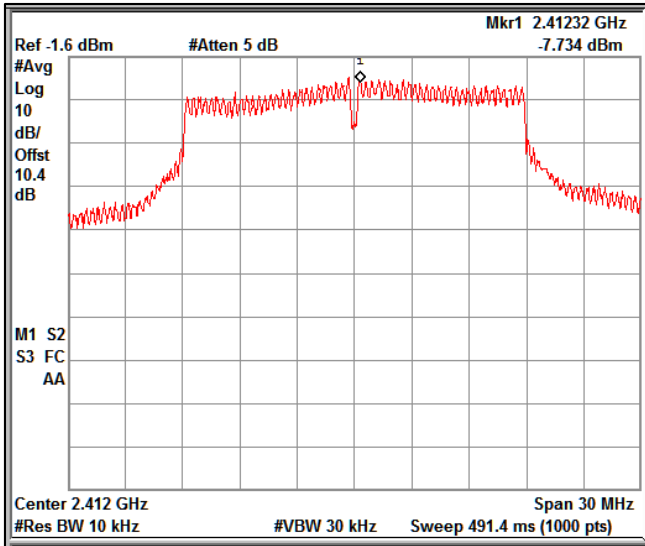

Data Rate: MCS0 Channel Frequency: 2412MHz

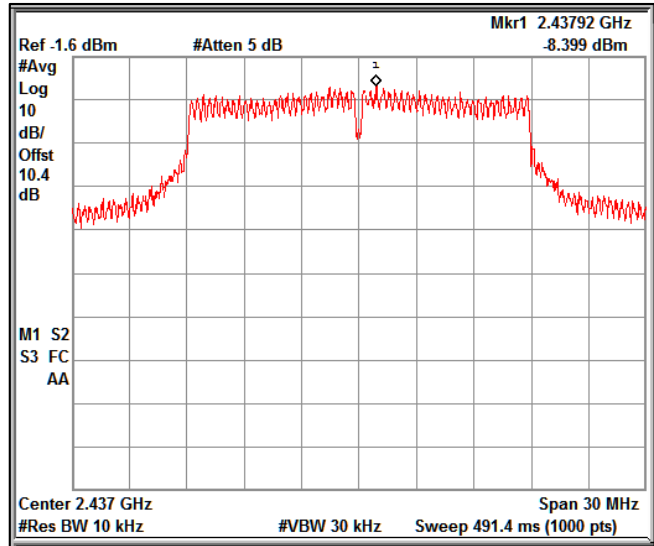

Data Rate: MCS0 Channel Frequency: 2437MHz

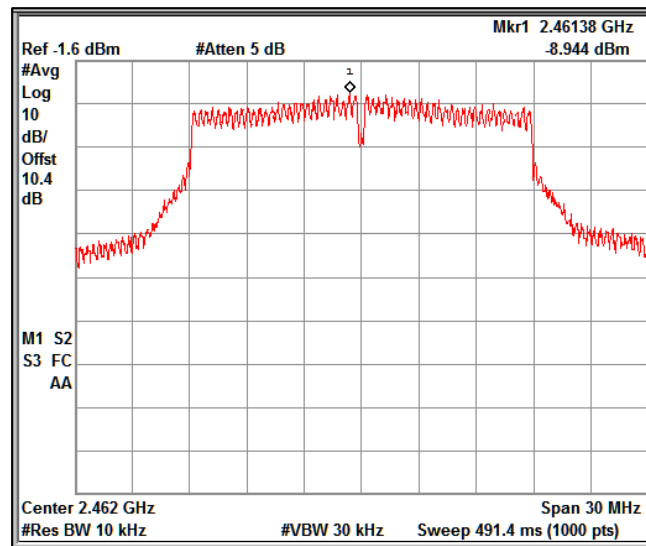

Data Rate: MCS0 Channel Frequency: 2462MHz

Prüfbericht - Nr.:
Test Report No.:

IN2391GP 001

Seite 64 von 229
Page 64 of 229

Modulation: 802.11ac_VHT20

Data rate (Mbps)	Channel Frequency (MHz)	PSD (dBm/kHz) Chain1	PSD (dBm/kHz) Chain2	U.FL Cable loss	PSD (dBm/kHz) Chain1	PSD (dBm/kHz) Chain2	Duty cycle correction factor (dB)	Total PSD (dBm/kHz)	PSD Limit (dBm/kHz)
MCS0	2412	-9.60	-8.49	1.70	-7.90	-6.79	0.45	-3.85	8.00
	2437	-8.31	-7.92	1.70	-6.61	-6.22	0.45	-2.95	8.00
	2462	-10.11	-9.37	1.70	-8.41	-7.67	0.45	-4.56	8.00
MCS8	2412	-14.06	-12.91	1.70	-12.36	-11.21	2.92	-5.81	8.00
	2437	-12.93	-12.81	1.70	-11.23	-11.11	2.92	-5.23	8.00
	2462	-13.37	-12.33	1.70	-11.67	-10.63	2.92	-5.18	8.00

*Note: Duty Cycle Correction Factor Calculation

10*LOG (1/X) Where X is Duty Cycle is considered in below results

Duty cycle correction Factor is considered in Final Average PSD

A cable loss Correction factor of **1.70dB** was added to the measured value Chain 1 and Chain 2 results.

Chain 1:

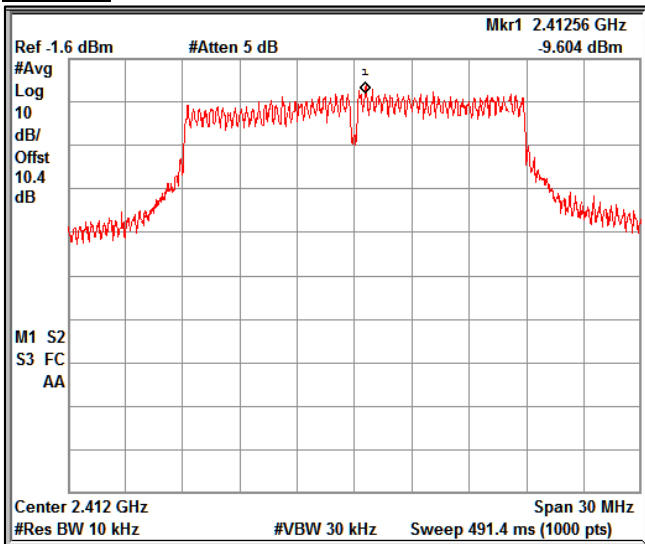

Data Rate: MCS0 Channel Frequency: 2412MHz

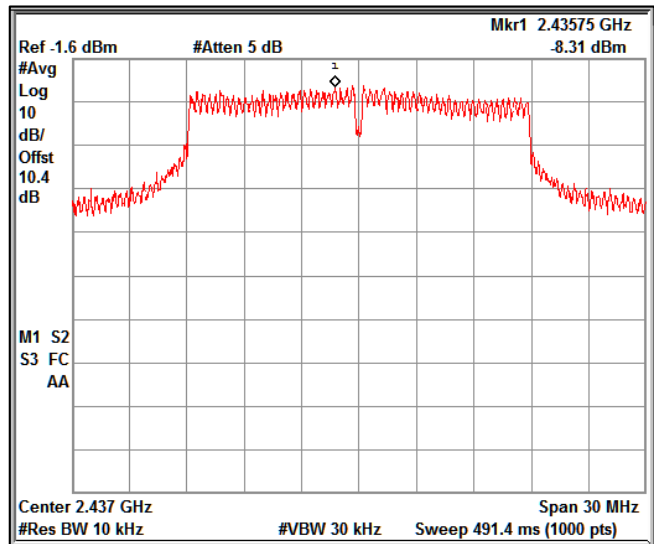

Data Rate: MCS0 Channel Frequency: 2437MHz

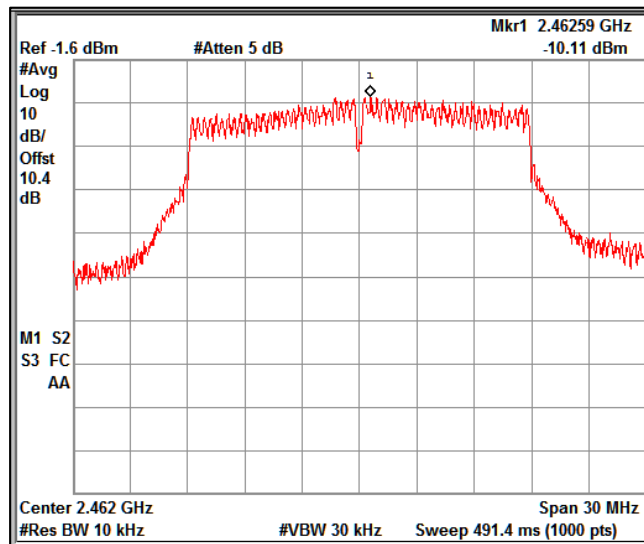

Data Rate: MCS0 Channel Frequency: 2462MHz

Chain 2:

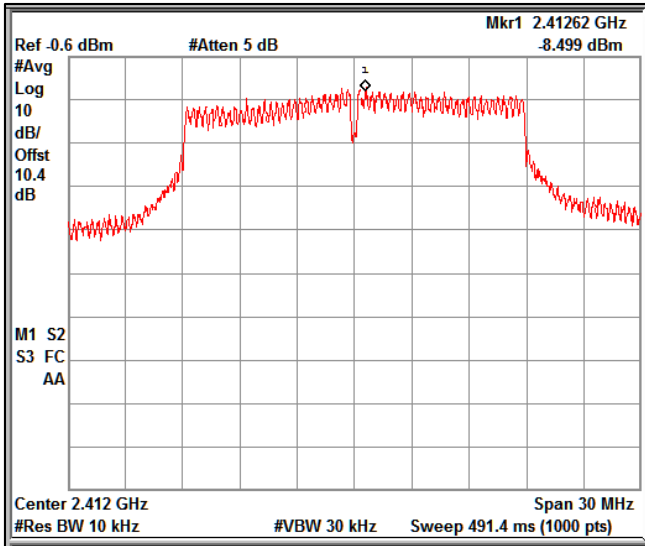

Data Rate: MCS0 Channel Frequency: 2412MHz

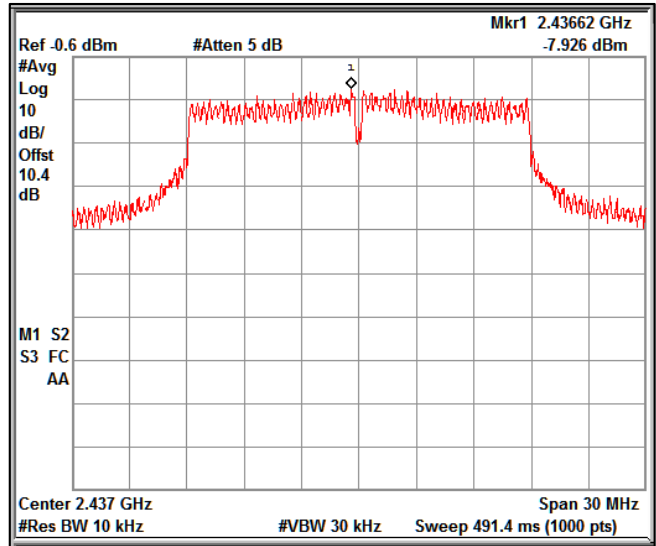

Data Rate: MCS0 Channel Frequency: 2437MHz

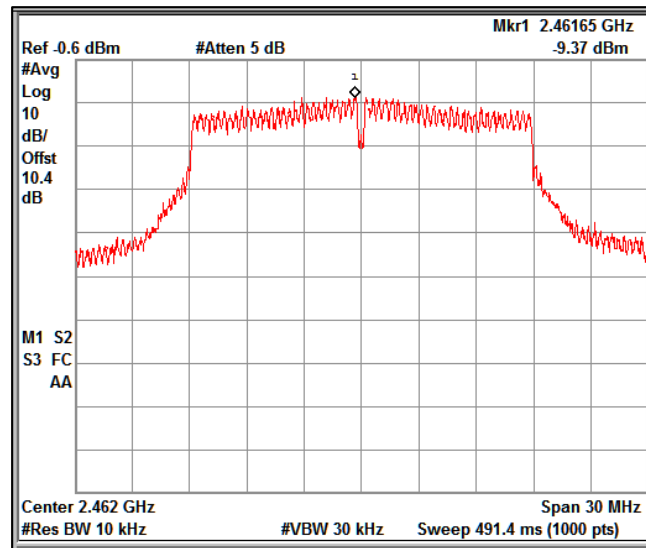

Data Rate: MCS0 Channel Frequency: 2462MHz

Prüfbericht - Nr.:
Test Report No.:

IN2391GP 001

Seite 66 von 229
Page 66 of 229

Modulation: 802.11ax_HE20

Data rate (Mbps)	Channel Frequency (MHz)	PSD (dBm/kHz) Chain1	PSD (dBm/kHz) Chain2	U.FL Cable loss	PSD (dBm/kHz) Chain1	PSD (dBm/kHz) Chain2	Duty cycle correction factor (dB)	Total PSD (dBm/kHz)	PSD Limit (dBm/kHz)
MCS0	2412	-11.02	-9.45	1.70	-9.32	-7.75	0.57	-4.88	8.00
	2437	-8.92	-9.33	1.70	-7.22	-7.63	0.57	-3.83	8.00
	2462	-11.36	-11.09	1.70	-9.66	-9.39	0.57	-5.94	8.00
MCS11	2412	-15.58	-13.70	1.70	-13.88	-12.00	3.47	-6.36	8.00
	2437	-14.73	-14.45	1.70	-13.03	-12.75	3.47	-6.41	8.00
	2462	-14.83	-14.02	1.70	-13.13	-12.32	3.47	-6.22	8.00

*Note: Duty Cycle Correction Factor Calculation

10*LOG (1/X) Where X is Duty Cycle is considered in below results

Duty cycle correction Factor is considered in Final Average PSD

A cable loss Correction factor of **1.70dB** was added to the measured value Chain 1 and Chain 2 results.

Chain 1:

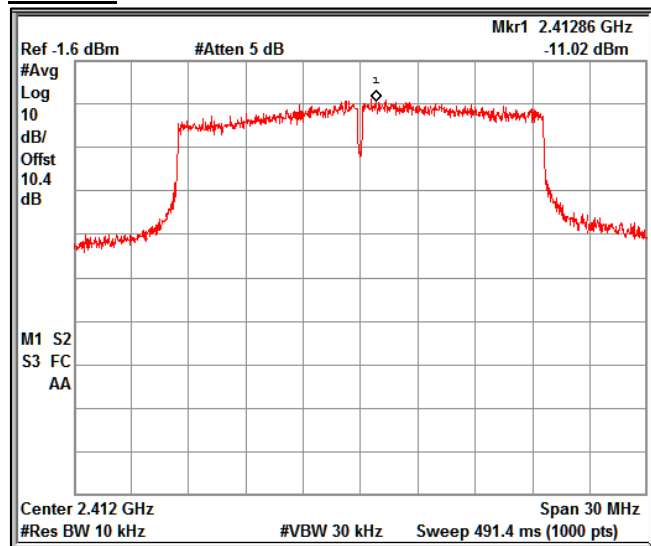

Data Rate: MCS0 Channel Frequency: 2412MHz

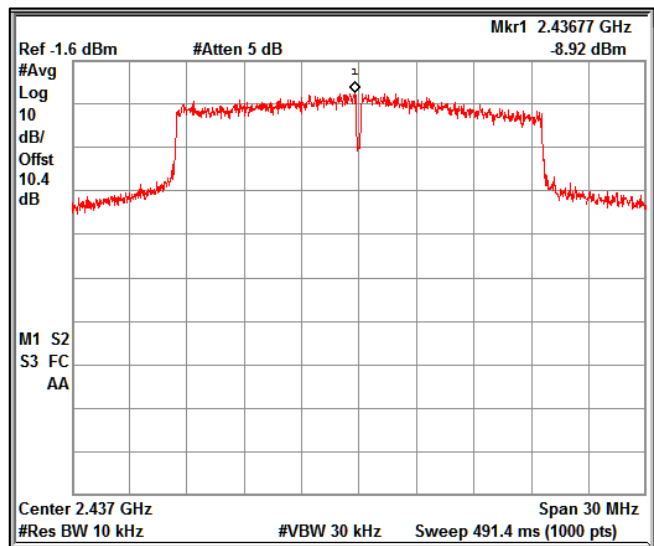

Data Rate: MCS0 Channel Frequency: 2437MHz

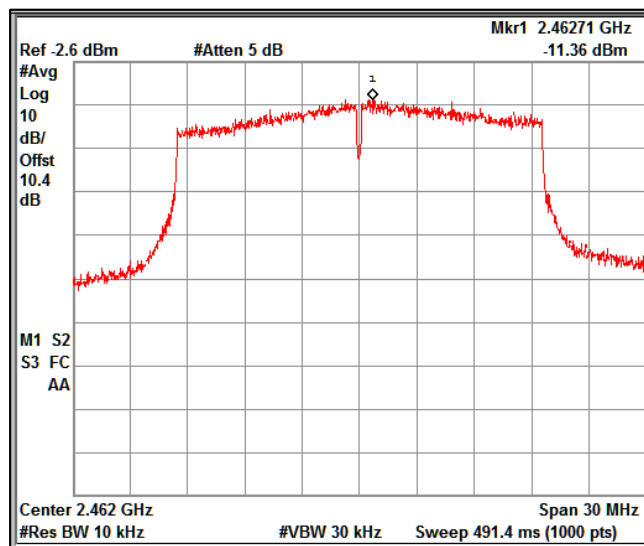

Data Rate: MCS0 Channel Frequency: 2462MHz

Chain 2:

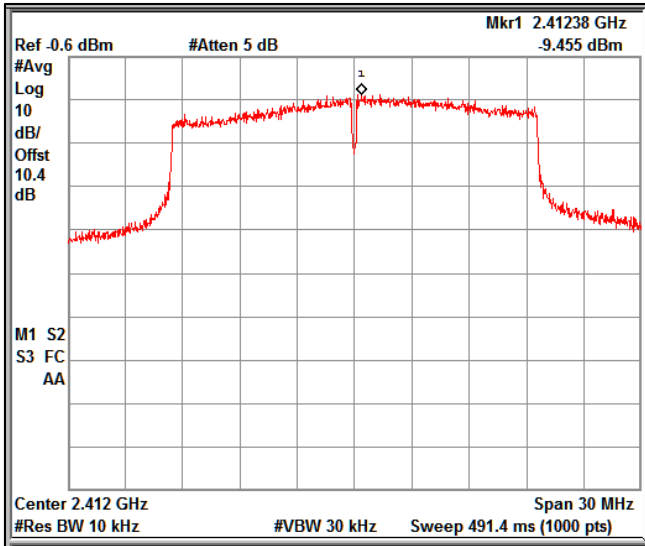

Data Rate: MCS0 Channel Frequency: 2412MHz

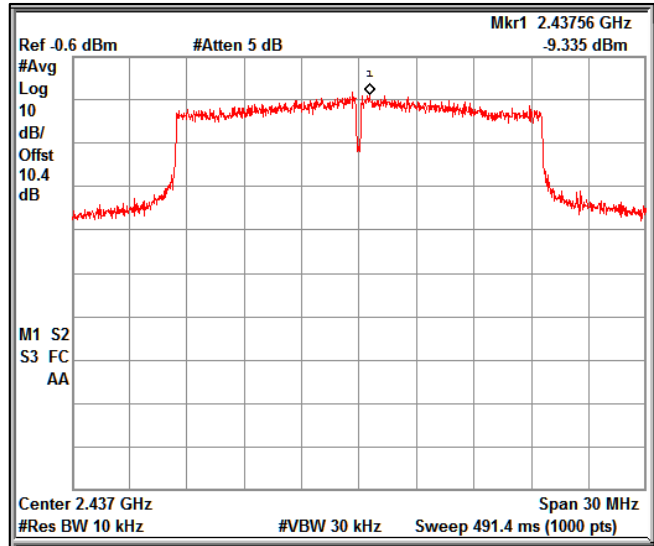

Data Rate: MCS0 Channel Frequency: 2437MHz

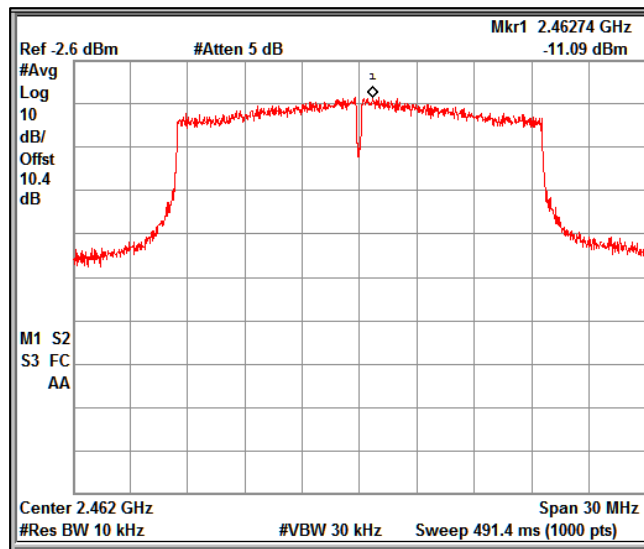

Data Rate: MCS0 Channel Frequency: 2462MHz

Modulation: 802.11n_HT40

Data rate (Mbps)	Channel Frequency (MHz)	PSD (dBm/kHz) Chain1	PSD (dBm/kHz) Chain2	U.FL Cable loss	PSD (dBm/kHz) Chain1	PSD (dBm/kHz) Chain2	Duty cycle correction factor (dB)	Total PSD (dBm/kHz)	PSD Limit (dBm/kHz)
MCS0	2422	-6.64	-5.68	1.70	-6.64	-5.68	0.46	-2.67	8.00
	2437	-3.05	-2.60	1.70	-0.55	-0.10	0.46	3.14	8.00
	2452	-7.40	-6.58	1.70	-7.40	-6.58	0.46	-3.51	8.00
MCS7	2422	-10.38	-8.48	1.70	-10.38	-8.48	2.72	-3.60	8.00
	2437	-5.98	-5.72	1.70	-5.98	-5.72	2.72	-0.12	8.00
	2452	-6.64	-5.68	1.70	-6.64	-5.68	0.46	-2.67	8.00

*Note: Duty Cycle Correction Factor Calculation

$10 * \text{LOG} (1/X)$ Where X is Duty Cycle is considered in below results

Duty cycle correction Factor is considered in Final Average PSD

A cable loss Correction factor of **1.70dB** was added to the measured value Chain 1 and Chain 2 results.

Chain 1:

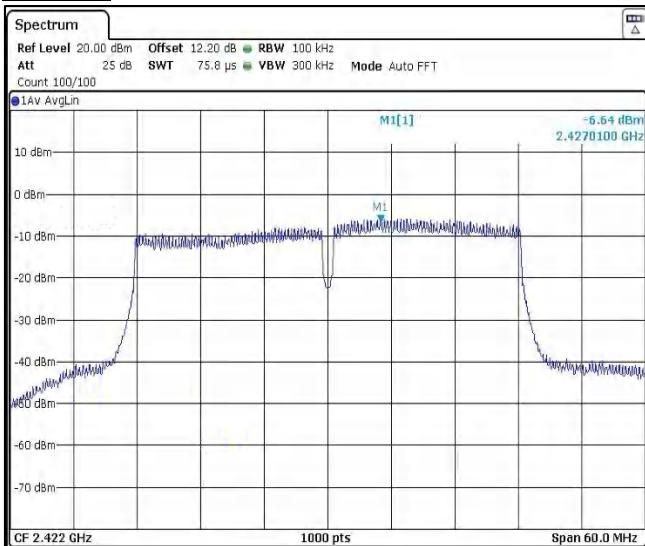

Data Rate: MCS0

Channel Frequency: 2422MHz

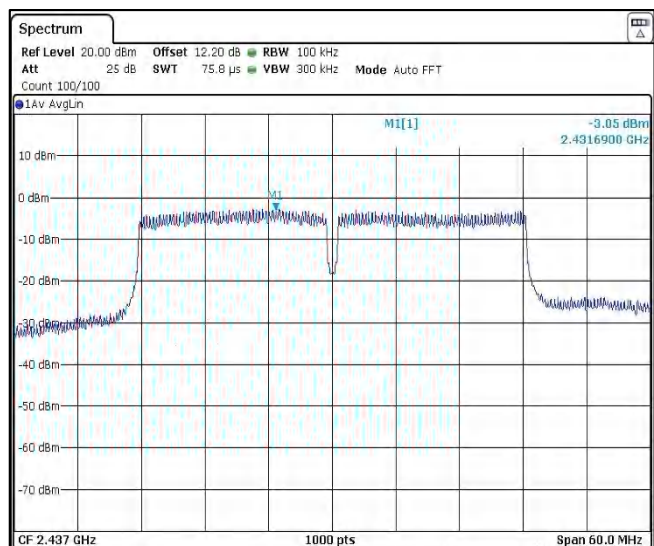

Data Rate: MCS0

Channel Frequency: 2437MHz

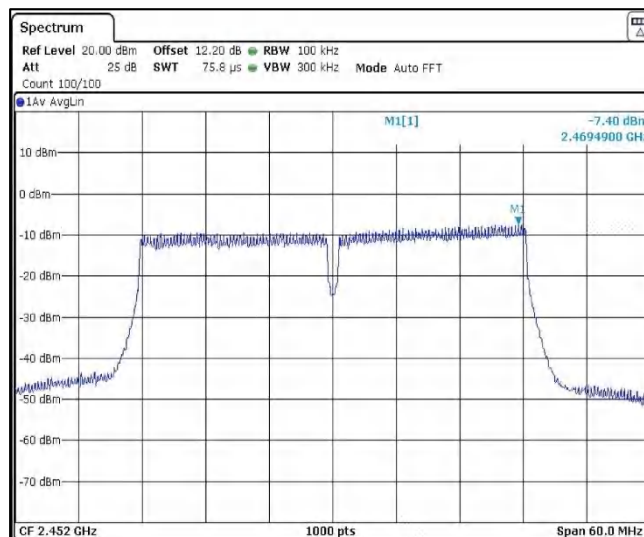

Data Rate: MCS0

Channel Frequency: 2452MHz

Chain 2:

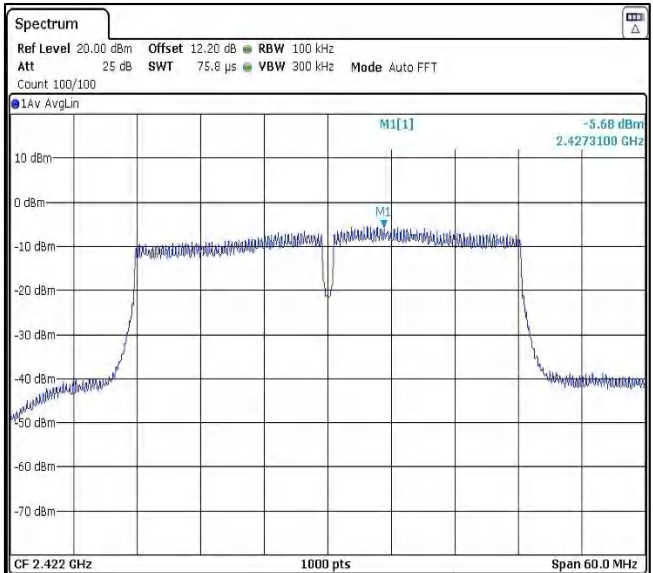

Data Rate: MCS0 Channel Frequency: 2422MHz

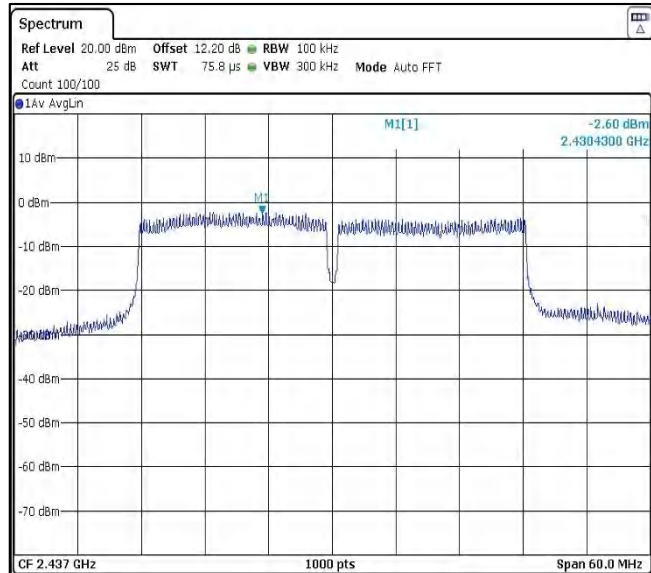

Data Rate: MCS0 Channel Frequency: 2437MHz

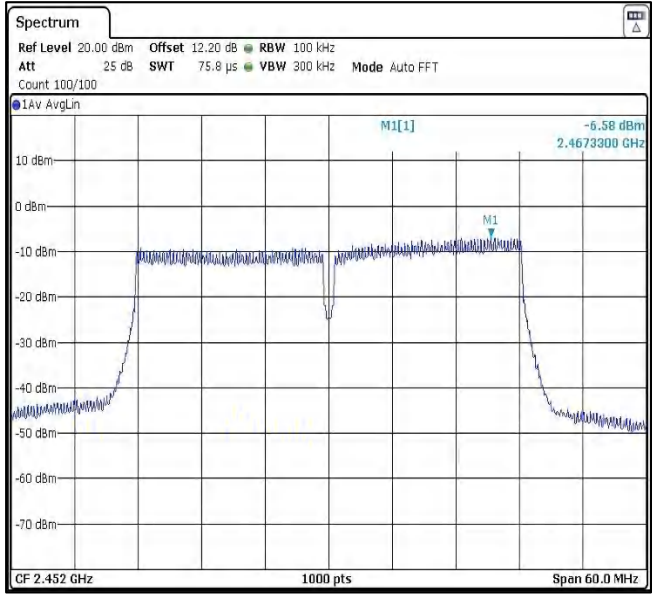

Data Rate: MCS0 Channel Frequency: 2452MHz

Prüfbericht - Nr.:
Test Report No.:

IN2391GP 001

Seite 70 von 229
Page 70 of 229

Modulation: 802.11ac_VHT40

Data rate (Mbps)	Channel Frequency (MHz)	PSD (dBm/kHz) Chain1	PSD (dBm/kHz) Chain2	U.FL Cable loss	PSD (dBm/kHz) Chain1	PSD (dBm/kHz) Chain2	Duty cycle correction factor (dB)	Total PSD (dBm/kHz)	PSD Limit (dBm/kHz)
MCS0	2422	-6.07	-4.84	1.70	-6.07	-4.84	0.45	-1.95	8.00
	2437	-4.32	-3.18	1.70	-4.32	-3.18	0.45	-0.25	8.00
	2452	-8.05	-8.17	1.70	-8.05	-8.17	0.45	-4.65	8.00
MCS8	2422	-7.90	-7.69	1.70	-7.90	-7.69	2.92	-1.86	8.00
	2437	-5.76	-5.98	1.70	-5.76	-5.98	2.92	0.07	8.00
	2452	-11.44	-11.32	1.70	-11.44	-11.32	2.92	-5.44	8.00

*Note: Duty Cycle Correction Factor Calculation

10*LOG (1/X) Where X is Duty Cycle is considered in below results

Duty cycle correction Factor is considered in Final Average PSD

A cable loss Correction factor of **1.70dB** was added to the measured value Chain 1 and Chain 2 results.

Chain 1:

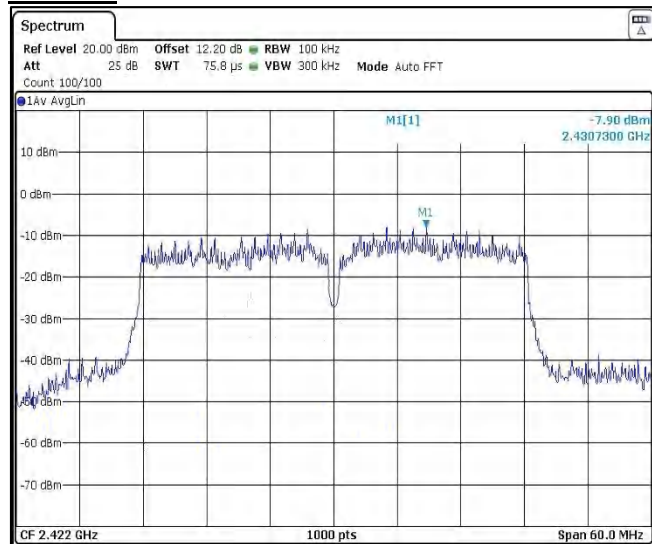

Data Rate: MCS0 Channel Frequency: 2422MHz

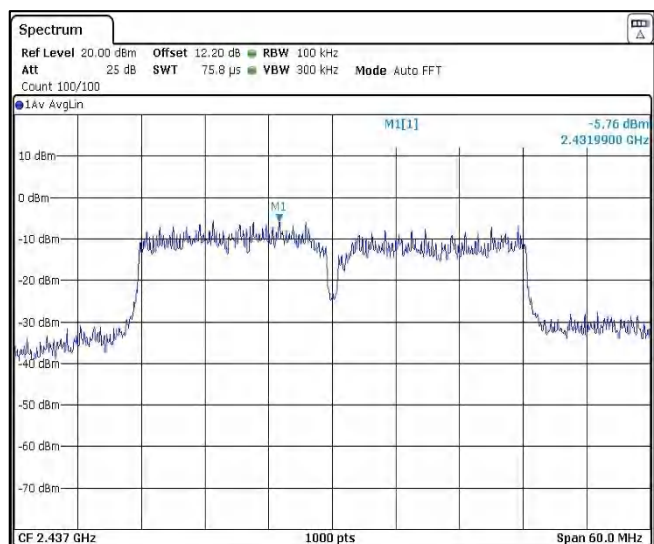

Data Rate: MCS0 Channel Frequency: 2437MHz

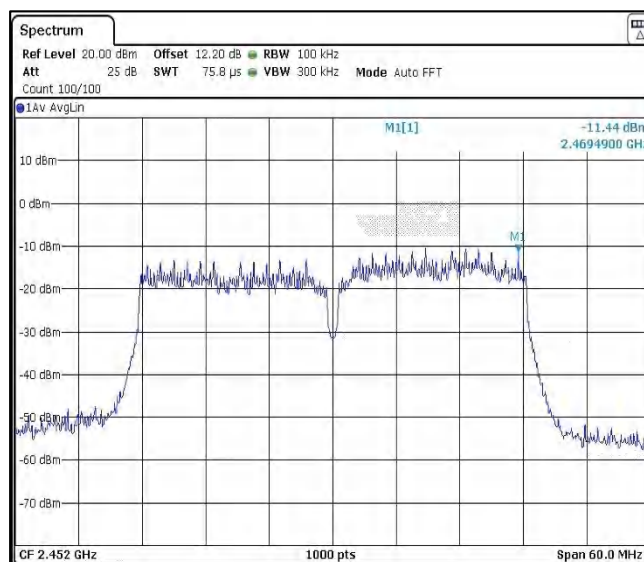

Data Rate: MCS0 Channel Frequency: 2452MHz

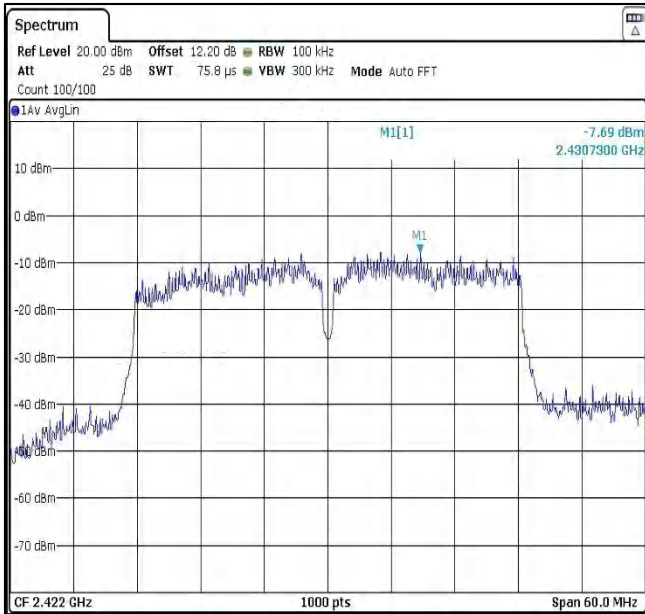
Chain 2:

Data Rate: MCS0

Channel Frequency: 2422MHz

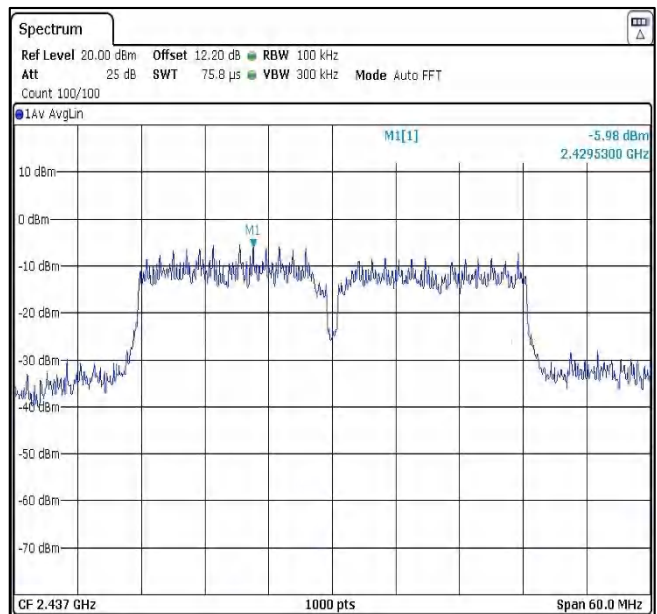

Data Rate: MCS0

Channel Frequency: 2437MHz

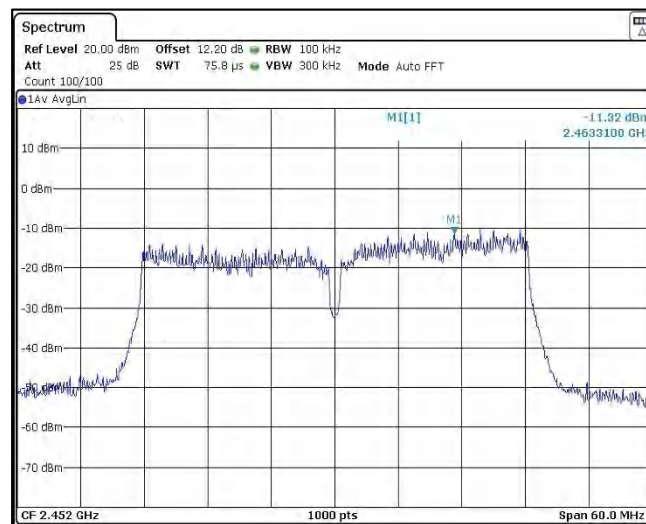

Data Rate: MCS0

Channel Frequency: 2452MHz

Prüfbericht - Nr.:
Test Report No.:

IN2391GP 001

Seite 72 von 229
Page 72 of 229

Modulation: 802.11ax_HE40

Data rate (Mbps)	Channel Frequency (MHz)	PSD (dBm/kHz) Chain1	PSD (dBm/kHz) Chain2	U.FL Cable loss	PSD (dBm/kHz) Chain1	PSD (dBm/kHz) Chain2	Duty cycle correction factor (dB)	Total PSD (dBm/kHz)	PSD Limit (dBm/kHz)
MCS0	2422	-9.47	-8.76	1.70	-9.47	-8.76	0.57	-5.52	8.00
	2437	-4.58	-4.16	1.70	-4.58	-4.16	0.57	-0.78	8.00
	2452	-11.89	-10.84	1.70	-11.89	-10.84	0.57	-7.75	8.00
MCS11	2422	-12.05	-12.96	1.70	-12.05	-12.96	3.47	-6.00	8.00
	2437	-12.13	-11.69	1.70	-12.13	-11.69	3.47	-5.42	8.00
	2452	-12.43	-11.21	1.70	-12.43	-11.21	3.47	-5.29	8.00

*Note: Duty Cycle Correction Factor Calculation

10*LOG (1/X) Where X is Duty Cycle is considered in below results

Duty cycle correction Factor is considered in Final Average PSD

A cable loss Correction factor of **1.70dB** was added to the measured value Chain 1 and Chain 2 results.

Chain 1:

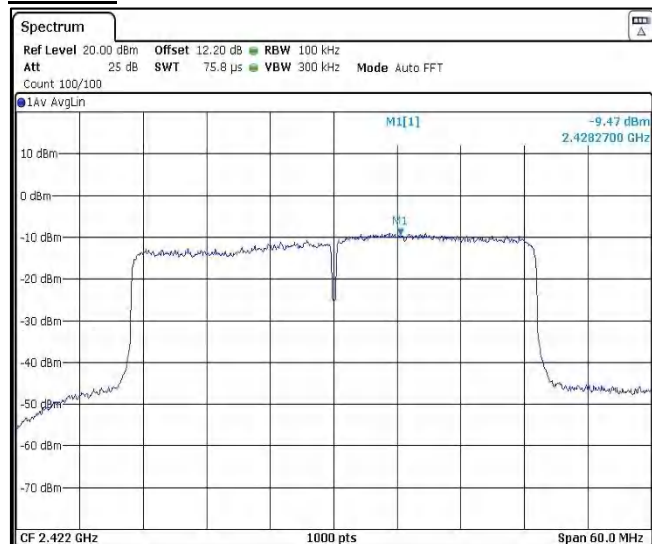

Data Rate: MCS0 Channel Frequency: 2422MHz

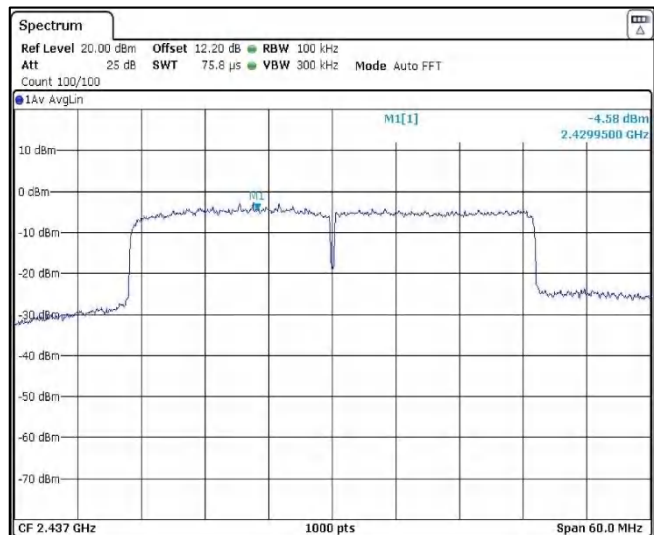

Data Rate: MCS0 Channel Frequency: 2437MHz

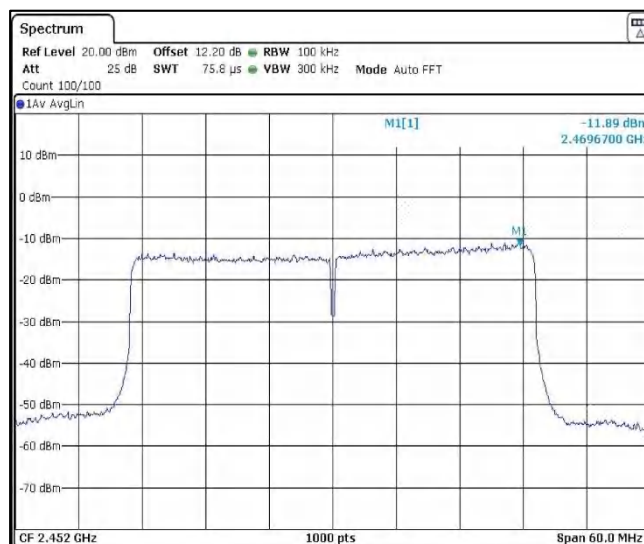

Data Rate: MCS0 Channel Frequency: 2452MHz

Chain 2:

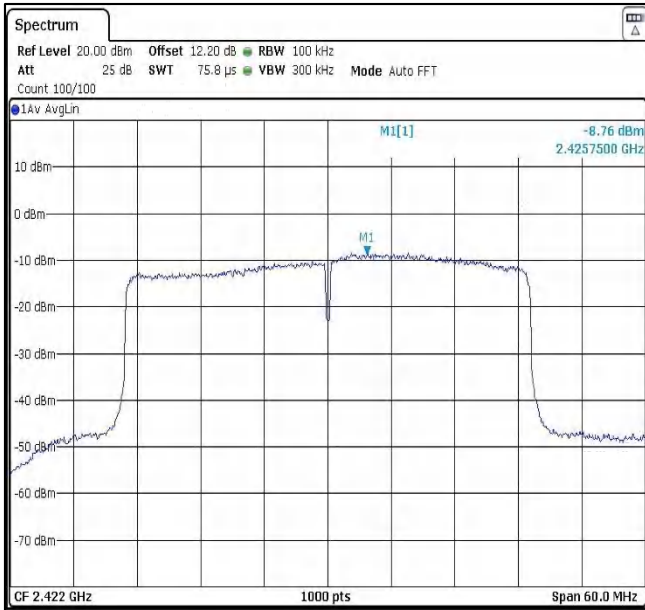

Data Rate: MCS0

Channel Frequency: 2422MHz

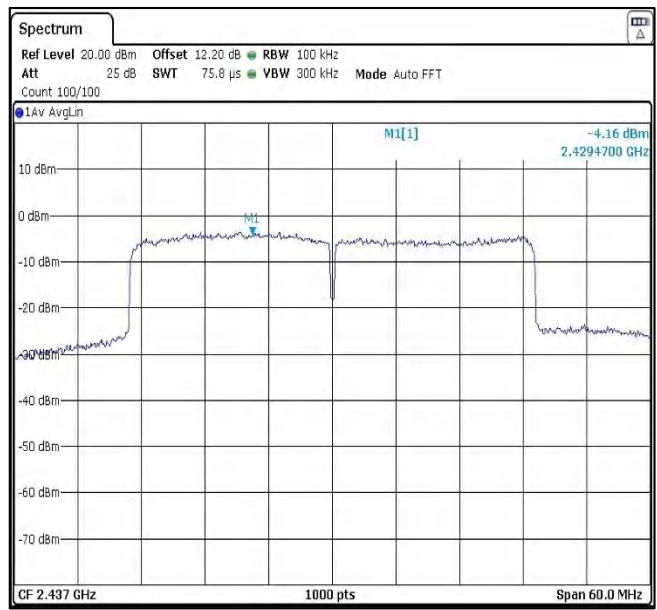

Data Rate: MCS0

Channel Frequency: 2437MHz

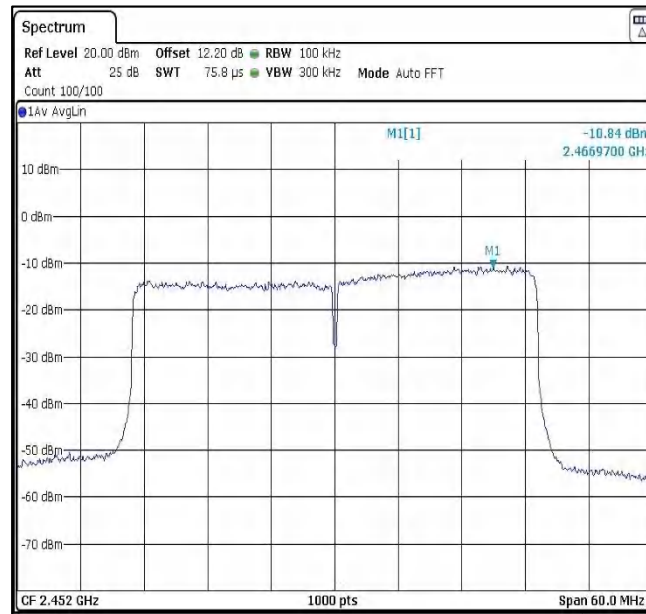

Data Rate: MCS0

Channel Frequency: 2452MHz

Prüfbericht - Nr.:
Test Report No.:

IN2391GP 001

Seite 74 von 229
Page 74 of 229

7.3 DTS Bandwidth & 99% Bandwidth

Result

Pass

Test Specification	FCC part 15 Subpart C 15.247 (a) (2) / RSS 247 Issue 2, Section 5.2 (a)
Test Method	Subclause 11.8.1 of ANSI C63.10
Measurement Bandwidth	100 kHz for x dB bandwidth 1 to 5% of OCB for 99% bandwidth
Detector	Peak
Port of testing	Antenna port
Requirement	The minimum 6 dB bandwidth shall be at least 500 kHz

Test Method:

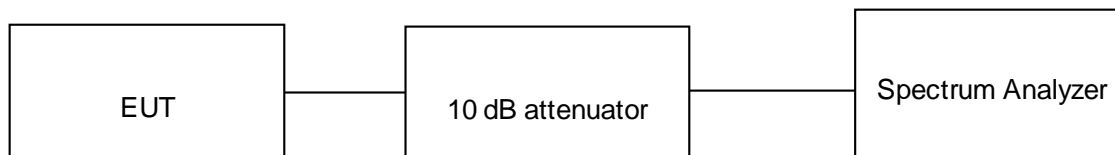

Test Condition

Normal Test Condition:

Temperature (Norm) = + 25 °C Voltage = 3.3 V DC through AC to Dc adaptor Relative humidity: 62 %

KDB Guidelines applied:

Measurements were made as per section 8.2 in KDB 558074 D01 15.247 Measurement Guidance v05r02.

Prüfbericht - Nr.:

Test Report No.:

IN2391GP 001

Seite 75 von 229

Page 75 of 229

Test results:

Note:

1. All the losses are included during measurement and final values are mentioned in the test report.
2. For 6 dB Bandwidth Measurements were made as per section 8.2 in KDB 558074 D01 15.247 Measurement Guidance v05r02.
3. For OCW 99 % Bandwidth measurements were made as per section 6.9.3 ANSI C63.10-2013 & 6.7 RSS GEN issue 5

Antenna Type: 1001932PT (PCB/Flex) MIMO Antenna Results

Note:

1. All the losses are included during measurement and final values are mentioned in the test report.
2. Total Average PSD (dBm) = Measured Average PSD (dBm) + Attenuator factor (10dB) + Cable loss (0.4dB)
3. This product do not support additional beamforming gain / directional gain, it uses signal antenna and hence directional gain of the single antenna is 2.50 dBi

Modulation: 802.11b

Data rate (Mbps)	Channel Frequency (MHz)	6 dB Bandwidth (MHz)	99% OBW (MHz)	Minimum Limit (MHz)
1Mbps	2412	7.65	11.30	0.5
	2437	7.65	11.70	0.5
	2462	7.65	11.10	0.5
11Mbps	2412	8.20	11.30	0.5
	2437	7.55	11.40	0.5
	2462	6.95	11.20	0.5

Graphs for 6 dB bandwidth measurement

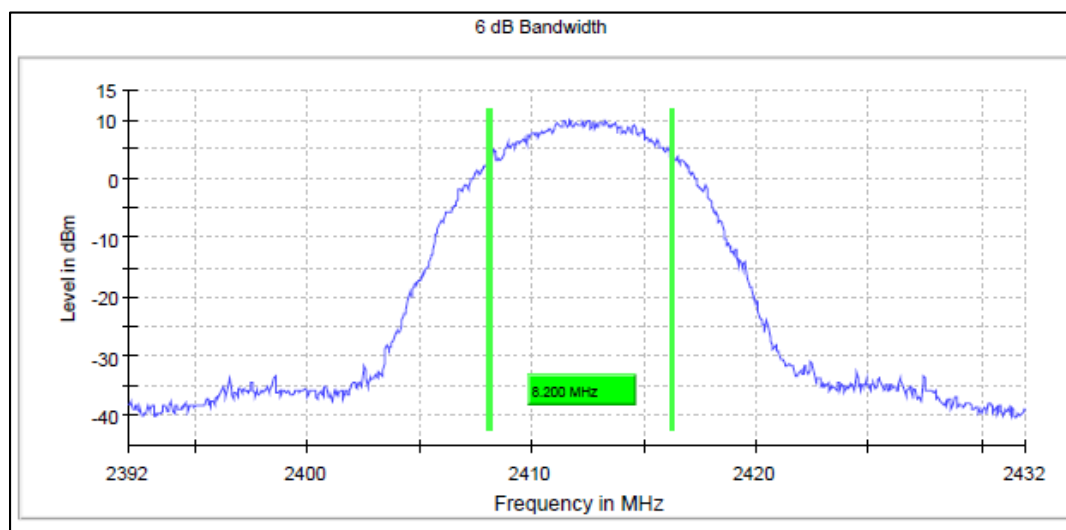

Data Rate: 11Mbps

Channel Frequency: 2412MHz

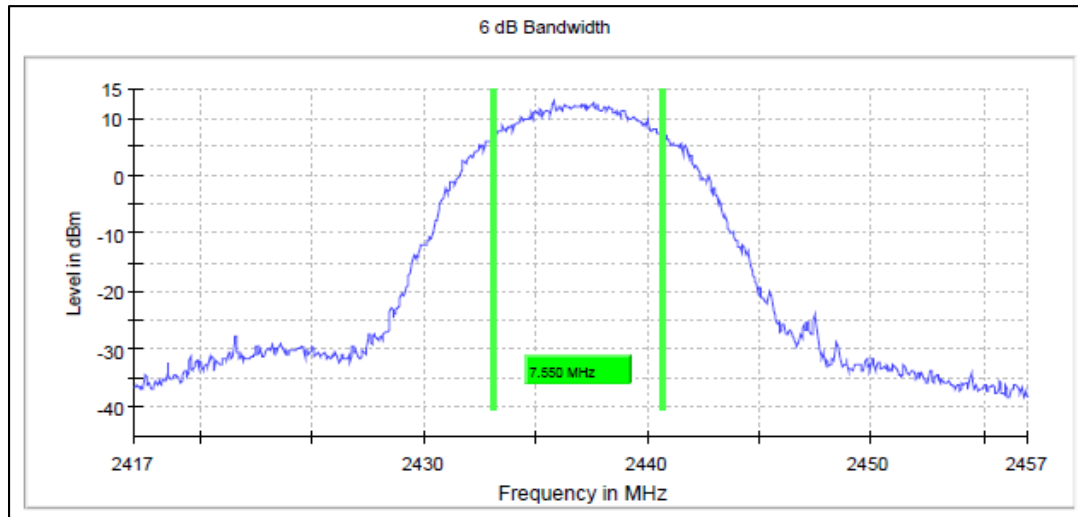

Data Rate: 11Mbps

Channel Frequency: 2437MHz

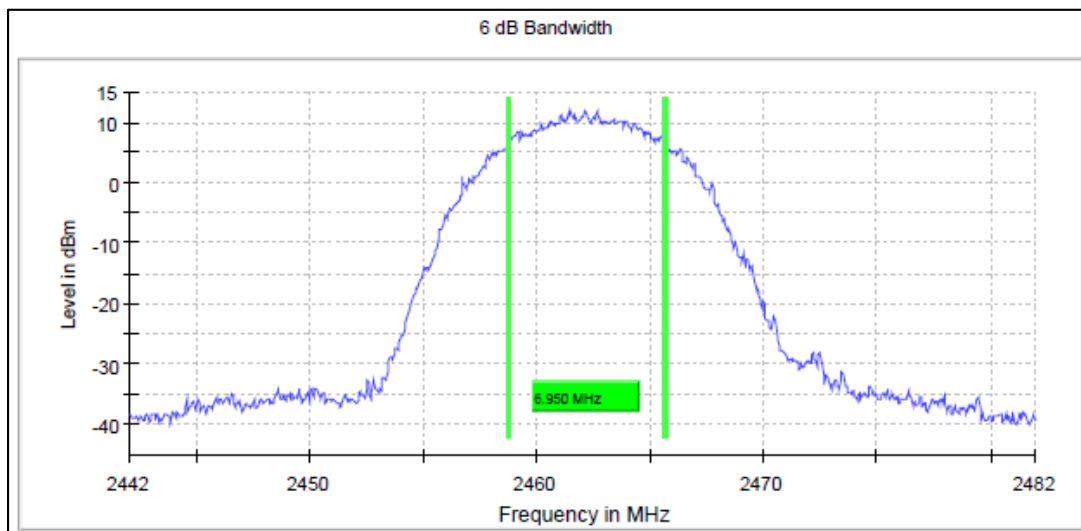

Data Rate: 11Mbps

Channel Frequency: 2462MHz

Graphs for OCW 99 % bandwidth measurement

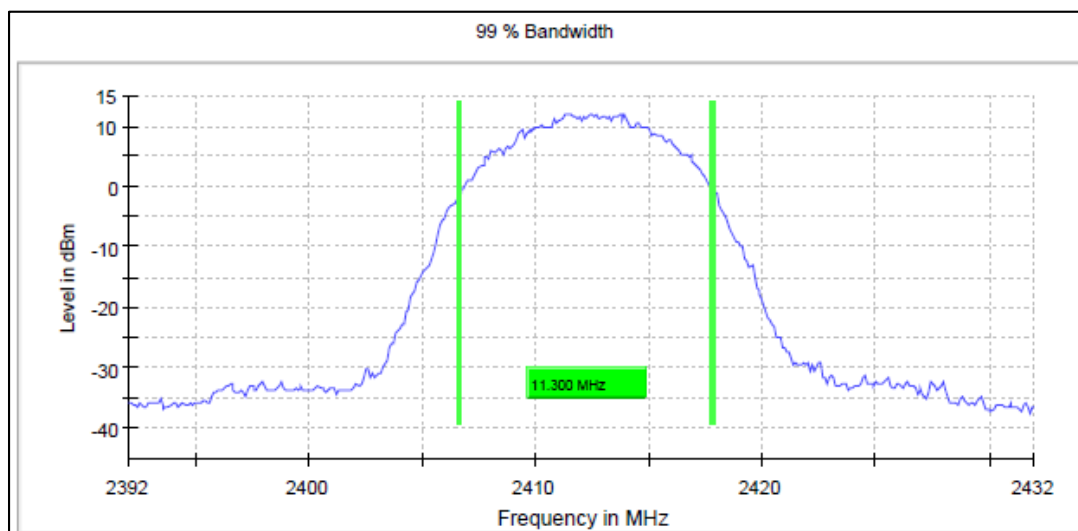

Data Rate: 11Mbps

Channel Frequency: 2412MHz

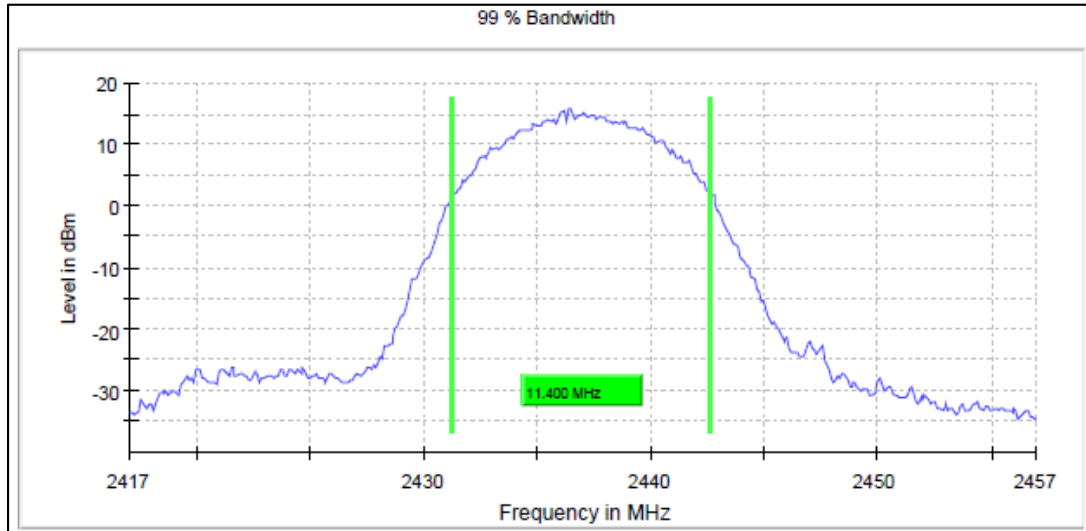

Data Rate: 11Mbps

Channel Frequency: 2437MHz

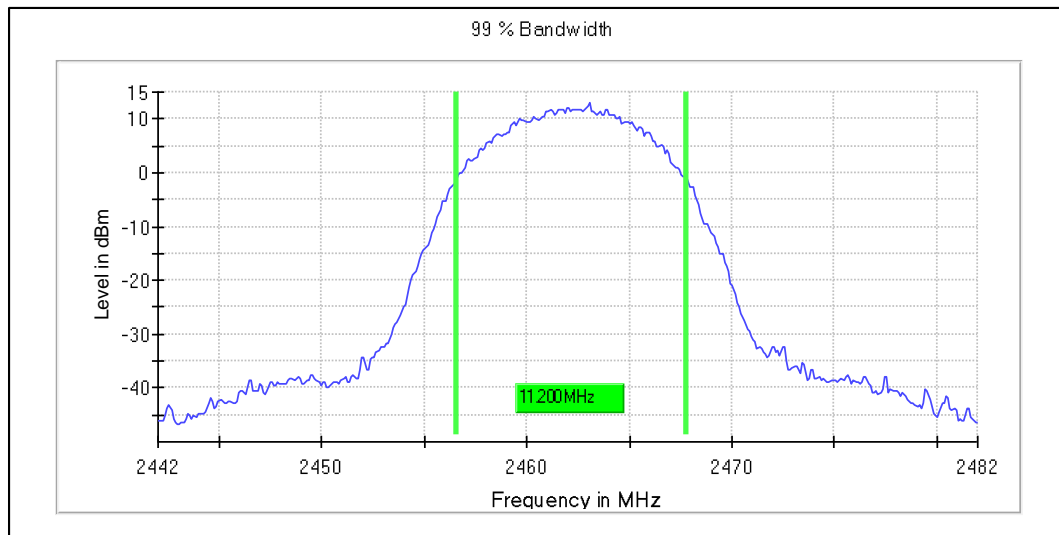

Data Rate: 11Mbps

Channel Frequency: 2462MHz

Modulation: 802.11g

Data rate (Mbps)	Channel Frequency (MHz)	6 dB Bandwidth (MHz)	99% OBW (MHz)	Minimum Limit (MHz)
6Mbps	2412	15.80	16.90	0.5
	2437	16.40	18.90	0.5
	2462	16.15	16.60	0.5
54Mbps	2412	16.50	16.90	0.5
	2437	16.55	16.70	0.5
	2462	16.55	16.70	0.5

Graphs for 6 dB bandwidth measurement

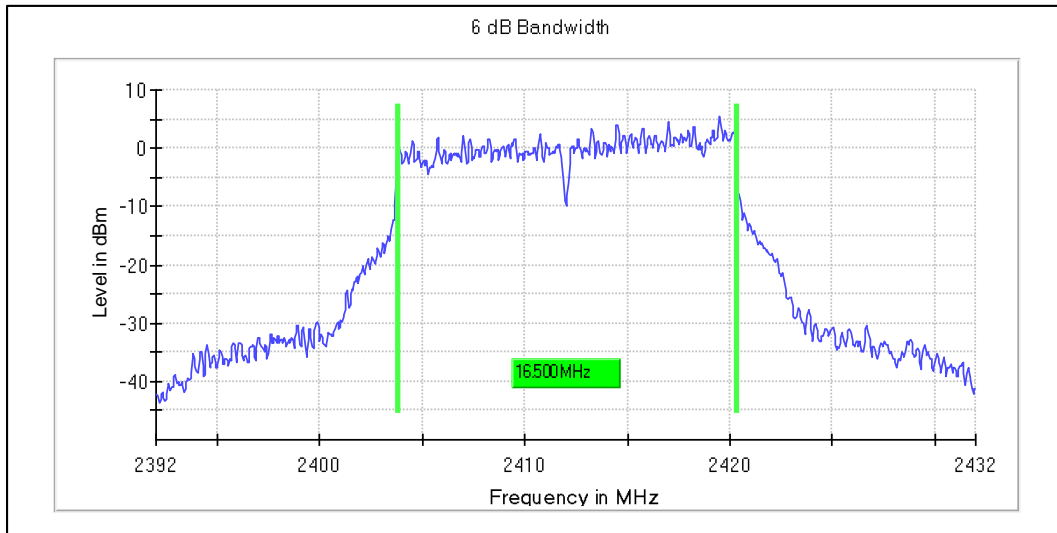

Data Rate: 54Mbps

Channel Frequency: 2412MHz

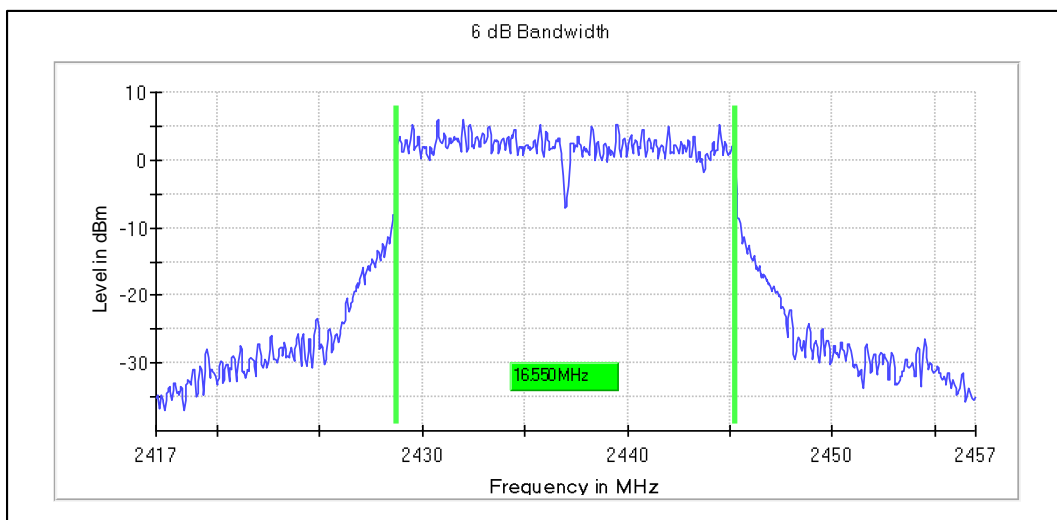

Data Rate: 54Mbps

Channel Frequency: 2437MHz

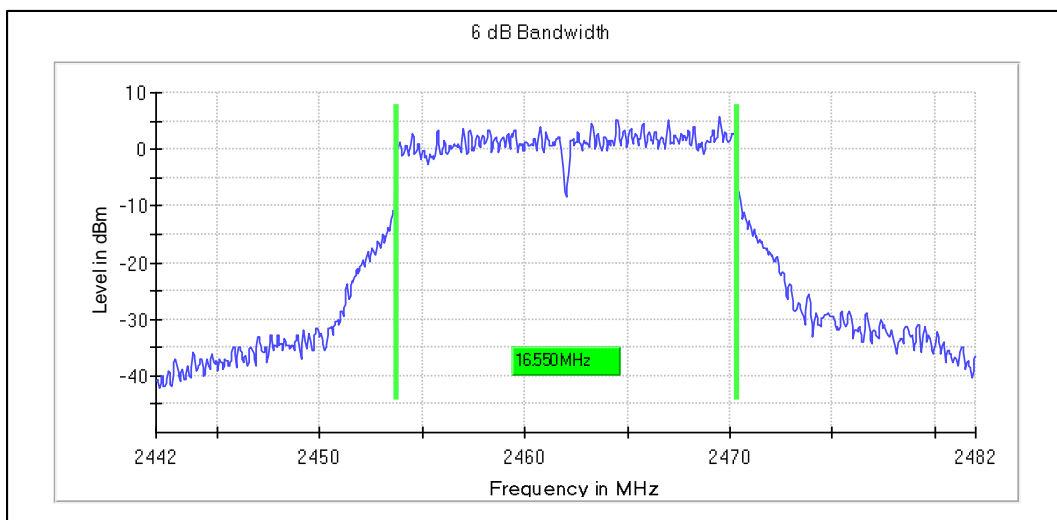

Data Rate: 54Mbps

Channel Frequency: 2462MHz

Graphs for OCW 99 % bandwidth measurement

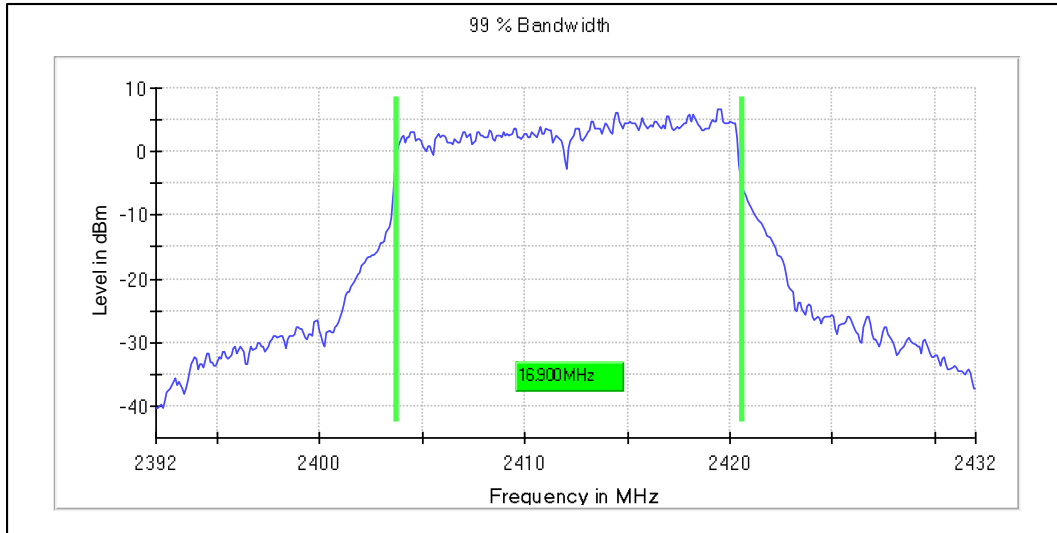

Data Rate: 54Mbps

Channel Frequency: 2412MHz

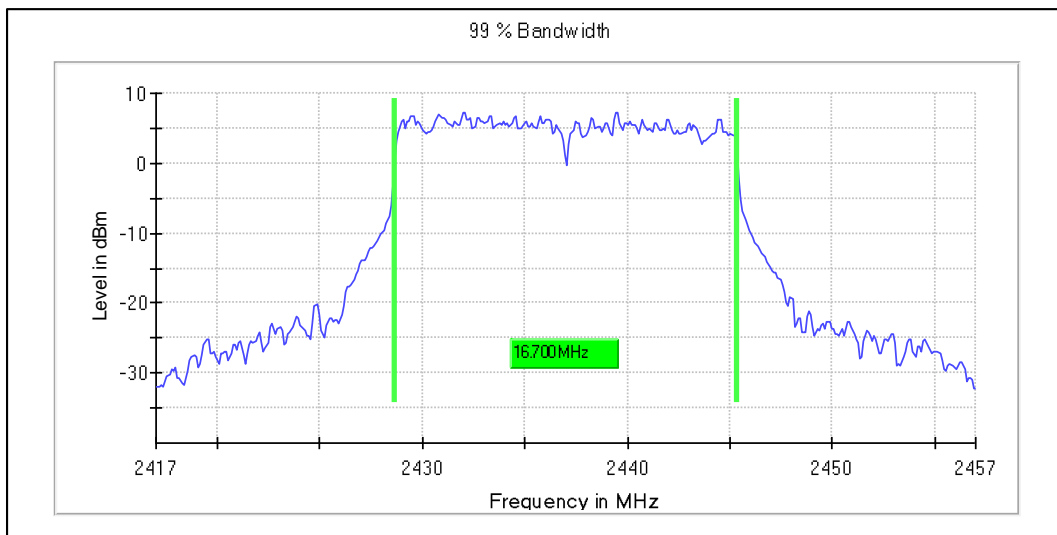

Data Rate: 54Mbps

Channel Frequency: 2437MHz

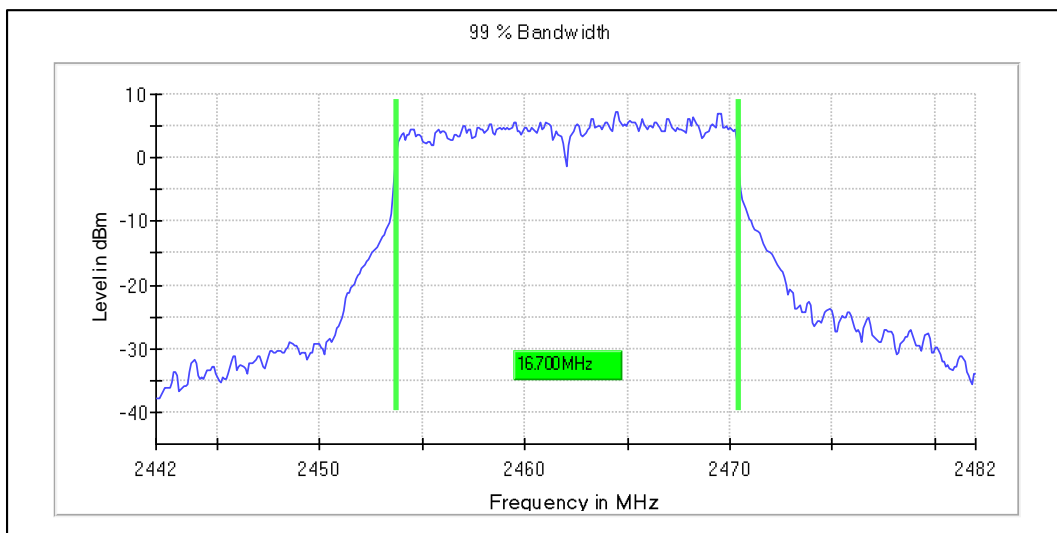

Data Rate: 54Mbps

Channel Frequency: 2462MHz

Modulation: 802.11n_HT20

Data rate (Mbps)	Channel Frequency (MHz)	6 dB Bandwidth (MHz)	99% OBW (MHz)	Minimum Limit (MHz)
MCS0	2412	16.40	18.00	0.5
	2437	17.65	19.30	0.5
	2462	16.75	17.90	0.5
MCS7	2412	17.75	18.10	0.5
	2437	17.85	17.90	0.5
	2462	17.80	17.80	0.5

Graphs for 6 dB bandwidth measurement

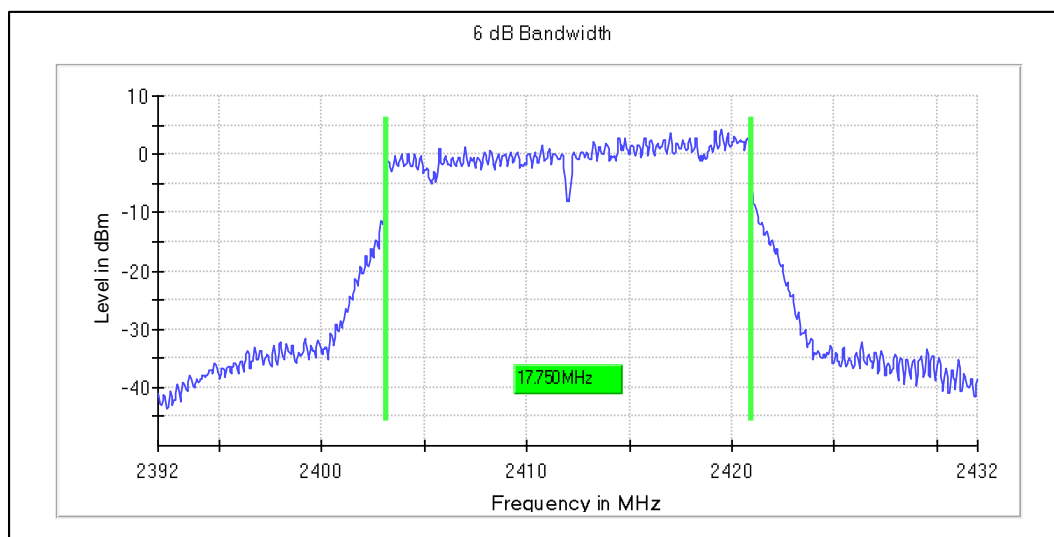

Data Rate: MCS7

Channel Frequency: 2412MHz

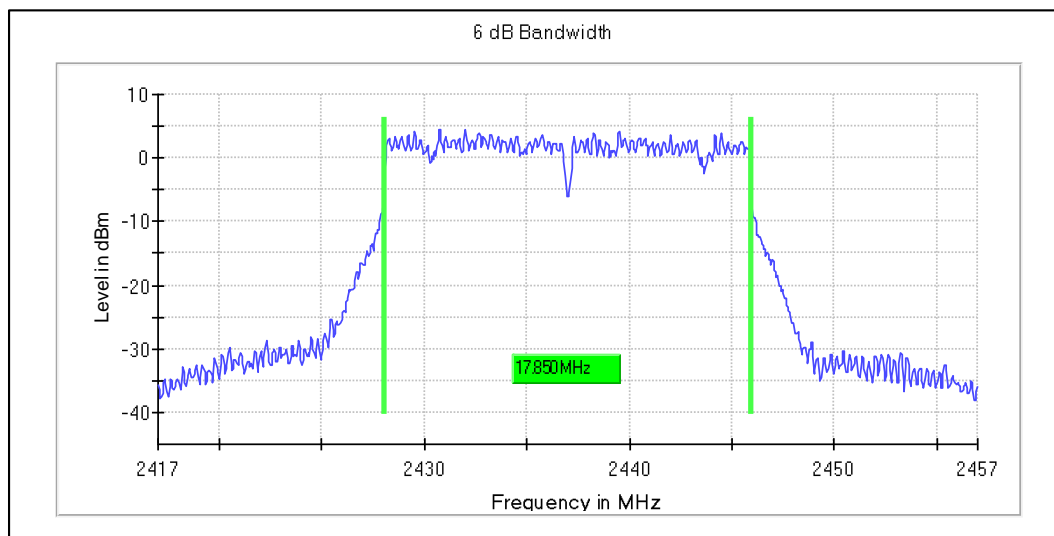

Data Rate: MCS7

Channel Frequency: 2437MHz

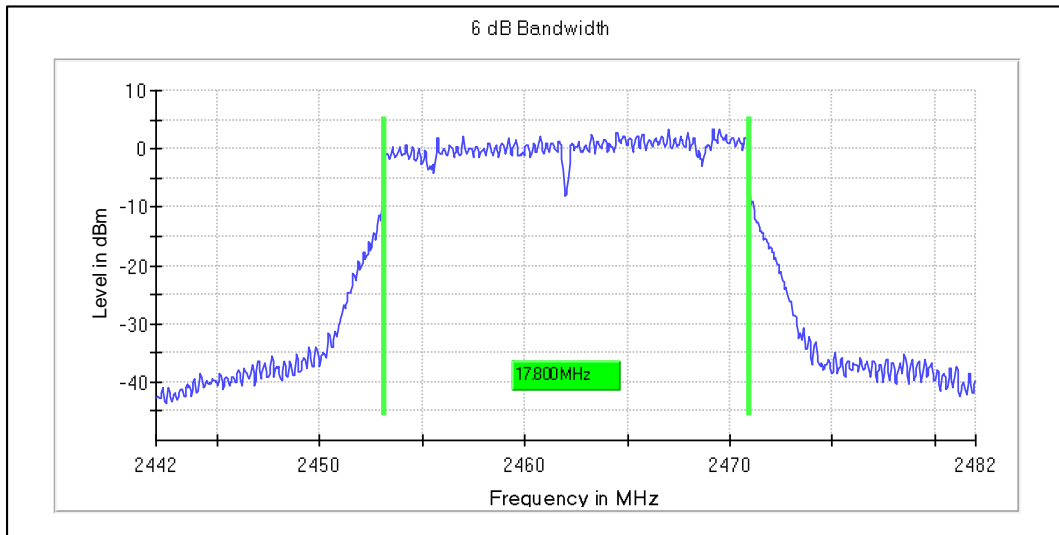

Data Rate: MCS7

Channel Frequency: 2462MHz

Graphs for OCW 99 % bandwidth measurement

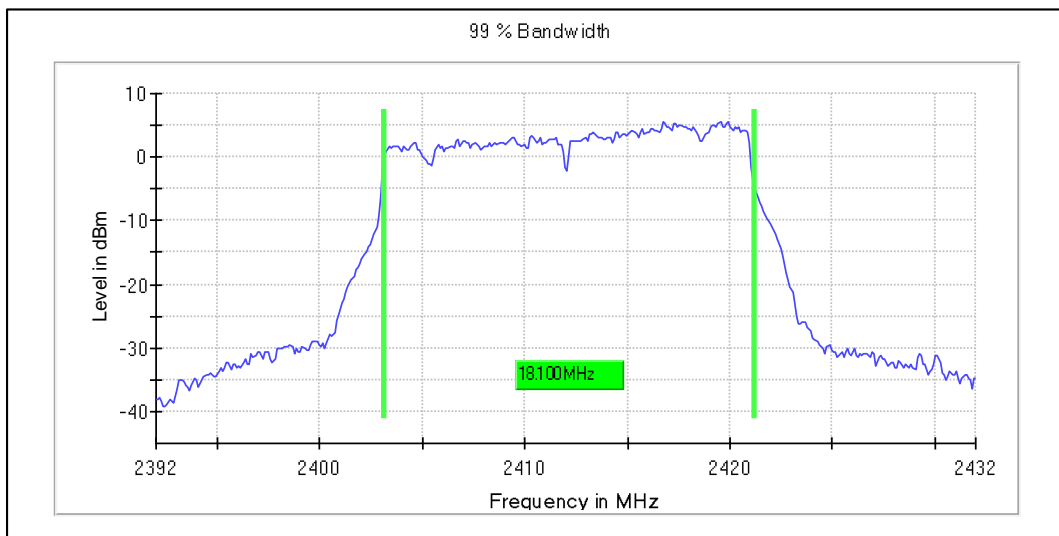

Data Rate: MCS7

Channel Frequency: 2412MHz

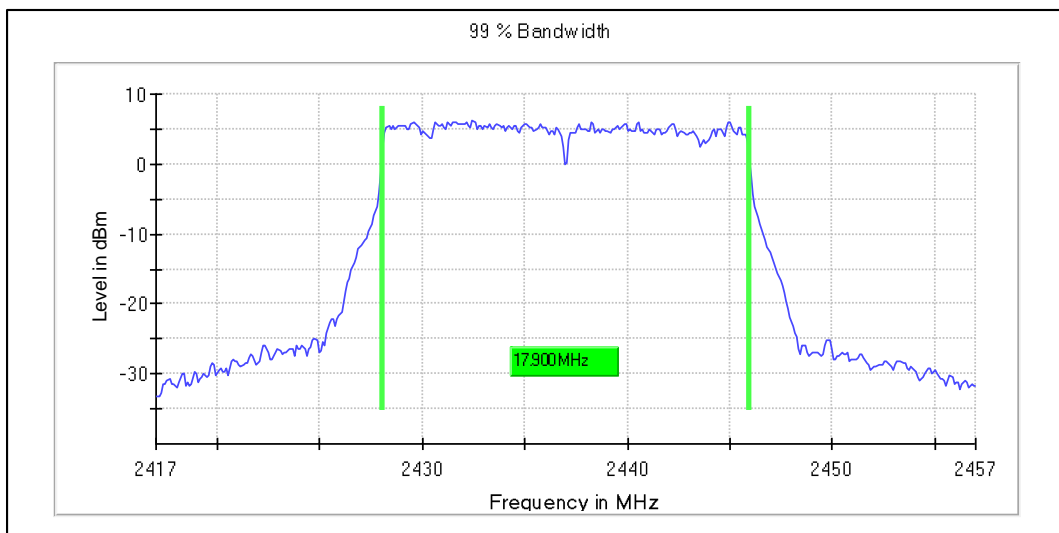

Data Rate: MCS7

Channel Frequency: 2437MHz

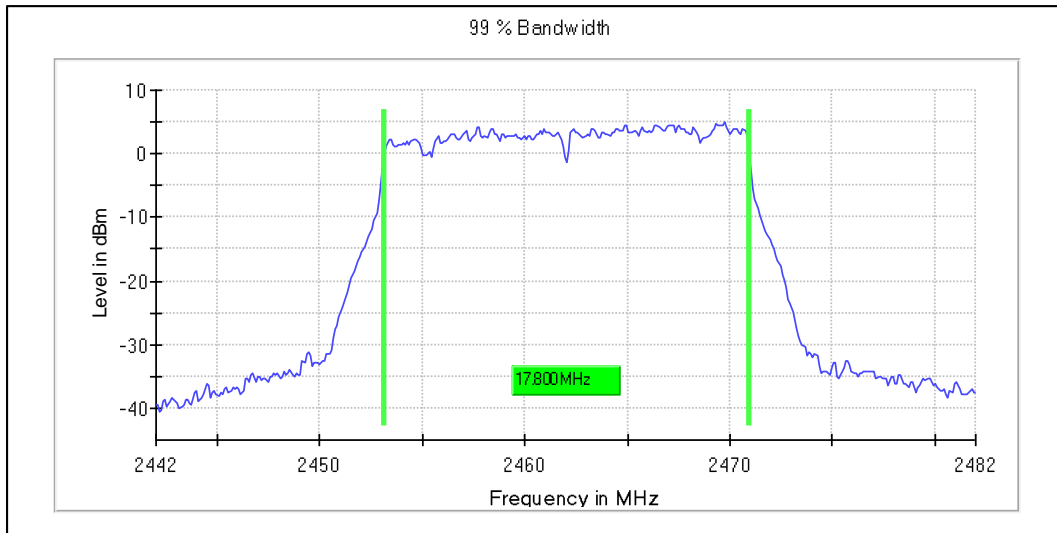

Data Rate: MCS7

Channel Frequency: 2462MHz

Modulation: 802.11ac_VHT20

Data rate (Mbps)	Channel Frequency (MHz)	6 dB Bandwidth (MHz)	99% OBW (MHz)	Minimum Limit (MHz)
MCS0	2412	16.40	18.00	0.5
	2437	17.65	19.30	0.5
	2462	16.75	17.90	0.5
MCS8	2412	17.80	17.90	0.5
	2437	17.85	17.90	0.5
	2462	17.80	17.90	0.5

Graphs for 6 dB bandwidth measurement

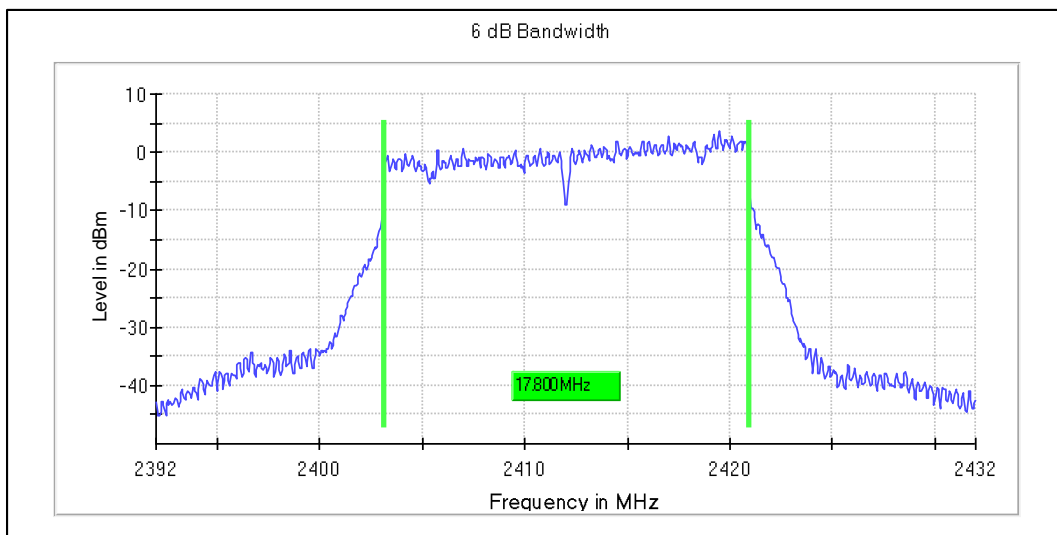

Data Rate: MCS8

Channel Frequency: 2412MHz

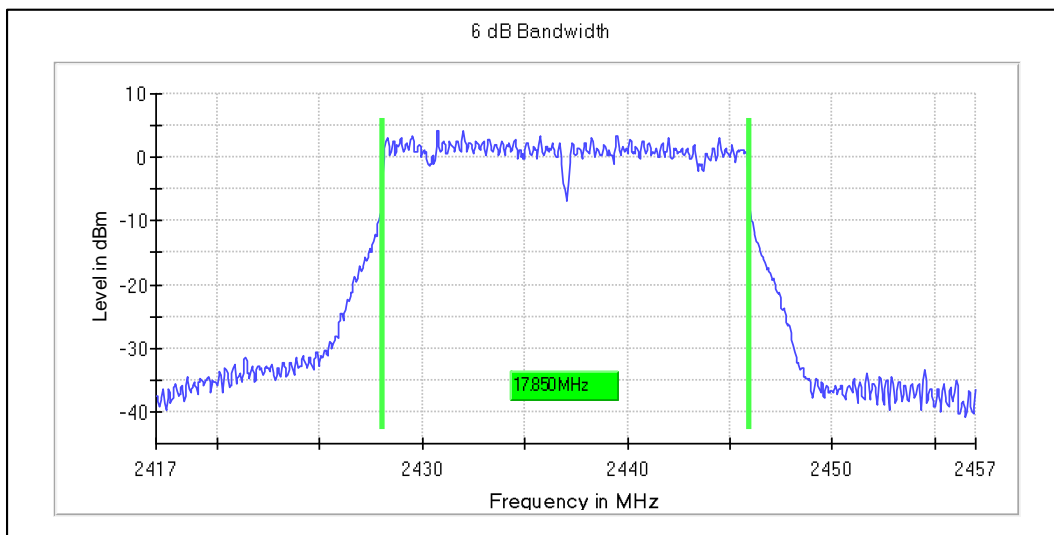

Data Rate: MCS8

Channel Frequency: 2437MHz

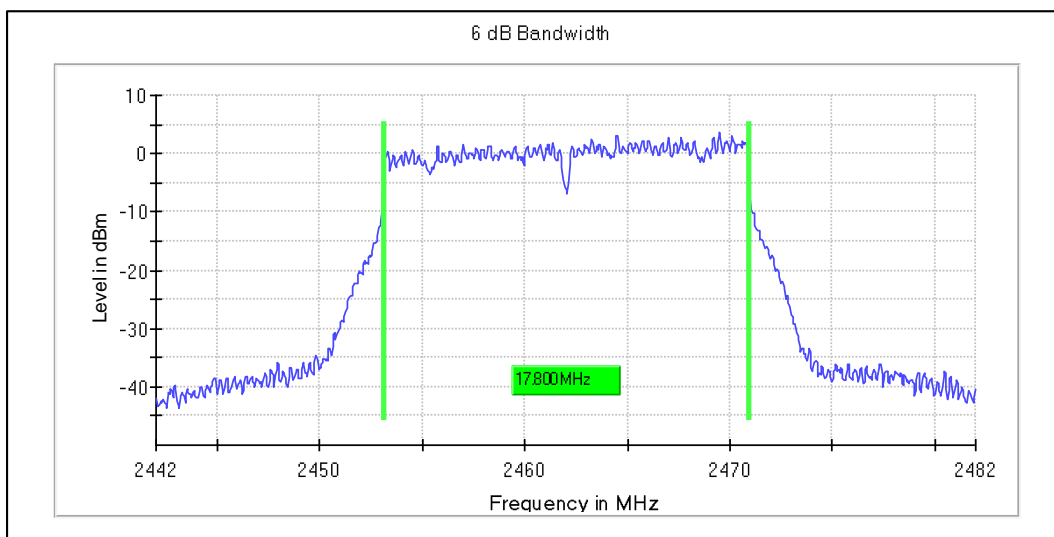

Data Rate: MCS8

Channel Frequency: 2462MHz

Graphs for OCW 99 % bandwidth measurement

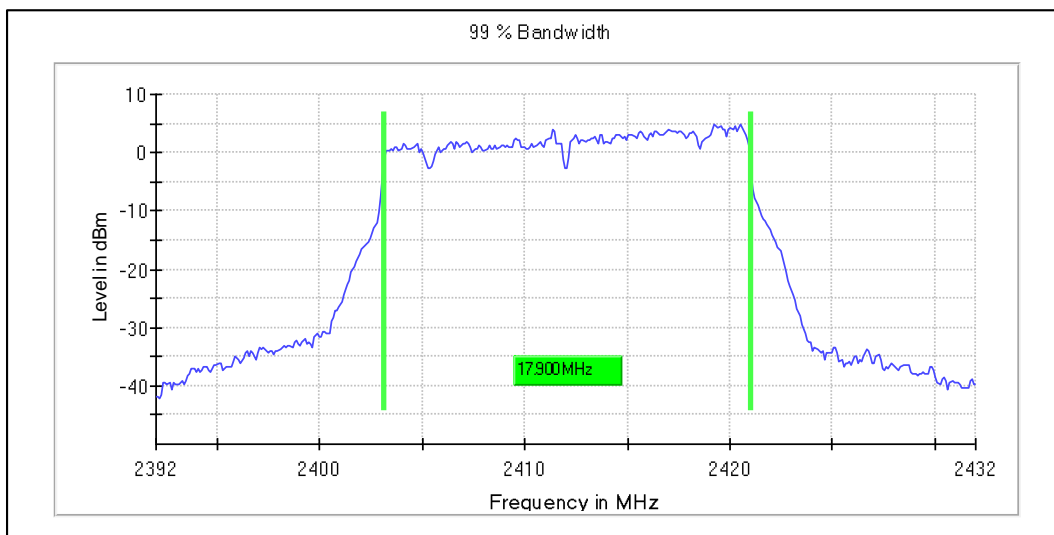

Data Rate: MCS8

Channel Frequency: 2412MHz

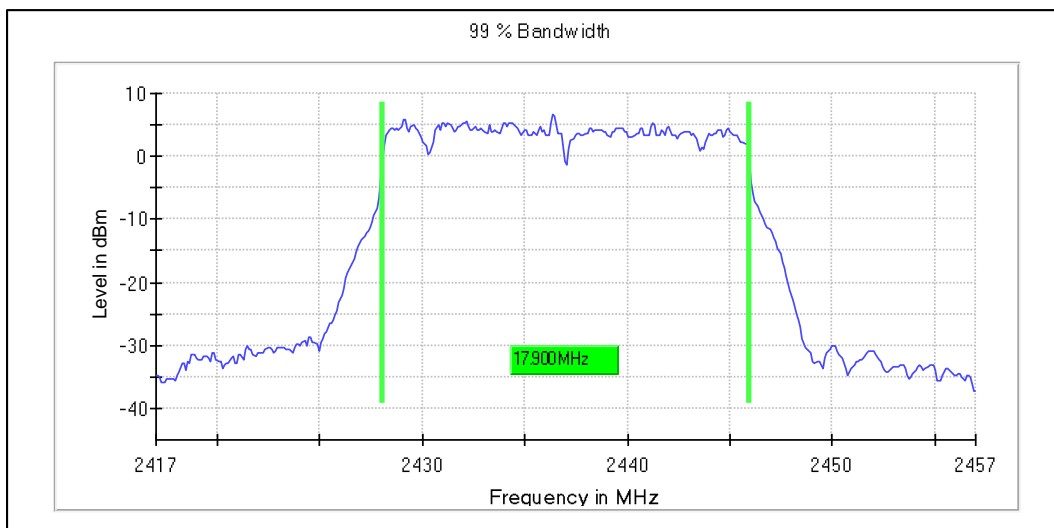

Data Rate: MCS8

Channel Frequency: 2437MHz

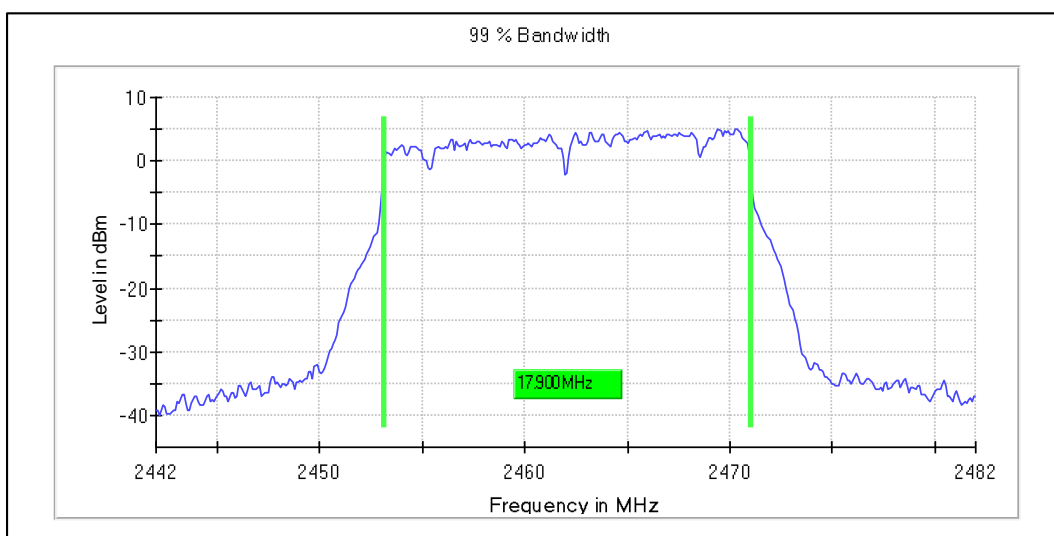

Data Rate: MCS8

Channel Frequency: 2462MHz

Modulation: 802.11ax_HE20

Data rate (Mbps)	Channel Frequency (MHz)	6 dB Bandwidth (MHz)	99% OBW (MHz)	Minimum Limit (MHz)
MCS0	2412	17.15	19.10	0.5
	2437	19.00	19.40	0.5
	2462	17.10	19.00	0.5
MCS11	2412	19.10	19.20	0.5
	2437	19.25	19.10	0.5
	2462	19.15	19.00	0.5

Graphs for 6 dB bandwidth measurement

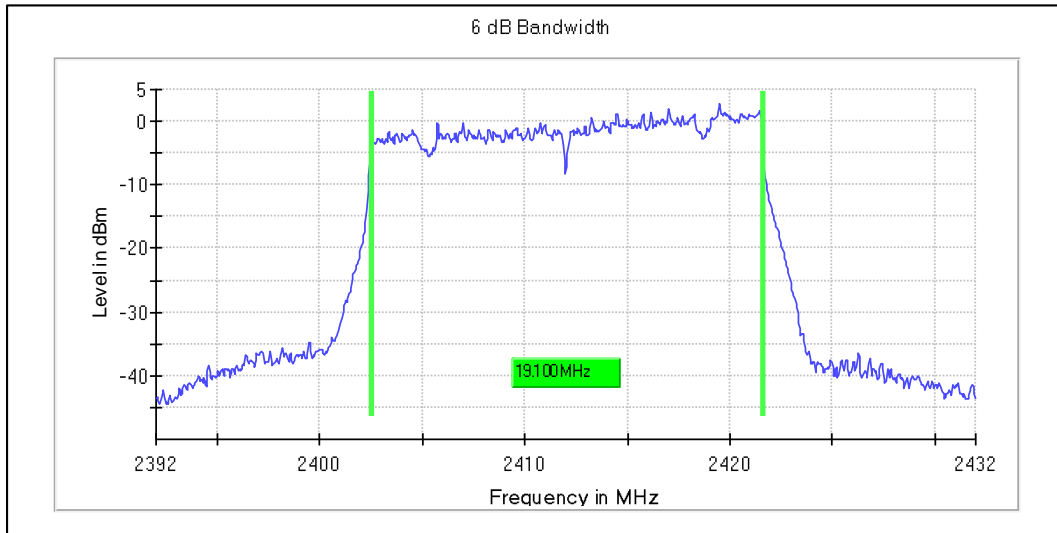

Data Rate: MCS11

Channel Frequency: 2412MHz

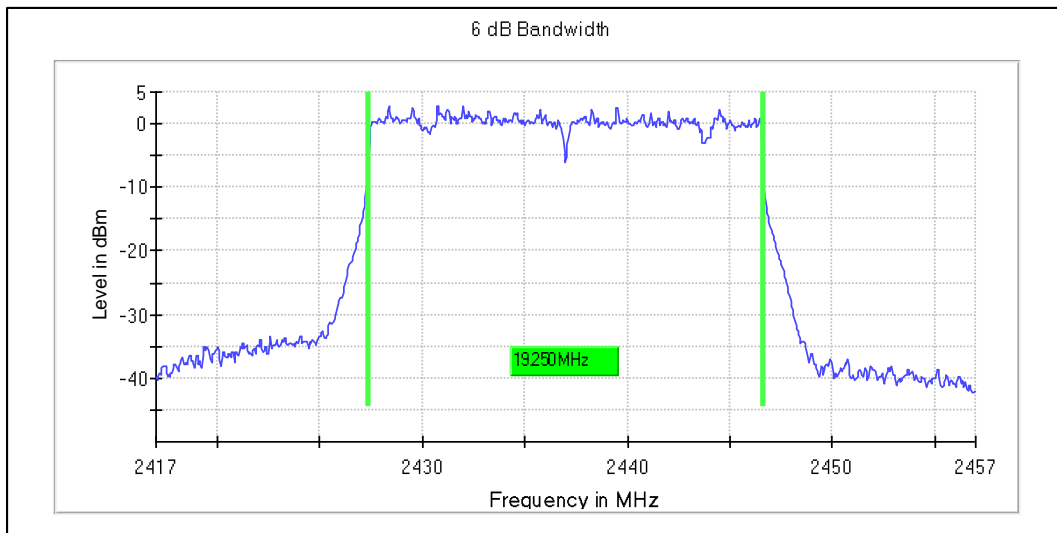

Data Rate: MCS11

Channel Frequency: 2437MHz



Data Rate: MCS11

Channel Frequency: 2462MHz

Graphs for OCW 99 % bandwidth measurement

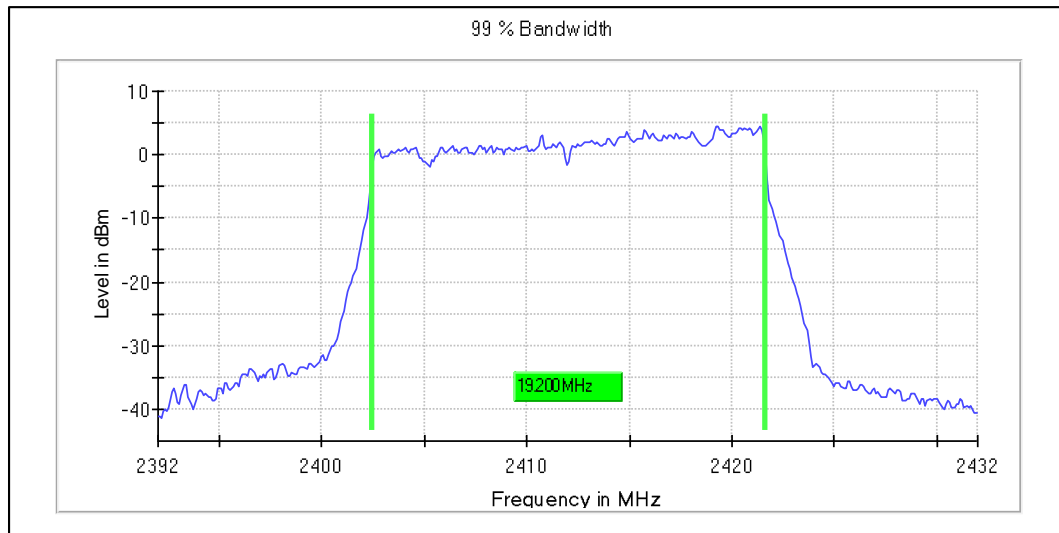

Data Rate: MCS11

Channel Frequency: 2412MHz

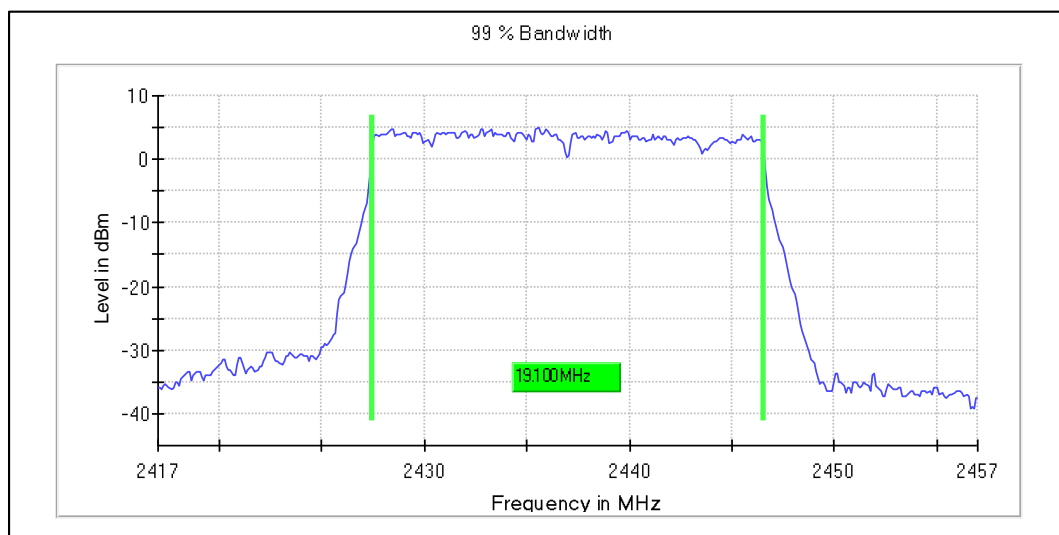

Data Rate: MCS11

Channel Frequency: 2437MHz

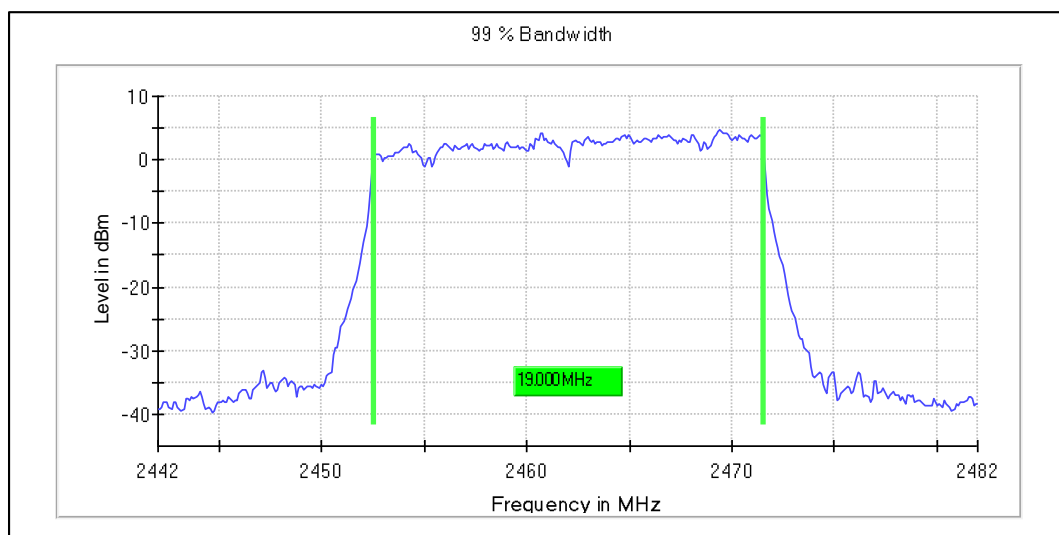

Data Rate: MCS11

Channel Frequency: 2462MHz

Modulation: 802.11n_HT40

Data rate (Mbps)	Channel Frequency (MHz)	6 dB Bandwidth (MHz)	99% OBW (MHz)	Minimum Limit (MHz)
MCS0	2422	35.70	36.50	0.5
	2437	36.45	38.35	0.5
	2452	36.15	37.00	0.5
MCS7	2422	35.85	36.50	0.5
	2437	36.60	36.75	0.5
	2452	36.60	36.50	0.5

Graphs for 6 dB bandwidth measurement

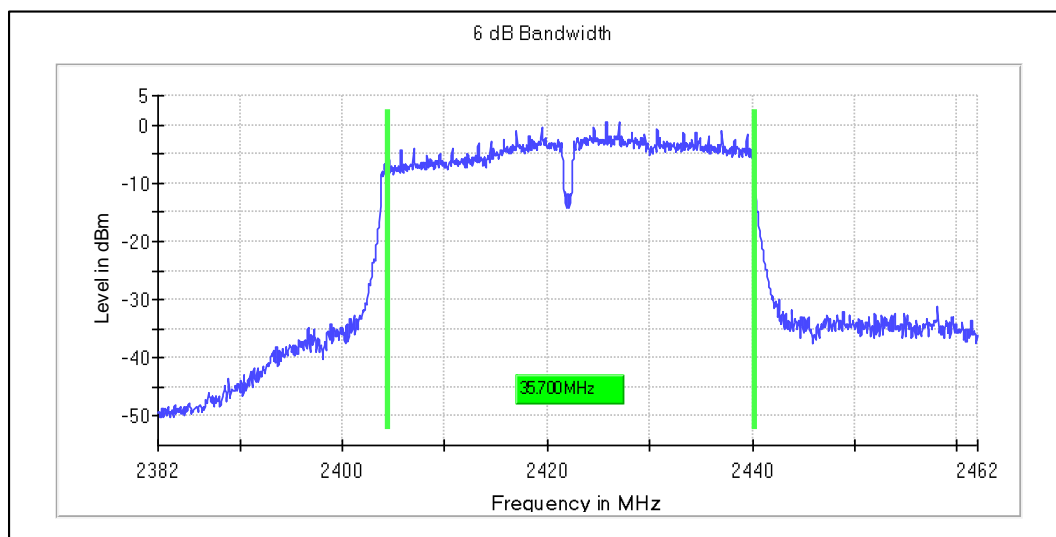

Data Rate: MCS0

Channel Frequency: 2422MHz

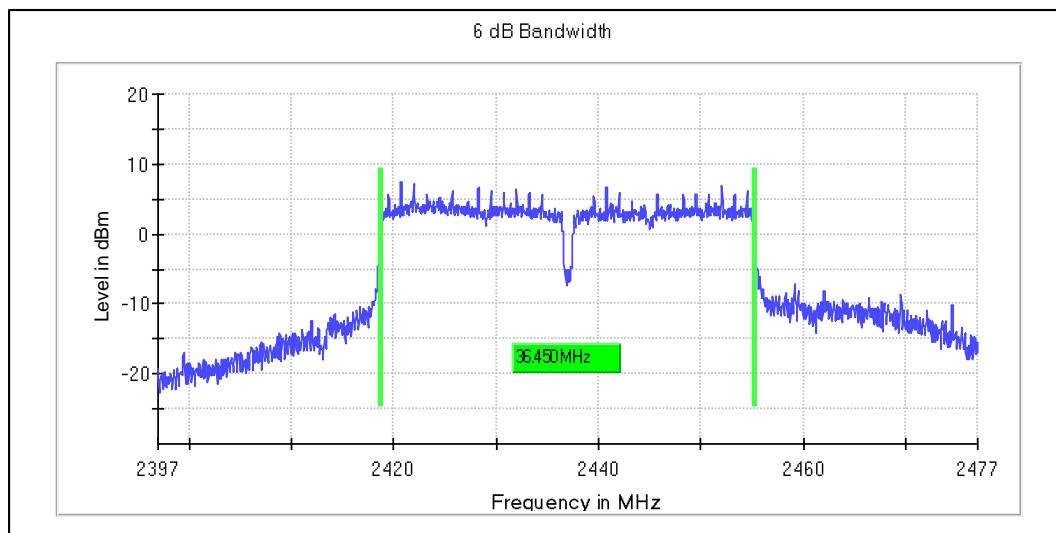

Data Rate: MCS0

Channel Frequency: 2437MHz

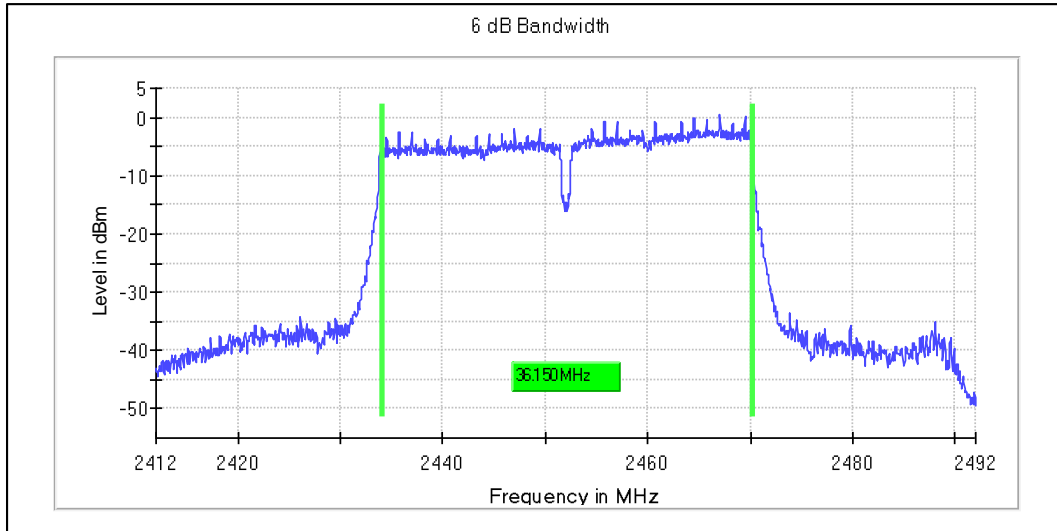

Data Rate: MCS0

Channel Frequency: 2452MHz

Graphs for OCW 99 % bandwidth measurement

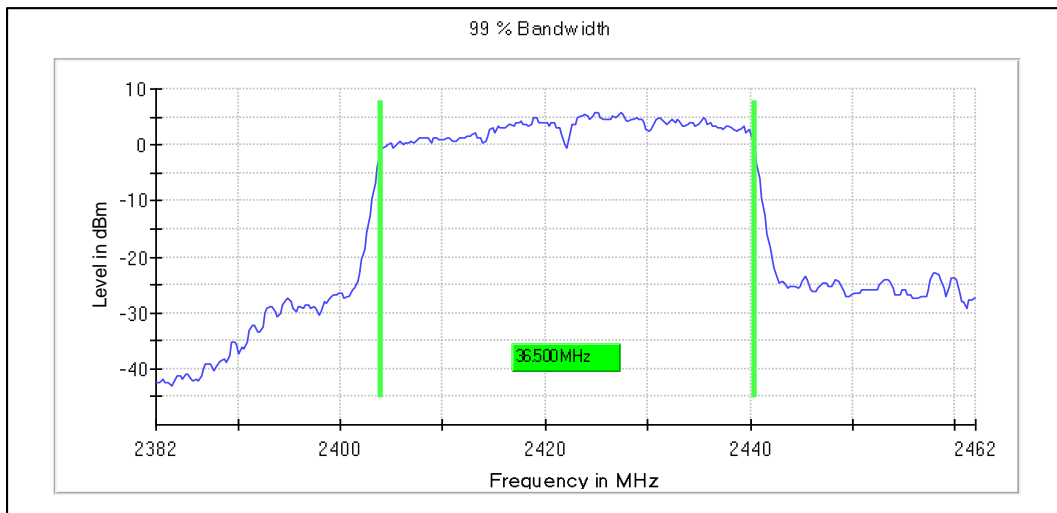

Data Rate: MCS0

Channel Frequency: 2422MHz

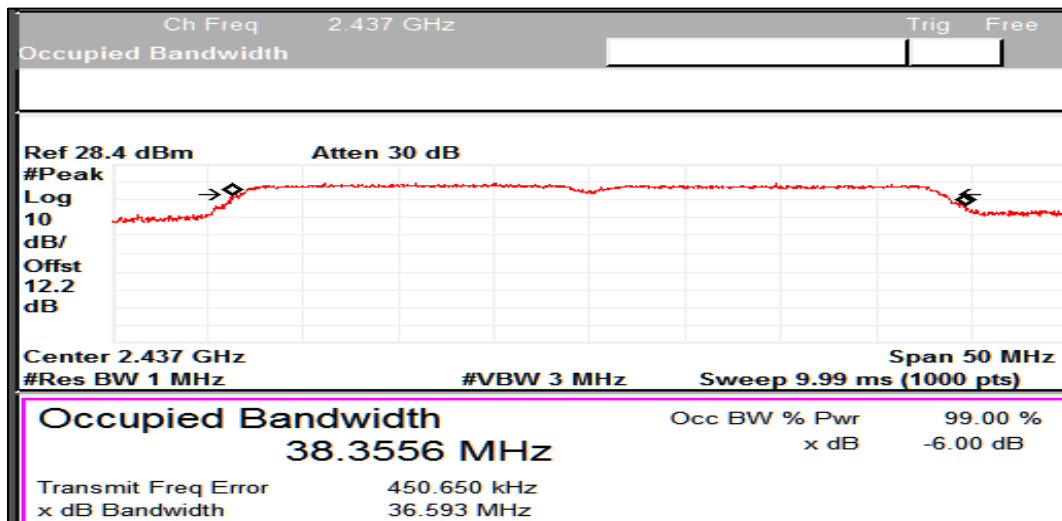

Data Rate: MCS0

Channel Frequency: 2437MHz

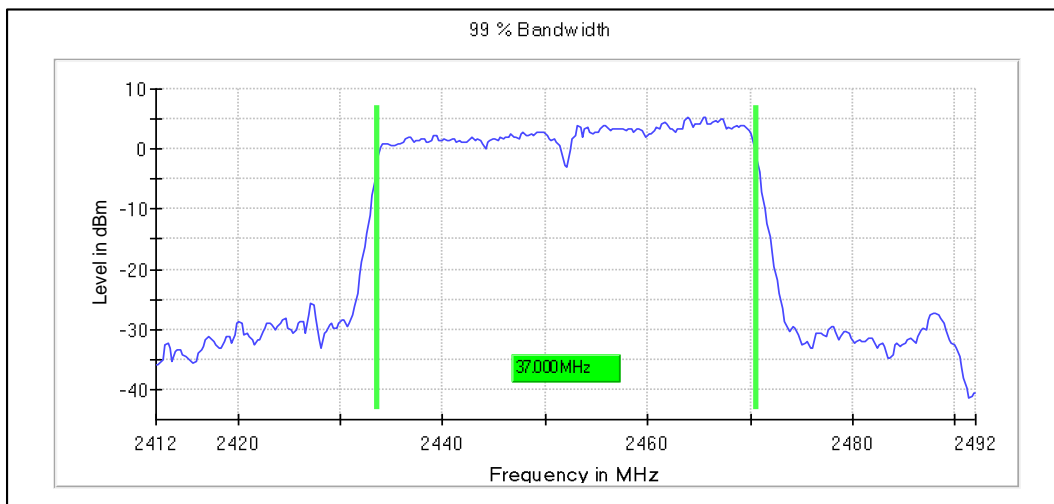

Data Rate: MCS0

Channel Frequency: 2452MHz

Modulation: 802.11ac_VHT40

Data rate (Mbps)	Channel Frequency (MHz)	6 dB Bandwidth (MHz)	99% OBW (MHz)	Minimum Limit (MHz)
MCS0	2422	35.80	36.50	0.5
	2437	36.83	38.13	0.5
	2452	36.20	36.75	0.5
MCS8	2422	36.50	36.50	0.5
	2437	36.55	36.75	0.5
	2452	36.55	36.75	0.5

Graphs for 6 dB bandwidth measurement

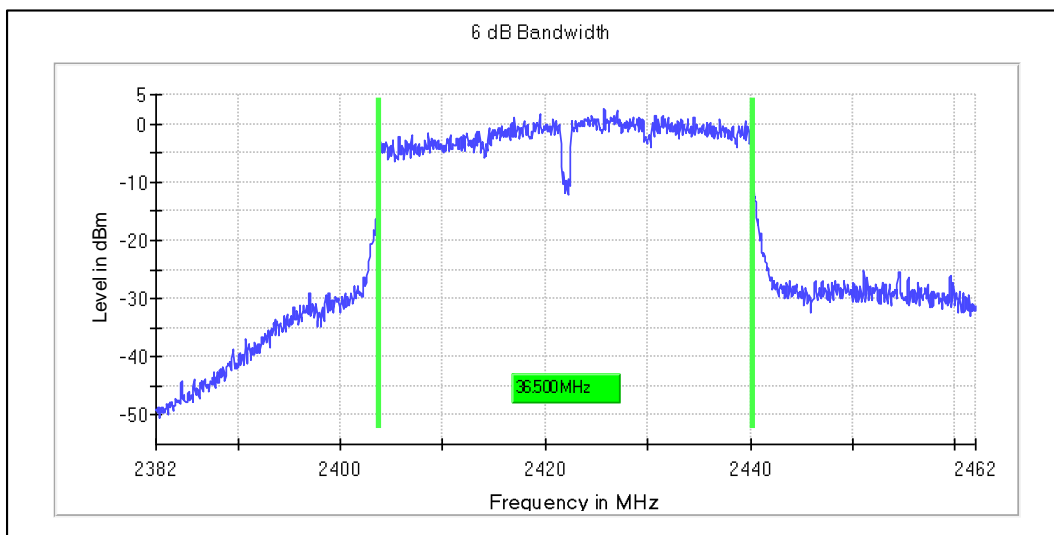

Data Rate: MCS8

Channel Frequency: 2422MHz

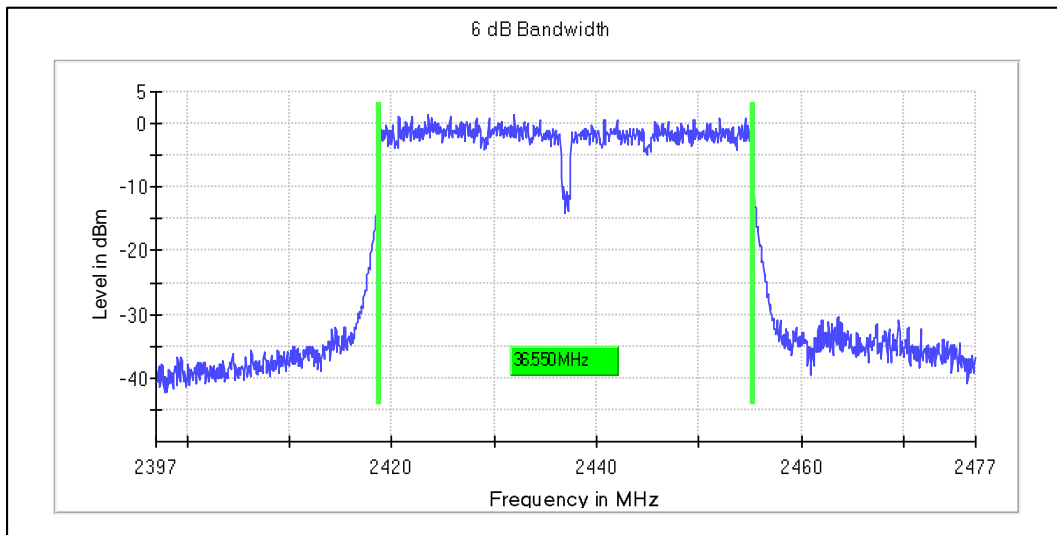

Data Rate: MCS8

Channel Frequency: 2437MHz

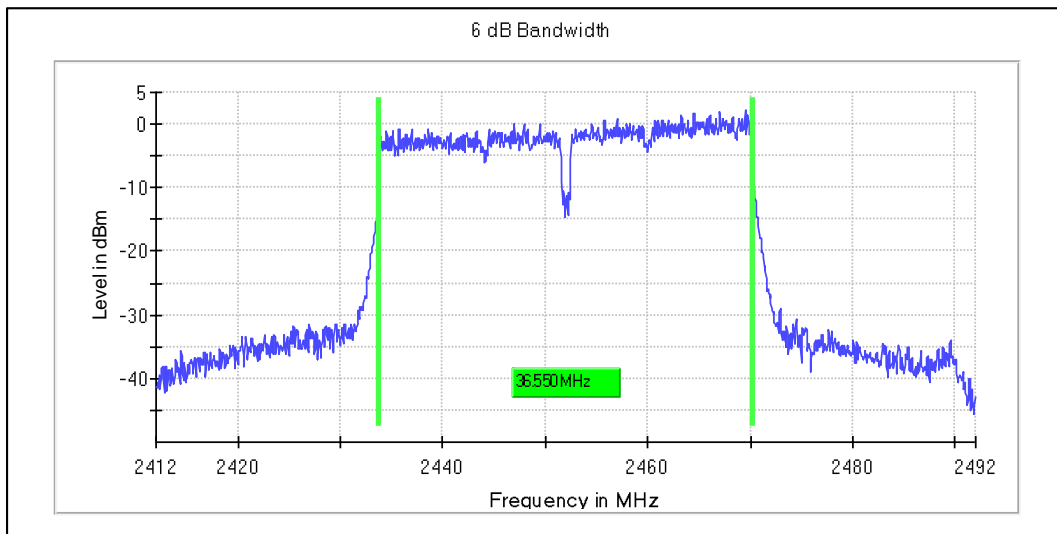

Data Rate: MCS8

Channel Frequency: 2452MHz

Graphs for OCW 99 % bandwidth measurement

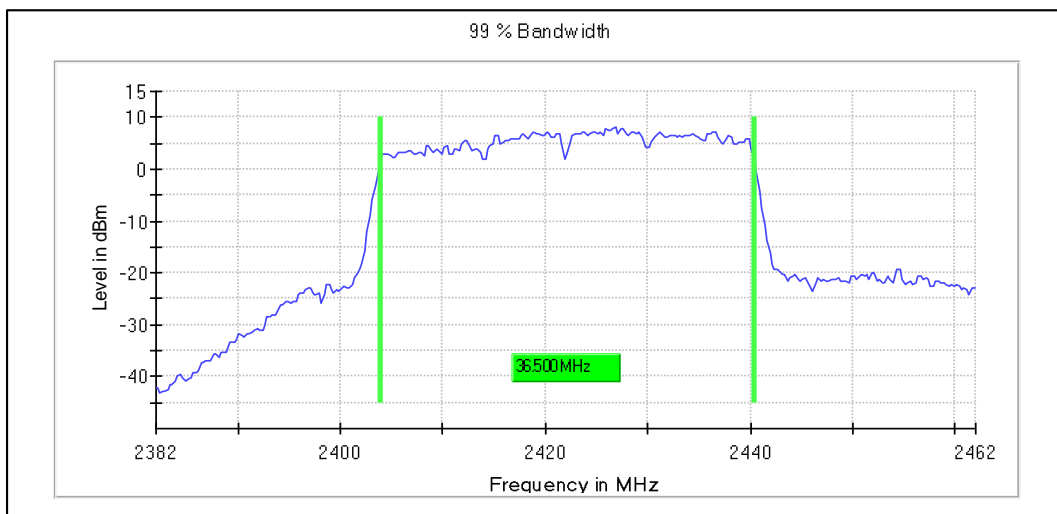

Data Rate: MCS8

Channel Frequency: 2422MHz

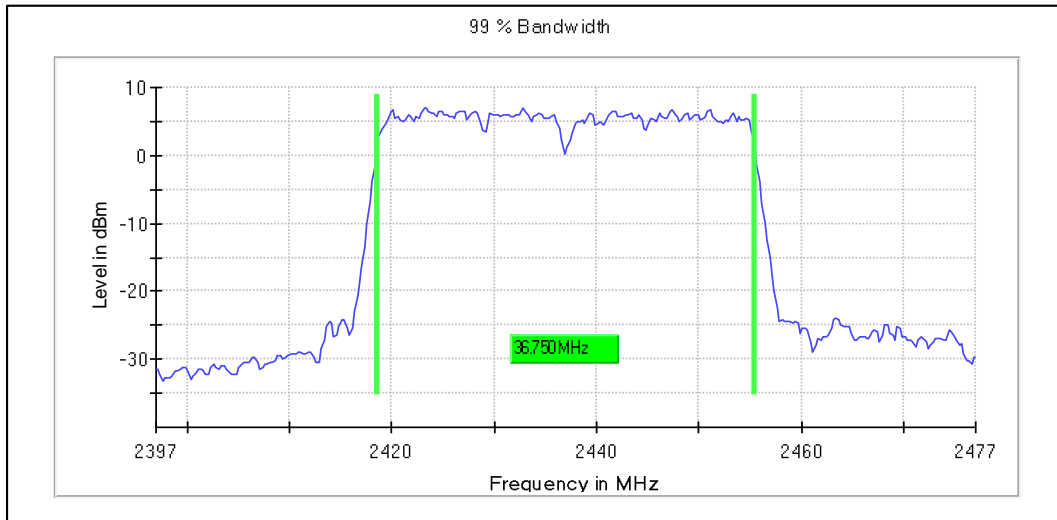

Data Rate: MCS8

Channel Frequency: 2437MHz

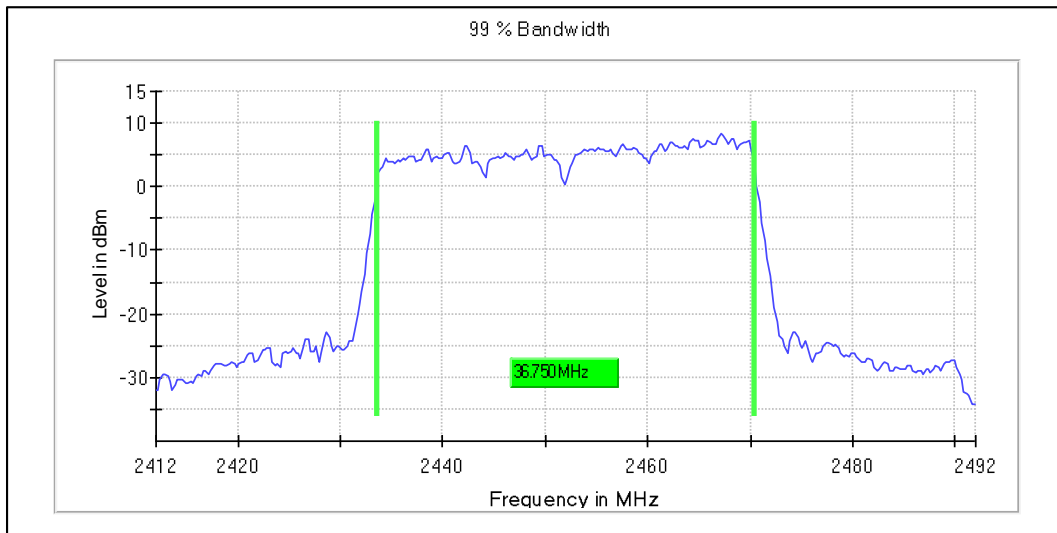

Data Rate: MCS8

Channel Frequency: 2452MHz

Modulation: 802.11ax_HE40

Data rate (Mbps)	Channel Frequency (MHz)	6 dB Bandwidth (MHz)	99% OBW (MHz)	Minimum Limit (MHz)
MCS0	2422	36.50	37.50	0.5
	2437	37.84	38.84	0.5
	2452	37.90	38.00	0.5
MCS11	2422	37.40	37.50	0.5
	2437	38.05	37.75	0.5
	2452	37.90	37.75	0.5

Graphs for 6 dB bandwidth measurement

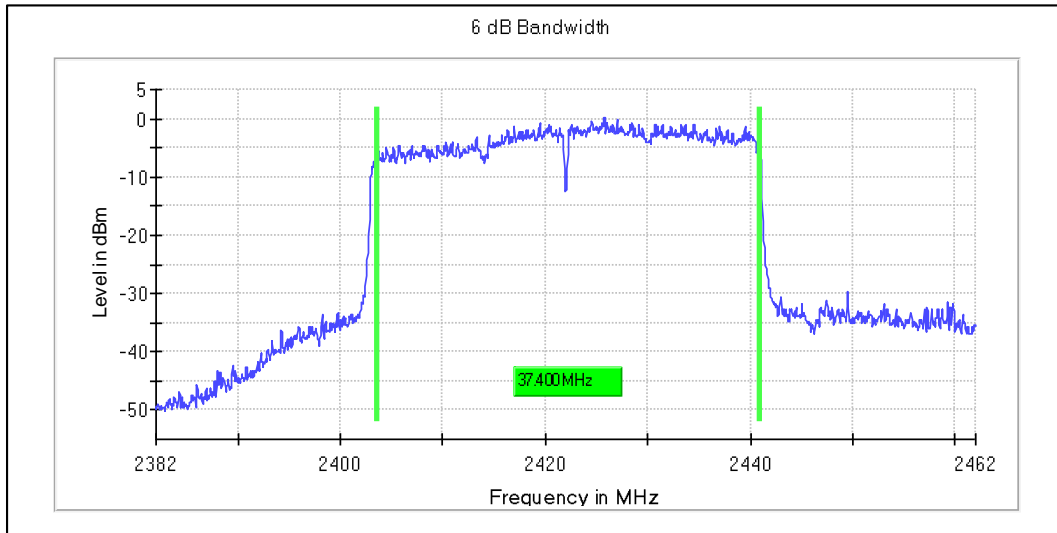

Data Rate: MCS11

Channel Frequency: 2422MHz

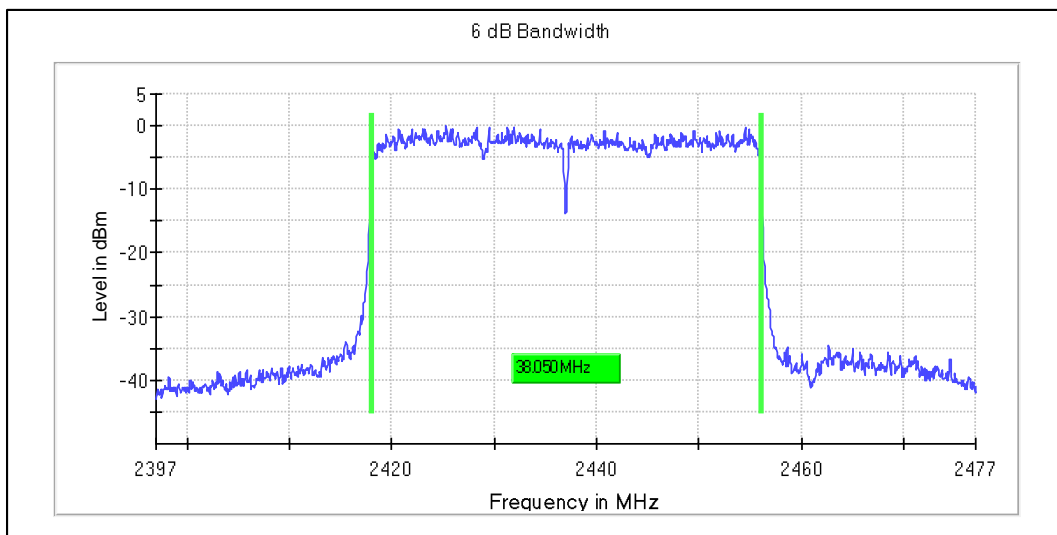

Data Rate: MCS11

Channel Frequency: 2437MHz

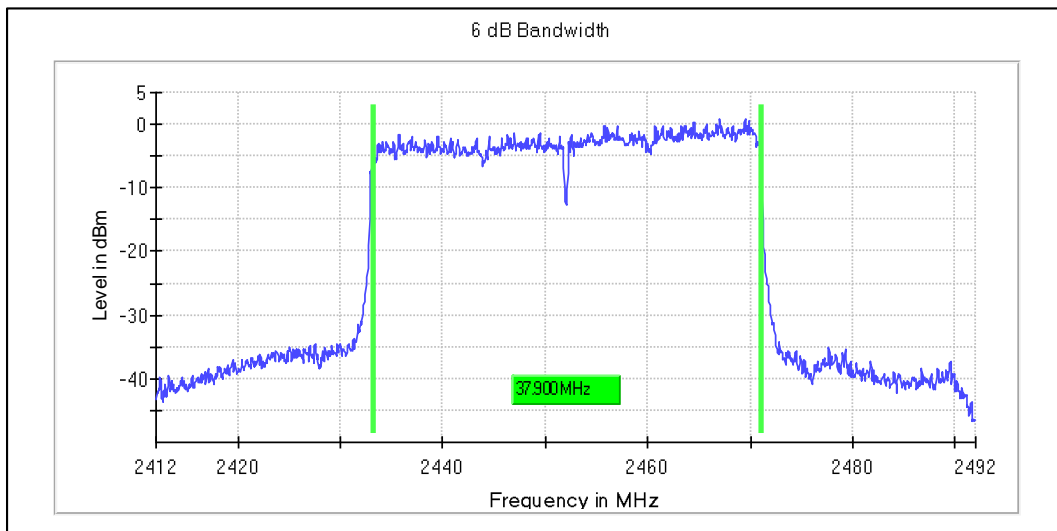

Data Rate: MCS11

Channel Frequency: 2452MHz

Graphs for OCW 99 % bandwidth measurement

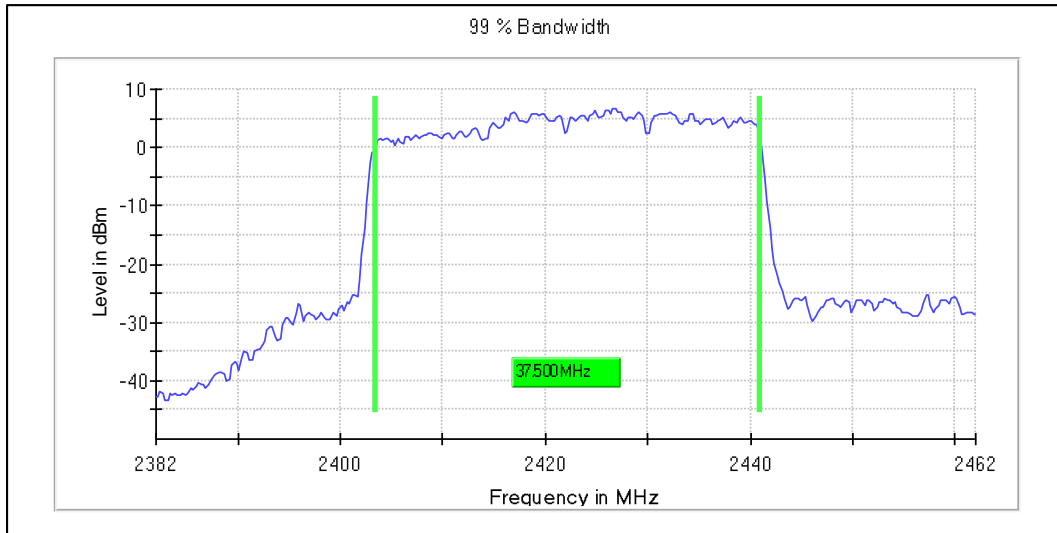

Data Rate: MCS11

Channel Frequency: 2422MHz

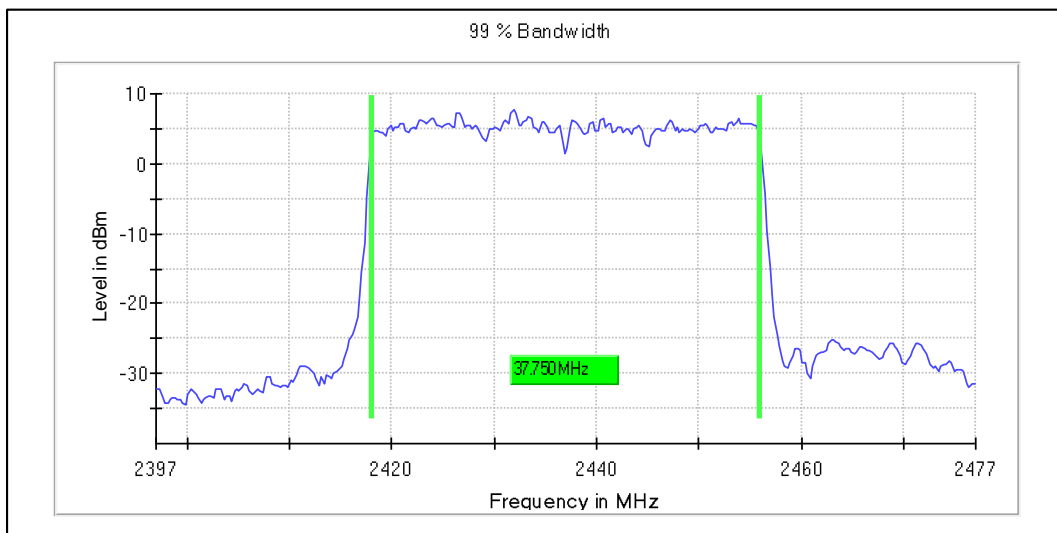

Data Rate: MCS11

Channel Frequency: 2437MHz

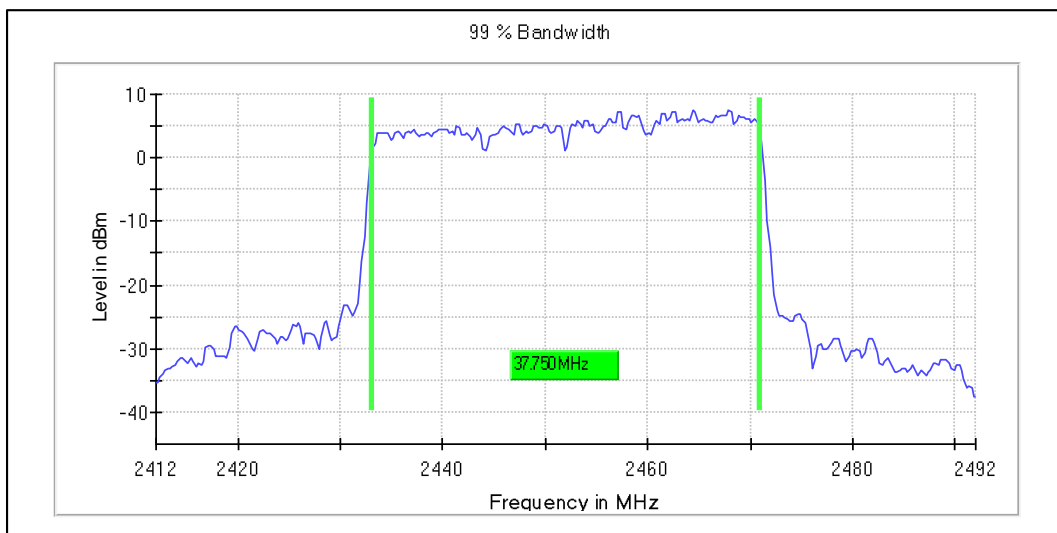

Data Rate: MCS11

Channel Frequency: 2452MHz

Antenna Type: FPA3020-10A (PCB/Flex) MIMO Antenna Results

Note:

1. All the losses are included during measurement and final values are mentioned in the test report.
2. Total Average PSD (dBm) = Measured Average PSD (dBm) + Attenuator factor (10dB) + Cable loss (0.4dB)
3. This product do not support additional beamforming gain / directional gain, it uses signal antenna and hence directional gain of the single antenna is 4.23 dBi

Modulation: 802.11b

Data rate (Mbps)	Channel Frequency (MHz)	6 dB Bandwidth (MHz)	99% OBW (MHz)	Minimum Limit (MHz)
1Mbps	2412	7.65	11.30	0.5
	2437	7.65	11.70	0.5
	2462	7.65	11.10	0.5
11Mbps	2412	8.20	11.30	0.5
	2437	7.55	11.40	0.5
	2462	6.95	11.20	0.5

Graphs for 6 dB bandwidth measurement

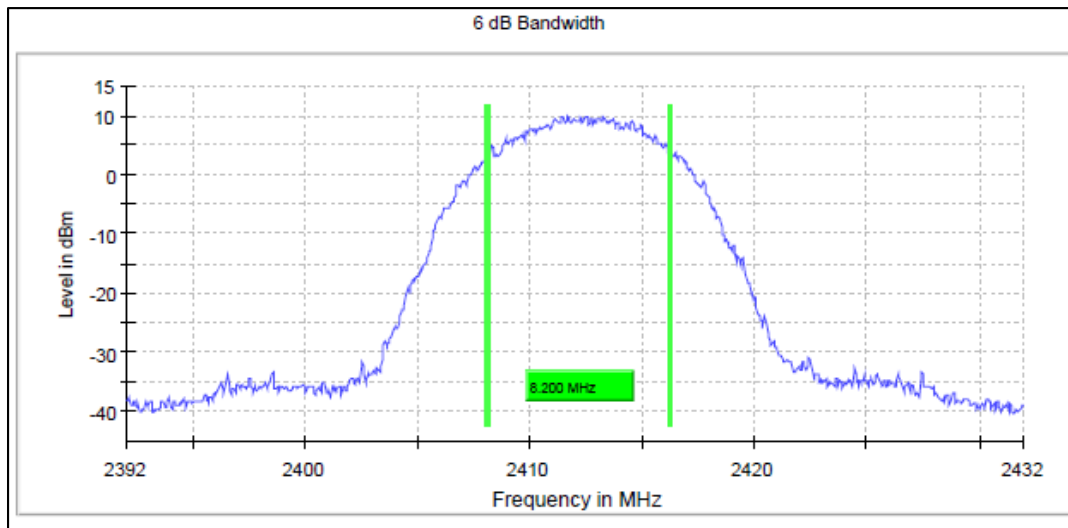

Data Rate: 11Mbps

Channel Frequency: 2412MHz

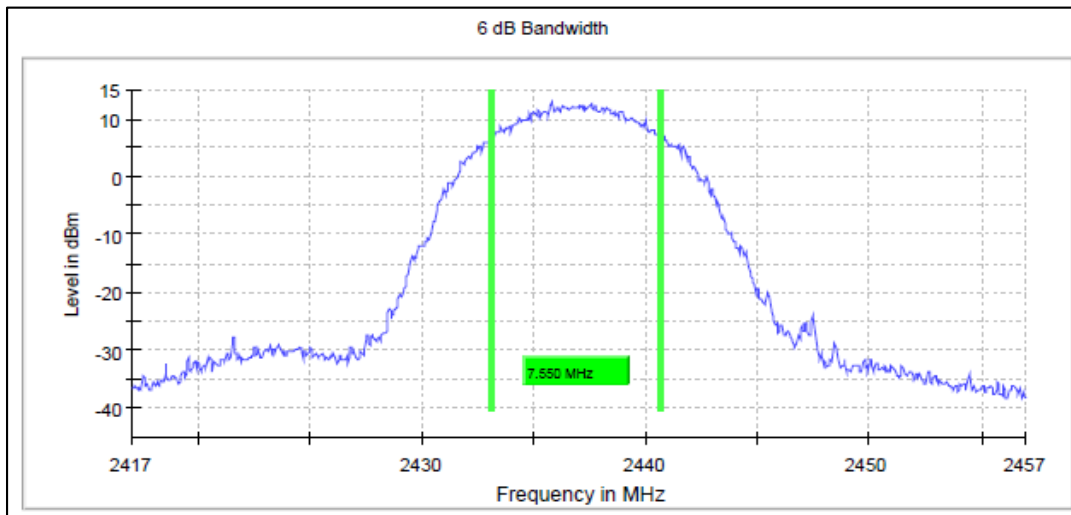

Data Rate: 11Mbps

Channel Frequency: 2437MHz

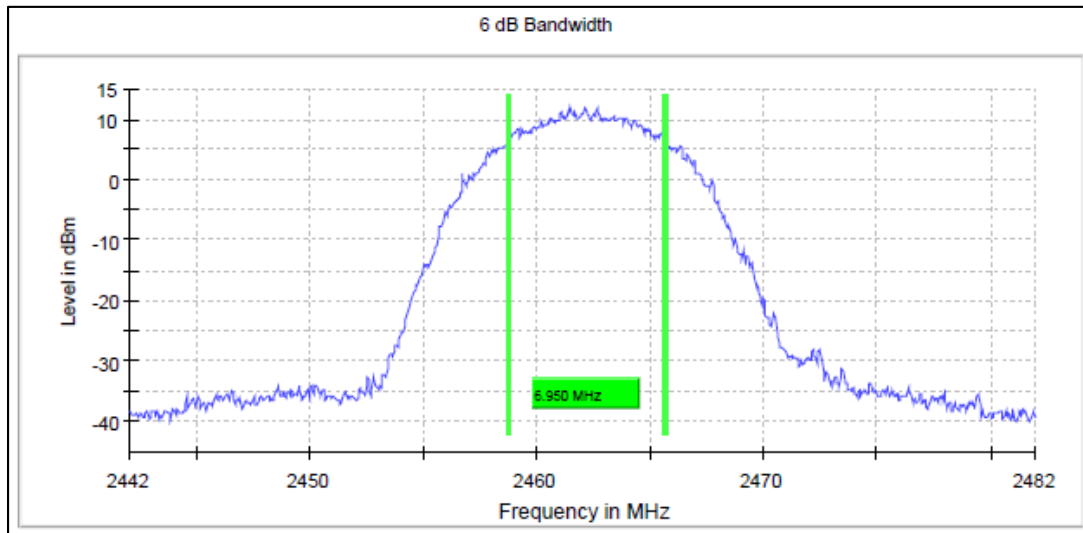

Data Rate: 11Mbps

Channel Frequency: 2462MHz

Graphs for OCW 99 % bandwidth measurement

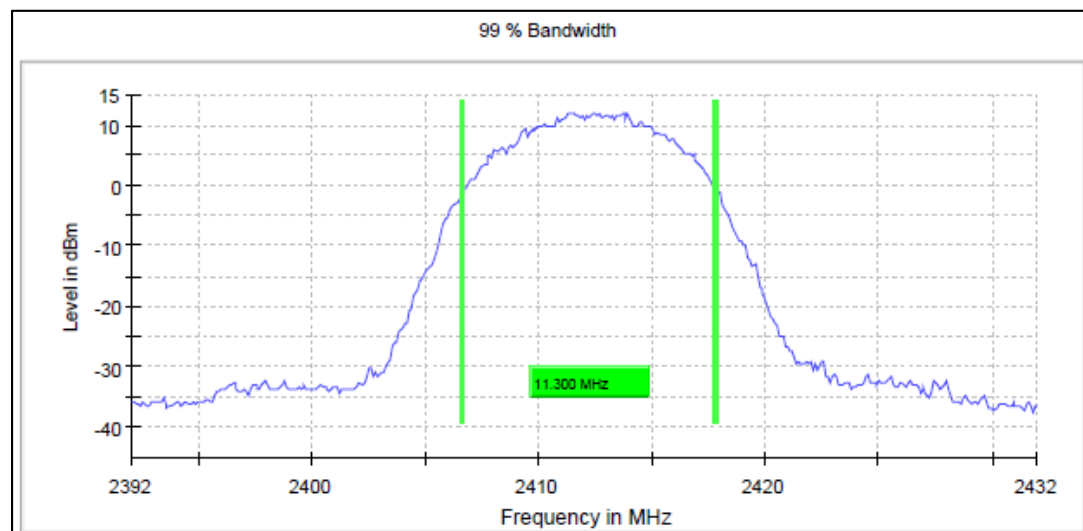

Data Rate: 11Mbps

Channel Frequency: 2412MHz

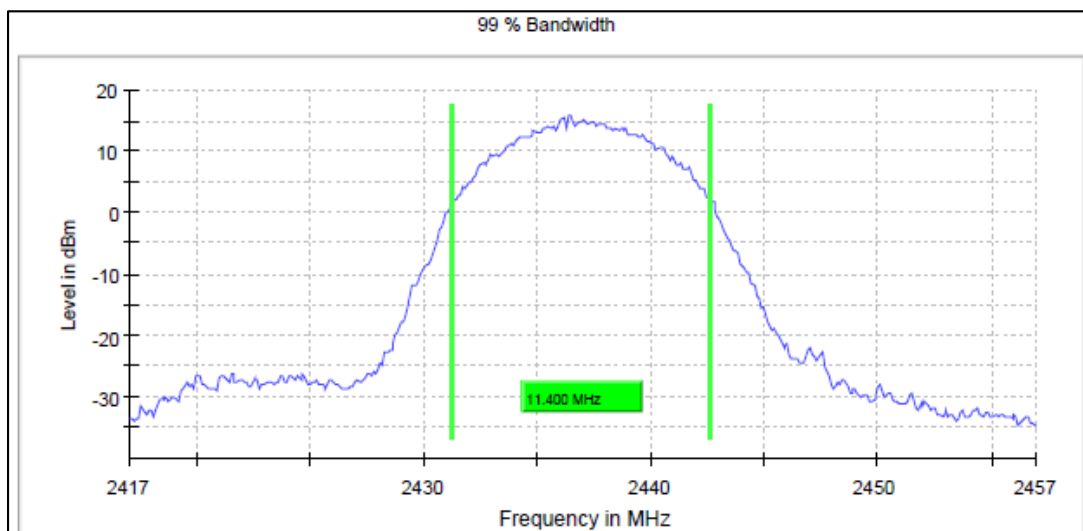

Data Rate: 11Mbps

Channel Frequency: 2437MHz

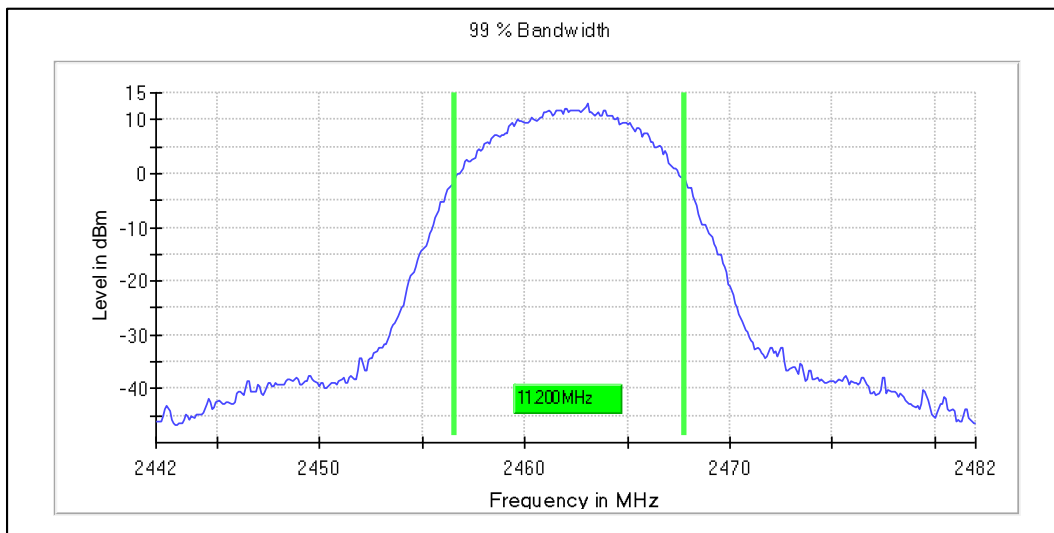

Data Rate: 11Mbps

Channel Frequency: 2462MHz

Modulation: 802.11g

Data rate (Mbps)	Channel Frequency (MHz)	6 dB Bandwidth (MHz)	99% OBW (MHz)	Minimum Limit (MHz)
6Mbps	2412	15.80	17.00	0.5
	2437	16.40	18.80	0.5
	2462	16.15	16.80	0.5
54Mbps	2412	16.50	16.90	0.5
	2437	16.55	16.70	0.5
	2462	16.55	16.70	0.5

Graphs for 6 dB bandwidth measurement

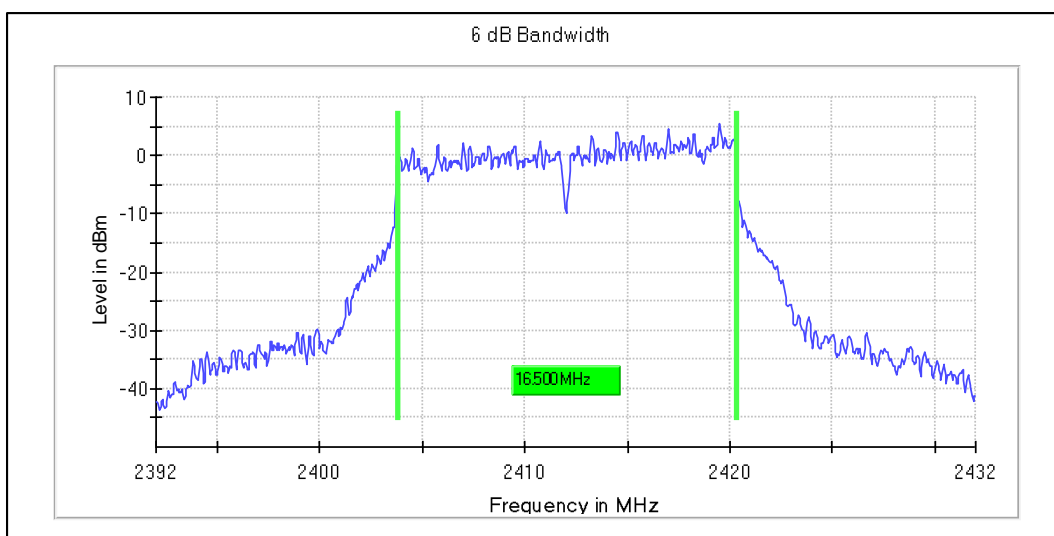

Data Rate: 54Mbps

Channel Frequency: 2412MHz

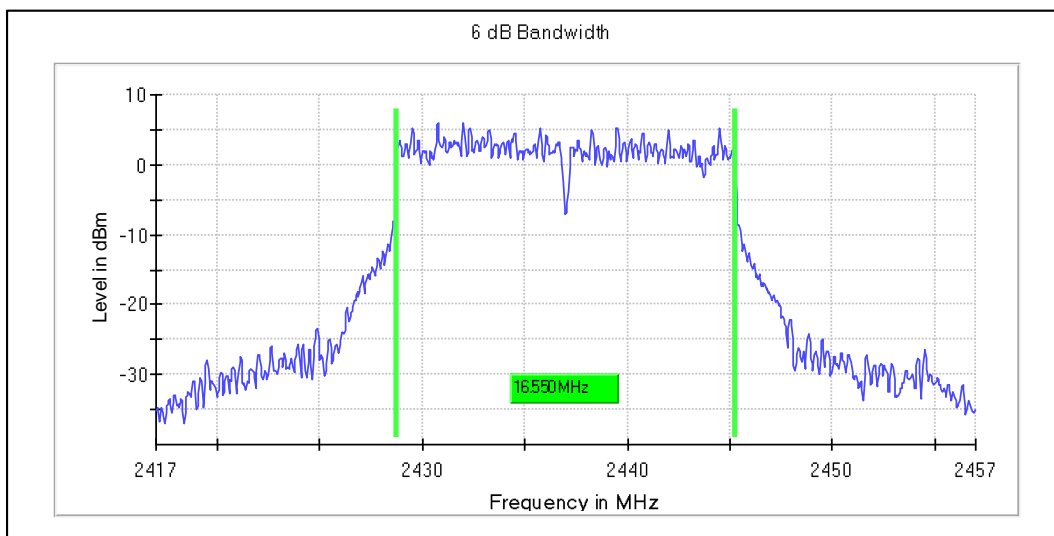

Data Rate: 54Mbps

Channel Frequency: 2437MHz

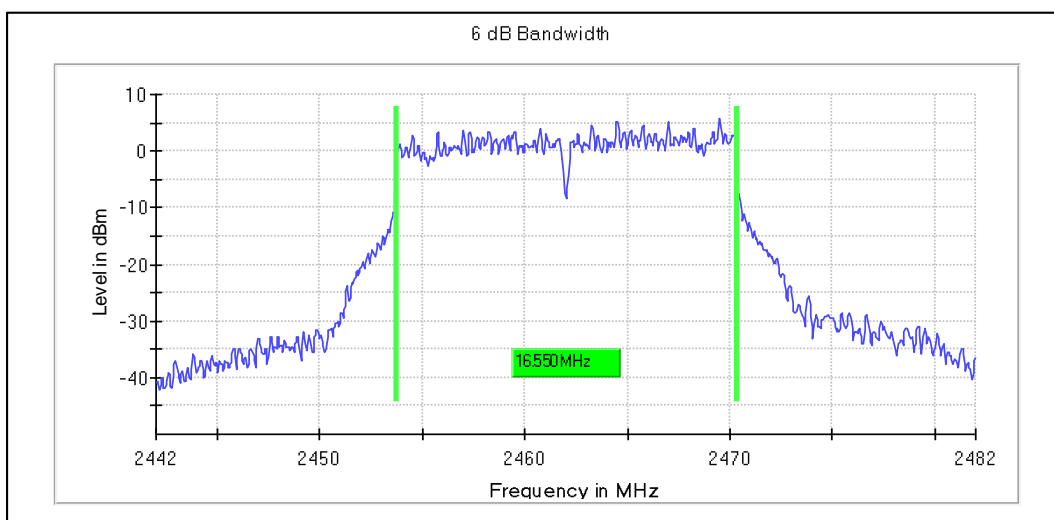

Data Rate: 54Mbps

Channel Frequency: 2462MHz

Graphs for OCW 99 % bandwidth measurement

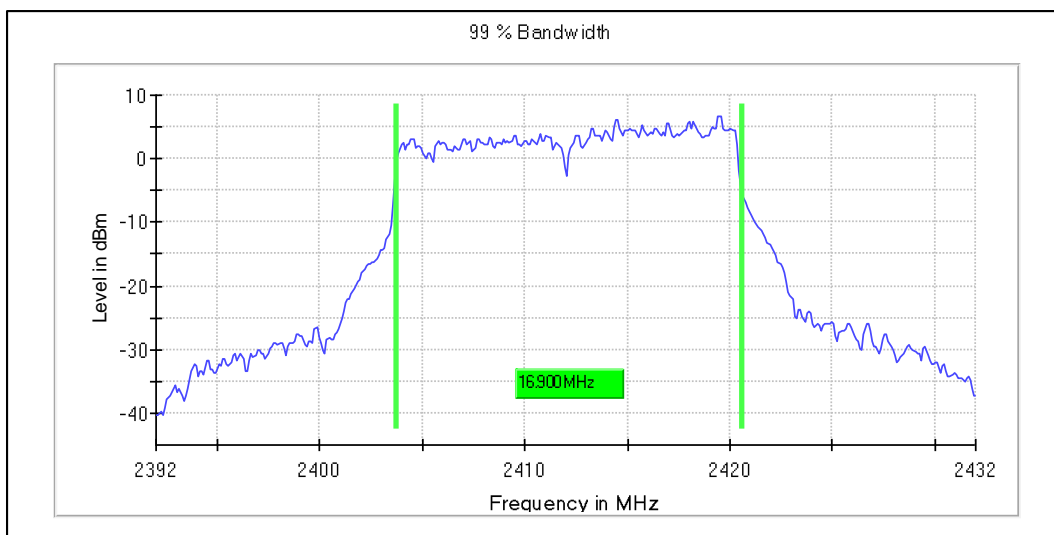

Data Rate: 54Mbps

Channel Frequency: 2412MHz

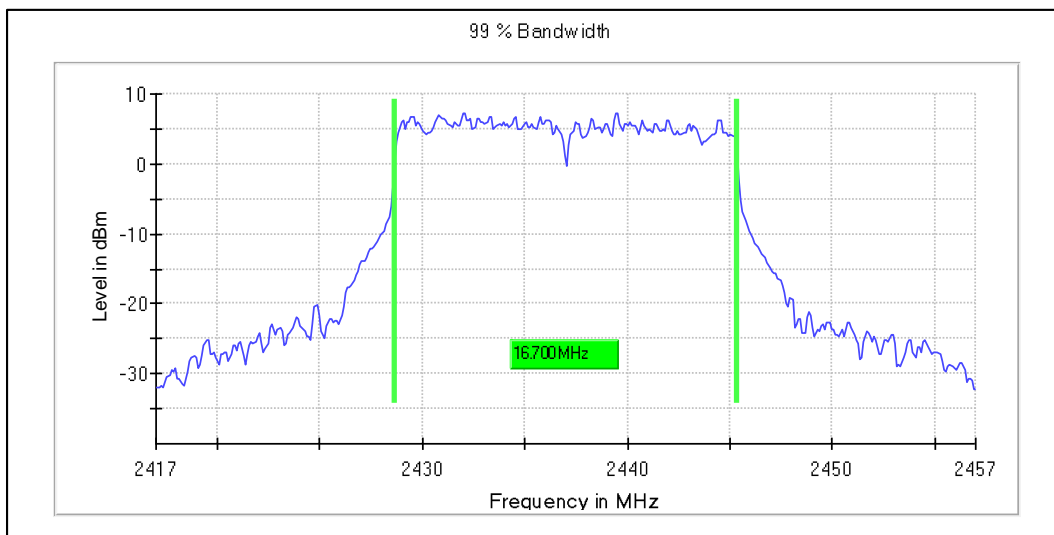

Data Rate: 54Mbps

Channel Frequency: 2437MHz

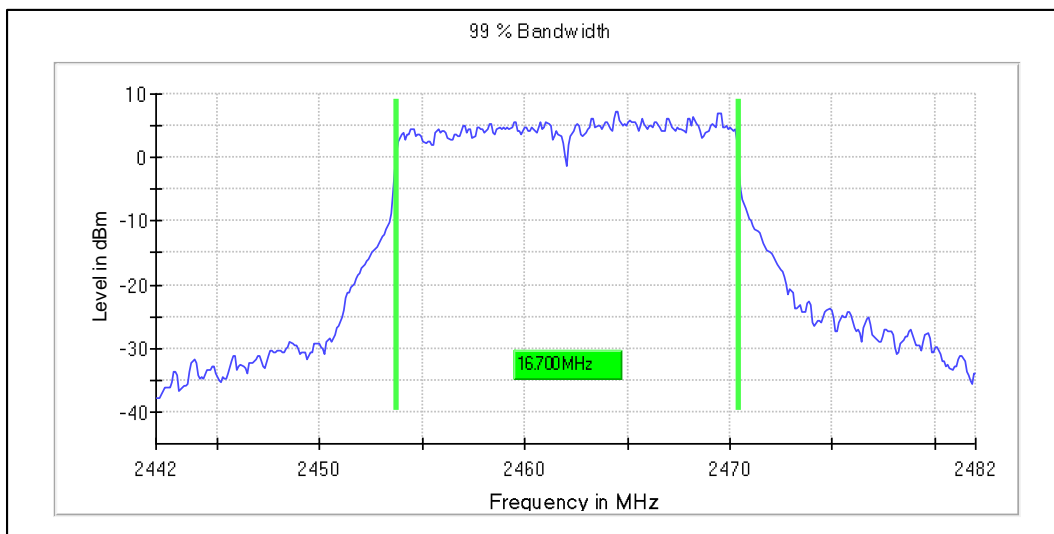

Data Rate: 54Mbps

Channel Frequency: 2462MHz

Modulation: 802.11n_HT20

Data rate (Mbps)	Channel Frequency (MHz)	6 dB Bandwidth (MHz)	99% OBW (MHz)	Minimum Limit (MHz)
MCS0	2412	16.40	18.30	0.5
	2437	17.65	19.80	0.5
	2462	16.65	17.90	0.5
MCS7	2412	17.80	17.90	0.5
	2437	17.85	17.90	0.5
	2462	17.80	17.80	0.5

Graphs for 6 dB bandwidth measurement

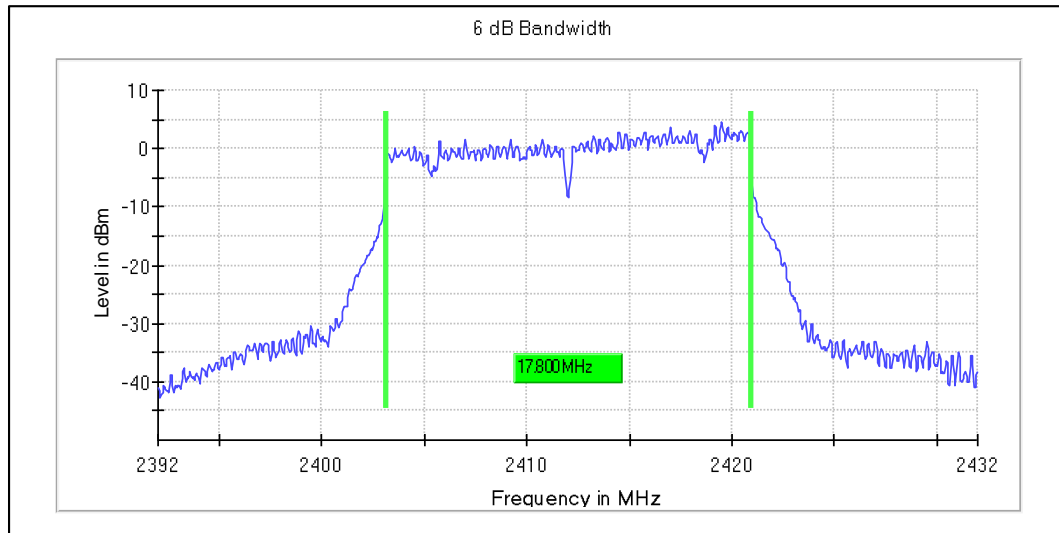

Data Rate: MCS7

Channel Frequency: 2412MHz

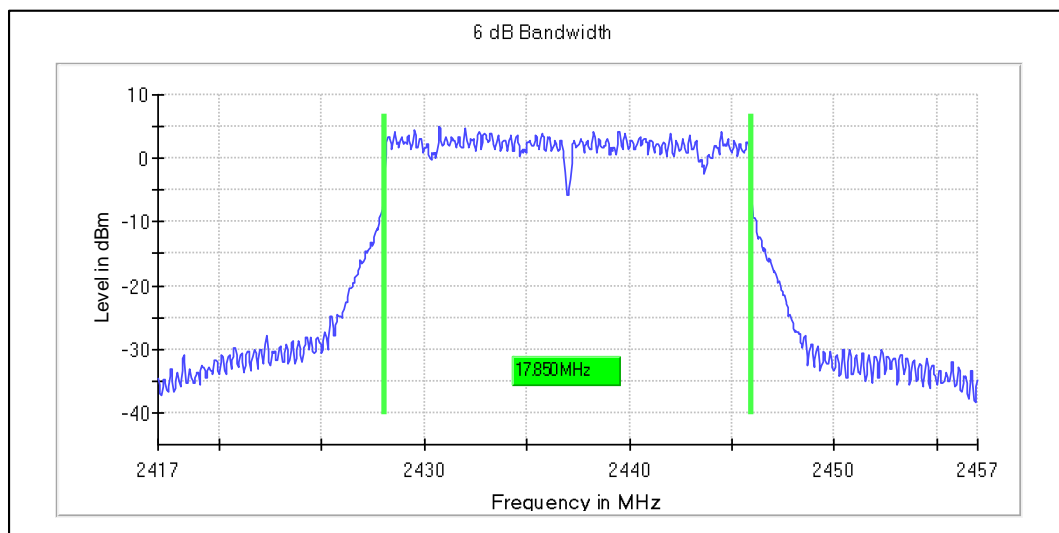

Data Rate: MCS7

Channel Frequency: 2437MHz

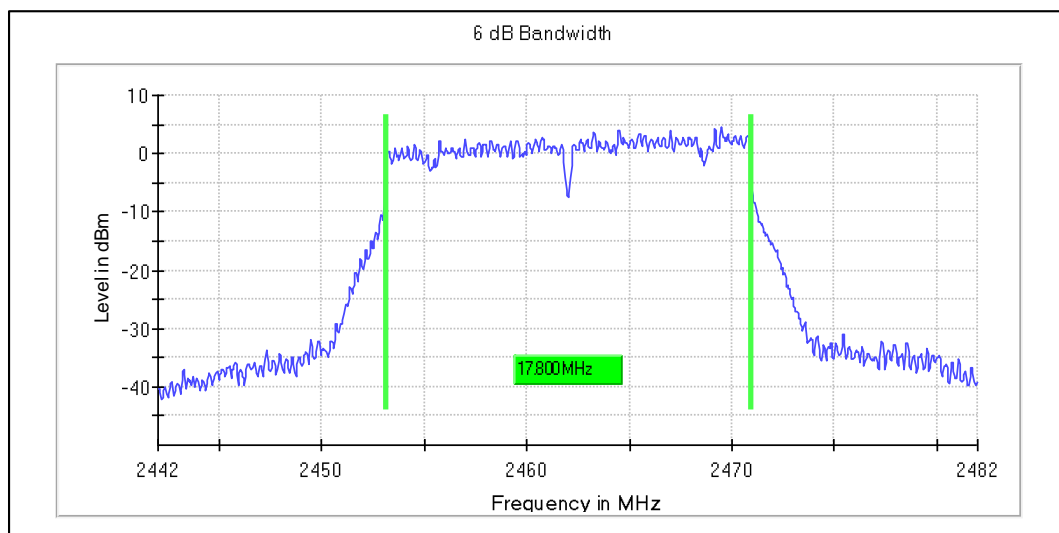

Data Rate: MCS7

Channel Frequency: 2462MHz

Graphs for OCW 99 % bandwidth measurement

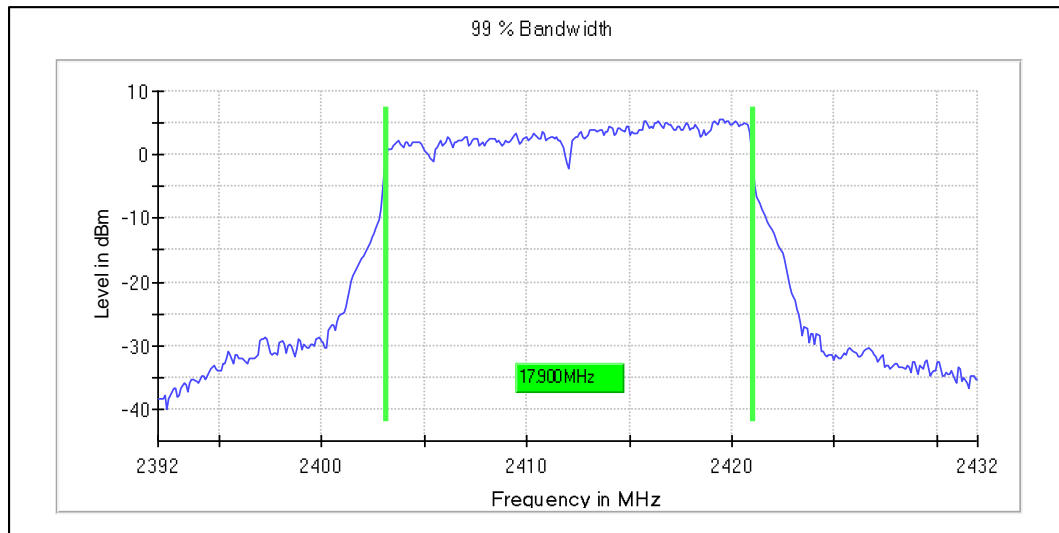

Data Rate: MCS7

Channel Frequency: 2412MHz

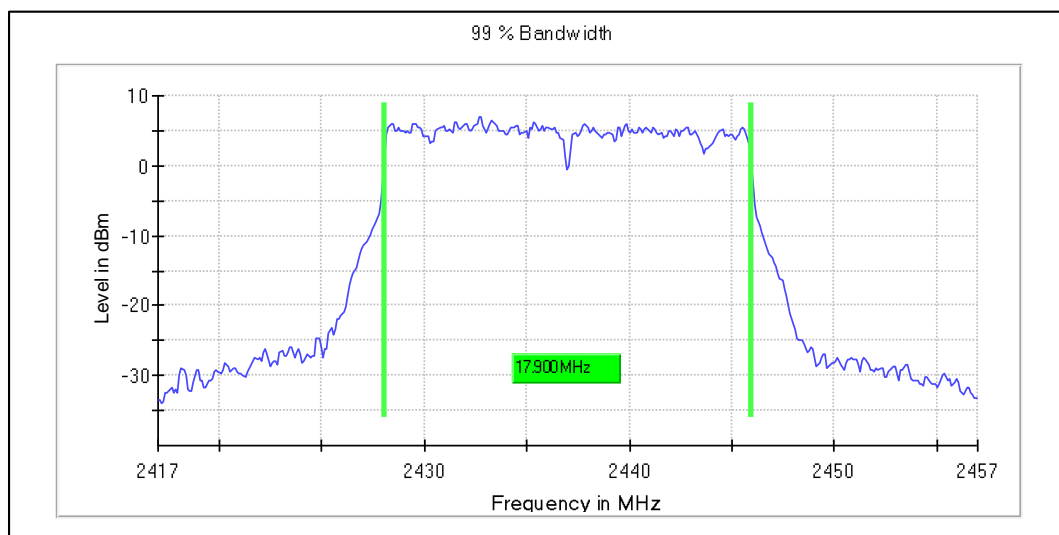

Data Rate: MCS7

Channel Frequency: 2437MHz

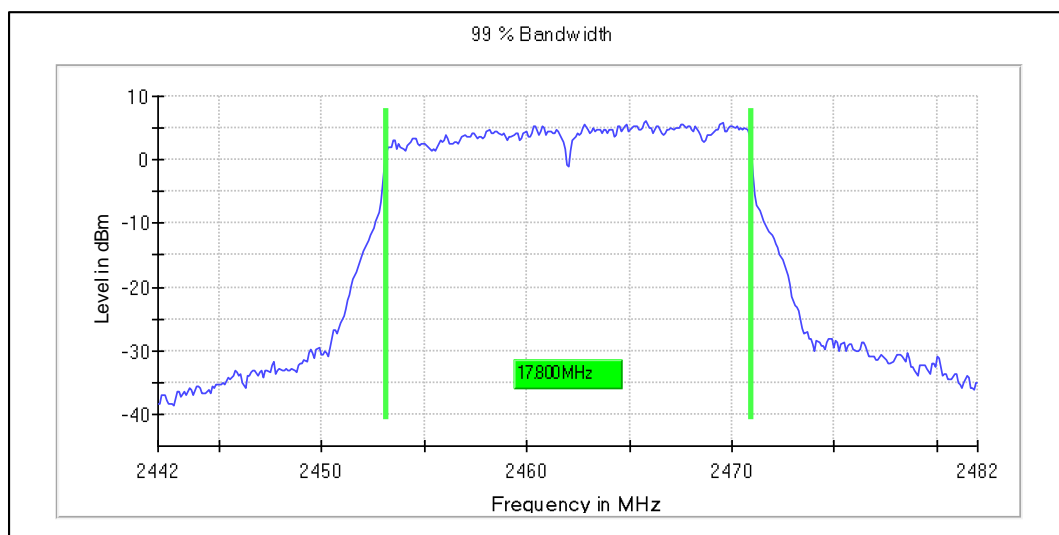

Data Rate: MCS7

Channel Frequency: 2462MHz