

USER MANUAL

WIFI & BT Module

MODEL NO:

HWBPC11AX -PRTM

802.11a/b/g/n/ac/ax

+

BT 5.1

System on Module

CONTENTS

Introduction:	3
Block diagram	5
Technical specifications	6
Recommended operating conditions (MODULE)	6
Operating conditions for WLAN.....	6
Operating conditions for BLUETOOTH.....	7
Footprint (front & back view)	8
Module pin details & configurations	9
Wireless specifications	Error! Bookmark not defined.
WLAN Specifications	11
BLUETOOTH Specifications	17
Antenna Specifications	18
Antenna Recommendations	22
Layout guidelines	23
Agency approvals	24
Labelling guidelines for product	26

INTRODUCTION:

This document specifies the details for a Wi-Fi Module with 802.11a/b/g/n/ac/ax 2x2 MIMO with BT 5.1 RFSOM module called with Honeywell Part No and following are the FCC & IC IDs.

3008-8482-001	PCB S/A, RFSOM Wi-Fi, BT - PC45
---------------	---------------------------------

FCC ID: HD5-PC11AX

IC: 1693B-PC11AX

Model Name: HWBPC11AX-PRTM

This HWBPC11AX-PRTM module is a Wi-Fi, BT system on module which will be placed inside the Honeywell products like printers, barcode scanners, RFID readers etc. to enable wireless connectivity.

This module includes MAC & physical layer of 802.11a/b/g/n/ac/ax and the Bluetooth modem.

This module operates on 3.3VDC Power supply with internal on-board regulation for 3.3vdc for powering ON all the circuits.

The module uses internal power amplifier and LNA for 2.4GHz frequency band and an external front end chip for 5GHz frequency band.

All filters and diplexers are included in the module to ensure maximum power flatness and optimum VSWR. The module has one antenna chain for 2X2 output for Wi-Fi.

The module shall use WM-BAX-BM-57 USI SiP module with Broadcom BCM43752 chipset which includes LNA, switch, and internal power amplifier (iPA) for small form factor and optimum performance. All filters and diplexers will be included in the module to ensure maximum power flatness and optimum VSWR. The module will perform with all legacy hardware having data rates as low as 1Mbps. When running 802.11 ac in 2 x 2 MIMO mode, data rates are expected to reach 1200 Mbps or more.

This chipset also supports concurrent operation of Bluetooth (Version 5.1) for wireless connectivity during browsing or other device applications. Along with both standard and high speed (HS) Bluetooth data rates, Bluetooth low energy modes are also supported.

Hardware WAPI acceleration engine, AES, TKIP, WPA and WPA2 are supported to provide the latest security requirement on your network

The Device communicates with HOST using SDIO interface for WIFI and UART interface for BLUETOOTH.

HWBPC11AX-PRTM – System on Module Features

- IEEE 802.11a/b/g/n/ac/ax 2x2 MIMO
- Bluetooth 5.1 + HS
- Bluetooth-WLAN coexistence
- Wi-Fi Wake on Wireless (WoW)
- 20MHz/40MHz bandwidth at 2.4GHz
- 20/40/80 MHz bandwidth at 5GHz
- Internal PA/LNA
- RF SOM Size: 15 mm x 15 mm, LGA Package
- 802.11 k/v/r
- Low Current consumption in IEEE PS and Deep Sleep
- Wi-Fi Security methods: WPA, WPA2 and TKIP, AES, CCX, WPS
- Wi-Fi + BT Coexistence with simultaneous video streaming over Wi-Fi and voice call over BT
- Supports both WLAN Station mode and WLAN AP mode.

BLOCK DIAGRAM

40 Pin Connector

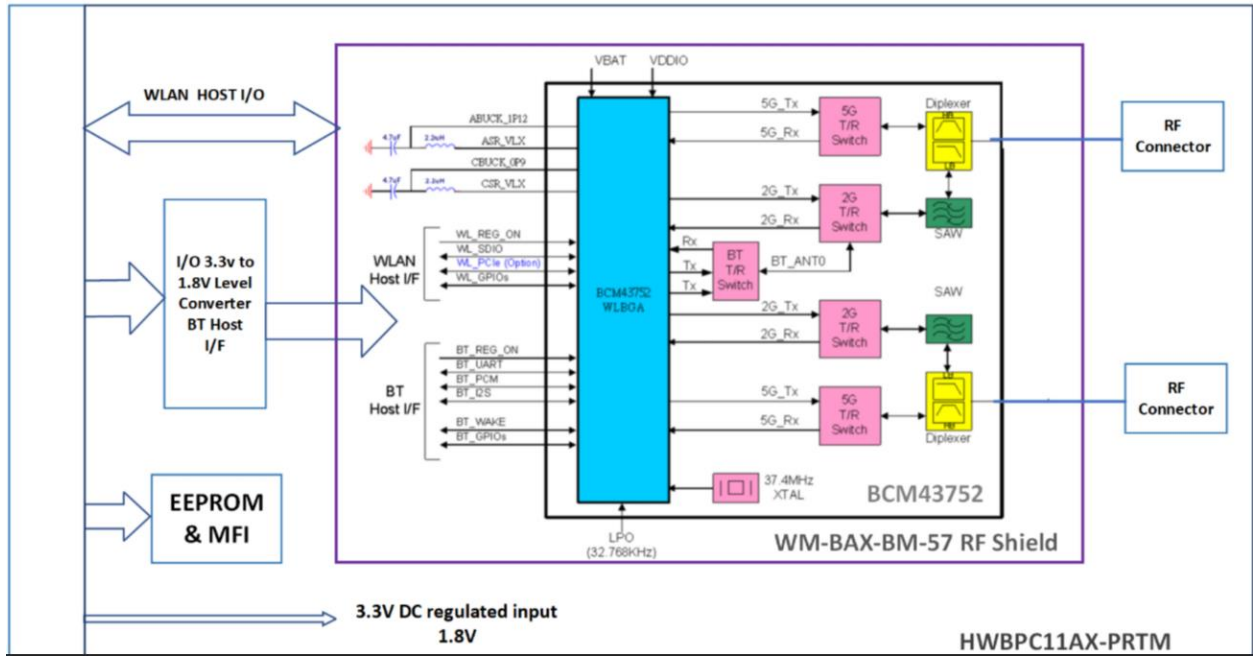

HWBPC11AX-PRTM module is designed based on WM-BAX-BM-57 USI SiP module with Broadcom BCM43752 chipset solution. It supports generic SDIO, UART interface to connect the WLAN/BT to the host processor. A simplified block diagram of the HWBPC11AX-PRTM module is depicted in above picture

TECHNICAL SPECIFICATIONS

RECOMMENDED OPERATING CONDITIONS (MODULE)

Operating Temperature:	-20° to 60°C
Humidity	Max 95% (Non-condensing, relative humidity)
Storage Temperature:	- 30° to +70°C
Power Supply:	+3.3V DC, <2.0 A
I/O Voltage levels	3.3v for Digital IOs, 1.8v for SDIO stream
Current Consumption	As per below Table

OPERATING CONDITIONS FOR WLAN

Condition	Bandwidth (MHz)	Band (GHz)	VBAT	VDDIO	Unit
Off and Sleep Modes					
Off	-	-	0	0.01	mA
Sleep	-	-	0.08	0.09	mA
Active Transmit					
CCK 1 chain	20	2.4	250	4.7	mA
MCS8, Nss 1, HT20, SGI	20	2.4	256	3.3	mA
MCS8, Nss 2, HT20, SGI	20	2.4	360	3.7	mA
MCS7, SGI	20	5	361	3.5	mA
MCS15, SGI	20	5	567	3.7	mA
MCS7	40	5	366	2.6	mA
MCS9, Nss 1, SGI	40	5	370	2.6	mA
MCS9, Nss 2, SGI	40	5	570	2.6	mA
MCS9, Nss 1, SGI	80	5	374	2	mA
MCS9, Nss 2, SGI	80	5	600	2.6	mA
MCS10, Nss 1, SGI	40	5	370	2.1	mA
MCS10, Nss 2, SGI	40	5	700	2.3	mA
MCS10, Nss 1, SGI	80	5	387	1.6	mA
MCS10, Nss 1, SGI	80	5	707	2	mA
MCS11, Nss 1, SGI	40	5	369	2	mA
MCS11, Nss 2, SGI	40	5	687	2.2	mA
MCS11, Nss 1, SGI	80	5	380	1.6	mA
MCS11, Nss 2, SGI	80	5	711	1.9	mA

Active Receive					
1 Mbps, 1 RX core	20	2.4	57.4	0.91	mA
1 Mbps, 2 RX cores	20	2.4	67	1.31	mA
MCS7, HT20 1 RX core	20	2.4	59.8	0.91	mA
MCS7, HT20 2 RX cores	20	2.4	71.7	1.31	mA
MCS15, HT20	20	2.4	72.1	1.33	mA
MCS7, SGI 1 RX core	20	5	68.1	1.21	mA
MCS7, SGI 2 RX core	20	5	86.2	1.3	mA
MCS15, SGI	20	5	86.1	1.3	mA
MCS7, SGI 1 RX core	40	5	73.1	1.2	mA
MCS7, SGI 2 RX core	40	5	97	1.28	mA
MCS15, SGI	40	5	96	1.28	mA
MCS9, Nss 1, SGI 1 RX core	80	5	83.5	1.19	mA
MCS9, Nss 1, SGI 2 RX cores	80	5	109.9	1.27	mA
MCS10, Nss 1, SGI 1 RX core	80	5	84.4	0.9	mA
MCS10, Nss 1, SGI 2 RX core	80	5	115.7	1	mA
MCS11, Nss 1, SGI 1 RX core	80	5	84.9	0.9	mA
MCS11, Nss 1, SGI 2 RX core	80	5	124.5	1.2	mA

OPERATING CONDITIONS FOR BLUETOOTH

Operating Mode	Normal-Power TX Mode		High-Power TX Mode		Unit
	VBAT	VDDIO	VBAT	VDDIO	
Sleep	40	75	40	75	uA
Standard 1.28s inquiry scan	270	85	270	85	uA
500 ms sniff master	440	110	480	110	uA
DM1/DH1	14.5	0.32	42.5	0.32	mA
DM3/DH3	17.9	0.34	56.5	0.34	mA
DM5/DH5	18.3	0.35	57.8	0.35	mA
3DH5 master	16.8	0.43	79.7	0.43	mA
SCO HV3 master	6.6	0.31	16.5	0.31	mA
BLE 1.28 second scan	270	85	270	85	mA
BLE adv. unconnectable 1s	250	90	290	90	mA
BLE connected 1s	240	90	250	90	mA
Transmit 100% On—Max OP BDR	32.6	0.32	109	0.32	mA

FOOTPRINT (FRONT & BACK VIEW)

Front View



BACK View

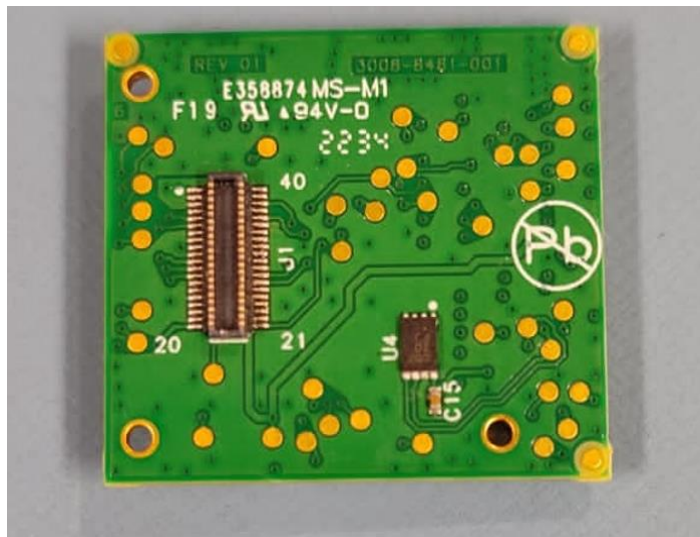

MODULE PIN DETAILS & CONFIGURATIONS

<u>S.No</u>	<u>PINOUT</u>	<u>Signal Type</u>
1	GND	Ground
2	GND	Ground
3	BT_UART_CTS_3V3	Input/Output
4	1.8V Dig I/O PS	Input/Output
5	BT_UART_RTS_3V3	Input/Output
6	BT_HOST_WAKE_3V3	Input/Output
7	BT_UART_TX_3V3	Input/Output
8	EEPROM_SDA	Input/Output
9	BT_UART_RX_3V3	Input/Output
10	EEPROM_SCL	Input/Output
11	BT_EN_3V3	Input/Output
12	WIFI_WAKE_ON_3V3	Input/Output
13	GND	Ground
14	WL_EN_3V3	Input/Output
15	GND	Ground
16	SDIO_CLK	Input/Output
17	GND	Ground
18	SDIO_D3	Input/Output
19	GND	Ground
20	SDIO_D2	Input/Output
21	GND	Ground
22	SDIO_D1	Input/Output
23	GND	Ground
24	SDIO_D0	Input/Output
25	GND	Ground
26	SDIO_CMD	Input/Output
27	5.0v DC Power Supply	5.0v DC Power Supply
28	5.0v DC Power Supply	5.0v DC Power Supply
29	GND	Ground
30	GND	Ground

WIRELESS SPECIFICATIONS

WLAN specifications:

Features	Description
WLAN Standards	IEEE 802 11a/b/g/n/ac/ax
Antenna Port	Support 2x2 MIMO streaming
Frequency Band	2.400 GHz – 2.484 GHz 4.900 GHz – 5.845 GHz*
Number of Sub Channels	1~ 11Channels 36~ 48,52~ 64, 100~ 140, 149~ 165 Channels
Modulation	DSSS, CCK, OFDM, BPSK, QPSK,16QAM, 64QAM, 256QAM, 1024QAM
Supported data rates	1, 2, 5.5, 11 (Mbps) 6, 9, 12, 18, 24, 36, 48, 54 (Mbps) HT20_MCS0 ~ HT20_MCS7 VHT80_MCS0 ~ VHT80_MCS9 HE80_MCS0 ~ HE80_MCS11
<p>*Note: Band 5600 MHz to 5650 MHz is not supported for Canada</p> <p>RESTRICTIONS IN THE 5 GHZ BAND</p> <p>Within the 5.15 to 5.25 GHz band, UNII devices will be restricted to indoor operations only.</p> <p>RESTRICTIONS DANS LA BANDE DE 5 GHZ</p> <p>Dans la bande de 5,15 à 5,25 GHz, les appareils UNII seront restreints aux opérations intérieures.</p>	

BLUETOOTH specifications:

The Radio specification is compliant with the Bluetooth 5.0 + EDR specification

Features	Description
Frequency Band	2400 MHz ~ 2483.5 MHz
Number of Channels	79 channels
Modulation	FHSS (Frequency Hopping Spread Spectrum), GFSK, DPSK
Supported data rates	BLE -1&2 Mbps BT – 1Mbps, 2Mbps, 3Mbps
Antenna Port	Single Antenna for Wi-Fi and BT

WLAN SPECIFICATIONS

Wi-Fi Power Table at 2.4GHz Band.

Channel Bandwidth	Mode	Data rate	Channels	1001932PT (Flex/PCB) Antenna	FPA3020-10A(Flex/PCB) Antenna
20 MHz	b	1	Low	19.00	19.00
			Mid	19.00	19.00
			High	19.00	19.00
		11	Low	19.00	19.00
			Mid	19.00	19.00
			High	19.00	19.00
	g	6	Low	18.00	18.00
			Mid	19.00	19.00
			High	16.00	18.00
		54	Low	17.00	17.00
			Mid	17.00	17.00
			High	17.00	17.00
	n	MCS 0	Low	16.00	19.00
			Mid	19.00	19.00
			High	14.00	17.00
		MCS 7	Low	16.00	16.00
			Mid	16.00	16.00
			High	15.00	16.00
	ac	MCS 0	Low	17.00	19.00
			Mid	19.00	19.00
			High	14.00	17.00
		MCS 8	Low	15.00	15.00
			Mid	15.00	15.00
			High	15.00	15.00
ax	MCS 0	Low	14.00	18.00	
		Mid	19.00	19.00	
		High	14.00	16.00	
	MCS 11	Low	14.00	14.00	
		Mid	14.00	14.00	
		High	14.00	14.00	
40MHz	n	MCS 0	Low	13.00	16.00
			Mid	19.00	19.00
			High	13.00	15.00
		MCS 7	Low	16.00	16.00
			Mid	16.00	19.00
			High	13.00	17.00
	ac	MCS 0	Low	15.00	17.00
			Mid	19.00	19.00
			High	13.00	15.00
		MCS 8	Low	15.00	17.00
			Mid	15.00	19.00
			High	15.00	15.00
	ax	MCS 0	Low	14.00	17.00
			Mid	19.00	19.00
			High	12.00	16.00
		MCS 11	Low	13.00	14.00
			Mid	14.00	14.00
			High	14.00	14.00

Wi-Fi Power Table at 5.GHz Band

Antenna Type: 1001932PT (Flex/PCB Antenna) U.FL Ports

6Mbps		HT20_MCS0		HT40_MCS0		HE40_MCS0	
5180	10	5180	11	5190	10	5190	10
5240	17	5240	17	5230	13	5230	14
5260	17	5260	17	5270	16	5270	16
5320	12	5320	12	5310	13	5310	12
5500	11	5500	11	5510	10	5510	10
5700	11	5700	10	5590	17	5590	17
5720	18	5720	17	5670	12	5670	12
5745	12	5745	16	5710	17	5710	17
5825	18	5825	17	5755	13	5755	13
54Mbps		HT20_MCS7		5795	15	5795	13
5180	12	5180	11	HT40_MCS7		HE40_MCS11	
5240	16	5240	15	5190	10	5190	10
5260	16	5260	15	5230	14	5230	10
5320	12	5320	12	5270	14	5270	10
5500	11	5500	11	5310	13	5310	10
5700	11	5700	10	5510	10	5510	10
5720	16	5720	15	5590	14	5590	10
5745	15	5745	15	5670	12	5670	10
5825	16	5825	14	5710	14	5710	10
VHT20_MCS0		HE20_MCS0		5755	14	5755	10
5180	11	5180	11	5795	14	5795	10
5240	17	5240	17	VHT40_MCS0		VHT80_MCS0	
5260	17	5260	17	5190	10	5210	13
5320	11	5320	12	5230	14	5290	14
5500	11	5500	11	5270	16	5530	11
5700	10	5700	10	5310	13	5690	16
5720	18	5720	17	5510	10	5775	16
5745	12	5745	12	5590	16	VHT40_MCS9	
5825	12	5825	13	5670	12	5210	12
VHT20_MCS9		HE20_MCS11		5710	16	5290	12
5180	11	5180	10	5755	14	5530	11
5240	13	5240	10	5795	14	5690	12
5260	13	5260	10	VHT40_MCS9		5775	12
5320	12	5320	10	5190	10	HE80_MCS0	
5500	11	5500	10	5230	13	5190	13
5700	10	5700	10	5270	13	5230	14
5720	13	5720	10	5310	13	5270	11
5745	13	5745	10	5510	10	5310	16
5825	13	5825	10	5590	13	5510	16
				5670	12	HE80_MCS11	
				5710	13	5210	9
				5755	13	5290	9
				5795	13	5530	9
						5690	9
						5775	9

Antenna Type: FPA3020 - 10 (Flex/PCB Antenna) U.FL Ports

6Mbps		HT20_MCS0		HT40_MCS0		HE40_MCS0	
5180	12	5180	10	5190	10	5190	10
5240	17	5240	17	5230	13	5230	14
5260	17	5260	17	5270	16	5270	16
5320	12	5320	12	5310	13	5310	12
5500	11	5500	11	5510	10	5510	10
5700	11	5700	12	5590	17	5590	17
5720	18	5720	12	5670	12	5670	12
5745	16	5745	12	5710	17	5710	17
5825	16	5825	12	5755	13	5755	13
54Mbps		HT20_MCS7		HT40_MCS7		HE40_MCS11	
5180	12	5180	10	5190	10	5190	10
5240	12	5240	17	5230	14	5230	10
5260	12	5260	17	5270	14	5270	10
5320	12	5320	12	5310	13	5310	10
5500	11	5500	11	5510	10	5510	10
5700	12	5700	12	5590	14	5590	10
5720	16	5720	12	5670	12	5670	10
5745	12	5745	12	5710	14	5710	10
5825	16	5825	12	5755	14	5755	10
VHT20_MCS0		HE20_MCS0		VHT40_MCS0		VHT80_MCS0	
5180	12	5180	12	5190	10	5210	13
5240	12	5240	12	5230	14	5290	14
5260	12	5260	12	5270	14	5530	11
5320	12	5320	12	5310	13	5690	16
5500	12	5500	12	5510	10	5775	16
5700	12	5700	12	5590	16	VHT40_MCS9	
5720	12	5720	12	5670	12	5210	12
5745	14	5745	15	5710	16	5290	12
5825	12	5825	12	5755	14	5530	11
VHT20_MCS9		HE20_MCS11		VHT40_MCS9		HE80_MCS0	
5180	12	5180	12	5190	10	5190	13
5240	12	5240	12	5230	13	5230	14
5260	12	5260	12	5270	13	5270	11
5320	12	5320	12	5310	13	5270	11
5500	12	5500	12	5510	10	5310	16
5700	12	5700	12	5590	13	5510	16
5720	12	5720	12	5670	12	HE80_MCS11	
5745	12	5745	12	5710	13	5210	9
5825	12	5825	12	5755	13	5290	9
				5795	13	5530	9
						5690	9
						5775	9

BT Power Table

Channel Bandwidth	Data rate (Mbps)	Channel Frequency (MHZ)	1001932PT (Flex/PCB) Antenna	FPA3020-10A (Flex/PCB) Antenna
1MHz	1	2402	16.5	16.5
		2440	16.5	16.5
		2480	16.5	16.5
	2	2402	14.0	14.0
		2440	14.0	14.0
		2480	14.0	14.0
	3	2402	14.0	14.0
		2440	14.0	14.0
		2480	14.0	14.0

BLE Power Table

Channel Bandwidth	Data rate (Mbps)	Channels	1001932PT (Flex/PCB) Antenna	FPA3020-10A (Flex/PCB) Antenna
2MHz	1	Low	8	8
		Mid	8	8
		High	8	8
	2	Low	8	8
		Mid	8	8
		High	8	8

2.4GHz802.11BRECEIVER

Item	Condition	Min.	Typ.	Max.	Unit
Receiver Minimum Input Level Sensitivity (PER< 8 %)	11Mbps	-	-88.0	-	dBm
	1Mbps		-96.0	-	dBm
Receiver Maximum Input Level (PER< 8 %)	11Mbps	-10	-	-	dBm
	1Mbps	-10	-	-	dBm

2.4GHz802.11GRECEIVER

Item	Condition	Min.	Typ.	Max.	Unit
Receiver Minimum Input Level Sensitivity (PER< 10 %)	54 Mbps	-	-74.0	-	dBm
	6 Mbps		-91.0	-	dBm
Receiver Maximum Input Level (PER< 10 %)	54 Mbps	-20	-	-	dBm
	6 Mbps	-20	-	-	dBm

2.4GHz802.11N RECEIVER

Item	Condition	Min.	Typ.	Max.	Unit
Receiver Minimum Input Level Sensitivity (PER< 10 %)	MCS7	-	-73.0	-	dBm
	MCS0		-90.0	-	dBm
Receiver Maximum Input Level (PER< 10 %)	MCS7	-20	-	-	dBm
	MCS0	-20	-	-	dBm

2.4GHz802.11ACRECEIVER

Item	Condition	Min.	Typ.	Max.	Unit
Receiver Minimum Input Level Sensitivity (PER< 10 %)	MCS8	-	-70.0	-	dBm
	MCS0		-90.0	-	dBm
Receiver Maximum Input Level (PER< 10 %)	MCS8	-20	-	-	dBm
	MCS0	-20	-	-	dBm

2.4GHz802.11AXRECEIVER

Item	Condition	Min.	Typ.	Max.	Unit
Receiver Minimum Input Level Sensitivity (PER< 10 %)	MCS11	-	-69.0	-	dBm
	MCS0		-90.0	-	dBm
Receiver Maximum Input Level (PER< 10 %)	MCS11	-20	-	-	dBm
	MCS0	-20	-	-	dBm

5GHz 802.11AC 20MHz RECEIVER

Item	Condition	Min.	Typ.	Max.	Unit
Receiver Minimum Input Level Sensitivity (PER< 10 %)	MCS8	-	-70.0	-	dBm
	MCS0		-91.0	-	dBm
Receiver Maximum Input Level (PER< 10 %)	MCS8	-20	-	-	dBm
	MCS0	-20	-	-	dBm

5GHz 802.11AC 40MHz RECEIVER

Item	Condition	Min.	Typ.	Max.	Unit
Receiver Minimum Input Level Sensitivity (PER< 10 %)	MCS9	-	-66.0	-	dBm
	MCS0		-90.0	-	dBm
Receiver Maximum Input Level (PER< 10 %)	MCS9	-20	-	-	dBm
	MCS0	-20	-	-	dBm

5GHz 802.11AC 80MHz RECEIVER

Item	Condition	Min.	Typ.	Max.	Unit
Receiver Minimum Input Level Sensitivity (PER< 10 %)	MCS9	-	-63.0	-	dBm
	MCS0		-90.0	-	dBm
Receiver Maximum Input Level (PER< 10 %)	MCS9	-20	-	-	dBm

5GHz 802.11AX 20MHz RECEIVER

Item	Condition	Min.	Typ.	Max.	Unit
Receiver Minimum Input Level Sensitivity (PER< 10 %)	MCS9	-	-59.0	-	dBm
	MCS0		-90.0	-	dBm
Receiver Maximum Input Level (PER< 10 %)	MCS9	-20	-	-	dBm

5GHz 802.11AX 40MHz RECEIVER

Item	Condition	Min.	Typ.	Max.	Unit
Receiver Minimum Input Level Sensitivity (PER< 10 %)	MCS9	-	-58.0	-	dBm
	MCS0		-89.0	-	dBm
Receiver Maximum Input Level (PER< 10 %)	MCS9	-20	-	-	dBm

5GHz 802.11AX840MHz RECEIVER

Item	Condition	Min.	Typ.	Max.	Unit
Receiver Minimum Input Level Sensitivity (PER< 10 %)	MCS9	-	-55.0	-	dBm
	MCS0		-86.0	-	dBm
Receiver Maximum Input Level (PER< 10 %)	MCS9	-20	-	-	dBm

BLUETOOTH SPECIFICATIONS

Parameter	Conditions	Min.	Typ.	Max	Unit
Basic Rate (Normal Power Mode)					
Frequency Range		2402	...	2480	MHz
Sensitivity (BER)	BER \leq 0.1%		-91.0		dBm
Maximum Input Level	BER \leq 0.1%			-17	dBm
EDR (Normal Power Mode)					
EDR Sensitivity (BER)	$\pi/4$ -DQPSK	...	-93.0		dBm
	BER \leq 0.01%				
	8DPSK	...	-87.0		dBm
	BER \leq 0.01%				
BLE					
BLE Sensitivity (PER)	PER \leq 30.8%@1MBPS	...	-94.5		dBm
	PER \leq 30.8%@2MBPS				
BLE Maximum Input Level		-17	dBm
Basic Rate (High Power Mode)					
Frequency Range		2402	...	2480	MHz
Sensitivity (BER)	BER \leq 0.1%		-91.0		dBm
Maximum Input Level	BER \leq 0.1%			-17	dBm
EDR (High Power Mode)					
EDR Sensitivity (BER)	$\pi/4$ -DQPSK	...	-93.0		dBm
	BER \leq 0.01%				
	8DPSK	...	-87.0		dBm
	BER \leq 0.01%				

ANTENNA SPECIFICATIONS

Antenna 1: Flex PCB Antenna, Part no: 1001932PT



Electrical Specifications

Typical Performance using 100 mm cable tested on PC-ABS

Frequency	2.400 – 2.485 GHz	5.150 – 5.825 GHz
Peak Gain	2.5 dBi	4.4 dBi
Average Efficiency	60%	71%
VSWR Match	2.0 :1 max	
Feed Point Impedance	50 ohms unbalanced	
Polarization	Linear	
Power Handling	0.5 Watt CW	

Mechanical Specifications & Ordering Part Number

Ordering Part #	1001932PT-AA10L0100	1001932PT-AC10L0100
Dimensions (mm)	35.2 x 8.5 x 0.9 (Height up to 1.80 mm at soldering point)	
Weight (grams)	0.8	0.8
Cable/Connector	Length: 100 Diameter: 1.13 Color: Black Connector: u.FI compatible	Length: 100 Diameter: 1.13 Color: Black Connector: MHF4L
Mounting	Adhesive on bottom side of antenna	
Packaging	PE bags	

VSWR, Efficiency and Peak Gain Plots

Typical Performance using 100 mm cable tested on PC-ABS

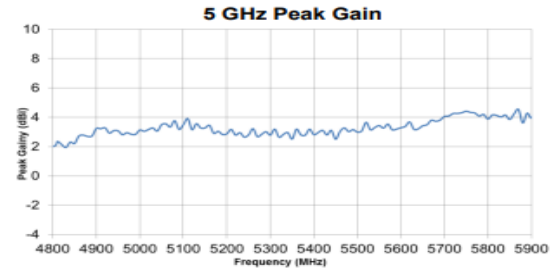
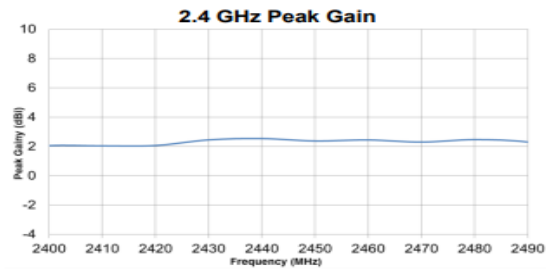
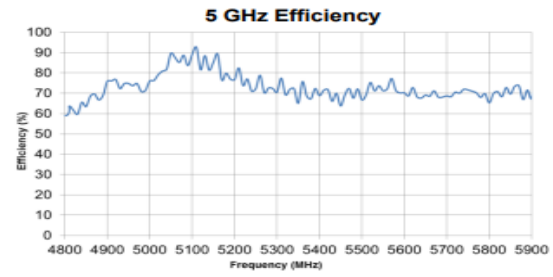
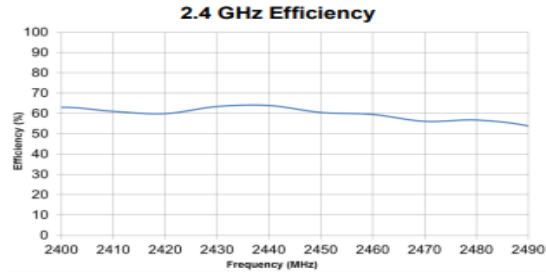
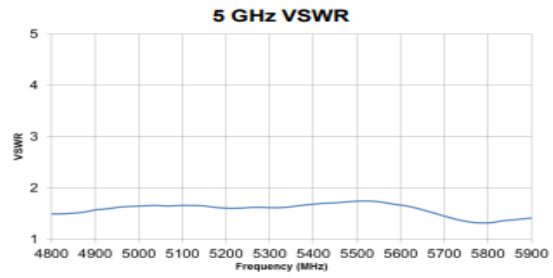
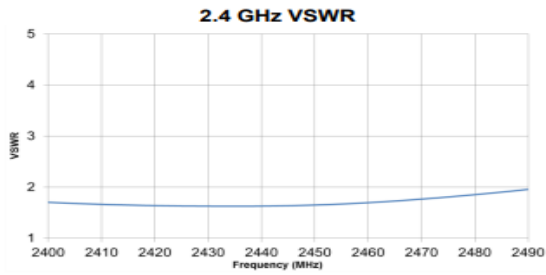

Antenna Radiation Patterns

Typical Performance using 100 mm cable tested on PC-ABS
Measured @ 2440, 5450 MHz

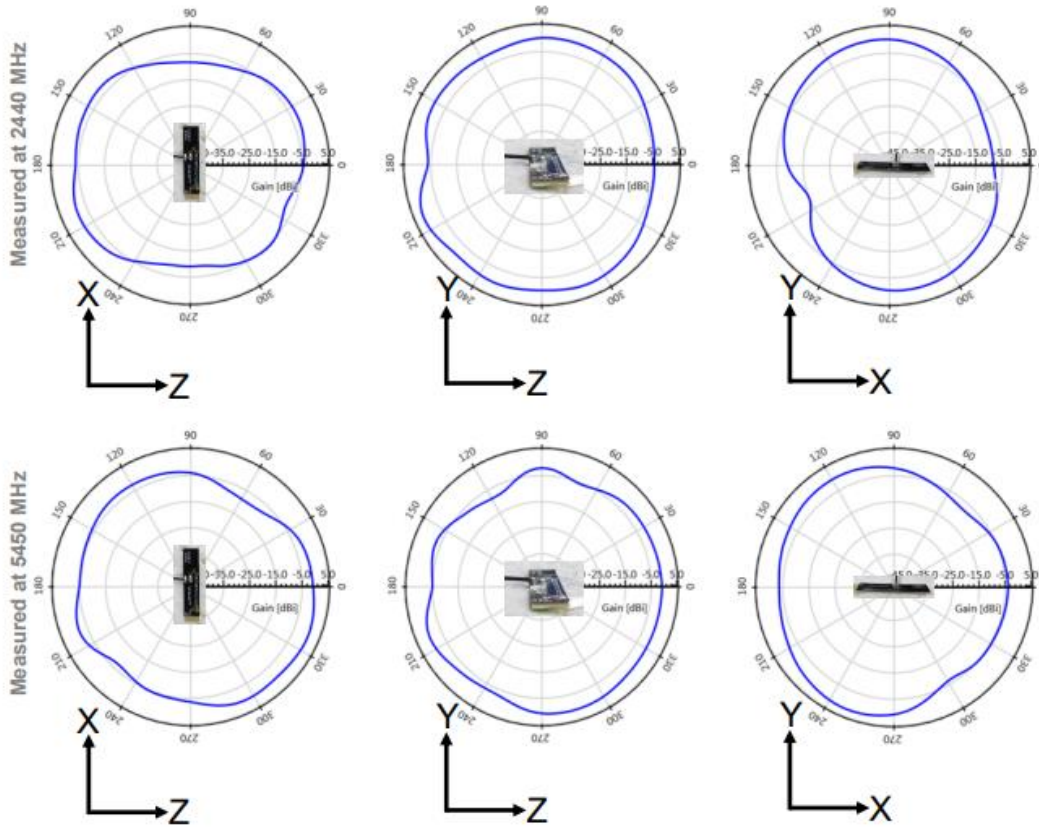

Antenna 3: Flex PCB antenna , Part no: FPA3020-10



2.4GHz : Electrical Characteristics

Frequency	ZX plane		ZY plane		XY plane	
	Max Value	Average	Max Value	Average	Max Value	Average
[MHz]	[dBi]	[dBi]	[dBi]	[dBi]	[dBi]	[dBi]
2400	3.62	-0.79	3.03	-1.32	0.39	-3.24
2450	3.76	-0.25	3.59	-0.49	0.75	-2.87
2500	4.23	-0.65	3.46	-0.39	0.07	-3.44

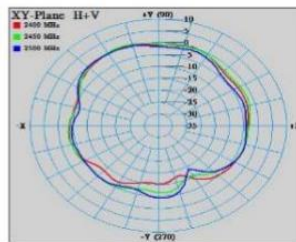
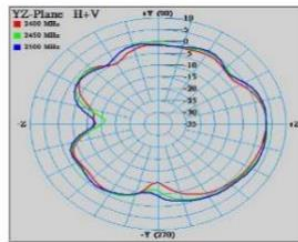
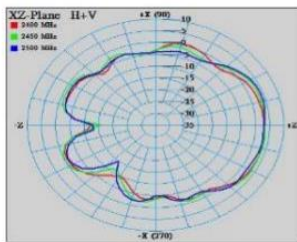

5GHz : Electrical Characteristics

Frequency	ZX plane		ZY plane		XY plane	
	Max Value	Average	Max Value	Average	Max Value	Average
[MHz]	[dBi]	[dBi]	[dBi]	[dBi]	[dBi]	[dBi]
5150	5.56	0.27	5.58	-0.30	2.74	-0.80
5500	5.28	0.61	4.94	-0.96	1.52	-1.33
5850	4.85	-0.84	4.08	-0.93	2.42	-2.22

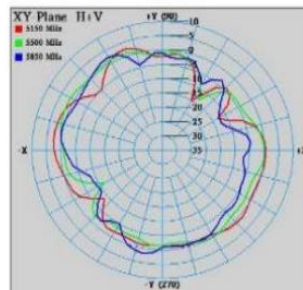
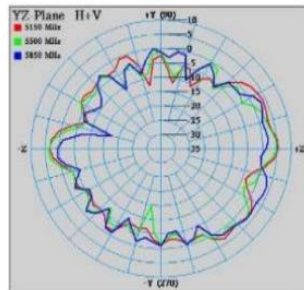
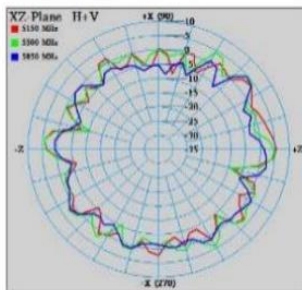

ANTENNA RECOMMENDATIONS

This radio transmitter [IC:1693B-PC11AX] has been approved by Innovation, Science and Economic Development Canada to operate with the antenna types listed above, with the maximum permissible gain indicated. Antenna types not included in this list that have a gain greater than the maximum gain indicated for any type listed are strictly prohibited for use with this device.

— Le présent émetteur radio [IC: 1693B-PC11AX] a été approuvé par Innovation, Sciences et Développement économique Canada pour fonctionner avec les types d'antenne énumérés cidessous et ayant un gain admissible maximal. Les types d'antenne non inclus dans cette liste, et dont le gain est supérieur au gain maximal indiqué pour tout type figurant sur la liste, sont strictement interdits pour l'exploitation de l'émetteur

LAYOUT GUIDELINES

- Do not run antenna cables directly above or directly below the radio module.
- Do not run any high-speed digital lines below the radio.
- Use proper electro-static-discharge (ESD) procedures when installing the HWBPC11AX-PRTM module.
- Use non-conductive labels and to be pasted over the EMI shield provided on the module.

AGENCY APPROVALS



FCC ID: HD5-PC11AX

Model Name: HWBPC11AX-PRTM

This equipment has been tested and found to comply with the limits for a Class B digital device, pursuant to Part 15 of the FCC Rules. These limits are designed to provide reasonable protection against harmful interference in a residential installation.

This equipment generates, uses and can radiate radio frequency energy. However, there is no guarantee that interference will not occur in a installation. If this equipment does cause harmful interference to radio or reception, which can be determined by turning the equipment off and on, the user is encouraged to try to correct the interference by one or more of the following measures:

- Reorient or relocate the receiving antenna.
- Increase the separation between the equipment and receiver.
- Connect the equipment into an outlet on a circuit different from that to which the receiver is connected.
- Consult the dealer or an experienced technician for help.

This device complies with part 15 of the FCC Rules. Operation is subject to the following two conditions:

- 1) This device may not cause harmful interference, and
- 2) This device must accept any interference received, including interference that may cause undesired operation.

Caution:

MODIFICATION: Any changes or modifications not expressly approved by the grantee of this device could void the user's authority to operate the device.

INSTALL & OPERATION: The equipment should be installed and operated with minimum distance 20cm between the radiator & your body

Industry Canada

Model: HWBPC11AX-PRTM

IC: 1693B-PC11AX

This device complies with Industry Canada RSS standard(s). Operation is subject to the following two conditions:

- (1) this device may not cause interference, and
- (2) this device must accept any interference, including interference that may cause undesired operation of the device.

Changes or modifications not expressly approved by the party responsible for compliance could void the user's authority to operate the equipment.

Le présent appareil est conforme aux CNR d'Industrie Canada applicable aux appareils radio

Exemptés de licence. L'exploitation est autorisée aux deux conditions suivantes :

- (1) l'appareil ne doit pas produire de brouillage, et (2) l'utilisateur de l'appareil doit accepter tout brouillage radioélectrique subi, même si le brouillage est susceptible d'en compromettre le fonctionnement."

Cet équipement doit être installé et utilisé avec une distance minimale de 20cm entre le radiateur et votre corps.

Note:

Within the 5.15 to 5.25 GHz band, UNII devices will be restricted to indoor operations only.

Dans la bande de 5,15 à 5,25 GHz, les appareils UNII seront restreints aux opérations intérieures.

LABELLING GUIDELINES FOR PRODUCT

The proposed FCC IC label format is to be placed on the module. If it is not visible when the module is installed into the system, "Contains FCC ID: HD5-PC11AX, Contains IC: 1693B-PC11AX" shall be placed on the outside of final host system.

Étiquetage le format proposé de l'étiquette IC de fac doit être placé sur le module. Si le module n'est pas visible lorsqu'il est installé dans le système, contenant l'ID FCC ID: HD5-PC11AX, contenant l'IC: 1693B-PC11AX doit être placé à l'extérieur du système hôte final.