



# TEST REPORT

**Report Reference No.**..... : **TRE1803002804** R/C.....: 12417  
**FCC ID**..... : **HD5-EDA703**  
**Applicant's name**..... : **Honeywell International Inc**  
Address.....: 9680 Old Bailes Rd, Fort Mill, South Carolina, United States  
Manufacturer.....: Honeywell International Inc  
Address.....: 9680 Old Bailes Rd, Fort Mill, South Carolina, United States  
**Test item description** ..... : **Tablet**  
Trade Mark .....: Honeywell  
Model/Type reference.....: EDA70-3  
Listed Model(s) .....: -  
**Standard** ..... : **FCC CFR Title 47 Part 15 Subpart C Section 15.247**  
Date of receipt of test sample.....: Mar.07,2018  
Date of testing.....: Mar.07,2018- Mar.15,2018  
Date of issue.....: Mar.15,2018  
**Result**.....: **PASS**

Compiled by  
(position+printedname+signature)....: File administrators Candy Liu *Candy Liu*  
Supervised by  
(position+printedname+signature)....: Project Engineer Edward Pan *Edward Pan*  
Approved by  
(position+printedname+signature)....: RF Manager Hans Hu *Hans Hu*

**Testing Laboratory Name** ..... : **Shenzhen Huatongwei International Inspection Co., Ltd.**  
Address.....: 1/F, Bldg 3, Hongfa Hi-tech Industrial Park, Genyu Road,  
Tianliao, Gongming, Shenzhen, China

**Shenzhen Huatongwei International Inspection Co., Ltd. All rights reserved.**

This publication may be reproduced in whole or in part for non-commercial purposes as long as the Shenzhen Huatongwei International Inspection Co., Ltd. is acknowledged as copyright owner and source of the material. Shenzhen Huatongwei International Inspection Co., Ltd. takes no responsibility for and will not assume liability for damages resulting from the reader's interpretation of the reproduced material due to its placement and context.

*The test report merely correspond to the test sample.*

## Contents

|           |   |           |
|-----------|---|-----------|
| <b>1.</b> | <b><u>TEST STANDARDS AND REPORT VERSION</u></b> | <b>3</b>  |
| 1.1.      | Test Standards                                  | 3         |
| 1.2.      | Report version                                  | 3         |
| <b>2.</b> | <b><u>TEST DESCRIPTION</u></b>                  | <b>4</b>  |
| <b>3.</b> | <b><u>SUMMARY</u></b>                           | <b>5</b>  |
| 3.1.      | Client Information                              | 5         |
| 3.2.      | Product Description                             | 5         |
| 3.3.      | Operation state                                 | 6         |
| 3.4.      | EUT configuration                               | 6         |
| 3.5.      | Modifications                                   | 6         |
| <b>4.</b> | <b><u>TEST ENVIRONMENT</u></b>                  | <b>7</b>  |
| 4.1.      | Address of the test laboratory                  | 7         |
| 4.2.      | Test Facility                                   | 7         |
| 4.3.      | Environmental conditions                        | 8         |
| 4.4.      | Statement of the measurement uncertainty        | 8         |
| 4.5.      | Equipments Used during the Test                 | 9         |
| <b>5.</b> | <b><u>TEST CONDITIONS AND RESULTS</u></b>       | <b>11</b> |
| 5.1.      | Antenna requirement                             | 11        |
| 5.2.      | Conducted Emissions (AC Main)                   | 12        |
| 5.3.      | Conducted Peak Output Power                     | 15        |
| 5.4.      | Power Spectral Density                          | 16        |
| 5.5.      | 6dB bandwidth                                   | 20        |
| 5.6.      | Restricted band                                 | 24        |
| 5.7.      | Band edge and Spurious Emissions (conducted)    | 31        |
| 5.8.      | Spurious Emissions (radiated)                   | 44        |
| <b>6.</b> | <b><u>TEST SETUP PHOTOS</u></b>                 | <b>50</b> |
| <b>7.</b> | <b><u>EXTERANAL AND INTERNAL PHOTOS</u></b>     | <b>51</b> |

# **1. TEST STANDARDS AND REPORT VERSION**

## **1.1. Test Standards**

The tests were performed according to following standards:

[FCC Rules Part 15.247](#): Frequency Hopping, Direct Spread Spectrum and Hybrid Systems that are in operation within the bands of 902-928 MHz, 2400-2483.5 MHz, and 5725-5850 MHz.

[ANSI C63.10:2013](#): American National Standard for Testing Unlicensed Wireless Devices

[KDB 558074 D01 DTS Meas Guidance v04](#): Guidance for Performing Compliance Measurements on Digital Transmission Systems (DTS) Operating under §15.247

## **1.2. Report version**

| Version No. | Date of issue | Description |
|-------------|---------------|-------------|
| 00          | Mar.15,2018   | Original    |
|             |               |             |
|             |               |             |
|             |               |             |
|             |               |             |

## **2. TEST DESCRIPTION**

| <b>Test Item</b>                   | <b>FCC Rule</b>  | <b>Result</b> | <b>Test Engineer</b> |
|------------------------------------|------------------|---------------|----------------------|
| Antenna requirement                | 15.203/15.247(c) | PASS          | Zhaohui ouyang       |
| Line Conducted Emissions (AC Main) | 15.207           | PASS          | Alex Guo             |
| Conducted Peak Output Power        | 15.247(b)(3)     | PASS          | Zhaohui ouyang       |
| Power Spectral Density             | 15.247(e)        | PASS          | Zhaohui ouyang       |
| 6dB Bandwidth                      | 15.247(a)(2)     | PASS          | Zhaohui ouyang       |
| Restricted band                    | 15.247(d)/15.205 | PASS          | Zhaohui ouyang       |
| Spurious Emissions                 | 15.247(d)/15.209 | PASS          | Zhaohui ouyang       |

Note: The measurement uncertainty is not included in the test result.

### 3. SUMMARY

#### 3.1. Client Information

|               |  |
|---------------|--|
| Applicant:    | Honeywell International Inc                                  |
| Address:      | 9680 Old Bailes Rd, Fort Mill, South Carolina, United States |
| Manufacturer: | Honeywell International Inc                                  |
| Address:      | 9680 Old Bailes Rd, Fort Mill, South Carolina, United States |

#### 3.2. Product Description

|                      |   |
|----------------------|---|
| Name of EUT:         | Tablet  |
| Trade Mark:          | Honeywell   |
| Model No.:           | EDA70-3   |
| Listed Model(s):     | -   |
| IMEI:                | Conducted: 35893608074936<br>Radiated: 358936080077343  |
| Power supply:        | DC 3.8V   |
| Adapter information: | Input:100-240Va.c.,50/60Hz,0.30A<br>Output: 5Vd.c.,2.0A |
| Hardware version:    | IDH53_MB_V2.0.1   |
| Software version:    | 209.01.00.0002  |
| <b>WIFI</b>          |   |
| Supported type:      | 802.11b/802.11g/802.11n(HT20)                           |
| Modulation:          | DSSS for 802.11b<br>OFDM for 802.11g/802.11n(HT20)      |
| Operation frequency: | 2412MHz~2462MHz   |
| Channel number:      | 11  |
| Channel separation:  | 5MHz  |
| Antenna type:        | PIFA Antenna  |
| Antenna gain:        | 3.20dBi   |

### 3.3. Operation state

➤ **Test frequency list**

According to section 15.31(m), regards to the operating frequency range over 10 MHz, must select three channel which were tested. the Lowest frequency, the middle frequency, and the highest frequency of channel were selected to perform the test, please see the above gray bottom.

| 802.11b/g/n(HT20) |                 |
|-------------------|-----------------|
| Channel           | Frequency (MHz) |
| 01                | 2412            |
| 02                | 2417            |
| ...               | ...             |
| 06                | 2437            |
| ...               | ...             |
| 10                | 2457            |
| 11                | 2462            |

➤ **Test mode**

|  |
|--|
| For RF test items  |
| The engineering test program was provided and enabled to make EUT continuous transmit (duty cycle>98%).  |
| For AC power line conducted emissions:   |
| The EUT was set to connect with the WLAN AP under large package sizes transmission.  |
| For Radiated suprious emissions test item:   |
| The engineering test program was provided and enabled to make EUT continuous transmit(duty cycle>98%). The EUT in each of three orthogonal axis emissions had been tested ,but only the worst case (X axis) data Recorded in the report. |

### 3.4. EUT configuration

The following peripheral devices and interface cables were connected during the measurement:

- - supplied by the manufacturer
- - supplied by the lab

|     |               |   |
|-----|---------------|---|
| ○ / | Manufacturer: | / |
|     | Model No.:    | / |
| ○ / | Manufacturer: | / |
|     | Model No.:    | / |

### 3.5. Modifications

No modifications were implemented to meet testing criteria.

## **4. TEST ENVIRONMENT**

### **4.1. Address of the test laboratory**

Laboratory: Shenzhen Huatongwei International Inspection Co., Ltd.

Address: 1/F, Bldg 3, Hongfa Hi-tech Industrial Park, Genyu Road, Tianliao, Gongming, Shenzhen, China

### **4.2. Test Facility**

#### **CNAS-Lab Code: L1225**

Shenzhen Huatongwei International Inspection Co., Ltd. has been assessed and proved to be in compliance with CNAS-CL01 Accreditation Criteria for Testing and Calibration Laboratories (identical to ISO/IEC17025: 2005 General Requirements) for the Competence of Testing and Calibration Laboratories.

#### **A2LA-Lab Cert. No.: 3902.01**

Shenzhen Huatongwei International Inspection Co., Ltd. EMC Laboratory has been accredited by A2LA for technical competence in the field of electrical testing, and proved to be in compliance with ISO/IEC 17025: 2005 General Requirements for the Competence of Testing and Calibration Laboratories and any additional program requirements in the identified field of testing.

#### **FCC-Registration No.: 762235**

Shenzhen Huatongwei International Inspection Co., Ltd. EMC Laboratory has been registered and fully described in a report filed with the FCC (Federal Communications Commission). The acceptance letter from the FCC is maintained in our files.

#### **IC-Registration No.:5377B-1**

Two 3m Alternate Test Site of Shenzhen Huatongwei International Inspection Co., Ltd. has been registered by Certification and Engineering Bureau of Industry Canada for the performance of radiated measurements with Registration No.: 5377B-1.

#### **ACA**

Shenzhen Huatongwei International Inspection Co., Ltd. EMC Laboratory can also perform testing for the Australian C-Tick mark as a result of our A2LA accreditation.

### 4.3. Environmental conditions

During the measurement the environmental conditions were within the listed ranges:

|                    |             |
|--------------------|-------------|
| Temperature:       | 15~35°C     |
| Relative Humidity: | 30~60 %     |
| Air Pressure:      | 950~1050mba |

### 4.4. Statement of the measurement uncertainty

The data and results referenced in this document are true and accurate. The reader is cautioned that there may be errors in calibration limits of the equipment and facilities. The measurement uncertainty was calculated for all measurements listed in this test report according to TR-100028-01 "Electromagnetic compatibility and Radio spectrum Matters (ERM); Uncertainties in the measurement of mobile radio equipment characteristics; Part 1" and TR-100028-02 "Electromagnetic compatibility and Radio spectrum Matters (ERM); Uncertainties in the measurement of mobile radio equipment characteristics; Part 2" and is documented in the Shenzhen Huatongwei International Inspection Co., Ltd. quality system according to ISO/IEC 17025. Furthermore, component and process variability of devices similar to that tested may result in additional deviation. The manufacturer has the sole responsibility of continued compliance of the device.

Here after the best measurement capability for Shenzhen Huatongwei International Inspection Co., Ltd. is reported:

| Test Items                              | Measurement Uncertainty | Notes |
|---|-------------------------|-------|
| Transmitter power conducted             | 0.57 dB                 | (1)   |
| Transmitter power Radiated              | 2.20 dB                 | (1)   |
| Conducted spurious emissions 9kHz~40GHz | 1.60 dB                 | (1)   |
| Radiated spurious emissions 9kHz~40GHz  | 2.20 dB                 | (1)   |
| Conducted Emissions 9kHz~30MHz          | 3.39 dB                 | (1)   |
| Radiated Emissions 30~1000MHz           | 4.24 dB                 | (1)   |
| Radiated Emissions 1~18GHz              | 5.16 dB                 | (1)   |
| Radiated Emissions 18~40GHz             | 5.54 dB                 | (1)   |

(1) This uncertainty represents an expanded uncertainty expressed at approximately the 95% confidence level using a coverage factor of  $k=1.96$ .



#### 4.5. Equipments Used during the Test

| Conducted Emissions |                     |              |           |            |                      |                      |
|---------------------|---------------------|--------------|-----------|------------|----------------------|----------------------|
| Item                | Test Equipment      | Manufacturer | Model No. | Serial No. | Last Cal. (mm-dd-yy) | Next Cal. (mm-dd-yy) |
| 1                   | EMI Test Receiver   | R&S          | ESCI      | 101247     | 11/11/2017           | 11/10/2018           |
| 2                   | Artificial Mains    | SCHWARZBECK  | NNLK 8121 | 573        | 11/11/2017           | 11/10/2018           |
| 3                   | 2-Line V-Network    | R&S          | ESH3-Z5   | 100049     | 11/11/2017           | 11/10/2018           |
| 4                   | Pulse Limiter       | R&S          | ESH3-Z2   | 101488     | 11/11/2017           | 11/10/2018           |
| 5                   | RF Connection Cable | HUBER+SUHNER | EF400     | N/A        | 11/21/2017           | 11/20/2018           |
| 6                   | Test Software       | R&S          | ES-K1     | N/A        | N/A                  | N/A                  |

| Radiated Emissions |                         |                              |           |            |                      |                      |
|--------------------|-------------------------|------------------------------|-----------|------------|----------------------|----------------------|
| Item               | Test Equipment          | Manufacturer                 | Model No. | Serial No. | Last Cal. (mm-dd-yy) | Next Cal. (mm-dd-yy) |
| 1                  | EMI Test Receiver       | R&S                          | ESCI      | 101247     | 11/11/2017           | 11/10/2018           |
| 2                  | Loop Antenna            | R&S                          | HFH2-Z2   | 100020     | 11/20/2017           | 11/19/2018           |
| 3                  | Ultra-Broadband Antenna | SCHWARZBECK                  | VULB9163  | 538        | 4/5/2017             | 4/4/2020             |
| 4                  | Preamplifier            | SCHWARZBECK                  | BBV 9743  | 9743-0022  | 10/18/2017           | 10/17/2018           |
| 5                  | RF Connection Cable     | HUBER+SUHNER                 | RE-7-FL   | N/A        | 11/21/2017           | 11/20/2018           |
| 6                  | EMI Test Software       | R&S                          | ESK1      | N/A        | N/A                  | N/A                  |
| 7                  | Spectrum Analyzer       | R&S                          | FSP40     | 100597     | 11/11/2017           | 11/10/2018           |
| 8                  | Horn Antenna            | SCHWARZBECK                  | 9120D     | 1011       | 3/27/2017            | 3/26/2020            |
| 9                  | Horn Antenna            | SCHWARZBECK                  | BBHA9170  | 25841      | 3/27/2017            | 3/26/2018            |
| 10                 | Broadband Preamplifier  | SCHWARZBECK                  | BBV 9718  | 9718-248   | 10/18/2017           | 10/17/2018           |
| 11                 | High pass filter        | Compliance Direction systems | BSU-6     | 34202      | 11/11/2017           | 11/10/2018           |
| 12                 | RF Connection Cable     | HUBER+SUHNER                 | RE-7-FH   | N/A        | 11/21/2017           | 11/20/2018           |
| 13                 | EMI Test Software       | Audix                        | E3        | N/A        | N/A                  | N/A                  |
| 14                 | Turntable               | MATURO                       | TT2.0     | N/A        | N/A                  | N/A                  |
| 15                 | Antenna Mast            | MATURO                       | TAM-4.0-P | N/A        | N/A                  | N/A                  |

| <b>RF Conducted Test</b> |                     |              |           |            |                      |                      |
|--------------------------|---------------------|--------------|-----------|------------|----------------------|----------------------|
| Item                     | Test Equipment      | Manufacturer | Model No. | Serial No. | Last Cal. (mm-dd-yy) | Next Cal. (mm-dd-yy) |
| 1                        | Spectrum Analyzer   | R&S          | FSV40     | 100048     | 11/11/2017           | 11/10/2018           |
| 2                        | EXA Signal Analyzer | Agilent      | N9020A    | 184247     | 9/22/2017            | 9/21/2018            |
| 3                        | Power Meter         | Anritsu      | ML249A    | N/A        | 9/22/2017            | 9/21/2018            |
| 4                        | OSP                 | R&S          | OSP120    | 101317     | N/A                  | N/A                  |

## 5. TEST CONDITIONS AND RESULTS

### 5.1. Antenna requirement

#### REQUIREMENT:

#### **FCC CFR Title 47 Part 15 Subpart C Section 15.203:**

An intentional radiator shall be designed to ensure that no antenna other than that furnished by the responsible party shall be used with the device. The use of a permanently attached antenna or of an antenna that uses a unique coupling to the intentional radiator, the manufacturer may design the unit so that a broken antenna can be replaced by the user, but the use of a standard antenna jack or electrical connector is prohibited.

#### **FCC CFR Title 47 Part 15 Subpart C Section 15.247(c) (1)(i):**

(i) Systems operating in the 2400~2483.5 MHz band that is used exclusively for fixed. Point-to-point operations may employ transmitting antennas with directional gain greater than 6 dBi provided the maximum conducted output power of the intentional radiator is reduced by 1 dB for every 3 dB that the directional gain of the antenna exceeds 6 dBi.

#### TEST RESULTS

Passed       Not Applicable

The directional gain of the antenna less than 6 dBi, please refer to the below antenna photo.

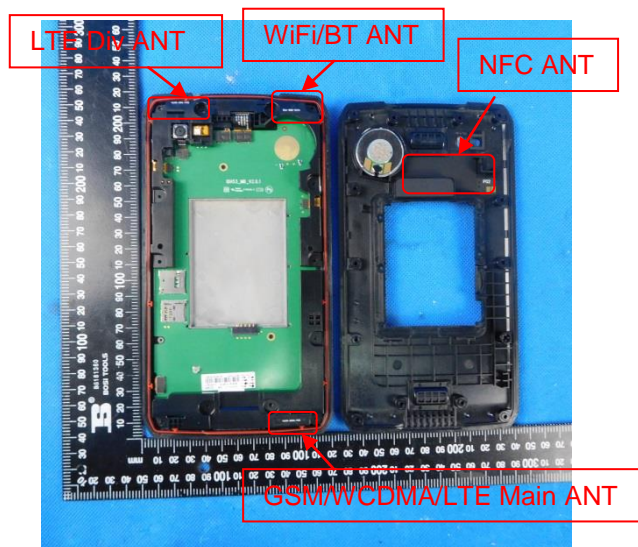

## 5.2. Conducted Emissions (AC Main)

### LIMIT

FCC CFR Title 47 Part 15 Subpart C Section 15.207:

| Frequency range (MHz) | Limit (dBuV) |           |
|-----------------------|--------------|-----------|
|                       | Quasi-peak   | Average   |
| 0.15-0.5              | 66 to 56*    | 56 to 46* |
| 0.5-5                 | 56           | 46        |
| 5-30                  | 60           | 50        |

\* Decreases with the logarithm of the frequency.

### TEST CONFIGURATION

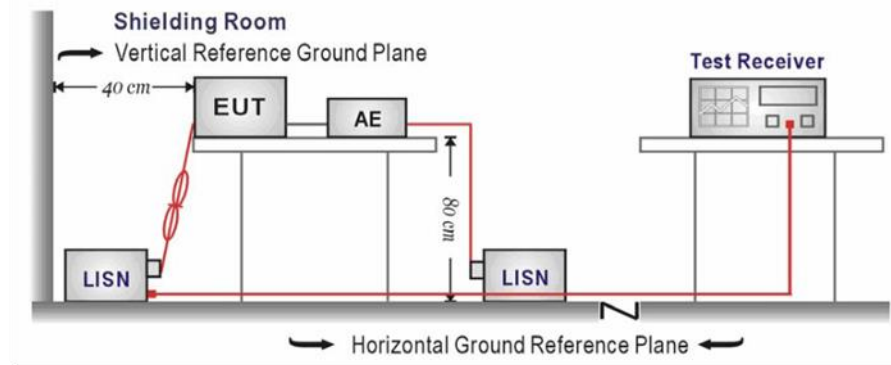

### TEST PROCEDURE

1. The EUT was setup according to ANSI C63.10:2013 requirements.
2. The EUT was placed on a platform of nominal size, 1 m by 1.5 m, raised 80 cm above the conducting ground plane. The vertical conducting plane was located 40 cm to the rear of the EUT. All other surfaces of EUT were at least 80 cm from any other grounded conducting surface.
3. The EUT and simulators are connected to the main power through a line impedances stabilization network (LISN). The LISN provides a 50 ohm /50uH coupling impedance for the measuring equipment.
4. The peripheral devices are also connected to the main power through a LISN. (Please refer to the block diagram of the test setup and photographs)
5. Each current-carrying conductor of the EUT power cord, except the ground (safety) conductor, was individually connected through a LISN to the input power source.
6. The excess length of the power cord between the EUT and the LISN receptacle were folded back and forth at the center of the lead to form a bundle not exceeding 40 cm in length.
7. Conducted Emissions were investigated over the frequency range from 0.15MHz to 30MHz using a receiver bandwidth of 9 kHz.
8. During the above scans, the emissions were maximized by cable manipulation.

### TEST MODE:

Please refer to the clause 3.3

### TEST RESULTS

Passed       Not Applicable

Note:

- 1) Transd=Cable lose+ Pulse Limiter Factor + Artificial Mains Factor
- 2) Margin= Limit -Level

Test Line:

L

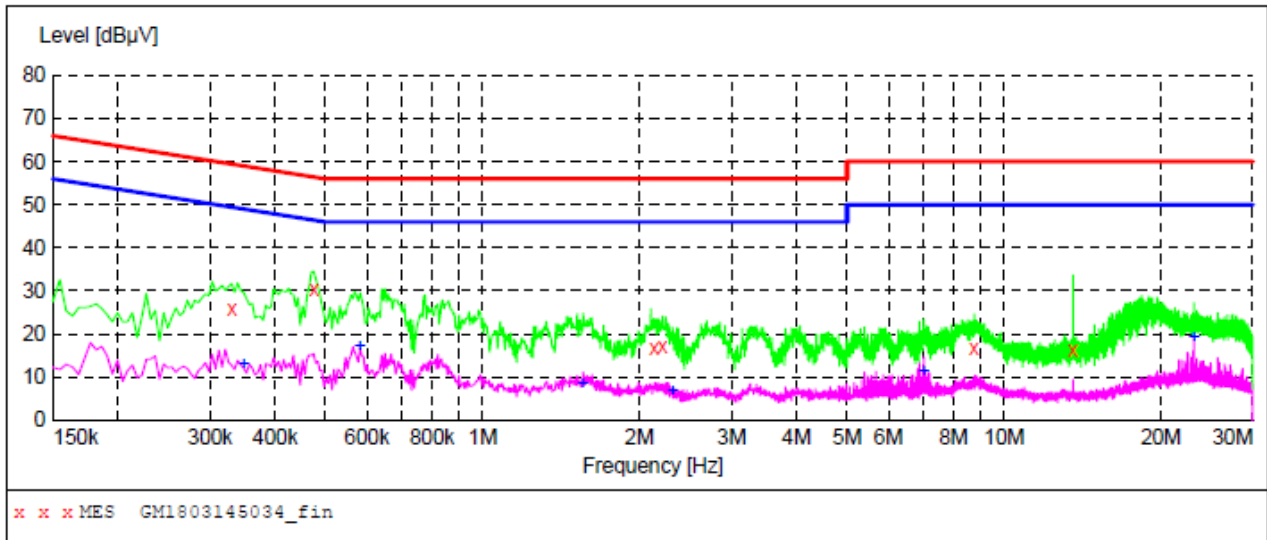

**MEASUREMENT RESULT: "GM1803145034\_fin"**

3/14/2018 2:36PM

| Frequency<br>MHz | Level<br>dBµV | Transd<br>dB | Limit<br>dBµV | Margin<br>dB | Detector | Line | PE  |
|------------------|---------------|--------------|---------------|--------------|----------|------|-----|
| 0.330000         | 25.70         | 9.9          | 60            | 33.8         | QP       | L1   | GND |
| 0.474000         | 30.40         | 9.9          | 56            | 26.0         | QP       | L1   | GND |
| 2.130000         | 16.70         | 10.1         | 56            | 39.3         | QP       | L1   | GND |
| 2.211000         | 17.00         | 10.1         | 56            | 39.0         | QP       | L1   | GND |
| 8.758500         | 16.50         | 10.4         | 60            | 43.5         | QP       | L1   | GND |
| 13.551000        | 16.10         | 10.5         | 60            | 43.9         | QP       | L1   | GND |

**MEASUREMENT RESULT: "GM1803145034\_fin2"**

3/14/2018 2:36PM

| Frequency<br>MHz | Level<br>dBµV | Transd<br>dB | Limit<br>dBµV | Margin<br>dB | Detector | Line | PE  |
|------------------|---------------|--------------|---------------|--------------|----------|------|-----|
| 0.348000         | 13.00         | 9.9          | 49            | 36.0         | AV       | L1   | GND |
| 0.582000         | 17.20         | 10.0         | 46            | 28.8         | AV       | L1   | GND |
| 1.554000         | 8.60          | 10.1         | 46            | 37.4         | AV       | L1   | GND |
| 2.310000         | 6.60          | 10.1         | 46            | 39.4         | AV       | L1   | GND |
| 7.017000         | 11.20         | 10.2         | 50            | 38.8         | AV       | L1   | GND |
| 23.127000        | 19.20         | 10.7         | 50            | 30.8         | AV       | L1   | GND |

Test Line:

N

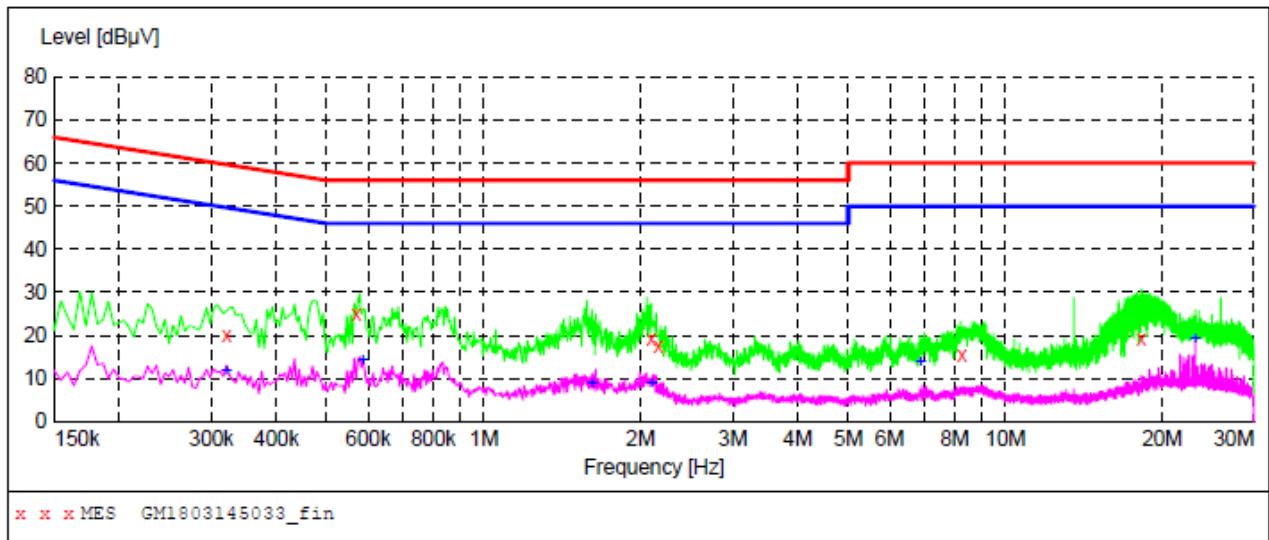

**MEASUREMENT RESULT: "GM1803145033\_fin"**

3/14/2018 2:33PM

| Frequency MHz | Level dBµV | Transd dB | Limit dBµV | Margin dB | Detector | Line | PE  |
|---------------|------------|-----------|------------|-----------|----------|------|-----|
| 0.321000      | 20.00      | 9.9       | 60         | 39.7      | QP       | N    | GND |
| 0.568500      | 24.80      | 10.0      | 56         | 31.2      | QP       | N    | GND |
| 2.094000      | 19.30      | 10.1      | 56         | 36.7      | QP       | N    | GND |
| 2.157000      | 17.70      | 10.1      | 56         | 38.3      | QP       | N    | GND |
| 8.268000      | 15.30      | 10.4      | 60         | 44.7      | QP       | N    | GND |
| 18.226500     | 19.40      | 10.6      | 60         | 40.6      | QP       | N    | GND |

**MEASUREMENT RESULT: "GM1803145033\_fin2"**

3/14/2018 2:33PM

| Frequency MHz | Level dBµV | Transd dB | Limit dBµV | Margin dB | Detector | Line | PE  |
|---------------|------------|-----------|------------|-----------|----------|------|-----|
| 0.321000      | 11.90      | 9.9       | 50         | 37.8      | AV       | N    | GND |
| 0.586500      | 14.30      | 10.0      | 46         | 31.7      | AV       | N    | GND |
| 1.612500      | 8.80       | 10.1      | 46         | 37.2      | AV       | N    | GND |
| 2.098500      | 9.00       | 10.1      | 46         | 37.0      | AV       | N    | GND |
| 6.882000      | 14.00      | 10.2      | 50         | 36.0      | AV       | N    | GND |
| 23.127000     | 19.00      | 10.7      | 50         | 31.0      | AV       | N    | GND |

### 5.3. Conducted Peak Output Power

#### LIMIT

FCC CFR Title 47 Part 15 Subpart C Section 15.247 (b)(3): 30dBm

#### TEST CONFIGURATION

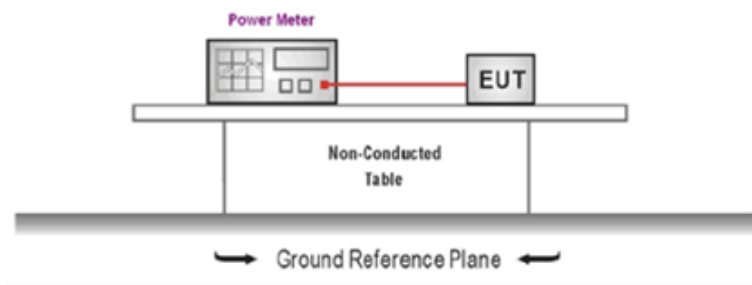

#### TEST PROCEDURE

1. The EUT was tested according to ANSI C63.10: 2013 and KDB 558074 D01 for compliance to FCC 47 CFR 15.247 requirements.
2. The maximum peak conducted output power may be measured using a broadband peak RF power meter.
3. The power meter shall have a video bandwidth that is greater than or equal to the DTS bandwidth and shall utilize a fast-responding diode detector
4. Record the measurement data.

#### TEST MODE:

Please refer to the clause 3.3

#### TEST RESULTS

Passed       Not Applicable

| Type          | Channel | Output power (dBm) | Limit (dBm) | Result |
|---------------|---------|--------------------|-------------|--------|
| 802.11b       | 01      | 19.22              | ≤30.00      | Pass   |
|               | 06      | 19.17              |             |        |
|               | 11      | 18.32              |             |        |
| 802.11g       | 01      | 17.14              | ≤30.00      | Pass   |
|               | 06      | 17.10              |             |        |
|               | 11      | 16.04              |             |        |
| 802.11n(HT20) | 01      | 16.32              | ≤30.00      | Pass   |
|               | 06      | 16.13              |             |        |
|               | 11      | 15.09              |             |        |

### 5.4. Power Spectral Density

#### LIMIT

#### FCC CFR Title 47 Part 15 Subpart C Section 15.247 (e):

For digitally modulated systems, the power spectral density conducted from the intentional radiator to the antenna shall not be greater than 8 dBm in any 3 kHz band during any time interval of continuous transmission.

#### TEST CONFIGURATION

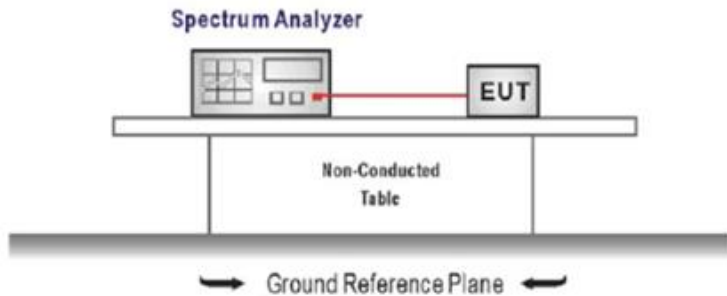

#### TEST PROCEDURE

1. Connect the antenna port(s) to the spectrum analyzer input,
2. Configure the spectrum analyzer as shown below:  
 Center frequency=DTS channel center frequency  
 Span =1.5 times the DTS bandwidth  
 RBW = 3 kHz ≤ RBW ≤ 100 kHz, VBW ≥ 3 × RBW  
 Sweep time = auto couple  
 Detector = peak  
 Trace mode = max hold
3. Place the radio in continuous transmit mode, allow the trace to stabilize, view the transmitter wave form on the spectrum analyzer.
4. Use the peak marker function to determine the maximum amplitude level within the RBW.
5. If measured value exceeds limit, reduce RBW (no less than 3 kHz) and repeat.

#### TEST MODE:

Please refer to the clause 3.3

#### TEST RESULTS

Passed       Not Applicable

| Type          | Channel | Power Spectral Density (dBm/30KHz) | Power Spectral Density (dBm/3KHz) | Limit (dBm/3KHz) | Result |
|---------------|---------|------------------------------------|-----------------------------------|------------------|--------|
| 802.11b       | 01      | 3.89                               | -6.11                             | ≤8.00            | Pass   |
|               | 06      | 4.36                               | -5.64                             |                  |        |
|               | 11      | 3.78                               | -6.22                             |                  |        |
| 802.11g       | 01      | -6.98                              | -16.98                            | ≤8.00            | Pass   |
|               | 06      | -7.10                              | -17.10                            |                  |        |
|               | 11      | -6.89                              | -16.89                            |                  |        |
| 802.11n(HT20) | 01      | -7.66                              | -17.66                            | ≤8.00            | Pass   |
|               | 06      | -7.95                              | -17.95                            |                  |        |
|               | 11      | -8.52                              | -18.52                            |                  |        |

$$PSD(3KHz\ RBW) = PSD(30KHz\ RBW) - 10 \cdot \log(30/3) = PSD(30KHz\ RBW) - 10$$

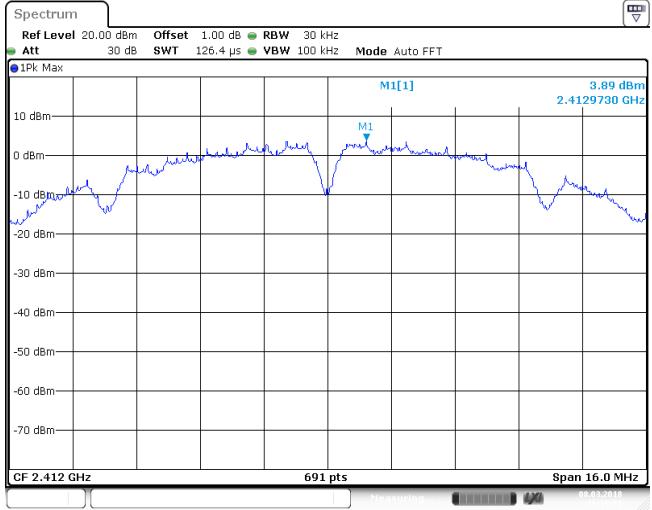
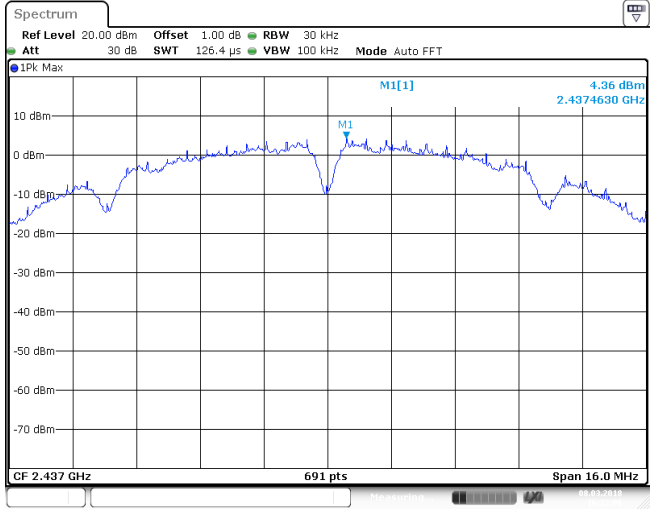
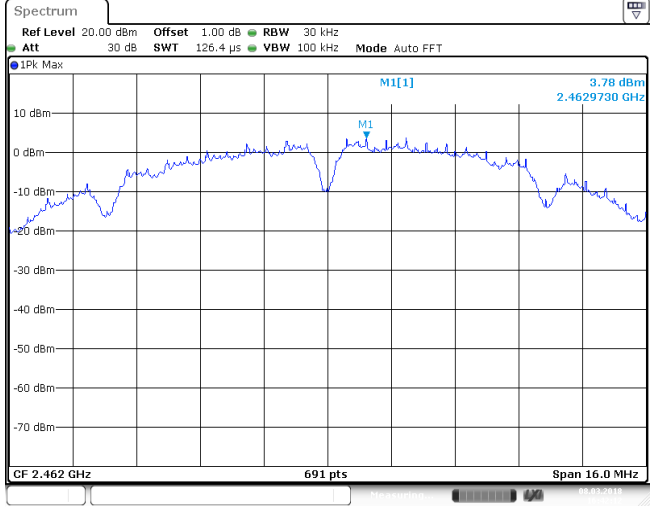

Test plot as follows:

| Type: |  | 802.11 b |
|-------|--|----------|
| CH01  |    |          |
| CH06  |   |          |
| CH11  |  |          |

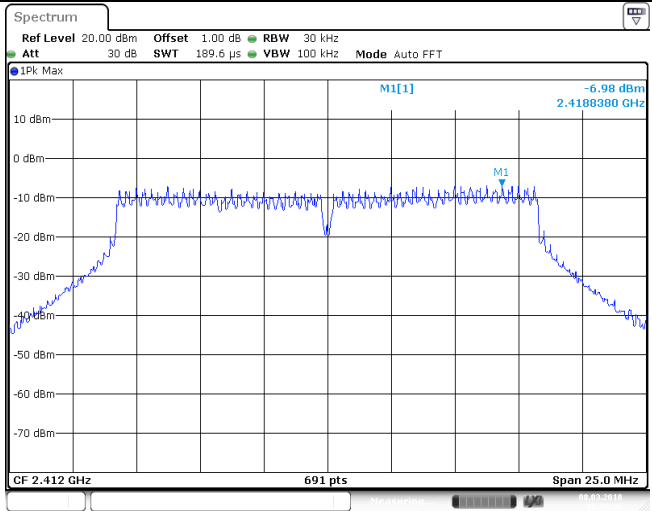
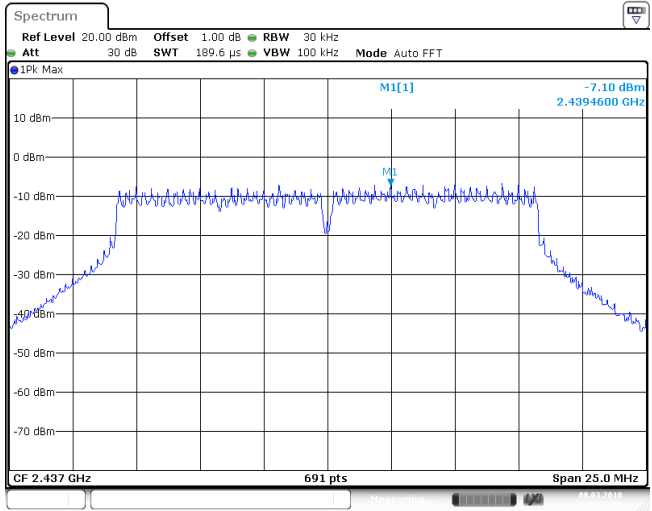
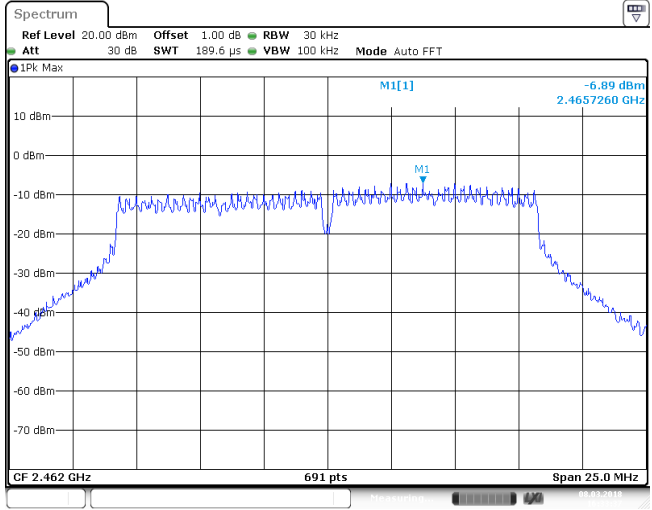
| Type: |  | 802.11 g |
|-------|--|----------|
| CH01  |    |          |
| CH06  |   |          |
| CH11  |  |          |

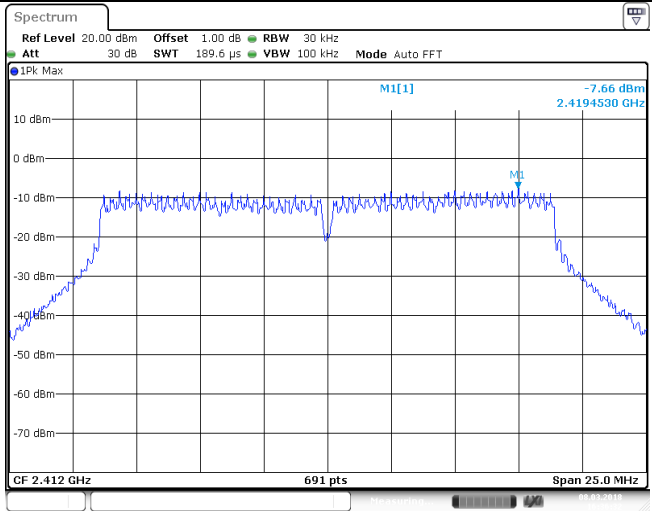
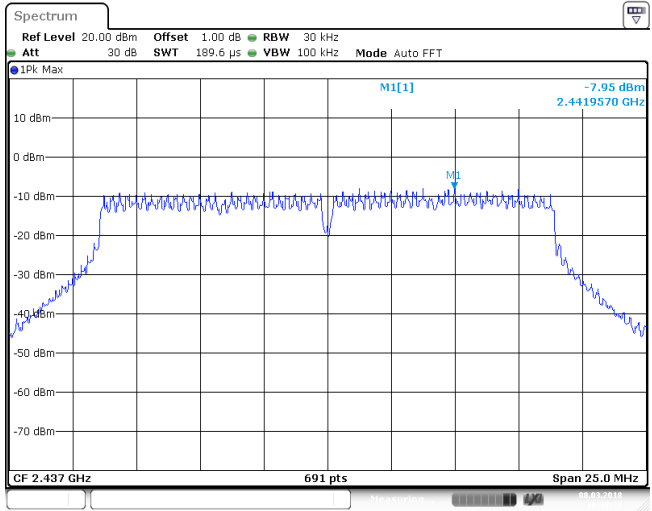
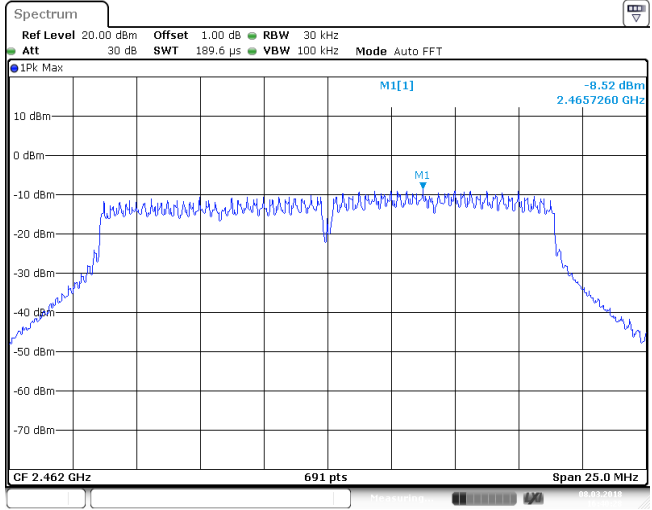
| Type: |  | 802.11n(HT20) |
|-------|--|---------------|
| CH01  |    |               |
| CH06  |   |               |
| CH11  |  |               |

### 5.5. 6dB bandwidth

#### LIMIT

#### **FCC CFR Title 47 Part 15 Subpart C Section 15.247 (a)(2):**

For digital modulation systems, the minimum 6 dB bandwidth shall be at least 500 kHz.

#### TEST CONFIGURATION

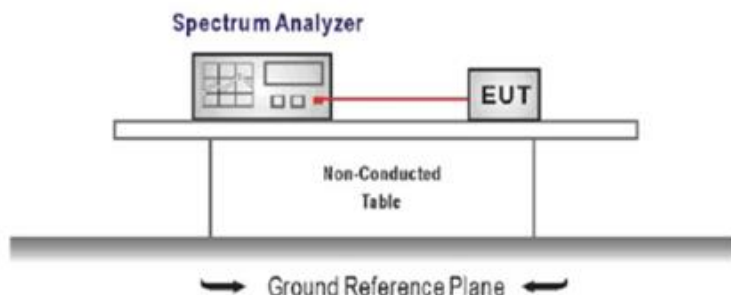

#### TEST PROCEDURE

1. Connect the antenna port(s) to the spectrum analyzer input.
2. Configure the spectrum analyzer as shown below (enter all losses between the transmitter output and the spectrum analyzer).  
 Center Frequency =DTS channel center frequency  
 Span=2 x DTS bandwidth  
 RBW = 100 kHz, VBW ≥ 3 × RBW  
 Sweep time= auto couple  
 Detector = Peak  
 Trace mode = max hold
3. Place the radio in continuous transmit mode, allow the trace to stabilize, view the transmitter wave form on the spectrum analyzer.
4. Measure the maximum width of the emission that is constrained by the frequencies associated with the two outermost amplitude points (upper and lower frequencies) that are attenuated by 6 dB relative to the maximum level measured in the fundamental emission, and record the pertinent measurements.

#### TEST MODE:

Please refer to the clause 3.3

#### TEST RESULTS

Passed       Not Applicable

| Type          | Channel | 6dB Bandwidth (MHz) | Limit (kHz) | Result |
|---------------|---------|---------------------|-------------|--------|
| 802.11b       | 01      | 9.09                | ≥500        | Pass   |
|               | 06      | 9.09                |             |        |
|               | 11      | 9.09                |             |        |
| 802.11g       | 01      | 16.41               | ≥500        | Pass   |
|               | 06      | 16.38               |             |        |
|               | 11      | 15.69               |             |        |
| 802.11n(HT20) | 01      | 17.64               | ≥500        | Pass   |
|               | 06      | 17.64               |             |        |
|               | 11      | 16.86               |             |        |

Test plot as follows:

| Type: | 802.11 b   |      |             |           |          |                 |          |                 |    |  |   |             |           |  |  |    |  |   |             |          |  |  |    |    |   |          |          |  |  |
|-------|--|------|-------------|-----------|----------|-----------------|----------|-----------------|----|--|---|-------------|-----------|--|--|----|--|---|-------------|----------|--|--|----|----|---|----------|----------|--|--|
| CH01  | <p>Spectrum</p> <p>Ref Level 20.50 dBm Offset 1.00 dB RBW 100 kHz<br/>Att 30 dB SWT 75.9 μs VBW 300 kHz Mode Auto FFT</p> <p>IPK View</p> <p>1.40 dBm<br/>2.4079200 GHz<br/>7.58 dBm<br/>2.4129600 GHz</p> <p>D1 1.579 dBm</p> <p>CF 2.412 GHz 1001 pts Span 30.0 MHz</p> <table border="1"> <thead> <tr> <th>Type</th> <th>Ref</th> <th>Trc</th> <th>X-value</th> <th>Y-value</th> <th>Function</th> <th>Function Result</th> </tr> </thead> <tbody> <tr> <td>M1</td> <td></td> <td>1</td> <td>2.40792 GHz</td> <td>1.40 dBm</td> <td></td> <td></td> </tr> <tr> <td>M2</td> <td></td> <td>1</td> <td>2.41296 GHz</td> <td>7.58 dBm</td> <td></td> <td></td> </tr> <tr> <td>D3</td> <td>M1</td> <td>1</td> <td>9.09 MHz</td> <td>-0.17 dB</td> <td></td> <td></td> </tr> </tbody> </table>  | Type | Ref         | Trc       | X-value  | Y-value         | Function | Function Result | M1 |  | 1 | 2.40792 GHz | 1.40 dBm  |  |  | M2 |  | 1 | 2.41296 GHz | 7.58 dBm |  |  | D3 | M1 | 1 | 9.09 MHz | -0.17 dB |  |  |
| Type  | Ref  | Trc  | X-value     | Y-value   | Function | Function Result |          |                 |    |  |   |             |           |  |  |    |  |   |             |          |  |  |    |    |   |          |          |  |  |
| M1    |  | 1    | 2.40792 GHz | 1.40 dBm  |          |                 |          |                 |    |  |   |             |           |  |  |    |  |   |             |          |  |  |    |    |   |          |          |  |  |
| M2    |  | 1    | 2.41296 GHz | 7.58 dBm  |          |                 |          |                 |    |  |   |             |           |  |  |    |  |   |             |          |  |  |    |    |   |          |          |  |  |
| D3    | M1   | 1    | 9.09 MHz    | -0.17 dB  |          |                 |          |                 |    |  |   |             |           |  |  |    |  |   |             |          |  |  |    |    |   |          |          |  |  |
| CH06  | <p>Spectrum</p> <p>Ref Level 20.50 dBm Offset 1.00 dB RBW 100 kHz<br/>Att 30 dB SWT 75.9 μs VBW 300 kHz Mode Auto FFT</p> <p>IPK View</p> <p>-0.06 dBm<br/>2.4324100 GHz<br/>7.45 dBm<br/>2.4364600 GHz</p> <p>D1 1.449 dBm</p> <p>CF 2.437 GHz 1001 pts Span 30.0 MHz</p> <table border="1"> <thead> <tr> <th>Type</th> <th>Ref</th> <th>Trc</th> <th>X-value</th> <th>Y-value</th> <th>Function</th> <th>Function Result</th> </tr> </thead> <tbody> <tr> <td>M1</td> <td></td> <td>1</td> <td>2.43241 GHz</td> <td>-0.06 dBm</td> <td></td> <td></td> </tr> <tr> <td>M2</td> <td></td> <td>1</td> <td>2.43646 GHz</td> <td>7.45 dBm</td> <td></td> <td></td> </tr> <tr> <td>D3</td> <td>M1</td> <td>1</td> <td>9.09 MHz</td> <td>1.51 dB</td> <td></td> <td></td> </tr> </tbody> </table> | Type | Ref         | Trc       | X-value  | Y-value         | Function | Function Result | M1 |  | 1 | 2.43241 GHz | -0.06 dBm |  |  | M2 |  | 1 | 2.43646 GHz | 7.45 dBm |  |  | D3 | M1 | 1 | 9.09 MHz | 1.51 dB  |  |  |
| Type  | Ref  | Trc  | X-value     | Y-value   | Function | Function Result |          |                 |    |  |   |             |           |  |  |    |  |   |             |          |  |  |    |    |   |          |          |  |  |
| M1    |  | 1    | 2.43241 GHz | -0.06 dBm |          |                 |          |                 |    |  |   |             |           |  |  |    |  |   |             |          |  |  |    |    |   |          |          |  |  |
| M2    |  | 1    | 2.43646 GHz | 7.45 dBm  |          |                 |          |                 |    |  |   |             |           |  |  |    |  |   |             |          |  |  |    |    |   |          |          |  |  |
| D3    | M1   | 1    | 9.09 MHz    | 1.51 dB   |          |                 |          |                 |    |  |   |             |           |  |  |    |  |   |             |          |  |  |    |    |   |          |          |  |  |
| CH11  | <p>Spectrum</p> <p>Ref Level 20.50 dBm Offset 1.00 dB RBW 100 kHz<br/>Att 30 dB SWT 75.9 μs VBW 300 kHz Mode Auto FFT</p> <p>IPK View</p> <p>0.30 dBm<br/>2.45792 GHz<br/>7.29 dBm<br/>2.4629600 GHz</p> <p>D1 1.293 dBm</p> <p>CF 2.462 GHz 1001 pts Span 30.0 MHz</p> <table border="1"> <thead> <tr> <th>Type</th> <th>Ref</th> <th>Trc</th> <th>X-value</th> <th>Y-value</th> <th>Function</th> <th>Function Result</th> </tr> </thead> <tbody> <tr> <td>M1</td> <td></td> <td>1</td> <td>2.45792 GHz</td> <td>0.30 dBm</td> <td></td> <td></td> </tr> <tr> <td>M2</td> <td></td> <td>1</td> <td>2.46296 GHz</td> <td>7.29 dBm</td> <td></td> <td></td> </tr> <tr> <td>D3</td> <td>M1</td> <td>1</td> <td>9.09 MHz</td> <td>0.69 dB</td> <td></td> <td></td> </tr> </tbody> </table>     | Type | Ref         | Trc       | X-value  | Y-value         | Function | Function Result | M1 |  | 1 | 2.45792 GHz | 0.30 dBm  |  |  | M2 |  | 1 | 2.46296 GHz | 7.29 dBm |  |  | D3 | M1 | 1 | 9.09 MHz | 0.69 dB  |  |  |
| Type  | Ref  | Trc  | X-value     | Y-value   | Function | Function Result |          |                 |    |  |   |             |           |  |  |    |  |   |             |          |  |  |    |    |   |          |          |  |  |
| M1    |  | 1    | 2.45792 GHz | 0.30 dBm  |          |                 |          |                 |    |  |   |             |           |  |  |    |  |   |             |          |  |  |    |    |   |          |          |  |  |
| M2    |  | 1    | 2.46296 GHz | 7.29 dBm  |          |                 |          |                 |    |  |   |             |           |  |  |    |  |   |             |          |  |  |    |    |   |          |          |  |  |
| D3    | M1   | 1    | 9.09 MHz    | 0.69 dB   |          |                 |          |                 |    |  |   |             |           |  |  |    |  |   |             |          |  |  |    |    |   |          |          |  |  |

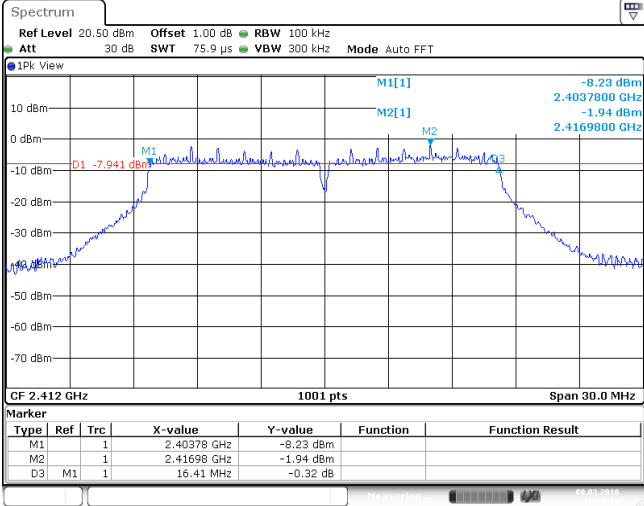
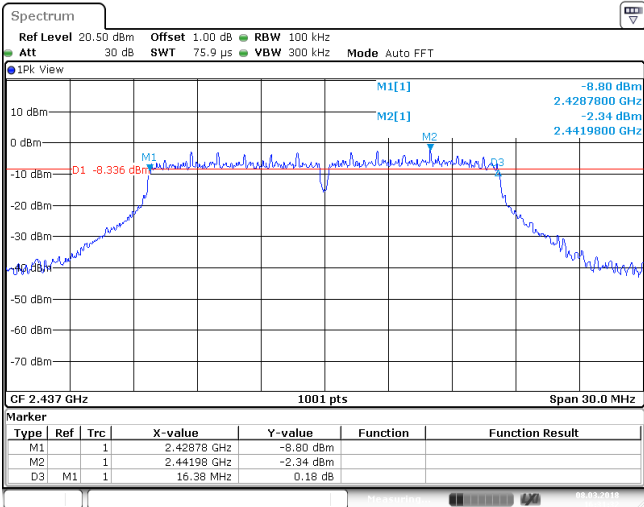
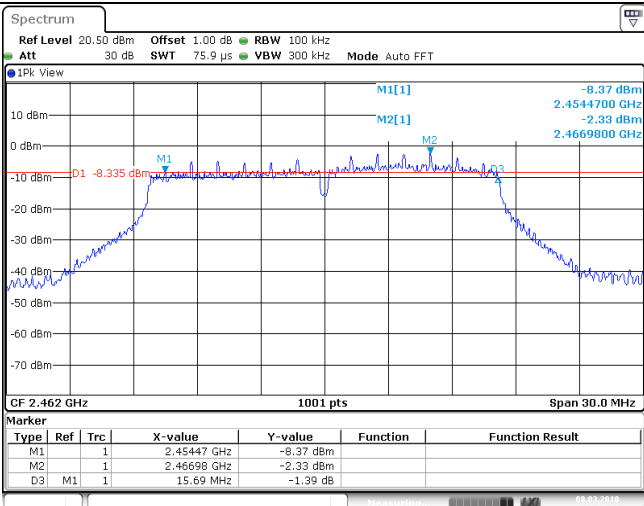
| Type: | 802.11 g  |      |             |           |          |                 |          |                 |    |  |   |             |           |  |  |    |  |   |             |           |  |  |    |    |   |           |          |  |  |
|-------|---|------|-------------|-----------|----------|-----------------|----------|-----------------|----|--|---|-------------|-----------|--|--|----|--|---|-------------|-----------|--|--|----|----|---|-----------|----------|--|--|
| CH01  |  <p><b>Spectrum</b><br/>         Ref Level 20.50 dBm Offset 1.00 dB RBW 100 kHz<br/>         Att 30 dB SWT 75.9 μs VBW 300 kHz Mode Auto FFT</p> <p>IPK View</p> <p>M1[1] -8.23 dBm<br/>         2.4037800 GHz<br/>         M2[1] -1.94 dBm<br/>         2.4169800 GHz</p> <p>D1 -7.941 dBm</p> <p>CF 2.412 GHz 1001 pts Span 30.0 MHz</p> <table border="1"> <thead> <tr> <th>Type</th> <th>Ref</th> <th>Trc</th> <th>X-value</th> <th>Y-value</th> <th>Function</th> <th>Function Result</th> </tr> </thead> <tbody> <tr> <td>M1</td> <td></td> <td>1</td> <td>2.40378 GHz</td> <td>-8.23 dBm</td> <td></td> <td></td> </tr> <tr> <td>M2</td> <td></td> <td>1</td> <td>2.41698 GHz</td> <td>-1.94 dBm</td> <td></td> <td></td> </tr> <tr> <td>D3</td> <td>M1</td> <td>1</td> <td>16.41 MHz</td> <td>-0.32 dB</td> <td></td> <td></td> </tr> </tbody> </table>   | Type | Ref         | Trc       | X-value  | Y-value         | Function | Function Result | M1 |  | 1 | 2.40378 GHz | -8.23 dBm |  |  | M2 |  | 1 | 2.41698 GHz | -1.94 dBm |  |  | D3 | M1 | 1 | 16.41 MHz | -0.32 dB |  |  |
| Type  | Ref   | Trc  | X-value     | Y-value   | Function | Function Result |          |                 |    |  |   |             |           |  |  |    |  |   |             |           |  |  |    |    |   |           |          |  |  |
| M1    |   | 1    | 2.40378 GHz | -8.23 dBm |          |                 |          |                 |    |  |   |             |           |  |  |    |  |   |             |           |  |  |    |    |   |           |          |  |  |
| M2    |   | 1    | 2.41698 GHz | -1.94 dBm |          |                 |          |                 |    |  |   |             |           |  |  |    |  |   |             |           |  |  |    |    |   |           |          |  |  |
| D3    | M1  | 1    | 16.41 MHz   | -0.32 dB  |          |                 |          |                 |    |  |   |             |           |  |  |    |  |   |             |           |  |  |    |    |   |           |          |  |  |
| CH06  |  <p><b>Spectrum</b><br/>         Ref Level 20.50 dBm Offset 1.00 dB RBW 100 kHz<br/>         Att 30 dB SWT 75.9 μs VBW 300 kHz Mode Auto FFT</p> <p>IPK View</p> <p>M1[1] -8.80 dBm<br/>         2.4287800 GHz<br/>         M2[1] -2.34 dBm<br/>         2.4419800 GHz</p> <p>D1 -8.336 dBm</p> <p>CF 2.437 GHz 1001 pts Span 30.0 MHz</p> <table border="1"> <thead> <tr> <th>Type</th> <th>Ref</th> <th>Trc</th> <th>X-value</th> <th>Y-value</th> <th>Function</th> <th>Function Result</th> </tr> </thead> <tbody> <tr> <td>M1</td> <td></td> <td>1</td> <td>2.42878 GHz</td> <td>-8.80 dBm</td> <td></td> <td></td> </tr> <tr> <td>M2</td> <td></td> <td>1</td> <td>2.44198 GHz</td> <td>-2.34 dBm</td> <td></td> <td></td> </tr> <tr> <td>D3</td> <td>M1</td> <td>1</td> <td>16.38 MHz</td> <td>0.18 dB</td> <td></td> <td></td> </tr> </tbody> </table>   | Type | Ref         | Trc       | X-value  | Y-value         | Function | Function Result | M1 |  | 1 | 2.42878 GHz | -8.80 dBm |  |  | M2 |  | 1 | 2.44198 GHz | -2.34 dBm |  |  | D3 | M1 | 1 | 16.38 MHz | 0.18 dB  |  |  |
| Type  | Ref   | Trc  | X-value     | Y-value   | Function | Function Result |          |                 |    |  |   |             |           |  |  |    |  |   |             |           |  |  |    |    |   |           |          |  |  |
| M1    |   | 1    | 2.42878 GHz | -8.80 dBm |          |                 |          |                 |    |  |   |             |           |  |  |    |  |   |             |           |  |  |    |    |   |           |          |  |  |
| M2    |   | 1    | 2.44198 GHz | -2.34 dBm |          |                 |          |                 |    |  |   |             |           |  |  |    |  |   |             |           |  |  |    |    |   |           |          |  |  |
| D3    | M1  | 1    | 16.38 MHz   | 0.18 dB   |          |                 |          |                 |    |  |   |             |           |  |  |    |  |   |             |           |  |  |    |    |   |           |          |  |  |
| CH11  |  <p><b>Spectrum</b><br/>         Ref Level 20.50 dBm Offset 1.00 dB RBW 100 kHz<br/>         Att 30 dB SWT 75.9 μs VBW 300 kHz Mode Auto FFT</p> <p>IPK View</p> <p>M1[1] -8.37 dBm<br/>         2.4544700 GHz<br/>         M2[1] -2.33 dBm<br/>         2.4669800 GHz</p> <p>D1 -8.335 dBm</p> <p>CF 2.462 GHz 1001 pts Span 30.0 MHz</p> <table border="1"> <thead> <tr> <th>Type</th> <th>Ref</th> <th>Trc</th> <th>X-value</th> <th>Y-value</th> <th>Function</th> <th>Function Result</th> </tr> </thead> <tbody> <tr> <td>M1</td> <td></td> <td>1</td> <td>2.45447 GHz</td> <td>-8.37 dBm</td> <td></td> <td></td> </tr> <tr> <td>M2</td> <td></td> <td>1</td> <td>2.46698 GHz</td> <td>-2.33 dBm</td> <td></td> <td></td> </tr> <tr> <td>D3</td> <td>M1</td> <td>1</td> <td>15.69 MHz</td> <td>-1.39 dB</td> <td></td> <td></td> </tr> </tbody> </table> | Type | Ref         | Trc       | X-value  | Y-value         | Function | Function Result | M1 |  | 1 | 2.45447 GHz | -8.37 dBm |  |  | M2 |  | 1 | 2.46698 GHz | -2.33 dBm |  |  | D3 | M1 | 1 | 15.69 MHz | -1.39 dB |  |  |
| Type  | Ref   | Trc  | X-value     | Y-value   | Function | Function Result |          |                 |    |  |   |             |           |  |  |    |  |   |             |           |  |  |    |    |   |           |          |  |  |
| M1    |   | 1    | 2.45447 GHz | -8.37 dBm |          |                 |          |                 |    |  |   |             |           |  |  |    |  |   |             |           |  |  |    |    |   |           |          |  |  |
| M2    |   | 1    | 2.46698 GHz | -2.33 dBm |          |                 |          |                 |    |  |   |             |           |  |  |    |  |   |             |           |  |  |    |    |   |           |          |  |  |
| D3    | M1  | 1    | 15.69 MHz   | -1.39 dB  |          |                 |          |                 |    |  |   |             |           |  |  |    |  |   |             |           |  |  |    |    |   |           |          |  |  |

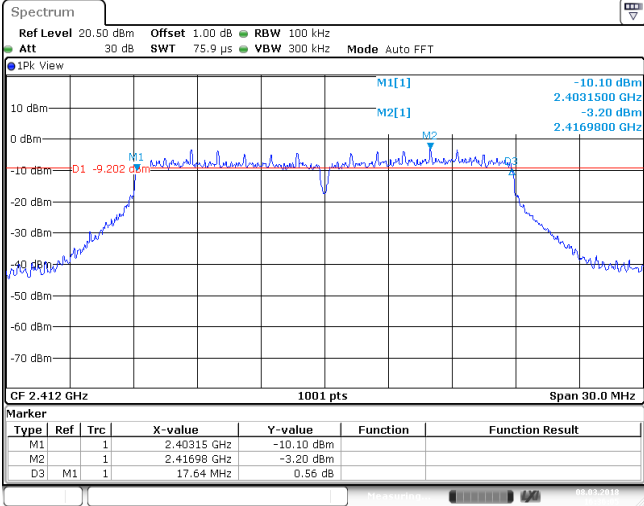
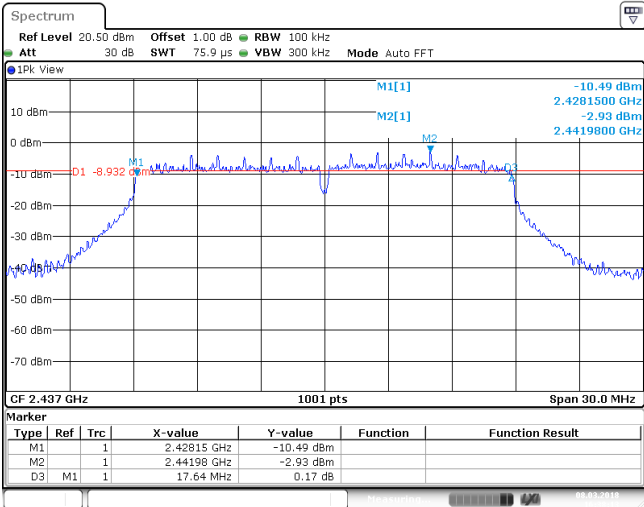
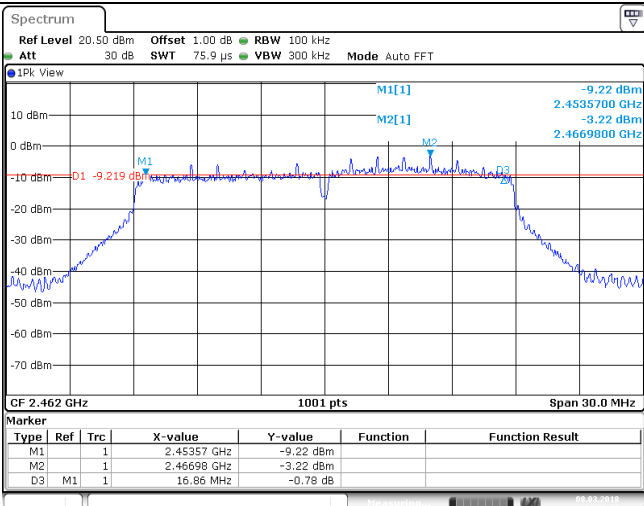
| Type: |  | 802.11n(HT20) |             |            |          |                 |         |          |                 |    |   |  |             |            |  |  |    |   |  |             |           |  |  |    |    |   |           |          |  |  |
|-------|--|---------------|-------------|------------|----------|-----------------|---------|----------|-----------------|----|---|--|-------------|------------|--|--|----|---|--|-------------|-----------|--|--|----|----|---|-----------|----------|--|--|
| CH01  |  <p><b>Spectrum</b><br/>                 Ref Level 20.50 dBm Offset 1.00 dB RBW 100 kHz<br/>                 Att 30 dB SWT 75.9 μs VBW 300 kHz Mode Auto FFT</p> <p>IPK View</p> <p>CF 2.412 GHz 1001 pts Span 30.0 MHz</p> <table border="1"> <thead> <tr> <th>Type</th> <th>Ref</th> <th>Trc</th> <th>X-value</th> <th>Y-value</th> <th>Function</th> <th>Function Result</th> </tr> </thead> <tbody> <tr> <td>M1</td> <td>1</td> <td></td> <td>2.40315 GHz</td> <td>-10.10 dBm</td> <td></td> <td></td> </tr> <tr> <td>M2</td> <td>1</td> <td></td> <td>2.41698 GHz</td> <td>-3.20 dBm</td> <td></td> <td></td> </tr> <tr> <td>D3</td> <td>M1</td> <td>1</td> <td>17.64 MHz</td> <td>0.56 dB</td> <td></td> <td></td> </tr> </tbody> </table>   |               | Type        | Ref        | Trc      | X-value         | Y-value | Function | Function Result | M1 | 1 |  | 2.40315 GHz | -10.10 dBm |  |  | M2 | 1 |  | 2.41698 GHz | -3.20 dBm |  |  | D3 | M1 | 1 | 17.64 MHz | 0.56 dB  |  |  |
| Type  | Ref  | Trc           | X-value     | Y-value    | Function | Function Result |         |          |                 |    |   |  |             |            |  |  |    |   |  |             |           |  |  |    |    |   |           |          |  |  |
| M1    | 1  |               | 2.40315 GHz | -10.10 dBm |          |                 |         |          |                 |    |   |  |             |            |  |  |    |   |  |             |           |  |  |    |    |   |           |          |  |  |
| M2    | 1  |               | 2.41698 GHz | -3.20 dBm  |          |                 |         |          |                 |    |   |  |             |            |  |  |    |   |  |             |           |  |  |    |    |   |           |          |  |  |
| D3    | M1   | 1             | 17.64 MHz   | 0.56 dB    |          |                 |         |          |                 |    |   |  |             |            |  |  |    |   |  |             |           |  |  |    |    |   |           |          |  |  |
| CH06  |  <p><b>Spectrum</b><br/>                 Ref Level 20.50 dBm Offset 1.00 dB RBW 100 kHz<br/>                 Att 30 dB SWT 75.9 μs VBW 300 kHz Mode Auto FFT</p> <p>IPK View</p> <p>CF 2.437 GHz 1001 pts Span 30.0 MHz</p> <table border="1"> <thead> <tr> <th>Type</th> <th>Ref</th> <th>Trc</th> <th>X-value</th> <th>Y-value</th> <th>Function</th> <th>Function Result</th> </tr> </thead> <tbody> <tr> <td>M1</td> <td>1</td> <td></td> <td>2.42815 GHz</td> <td>-10.49 dBm</td> <td></td> <td></td> </tr> <tr> <td>M2</td> <td>1</td> <td></td> <td>2.44198 GHz</td> <td>-2.93 dBm</td> <td></td> <td></td> </tr> <tr> <td>D3</td> <td>M1</td> <td>1</td> <td>17.64 MHz</td> <td>0.17 dB</td> <td></td> <td></td> </tr> </tbody> </table>  |               | Type        | Ref        | Trc      | X-value         | Y-value | Function | Function Result | M1 | 1 |  | 2.42815 GHz | -10.49 dBm |  |  | M2 | 1 |  | 2.44198 GHz | -2.93 dBm |  |  | D3 | M1 | 1 | 17.64 MHz | 0.17 dB  |  |  |
| Type  | Ref  | Trc           | X-value     | Y-value    | Function | Function Result |         |          |                 |    |   |  |             |            |  |  |    |   |  |             |           |  |  |    |    |   |           |          |  |  |
| M1    | 1  |               | 2.42815 GHz | -10.49 dBm |          |                 |         |          |                 |    |   |  |             |            |  |  |    |   |  |             |           |  |  |    |    |   |           |          |  |  |
| M2    | 1  |               | 2.44198 GHz | -2.93 dBm  |          |                 |         |          |                 |    |   |  |             |            |  |  |    |   |  |             |           |  |  |    |    |   |           |          |  |  |
| D3    | M1   | 1             | 17.64 MHz   | 0.17 dB    |          |                 |         |          |                 |    |   |  |             |            |  |  |    |   |  |             |           |  |  |    |    |   |           |          |  |  |
| CH11  |  <p><b>Spectrum</b><br/>                 Ref Level 20.50 dBm Offset 1.00 dB RBW 100 kHz<br/>                 Att 30 dB SWT 75.9 μs VBW 300 kHz Mode Auto FFT</p> <p>IPK View</p> <p>CF 2.462 GHz 1001 pts Span 30.0 MHz</p> <table border="1"> <thead> <tr> <th>Type</th> <th>Ref</th> <th>Trc</th> <th>X-value</th> <th>Y-value</th> <th>Function</th> <th>Function Result</th> </tr> </thead> <tbody> <tr> <td>M1</td> <td>1</td> <td></td> <td>2.45357 GHz</td> <td>-9.22 dBm</td> <td></td> <td></td> </tr> <tr> <td>M2</td> <td>1</td> <td></td> <td>2.46698 GHz</td> <td>-3.22 dBm</td> <td></td> <td></td> </tr> <tr> <td>D3</td> <td>M1</td> <td>1</td> <td>16.86 MHz</td> <td>-0.78 dB</td> <td></td> <td></td> </tr> </tbody> </table> |               | Type        | Ref        | Trc      | X-value         | Y-value | Function | Function Result | M1 | 1 |  | 2.45357 GHz | -9.22 dBm  |  |  | M2 | 1 |  | 2.46698 GHz | -3.22 dBm |  |  | D3 | M1 | 1 | 16.86 MHz | -0.78 dB |  |  |
| Type  | Ref  | Trc           | X-value     | Y-value    | Function | Function Result |         |          |                 |    |   |  |             |            |  |  |    |   |  |             |           |  |  |    |    |   |           |          |  |  |
| M1    | 1  |               | 2.45357 GHz | -9.22 dBm  |          |                 |         |          |                 |    |   |  |             |            |  |  |    |   |  |             |           |  |  |    |    |   |           |          |  |  |
| M2    | 1  |               | 2.46698 GHz | -3.22 dBm  |          |                 |         |          |                 |    |   |  |             |            |  |  |    |   |  |             |           |  |  |    |    |   |           |          |  |  |
| D3    | M1   | 1             | 16.86 MHz   | -0.78 dB   |          |                 |         |          |                 |    |   |  |             |            |  |  |    |   |  |             |           |  |  |    |    |   |           |          |  |  |

## 5.6. Restricted band

### LIMIT

#### **FCC CFR Title 47 Part 15 Subpart C Section 15.247 (d):**

In any 100 kHz bandwidth outside the frequency band in which the spread spectrum or digitally modulated intentional radiator is operating, Radiated Emissions which fall in the restricted bands, as defined in §15.205(a), must also comply with the Radiated Emissions limits specified in §15.209(a) (see §15.205(c)).

### TEST CONFIGURATION

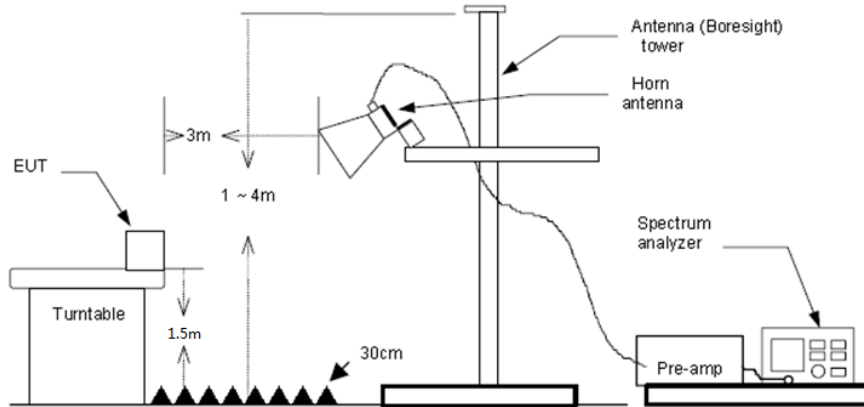

### TEST PROCEDURE

- 1) The EUT was setup and tested according to ANSI C63.10:2013 for compliance to FCC 47CFR 15.247 requirements.
- 2) The EUT is placed on a turn table which is 1.5 meter above ground. The turn table is rotated 360 degrees to determine the position of the maximum emission level.
- 3) The EUT was positioned such that the distance from antenna to the EUT was 3 meters.
- 4) The antenna is scanned from 1 meter to 4 meters to find out the maximum emission level. This is repeated for both horizontal and vertical polarization of the antenna. In order to find the maximum emission, all of the interface cables were manipulated according to ANSI C63.10:2013 on radiated measurement.
- 5) The receiver set as follow:  
 RBW=1MHz, VBW=3MHz PEAK detector for Peak value.  
 RBW=1MHz, VBW=3MHz RMS detector for Average value.

### TEST MODE:

Please refer to the clause 3.3

### TEST RESULTS

Passed       Not Applicable

Note:

- 1) Final level= Read level + Antenna Factor+ Cable Loss- Preamp Factor



802.11b-2412MHz Peak:

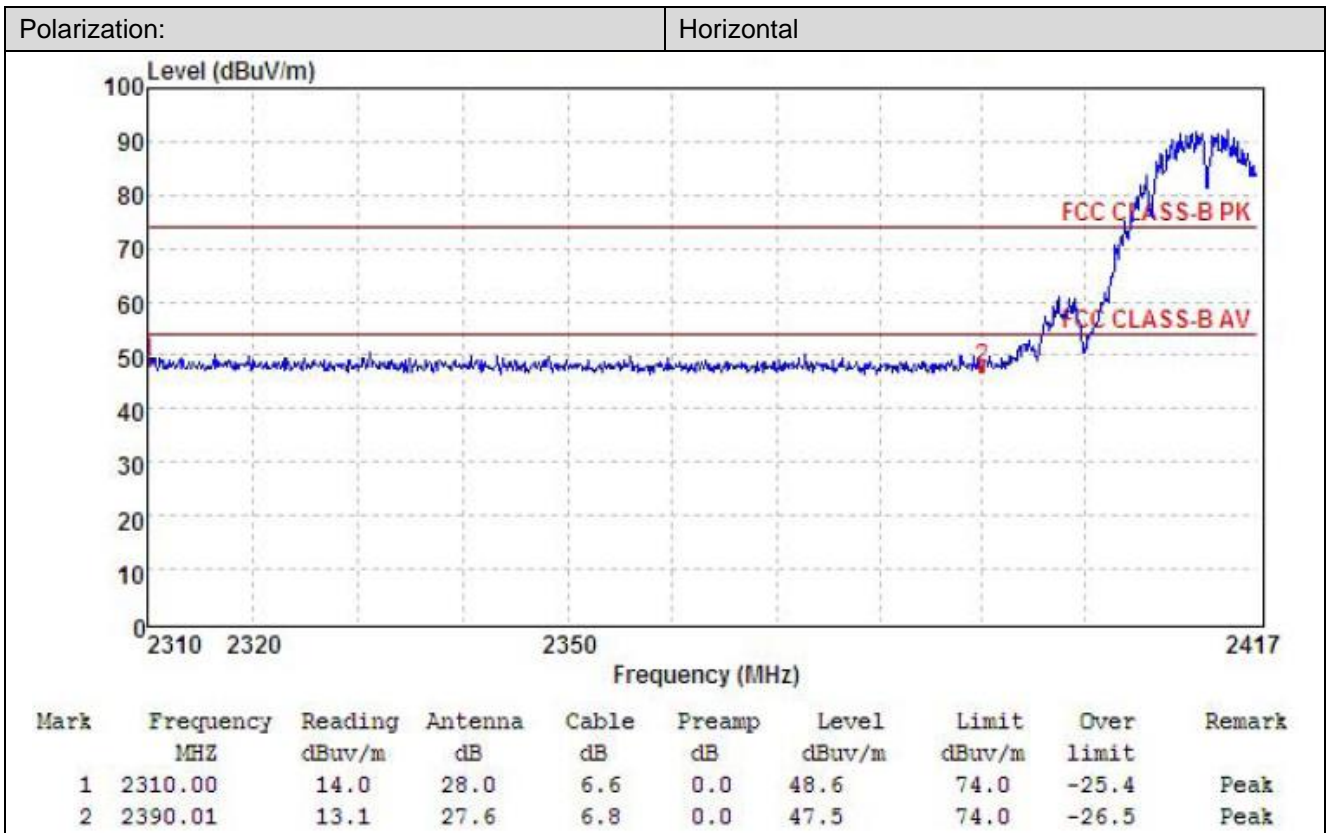
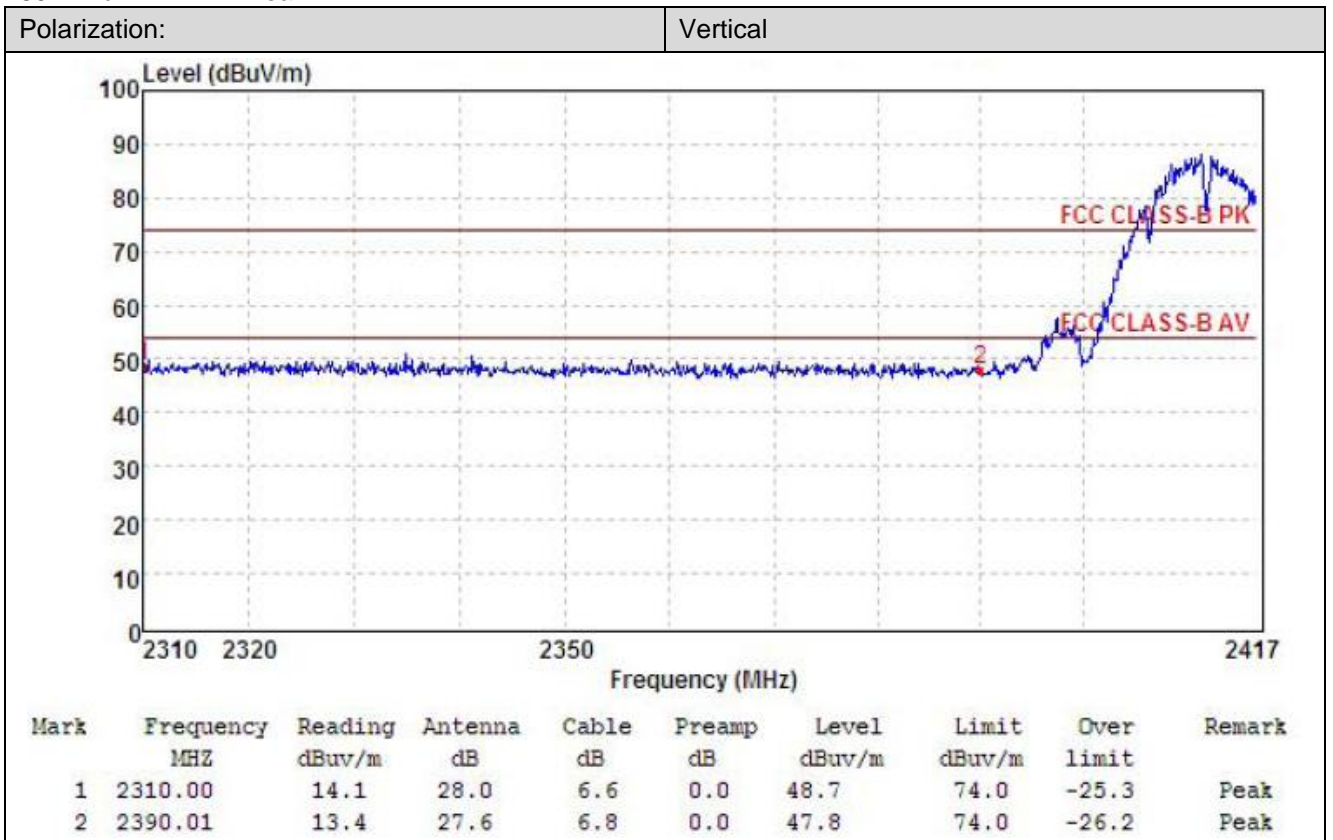

802.11b-2462MHz Peak:

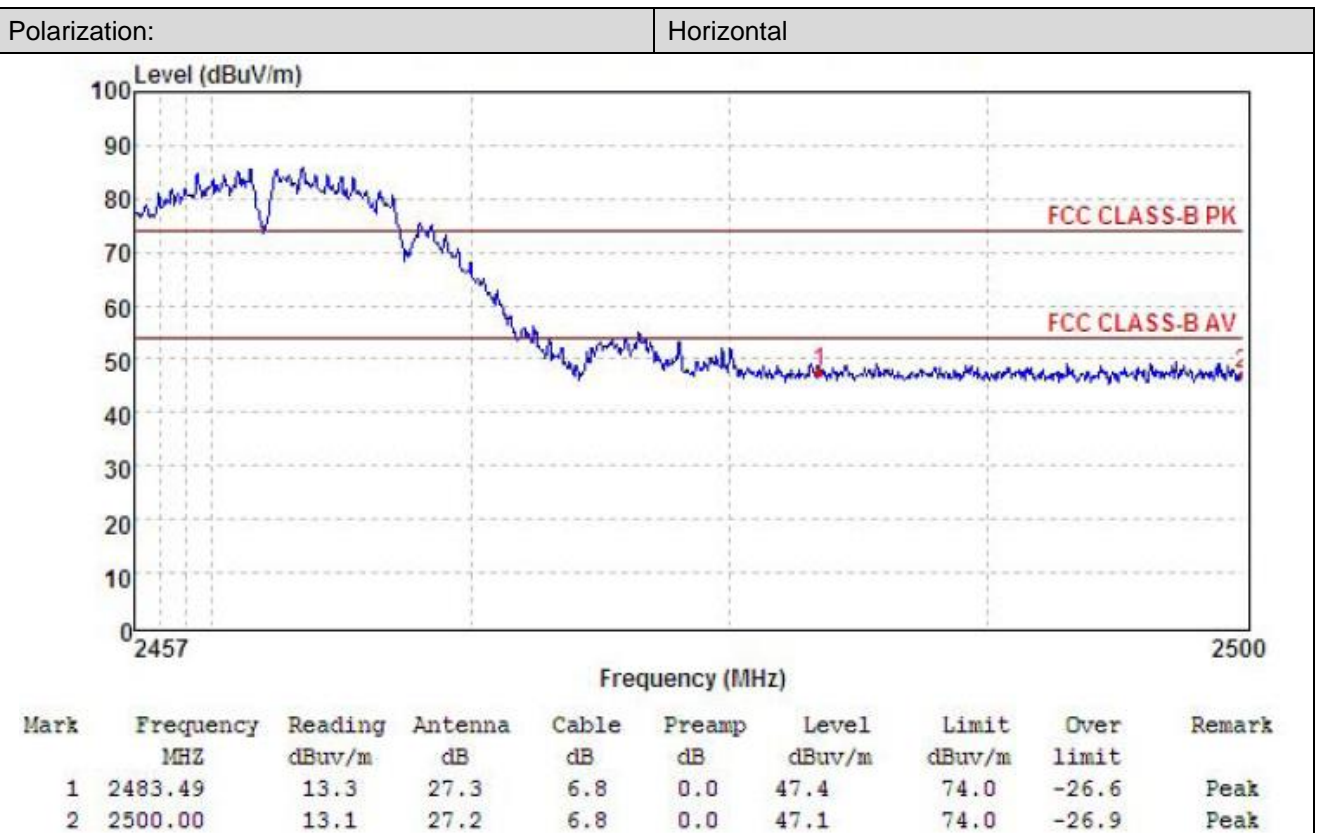
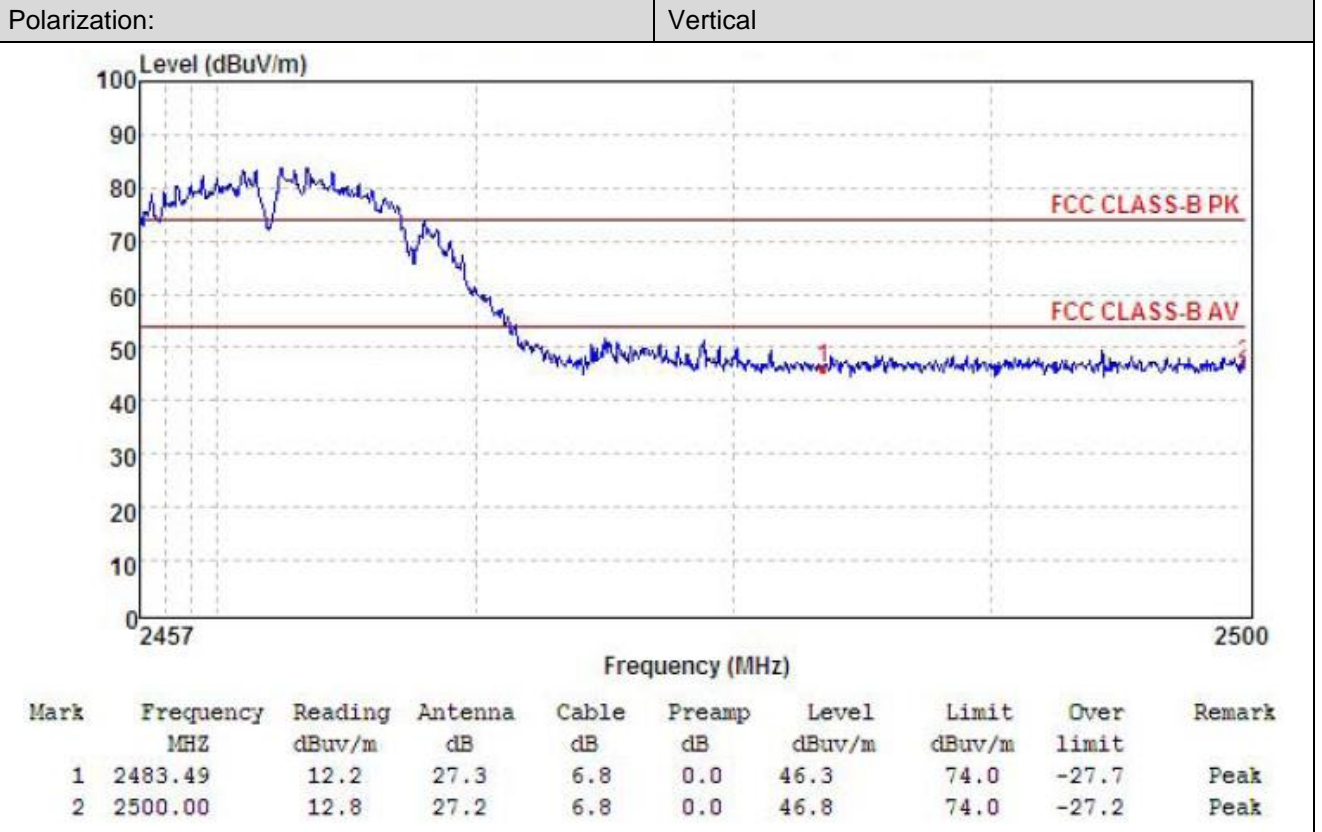

802.11g-2412MHz Peak:

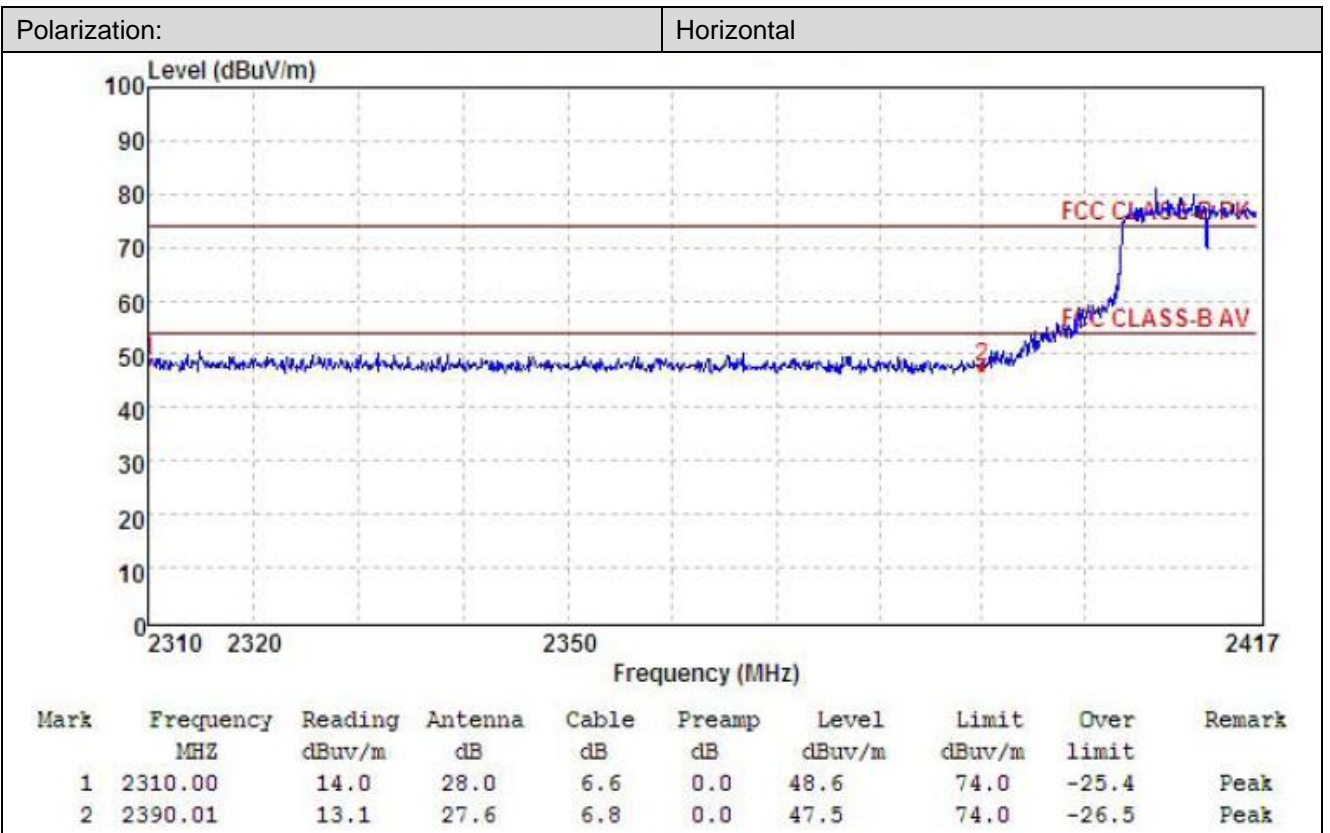
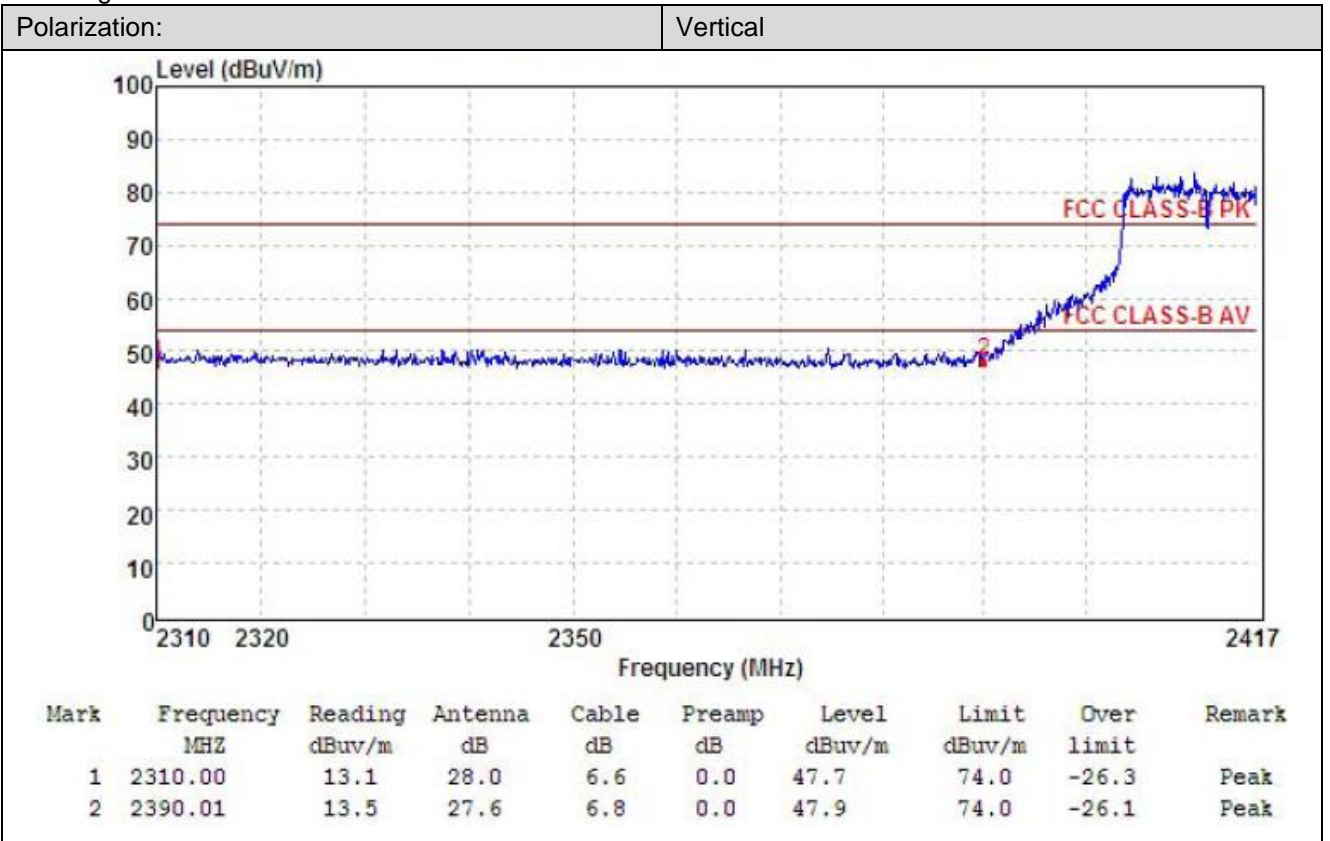

802.11g-2462MHz Peak:

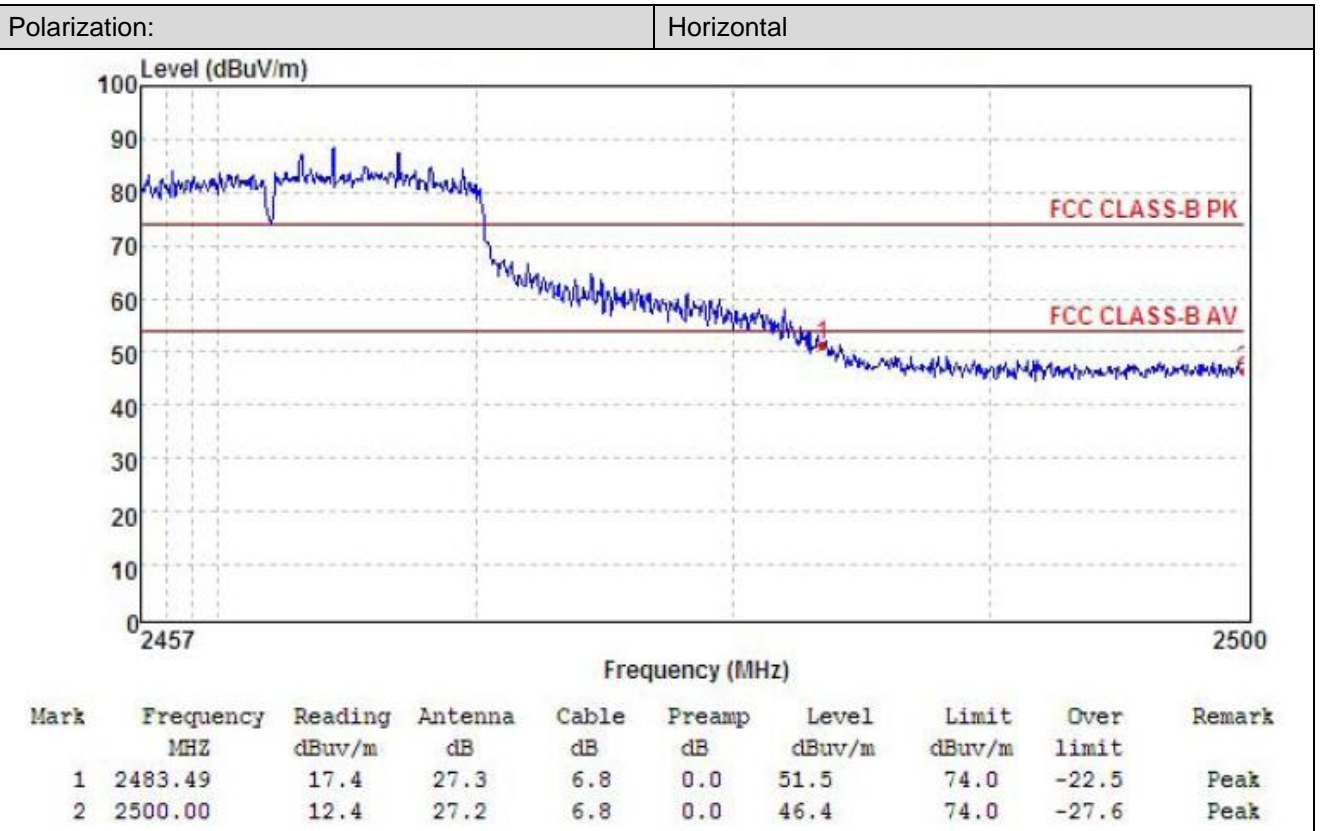
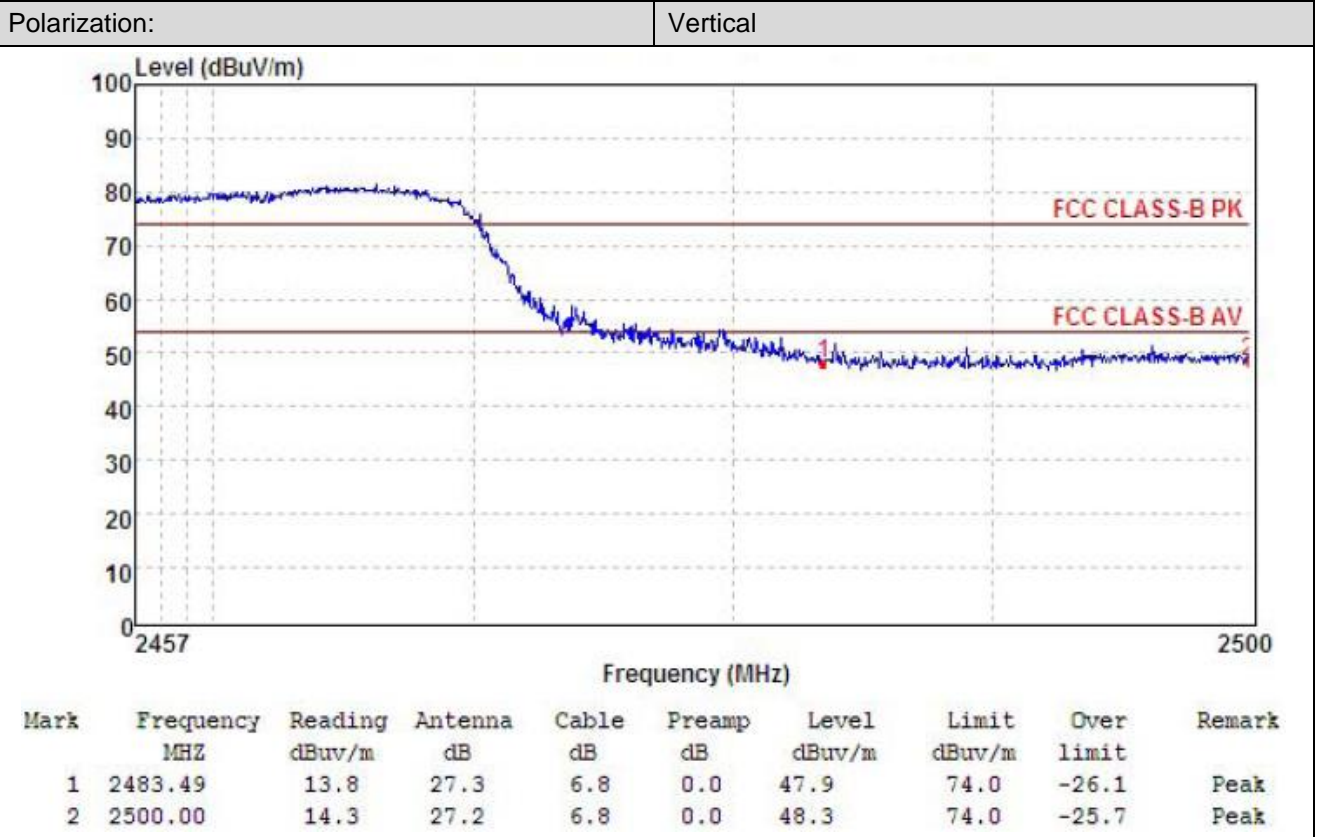

802.11n(HT20)-2412MHz Peak:

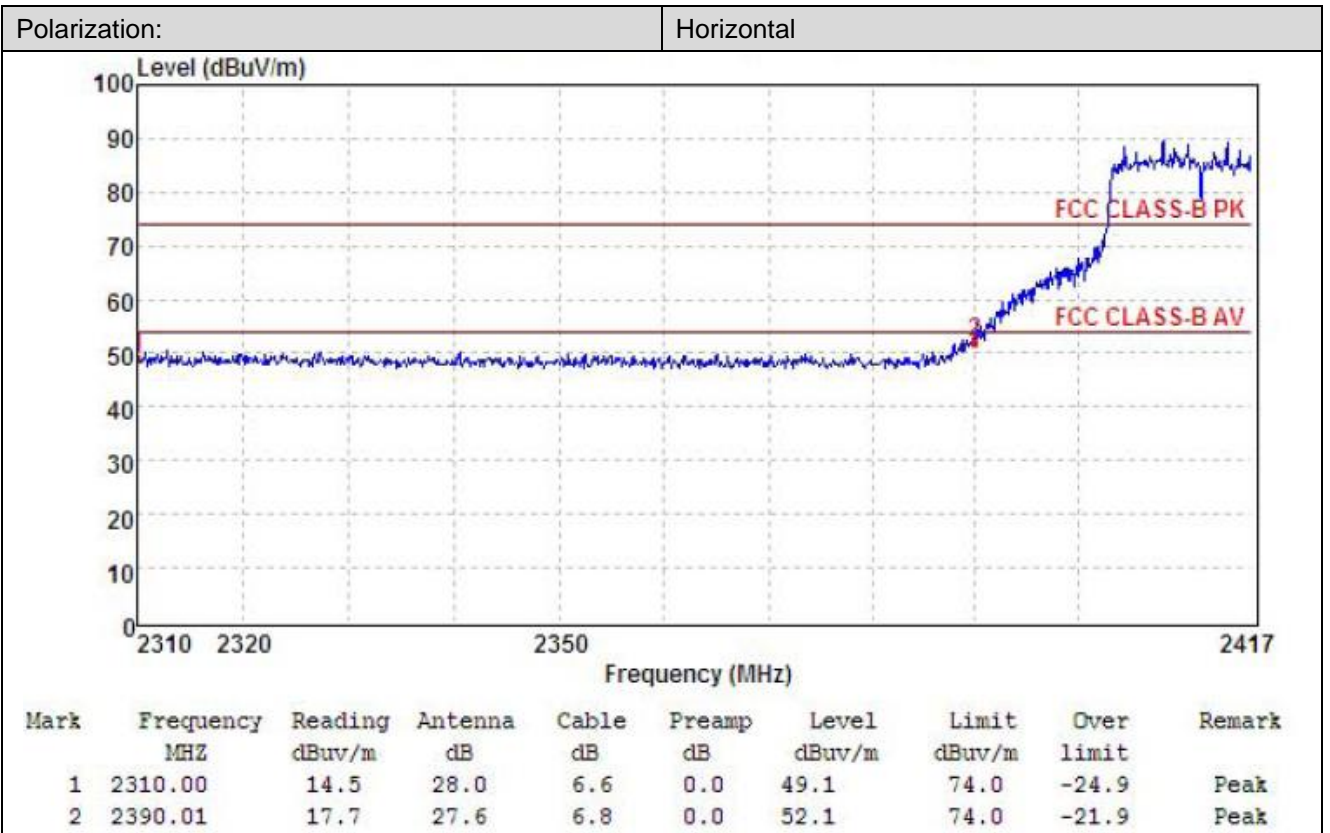
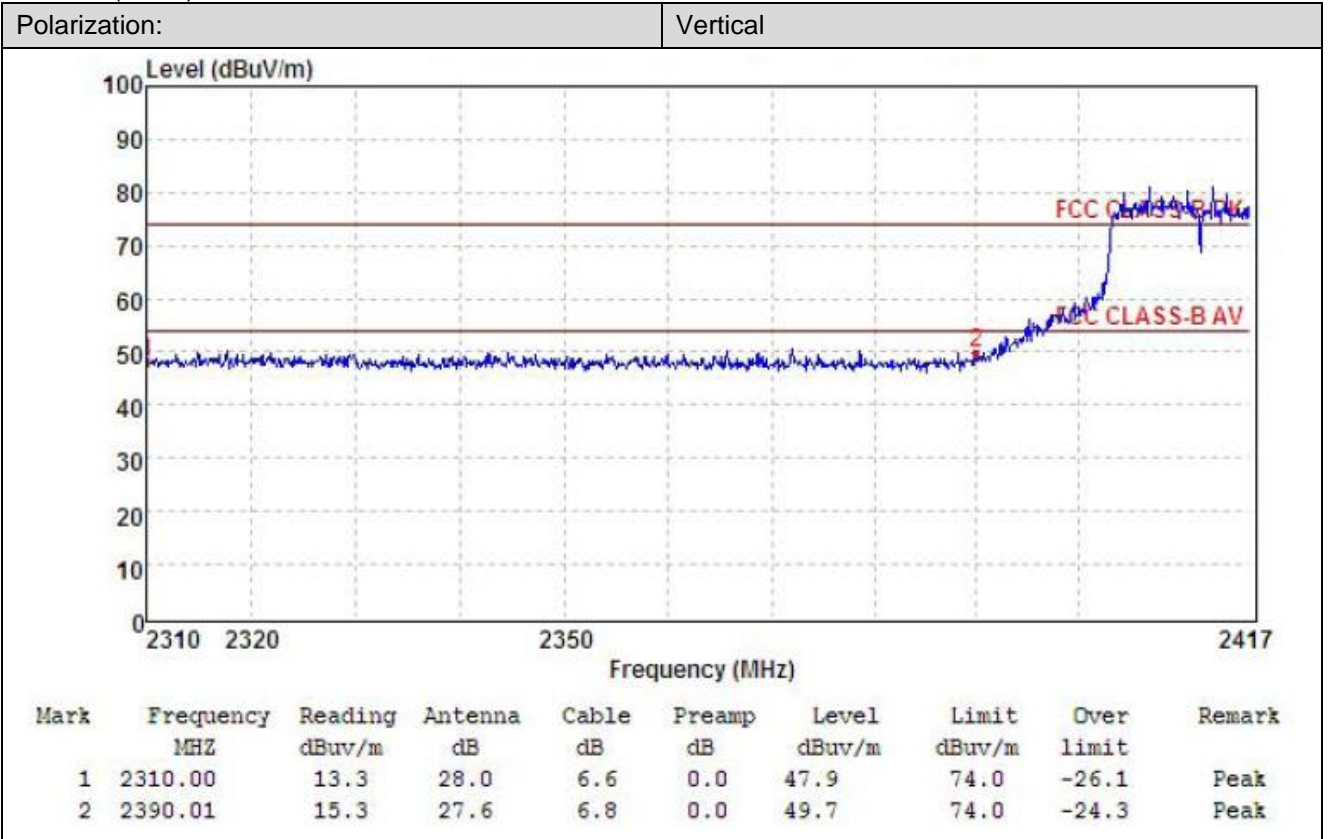

802.11n(HT20)-2462MHz Peak:

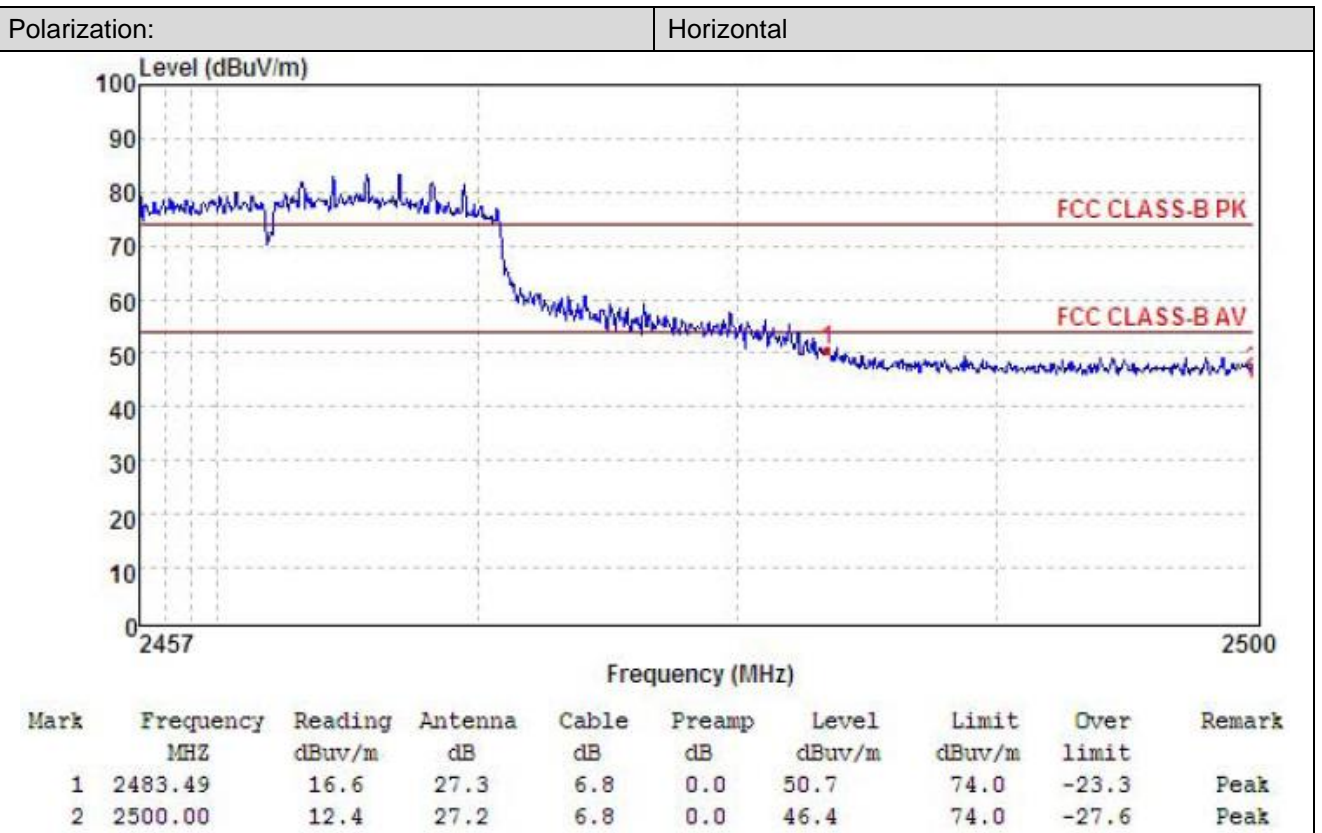
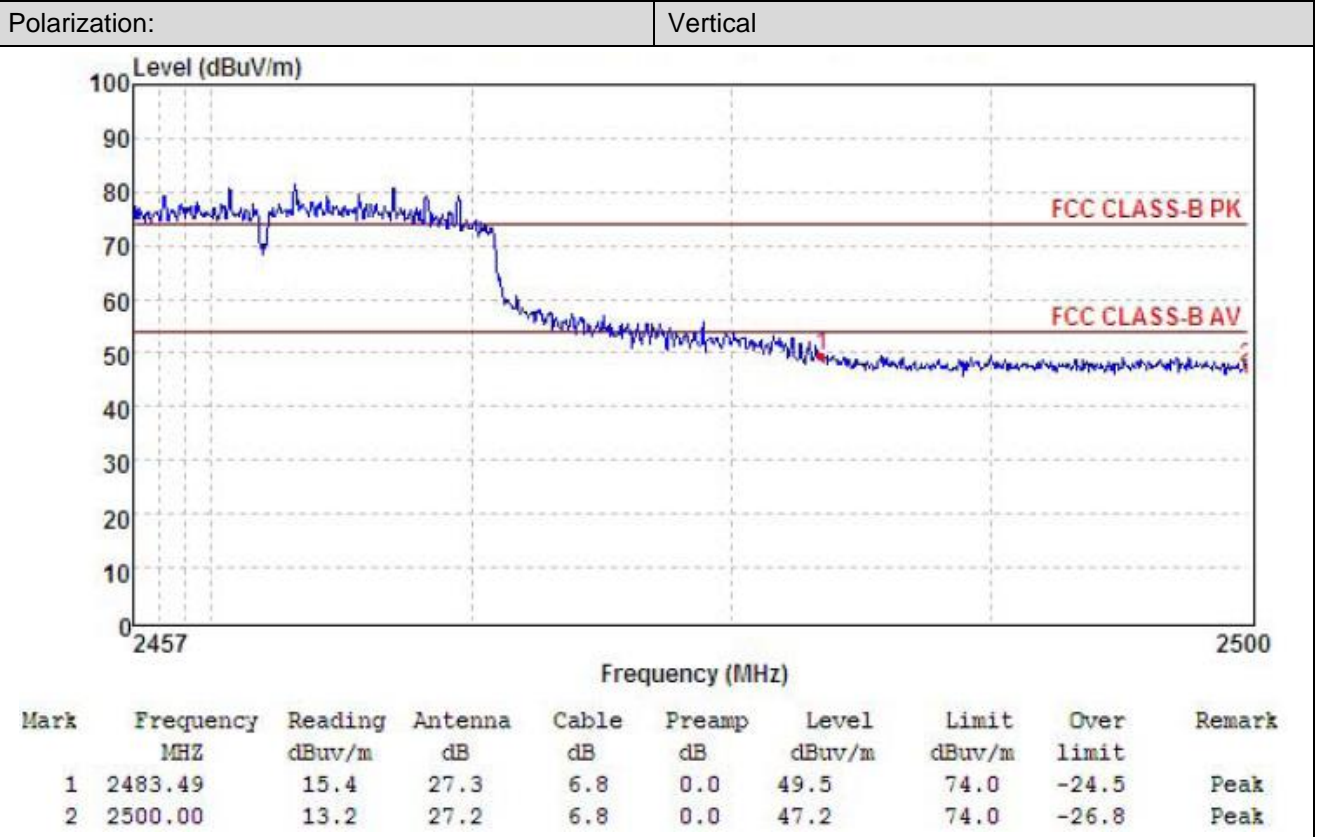

## 5.7. Band edge and Spurious Emissions (conducted)

### LIMIT

#### **FCC CFR Title 47 Part 15 Subpart C Section 15.247 (d):**

In any 100 kHz bandwidth outside the frequency band in which the spread spectrum intentional radiator is operating, the radio frequency power that is produced by the intentional radiator shall be at least 20 dB below that in the 100 kHz bandwidth within the band that contains the highest level of the desired power, based on either an RF conducted or a radiated measurement.

### TEST CONFIGURATION

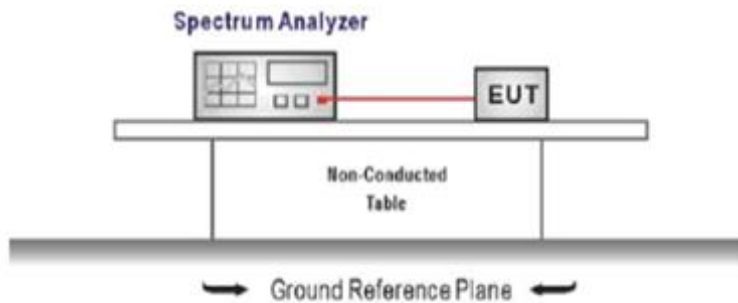

### TEST PROCEDURE



1. Connect the antenna port(s) to the spectrum analyzer input.
2. Establish a reference level by using the following procedure  
 Center frequency=DTS channel center frequency  
 The span = 1.5 times the DTS bandwidth.  
 RBW = 100 kHz, VBW  $\geq$  3 x RBW  
 Detector = peak, Sweep time = auto couple, Trace mode = max hold  
 Allow trace to fully stabilize  
 Use the peak marker function to determine the maximum PSD level  
  
 Note: the channel found to contain the maximum PSD level can be used to establish the reference level.
3. Emission level measurement  
 Set the center frequency and span to encompass frequency range to be measured  
 RBW = 100 kHz, VBW  $\geq$  3 x RBW  
 Detector = peak, Sweep time = auto couple, Trace mode = max hold  
 Allow trace to fully stabilize  
 Use the peak marker function to determine the maximum amplitude level.
4. Place the radio in continuous transmit mode, allow the trace to stabilize, view the transmitter waveform on the spectrum analyzer.
5. Ensure that the amplitude of all unwanted emission outside of the authorized frequency band excluding restricted frequency bands) are attenuated by at least the minimum requirements specified (at least 20 dB relative to the maximum in-band peak PSD level in 100 kHz). Report the three highest emission relative to the limit.

### TEST MODE:

Please refer to the clause 3.3

### TEST RESULTS

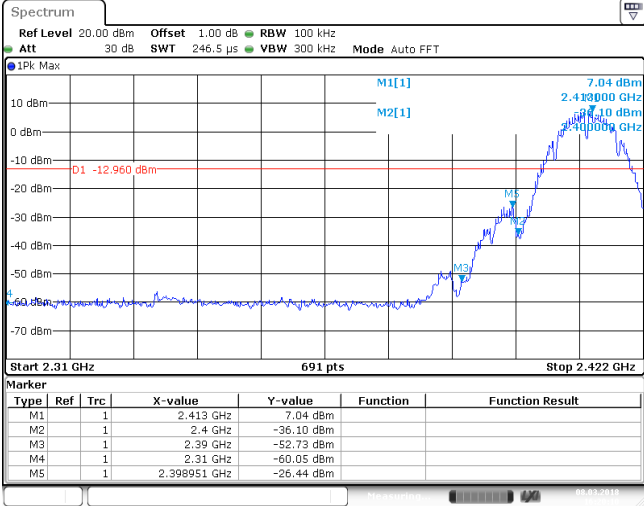
Passed       Not Applicable

| Test Item: | Bandedge  | Type: | 802.11 b     |            |          |                 |         |         |          |                 |    |   |  |              |          |  |  |    |   |  |            |            |  |  |    |   |  |          |            |  |  |    |   |  |              |            |  |  |    |   |  |              |            |  |  |
|------------|---|-------|--------------|------------|----------|-----------------|---------|---------|----------|-----------------|----|---|--|--------------|----------|--|--|----|---|--|------------|------------|--|--|----|---|--|----------|------------|--|--|----|---|--|--------------|------------|--|--|----|---|--|--------------|------------|--|--|
| CH01       |  <p>                     Spectrum<br/>                     Ref Level 20.00 dBm Offset 1.00 dB RBW 100 kHz<br/>                     Att 30 dB SWI 246.5 μs VBW 300 kHz Mode Auto FFT                 </p> <p>                     Start 2.31 GHz 691 pts Stop 2.422 GHz                 </p> <table border="1"> <thead> <tr> <th>Type</th> <th>Ref</th> <th>Trc</th> <th>X-value</th> <th>Y-value</th> <th>Function</th> <th>Function Result</th> </tr> </thead> <tbody> <tr> <td>M1</td> <td>1</td> <td></td> <td>2.413 GHz</td> <td>7.04 dBm</td> <td></td> <td></td> </tr> <tr> <td>M2</td> <td>1</td> <td></td> <td>2.4 GHz</td> <td>-36.10 dBm</td> <td></td> <td></td> </tr> <tr> <td>M3</td> <td>1</td> <td></td> <td>2.39 GHz</td> <td>-52.73 dBm</td> <td></td> <td></td> </tr> <tr> <td>M4</td> <td>1</td> <td></td> <td>2.31 GHz</td> <td>-60.05 dBm</td> <td></td> <td></td> </tr> <tr> <td>M5</td> <td>1</td> <td></td> <td>2.398951 GHz</td> <td>-26.44 dBm</td> <td></td> <td></td> </tr> </tbody> </table> |       |              | Type       | Ref      | Trc             | X-value | Y-value | Function | Function Result | M1 | 1 |  | 2.413 GHz    | 7.04 dBm |  |  | M2 | 1 |  | 2.4 GHz    | -36.10 dBm |  |  | M3 | 1 |  | 2.39 GHz | -52.73 dBm |  |  | M4 | 1 |  | 2.31 GHz     | -60.05 dBm |  |  | M5 | 1 |  | 2.398951 GHz | -26.44 dBm |  |  |
| Type       | Ref   | Trc   | X-value      | Y-value    | Function | Function Result |         |         |          |                 |    |   |  |              |          |  |  |    |   |  |            |            |  |  |    |   |  |          |            |  |  |    |   |  |              |            |  |  |    |   |  |              |            |  |  |
| M1         | 1   |       | 2.413 GHz    | 7.04 dBm   |          |                 |         |         |          |                 |    |   |  |              |          |  |  |    |   |  |            |            |  |  |    |   |  |          |            |  |  |    |   |  |              |            |  |  |    |   |  |              |            |  |  |
| M2         | 1   |       | 2.4 GHz      | -36.10 dBm |          |                 |         |         |          |                 |    |   |  |              |          |  |  |    |   |  |            |            |  |  |    |   |  |          |            |  |  |    |   |  |              |            |  |  |    |   |  |              |            |  |  |
| M3         | 1   |       | 2.39 GHz     | -52.73 dBm |          |                 |         |         |          |                 |    |   |  |              |          |  |  |    |   |  |            |            |  |  |    |   |  |          |            |  |  |    |   |  |              |            |  |  |    |   |  |              |            |  |  |
| M4         | 1   |       | 2.31 GHz     | -60.05 dBm |          |                 |         |         |          |                 |    |   |  |              |          |  |  |    |   |  |            |            |  |  |    |   |  |          |            |  |  |    |   |  |              |            |  |  |    |   |  |              |            |  |  |
| M5         | 1   |       | 2.398951 GHz | -26.44 dBm |          |                 |         |         |          |                 |    |   |  |              |          |  |  |    |   |  |            |            |  |  |    |   |  |          |            |  |  |    |   |  |              |            |  |  |    |   |  |              |            |  |  |
| CH11       |  <p>                     Spectrum<br/>                     Ref Level 20.00 dBm Offset 1.00 dB RBW 100 kHz<br/>                     Att 30 dB SWI 113.8 μs VBW 300 kHz Mode Auto FFT                 </p> <p>                     Start 2.452 GHz 691 pts Stop 2.5 GHz                 </p> <table border="1"> <thead> <tr> <th>Type</th> <th>Ref</th> <th>Trc</th> <th>X-value</th> <th>Y-value</th> <th>Function</th> <th>Function Result</th> </tr> </thead> <tbody> <tr> <td>M1</td> <td>1</td> <td></td> <td>2.462454 GHz</td> <td>7.19 dBm</td> <td></td> <td></td> </tr> <tr> <td>M2</td> <td>1</td> <td></td> <td>2.4835 GHz</td> <td>-44.67 dBm</td> <td></td> <td></td> </tr> <tr> <td>M3</td> <td>1</td> <td></td> <td>2.5 GHz</td> <td>-59.94 dBm</td> <td></td> <td></td> </tr> <tr> <td>M4</td> <td>1</td> <td></td> <td>2.483513 GHz</td> <td>-44.67 dBm</td> <td></td> <td></td> </tr> </tbody> </table>  |       |              | Type       | Ref      | Trc             | X-value | Y-value | Function | Function Result | M1 | 1 |  | 2.462454 GHz | 7.19 dBm |  |  | M2 | 1 |  | 2.4835 GHz | -44.67 dBm |  |  | M3 | 1 |  | 2.5 GHz  | -59.94 dBm |  |  | M4 | 1 |  | 2.483513 GHz | -44.67 dBm |  |  |    |   |  |              |            |  |  |
| Type       | Ref   | Trc   | X-value      | Y-value    | Function | Function Result |         |         |          |                 |    |   |  |              |          |  |  |    |   |  |            |            |  |  |    |   |  |          |            |  |  |    |   |  |              |            |  |  |    |   |  |              |            |  |  |
| M1         | 1   |       | 2.462454 GHz | 7.19 dBm   |          |                 |         |         |          |                 |    |   |  |              |          |  |  |    |   |  |            |            |  |  |    |   |  |          |            |  |  |    |   |  |              |            |  |  |    |   |  |              |            |  |  |
| M2         | 1   |       | 2.4835 GHz   | -44.67 dBm |          |                 |         |         |          |                 |    |   |  |              |          |  |  |    |   |  |            |            |  |  |    |   |  |          |            |  |  |    |   |  |              |            |  |  |    |   |  |              |            |  |  |
| M3         | 1   |       | 2.5 GHz      | -59.94 dBm |          |                 |         |         |          |                 |    |   |  |              |          |  |  |    |   |  |            |            |  |  |    |   |  |          |            |  |  |    |   |  |              |            |  |  |    |   |  |              |            |  |  |
| M4         | 1   |       | 2.483513 GHz | -44.67 dBm |          |                 |         |         |          |                 |    |   |  |              |          |  |  |    |   |  |            |            |  |  |    |   |  |          |            |  |  |    |   |  |              |            |  |  |    |   |  |              |            |  |  |

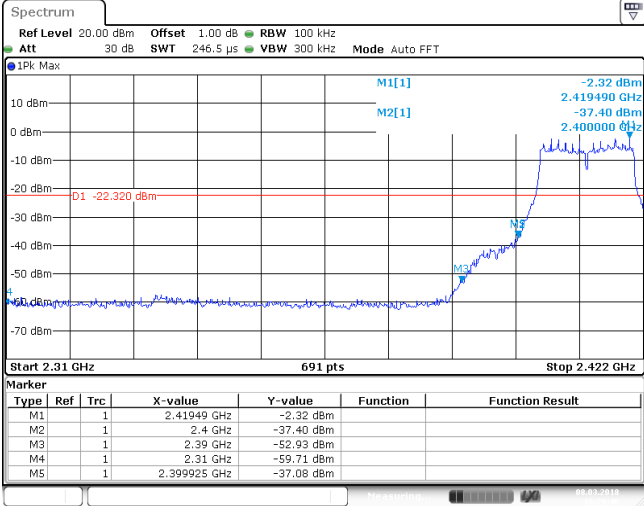
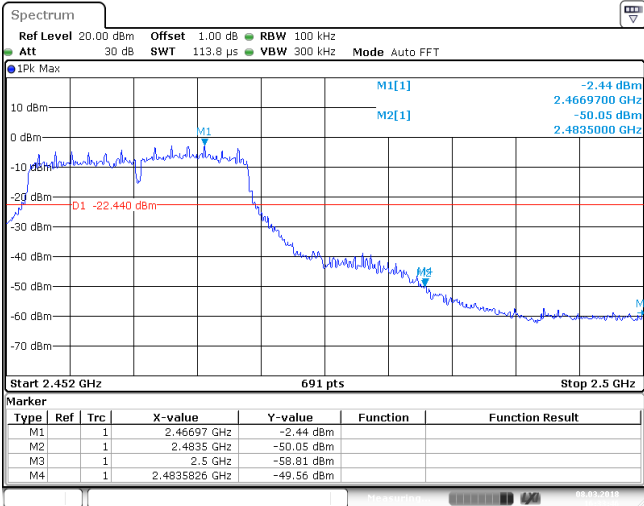

| Test Item: | Bandedge  | Type: | 802.11 g      |            |          |                 |         |         |          |                 |    |   |  |             |           |  |  |    |   |  |            |            |  |  |    |   |  |          |            |  |  |    |   |  |               |            |  |  |    |   |  |              |            |  |  |
|------------|---|-------|---------------|------------|----------|-----------------|---------|---------|----------|-----------------|----|---|--|-------------|-----------|--|--|----|---|--|------------|------------|--|--|----|---|--|----------|------------|--|--|----|---|--|---------------|------------|--|--|----|---|--|--------------|------------|--|--|
| CH01       |  <p><b>Spectrum</b><br/>                     Ref Level 20.00 dBm Offset 1.00 dB RBW 100 kHz<br/>                     Att 30 dB SWI 246.5 μs VBW 300 kHz Mode Auto FFT</p> <p>Start 2.31 GHz 691 pts Stop 2.422 GHz</p> <table border="1"> <thead> <tr> <th>Type</th> <th>Ref</th> <th>Trc</th> <th>X-value</th> <th>Y-value</th> <th>Function</th> <th>Function Result</th> </tr> </thead> <tbody> <tr> <td>M1</td> <td>1</td> <td></td> <td>2.41949 GHz</td> <td>-2.32 dBm</td> <td></td> <td></td> </tr> <tr> <td>M2</td> <td>1</td> <td></td> <td>2.4 GHz</td> <td>-37.40 dBm</td> <td></td> <td></td> </tr> <tr> <td>M3</td> <td>1</td> <td></td> <td>2.39 GHz</td> <td>-52.93 dBm</td> <td></td> <td></td> </tr> <tr> <td>M4</td> <td>1</td> <td></td> <td>2.31 GHz</td> <td>-59.71 dBm</td> <td></td> <td></td> </tr> <tr> <td>M5</td> <td>1</td> <td></td> <td>2.399925 GHz</td> <td>-37.08 dBm</td> <td></td> <td></td> </tr> </tbody> </table> |       |               | Type       | Ref      | Trc             | X-value | Y-value | Function | Function Result | M1 | 1 |  | 2.41949 GHz | -2.32 dBm |  |  | M2 | 1 |  | 2.4 GHz    | -37.40 dBm |  |  | M3 | 1 |  | 2.39 GHz | -52.93 dBm |  |  | M4 | 1 |  | 2.31 GHz      | -59.71 dBm |  |  | M5 | 1 |  | 2.399925 GHz | -37.08 dBm |  |  |
| Type       | Ref   | Trc   | X-value       | Y-value    | Function | Function Result |         |         |          |                 |    |   |  |             |           |  |  |    |   |  |            |            |  |  |    |   |  |          |            |  |  |    |   |  |               |            |  |  |    |   |  |              |            |  |  |
| M1         | 1   |       | 2.41949 GHz   | -2.32 dBm  |          |                 |         |         |          |                 |    |   |  |             |           |  |  |    |   |  |            |            |  |  |    |   |  |          |            |  |  |    |   |  |               |            |  |  |    |   |  |              |            |  |  |
| M2         | 1   |       | 2.4 GHz       | -37.40 dBm |          |                 |         |         |          |                 |    |   |  |             |           |  |  |    |   |  |            |            |  |  |    |   |  |          |            |  |  |    |   |  |               |            |  |  |    |   |  |              |            |  |  |
| M3         | 1   |       | 2.39 GHz      | -52.93 dBm |          |                 |         |         |          |                 |    |   |  |             |           |  |  |    |   |  |            |            |  |  |    |   |  |          |            |  |  |    |   |  |               |            |  |  |    |   |  |              |            |  |  |
| M4         | 1   |       | 2.31 GHz      | -59.71 dBm |          |                 |         |         |          |                 |    |   |  |             |           |  |  |    |   |  |            |            |  |  |    |   |  |          |            |  |  |    |   |  |               |            |  |  |    |   |  |              |            |  |  |
| M5         | 1   |       | 2.399925 GHz  | -37.08 dBm |          |                 |         |         |          |                 |    |   |  |             |           |  |  |    |   |  |            |            |  |  |    |   |  |          |            |  |  |    |   |  |               |            |  |  |    |   |  |              |            |  |  |
| CH11       |  <p><b>Spectrum</b><br/>                     Ref Level 20.00 dBm Offset 1.00 dB RBW 100 kHz<br/>                     Att 30 dB SWI 113.8 μs VBW 300 kHz Mode Auto FFT</p> <p>Start 2.452 GHz 691 pts Stop 2.5 GHz</p> <table border="1"> <thead> <tr> <th>Type</th> <th>Ref</th> <th>Trc</th> <th>X-value</th> <th>Y-value</th> <th>Function</th> <th>Function Result</th> </tr> </thead> <tbody> <tr> <td>M1</td> <td>1</td> <td></td> <td>2.46697 GHz</td> <td>-2.44 dBm</td> <td></td> <td></td> </tr> <tr> <td>M2</td> <td>1</td> <td></td> <td>2.4835 GHz</td> <td>-50.05 dBm</td> <td></td> <td></td> </tr> <tr> <td>M3</td> <td>1</td> <td></td> <td>2.5 GHz</td> <td>-58.81 dBm</td> <td></td> <td></td> </tr> <tr> <td>M4</td> <td>1</td> <td></td> <td>2.4835826 GHz</td> <td>-49.56 dBm</td> <td></td> <td></td> </tr> </tbody> </table>  |       |               | Type       | Ref      | Trc             | X-value | Y-value | Function | Function Result | M1 | 1 |  | 2.46697 GHz | -2.44 dBm |  |  | M2 | 1 |  | 2.4835 GHz | -50.05 dBm |  |  | M3 | 1 |  | 2.5 GHz  | -58.81 dBm |  |  | M4 | 1 |  | 2.4835826 GHz | -49.56 dBm |  |  |    |   |  |              |            |  |  |
| Type       | Ref   | Trc   | X-value       | Y-value    | Function | Function Result |         |         |          |                 |    |   |  |             |           |  |  |    |   |  |            |            |  |  |    |   |  |          |            |  |  |    |   |  |               |            |  |  |    |   |  |              |            |  |  |
| M1         | 1   |       | 2.46697 GHz   | -2.44 dBm  |          |                 |         |         |          |                 |    |   |  |             |           |  |  |    |   |  |            |            |  |  |    |   |  |          |            |  |  |    |   |  |               |            |  |  |    |   |  |              |            |  |  |
| M2         | 1   |       | 2.4835 GHz    | -50.05 dBm |          |                 |         |         |          |                 |    |   |  |             |           |  |  |    |   |  |            |            |  |  |    |   |  |          |            |  |  |    |   |  |               |            |  |  |    |   |  |              |            |  |  |
| M3         | 1   |       | 2.5 GHz       | -58.81 dBm |          |                 |         |         |          |                 |    |   |  |             |           |  |  |    |   |  |            |            |  |  |    |   |  |          |            |  |  |    |   |  |               |            |  |  |    |   |  |              |            |  |  |
| M4         | 1   |       | 2.4835826 GHz | -49.56 dBm |          |                 |         |         |          |                 |    |   |  |             |           |  |  |    |   |  |            |            |  |  |    |   |  |          |            |  |  |    |   |  |               |            |  |  |    |   |  |              |            |  |  |

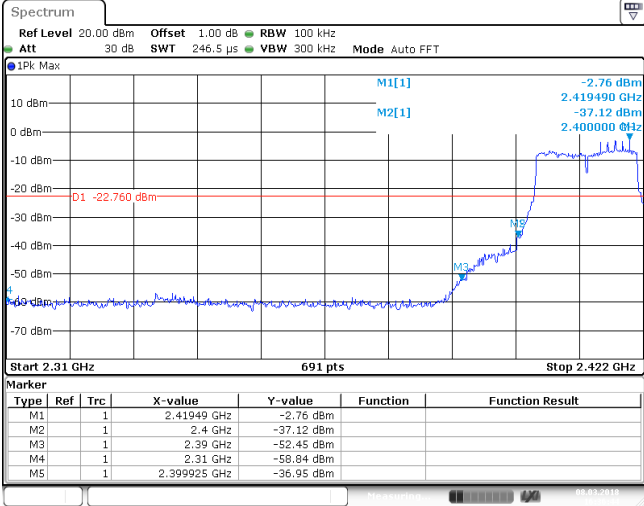
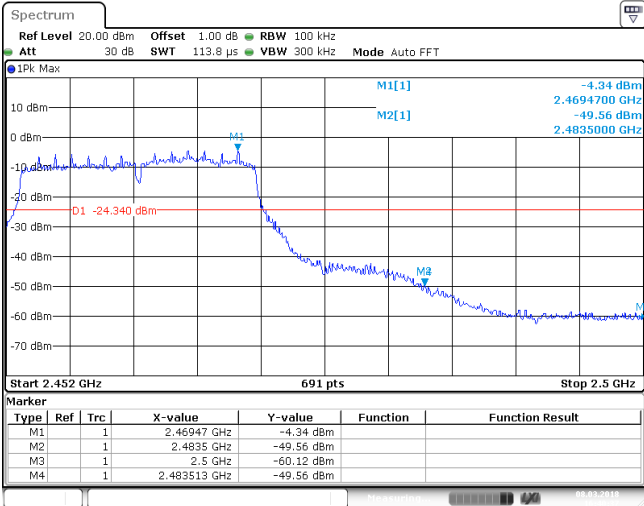
| Test Item: | Bandedge   | Type: | 802.11 n(HT20) |            |          |                 |         |         |          |                 |    |   |  |             |           |  |  |    |   |  |            |            |  |  |    |   |  |          |            |  |  |    |   |  |              |            |  |  |    |   |  |              |            |  |  |
|------------|--|-------|----------------|------------|----------|-----------------|---------|---------|----------|-----------------|----|---|--|-------------|-----------|--|--|----|---|--|------------|------------|--|--|----|---|--|----------|------------|--|--|----|---|--|--------------|------------|--|--|----|---|--|--------------|------------|--|--|
| CH01       |  <p><b>Marker</b></p> <table border="1"> <thead> <tr> <th>Type</th> <th>Ref</th> <th>Trc</th> <th>X-value</th> <th>Y-value</th> <th>Function</th> <th>Function Result</th> </tr> </thead> <tbody> <tr> <td>M1</td> <td>1</td> <td></td> <td>2.41949 GHz</td> <td>-2.76 dBm</td> <td></td> <td></td> </tr> <tr> <td>M2</td> <td>1</td> <td></td> <td>2.4 GHz</td> <td>-37.12 dBm</td> <td></td> <td></td> </tr> <tr> <td>M3</td> <td>1</td> <td></td> <td>2.39 GHz</td> <td>-52.45 dBm</td> <td></td> <td></td> </tr> <tr> <td>M4</td> <td>1</td> <td></td> <td>2.31 GHz</td> <td>-58.84 dBm</td> <td></td> <td></td> </tr> <tr> <td>M5</td> <td>1</td> <td></td> <td>2.399925 GHz</td> <td>-36.95 dBm</td> <td></td> <td></td> </tr> </tbody> </table> |       |                | Type       | Ref      | Trc             | X-value | Y-value | Function | Function Result | M1 | 1 |  | 2.41949 GHz | -2.76 dBm |  |  | M2 | 1 |  | 2.4 GHz    | -37.12 dBm |  |  | M3 | 1 |  | 2.39 GHz | -52.45 dBm |  |  | M4 | 1 |  | 2.31 GHz     | -58.84 dBm |  |  | M5 | 1 |  | 2.399925 GHz | -36.95 dBm |  |  |
| Type       | Ref  | Trc   | X-value        | Y-value    | Function | Function Result |         |         |          |                 |    |   |  |             |           |  |  |    |   |  |            |            |  |  |    |   |  |          |            |  |  |    |   |  |              |            |  |  |    |   |  |              |            |  |  |
| M1         | 1  |       | 2.41949 GHz    | -2.76 dBm  |          |                 |         |         |          |                 |    |   |  |             |           |  |  |    |   |  |            |            |  |  |    |   |  |          |            |  |  |    |   |  |              |            |  |  |    |   |  |              |            |  |  |
| M2         | 1  |       | 2.4 GHz        | -37.12 dBm |          |                 |         |         |          |                 |    |   |  |             |           |  |  |    |   |  |            |            |  |  |    |   |  |          |            |  |  |    |   |  |              |            |  |  |    |   |  |              |            |  |  |
| M3         | 1  |       | 2.39 GHz       | -52.45 dBm |          |                 |         |         |          |                 |    |   |  |             |           |  |  |    |   |  |            |            |  |  |    |   |  |          |            |  |  |    |   |  |              |            |  |  |    |   |  |              |            |  |  |
| M4         | 1  |       | 2.31 GHz       | -58.84 dBm |          |                 |         |         |          |                 |    |   |  |             |           |  |  |    |   |  |            |            |  |  |    |   |  |          |            |  |  |    |   |  |              |            |  |  |    |   |  |              |            |  |  |
| M5         | 1  |       | 2.399925 GHz   | -36.95 dBm |          |                 |         |         |          |                 |    |   |  |             |           |  |  |    |   |  |            |            |  |  |    |   |  |          |            |  |  |    |   |  |              |            |  |  |    |   |  |              |            |  |  |
| CH11       |  <p><b>Marker</b></p> <table border="1"> <thead> <tr> <th>Type</th> <th>Ref</th> <th>Trc</th> <th>X-value</th> <th>Y-value</th> <th>Function</th> <th>Function Result</th> </tr> </thead> <tbody> <tr> <td>M1</td> <td>1</td> <td></td> <td>2.46947 GHz</td> <td>-4.34 dBm</td> <td></td> <td></td> </tr> <tr> <td>M2</td> <td>1</td> <td></td> <td>2.4835 GHz</td> <td>-49.56 dBm</td> <td></td> <td></td> </tr> <tr> <td>M3</td> <td>1</td> <td></td> <td>2.5 GHz</td> <td>-60.12 dBm</td> <td></td> <td></td> </tr> <tr> <td>M4</td> <td>1</td> <td></td> <td>2.483513 GHz</td> <td>-49.56 dBm</td> <td></td> <td></td> </tr> </tbody> </table>  |       |                | Type       | Ref      | Trc             | X-value | Y-value | Function | Function Result | M1 | 1 |  | 2.46947 GHz | -4.34 dBm |  |  | M2 | 1 |  | 2.4835 GHz | -49.56 dBm |  |  | M3 | 1 |  | 2.5 GHz  | -60.12 dBm |  |  | M4 | 1 |  | 2.483513 GHz | -49.56 dBm |  |  |    |   |  |              |            |  |  |
| Type       | Ref  | Trc   | X-value        | Y-value    | Function | Function Result |         |         |          |                 |    |   |  |             |           |  |  |    |   |  |            |            |  |  |    |   |  |          |            |  |  |    |   |  |              |            |  |  |    |   |  |              |            |  |  |
| M1         | 1  |       | 2.46947 GHz    | -4.34 dBm  |          |                 |         |         |          |                 |    |   |  |             |           |  |  |    |   |  |            |            |  |  |    |   |  |          |            |  |  |    |   |  |              |            |  |  |    |   |  |              |            |  |  |
| M2         | 1  |       | 2.4835 GHz     | -49.56 dBm |          |                 |         |         |          |                 |    |   |  |             |           |  |  |    |   |  |            |            |  |  |    |   |  |          |            |  |  |    |   |  |              |            |  |  |    |   |  |              |            |  |  |
| M3         | 1  |       | 2.5 GHz        | -60.12 dBm |          |                 |         |         |          |                 |    |   |  |             |           |  |  |    |   |  |            |            |  |  |    |   |  |          |            |  |  |    |   |  |              |            |  |  |    |   |  |              |            |  |  |
| M4         | 1  |       | 2.483513 GHz   | -49.56 dBm |          |                 |         |         |          |                 |    |   |  |             |           |  |  |    |   |  |            |            |  |  |    |   |  |          |            |  |  |    |   |  |              |            |  |  |    |   |  |              |            |  |  |

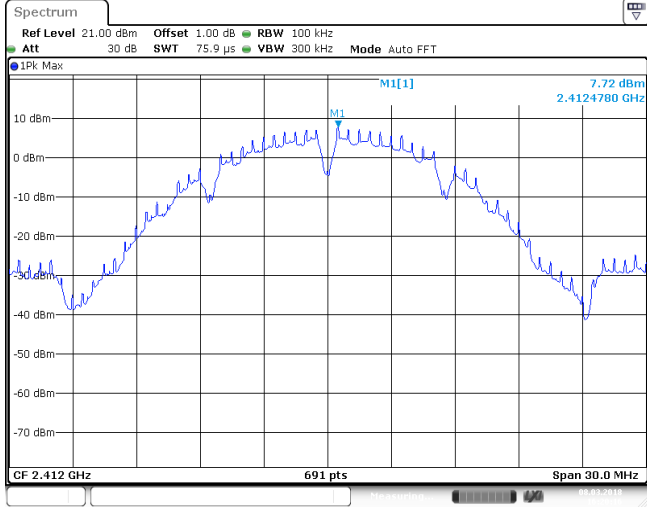
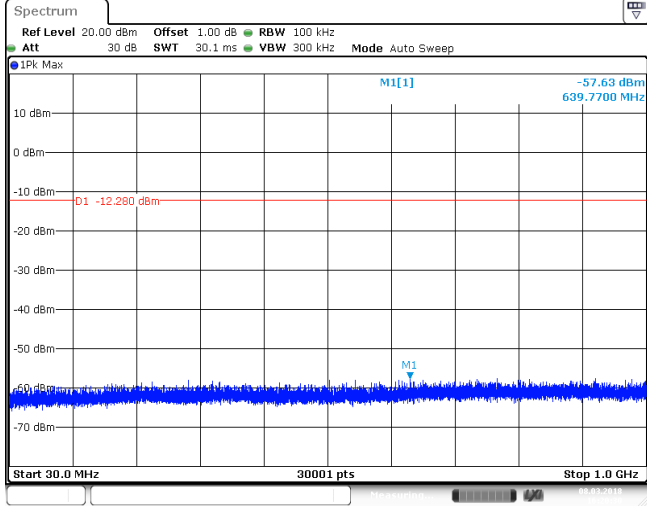
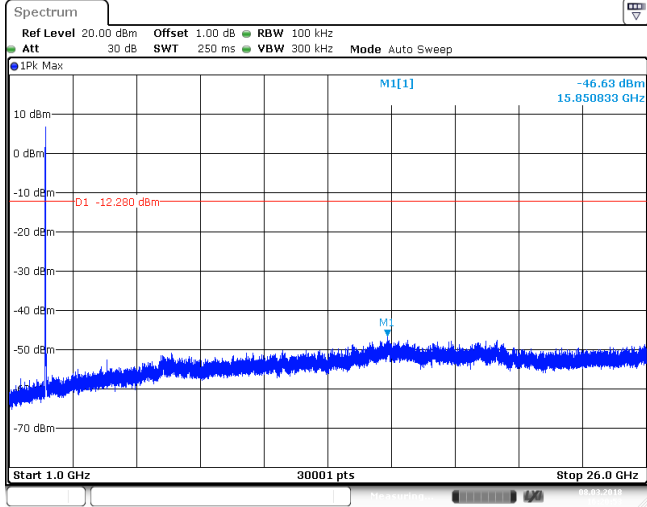
| Test Item:              | SE | Type:  | 802.11 b |
|-------------------------|----|--|----------|
| CH01<br>Reference level |    |    |          |
| CH01<br>30MHz~1000MHz   |    |   |          |
| CH01<br>1GHz~26GHz      |    |  |          |

CH06  
Reference level

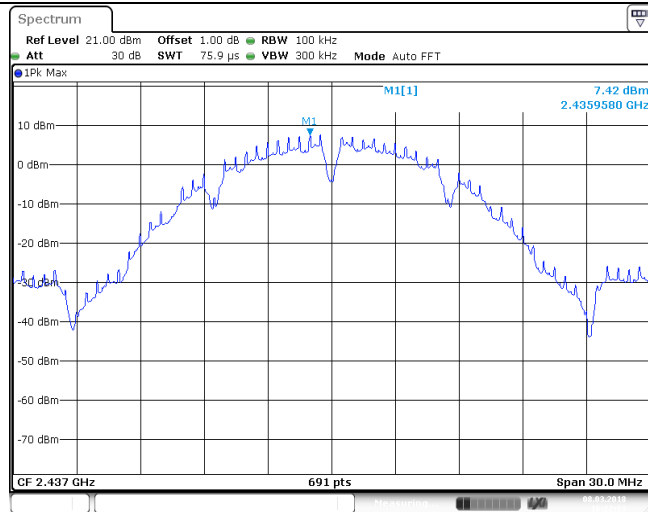

CH06  
30MHz~1000MHz

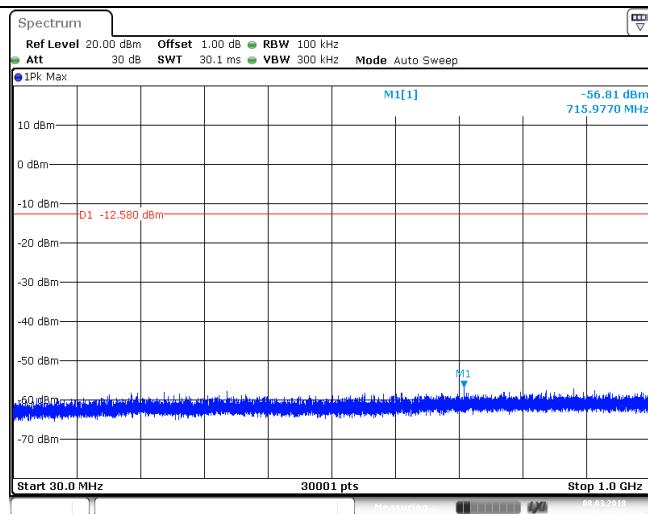

CH06  
1GHz~26GHz

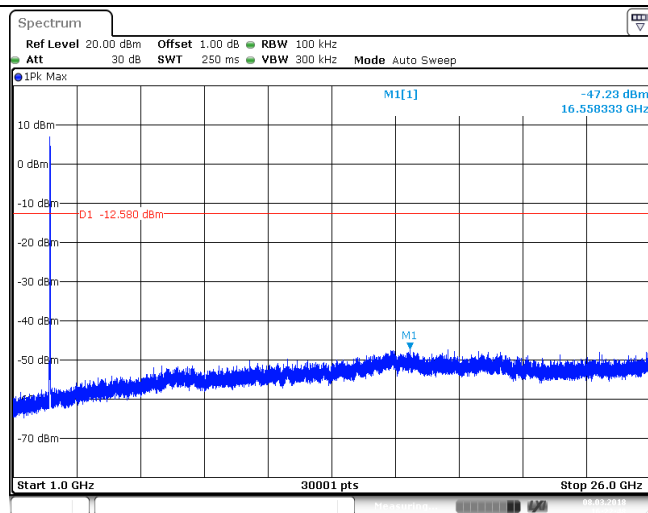

CH11  
Reference level

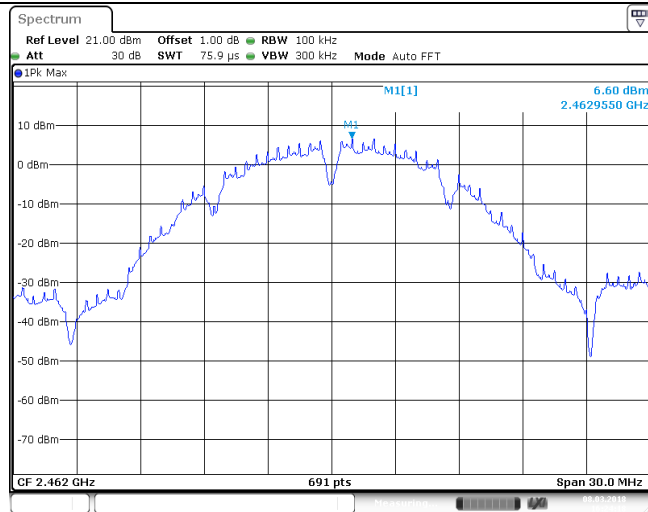

CH11  
30MHz~1000MHz

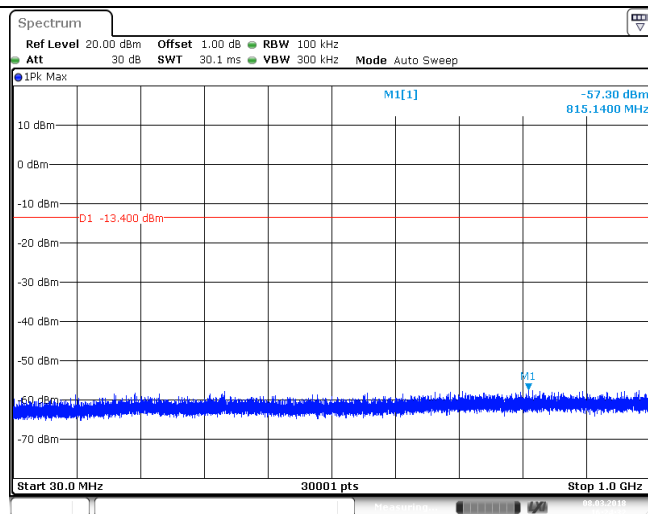

CH11  
1GHz~26GHz

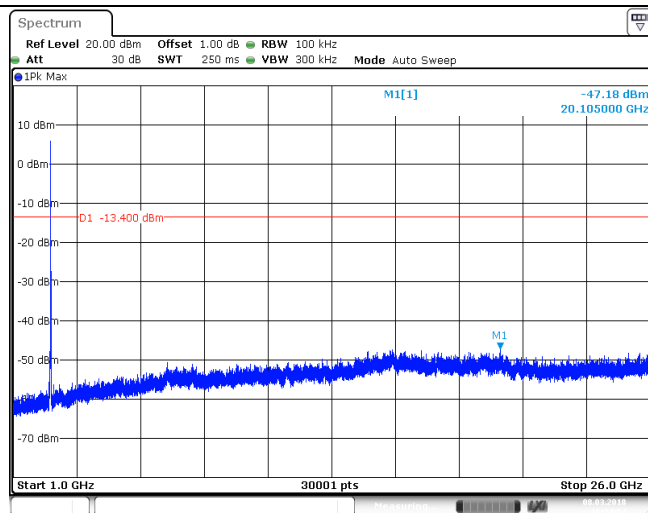

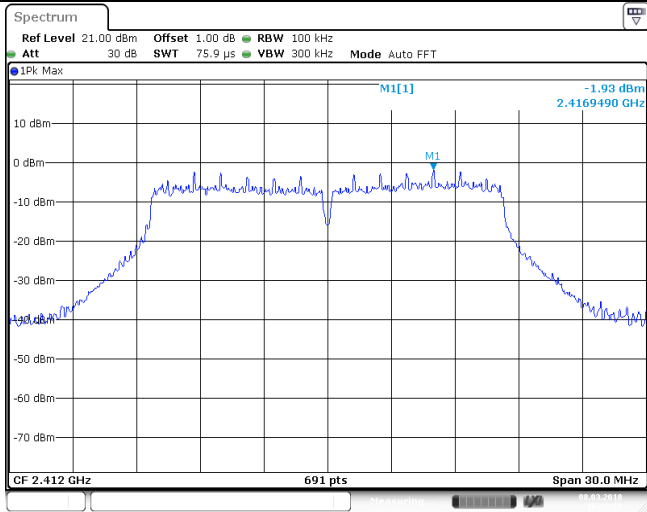
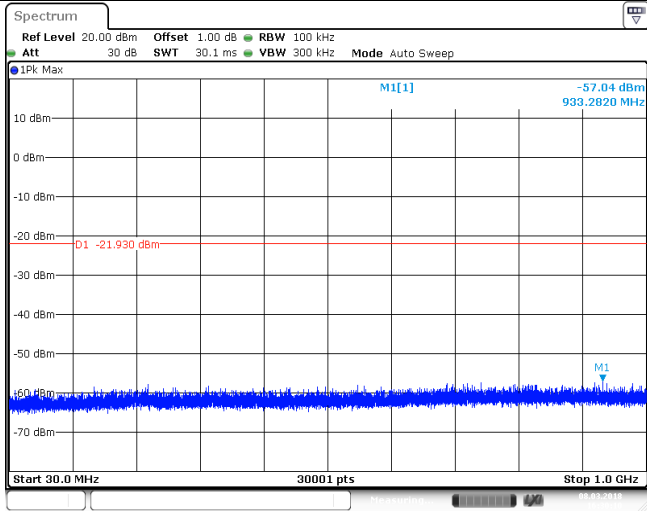
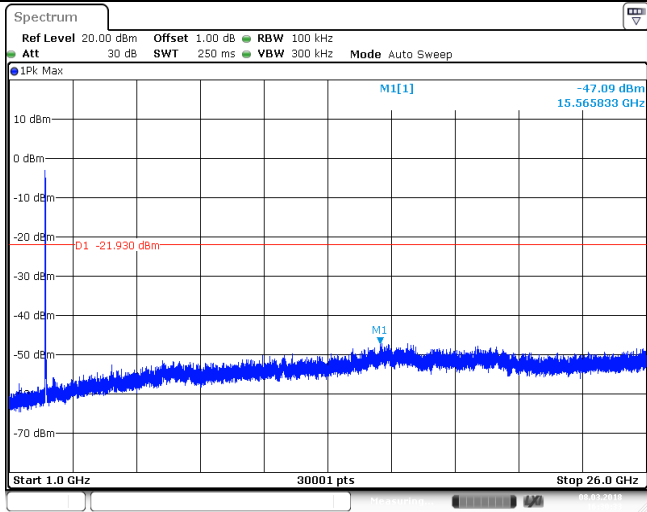
| Test Item:                      | SE | Type:   | 802.11 g |
|---------------------------------|----|---|----------|
| <p>CH01<br/>Reference level</p> |    |  <p>Spectrum<br/>                     Ref Level 21.00 dBm Offset 1.00 dB RBW 100 kHz<br/>                     Att 30 dB SWT 75.9 μs VBW 300 kHz Mode Auto FFT<br/>                     IPk Max M1[1] -1.93 dBm 2.4169490 GHz<br/>                     CF 2.412 GHz 691 pts Span 30.0 MHz</p>  |          |
| <p>CH01<br/>30MHz~1000MHz</p>   |    |  <p>Spectrum<br/>                     Ref Level 20.00 dBm Offset 1.00 dB RBW 100 kHz<br/>                     Att 30 dB SWT 30.1 ms VBW 300 kHz Mode Auto Sweep<br/>                     IPk Max M1[1] -57.04 dBm 933.2020 MHz<br/>                     D1 -21.930 dBm<br/>                     Start 30.0 MHz 30001 pts Stop 1.0 GHz</p>  |          |
| <p>CH01<br/>1GHz~26GHz</p>      |    |  <p>Spectrum<br/>                     Ref Level 20.00 dBm Offset 1.00 dB RBW 100 kHz<br/>                     Att 30 dB SWT 250 ms VBW 300 kHz Mode Auto Sweep<br/>                     IPk Max M1[1] -47.09 dBm 15.565833 GHz<br/>                     D1 -21.930 dBm<br/>                     Start 1.0 GHz 30001 pts Stop 26.0 GHz</p> |          |

CH06  
Reference level

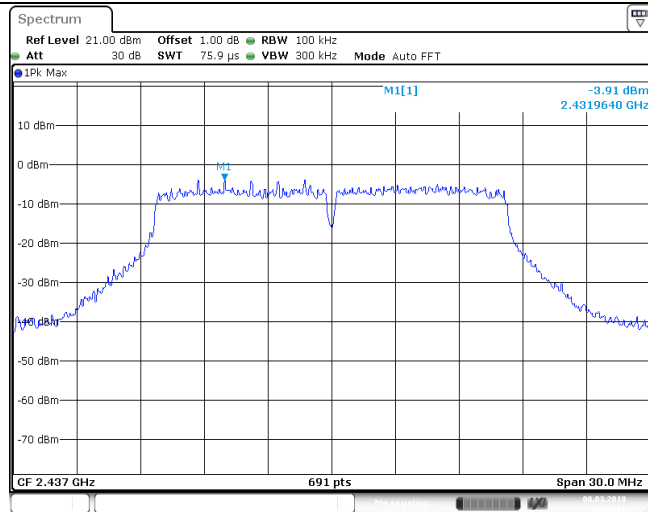

CH06  
30MHz~1000MHz

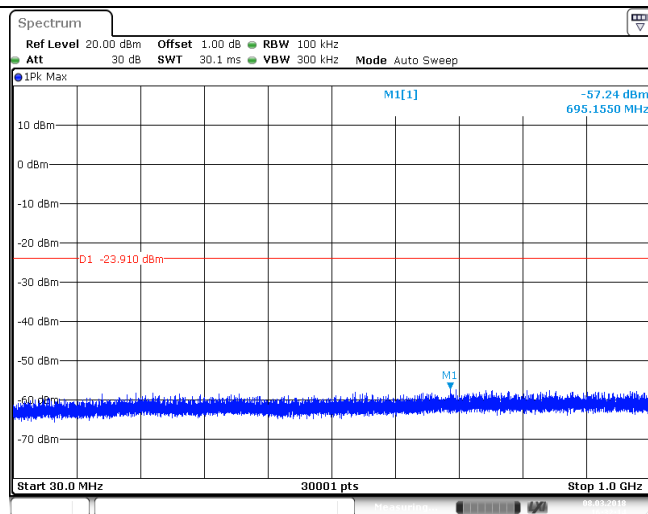

CH06  
1GHz~26GHz

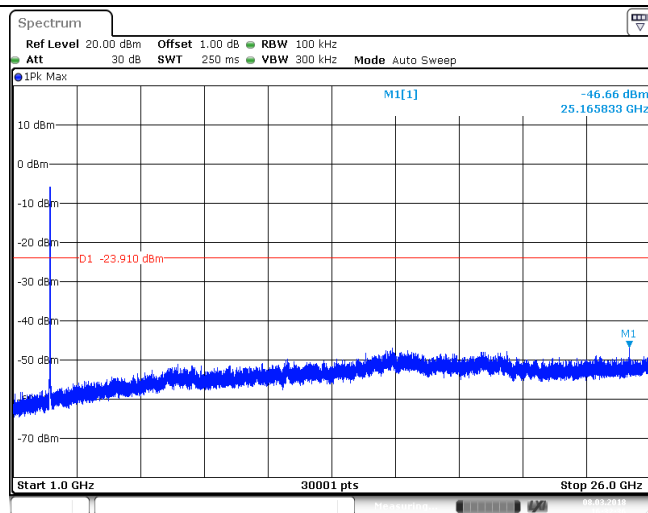

CH11  
Reference level

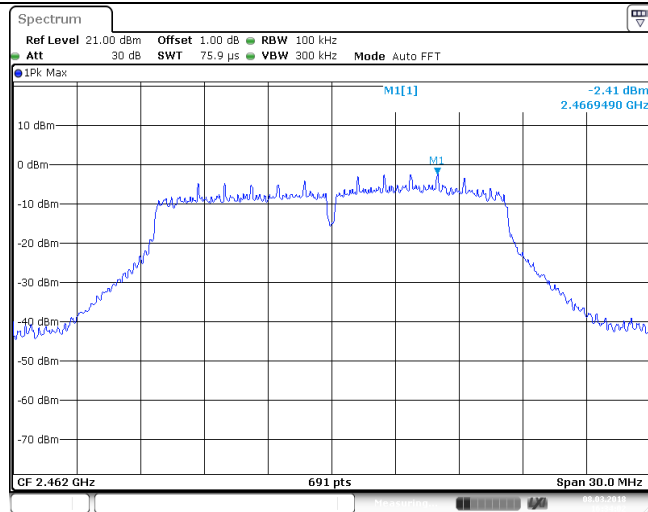

CH11  
30MHz~1000MHz

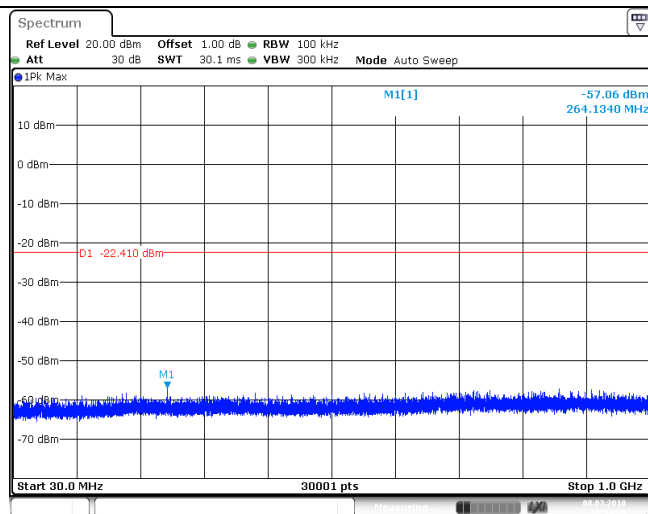

CH11  
1GHz~26GHz

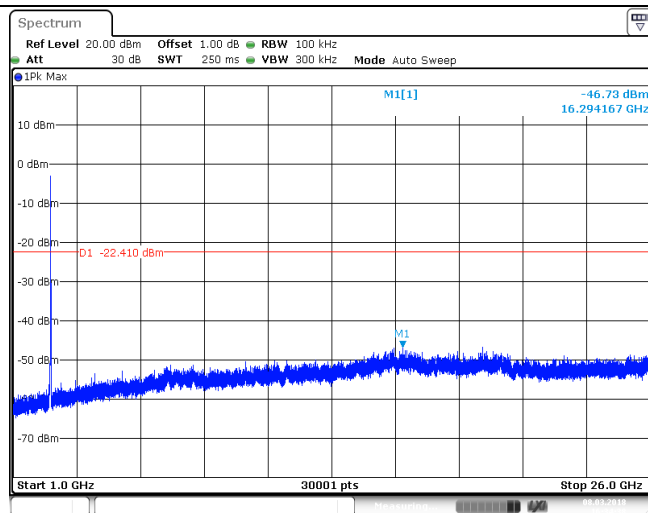

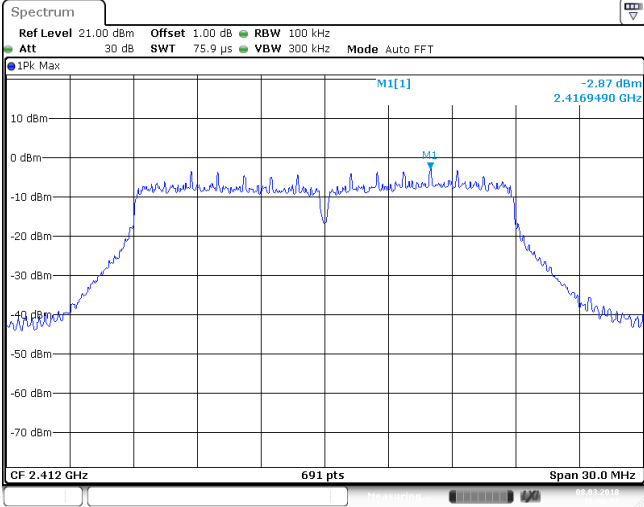
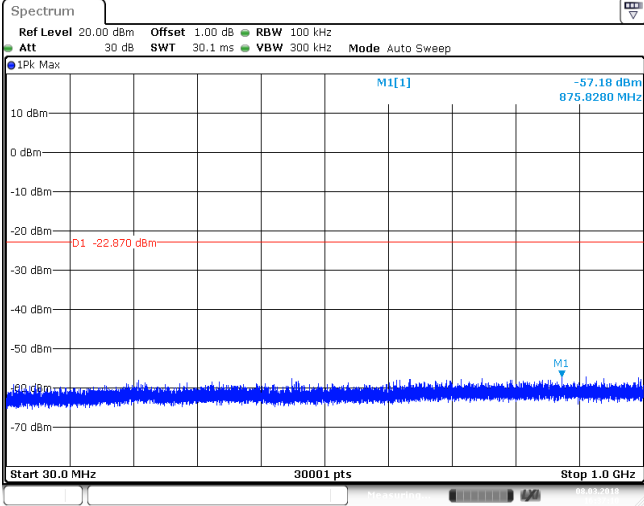
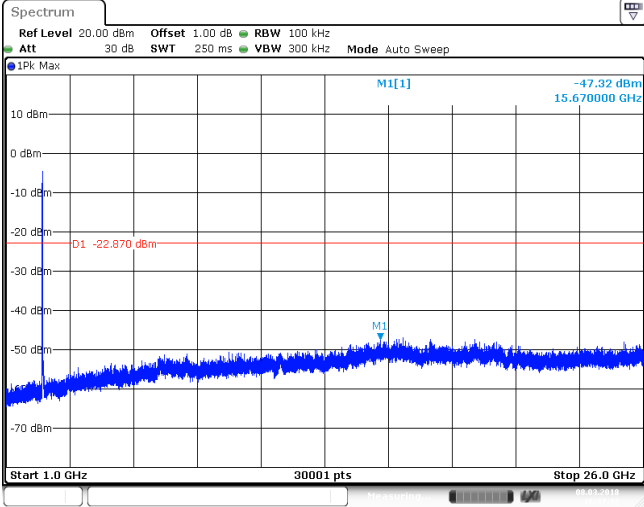

| Test Item:              | SE | Type:  | 802.11 n(HT20) |
|-------------------------|----|--|----------------|
| CH01<br>Reference level |    |    |                |
| CH01<br>30MHz~1000MHz   |    |   |                |
| CH01<br>1GHz~26GHz      |    |  |                |

CH06  
Reference level

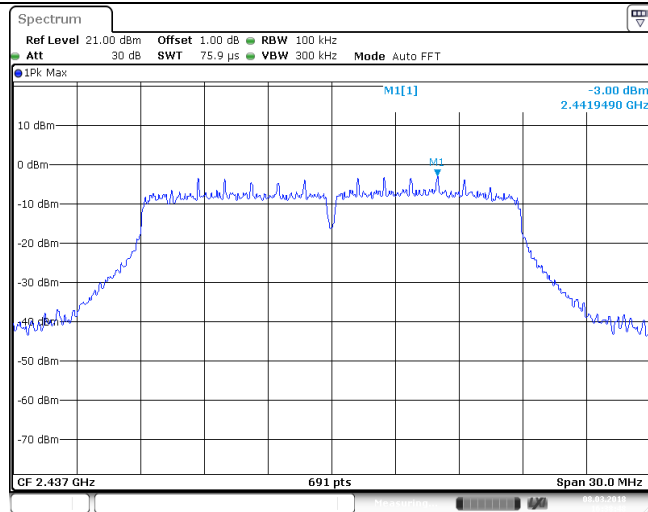

CH06  
30MHz~1000MHz

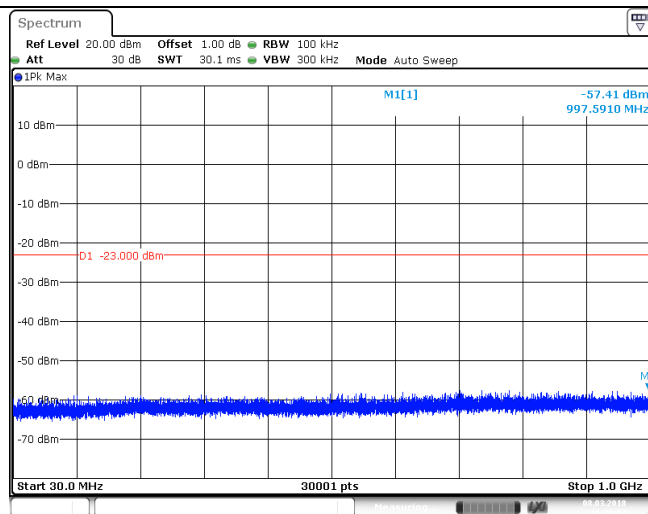

CH06  
1GHz~26GHz

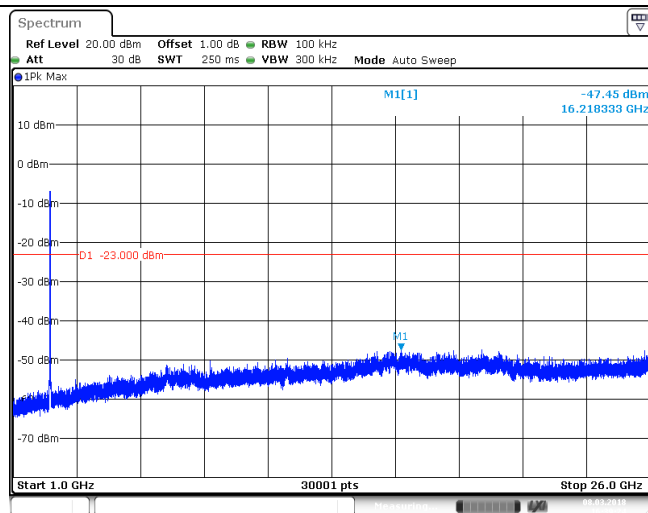

CH11  
Reference level

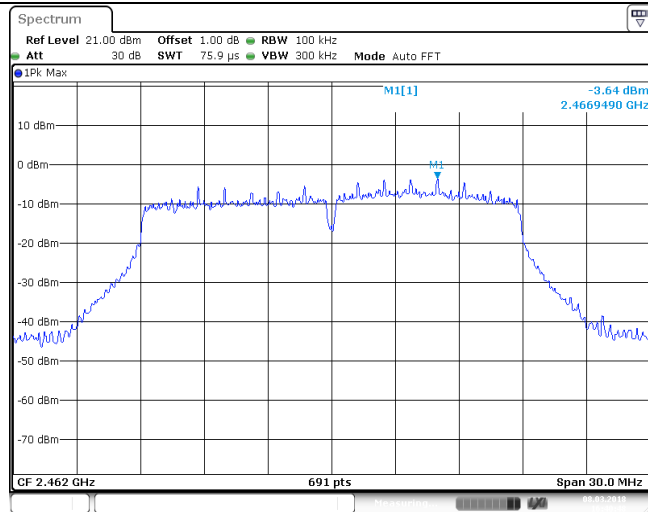

CH11  
30MHz~1000MHz

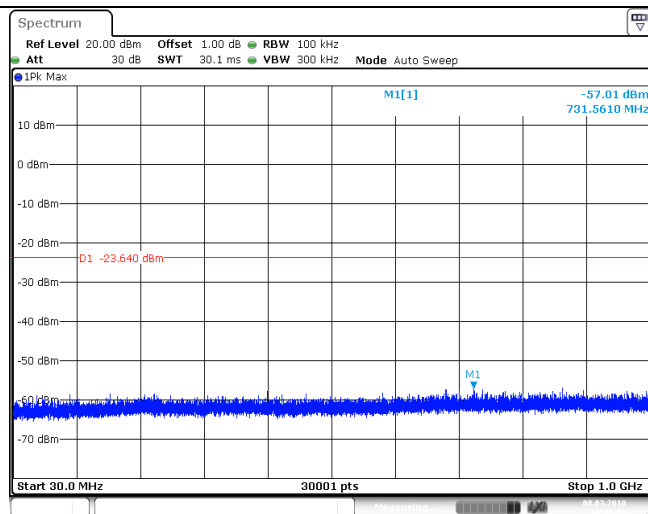

CH11  
1GHz~26GHz

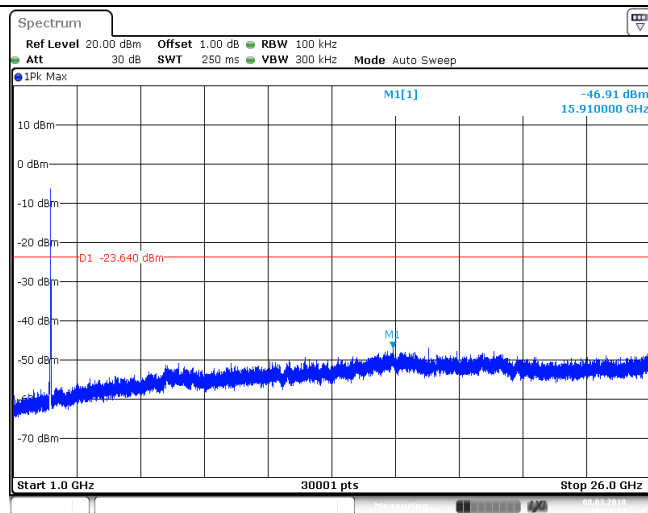

### 5.8. Spurious Emissions (radiated)

#### LIMIT

#### FCC CFR Title 47 Part 15 Subpart C Section 15.209

| Frequency     | Limit (dBuV/m @3m) | Value      |
|---------------|--------------------|------------|
| 30MHz-88MHz   | 40.00              | Quasi-peak |
| 88MHz-216MHz  | 43.50              | Quasi-peak |
| 216MHz-960MHz | 46.00              | Quasi-peak |
| 960MHz-1GHz   | 54.00              | Quasi-peak |
| Above 1GHz    | 54.00              | Average    |
|               | 74.00              | Peak       |

#### TEST CONFIGURATION

➤ 9kHz ~30MHz

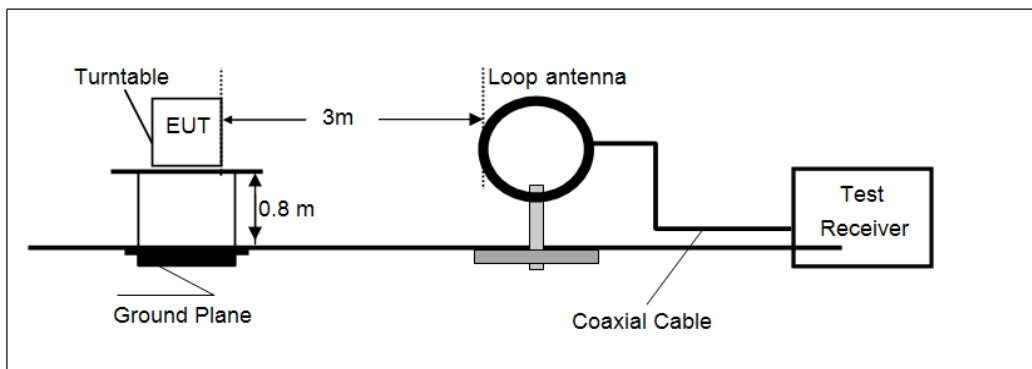

➤ 30MHz ~ 1GHz

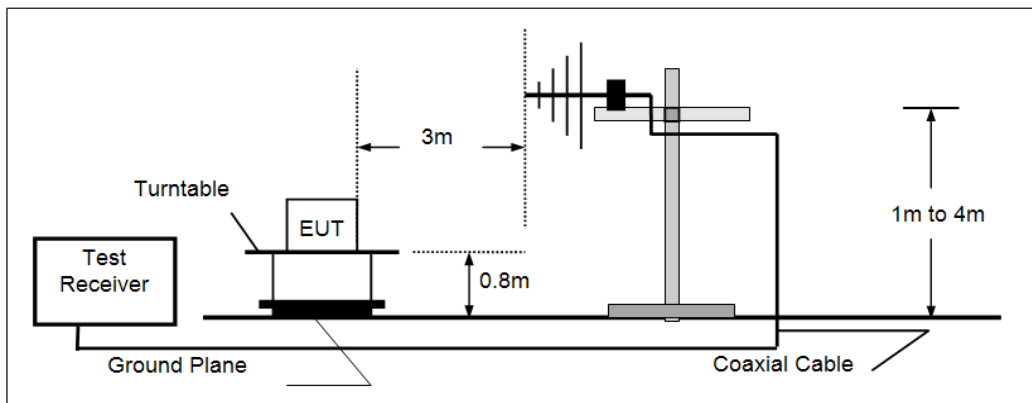

➤ Above 1GHz

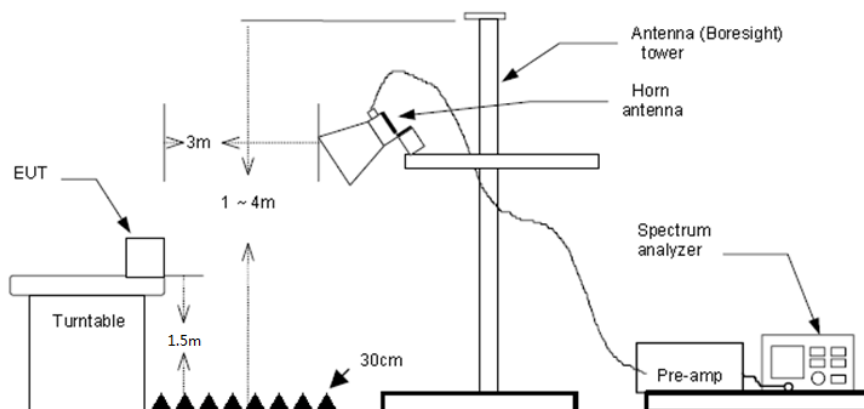

## **TEST PROCEDURE**

1. The EUT was setup and tested according to ANSI C63.10:2013 for compliance to FCC 47CFR 15.247 requirements.
2. The EUT is placed on a turn table which is 0.8 meter above ground for below 1 GHz, and 1.5 m for above 1 GHz. The turn table is rotated 360 degrees to determine the position of the maximum emission level.
3. The EUT was set 3 meters from the receiving antenna, which was mounted on the top of a variable height antenna tower.
4. For each suspected emission, the EUT was arranged to its worst case and then tune the Antenna tower (from 1 m to 4 m) and turntable (from 0 degree to 360 degrees) to find the maximum reading. A pre-amp and a high pass filter are used for the test in order to get better signal level to comply with the guidelines.
5. Set to the maximum power setting and enable the EUT transmit continuously.
6. Use the following spectrum analyzer settings
  - (1) Span shall wide enough to fully capture the emission being measured;
  - (2) Below 1 GHz:  
RBW=120 kHz, VBW=300 kHz, Sweep=auto, Detector function=peak, Trace=max hold;  
If the emission level of the EUT measured by the peak detector is 3 dB lower than the applicable limit, the peak emission level will be reported. Otherwise, the emission measurement will be repeated using the quasi-peak detector and reported.
  - (3) From 1 GHz to 10<sup>th</sup> harmonic:  
RBW=1MHz, VBW=3MHz Peak detector for Peak value.  
RBW=1MHz, VBW=3MHz RMS detector for Average value.

## **TEST MODE:**

Please refer to the clause 3.3

## **TEST RESULTS**

**Passed**       **Not Applicable**

Note:

- 1) Final Level =Receiver Read level + Antenna Factor + Cable Loss – Preamplifier Factor
- 2) The emission levels of other frequencies are very lower than the limit and not show in test report.

### ➤ **9kHz ~ 30MHz**

The EUT was pre-scanned the frequency band (9kHz~30MHz), found the radiated level lower than the limit, so don't show on the report.

### ➤ **30MHz ~1000MHz**

Have pre-scan all modulation mode, found the 802.11b mode CH01 which it was worst case, so only the worst case's data on the test report.

➤ 30MHz ~ 1GHz

Polarization: Vertical

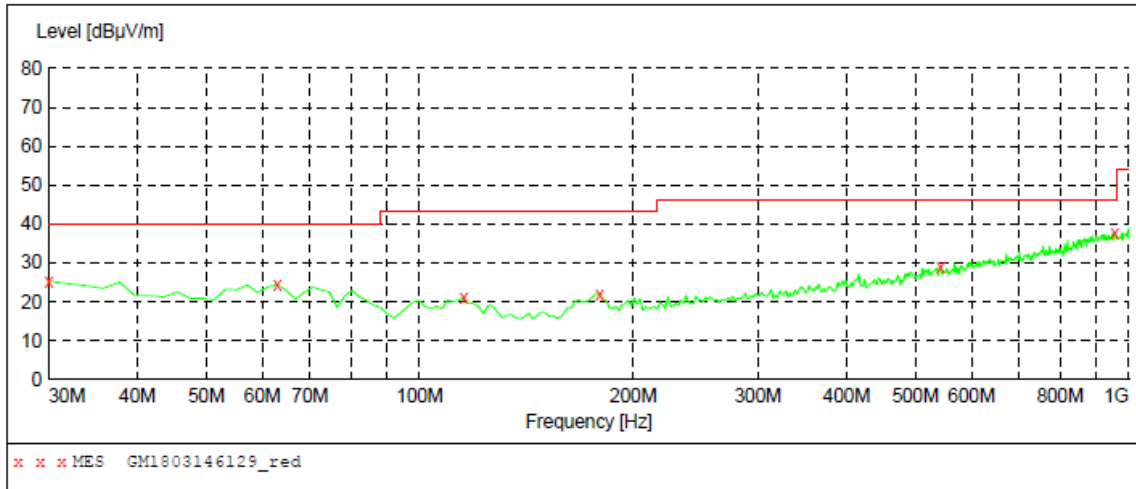

**MEASUREMENT RESULT: "GM1803146129\_red"**

3/14/2018 10:07PM

| Frequency<br>MHz | Level<br>dBµV/m | Transd<br>dB | Limit<br>dBµV/m | Margin<br>dB | Det. | Height<br>cm | Azimuth<br>deg | Polarization |
|------------------|-----------------|--------------|-----------------|--------------|------|--------------|----------------|--------------|
| 30.000000        | 25.40           | -13.3        | 40.0            | 14.6         | QP   | 100.0        | 34.00          | VERTICAL     |
| 62.980000        | 24.50           | -10.8        | 40.0            | 15.5         | QP   | 100.0        | 200.00         | VERTICAL     |
| 115.360000       | 21.10           | -11.6        | 43.5            | 22.4         | QP   | 100.0        | 63.00          | VERTICAL     |
| 179.380000       | 22.10           | -12.3        | 43.5            | 21.4         | QP   | 100.0        | 359.00         | VERTICAL     |
| 542.160000       | 29.00           | -0.9         | 46.0            | 17.0         | QP   | 100.0        | 0.00           | VERTICAL     |
| 955.380000       | 37.70           | 7.3          | 46.0            | 8.3          | QP   | 100.0        | 89.00          | VERTICAL     |

Polarization: Horizontal

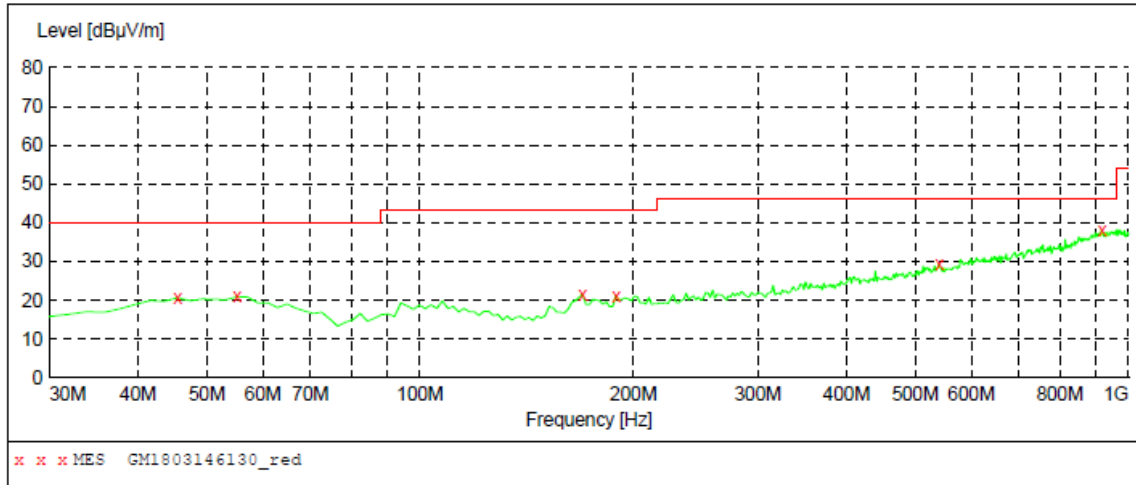

**MEASUREMENT RESULT: "GM1803146130\_red"**

3/14/2018 10:11PM

| Frequency<br>MHz | Level<br>dBµV/m | Transd<br>dB | Limit<br>dBµV/m | Margin<br>dB | Det. | Height<br>cm | Azimuth<br>deg | Polarization |
|------------------|-----------------|--------------|-----------------|--------------|------|--------------|----------------|--------------|
| 45.520000        | 20.70           | -8.8         | 40.0            | 19.3         | QP   | 100.0        | 229.00         | HORIZONTAL   |
| 55.220000        | 20.90           | -9.2         | 40.0            | 19.1         | QP   | 300.0        | 336.00         | HORIZONTAL   |
| 169.680000       | 21.60           | -13.0        | 43.5            | 21.9         | QP   | 300.0        | 294.00         | HORIZONTAL   |
| 189.080000       | 21.20           | -11.2        | 43.5            | 22.3         | QP   | 100.0        | 310.00         | HORIZONTAL   |
| 540.220000       | 29.30           | -1.0         | 46.0            | 16.7         | QP   | 300.0        | 239.00         | HORIZONTAL   |
| 916.580000       | 37.90           | 6.9          | 46.0            | 8.1          | QP   | 100.0        | 68.00          | HORIZONTAL   |

## ➤ 1 GHz ~ 25 GHz

| 802.11b         |                   |                       |                 |                    | CH01           |                     |                 |              |            |
|-----------------|-------------------|-----------------------|-----------------|--------------------|----------------|---------------------|-----------------|--------------|------------|
| Frequency (MHz) | Read Level (dBuV) | Antenna Factor (dB/m) | Cable Loss (dB) | Preamp Factor (dB) | Level (dBuV/m) | Limit Line (dBuV/m) | Over Limit (dB) | Polarization | Test value |
| 1938.35         | 30.25             | 25.69                 | 6.17            | 37.25              | 24.86          | 74.00               | -49.14          | Vertical     | Peak       |
| 3463.29         | 33.45             | 28.71                 | 8.06            | 38.46              | 31.76          | 74.00               | -42.24          | Vertical     | Peak       |
| 5125.52         | 32.21             | 31.80                 | 9.77            | 36.27              | 37.51          | 74.00               | -36.49          | Vertical     | Peak       |
| 6428.77         | 32.11             | 33.50                 | 11.04           | 35.32              | 41.33          | 74.00               | -32.67          | Vertical     | Peak       |
| 1296.47         | 35.16             | 26.20                 | 4.82            | 36.52              | 29.66          | 74.00               | -44.34          | Horizontal   | Peak       |
| 4128.28         | 33.99             | 29.93                 | 8.88            | 37.81              | 34.99          | 74.00               | -39.01          | Horizontal   | Peak       |
| 6203.70         | 32.08             | 32.91                 | 11.01           | 35.29              | 40.71          | 74.00               | -33.29          | Horizontal   | Peak       |
| 7527.83         | 32.92             | 36.13                 | 12.49           | 34.92              | 46.62          | 74.00               | -27.38          | Horizontal   | Peak       |

| 802.11b         |                   |                       |                 |                    | CH06           |                     |                 |              |            |
|-----------------|-------------------|-----------------------|-----------------|--------------------|----------------|---------------------|-----------------|--------------|------------|
| Frequency (MHz) | Read Level (dBuV) | Antenna Factor (dB/m) | Cable Loss (dB) | Preamp Factor (dB) | Level (dBuV/m) | Limit Line (dBuV/m) | Over Limit (dB) | Polarization | Test value |
| 1759.64         | 36.19             | 25.32                 | 5.88            | 37.06              | 30.33          | 74.00               | -43.67          | Vertical     | Peak       |
| 4045.06         | 33.68             | 29.79                 | 8.82            | 38.01              | 34.28          | 74.00               | -39.72          | Vertical     | Peak       |
| 4871.10         | 36.47             | 31.46                 | 9.59            | 36.76              | 40.76          | 74.00               | -33.24          | Vertical     | Peak       |
| 7190.69         | 32.11             | 36.14                 | 11.86           | 35.07              | 45.04          | 74.00               | -28.96          | Vertical     | Peak       |
| 1303.09         | 36.51             | 26.19                 | 4.84            | 36.51              | 31.03          | 74.00               | -42.97          | Horizontal   | Peak       |
| 3747.66         | 35.07             | 29.44                 | 8.44            | 38.24              | 34.71          | 74.00               | -39.29          | Horizontal   | Peak       |
| 4871.10         | 38.89             | 31.46                 | 9.59            | 36.76              | 43.18          | 74.00               | -30.82          | Horizontal   | Peak       |
| 8063.40         | 33.27             | 37.04                 | 12.45           | 34.54              | 48.22          | 74.00               | -25.78          | Horizontal   | Peak       |

| 802.11b         |                   |                       |                 |                    | CH11           |                     |                 |              |            |
|-----------------|-------------------|-----------------------|-----------------|--------------------|----------------|---------------------|-----------------|--------------|------------|
| Frequency (MHz) | Read Level (dBuV) | Antenna Factor (dB/m) | Cable Loss (dB) | Preamp Factor (dB) | Level (dBuV/m) | Limit Line (dBuV/m) | Over Limit (dB) | Polarization | Test value |
| 1222.74         | 37.38             | 26.28                 | 4.70            | 36.56              | 31.80          | 74.00               | -42.20          | Vertical     | Peak       |
| 4065.71         | 34.66             | 29.83                 | 8.83            | 37.96              | 35.36          | 74.00               | -38.64          | Vertical     | Peak       |
| 4920.96         | 39.18             | 31.42                 | 9.62            | 36.62              | 43.60          | 74.00               | -30.40          | Vertical     | Peak       |
| 6561.03         | 32.84             | 34.12                 | 11.29           | 35.35              | 42.90          | 74.00               | -31.10          | Vertical     | Peak       |
| 1698.03         | 34.06             | 25.19                 | 5.76            | 36.93              | 28.08          | 74.00               | -45.92          | Horizontal   | Peak       |
| 2223.98         | 32.50             | 27.65                 | 6.48            | 37.41              | 29.22          | 74.00               | -44.78          | Horizontal   | Peak       |
| 4933.50         | 38.78             | 31.43                 | 9.63            | 36.59              | 43.25          | 74.00               | -30.75          | Horizontal   | Peak       |
| 6156.51         | 32.21             | 32.73                 | 10.94           | 35.32              | 40.56          | 74.00               | -33.44          | Horizontal   | Peak       |

## Remark:

1. Final Level = Receiver Read level + Antenna Factor + Cable Loss – Pre-amplifier Factor
2. The peak level is lower than average limit (54 dBuV/m), this data is the too weak instrument of signal is unable to test.
3. The emission levels of other frequencies (test frequency band is 1GHz to 25GHz) are very lower than the limit and not show in test report.

| 802.11g         |                   |                       |                 |                    | CH01           |                     |                 |              |            |
|-----------------|-------------------|-----------------------|-----------------|--------------------|----------------|---------------------|-----------------|--------------|------------|
| Frequency (MHz) | Read Level (dBuV) | Antenna Factor (dB/m) | Cable Loss (dB) | Preamp Factor (dB) | Level (dBuV/m) | Limit Line (dBuV/m) | Over Limit (dB) | Polarization | Test value |
| 1378.14         | 34.95             | 25.96                 | 4.96            | 36.47              | 29.40          | 74.00               | -44.60          | Vertical     | Peak       |
| 4278.06         | 34.74             | 30.16                 | 9.01            | 37.61              | 36.30          | 74.00               | -37.70          | Vertical     | Peak       |
| 6172.20         | 32.53             | 32.79                 | 10.96           | 35.31              | 40.97          | 74.00               | -33.03          | Vertical     | Peak       |
| 7117.84         | 31.93             | 35.71                 | 11.86           | 34.96              | 44.54          | 74.00               | -29.46          | Vertical     | Peak       |
| 1219.64         | 35.24             | 26.28                 | 4.69            | 36.56              | 29.65          | 74.00               | -44.35          | Horizontal   | Peak       |
| 3681.47         | 35.59             | 29.30                 | 8.36            | 38.25              | 35.00          | 74.00               | -39.00          | Horizontal   | Peak       |
| 4821.76         | 35.26             | 31.56                 | 9.55            | 36.90              | 39.47          | 74.00               | -34.53          | Horizontal   | Peak       |
| 6903.71         | 31.84             | 34.72                 | 11.73           | 34.89              | 43.40          | 74.00               | -30.60          | Horizontal   | Peak       |

| 802.11g         |                   |                       |                 |                    | CH06           |                     |                 |              |            |
|-----------------|-------------------|-----------------------|-----------------|--------------------|----------------|---------------------|-----------------|--------------|------------|
| Frequency (MHz) | Read Level (dBuV) | Antenna Factor (dB/m) | Cable Loss (dB) | Preamp Factor (dB) | Level (dBuV/m) | Limit Line (dBuV/m) | Over Limit (dB) | Polarization | Test value |
| 1293.17         | 35.16             | 26.21                 | 4.82            | 36.52              | 29.67          | 74.00               | -44.33          | Vertical     | Peak       |
| 3104.22         | 34.33             | 28.80                 | 7.61            | 38.21              | 32.53          | 74.00               | -41.47          | Vertical     | Peak       |
| 4321.84         | 33.72             | 30.27                 | 9.06            | 37.60              | 35.45          | 74.00               | -38.55          | Vertical     | Peak       |
| 5125.52         | 33.13             | 31.80                 | 9.77            | 36.27              | 38.43          | 74.00               | -35.57          | Vertical     | Peak       |
| 1537.56         | 33.30             | 25.46                 | 5.39            | 36.64              | 27.51          | 74.00               | -46.49          | Horizontal   | Peak       |
| 3057.17         | 32.94             | 28.72                 | 7.55            | 38.22              | 30.99          | 74.00               | -43.01          | Horizontal   | Peak       |
| 4871.10         | 36.84             | 31.46                 | 9.59            | 36.76              | 41.13          | 74.00               | -32.87          | Horizontal   | Peak       |
| 6235.36         | 33.55             | 32.97                 | 11.01           | 35.29              | 42.24          | 74.00               | -31.76          | Horizontal   | Peak       |

| 802.11g         |                   |                       |                 |                    | CH11           |                     |                 |              |            |
|-----------------|-------------------|-----------------------|-----------------|--------------------|----------------|---------------------|-----------------|--------------|------------|
| Frequency (MHz) | Read Level (dBuV) | Antenna Factor (dB/m) | Cable Loss (dB) | Preamp Factor (dB) | Level (dBuV/m) | Limit Line (dBuV/m) | Over Limit (dB) | Polarization | Test value |
| 1182.94         | 35.68             | 26.17                 | 4.62            | 36.58              | 29.89          | 74.00               | -44.11          | Vertical     | Peak       |
| 3786.01         | 33.87             | 29.56                 | 8.48            | 38.23              | 33.68          | 74.00               | -40.32          | Vertical     | Peak       |
| 4920.96         | 35.04             | 31.42                 | 9.62            | 36.62              | 39.46          | 74.00               | -34.54          | Vertical     | Peak       |
| 7135.98         | 32.15             | 35.82                 | 11.86           | 34.99              | 44.84          | 74.00               | -29.16          | Vertical     | Peak       |
| 1235.26         | 35.69             | 26.26                 | 4.72            | 36.55              | 30.12          | 74.00               | -43.88          | Horizontal   | Peak       |
| 4045.06         | 34.52             | 29.79                 | 8.82            | 38.01              | 35.12          | 74.00               | -38.88          | Horizontal   | Peak       |
| 4933.50         | 39.35             | 31.43                 | 9.63            | 36.59              | 43.82          | 74.00               | -30.18          | Horizontal   | Peak       |
| 6851.19         | 32.38             | 34.36                 | 11.66           | 34.94              | 43.46          | 74.00               | -30.54          | Horizontal   | Peak       |

## Remark:

1. Final Level = Receiver Read level + Antenna Factor + Cable Loss – Preamplifier Factor
2. The peak level is lower than average limit(54 dBuV/m), this data is the too weak instrument of signal is unable to test.
3. The emission levels of other frequencies(test frequency band is 1GHz to 25GHz) are very lower than the limit and not show in test report.



| 802.11n(HT20)   |                   |                       |                 |                    | CH01           |                     |                 |              |            |
|-----------------|-------------------|-----------------------|-----------------|--------------------|----------------|---------------------|-----------------|--------------|------------|
| Frequency (MHz) | Read Level (dBuV) | Antenna Factor (dB/m) | Cable Loss (dB) | Preamp Factor (dB) | Level (dBuV/m) | Limit Line (dBuV/m) | Over Limit (dB) | Polarization | Test value |
| 1795.84         | 34.15             | 25.39                 | 5.95            | 37.13              | 28.36          | 74.00               | -45.64          | Vertical     | Peak       |
| 3359.10         | 35.27             | 28.20                 | 7.91            | 38.48              | 32.90          | 74.00               | -41.10          | Vertical     | Peak       |
| 6267.19         | 32.73             | 33.03                 | 11.00           | 35.30              | 41.46          | 74.00               | -32.54          | Vertical     | Peak       |
| 7413.73         | 33.13             | 36.27                 | 12.11           | 34.83              | 46.68          | 74.00               | -27.32          | Vertical     | Peak       |
| 1457.52         | 33.77             | 25.84                 | 5.16            | 36.53              | 28.24          | 74.00               | -45.76          | Horizontal   | Peak       |
| 4004.08         | 35.05             | 29.71                 | 8.78            | 38.10              | 35.44          | 74.00               | -38.56          | Horizontal   | Peak       |
| 5689.36         | 33.17             | 31.62                 | 10.41           | 35.62              | 39.58          | 74.00               | -34.42          | Horizontal   | Peak       |
| 6662.01         | 32.61             | 34.20                 | 11.43           | 35.25              | 42.99          | 74.00               | -31.01          | Horizontal   | Peak       |

| 802.11n(HT20)   |                   |                       |                 |                    | CH06           |                     |                 |              |            |
|-----------------|-------------------|-----------------------|-----------------|--------------------|----------------|---------------------|-----------------|--------------|------------|
| Frequency (MHz) | Read Level (dBuV) | Antenna Factor (dB/m) | Cable Loss (dB) | Preamp Factor (dB) | Level (dBuV/m) | Limit Line (dBuV/m) | Over Limit (dB) | Polarization | Test value |
| 1267.10         | 35.71             | 26.23                 | 4.77            | 36.53              | 30.18          | 74.00               | -43.82          | Vertical     | Peak       |
| 1702.36         | 34.78             | 25.20                 | 5.77            | 36.93              | 28.82          | 74.00               | -45.18          | Vertical     | Peak       |
| 4641.12         | 34.13             | 31.02                 | 9.48            | 37.17              | 37.46          | 74.00               | -36.54          | Vertical     | Peak       |
| 5217.66         | 36.37             | 31.46                 | 9.86            | 36.25              | 41.44          | 74.00               | -32.56          | Vertical     | Peak       |
| 1273.57         | 35.18             | 26.23                 | 4.79            | 36.53              | 29.67          | 74.00               | -44.33          | Horizontal   | Peak       |
| 1899.28         | 37.73             | 25.30                 | 6.11            | 37.22              | 31.92          | 74.00               | -42.08          | Horizontal   | Peak       |
| 3993.90         | 35.61             | 29.70                 | 8.77            | 38.11              | 35.97          | 74.00               | -38.03          | Horizontal   | Peak       |
| 5791.65         | 33.53             | 32.06                 | 10.58           | 35.34              | 40.83          | 74.00               | -33.17          | Horizontal   | Peak       |

| 802.11n(HT20)   |                   |                       |                 |                    | CH11           |                     |                 |              |            |
|-----------------|-------------------|-----------------------|-----------------|--------------------|----------------|---------------------|-----------------|--------------|------------|
| Frequency (MHz) | Read Level (dBuV) | Antenna Factor (dB/m) | Cable Loss (dB) | Preamp Factor (dB) | Level (dBuV/m) | Limit Line (dBuV/m) | Over Limit (dB) | Polarization | Test value |
| 1296.47         | 35.56             | 26.20                 | 4.82            | 36.52              | 30.06          | 74.00               | -43.94          | Vertical     | Peak       |
| 1755.16         | 35.32             | 25.31                 | 5.87            | 37.05              | 29.45          | 74.00               | -44.55          | Vertical     | Peak       |
| 4267.18         | 34.48             | 30.13                 | 9.00            | 37.62              | 35.99          | 74.00               | -38.01          | Vertical     | Peak       |
| 5940.97         | 32.62             | 32.38                 | 10.65           | 35.41              | 40.24          | 74.00               | -33.76          | Vertical     | Peak       |
| 1750.70         | 36.10             | 25.30                 | 5.86            | 37.04              | 30.22          | 74.00               | -43.78          | Horizontal   | Peak       |
| 4045.06         | 34.66             | 29.79                 | 8.82            | 38.01              | 35.26          | 74.00               | -38.74          | Horizontal   | Peak       |
| 5821.21         | 40.01             | 32.14                 | 10.60           | 35.33              | 47.42          | 74.00               | -26.58          | Horizontal   | Peak       |
| 8484.55         | 32.57             | 36.85                 | 12.87           | 34.37              | 47.92          | 74.00               | -26.08          | Horizontal   | Peak       |

## Remark:

1. Final Level = Receiver Read level + Antenna Factor + Cable Loss – Preamplifier Factor
2. The peak level is lower than average limit(54 dBuV/m), this data is the too weak instrument of signal is unable to test.
3. The emission levels of other frequencies(test frequency band is 1GHz to 25GHz) are very lower than the limit and not show in test report.

## 6. TEST SETUP PHOTOS

Conducted Emissions (AC Mains)



Radiated Emissions



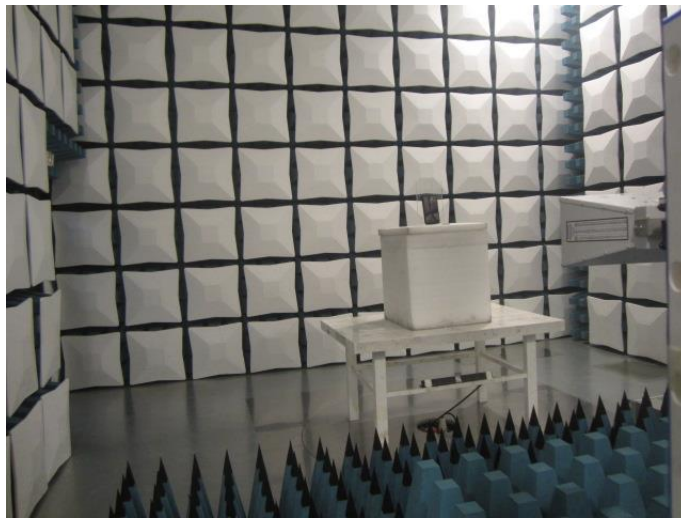

## 7. EXTERANAL AND INTERNAL PHOTOS

Reference to the test report No.: TRE1803002801.

-----End of Report-----