

RF MEASUREMENT REPORT

FCC ID: HD5-CT4XVDWLSPK
Applicant: Honeywell International Inc
Honeywell Safety and Productivity Solutions
Product: Vehicle Dock
Model No.: CT4X-VD-WL-SPK
Brand Name: Honeywell
FCC Classification: FCC Part 15 Spread Spectrum Transmitter (DSS)
FCC Rule Part(s): Part15 Subpart C (Section 15.247)
Result: Complies
Received Date: 2024-03-07
Test Date: 2024-03-27 ~ 2024-03-29

Reviewed By:

Jame Yuan

Approved By:

Robin Wu



The test results relate only to the samples tested.

The test results shown in the test report are traceable to the national/international standards through the calibration of the equipment and evaluated measurement uncertainty herein.

The test report shall not be reproduced except in full without the written approval of MRT Technology (Suzhou) Co., Ltd.

Revision History

Report No.	Version	Description	Issue Date	Note
2403RSU013-U6	V01	Initial Report	2024-03-29	Valid

CONTENTS

Description	Page
1. General Information	6
1.1. Applicant	6
1.2. Manufacturer	6
1.3. Testing Facility	6
1.4. Product Information.....	7
1.5. Radio Specification under Test	7
1.6. Working Frequencies	8
1.7. Pseudorandom Frequency Hopping Sequence.....	9
2. Test Configuration	10
2.1. Test Mode	10
2.2. Test System Connection Diagram	10
2.3. Test Software.....	10
2.4. Applied Standards.....	11
2.5. Test Environment Condition	11
3. Antenna Requirement	12
4. Measuring Instrument	13
5. Decision Rules and Measurement Uncertainty	14
5.1. Decision Rules	14
5.2. Measurement Uncertainty.....	14
6. Test Result.....	15
6.1. Summary.....	15
6.2. Occupied Bandwidth Measurement.....	16
6.2.1. Test Limit.....	16
6.2.2. Test Procedure.....	16
6.2.3. Test Setting	16
6.2.4. Test Setup	16
6.2.5. Test Result	16
6.3. Output Power Measurement.....	17
6.3.1. Test Limit.....	17
6.3.2. Test Procedure.....	17
6.3.3. Test Setting	17
6.3.4. Test Setup	17
6.3.5. Test Result	17
6.4. Carrier Frequency Separation Measurement	18
6.4.1. Test Limit.....	18
6.4.2. Test Procedure.....	18

6.4.3.	Test Setting	18
6.4.4.	Test Setup	18
6.4.5.	Test Result	18
6.5.	Number of Hopping Channels Measurement	19
6.5.1.	Test Limit	19
6.5.2.	Test Procedure	19
6.5.3.	Test Settintg	19
6.5.4.	Test Setup	19
6.5.5.	Test Result	19
6.6.	Time of Occupancy Measurement	20
6.6.1.	Test Limit	20
6.6.2.	Test Procedure	20
6.6.3.	Test Settintg	20
6.6.4.	Test Setup	20
6.6.5.	Test Result	20
6.7.	Band-edge Compliance Measurement	21
6.7.1.	Test Limit	21
6.7.2.	Test Procedure	21
6.7.3.	Test Setting	21
6.7.4.	Test Setup	21
6.7.5.	Test Result	21
6.8.	Conducted Spurious Emissions Measurement	22
6.8.1.	Test Limit	22
6.8.2.	Test Procedure	22
6.8.3.	Test Setting	22
6.8.4.	Test Setup	22
6.8.5.	Test Result	23
6.9.	Radiated Spurious Emission Measurement	24
6.9.1.	Test Limit	24
6.9.2.	Test Procedure	24
6.9.3.	Test Setting	24
6.9.4.	Test Setup	26
6.9.5.	Test Result	27
6.10.	Radiated Restricted Band Edge Measurement	28
6.10.1.	Test Limit	28
6.10.2.	Test Procedure	29
6.10.3.	Test Setting	29
6.10.4.	Test Setup	30
6.10.5.	Test Result	30

6.11.	AC Conducted Emissions Measurement	31
6.11.1.	Test Limit	31
6.11.2.	Test Setup	31
6.11.3.	Test Result	31
Appendix A - Test Result.....		32
A.1	Duty Cycle Test Result	32
A.2	20dB Bandwidth Test Result	33
A.3	Output Power Test Result	37
A.4	Carrier Frequency Separation Test Result.....	41
A.5	Number of Hopping Channels Test Result.....	45
A.6	Time of Occupancy Test Result	48
A.7	Band-edge Compliance Test Result.....	51
A.8	Conducted Spurious Emissions Test Result	54
A.9	Radiated Spurious Emission Test Result	58
A.10	Radiated Restricted Band Edge Test Result.....	63
Appendix B - Test Setup Photograph		87
Appendix C - EUT Photograph		88

1.4. Product Information

Product Name	Vehicle Dock
Model No.	CT4X-VD-WL-SPK
EUT Identification No.	20240307Sample#05(Conducted Sample) 20240307Sample#06(Radiated Sample)
Brand Name	Honeywell
WPT Specification	144kHz
NFC Specification	13.56MHz(tag)
Bluetooth Specification	V5.0 (Dual Mode)
Antenna Information	Refer to Section 1.5
Power Voltage	12/24VDC
Operating Temperature	-20~50 °C
<p>Note: The information of EUT was provided by the manufacturer, and the accuracy of the information shall be the responsibility of the manufacturer.</p>	

1.5. Radio Specification under Test

Operating Frequency	2402~2480MHz
Channel Number	79
Type of modulation	GFSK, Pi/4 DQPSK, 8DPSK
Data Rate	1Mbps, 2Mbps, 3Mbps
Antenna Type	PCB Antenna
Antenna Gain	-0.50 dBi

Note:

- 15.247(g): In accordance with the Bluetooth Industry Standard, the system is designed to comply with all of the regulations in Section 15.247 when the transmitter is presented with a continuous data (or information) system.
- 15.247(h): In accordance with the Bluetooth Industry Standard, the system does not coordinate its channels selection/ hopping sequence with other frequency hopping systems for the express purpose of avoiding the simultaneous occupancy of individual hopping frequencies by multiple transmitters.
- 15.247(h): The EUT employs Adaptive Frequency Hopping (AFH) which identifies sources of interference namely devices operating in 802.11 WLAN and excludes them from the list of available channels. The process of re-mapping reduces the number of test channels from 79 channels to a minimum number of 20 channels.

1.6. Working Frequencies

Channel	Frequency	Channel	Frequency	Channel	Frequency
00	2402 MHz	01	2403 MHz	02	2404 MHz
03	2405 MHz	04	2406 MHz	05	2407 MHz
06	2408 MHz	07	2409 MHz	08	2410 MHz
09	2411 MHz	10	2412 MHz	11	2413 MHz
12	2414 MHz	13	2415 MHz	14	2416 MHz
15	2417 MHz	16	2418 MHz	17	2419 MHz
18	2420 MHz	19	2421 MHz	20	2422 MHz
21	2423 MHz	22	2424 MHz	23	2425 MHz
24	2426 MHz	25	2427 MHz	26	2428 MHz
27	2429 MHz	28	2430 MHz	29	2431 MHz
30	2432 MHz	31	2433 MHz	32	2434 MHz
33	2435 MHz	34	2436 MHz	35	2437 MHz
36	2438 MHz	37	2439 MHz	38	2440 MHz
39	2441 MHz	40	2442 MHz	41	2443 MHz
42	2444 MHz	43	2445 MHz	44	2446 MHz
45	2447 MHz	46	2448 MHz	47	2449 MHz
48	2450 MHz	49	2451 MHz	50	2452 MHz
51	2453 MHz	52	2454 MHz	53	2455 MHz
54	2456 MHz	55	2457 MHz	56	2458 MHz
57	2459 MHz	58	2460 MHz	59	2461 MHz
60	2462 MHz	61	2463 MHz	62	2464 MHz
63	2465 MHz	64	2466 MHz	65	2467 MHz
66	2468 MHz	67	2469 MHz	68	2470 MHz
69	2471 MHz	70	2472 MHz	71	2473 MHz
72	2474 MHz	73	2475 MHz	74	2476 MHz
75	2477 MHz	76	2478 MHz	77	2479 MHz
78	2480 MHz	--	--	--	--

1.7. Pseudorandom Frequency Hopping Sequence

The pseudorandom sequence may be generated in a nine-stage shift register whose 5th and 9th stage outputs are added in a modulo-two addition stage. And the result is fed back to the input of the first stage. The sequence begins with the first ONE of 9 consecutive ONES; i.e. the shift register is initialized with nine ones.

- Number of shift register stages: 9
- Length of pseudo-random sequence: $2^9 - 1 = 511$ bits
- Longest sequence of zeros: 8 (non-inverted signal)

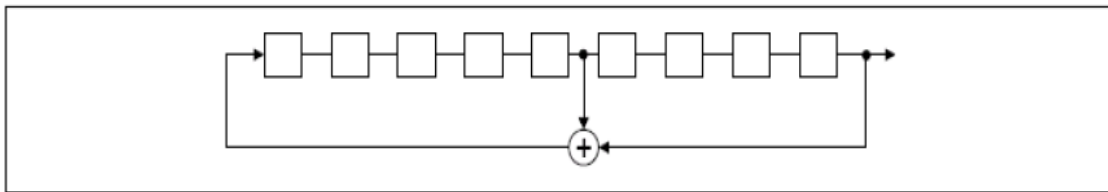

Linear Feedback Shift Register for Generation of the PRBS sequence

An example of Pseudorandom Frequency Hopping Sequence as follow:

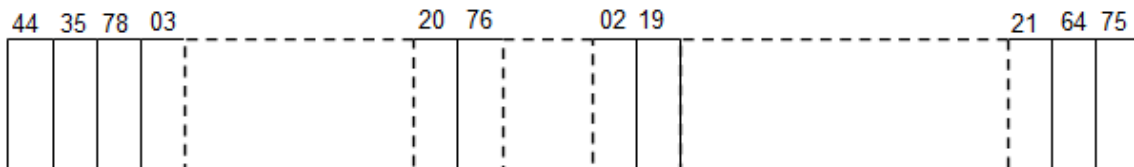

Each frequency used equally on the average by each transmitter.

The system receivers have input bandwidths that match the hopping channel bandwidths of their Corresponding transmitters and shift frequencies in synchronization with the transmitted signals.

2. Test Configuration

2.1. Test Mode

Mode 1: Transmit by DH5
Mode 2: Transmit by 2DH5
Mode 3: Transmit by 3DH1
Mode 4: Transmit by 3DH3
Mode 5: Transmit by 3DH5

2.2. Test System Connection Diagram

The device was tested per the guidance ANSI C63.10: 2013 was used to reference the appropriate EUT setup for radiated emissions testing and AC line conducted testing.

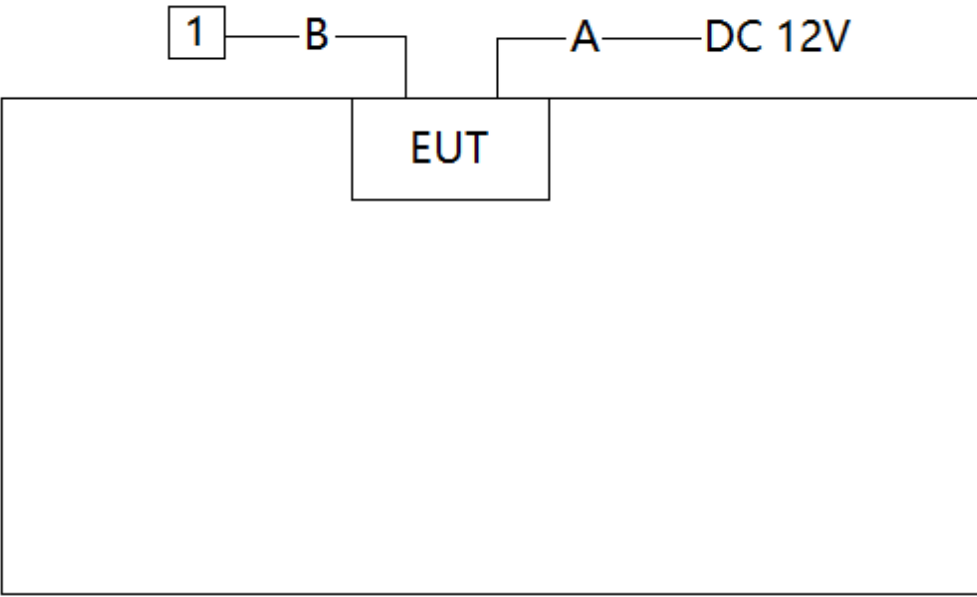
Connection Diagram			
			
Cable Type		Manufacturer	Model No.
A	Power Cable	Non-shielded	1.5m
B	Coaxial Cable	Non-shielded	1.5m
Product		Manufacturer	Model No.
1	Notebook	Lenovo	E495

2.3. Test Software

The test utility software used during testing was “cybluetool”, and the version was 0.1.97.1.

2.4. Applied Standards

According to the specifications of the manufacturer, the EUT must comply with the requirements of the following standards:

- FCC Part 15.247
- KDB 558074 D01v05r02
- ANSI C63.10-2013

2.5. Test Environment Condition

Ambient Temperature	15 ~ 35 °C
Relative Humidity	20 ~75 %RH

3. Antenna Requirement

Excerpt from §15.203 of the FCC Rules/Regulations:

“An intentional radiator antenna shall be designed to ensure that no antenna other than that furnished by the responsible party can be used with the device. The use of a permanently attached antenna or of an antenna that uses a unique coupling to the intentional radiator shall be considered sufficient to comply with the provisions of this section.”

- The antenna of the device is **permanently attached**.
- There are no provisions for connection to an external antenna.

Conclusion:

The unit complies with the requirement of §15.203.

4. Measuring Instrument

Instrument	Manufacturer	Model No.	Asset No.	Cali. Interval	Cali. Due Date	Test Site
EMI Test Receiver	R&S	ESR3	MRTSUE06185	1 year	2024-12-17	SIP-AC2
Signal Analyzer	Keysight	N9010B	MRTSUE06559	1 year	2024-05-23	SIP-AC2
Horn Antenna	Schwarzbeck	BBHA 9170	MRTSUE06598	1 year	2024-11-04	SIP-AC2
Preamplifier	EMCI	EMC051845SE	MRTSUE06601	1 year	2024-11-02	SIP-AC2
Preamplifier	EMCI	EMC184045SE	MRTSUE06602	1 year	2024-10-09	SIP-AC2
Thermohygrometer	testo	608-H1	MRTSUE06622	1 year	2024-11-03	SIP-AC2
TRILOG Antenna	Schwarzbeck	VULB 9168	MRTSUE06647	1 year	2024-06-17	SIP-AC2
Horn Antenna	Schwarzbeck	BBHA 9120D	MRTSUE06648	1 year	2024-10-21	SIP-AC2
Anechoic Chamber	RIKEN	SIP-AC2	MRTSUE06781	1 year	2024-12-21	SIP-AC2
Loop Antenna	Schwarzbeck	FMZB 1519 B	MRTSUE06937	1 year	2025-01-27	SIP-AC2
USB Power Sensor	Keysight	U2021XA	MRTSUE06596	1 year	2024-07-31	SIP-TR1
Signal Analyzer	Keysight	N9010B	MRTSUE07036	1 year	2025-02-03	SIP-TR1
Thermohygrometer	testo	608-H1	MRTSUE11022	1 year	2024-10-28	SIP-TR1

Software	Version	Function
EMI Software	V3.0.0	EMI Test Software
BenchVue Power Meter	2018.1	Power
Controller_T-E-TAC-2	1.02	RE Antenna & Turntable

5. Decision Rules and Measurement Uncertainty

5.1. Decision Rules

The Decision Rule is based on Simple Acceptance in accordance with ISO Guide 98-4: 2012 Clause 8.2. (Measurement uncertainty is not taken into account when stating conformity with a specified requirement.)

5.2. Measurement Uncertainty

Where relevant, the following test uncertainty levels have been estimated for tests performed on the EUT as specified in CISPR 16-4-2. This uncertainty represents an expanded uncertainty expressed at approximately the 95% confidence level using a coverage factor of $k = 2$.

AC Conducted Emission Measurement
The maximum measurement uncertainty is evaluated as: 9kHz~150kHz: 3.58dB 150kHz~30MHz: 3.20dB
Radiated Emission Measurement
The maximum measurement uncertainty is evaluated as: Coaxial: 9kHz~30MHz: 2.61dB Coplanar: 9kHz~30MHz: 2.62dB Horizontal: 30MHz~200MHz: 3.79dB 200MHz~1GHz: 3.91dB 1GHz~40GHz: 4.99dB Vertical: 30MHz~200MHz: 4.06dB 200MHz~1GHz: 5.21dB 1GHz~40GHz: 4.90dB
Spurious Emissions, Conducted
Measuring Uncertainty for a Level of Confidence of 95% ($U=2Uc(y)$): 2.2dB
Output Power
Measuring Uncertainty for a Level of Confidence of 95% ($U=2Uc(y)$): 1.4dB
Power Spectrum Density
Measuring Uncertainty for a Level of Confidence of 95% ($U=2Uc(y)$): 2.2dB
Occupied Bandwidth
Measuring Uncertainty for a Level of Confidence of 95% ($U=2Uc(y)$): 2.7%

6. Test Result

6.1. Summary

FCC Section(s)	Test Description	Test Condition	Verdict
15.247(a)(1)	20dB Bandwidth	Conducted	Pass
15.247(b)(1)	Peak Transmitter Output Power		Pass
15.247(a)(1)	Channel Separation		Pass
15.247(a)(1)(iii)	Number of Channels		Pass
15.247(a)(1)(iii)	Time of Occupancy		Pass
15.247(d)	Band Edge / Out- of-Band Emissions		Pass
15.205, 15.209	General Field Strength (Restricted Bands and Radiated Emission)	Radiated	Pass
15.207	AC Conducted Emissions 150kHz - 30MHz	Line Conducted	N/A

Notes:

- The analyzer plots shown in this section were all taken with a correction table loaded into the analyzer. The correction table was used to account for the losses of the cables and attenuators used as part of the system to connect the EUT to the analyzer at all frequencies of interest.
- “N/A” means that this item is not applicable, and the detail information refer to relevant section.

6.2. Occupied Bandwidth Measurement

6.2.1. Test Limit

N/A

6.2.2. Test Procedure

ANSI C63.10-2013 - Section 6.9.2 (20dB Bandwidth)

6.2.3. Test Setting

1. Set RBW = 1% to 5% of the 20dB bandwidth
2. VBW = approximately three times RBW
3. Span = approximately 2 to 5 times the 20dB bandwidth, centered on a hopping channel
4. Detector = Peak
5. Trace mode = max hold
6. Sweep = auto couple
7. Allow the trace to stabilize
8. Measure the maximum width of the emission that is constrained by the frequencies associated with the two outermost amplitude points (upper and lower frequencies) that are attenuated by 20 dB relative to the maximum level measured in the fundamental emission.

6.2.4. Test Setup

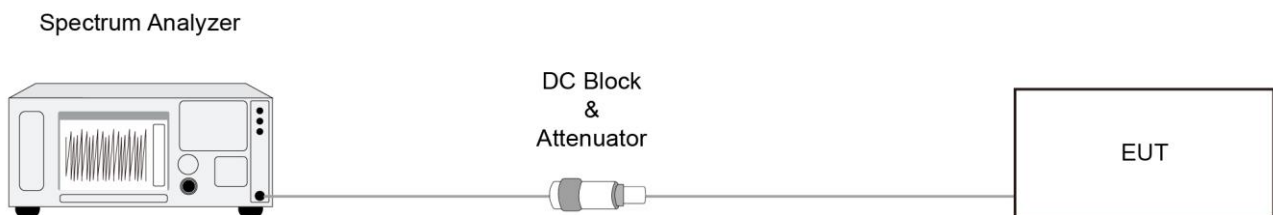

6.2.5. Test Result

Refer to Appendix A.2.

6.3. Output Power Measurement

6.3.1. Test Limit

For frequency hopping systems operating in the 2400-2483.5MHz band employing at least 75 non-overlapping hopping channels: 1 watt (30dBm). For all other frequency hopping systems in the 2400 - 2483.5MHz band: 0.125 watt (20.97dBm).

6.3.2. Test Procedure

ANSI C63.10-2013 - Section 7.8.5

6.3.3. Test Setting

1. Set RBW \geq the 20 dB bandwidth of the emission being measured.
2. VBW \geq RBW
3. Span = approximately five times the 20dB bandwidth, centered on a hopping channel
4. Detector = Peak
5. Trace mode = max hold
6. Sweep = auto couple
7. Allow the trace to stabilize, Use the marker-to-peak function to set the marker to the peak of the emission.
The indicated level is the peak output power (don't forget added the external attenuation and cable loss)

6.3.4. Test Setup

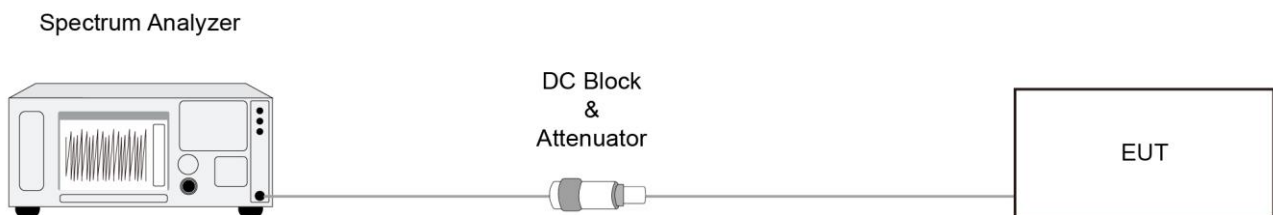

6.3.5. Test Result

Refer to Appendix A.3.

6.4. Carrier Frequency Separation Measurement

6.4.1. Test Limit

The minimum permissible channel separation for this system is $2/3$ the value of the 20dB BW.

6.4.2. Test Procedure

ANSI C63.10-2013 - Section 7.8.2.

6.4.3. Test Setting

1. Span = wide enough to capture the peaks of two adjacent channels.
2. Start with the RBW set to approximately 30% of the channel spacing; adjust as necessary to best identify the center of each individual channel.
3. VBW \geq RBW
4. Sweep time = Auto couple
5. Detector = Peak
6. Trace mode = Max hold
7. Allowed the trace to stabilize
8. Use the marker-delta function to determine the separation between the peaks of the adjacent channels.

6.4.4. Test Setup

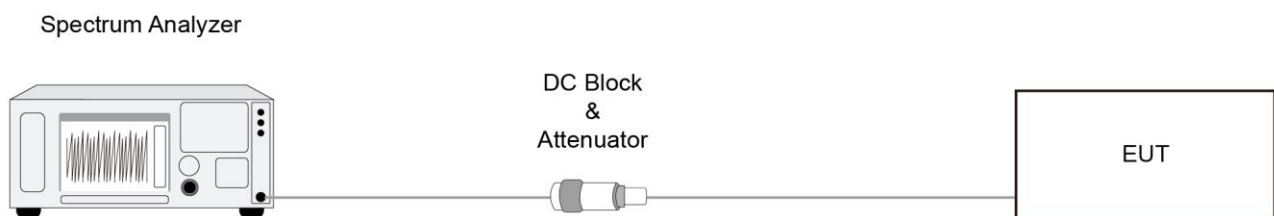

6.4.5. Test Result

Refer to Appendix A.4.

6.5. Number of Hopping Channels Measurement

6.5.1. Test Limit

This frequency hopping system must employ a minimum of 15 hopping channels.

6.5.2. Test Procedure

ANSI C63.10-2013 - Section 7.8.3.

6.5.3. Test Setting

1. Span = the frequency band of operation. Depending on the number of channels the device supports, it may be necessary to divide the frequency range of operation across multiple spans, to allow the individual channels to be clearly seen.
2. To identify clearly the individual channels, set the RBW to less than 30% of the channel spacing or the 20 dB bandwidth, whichever is smaller.
3. VBW \geq RBW
4. Sweep time = Auto couple
5. Detector = Peak
6. Trace mode = Max hold
7. Allow the trace to stabilize

6.5.4. Test Setup

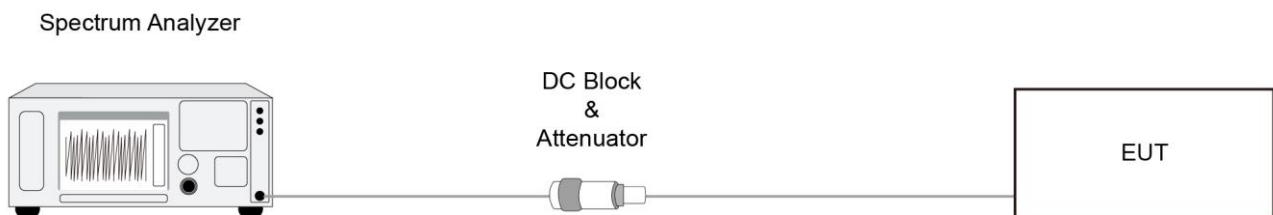

6.5.5. Test Result

Refer to Appendix A.5.

6.6. Time of Occupancy Measurement

6.6.1. Test Limit

The maximum permissible time of occupancy is 400ms within a period of 400ms multiplied by the number of hopping channels employed.

6.6.2. Test Procedure

ANSI C63.10-2013 - Section 7.8.4.

6.6.3. Test Setting

1. Span = zero span, centered on a hopping channel.
2. RBW shall be \leq channel spacing and where possible RBW should be set $\gg 1 / T$, where T is the expected dwell time per channel.
3. VBW \geq RBW
4. Sweep time = as necessary to capture the entire dwell time per hopping channel
5. Detector = Peak
6. Trace mode = max hold
7. Use the marker-delta function to determine the transmit time per hop. If this value varies with different modes of operation (data rate, modulation format, number of hopping channels, etc.), then repeat this test for each variation in transmit time. An oscilloscope may be used instead of a spectrum analyzer. The EUT shall show compliance with the appropriate regulatory limit for the number of hopping channels. A plot of the data shall be included in the test report.

6.6.4. Test Setup

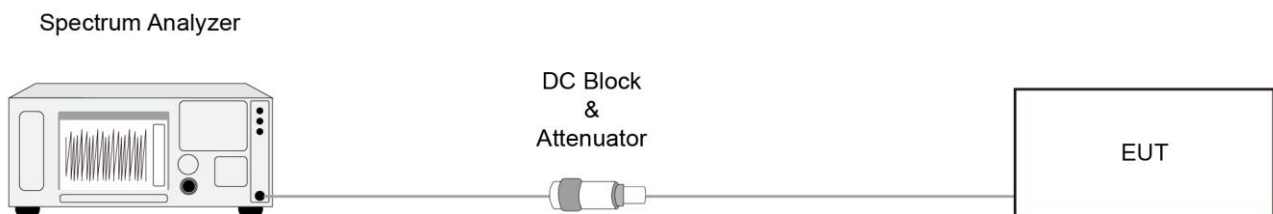

6.6.5. Test Result

Refer to Appendix A.6.

6.7. Band-edge Compliance Measurement

6.7.1. Test Limit

The maximum permissible emission level is 20dBc. Any emissions were lying outside of the emission bandwidth and in authorized band edges to a field strength limit specified in Section 15.209 of the Title 47 CFR.

6.7.2. Test Procedure

ANSI C63.10-2013 - Section 6.10.4.

6.7.3. Test Setting

1. Span = wide enough to capture the peak level of the emission operating on the channel closest to the band edge, as well as any modulation products which fall outside of the authorized band of operation.
2. RBW = 100kHz
3. VBW = 300kHz
4. Detector = peak
5. Sweep time = auto couple
6. Trace mode = max hold
7. Trace was allowed to stabilize
8. Allow the trace to stabilize. Set the marker on the emission at the band edge, or on the highest modulation product outside of the band, if this level is greater than that at the band edge. Enable the marker-delta function, then use the marker-to-peak function to move the marker to the peak of the in-band emission.

6.7.4. Test Setup

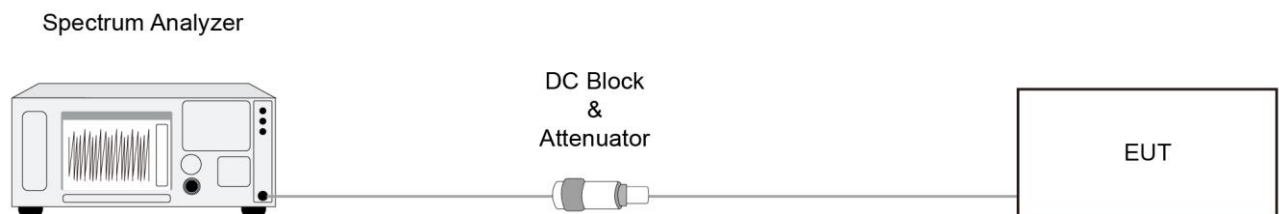

6.7.5. Test Result

Refer to Appendix A.7.

6.8. Conducted Spurious Emissions Measurement

6.8.1. Test Limit

In any 100 kHz bandwidth outside the frequency band in which the spread spectrum or digitally modulated intentional radiator is operating, the radio frequency power that is produced by the intentional radiator shall be at least 20 dB below that in the 100 kHz bandwidth within the band that contains the highest level of the desired power, based on either an RF conducted or a radiated measurement, provided the transmitter demonstrates compliance with the peak conducted or a radiated measurement, provided the transmitter demonstrates compliance with the peak conducted power limits. If the transmitter complies with the conducted power limits based on the use of RMS averaging over a time interval, the attenuation required under this paragraph shall be 30 dB instead of 20 dB.

6.8.2. Test Procedure

ANSI C63.10-2013 - Section 7.8.8.

6.8.3. Test Setting

1. Span = wide enough to capture the peak level of the in-band emission and all spurious emissions (e.g., harmonics) from the lowest frequency generated in the EUT up through the 10th harmonic. Typically, several plots are required to cover this entire span.
2. RBW = 100KHz
3. VBW = 300KHz
4. Detector = peak
5. Sweep time = auto couple
6. Trace mode = max hold
7. Trace was allowed to stabilize
8. Set the marker on the peak of any spurious emission recorded. The level displayed must comply with the limit specified in this section.

6.8.4. Test Setup

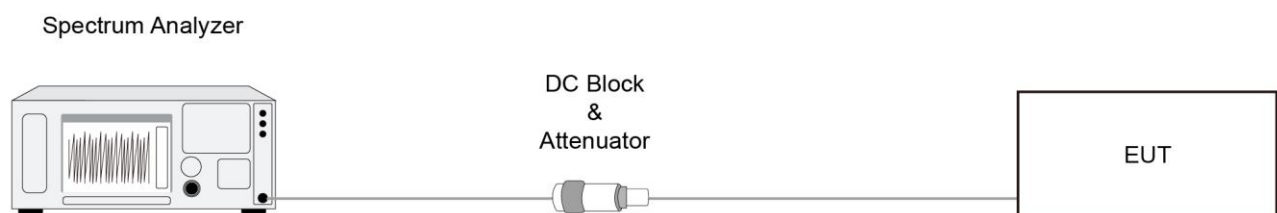

6.8.5. Test Result

Refer to Appendix A.8.

6.9. Radiated Spurious Emission Measurement

6.9.1. Test Limit

All out of band emissions appearing in a restricted band as specified in Section 15.205 of the Title 47 CFR must not exceed the limits shown in Table per Section 15.209.

FCC Part 15 Subpart C Paragraph 15.209		
Frequency [MHz]	Field Strength [uV/m]	Measured Distance [Meters]
0.009 - 0.490	2400/F (kHz)	300
0.490 - 1.705	24000/F (kHz)	30
1.705 - 30	30	30
30 - 88	100	3
88 - 216	150	3
216 - 960	200	3
Above 960	500	3

6.9.2. Test Procedure

ANSI C63.10 Section 6.3 (General Requirements)

ANSI C63.10 Section 6.4 (Standard test method below 30MHz)

ANSI C63.10 Section 6.5 (Standard test method above 30MHz to 1GHz)

ANSI C63.10 Section 6.6 (Standard test method above 1GHz)

6.9.3. Test Setting

Table 1 - RBW as a function of frequency

Frequency	RBW
9 ~ 150 kHz	200 ~ 300 Hz
0.15 ~ 30 MHz	9 ~ 10 kHz
30 ~ 1000 MHz	100 ~ 120 kHz
> 1000 MHz	1 MHz

Quasi-Peak Measurements below 1GHz

1. Analyzer center frequency was set to the frequency of the radiated spurious emission of interest
2. Span was set greater than 1MHz
3. RBW = as specified in Table 1
4. Detector = CISPR quasi-peak
5. Sweep time = auto couple
6. Trace was allowed to stabilize

Peak Measurements above 1GHz

1. Analyzer center frequency was set to the frequency of the radiated spurious emission of interest
2. RBW = 1MHz
3. VBW = 3MHz
4. Detector = peak
5. Sweep time = auto couple
6. Trace mode = max hold
7. Trace was allowed to stabilize

Average Measurements above 1GHz (Method VB)

1. Analyzer center frequency was set to the frequency of the radiated spurious emission of interest
2. RBW = 1MHz
3. VBW; If the EUT is configured to transmit with duty cycle $\geq 98\%$, set VBW = 10 Hz.
If the EUT duty cycle is $< 98\%$, set VBW $\geq 1/T$. T is the minimum transmission duration.
4. Detector = Peak
5. Sweep time = auto
6. Trace mode = max hold
7. Trace was allowed to stabilize

6.9.4. Test Setup

Below 30MHz Test Setup:

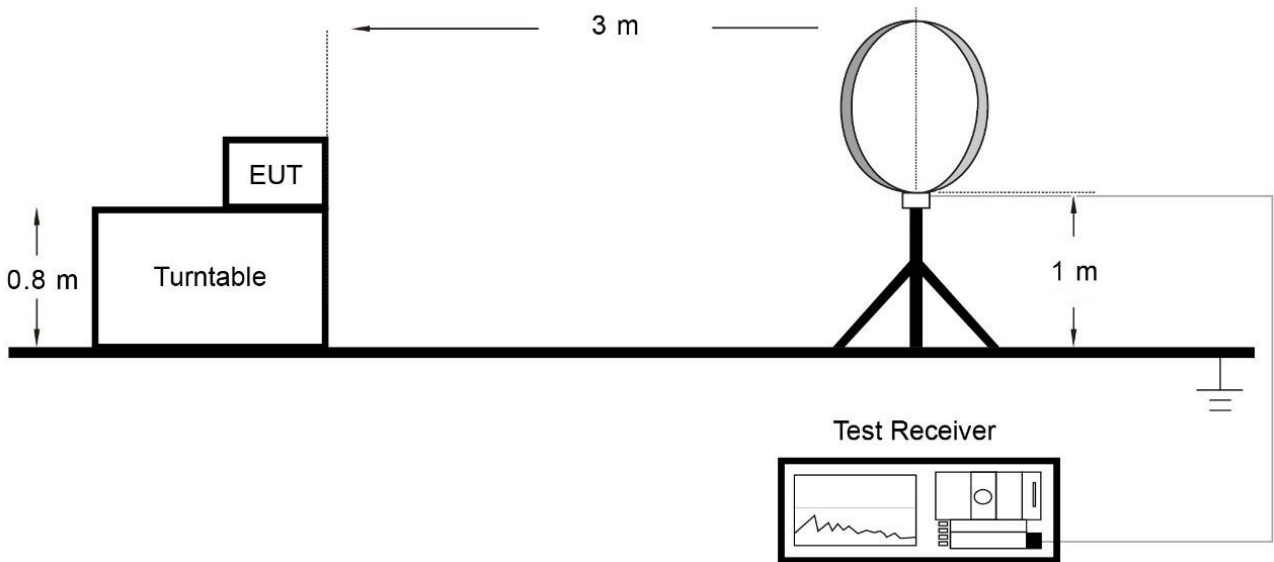

Below 1GHz Test Setup:

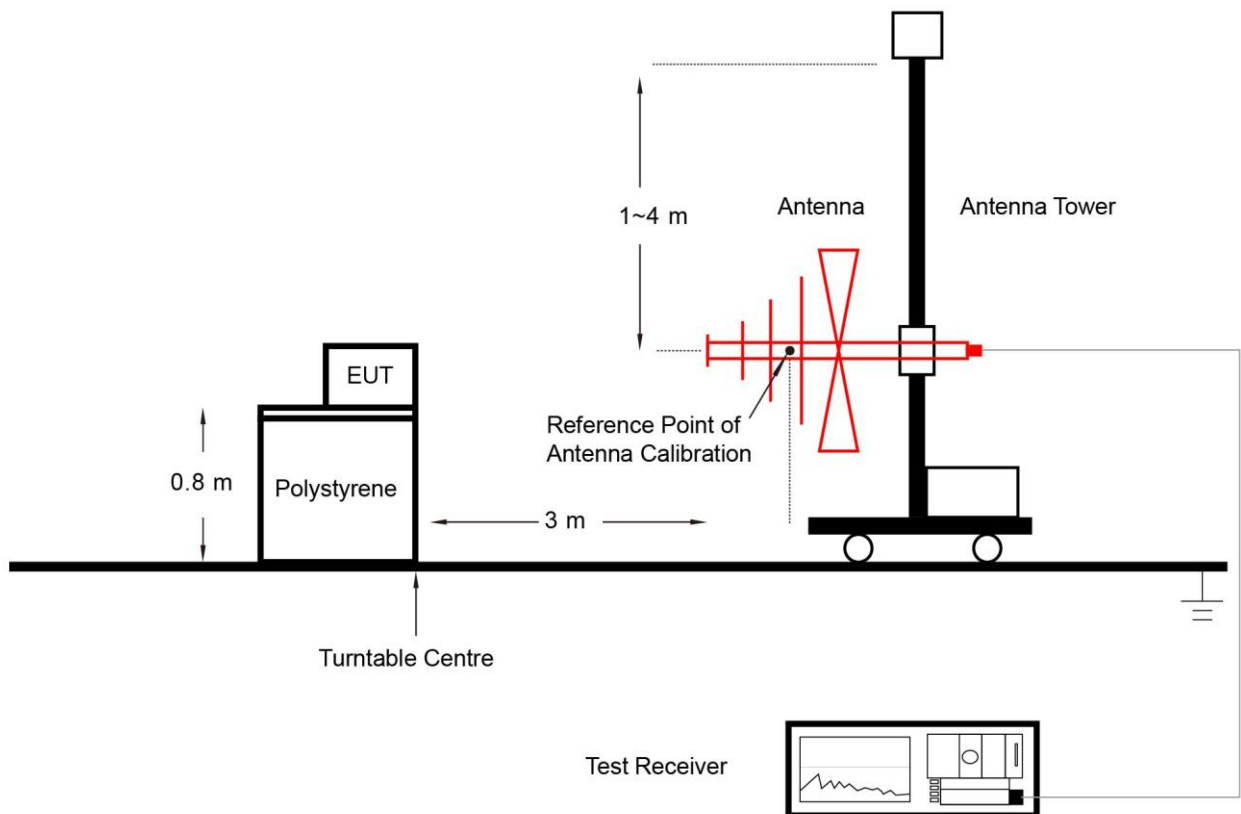

Above 1GHz Test Setup:

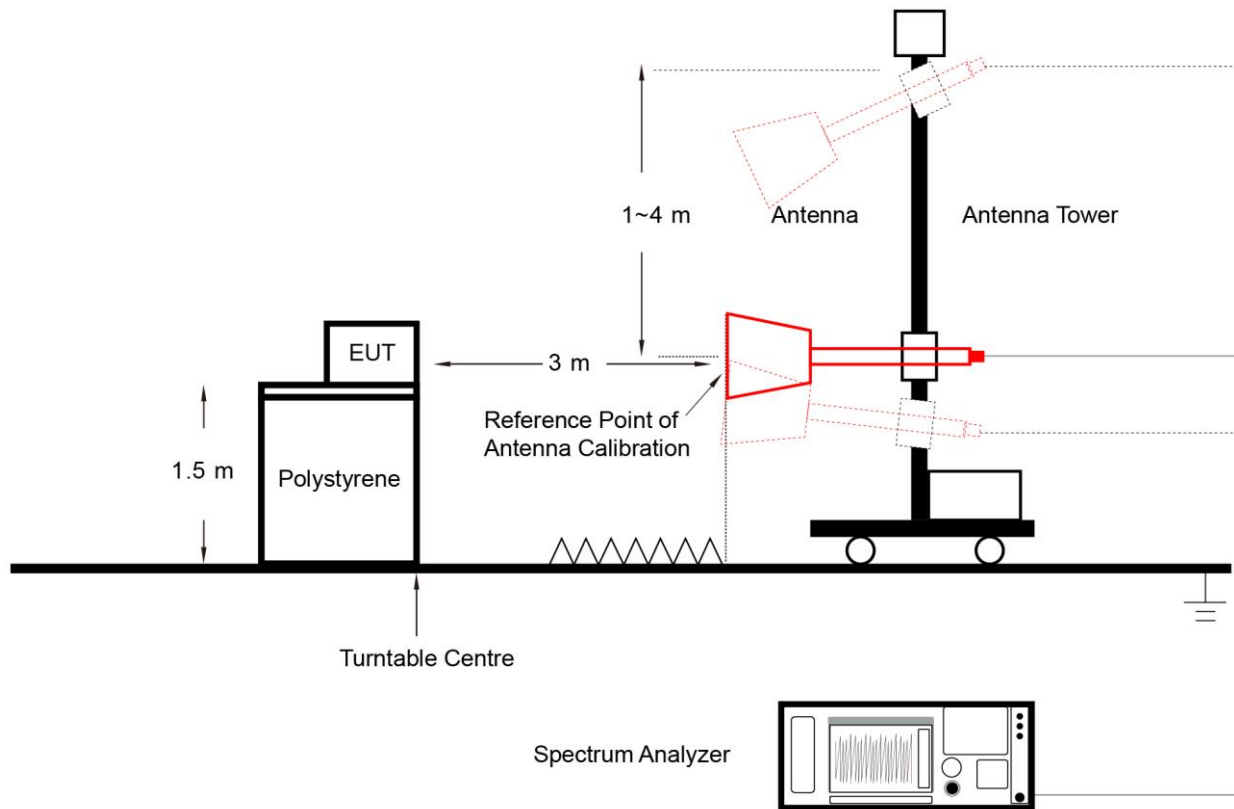

6.9.5. Test Result

Refer to Appendix A.9.

6.10. Radiated Restricted Band Edge Measurement

6.10.1. Test Limit

For 15.205 requirement:

Radiated emissions which fall in the restricted bands, as defined in Section 15.205(a) of FCC part 15, must also comply with the radiated emission limits specified in Section 15.209(a).

Frequency (MHz)	Frequency (MHz)	Frequency (MHz)	Frequency (GHz)
0.090 - 0.110	16.42 - 16.423	399.9 - 410	4.5 - 5.15
¹ 0.495 - 0.505	16.69475 - 16.69525	608 - 614	5.35 - 5.46
2.1735 - 2.1905	16.80425 - 16.80475	960 - 1240	7.25 - 7.75
4.125 - 4.128	25.5 - 25.67	1300 - 1427	8.025 - 8.5
4.17725 - 4.17775	37.5 - 38.25	1435 - 1626.5	9.0 - 9.2
4.20725 - 4.20775	73 - 74.6	1645.5 - 1646.5	9.3 - 9.5
6.215 - 6.218	74.8 - 75.2	1660 - 1710	10.6 - 12.7
6.26775 - 6.26825	108 - 121.94	1718.8 - 1722.2	13.25 - 13.4
6.31175 - 6.31225	123 - 138	2200 - 2300	14.47 - 14.5
8.291 - 8.294	149.9 - 150.05	2310 - 2390	15.35 - 16.2
8.362 - 8.366	156.52475 - 156.52525	2483.5 - 2500	17.7 - 21.4
8.37625 - 8.38675	156.7 - 156.9	2690 - 2900	22.01 - 23.12
8.41425 - 8.41475	162.0125 - 167.17	3260 - 3267	23.6 - 24.0
12.29 - 12.293	167.72 - 173.2	3332 - 3339	31.2 - 31.8
12.51975 - 12.52025	240 - 285	3345.8 - 3358	36.43 - 36.5
12.57675 - 12.57725	322 - 335.4	3600 - 4400	(²)
13.36 - 13.41	--	--	--

All out of band emissions appearing in a restricted band as specified in Section 15.205 of the Title 47CFR must not exceed the limits shown in Table per Section 15.209.

FCC Part 15 Subpart C Paragraph 15.209		
Frequency [MHz]	Field Strength [uV/m]	Measured Distance [Meters]
0.009 - 0.490	2400/F (kHz)	300
0.490 - 1.705	24000/F (kHz)	30
1.705 - 30	30	30
30 - 88	100	3
88 - 216	150	3
216 - 960	200	3
Above 960	500	3

6.10.2. Test Procedure

ANSI C63.10 Section 6.3 (General Requirements)

ANSI C63.10 Section 6.6 (Standard test method above 1GHz)

6.10.3. Test Setting

Peak Field Strength Measurements

1. Analyzer center frequency was set to the frequency of the radiated spurious emission of interest
2. RBW = 1MHz
3. VBW = 3MHz
4. Detector = peak
5. Sweep time = auto couple
6. Trace mode = max hold
7. Trace was allowed to stabilize

Average Measurements above 1GHz (Method VB)

1. Analyzer center frequency was set to the frequency of the radiated spurious emission of interest
2. RBW = 1MHz
3. VBW; If the EUT is configured to transmit with duty cycle $\geq 98\%$, set VBW = 10 Hz.
If the EUT duty cycle is $< 98\%$, set VBW $\geq 1/T$. T is the minimum transmission duration.
4. Detector = Peak
5. Sweep time = auto
6. Trace mode = max hold
7. Trace was allowed to stabilize

6.10.4. Test Setup

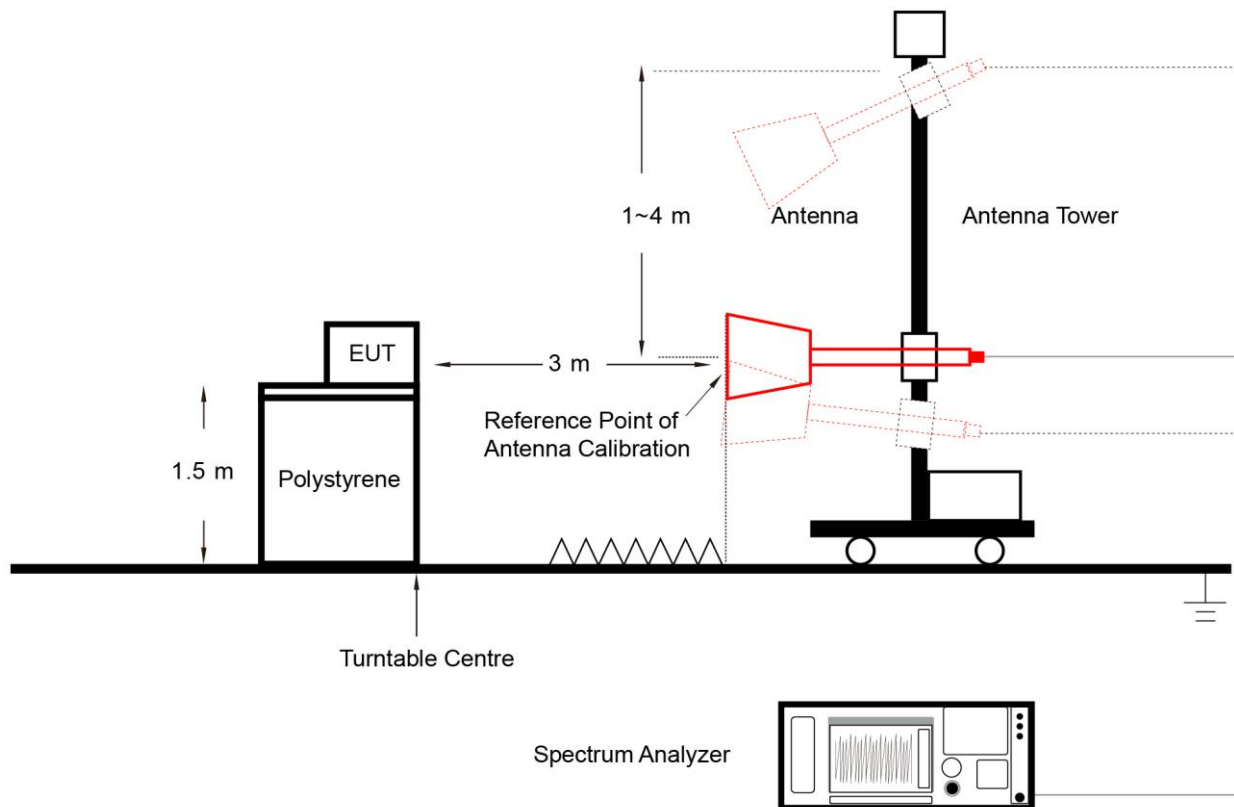

6.10.5. Test Result

Refer to Appendix A.10.

6.11. AC Conducted Emissions Measurement

6.11.1. Test Limit

FCC Part 15 Subpart C Paragraph 15.207 Limits		
Frequency (MHz)	QP (dB μ V)	Average (dB μ V)
0.15 - 0.50	66 - 56	56 - 46
0.50 - 5.0	56	46
5.0 - 30	60	50

Note 1: The lower limit shall apply at the transition frequencies.

Note 2: The limit decreases linearly with the logarithm of the frequency in the range 0.15MHz to 0.5MHz.

6.11.2. Test Setup

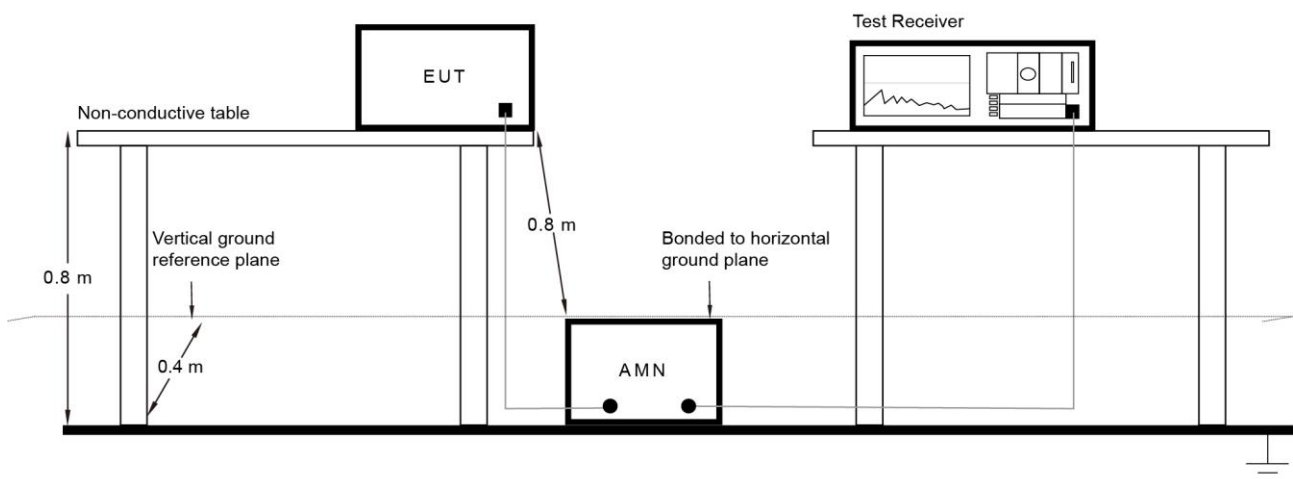

6.11.3. Test Result

The EUT is powered by DC 12V&24V, so this item is not applicable.

Appendix A - Test Result

A.1 Duty Cycle Test Result

Test Site	SIP-TR1	Test Engineer	Ryan Wang
Test Date	2024-03-28		

Test Mode	Duty Cycle
DH5	76.53%
2DH5	76.53%
3DH5	76.80%

Duty Cycle

DH5 (T = 2.87ms)

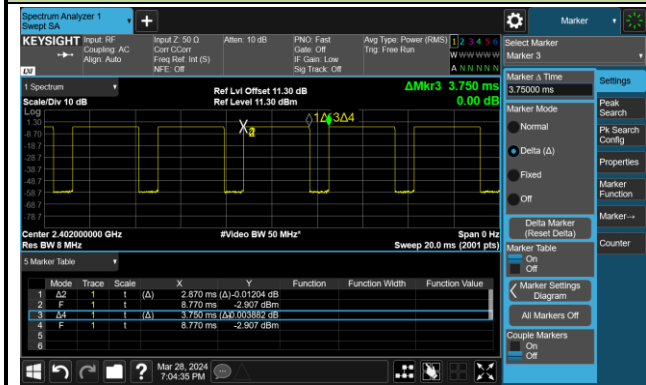

2DH5 (T = 2.87ms)

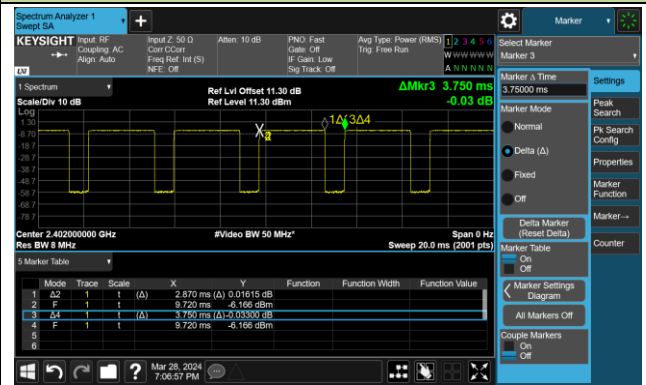

3DH5 (T = 2.88ms)

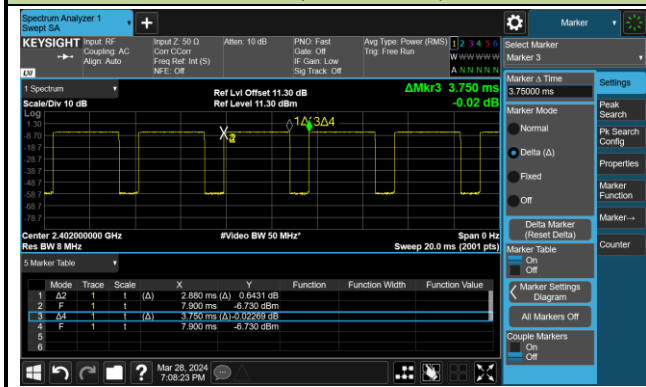

A.2 20dB Bandwidth Test Result

Test Site	SIP-TR1	Test Engineer	Ryan Wang
Test Date	2024-03-28		

Test Mode	Channel No.	Frequency (MHz)	20dB Bandwidth (kHz)	Result
DH5	00	2402	886.1	Pass
DH5	39	2441	883.9	Pass
DH5	78	2480	886.5	Pass
2DH5	00	2402	1339.0	Pass
2DH5	39	2441	1339.0	Pass
2DH5	78	2480	1338.0	Pass
3DH5	00	2402	1318.0	Pass
3DH5	39	2441	1319.0	Pass
3DH5	78	2480	1319.0	Pass

DH5 20dB Bandwidth

Channel 00 (2402MHz)



Channel 39 (2441MHz)

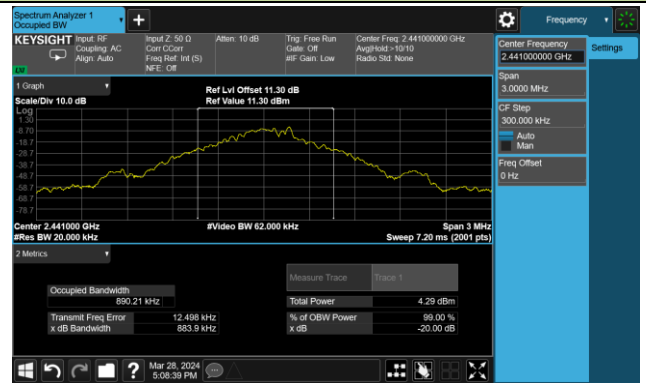

Channel 78 (2480MHz)



2DH5 20dB Bandwidth

Channel 00 (2402MHz)

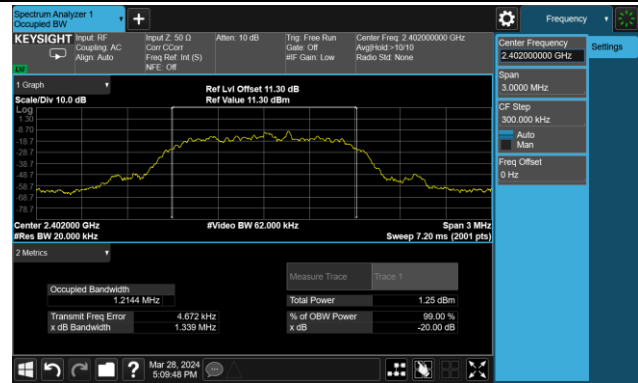

Channel 39 (2441MHz)

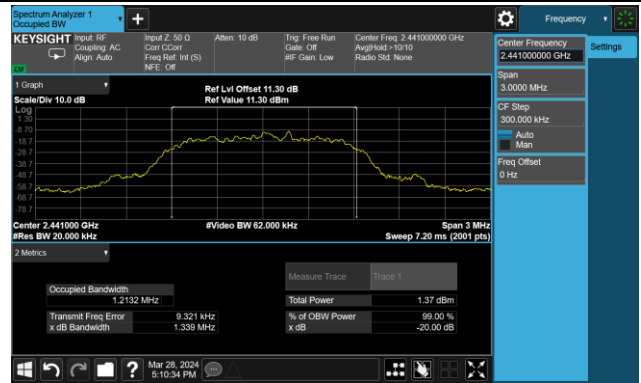

Channel 78 (2480MHz)

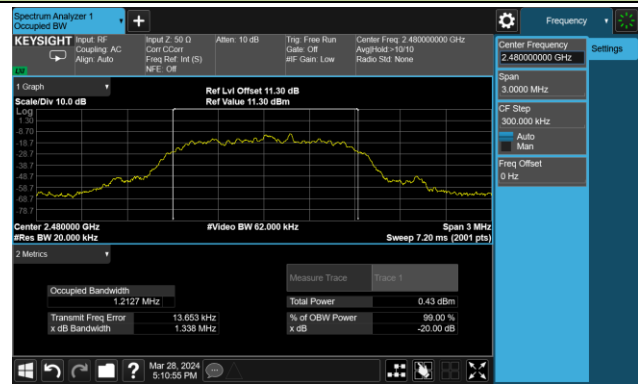

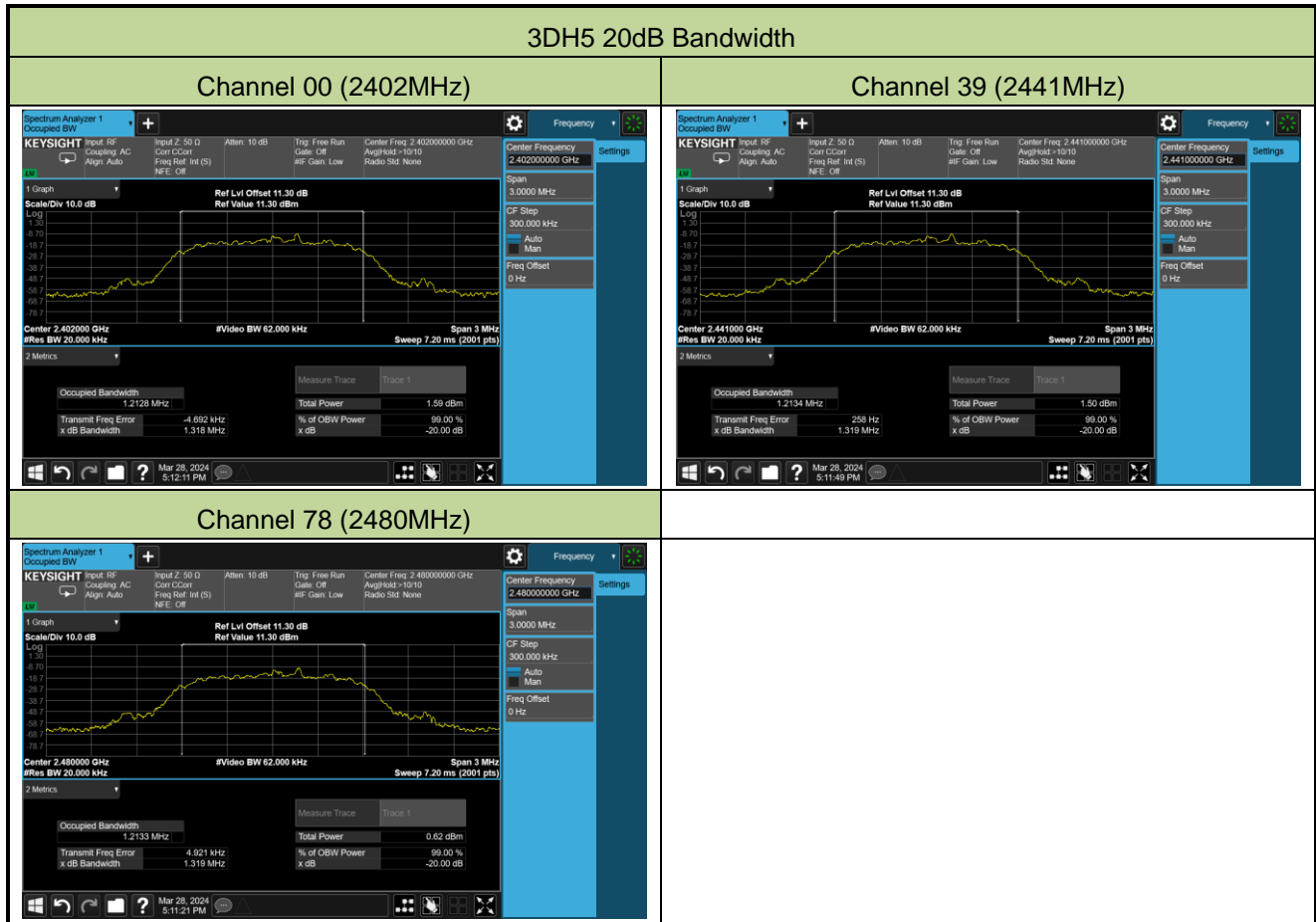

A.3 Output Power Test Result

Test Site	SIP-TR1	Test Engineer	Ryan Wang
Test Date	2024-03-28 ~ 2024-03-29		

Test Mode	Channel No.	Frequency (MHz)	Output Power (dBm)	Power Limit (dBm)
DH5	00	2402	-2.82	≤ 20.97
DH5	39	2441	-2.85	≤ 20.97
DH5	78	2480	-3.51	≤ 20.97
2DH5	00	2402	-1.97	≤ 20.97
2DH5	39	2441	-1.81	≤ 20.97
2DH5	78	2480	-2.46	≤ 20.97
3DH5	00	2402	-1.52	≤ 20.97
3DH5	39	2441	-1.49	≤ 20.97
3DH5	78	2480	-2.11	≤ 20.97

DH5 Output Power

Channel 00 (2402MHz)

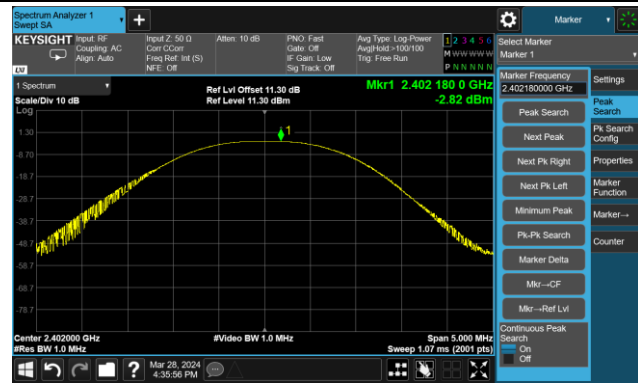

Channel 39 (2441MHz)

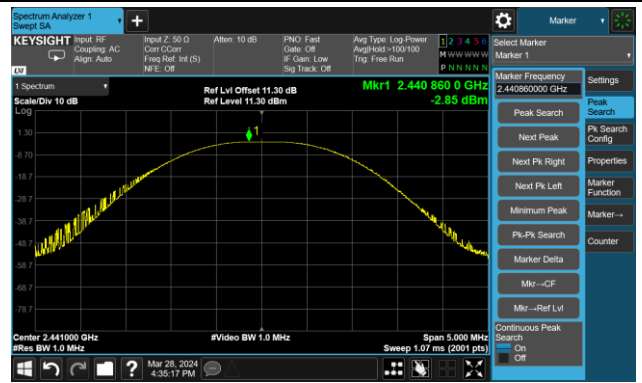

Channel 78 (2480MHz)



2DH5 Output Power

Channel 00 (2402MHz)

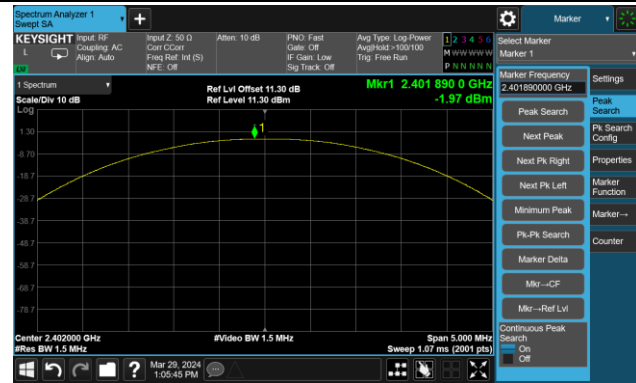

Channel 39 (2441MHz)



Channel 78 (2480MHz)



3DH5 Output Power

Channel 00 (2402MHz)

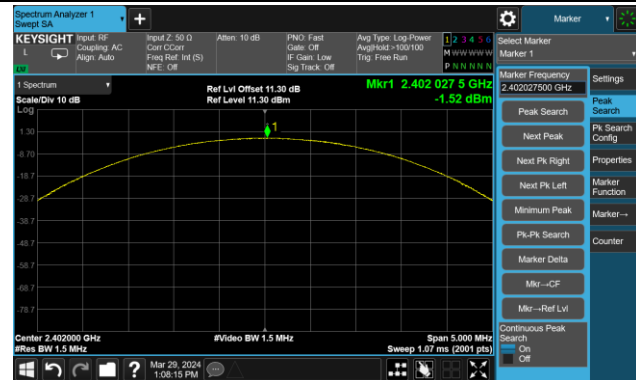

Channel 39 (2441MHz)



Channel 78 (2480MHz)



A.4 Carrier Frequency Separation Test Result

Test Site	SIP-TR1	Test Engineer	Ryan Wang
Test Date	2024-03-28 ~ 2024-03-29		

Test Mode	Channel No.	Frequency (MHz)	Carrier Frequency Separation (kHz)	Limit (kHz)	Result
DH5	00	2402	1000	≥ 590.7	Pass
DH5	39	2441	1000	≥ 589.3	Pass
DH5	78	2480	1000	≥ 591.0	Pass
2DH5	00	2402	1000	≥ 892.7	Pass
2DH5	39	2441	1000	≥ 892.7	Pass
2DH5	78	2480	1000	≥ 892.0	Pass
3DH5	00	2402	1000	≥ 878.7	Pass
3DH5	39	2441	1000	≥ 879.3	Pass
3DH5	78	2480	1000	≥ 879.3	Pass

Note: The Limit is 2/3 the value of the 20dB BW.

DH5 Carrier Frequency Separation

Channel 00 (2402MHz)



Channel 39 (2441MHz)

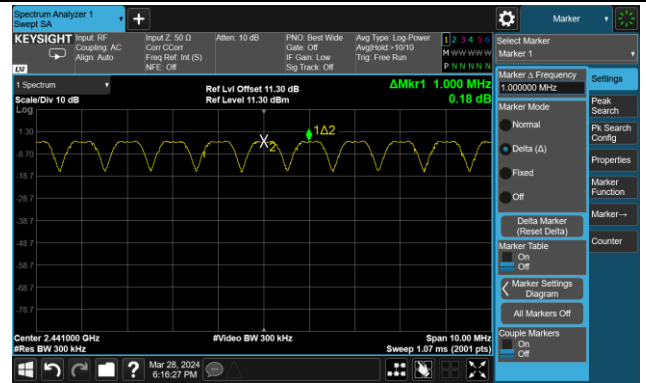

Channel 78 (2480MHz)



2DH5 Carrier Frequency Separation

Channel 00 (2402MHz)

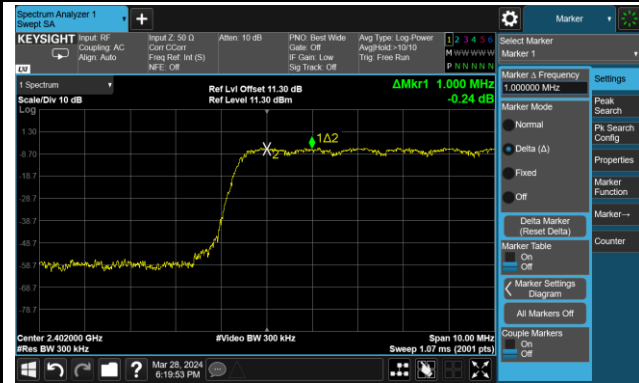

Channel 39 (2441MHz)

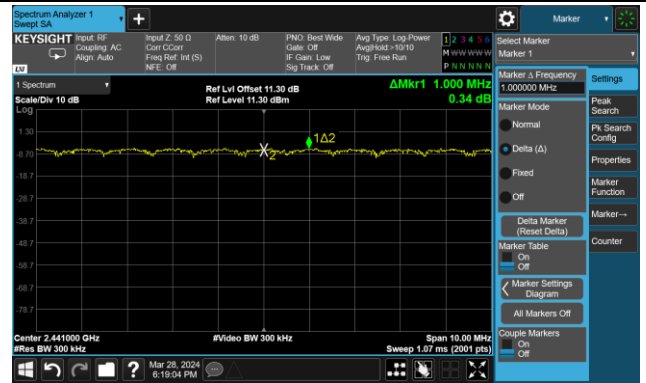

Channel 78 (2480MHz)



3DH5 Carrier Frequency Separation

Channel 00 (2402MHz)

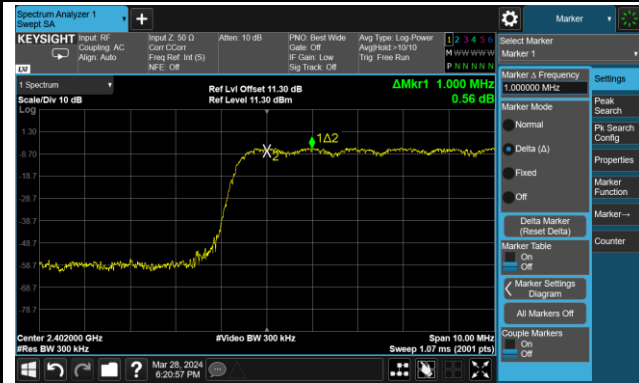

Channel 39 (2441MHz)

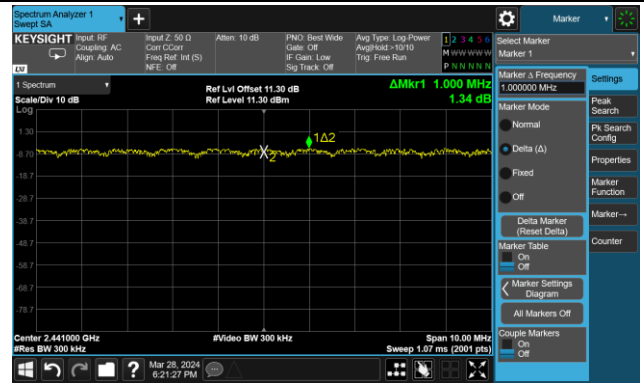

Channel 78 (2480MHz)



A.5 Number of Hopping Channels Test Result

Test Site	SIP-TR1	Test Engineer	Ryan Wang
Test Date	2024-03-28		

Test Mode (Hopping)	Channel Numbers	Frequency (MHz)	Limit (Hopping Channels)	Result
DH5	79	2402~2480	≥ 15	Pass
2DH5	79	2402~2480	≥ 15	Pass
3DH5	79	2402~2480	≥ 15	Pass

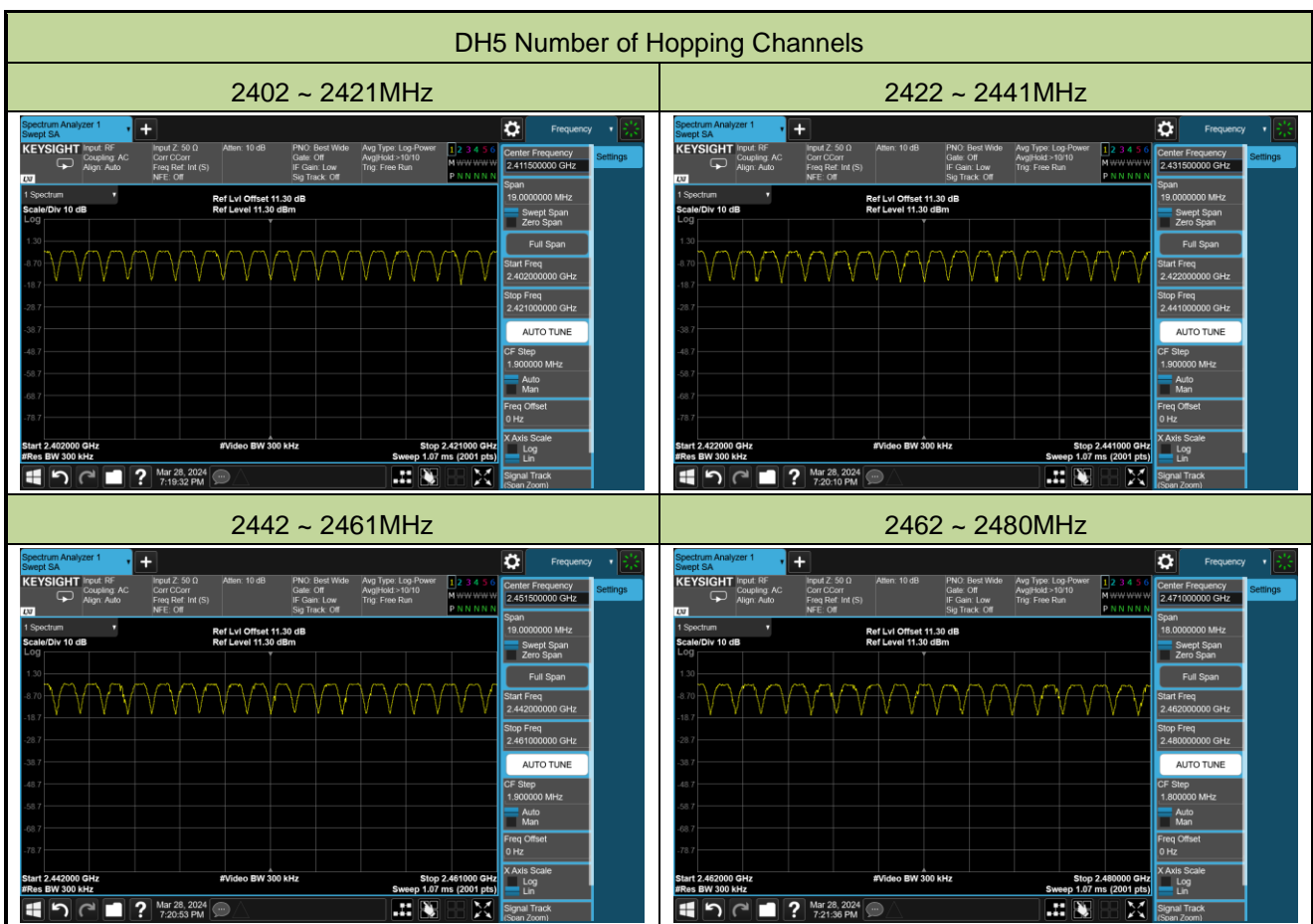

2DH5 Number of Hopping Channels

2402 ~ 2421MHz

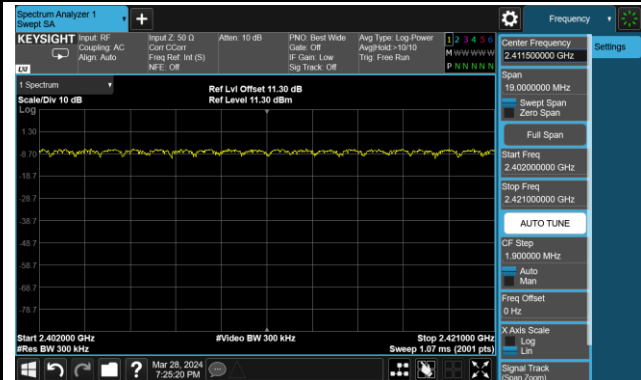

2422 ~ 2441MHz

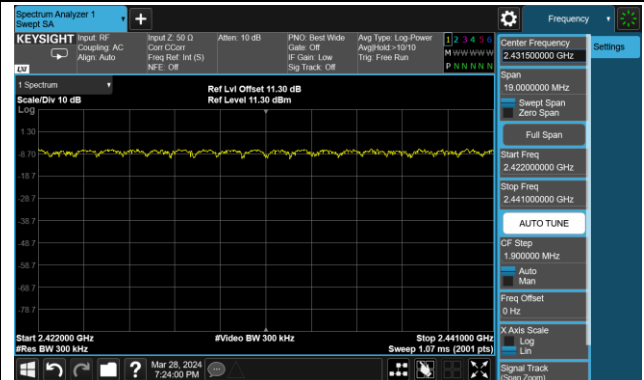

2442 ~ 2461MHz

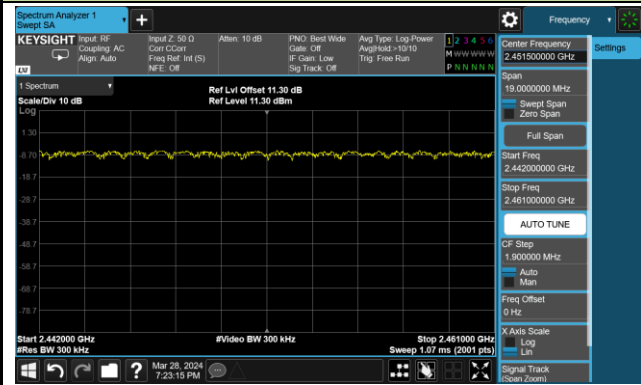

2462 ~ 2480MHz

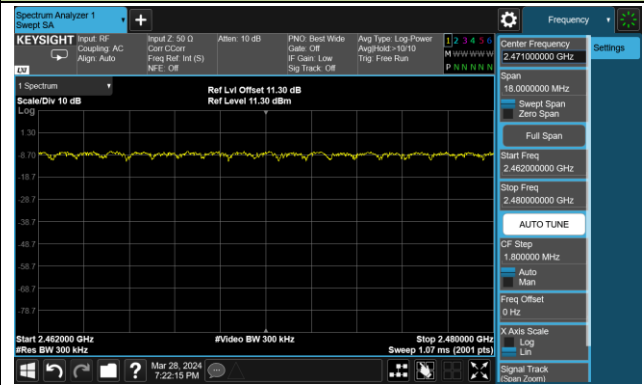

3DH5 Number of Hopping Channels

2402 ~ 2421MHz

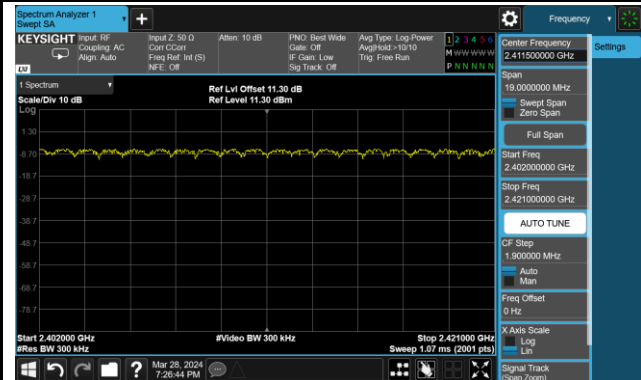

2422 ~ 2441MHz

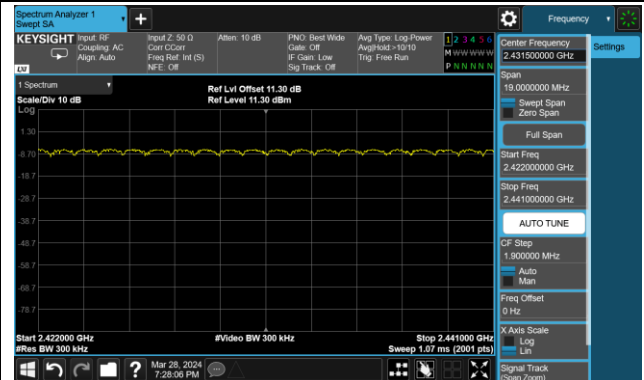

2442 ~ 2461MHz

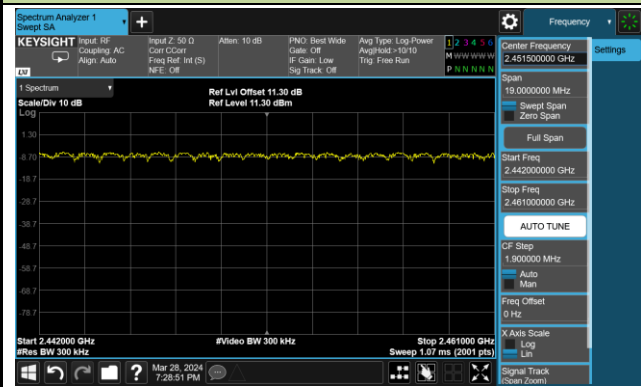

2462 ~ 2480MHz

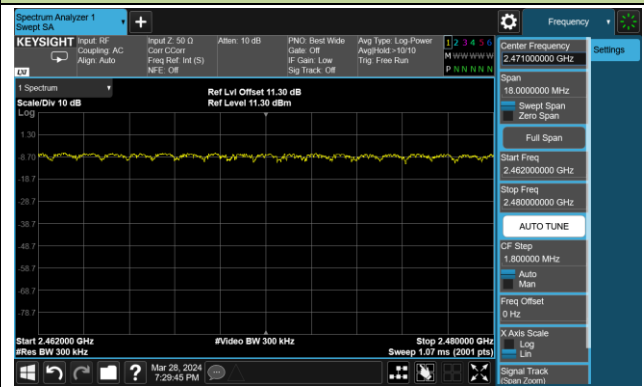

A.6 Time of Occupancy Test Result

Test Site	SIP-TR1	Test Engineer	Ryan Wang
Test Date	2024-03-28		

Test Mode	Channel No.	Frequency (MHz)	Transmit Time Per Hop (ms)	Observation Period (s)	Number of Hops in Sweep Time	Number of Hops in Observation Period	Time of Occupancy (ms)	Limit (ms)	Result
DH1	00~78	2402~2480	0.38	31.6	58	305	115.90	≤ 400	Pass
DH3	00~78	2402~2480	1.625	31.6	30	158	256.75	≤ 400	Pass
DH5	00~78	2402~2480	2.89	31.6	24	126	364.14	≤ 400	Pass

Notes:

1. Number of Hops in Observation Period = Number of Hops in Sweep Time * (Observation Period / Sweep Time), Sweep Time = 6s.
2. Time of Occupancy (ms) = Transmit Time Per Hop * Number of Hops in Observation Period

Transmit Time Per Hop

DH1



DH3

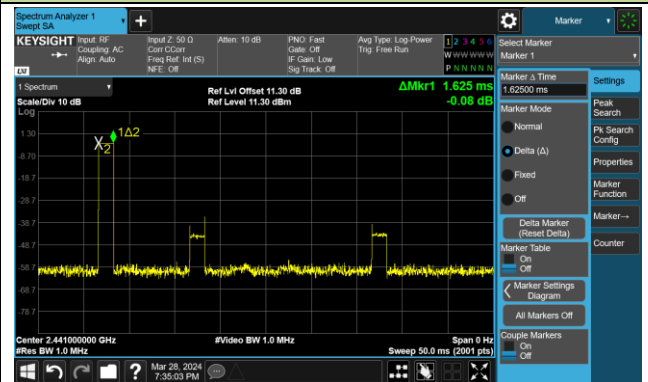

DH5

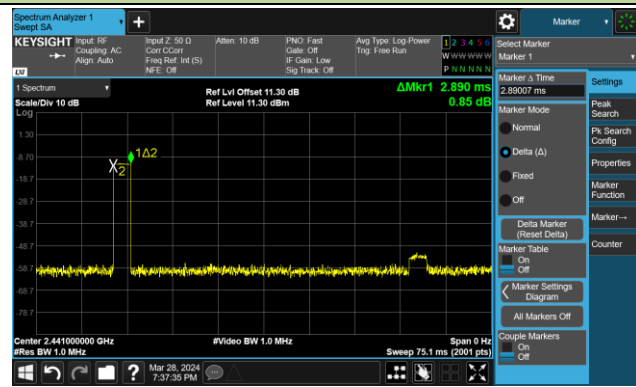

Number of Hops in Sweep Time

DH1

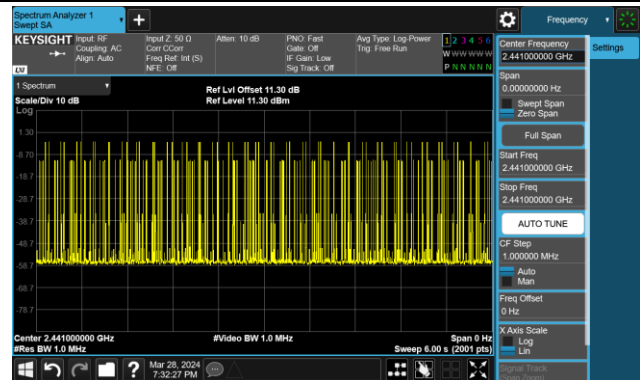

DH3

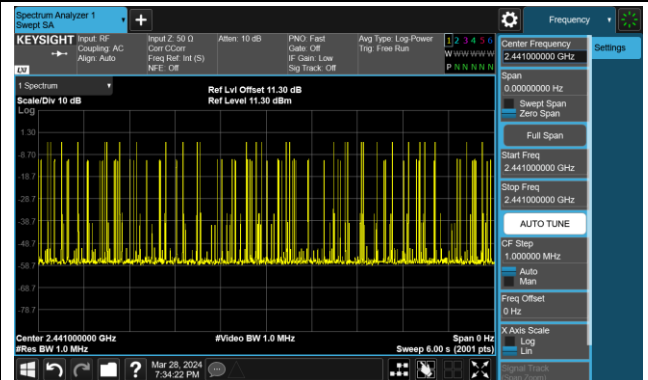

DH5

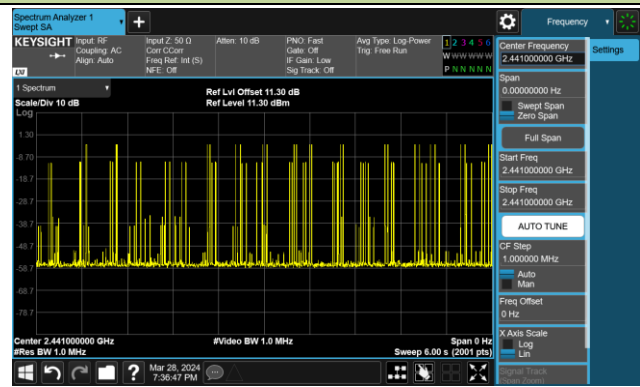

A.7 Band-edge Compliance Test Result

Test Site	SIP-TR1	Test Engineer	Ryan Wang
Test Date	2024-03-28		

Test Mode	Channel No.	Frequency (MHz)	Limit	Result
DH5	00	2402	20dBc	Pass
DH5	78	2480	20dBc	Pass
2DH5	00	2402	20dBc	Pass
2DH5	78	2480	20dBc	Pass
3DH5	00	2402	20dBc	Pass
3DH5	78	2480	20dBc	Pass