

CK65 Series

Mobile Computer
powered by Android™



User Guide

Disclaimer

Honeywell International Inc. (“HII”) reserves the right to make changes in specifications and other information contained in this document without prior notice, and the reader should in all cases consult HII to determine whether any such changes have been made. The information in this publication does not represent a commitment on the part of HII.

HII shall not be liable for technical or editorial errors or omissions contained herein; nor for incidental or consequential damages resulting from the furnishing, performance, or use of this material. HII disclaims all responsibility for the selection and use of software and/or hardware to achieve intended results.

This document contains proprietary information that is protected by copyright. All rights are reserved. No part of this document may be photocopied, reproduced, or translated into another language without the prior written consent of HII.

Copyright © 2019 Honeywell International Inc. All rights reserved.

Web Address: www.honeywellaidc.com

Trademarks

Google and Android are trademarks of Google LLC.

Bluetooth trademarks are owned by Bluetooth SIG, Inc., U.S.A. and licensed to Honeywell.

microSD is a registered trademark of SD-3C, LLC.

Qualcomm and Snapdragon are registered trademarks or trademarks of Qualcomm Incorporated in the United States and/or other countries.

Other product names or marks mentioned in this document may be trademarks or registered trademarks of other companies and are the property of their respective owners.

Patents

For patent information, refer to www.hsmpats.com.

TABLE OF CONTENTS

Customer Support	vii
Technical Assistance	vii
Product Service and Repair	vii
Limited Warranty	vii

Chapter 1 - About the Computer Features..... 1

About the CK65 Mobile Computer	1
Model Overview	1
Features of the CK65.....	3
About the Battery	6
Charge the Battery Before Use.....	6
Replace the Battery.....	7
About the Battery Status.....	7
About the Battery Status LED Setting.....	8
Check the Battery Level and Usage	9
About Battery Life and Conservation	10
Battery Recommendations and Safety Precautions	10
Enable Airplane Mode	11
Power On the Computer	11
Welcome Screen.....	11
Unlock the Screen	12
Change the Screen Lock to Protect the Computer	12
Configure the Screen Backlight	13
About the Scan Status LED.....	13
About the Keypad	14

Keypad LEDs	14
About the Color-Coded Keys.....	15
About the Audio Features	17
Audio Settings	18
Insert a microSD Card.....	18
How to Transfer Files	20
Configure USB Connection and Transfer Files	21
Accessories for the Computer.....	21

Chapter 2 - About the User Interface and Applications 23

About the User Interface.....	23
Navigation and Function Buttons	24
About Status Bar Icons	24
Remap a Button or Key.....	25
Restore Default Button Action	25
View and Manage Notifications	26
Open Quick Settings	26
Customize the Home Screen	27
Customize the Favorites Tray	27
Use Google™ Search.....	27
About Screen Gestures	28
Set the Time Zone.....	28
About Honeywell Applications.....	29
Applications You Can Download to the Mobile Computer	30
Unlock Developer Options	31

Chapter 3 - Use the Image Engine 33

About the Image Engine	33
About the Scan Wedge Feature	33
Change the Scanner Settings	34
Restore Default Scan Settings	34
Default Scan Settings.....	35
Add a Scan Setting Profile	39

Delete a Scan Setting Profile	39
About the Optional Digital Scan Button	40
Enable and Configure the Digital Scan Button	40
Scan Bar Codes	41
About Scanning Configuration Bar Codes	41
Use the Scan Demo App	42
Change the Scan Demo Symbology Settings	42

Chapter 4 - Use the Camera43

About the Color Camera	43
How to Zoom.....	43
Take a Photo	43
Change Camera Settings	44
Record a Video.....	45
Change Video Settings.....	45
Use the Camera as a Flashlight	46

Chapter 5 - Configure the Computer47

How to Configure the Computer	47
Start the Settings App.....	47
About the Structure of the Settings App	47
About Network Communications	55
Connect to a Wi-Fi Network.....	55
Connect to an Ethernet Network.....	56
How to Connect to Virtual Private Networks.....	57
About Wireless Security	58
About Certificates.....	58
About Bluetooth Communications	60
Connect a Bluetooth Device.....	60
Rename the Computer and View File History	61
Rename, Share or Unpair a Paired Device.....	61
About Serial and USB Communications	61
USB Troubleshooting	61

About Near Field Communication (NFC)	62
Developer Information.....	62
About Provisioning Mode	63
Enable or Disable Provisioning Mode.....	63

Chapter 6 - Manage and Maintain the Computer..... 65

About Software Updates	65
About Transferring Files via USB Connection	65
Install Software with AutoInstall.....	66
Optional microSD Card Method.....	66
About the Honeywell Upgrader	67
View the Installed OTA Version	67
Install OTA Updates.....	68
Reboot (Restart) the Computer.....	69
About Enterprise Data Reset.....	69
Before You Begin	69
Enterprise Data Reset the Computer	70
About Erase All Data (Factory Reset).....	70
Before You Begin	70
Erase All Data (Factory Reset).....	71
Clean the Computer.....	71

Appendix A - Specifications..... 73

Computer Agency Information.....	73
Label Locations	73
Physical and Environmental Specifications	74
Bar Code Symbologies Supported	74
N6703SR Imager Engine Reading Distances	75
N6703SR Imager Engine Field of View/Resolution	76
EX20 Imager Engine Reading Distances	76
EX20 Imager Engine Field of View/Resolution	77

Customer Support

Technical Assistance

To search our knowledge base for a solution or to log in to the Technical Support portal and report a problem, go to www.hsmcontactsupport.com.

For our latest contact information, see www.honeywellaidc.com/locations.

Product Service and Repair

Honeywell International Inc. provides service for all of its products through service centers throughout the world. To find your service center, go to www.honeywellaidc.com and select Support. Contact your service center to obtain a Return Material Authorization number (RMA #) before you return the product.

To obtain warranty or non-warranty service, return your product to Honeywell (postage paid) with a copy of the dated purchase record. To learn more, go to www.honeywellaidc.com and select **Service & Repair** at the bottom of the page.

For ongoing and future product quality improvement initiatives, the mobile computer comes equipped with an embedded device lifetime counter function. Honeywell may use the lifetime counter data for future statistical reliability analysis as well as ongoing quality, repair and service purposes.

Limited Warranty

For warranty information, go to www.honeywellaidc.com and click **Get Resources > Product Warranty**.

ABOUT THE COMPUTER FEATURES

This chapter introduces the CK65 Mobile Computer. Use this chapter to learn about the basic computer features, functions, and accessories.

About the CK65 Mobile Computer

CK65 mobile computers, built on the Mobility Edge™ platform, deliver real-time connectivity, advanced data capture, and future-proof investment protection. A 4-inch touchscreen with the option to choose between an alphanumeric or numeric keypad with function keys provides the flexibility to fit current and future application environments. CK65 models are equipped for fast Wi-Fi connectivity with a WLAN 802.11a/b/g/n dual-band radio and Bluetooth (v5.0) technology that includes Bluetooth Low Energy (BLE) support.

All models are available with either a N6703SR (1D/2D) high performance imager or an EX20 Near/Far (1D/2D), high performance 2D imager for long range scanning applications up to 15.2 m (50 ft).

Note: *Throughout this manual, all versions of the mobile computer are referred to as the CK65 unless information is specific to a particular model type.*

Model Overview

Available Features	Model CK65L0N
Android 8 operating system, upgradeable through Android R	x
2.2 GHz Qualcomm Snapdragon™ 660 octacore processor	x
2 GB/4 GB LPDDR4 RAM, 32 GB flash memory	x
High definition, bright color, outdoor-readable display with responsive multi-touch capacitive touch panel	x
Integrated ambient light sensor, accelerometer, gyroscope, and magnetometer	x

Available Features	Model CK65L0N
Choice of physical keypad: <ul style="list-style-type: none"> • Alphanumeric and function keypad • Numeric and function keypad 	x
Choice of Honeywell imager: <ul style="list-style-type: none"> • N6703SR (1D/2D), high performance imager • EX20 Near/Far (1D/2D), high performance, long range imager 	x
WLAN IEEE 802.11 a/b/g/n/ac radio; Wi-Fi certified	x
Bluetooth™ V5.0 and Bluetooth Low Energy (BLE) technology support	x
NFC technology for short-range wireless data exchange	x
Mid-tier rugged specifications with IP64 sealing	x
Customer-accessible microSD™ slot for removable memory cards up to 512 GB (SDXC/SDHC/SDIO-compliant)	x
Value-added software components supporting specialized imaging and OCR functions	x
13-megapixel color camera, 4K video with image stabilization and advanced software features for enhanced exposure control	x

Features of the CK65

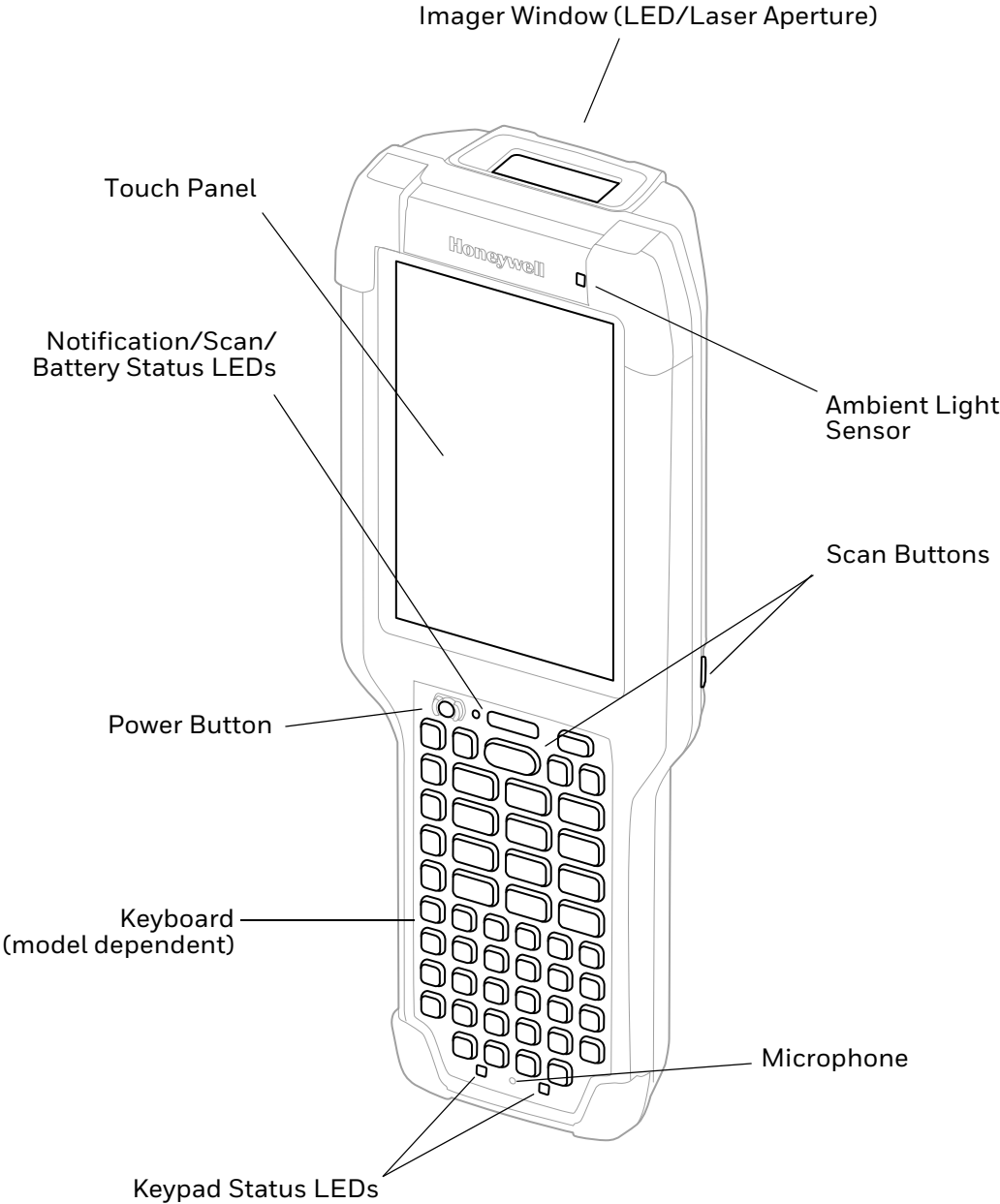

CK65 Model with N6703 Imager

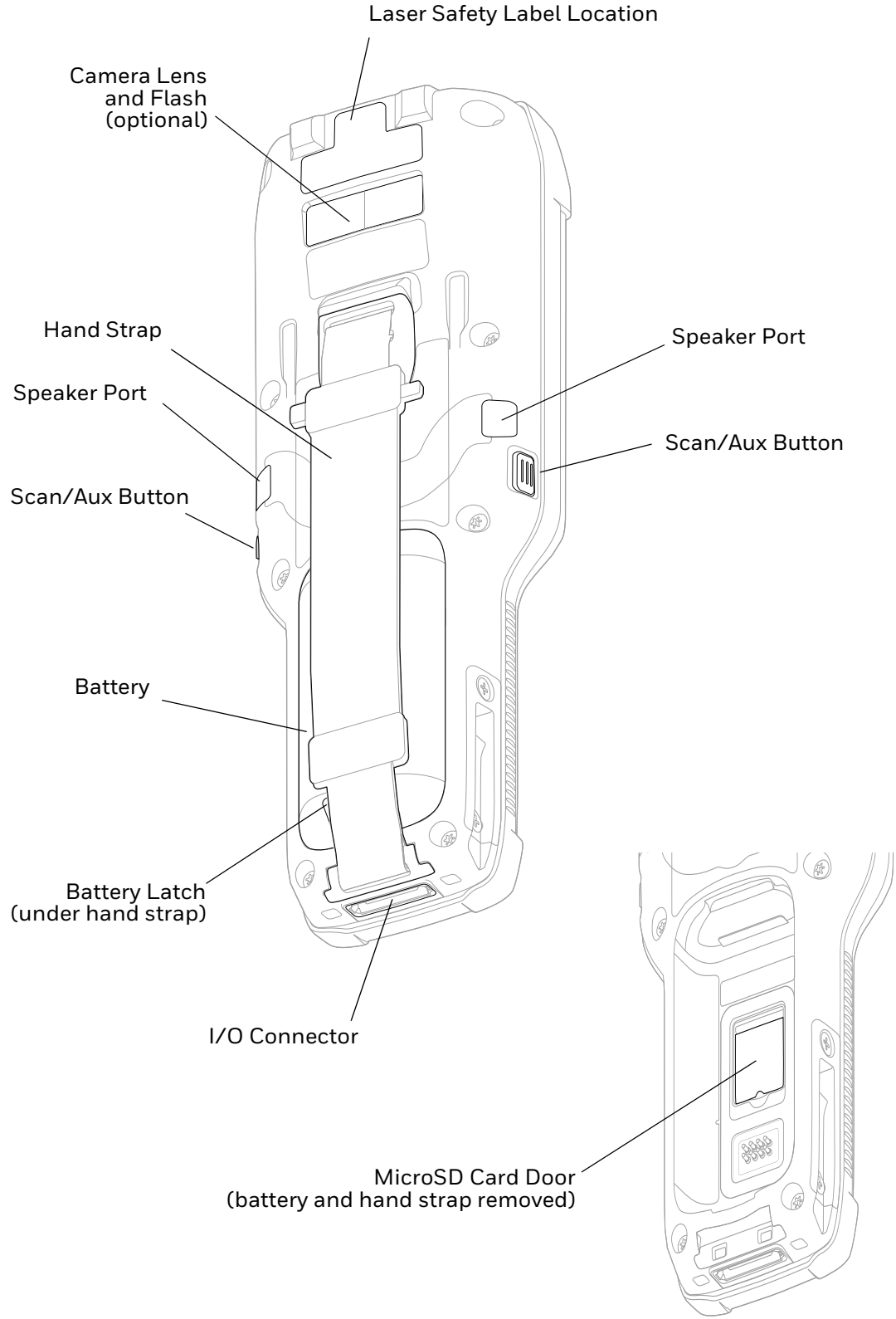

CK65 Model with EX20 Imager

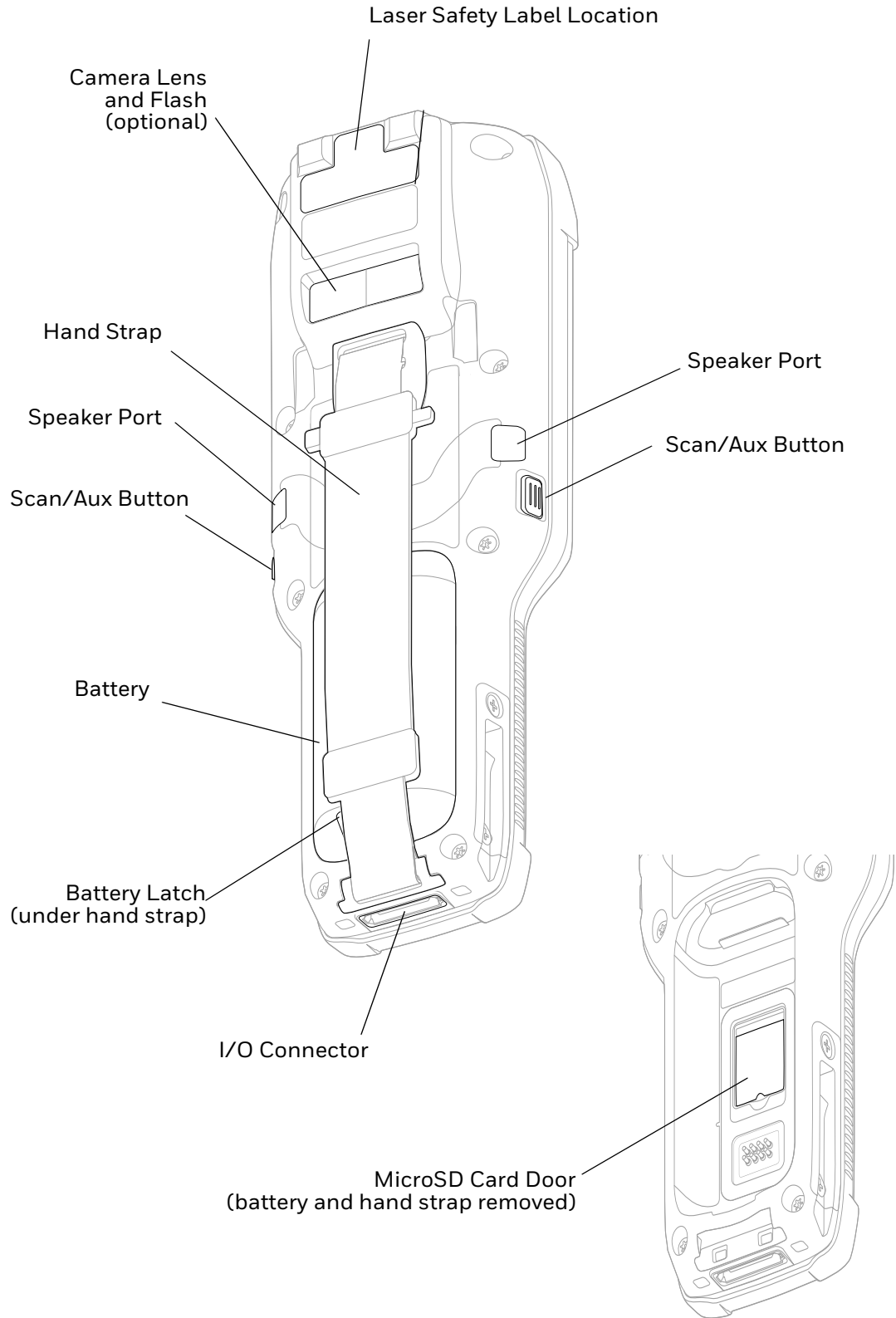

About the Battery

The computer uses a rechargeable Li-ion battery as its main power source. Several factors determine the life of your battery, such as display brightness, display timeout, input device, extreme temperature, and usage. Honeywell recommends that you keep the battery charged at all times to prevent data loss.

CK65 computers are designed for use with battery model AB18 manufactured for Honeywell International Inc. CK3 battery models AB17 and 1001AB01 may be used with the CK65.

Note: To view specifications specific to your battery model, see the battery insert supplied with the battery.

For a list of compatible accessories for the CK65 mobile computer series and their part numbers, see the *CK65 Accessory Guide*, available for download from the CK65 product page at www.honeywellaidc.com. Contact your local sales representative for replacement battery ordering information.



Caution: Read **Battery Recommendations and Safety Precautions** on page 10 and all cautionary markings on the battery, charging peripheral, and device using the battery before attempting to install, use, or charge the battery.

Charge the Battery Before Use

CK65 computers ship with the battery significantly discharged of power. Fully charge the battery before using your computer for the first time. You can charge the battery with a CK3 series charging accessory before or after you install the battery in the computer.

CK65 Charging Accessory	AB18 Charge Times
AC20 quad charger	up to 6 hours
AD20 single dock	up to 6 or 7 hours
AD21 Ethernet multidock	up to 7 hours
AD22 charge-only multidock	up to 7 hours
AV10 vehicle dock	up to 7 hours
DX2 or DX4 with FlexDock cup 1002UC02	up to 7 hours
Universal wall mount charger	up to 6 hours

Note: Using the computer while charging the battery increases the time required to reach a full charge.

Replace the Battery

When battery power is low, you have the choice to either charge the battery in the computer, or replace it with another fully charged battery. Spare batteries can be purchased separately.



Caution: Ensure all components are dry prior to placing the battery in the computer terminal. Mating wet components may cause damage not covered by the warranty.

To replace the battery:

1. Save your files and close any open applications.
2. Press and hold the **Power** button until the options menu appears.
3. Tap **Swap Battery**. Follow the on-screen instructions to place the unit in battery swap mode.
4. Release the end of the hand strap at the bottom of the computer.
5. Push the battery latch toward the battery to release the lock.
6. Lift up the edge of the battery and remove it from the computer.
7. Insert the charged battery into the computer.
8. Press down on the bottom edge of the battery to engage the lock.
9. Attach the hand strap.



About the Battery Status



To view detailed information on your battery, such as use statistics, amount of charge remaining, and battery health information:

1. Open the **Settings** app .
2. Select either **Battery** or **Honeywell Settings > Battery Optimizer**.

You can also use the battery icon at the top of the screen in the Status bar to see battery charge information. The icon changes depending on the charge level.

Battery Status Icons

Icon	Status
	The battery charge is at 100%.
	The battery charge is at 50%.
	The battery charge is low. You need to charge or replace the battery soon.

Icon	Status
	The battery is critically low. You need to replace the battery now or connect the computer to a charging accessory.
	The computer is connected to external power and the battery is charging.
	There is a battery error. Install another battery. If the problem persists, contact Honeywell Technical Support.

Along with the battery icon, there is a battery status LED below the touch screen. The LED color and behavior (e.g., steady on, blinking, or off) indicates the charging status of the battery. To view status descriptions and to learn how to modify the Battery LED behavior, see [About the Battery Status LED Setting](#) on page 8.

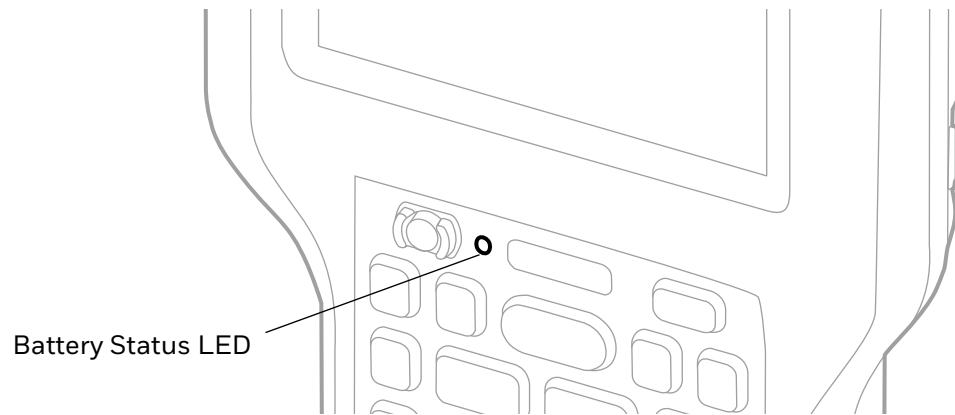

About the Battery Status LED Setting

You can change the behavior of the Battery status LED if the out-of-box behavior for a charging battery (blinking green) is not acceptable to your environment.

You can choose one of three options:

- **Honeywell Battery LED** (factory default, out-of-box configuration)
- **Default Battery LED** (optional Android OS configuration)
- **No Battery LED**

Honeywell Battery LED Behavior (Factory Default/Out-of-Box Configuration)

Connected to Power	LED State	Description
No	Blinking amber	Battery level is below 15%
No	Off	Battery level is more than 15%
Yes	Steady amber	Battery level is between 0% and 60%
Yes	Blinking green	Battery level is between 60% and 95%
Yes	Steady green	Battery level is above 95%
Either	Blinking red	Battery error

Default Battery LED Behavior (Optional Android OS Configuration)

Connected to Power	LED State	Description
No	Blinking red	Battery level is below 15%
No	Off	Battery level is 15% or more
Yes	Steady red	Battery level is below 15%
Yes	Steady amber	Battery level is between 15% and 90%
Yes	Steady green	Battery level is 90% or more

Select the No battery LED setting if you want to use the LED as a notification LED for applications or device management solutions. For more information on how to use the LED as a notification LED, see <http://developer.android.com/guide/topics/ui/notifiers/notifications.html>.

Change the Battery Status LED Behavior

To change the battery status LED behavior:

1. Swipe up from the bottom of the Home screen to access all apps.
2. Tap **Settings**  > **Honeywell Settings** > **Battery LED**.
3. Choose one of the options:
 - **Default Battery LED** (optional Android OS configuration)
 - **Honeywell Battery LED** (factory default/out-of-box configuration)
 - **No Battery LED** (disable battery LED)

Check the Battery Level and Usage

In addition to the Battery status icon and LED, you can monitor the battery status from the Settings app.

1. Swipe up from the bottom of the Home screen to access all apps.
2. Tap **Settings**  > **Battery**.

The current percentage of battery power remaining and the amount of usage time left on the battery appear on the screen. A list shows the battery usage for individual apps and services. For usage details, select one of the apps or services in the list. You can also access the **Battery saver** feature from the battery screen.

About Battery Life and Conservation

If you store the battery outside of the computer for long periods of time, the battery slowly discharges. To maintain battery performance, storing the battery in a charger is recommended. Use the reference table below to learn about how to conserve battery power.

When You Want to:	Do this to Save Battery Power:
Use the computer and the low battery status icon appears or the battery light turns on.	Do one of the following: <ul style="list-style-type: none">• Connect the computer to a charging accessory.• Replace the Battery (see page 7).
Stop using the computer for 5 minutes or more.	Make sure that the low battery status icon is not on the screen and that the battery status LED is not on. Press and release the Power button to put the computer to sleep.
Store the computer for more than a day.	<ul style="list-style-type: none">• If you are storing the computer for a few days (e.g., over the weekend), install a fully charged battery or connect the computer to a power source.• If you are storing the computer for a longer period of time, remove and charge the battery. When the battery is done charging, store both the battery and the computer in a cool location.• If you store the battery for several months, recharge the battery periodically to keep it at peak performance.
Store the battery outside of the computer.	Store the batteries in a charger.

Battery Recommendations and Safety Precautions



Caution: Improper battery replacement or incompatible device usage may result in risk of burns, fire, explosion, or other hazard. Dispose of lithium-ion batteries according to local regulations. Risk of fire and burns if improperly handled. Do not open, crush, heat above 50°C (122°F) or incinerate.

- For maximum battery life, charge the battery at 20 °C (68 °F) to 25 °C (77 °F) and store at 23 °C (73 °F).
- Do not store the battery at temperatures above 60 °C (140°F). Storage above 60 °C (140°F) may damage the battery.
- Charge the battery before use. Battery ships with only a partial charge.
- See [Charge the Battery Before Use](#) on page 6 for approved charging methods. Use of this battery in other devices could result in damage to the device or battery.
- Avoid dropping the battery or computer. If you suspect that the battery or computer is damaged, send it to a Honeywell service center for inspection.
- Discarded batteries may create a safety hazard. Before disposal, cover the battery contacts with electrical insulating tape.

- Do not modify the battery or attempt to insert foreign objects into it.
- Do not solder directly to the battery contacts.
- Do not drop the battery or apply mechanical shocks or pressure to it.
- Do not disassemble or open, crush, bend or deform, puncture, shred or burn the battery.
- Do not immerse the battery pack in water or get the battery pack wet before proper installation in the computer.

Enable Airplane Mode

If you do not need to connect to any wireless networks, you can enable Airplane mode to turn Off the radios and save battery power.

1. Swipe up from the bottom of the Home screen to access all apps.
2. Tap **Settings**  > **Network & Internet**.
3. Tap the toggle button next to **Airplane mode**. An airplane icon appears in the status bar to indicate Airplane mode is turned On.

Power On the Computer

After you have fully charged and installed a battery, power on the computer for the first time:

- Press and hold the **Power** button for approximately 3 seconds, and then release the button.

Welcome Screen

The first time you power on the computer, a Welcome screen appears. Select a language and then tap **Start**. You can either scan a configuration bar code or select manual to set up the computer. To learn more about how to [Scan Bar Codes](#), see [page 41](#).

During the manual setup process, follow the prompts on the screen to:

- Set up the Wi-Fi network connections.
- Set the time, date, and time zone, if no Wi-Fi connection is available.
- Personalize (name) the computer.
- Set up security and privacy options.

Once you complete the initial setup, the Welcome screen no longer appears when you power on the computer and **Provisioning mode** is automatically turned Off (disabled). Scanning a bar code to install applications, certificates, configuration files, and licenses on the computer is restricted when **Provisioning mode** is turned Off. To learn more [About Provisioning Mode](#) see [page 63](#).

Unlock the Screen

The screen lock automatically activates every time the computer is turned On or when the computer wakes from sleep mode.

- Swipe up from the lock icon at the bottom of the screen.

The level of security provided depends on the type of lock set (e.g., Swipe, Pattern, PIN, or Password). The default setting, Swipe, provides no protection against unauthorized access to your computer.

Change the Screen Lock to Protect the Computer

After you start using the computer, you should change the screen lock to prevent unauthorized persons from accessing the computer after the screen lock activates, unless they input the correct password, pin, or pattern.

The recommended setting for the Screen lock is to enable a Password lock. Use a strong password value (e.g., include numbers, characters, special characters, and mix character case).

1. Swipe up from the bottom of the Home screen to access all apps.
2. Tap **Settings**  > **Security & location** > **Screen lock**.
3. Choose one of the following options:
 - **None**
 - **Swipe**
 - **Pattern**
 - **PIN**
 - **Password**
4. Follow the on-screen prompts to complete the setup.
5. Exit the Settings app.

Configure the Screen Backlight

The display has an ambient light sensor that automatically adjusts the backlight intensity to conserve power and ensure the display is readable. You can also manually set the backlight intensity if you do not want to use the automated adaptive brightness feature.

1. Swipe up from the bottom of the Home screen to access all apps.
2. Tap **Settings**  > **Display**.
3. Choose one of the following options:
 - To have the computer automatically adjust the brightness for your work environment, turn On the **Adaptive brightness** setting. You can tap **Adaptive brightness** to toggle the feature On or Off.
 - To set the brightness level manually, verify the Adaptive brightness feature is turned Off, and then select **Brightness level**. Adjust the slider to set the brightness level.

About the Scan Status LED

The Scan Status LED indicates the read status of the imager when scanning a bar code. The Scan Status LED is located below the touch screen.

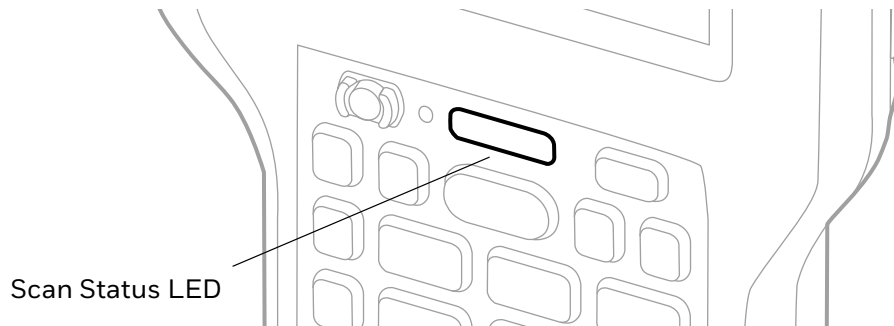

Scan Status LED Descriptions

LED Color	Description
Green	Good read of a bar code.
Red	Failure to scan bar code. Check to make sure you have the correct symbology enabled.

Note: The behavior of the Scan Status LEDs is determined by the scanning notification settings (see page 39).

To learn more about how to use and configure the imager engine for scanning, see [Use the Image Engine](#) beginning on page 33.

About the Keypad

The CK65 is available in two keypad configurations.

Alphanumeric Keypad



Numeric Keypad



Keypad LEDs

Special characters and alternate functions are entered by pressing color-coded key sequences. Keypad LEDs located at the bottom of the keypad, indicate when a color-coded modifier key is active. All models include both orange and green modifier keys for typing alternate characters, symbols, and functions.

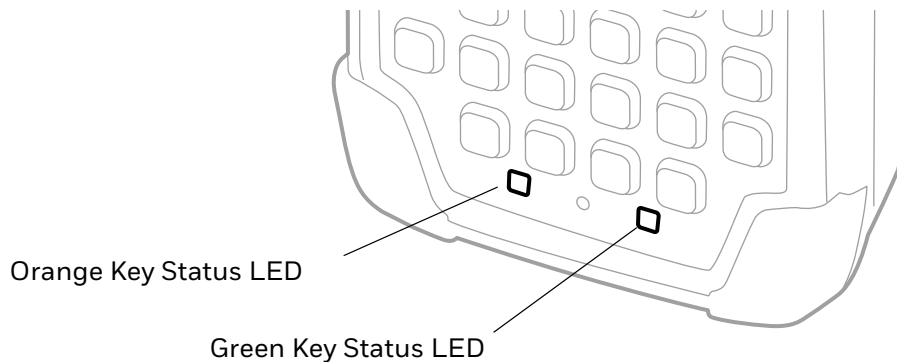

Keypad LED Descriptions

Status LED	Color	Description
Orange Modifier Key Status	Orange	Illuminated when the orange modifier key is enabled.
Green Modifier Key Status	Green	Illuminated when the green modifier key is enabled.

About the Color-Coded Keys

Use the keypad color-coded modifier key(s) to access all the characters, numbers, symbols and functions marked on the computer keys and keypad overlay.

Note: *On either keypad, you can lock the modifier key On and type only symbols or special characters by pressing the orange or green modifier key twice in rapid succession. Press the modifier key again to unlock the modifier.*

Enter Characters on the Alphanumeric Keypad

Computer models with a Alphanumeric keypad include orange and green modifier keys for typing symbols and special characters. The keypad also has customizable auxiliary keys (F1 to F5) that can provide up to five additional key functions.



To learn more about customizing the key functions, see [Remap a Button or Key](#) on page 25.

To type an alphabetic character or a number:

- Press the relevant character or number key.

To type a symbol or special character:

1. Press the orange or green modifier key.
2. Press the key for the symbol or special character.



Example: Press  and then  to type a question mark.

To type a single uppercase alphabetic character:

1. Press the orange modifier key then .
A will display in the status bar to indicate that shift is On.
2. Press the character. The shift notifier in the status bar will turn Off.

Example: Press ,  then  to type the capital letter Y.

To type all uppercase alphabetic characters:

1. Press the orange modifier key then .
A will display in the status bar while caps lock is on.
2. Press the character keys.
3. Press the orange modifier key and  again to turn caps lock Off.

Example: Press   and then     to type the word COLD in all caps.

Enter Characters on the Numeric Keypad

Computer models with a numeric keypad include orange and green modifier keys for typing alphabetic characters and special characters as well as accessing functions. The keypad also has customizable auxiliary keys (F1 to F12) that when used in conjunction with the green modifier key can provide up to 24 additional key functions.

To learn more about customizing the key functions, see [Remap a Button or Key](#) on page 25.

To type a number:

- Press the relevant number key.

To type a single alphabetic character or symbol:

1. Press the orange or green modifier key.
(If you press the orange key, **a** will display in the status bar to indicate that the keypad is in alphabetic mode.)
2. Press the key for the letter or special character.

Example: Press  and then  to type a lower case a.

To type multiple alphabetic characters:

1. Press the orange modifier key twice to lock it On.
a will display in the status bar.
2. Press the keys for the letters you want to input.
3. Press the orange modifier key once to return to typing numbers.

Example: Press   and then     to type the word “cold” in lower case letters.

To type a single uppercase alphabetic character:

1. Press the orange modifier key once.
a will display in the status bar.
2. Press .
- A** will change to **A** in the status bar to let you know shift is On.
3. Press the orange modifier key again.
4. Press the character key.



Example: Press    then  to type the capital letter Y by itself.

Alternately, to type a single uppercase alphabetic character with the modifier key locked on:

1. Press the orange modifier key twice to lock it on.
2. Press .
3. Press the character key.

Example: Press     then    to type the word “Cold”.

To type all uppercase characters:

1. Press the orange modifier key twice.
a will display in the status bar.
2. Press .
- A** will change to **A** in the status bar when caps lock is turned on.
3. Press the character keys.
4. Press  again to turn caps lock Off.

Example: Press    then     to type the word “COLD” in all caps.

About the Audio Features

The CK65 has multiple speakers, a microphone, and several software tools to configure sound volume or enable vibration feedback.

Audio Settings

This section describes the audio and sound settings you can configure in the Settings app.

- To change audio settings, select the **Settings** app  and then tap **Sound**.

Note: *Sound settings are model dependent. Some settings may not be available for your model type.*

Sound Settings

Setting	Description
Media volume	Use the sliders to set the volume for media (e.g., music, videos, and games), alarms and rings (notifications and ringtones).
Alarm volume	
Ring volume	
Also Vibrate for calls	Set the phone to vibrate for incoming calls.
Do Not Disturb preferences	Configure the Do not disturb feature.
Phone ringtone	Set the phone ringtone.
Advanced	Select to expand the settings menu.
Default notification sound	Set the default sound used for notifications.
Default alarm sound	Set the default sound used for alarms.
Other sounds and vibrations	Turn sounds On or Off for: <ul style="list-style-type: none">Dial pad tonesScreen locking soundsCharging soundsTouch soundsVibrate on tap
Emergency alerts	Set what emergency information you want to receive and how you want to receive the alerts.

Insert a microSD Card

You can use a microSD card to increase file storage capacity or to install software. Honeywell recommends the use of Single Level Cell (SLC) industrial grade microSD or microSDHC memory cards with the computer for maximum performance and durability.

Note: *Format the memory card before initial use.*

1. Save your files and close any open applications.
2. Press and hold the **Power** button until the options menu appears.
3. Tap **Power Off**.

4. Release one end of the hand strap. Slide the end of the strap toward the bottom of the unit, and then lift out the strap.

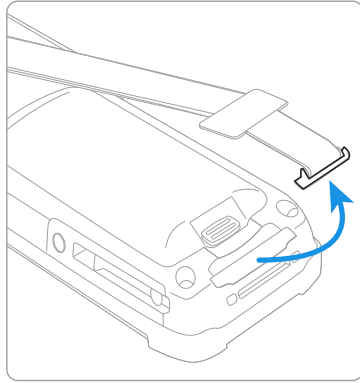

5. Press the battery latch towards the battery.
6. Lift up on the edge of the battery and remove it from the computer
7. Press down on the card access door hinge and lift the opposite end to open it.

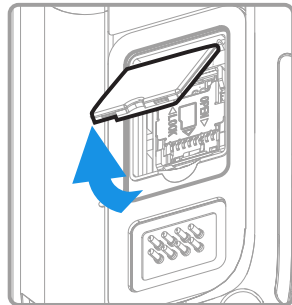

8. Press down gently and slide the card holder away from the open access door. Lift the edge of the holder up.

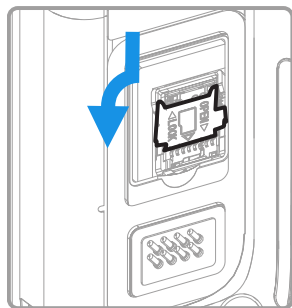

9. Insert the microSD card into the card holder with the contacts facing out.

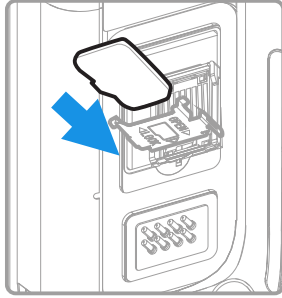

10. Close the holder with the card inserted. Press down gently on the card holder and slide it into the locked position.

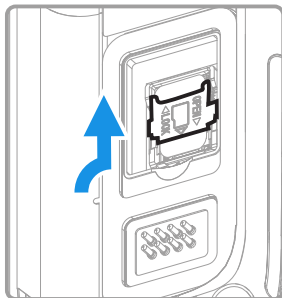

11. Close the card access door.
12. Install the battery and apply pressure to the edge closest to the battery latch.
13. Install the hand strap.
14. Press the **Power** button to turn On the computer.

How to Transfer Files

To transfer files you need to physically connect the CK65 mobile computer to your workstation (e.g., laptop or desktop computer) through a USB connection. When the mobile computer is connected and USB is configured for file or photo transfer, use a file browser (e.g., File Explorer or Windows Explorer) on your workstation to transfer files between the two computers. If you are transferring files to and from a Mac, use the Android File Transfer application (available from www.android.com/filetransfer).

Note: *File transfer through a USB connection is disabled by default. You need to configure the USB connection for transferring files or photos.*

You can use these accessories to connect your mobile computer to your workstation:

- Home Base or Ethernet Home Base, and a standard USB Type B to A cable

Configure USB Connection and Transfer Files

Note: The CK65 supports Hi-Speed USB communications (USB 2.0) with a maximum data transfer rate of 480 Mbps.

1. Connect the CK65 to your workstation.
2. On the CK65, swipe down from the top of the screen to see the notifications.
3. Tap the **Android System USB Connection** notification to open the options menu.
4. Select either **Transfer files** or **Transfer photos (PTP)**.
5. Open the file browser on your workstation.
6. Browse to the CK65. You can now copy, delete, or move files between the CK65 and your workstation.

Note: When provisioning mode is disabled (turned off), some file folders are hidden from view in the file browser.

Accessories for the Computer

The CK65 ships with a hand strap and battery. All other accessories are ordered and shipped separately. The computer requires a battery to function.

For a complete list of compatible accessories for the CK65 mobile computer series and their part numbers see the CK65 *Accessory Guide* available for download from the CK65 product page at www.honeywellaidc.com.

Contact your local sales representative for ordering information.

Accessory	Description
AB17, AB18, or 1001AB01 battery (PN 318-033-021, 318-034-033, 318-046-031)	Replacement or spare Li-ion rechargeable battery for the CK65.
AC20 Quad Battery Charger (PN 871-230-101, 871-230-301)	Charges up to four batteries at one time.
AD20 Single Dock (PN 871-228-101, 871-228-301)	Powers a CK65 and charges a spare battery separately. The single dock also provides client and host USB connectivity.
AD21 Ethernet Multidock (PN 871-229-202, 872-229-302)	Provides Ethernet connectivity and power for up to four devices.
AD22 Charge-only Multidock (PN 871-229-201, 871-229-301)	Charges up to four devices.
AV10 Vehicle Dock (PN871-231-102)	Holds and charges a CK65 while in a vehicle environment.
DX2 model 1002UU02 (PN 852-918-002)	Charges up to four batteries.

Accessory	Description
DX4 models 1002UU04 and 1002UU05 (PN 852-916-002, 852-917-002)	Charges up to four devices. Can also be configured to charge up to eight batteries. Model 1002UU05 also provides Ethernet connectivity.

ABOUT THE USER INTERFACE AND APPLICATIONS

Use this chapter to learn about the user interface and how to interact with the screen. You can also use this chapter to learn about the Honeywell applications on the computer.

About the User Interface

The Android 8 operating system provides a touch-friendly and easy-to-navigate user interface. When you turn On the mobile computer, the Home screen is the first screen that appears after language provisioning and the startup Wizard is complete.

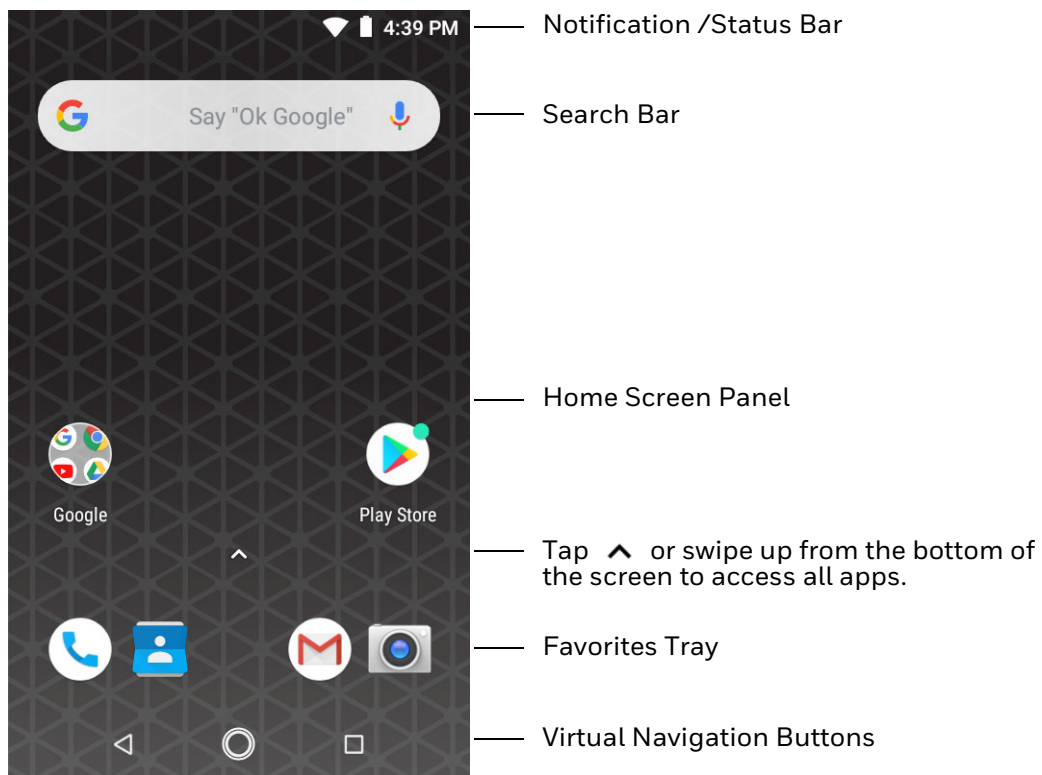

Home Screen Features







Item	Description
Notifications panel / Status bar	Status icons to the left tell you when an app has sent notifications, such as an arriving message. System icons to the right display the current wireless and network connection state and battery level.
Search bar	Search the Internet or the computer using Google™. Touch the microphone icon in the search box to initiate a voice search or command.
Home Screen Panel	You can create more than one custom Home screen panel. Swipe left or right on the Home to switch between your custom panels.
Favorites tray	App icons in the customizable tray are visible on all Home screen panels.

Navigation and Function Buttons

Your mobile computer has virtual buttons on the front panel below the Favorites tray and hardware buttons located on the sides for easy navigation and quick feature access when using the computer.

For button locations on computer, see [Features of the CK65](#) on page 3.













Navigation and Function Buttons

Button	Description	
	Back	Return to the previous screen.
	Home	Return to the Home screen.
	Recent Apps	View and switch between recently used apps.
	Scan	Press the right, left or front scan button to trigger the scanner.
	Function	Use the Key Remap feature in the Settings app to select a button function.
	FldEx	Field exit.

About Status Bar Icons

Status and notification icons show you the current status of your network, the battery, notifications, and sounds. Use the table below to understand some of the most common icons.

Status and Notification Icons

Icon	Description	Icon	Description
	Pending alarm and Alarm is set		Airplane mode is turned On.
	New text message or multimedia message		Bluetooth is turned On.
	Error with text or multimedia message delivery		SD card is full
	New email		Wi-Fi network connected with full signal strength
	Computer is connected to a PC with a USB cable		WiFi network connected but no signal strength
	Synchronizing data		
	Error with sync or sign-in		
	Computer is connected with Ethernet		



Remap a Button or Key

You can change the default function of the physical buttons and keys.

1. Swipe up from the bottom of the Home screen to access all apps.
2. Tap **Settings**  > **Honeywell Settings** > **Key Remap**.
3. Tap the plus sign (+).
4. Press the button or key you want to remap.
5. Tap **OK**.
6. Tap **Keys** or **Applications** or **Actions** to view the available functions.
7. Select the function you want assigned to the button. The function you selected now appears next to the button or key name.
8. Exit the Settings app.

Restore Default Button Action

To restore the button default action:

1. Swipe up from the bottom of the Home screen to access all apps.
2. Tap **Settings**  > **Honeywell Settings** > **Key remap**.
3. Tap the clean icon .

4. Choose the remapped button(s) you want restored to the default setting.
 - Tap the check box next to the button.
- OR
- Tap **All Select** to choose all the buttons.
5. Tap **Delete**.

View and Manage Notifications

You can view recent events on the computer, manage system notifications, change a setting or quickly respond to an app notification by opening the notifications panel.

When a notification icon appears in the status bar at the top of the screen:

1. Swipe down from the top of the screen to open the notifications panel.
2. Respond to the notification. You can take one of the following actions:
 - Tap the notification to open the associated app.
 - Tap a quick-reply or action command (e.g., Reply, Archive), if available.
 - Swipe the notification sideways, off the screen to dismiss it.

Slide the notification left or right to reveal the settings icon .

Choose between **Show notifications silently**, **Don't silence**, or **More Settings**.

Note: *Some notifications cannot be dismissed or turned Off.*

To close the notification panel, swipe up from the bottom of the screen, or tap the Back or Home buttons.

Open Quick Settings

Use the Quick Settings screen for easy access to common settings. Tap an icon to toggle the feature On/Off or to open additional settings.

- To open Quick Settings, swipe down twice from the status bar at the top of the screen.
- To close Quick Settings, tap the Back or Home buttons or .

Customize the Home Screen

You can add application icons to any Home screen for easier access.

1. Swipe up from the bottom of the Home screen to access all apps.
2. Tap and hold the app you want to add, and then start to drag the icon out of position. The computer vibrates, and then switches to a smaller view of the Home screen panels.
3. Drag and drop the app icon into place.
 - If you want to add another home screen, drag the icon to the right edge of the screen before releasing the icon.
 - If you want to create a folder, drag and drop the icon on top of another icon.

Note: *If you tap and hold an app but don't move it, a shortcut menu appears. The content of the menu depends on the app selected.*

To add widgets or customize the look of the Home screen:

1. Tap and hold an empty section of the screen.
2. Select either **Wallpapers**, **Widgets**, or **Home Settings**.

Customize the Favorites Tray

Modify the Favorites tray to contain the apps you use the most.

1. Tap and hold the app icon you want to replace on the Favorites tray.
2. Drag and drop the app on “**X Remove**” at the top of the screen.
3. Swipe up from the bottom of the screen to access all apps.
4. Tap and hold the icon of the app you want to add.
5. Drag and drop the icon into position on the Favorites tray.

Use Google™ Search

Use the Google Search field at the top of the Home screen to help you find anything you need on the computer or on the web.

1. At the top of Home screen, tap inside the Google Search box and begin to type your search term.

As you type, suggestions from Google web search appear below the Search box, and results from the computer (such as apps or contacts) appear below the web search results.

2. Tap a suggestion to search for it immediately, or touch the arrow to add the term to the search field without starting to search.

About Screen Gestures

Use your fingers to manipulate icons, buttons, menus, the on-screen keyboard, and other items on the screen.

- **Tap**

Tap to select something, toggle a setting On or Off, or activate a field for text entry. An on-screen keyboard automatically appears for text entry.

- **Tap and hold**

Tap and hold an item but do not lift your finger until an action occurs.

- **Drag and drop**

Tap and hold an item, and then slide your finger across the screen until you reach the target position. Lift your finger off the screen to drop the item in place.

- **Swipe**

Quickly move your finger across the screen, without pausing when you first touch. For example, you can swipe a Home screen left or right to view the other Home screens.

- **Slide**

Slowly move your finger across the screen, without pausing when you first touch. For example, you can slide a notification to the left until the Settings gear is revealed.

- **Double-tap**

Tap quickly twice on a web page, map, or other screen to zoom in. Double-tap again to zoom out.

- **Pinch**

In some apps, you can zoom in and out by placing two fingers on the screen at once and pinching them together (to zoom out) or spreading them apart (to zoom in).

Set the Time Zone









The computer gets the current date and time from its network connection. If preferred, you can change this behavior and manually set the time zone for your location.



1. Swipe up from the bottom of the Home screen to access all apps.
2. Tap **Settings**  > **System** > **Date & time**.
3. Tap **Automatic time zone** to turn Off the feature.
4. Tap **Select time zone** and choose the time zone for your location.

About Honeywell Applications

Honeywell applications help you troubleshoot and connect your computer to other devices and networks. Some of the applications in this table are located in the Power Tools app. To learn more about Honeywell Power Tools, go to www.honeywellaidc.com to download the *Power Tools User Guide*.

Honeywell Applications Available on the Computer

Icon	Application	Description
	AutoInstall Settings	Enable the AutoInstall feature, to automatically install *.zip or *.apk files containing applications saved in the Internal shared storage\honeywell\autoinstall folder and IPSM card\honeywell\autotinstall folder on the computer during the power-up boot or reboot process.
	Demos	Honeywell Demo apps demonstrate the basic capabilities of the computer and are not intended as functional business solutions. The demos included, demonstrate scanning, signature capture, NFC functionality, and printing via Bluetooth technology. Information on how to create custom applications for your Honeywell mobile computer can be found in the Honeywell Software Development Kit (SDK) for Android, available from the Technical Support Downloads Portal .
	HUupgrader	Use the HUupgrader app to view the current OTA version on the computer, check for updates, or initiate an OTA upgrade from storage.
Power Tools		
	BattMon	BattMon provides information on the charge status and health of the battery, and provides access to activate battery status notifications and battery charging history logs.
	ConfigApps	ConfigApps enables or disables applications and application updates.
	Configure Autorun	Configure Autorun provides the ability to set applications to automatically run after a reboot.
	Diagnostic Information	Diagnostic Information provides access to system statistics, notifications and version information about the computer.
	EZConfig	EZConfig supports advanced customization and configuration of the hand held computer. EZConfig includes a standard XML editor and configuration bar code scanner feature.

Icon	Application	Description
	WiFi Diagnostic	Use application to: <ul style="list-style-type: none"> View Wi-Fi radio status information about a connected access point or a list of other available access points in range of the Wi-Fi radio. Use the Route utility to view packet destination gateway information across the subnets. Use the IPConfig utility to view IP parameters for the on-board network adapters. Use the Ping utility to verify communication links or to make sure a specific IP address is working.
	Wireless Tether	Use to enable range tracking and customize out-of-range alerts for Bluetooth devices paired and tethered to your hand held computer.

Applications You Can Download to the Mobile Computer

You can download Honeywell applications to extend the capabilities of the computer. You may need to purchase a license to run some applications. To learn more about the applications described in this section and other Honeywell software solutions, go to www.honeywellaidc.com > **Browse Products** > **Software**.

About Honeywell Enterprise Browser

Enterprise Browser for Microsoft® Internet Explorer® is a locked-down enterprise Web client application designed for Honeywell computers. It provides a controlled Web application environment that helps enterprises increase productivity and reduce IT management expenses. You can configure Enterprise Browser for your specific application requirements and design custom web applications that run through the Enterprise Browser to provide your users with an easy-to-use yet controlled experience.

If Enterprise Browser is not included on your computer model, you can download a trial version for evaluation. After the evaluation period expires, you need to purchase a license. For more information about Enterprise Browser, visit www.honeywellaidc.com.



About Honeywell Launcher

Launcher is a configurable locked-down menu program designed for Honeywell computers that prevents end-users from accessing the start menu and other non-authorized applications. Use Launcher to provide a platform where your mobile computer users are limited to running only company-approved applications and prevent them from initiating unauthorized configuration changes. You can also use Honeywell Launcher together with Honeywell Enterprise Browser to create a single-purpose device configuration.

If Launcher is not included on your computer model, you can download a trial version of the software for evaluation. After the evaluation period expires, you need to purchase a license. For more information about Launcher, visit www.honeywellaidc.com.

Unlock Developer Options

Developer options only appear in the Settings app if you unlock the feature. If you are a developer working with the computer, you can easily unlock the additional settings to use for testing and debugging applications under development for the computer.

1. Swipe up from the bottom of the Home screen to access all apps.
2. Tap **Settings**  >**System** > **About phone**.
3. Tap **Build number** seven times. A message appears informing you that you are now a developer.
4. Tap **Developer options** under **Settings**  >**System**.

USE THE IMAGE ENGINE

Use this chapter to understand how to scan bar codes, configure the scan settings, and capture images using the integrated image engine in the computer.

About the Image Engine

You can use the image engine in the computer as a scanner or camera.

Use the imager as a scanner to read 1D and 2D bar code symbologies, composite symbologies, and postal codes. It also supports omni-directional scanning for greater flexibility in real-world settings. By default, the scanner feature is enabled and uses the default scan profile. You can modify the Default Profile or create new profiles for custom applications from **Settings > Honeywell Settings > Scanning**.

Use the imager as a camera to capture black and white images, such as signatures or pictures of damaged inventory.

Note: *Instead of using the internal imager, you can also use Bluetooth communications to connect the computer to an external scanner, such as the Granit™ 1981i and 1911i.*

About the Scan Wedge Feature

The scan wedge feature sends scanned bar code data to an active application as Android keypad input. To scan a bar code as keyboard input, open an application that accepts text input and then scan a bar code. You can use applications that are coded to use the scanner or applications that receive data through the scan wedge feature. If an application claims the scanner through the BarcodeReader API, the scan wedge feature is temporarily disabled.

You can find information on how to create custom applications for the computer in the *Software Development Kit (SDK)* available for download from the *Technical Support Downloads Portal* at <https://hsmftp.honeywell.com>. Once you create an account and enter the portal, navigate to **Software > Software and Tools > Developer Library > SDKs for Android**.

Change the Scanner Settings

Changes you make to the Default profile apply to all applications with no profile assigned.

1. Swipe up from the bottom of the Home screen to access all apps.
2. Tap **Settings**  > **Honeywell Settings** > **Scanning**.
3. Tap **Internal Scanner** > **Default Profile**.
4. Select from the following:
 - **Data Processing Settings**,
 - **Symbology Settings**,
 - **Decode Settings**,
 - **Imager Settings**,
 - **Trigger Settings**, or
 - **Notification Settings**.
5. Modify the settings to meet your application needs.

To learn more about the scanner settings, [Default Scan Settings](#) on page 35.

Restore Default Scan Settings

You can easily discard all changes you made to the Default profile and restore the default values.

Note: *When you choose the Restore all defaults option from any of the settings screens in a profile, all the settings in that profile return to their default values.*

1. Open the **Default profile**.
2. Tap  in the upper right corner of any of the scan settings screens for the profile.
3. Tap **Restore all defaults**.

Default Scan Settings

Use the following sections to understand the scan settings available for scanner profiles. To learn how to create a new profile, see page 39.

Data Processing Settings

Use the Data Processing Settings to specify how bar code data is processed by the computer.

Data Processing Settings

Setting	Description	Default										
Wedge	Enable or Disable the scan wedge feature.	Enabled										
Wedge Method	Standard or Keyboard.	Standard										
Charset	Select the character set to use when interpreting the bar code data into a string.	ISO-8859-1										
Prefix	<p>Defines the string added before the decoded bar code data. Substitutions occur within the Prefix string values.</p> <table border="1"> <thead> <tr> <th>Substring</th> <th>Replacement Character Code</th> </tr> </thead> <tbody> <tr> <td>\r</td> <td>13</td> </tr> <tr> <td>\n</td> <td>10</td> </tr> <tr> <td>\t</td> <td>9</td> </tr> <tr> <td>\\</td> <td>^\'</td> </tr> </tbody> </table>	Substring	Replacement Character Code	\r	13	\n	10	\t	9	\\	^\'	None
Substring	Replacement Character Code											
\r	13											
\n	10											
\t	9											
\\	^\'											
Suffix	<p>Defines the string added after the decoded bar code data. Substitutions occur within the Suffix string values.</p> <table border="1"> <thead> <tr> <th>Substring</th> <th>Replacement Character Code</th> </tr> </thead> <tbody> <tr> <td>\r</td> <td>13</td> </tr> <tr> <td>\n</td> <td>10</td> </tr> <tr> <td>\t</td> <td>9</td> </tr> <tr> <td>\\</td> <td>^\'</td> </tr> </tbody> </table>	Substring	Replacement Character Code	\r	13	\n	10	\t	9	\\	^\'	None
Substring	Replacement Character Code											
\r	13											
\n	10											
\t	9											
\\	^\'											
Wedge as Keys	List of character values to wedge as keys, represented as a comma-separated list of decimal values.	9,10										
Data Editing Plugin	Specify a data editing plug-in and edit plug-in settings.	None										
Symbology Prefix	<p>Specify a symbology identifier prefix to the bar code data. Options include:</p> <ul style="list-style-type: none"> • None • Honeywell • AIM 	None										

Setting	Description	Default
Launch Browser	<p>Enable or disable URL bar code handling. If a bar code starts with http:// or https://, the browser opens using the bar code data as a URL.</p> <p>Corresponds to BarcodeReader property: PROPERTY_DATA_PROCESSOR_LAUNCH-BROWSER</p>	Enable
Scan to Intent	<p>Enable or disable special handling of scan-to-intent bar codes.</p> <p>Applies to bar codes in one of the following formats: '//' ACTION '//' ACTION '\$' extra-data</p> <p>Where: ACTION and extra-data are any string of characters.</p> <p>Launches an application listening for the intent. Intent action: "com.honeywell.scantointent.intent.action." + ACTION Intent extra: "com.honeywell.scantointent.intent.extra.DATA" contains the remainder of the bar code data after the first '\$' character.</p> <p>Corresponds to BarcodeReader property: PROPERTY_DATA_PROCESSOR_SCAN_TO_INTENT</p>	Enabled
Launch EZ Config	<p>Enable or disable special handling of EZConfig bar codes.</p> <p>Applies to EZConfig bar codes that are encoded with the Aztec symbology and contain specific header data.</p> <p>Corresponds to BarcodeReader property: PROPERTY_DATA_PROCESSOR_LAUNCH_EZ_CONFIG</p>	Enabled
Data Intent	<p>Enables the reception and processing of bar code data without using an SDK or library.</p>	Disabled

Symbology Settings

Use the Symbology Settings to enable or disable bar code symbologies for the selected scan setting profile.

- Tap the check box next to a symbology name to enable (check mark) or disable (no check mark) decoding for that symbology.
- Tap the symbology name to view and modify additional configuration parameters for the symbology selected.

To view a list of default settings for supported symbologies, see [page 74](#).

Decode Settings

Adjust the Decode Settings when scanning bar codes that are densely packed or poor quality.

Decode Settings

Setting	Description	Default
Center Decode	<p>When enabled, the imager scans and decodes a bar code only if part of the bar code is at the center of the aimer window. This is useful in situations where several bar codes may be very close together in the imager field-of-view.</p> <ul style="list-style-type: none"> • Tap the check box to toggle the feature On or Off. • Select Center Decode to adjust the Window dimensions. <p>Honeywell recommends leaving the settings at 50 (default) to define the “center” area for the bar code.</p> <p>Configurable parameters:</p> <ul style="list-style-type: none"> • Window top • Window bottom • Window left • Window Right 	Disabled
Decode Security	<p>Use this setting to control the reading tolerance of the decoder. Lower settings are more lenient when reading low quality bar codes while higher values are more strict.</p>	2
Poor Quality 1D Reading	<p>Enable this setting when scanning damaged or badly printed 1-D bar codes to improve bar code read success.</p>	Disabled
Video Mode	<p>Use this setting to specify whether normal or inverse decoding for linear symbologies is enabled during the execution of Decode. By default normal video is enabled.</p> <p>Options include:</p> <ul style="list-style-type: none"> • Normal • Inverse • Normal and Inverse 	Normal
DPM mode	<p>Use this setting when scanning Direct Part Marking (DPM) bar codes that are etched or imprinted directly into the surfaces of materials including metal and plastic.</p> <p>Options include:</p> <ul style="list-style-type: none"> • No DPM optimization • Dot Peen DPM decoding • Reflective DPM decoding 	No DPM optimization

Setting	Description	Default
Region of Interest	<p>Set the ROI for decoding. Options include:</p> <ul style="list-style-type: none"> • Disable ROI is disabled and the entire original image is sent to the decoder. • Standard Use the aimer position to weight activity. Activity calculated on the row and the column in the middle of each cell. The ROI window may not include the aimer. • Standard, aimer centered Activity calculated on the row and the column in the middle of each cell. The ROI window will always include the aimer. • DPM, aimer centered Activity calculated on 4 rows and 2 columns in each cell. The ROI window will always include the aimer. • Kiosk/presentation application Ignore aimer position, no weight activity. Activity calculated on the row and the column in the middle of each cell. The ROI window may not include the aimer. 	Disabled

Imager Settings

You should not need to modify the Imager Settings. The **Override Recommended Values** setting is disabled by default. The recommended Imager Settings are designed to work in a wide range of environments and should only be modified if you have an advanced understanding of imagers.

Trigger Settings

Use the Trigger Settings to configure how the scan buttons work.

Trigger Settings

Setting	Description	Default
Enable Scan Trigger	Enable or Disable activating the imager by pressing the side scan buttons or the virtual Scan button in the Scan Demo app.	Enabled
Scan delay	Set the minimum amount of time in seconds before the scanner can read another bar code.	0
Decode Timeout	Set the number of seconds before the scanner automatically turns off if the scan button is pressed and nothing has successfully decoded.	20
Trigger Scan Mode	<p>Set read behavior on scan button press. Options available:</p> <ul style="list-style-type: none"> • One Shot • Continuous • Read on release • Read on second trigger press 	One Shot

Setting	Description	Default
Same symbol timeout	Set the minimum buffer time in seconds before the scanner reads the same bar code. This can be adjusted to prevent inadvertent scans of the same bar code if the code is left in the scan field longer than the Decode Timeout limit. The default same symbol timeout is 1000 seconds.	Disabled

Notification Settings



Use the Notification Settings to configure how your computer responds when you scan a bar code.

Notification Settings

Setting	Description	Default
Good Read Notification	Enables or disables a good read notification. The notification consists of a green blink of the Scan Status LED, a short beep, and an optional short vibration.	Enabled
Bad Read Notification	Enables or disables notification of a failed scan. The notification consists of a red blink of the Scan Status LED, an error beep, and an optional short vibration.	Disabled
Vibrate On Notification	Enables or disables whether the computer vibrates when there is a good or bad read.	Disabled

Add a Scan Setting Profile

To create a scan setting profile for a custom app on the computer:

1. Swipe up from the bottom of the Home screen to access all apps.
2. Tap **Settings**  > **Honeywell Settings** > **Scanning** > **Internal Scanner**.
3. Tap  in the upper right corner of the app screen.
4. Take one of the following actions:
 - Tap the profile name field. Add a new name, and then select **OK**.

OR

 - Tap the **select an application** option, and then choose an app from the list.

The new profile appears on the Internal Scanner profile list. You can now select and modify the scan settings for the new profile.

Delete a Scan Setting Profile

1. Swipe up from the bottom of the Home screen to access all apps.
2. Tap **Settings**  > **Honeywell Settings** > **Scanning** > **Internal Scanner**.

3. Tap and hold the profile you want to delete.
4. Select **Delete**, and then **OK**.

About the Optional Digital Scan Button

By default, the imager is enabled for scanning with the left, right, and front scan buttons configured to trigger the imager. If your application environment requires use of an on-screen scan button, enable the Digital Scan Button feature in the Settings app. Once enabled, you can then modify the appearance of the on-screen Scan button and select the apps the button appears in.

Enable and Configure the Digital Scan Button

1. Swipe up from the bottom of the Home screen to access all apps.
2. Tap **Settings**  > **Honeywell Settings** > **Digital Scan Button**.
3. Tap **Enable Digital Scan Button** to turn the feature on. A preview of the button appears at the bottom of the screen.
4. Configure the button appearance. As you adjust the settings, the preview button updates.
 - Tap **Select Button Size**, and then choose Small, Medium or Large.
 - Tap **Select Button Color** and then choose from seven color options. Default color is black. Tap a dot to select the color, and then select **OK** to confirm.
 - Use the slider under **Transparency Level** to adjust how transparent the button appears on the application screen.
5. Drag the preview button to the location where you want it to appear on the screen. Once you have positioned the button, select the **Set Button Location** toggle button to lock it into position.
6. Tap **Choose Application**.
7. Check the box next to all the applications where you want the digital scan button to be available.
8. Select **OK**.
9. Tap **Back** to return to the Settings screen.

The digital scan button appears on the screen when you open any of the apps you selected during the button setup. Tap and hold the button to activate the imager and scan a bar code.

Scan Bar Codes

By default, the computer imager is enabled for scanning. It supports omni-directional (360°) bar code scanning and an aiming beam is provided to help assist with targeting bar codes.

Before you start scanning bar codes, go into **Settings > Honeywell Settings > Scanning > Internal Scanner** and modify the scan profile to enable only the bar code symbologies that you need. By reducing the active symbology list, you can increase scan speed.

1. Point the scanner window at the bar code. For optimum performance, avoid reflections by scanning the bar code at a slight angle.
2. Press and hold any **Scan** button (i.e., right, left, or front).
3. Center the aiming beam over the bar code. Make sure the entire bar code is inside the illumination frame.

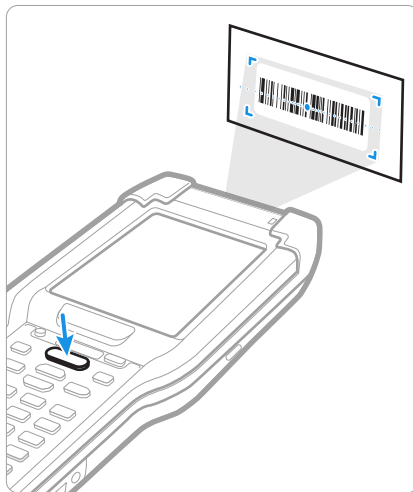

4. Release the Scan button when the computer beeps, and the Scan Status LED briefly turns on. The bar code information is entered into the application in use.

Note: *Not all bar code symbologies are enabled by default. If a bar code does not scan, the correct symbology may not be enabled.*

About Scanning Configuration Bar Codes

After completing the out-of-box set up process, Provisioning mode is automatically turned Off. Scanning a bar code to install applications, certificates, configuration files, and licenses on the computer is restricted unless you turn On (enable) Provisioning mode in the Settings app.

To learn more [About Provisioning Mode](#) see [page 63](#).

Use the Scan Demo App

Use the Scan Demo app to read bar codes or to test your symbology decode settings.

1. Swipe up from the bottom of the Home screen to access all apps.
2. Tap **Demos**.
3. Swipe left or right on the screen until **Scan Demo** appears under the turntable. Tap the center of the box image to open the app.
4. Point the scanner window at the bar code.
5. Press and hold any **Scan** button (i.e., right, left, or front) or tap and hold the on-screen **Scan** button.
6. Center the aiming beam over the bar code. Make sure the entire bar code is inside the illumination frame.

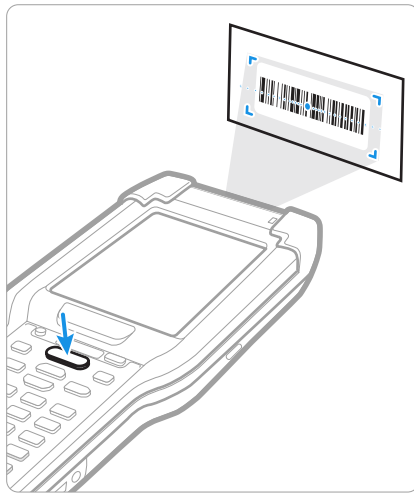

7. Release the Scan button when the computer beeps, and the Scan Status LED briefly turns On. Bar code information appears on the screen.

Note: In the Scan Demo app, not all bar code symbologies are enabled by default. If a bar code does not scan, the correct symbology may not be enabled.

Change the Scan Demo Symbology Settings

1. In the Scan Demo app, tap  in the upper right corner of the screen.
2. Select **Symbology Settings**.
3. Modify the symbology parameters.
 - Tap the check box next to a symbology name to enable (check mark) or disable (no check mark) decoding for that symbology.
 - Tap the symbology name to view and modify additional configuration parameters for the symbology selected.
4. Tap **Back** to return to the Scan Demo app.

USE THE CAMERA

Use this chapter to learn how to take pictures and record videos with the color camera.

About the Color Camera

The CK65 comes equipped with a 13-megapixel color camera, 4K video with image stabilization, and advanced software features for enhanced exposure control for taking pictures and videos. The camera lens and flash are located on the back of the computer.

Use the Photos app  to view photos and videos stored on the CK65.

By default the photos and videos captured with the Camera app are saved on the computer under Internal shared storage\DCIM\Camera.

How to Zoom

The camera zoom is controlled using a pinching motion on the touch screen. Place two fingers on the screen at the same time, and then:

- spread them apart to zoom in (enlarge and object).
- pinch them together to zoom out.

Take a Photo

1. Tap the **Snapdragon™ Camera** icon  in the favorites tray on the Home screen.
2. Using the screen as a viewfinder, move the computer until you see the image you want to capture. The camera lens is located on the back of the computer.

3. The camera automatically adjusts the focus but you can tap the screen to modify the focal point. By default, the camera senses the lighting in the environment and turns the flash on, if needed.
4. Tap  to take a photo.
 - To view the picture, tap the preview near the bottom of the screen.
 - To return to the Camera app, tap the **Back** navigation button.

Change Camera Settings

You can change the camera settings for best results when taking pictures. The camera settings are adjustable from within the Snapdragon™ Camera app.



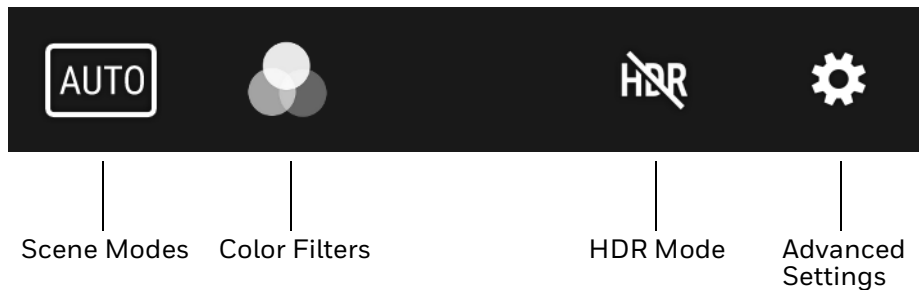

1. Open the **Snapdragon Camera** app .
2. At the top of the screen, select any of the following to adjust the settings.



- **Scene Modes**
Use preset setting profiles for best picture quality. Options include: Automatic, High Dynamic Range (HDR), OptiZoom, Portrait, Landscape, Sports, Flowers, Backlight, Candlelight, Sunset, Night, Beach, and Snow.
- **Color Filters**
Stylize your pictures by applying a filter. Options include: None, Mono, Sepia, Negative, Solarize, Posterize, Aqua, Emboss, Sketch, Neon.
- **HDR Mode**
Tap to quickly toggle HDR mode On or Off. When enabled, the computer automatically captures multiple photos and combines them into one photo creating the best quality image possible.
- **Advanced Settings**
Manually set advanced features. Options include: Flash, Picture size, Picture quality, Countdown timer, Storage, Continuous shot, Face detection, ISO, Exposure, White balance, Redeye reduction, and Shutter sound.



Record a Video

This section explains how to record video with the camera in the computer.

1. Tap the **Snapdragon Camera** icon  in the favorites tray.
2. Tap mode selection  in the bottom right corner of the app.
3. Tap  to select video.
4. Tap  to begin recording video. To zoom in or out, pinch or spread your fingers apart.
5. When you are done recording, tap .

Change Video Settings

You can change the video settings for best results when recording video.

1. Open the **Snapdragon Camera** app .
2. Tap  to select video.
3. At the top of the screen, select any of the following to adjust the settings.

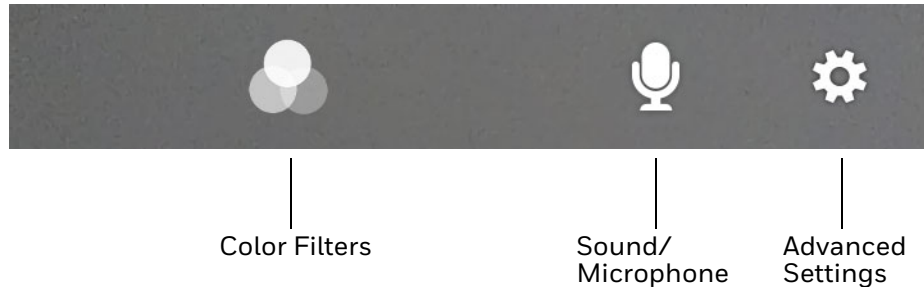

- **Color Filter**
Stylize your video by applying a filter. Options include: None, Mono, Sepia, Negative, Solarize, Posterize, Aqua, Emboss, Sketch, Neon.
- **Sound/Microphone**
Tap to quickly toggle sound recording On or Off.
- **Advanced Settings**
Manually set advanced features. Options include: Flash, Video quality, Video duration, GPS location, Storage, White balance and Image stabilization.

Use the Camera as a Flashlight

To use the camera as a flashlight.

1. Open Quick Settings (see page [26](#)).
2. Tap the **Flashlight** icon to turn the flashlight on.
 - Select the icon again to turn the flashlight off.

CONFIGURE THE COMPUTER

Use this chapter to learn about the available methods for configuring your mobile computer. You can also use this chapter to learn how to configure network communications and wireless security.

How to Configure the Computer

You can configure many parameters on the computer such as the bar code symbologies the integrated scanner decodes, or the network settings. The values you set for these parameters determine how the computer operates.

You configure the computer using the Settings app.

Start the Settings App

The Settings app is available from the all apps menu and the notification panel.

- Swipe up from the bottom of the Home screen to access all apps, and then tap Settings .

OR

- Swipe down from the top of the Home screen, and then select  in the status bar.

About the Structure of the Settings App

Use this section to learn about the structure of the Settings app so you can find parameters quickly.

Note: *The Settings app varies by computer model and OS version. Your computer may not include all the features outlined in this section.*

When you open the Setting app, suggestions appear at the top of the list.

- Tap **▼** or **▲** to expand or collapse the suggestion list.
- Tap a suggestion to open the settings screen or app relevant to the suggestion.
- Swipe left to dismiss the suggestion.

Network & Internet

In the Settings app, select **Network & Internet** to access the following settings.

Setting	Description
Wi-Fi	<ul style="list-style-type: none"> • Turn WLAN radio On or Off. • Lists available Wi-Fi networks in range and the connection status when the radio is turned On. • Add a network Wi-Fi connection.
Data usage	<ul style="list-style-type: none"> • Manage mobile/cellular data usage. • View mobile or Wi-Fi data use statistics for the current data use cycle. • Turn the Data saver feature On or Off. • Turn network restrictions for metered WLAN networks On or Off.
Hotspot & tethering	<ul style="list-style-type: none"> • Enable or disable USB tethering or Bluetooth tethering for sharing mobile data connections. • Enable or Disable using the computer as a portable Wi-Fi hotspot. • Configure Wi-Fi hotspot.
Ethernet	<ul style="list-style-type: none"> • Turn Ethernet connection on and off. • Configure Ethernet connections and set up proxy settings when the Ethernet setting is turned On.
VPN	Set the password parameters for a virtual private network (VPN) connection.
Airplane mode	Turn Airplane mode On or Off.

Connected devices

In the Settings app, select **Connected devices** to access the following settings.

Setting	Description
Bluetooth	<ul style="list-style-type: none"> • Turn the Bluetooth radio On or Off. • Lists Bluetooth enabled devices in range when the radio is turned On. • Connect to a Bluetooth Device. • View and rename the computer. • View the computer Bluetooth address. • View received files.
Cast	Set up a Cast connection. Cast (project) audio and screen content to a secondary device such as a television.
NFC	Turn Near Field Communication (NFC) On or Off. When the NFC radio is enabled, data exchanges are allowed when the computer touches another NFC enabled device.

Setting	Description
Android Beam	Turn the Android Beam feature On or Off. When NFC is enabled, this feature is accessible. You can beam app content to another NFC capable device by holding the devices close together. The app determines what content is transmitted to the other device.
Printing	Set up a printer connection with the CK65. Connection options include cloud print services, Wi-Fi printing via a router or printing via NFC.
USB	Configure USB communication.
Chromebook	Connect the CK65 to a Chromebook.

Apps & Notifications

In the Settings app, select **Apps & Notifications** to access the following settings.

Setting	Description
App info	View a list of all apps installed on the computer and system services running.
Notifications	<ul style="list-style-type: none"> • Manage notifications (e.g., turn notifications On/Off. • Set rules for notifications on the screen lock. • Turn notification dots On/Off. • Turn LED blink notification On/Off. • Set the default sound for all notifications.
App permissions	View and manage individual app permissions.
Advanced	
Default apps	View and manage default app use.
Emergency alerts	Manage Emergency alert notifications.
Special app access	Manage apps with special unrestricted access.

Battery

In the Settings app, select **Battery** to view battery status, use statistics and adjust features that conserve battery charge.

Setting	Description
Battery	View current battery charge or charging status.
Battery saver	Turn the Battery saver feature On or Off and set when the feature automatically activates. <ul style="list-style-type: none"> • Never • When the battery charge is at 5%. • When the battery charge is at 15%.
Battery percentage	Set to show or do not show battery percentage in status bar.
Adaptive brightness	Turn the Adaptive brightness feature On or Off.
Sleep	Set the inactivity time limit before the unit automatically turns off the screen to save battery power (seconds or minutes).
Ambient display	Set how the screen in sleep mode responds when new notifications are received (e.g., wake or do not wake).

Setting	Description
App battery usage data	View battery usage data.

Display

In the Settings app, select **Display** to access the following settings.

Setting	Description
Brightness level	Set the Brightness level manually if Adaptive brightness feature is turned Off.
Night light	Activate the Night light feature to adjust the screen tint to a light amber for easier viewing and reading in dim light or for the hours you use the device before going to sleep. Set the feature to stay on or define a schedule to automatically turn the feature On/Off. You can manually adjust the intensity of the amber hue once the feature is activated.
Adaptive brightness	Set how the screen in sleep mode responds when new notifications are received (e.g., wake or do not wake).
Wallpaper	Set the wallpaper.
Advanced	
Sleep	Set the inactivity time limit before the unit automatically turns of the screen to save battery power (seconds or minutes).
Keypad Backlight	Set the inactivity time limit before the unit automatically turns off the keypad backlight to save battery power (seconds or minutes).
Auto-rotate screen	Set the screen to switch from portrait to landscape when the unit is rotated. When Off the screen does not automatically rotate.
Font size	Set the default on-screen text size.
Display size	Set the default size of items on your screen.
Screen saver	Set the default screen saver as well as when to display it. Tap Settings  to select screen saver style or to turn Night mode on.
Ambient display	Set how the screen in sleep mode responds when new notifications are received (e.g., wake or do not wake).

Sound

In the Settings app, select **Sound** to modify the audio and sound settings. To learn more, see [Audio Settings](#) on page 18.

Storage

In the Settings app, select Storage to view statistics on available and used storage space on the device and on any portable storage cards installed.

Security & Location

In the Settings app, select **Security & Location** view latest Security scan results, security updates and phone encryption status. Access additional settings related to device security.

Setting	Description
Screen Lock	Activate and configure a screen lock (i.e., None, Swipe, Pattern, Pin, Password).
Lock screen preferences	Configure the following lock screen parameters: <ul style="list-style-type: none">• Select notifications you want shown on the lock screen.• Enable or disable adding users from the lock screen.• Customize the lock screen message.
Smart Lock	Define safe conditions or locations where your phone will stay unlocked (e.g. On-body, Trusted places, Trusted devices, Voice Match).
Location	<ul style="list-style-type: none">• Turn location services (Google and GPS satellite data) On or Off.• View and manage app-level location service permissions.• Set location mode accuracy and view location request history.• Turn Wi-Fi and/or Bluetooth scanning On or Off. When enabled system apps and services are allowed to detect Wi-Fi networks or Bluetooth devices at any time to improve location services.
Show passwords	Enable or disable showing characters briefly as you type.
Device admin apps	Manage administrator privileges.
Encryption & credentials	View encryption status and manage trusted credentials (e.g., view, install, clear, and edit).
Trusted agents	View and enable/disable trusted agent apps such as, Smart Lock by Google on the device. Trusted agents bypass security based on set parameters.
Screen pinning	Enable or disable the screen pinning feature. When enabled you can pin the device screen to a recently used app where it stays until you unpin the app via the security method chosen.
Apps with usage access	View and manage apps with usage permission.

Users & Accounts

In the Settings app, select **Users & accounts** to access the following settings.

Setting	Description
Users	<ul style="list-style-type: none">• Modify the owner profile name and add profiles for other people who use the computer.• Activate a different user profile.
Add account	Select to add and manage Corporate or Email account on the computer.

Setting	Description
Emergency Information	Enter emergency information for the active user profile. The information you enter may be used by first responders in an emergency. Anyone can read the information from the emergency dialer without unlocking the computer.
Automatically sync data	Turn auto-sync On or Off for accounts. Turning the feature On allows apps to refresh data automatically.
Add users from lock screen	Enable or disable allowing users to be added from the lock screen.

Honeywell Settings

In the Settings app, select **Honeywell Settings** to access the following settings.

Setting	Description
Battery LED	Configures the battery LED behavior. To learn more see, Change the Battery Status LED Behavior on page 9.
Battery Optimizer	View battery status and app usage information. Create and enable or disable a battery optimization profile that implements a group of settings to conserve power. Options include: <ul style="list-style-type: none"> • None When selected, no battery optimization profile is active. • Energy Saver This pre-defined profile implements UI settings that optimize battery conservation. • Cold Storage This pre-defined profile implement UI settings that optimize battery conservation in cold storage environments. • Add a Custom Profile Tap to create a custom battery profile that balances your application needs with energy saving settings. You can turn location services On or Off, configure sound and vibration options, modify brightness and timeout display options, turn UI transition animations On or Off and background services On or Off.
Digital Scan Button	Enable and configure the optional digital scan button. To learn more, see About the Optional Digital Scan Button on page 40.
Honeywell Power	Turn Unattended Mode on or off. When Unattended Mode is on, healthcare apps will continue to notify clinicians of critical communication, even though the unit appears to be in sleep mode.
HXLogger	The HXLogger is an advanced diagnostic log service that provides a basic log service, plug-ins for modified log services, and a log manager. <ul style="list-style-type: none"> • Tap HXLogger to turn the basic log service On or Off. When enabled the service records app and system diagnostic troubleshooting information into four basic log files: main log file, radio log, event log, and kernel log. • Tap Plugin to view and enable additional log services and custom plug-ins. • Tap Manager, to change the default log path, delete logs or upload logs for technical support troubleshooting.

Setting	Description
Key Remap	Change (remap) a button or key function. To learn more, see Remap a Button or Key on page 25.
Key WakeUp	Set the buttons you want to use to wake the computer from sleep mode. Options include: Left Scan, Middle Scan, Right Scan. By default the Left, Middle and Right Scan buttons are enabled for wake up.
Provisioning Mode	Enable or disable unrestricted installation of applications, certificates, configuration files, and licenses. Provisioning mode is turned Off by default. To learn more About Provisioning Mode , see page 63.
Scanning	Configure the computer imager. To learn more, see Change the Scanner Settings on page 34.
Smart sensors	Configures the integrated motion detection sensors for advanced power management. Options include: Keep awake on motion, Wake on motion, Face down suspend.
Staging Hub Agent	Use this agent and settings to connect the computer to the Honeywell Staging Hub Foundation software platform; a centralized software platform IT integrators and administrators can use as a solution for managing, monitoring and deploying Honeywell devices in a connected workspace environment.
Web Applications	Enable access for Honeywell Mobility SDK for Web apps and port selection.

Accessibility

In the Settings app, select **Accessibility** to access screen readers, display settings, interaction controls, and audio & on-screen text features to improve accessibility levels.

Setting	Description
Select to Speak	When turned on, you can tap specific items on the screen to hear them read aloud.
TalkBack	When turned on, the feature provides spoken feedback so you can use the computer without always looking at the screen. TalkBack describes your actions and tells you about alerts and notifications
Text-to-speech output (TTS)	Select and configure the preferred TTS engine, set language, speech rate and pitch of synthesized voice.
Display	Configure display features that may aid visual accessibility levels. <ul style="list-style-type: none"> • Adjust Font size • Display size • Turn the Magnification feature On/Off • Set Color correction • Turn Color inversion On/Off • Turn Large mouse pointer On/Off
Interaction controls	Set interaction controls that may aid physical accessibility levels. <ul style="list-style-type: none"> • Configure Switch Access. • Set the Click after pointer stops moving delay. • Turn Auto-rotate screen On/Off • Adjust the Touch & hold delay

Setting	Description
Audio & on-screen text	Turn Mono audio On/Off and Captions On/Off.
High contrast text	Turn High contrast text On/Off.

Google

In the Settings app, select **Google** to set up and manage your Google accounts and services.

System

In the Settings app, select **System** to access the following settings.

Setting	Description
Language & input	<ul style="list-style-type: none"> Set the active language. Set and manage Virtual and Physical Keyboard input methods. Configure auto-typing features such as capitalization, punctuation, spell check, and the personal dictionary. Set text-to-speech output. Adjusts the pointer speed.
Date & time	Configure all date and time settings.
Backup	Turn the Google Drive backup feature On or Off. When enabled, phone data (e.g., apps, apps data, call history, contacts, device settings, SMS, Wi-Fi passwords and permissions) is automatically backed up to the Google Drive.
Developer options	Enable developer-specific options such as USB debugging and SD card protection. This option only appears under System settings if you enable the feature. To learn more, see Unlock Developer Options on page 31.
Reset options	Select from the following reset options: <ul style="list-style-type: none"> Reset Wi-Fi, Mobile & Bluetooth Use to reset all network settings, including Wi-Fi, Mobile data and Bluetooth. Reset app preferences. Use reset app preference back to defaults. This apps you disabled, notification changes, default app actions set, background data restrictions for apps and permission restrictions. Enterprise data reset. To learn more, see Enterprise Data Reset the Computer on page 70. Erase all data (factory reset). To learn more, see Erase All Data (Factory Reset) on page 71.
About phone	View device specific information including the model number, operating system version, software patch version, radio versions, build number and legal information.

About Network Communications



You can easily add the mobile computer to your wireless or wired data collection network. Connect the CK65 your computer using:

- 802.11 a/b/g/n/ac radio communications.
- Ethernet communications.
- Bluetooth communications.
- USB and serial communications.

Connect to a Wi-Fi Network

The computer contains an 802.11 a/b/g/n/ac radio to transfer data using wireless communications. Before you connect to a Wi-Fi network, you need to know about your network security protocol and its required credentials.

By default, the 802.11 radio is disabled.

1. Swipe up from the bottom of the Home screen to access all apps.
2. Tap **Settings**  > **Network & Internet** > **Wi-Fi**.
3. Tap **Off**  to toggle Wi-Fi radio **On** . A list of discovered networks appears.
4. On the list, tap a network name to initiate a connection.

To add a network if it does not appear on the list:

- a. Navigate to the end of the discovered network list, and then tap **Add network**.
 - b. Type the Wi-Fi network name (SSID).
 - c. Choose a security protocol and add any required information.
 - d. Tap **Save**.
5. Enter any required information if the network is secured (e.g., password, key or certificate name).
 6. Tap **Connect**.

Once you connect to a saved Wi-Fi network:

- Tap the network name on the list to view details (e.g., status, signal strength, speed, frequency, security type). Select  to close details screen.
- The computer automatically connects to the same network when the network is in range and the WLAN radio is turned On.
- To remove a network from your saved list, tap and hold the network name and select **Forget network**. You can do this for networks you no longer use.
- To modify a network from your saved list, tap and hold the network name and select **Modify network**. You can do this if you changed your network password.

- To view a list of only your saved networks, navigate to the bottom of the discovered network list. Tap **Saved networks**.

Configure Proxy Settings for a Wi-Fi Network

If you need to connect to network resources through a proxy server, you can configure settings for the proxy server for each Wi-Fi network you add. By default, the Wi-Fi networks you add are not configured to connect through a proxy server.

Note: Proxy settings apply only to the Wi-Fi network you modify. You must change proxy settings for each network requiring a proxy server.

1. Swipe up from the bottom of the Home screen to access all apps.
2. Tap **Settings**  > **Network & Internet** > **Wi-Fi**. The list of available Wi-Fi networks appears.
3. Tap and hold the name of a connected network, and then tap **Modify network**.
4. Tap **Advanced options**.
5. Under Proxy, tap **None** to open menu, and then select **Manual**.
6. Enter the proxy settings for the network.
7. Tap **Save**.

Disable Wi-Fi Notifications

By default, when Wi-Fi is enabled, you receive notifications in the Status bar when the computer discovers a wireless network. You can disable these notifications.

1. Swipe up from the bottom of the Home screen to access all apps.
2. Tap Settings  > **Network & Internet** > **Wi-Fi**. Verify the WLAN radio is turned On.
3. Navigate to the bottom of the discovered network list.
4. Select **Wi-Fi preferences**.
5. Tap **Open network notification** to toggle the setting On or Off.

Connect to an Ethernet Network

To connect the computer to an Ethernet network, you need a CK65 Ethernet Home Base or a CK65 Net Base.

1. Make sure the base is connected to your Ethernet network.
2. Place the computer in the base.
3. Swipe up from the bottom of the Home screen to access all apps.

4. Tap **Settings**  > **Network & Internet** > **Ethernet**. The Ethernet setting is turned On by default.
5. Tap **Ethernet**.

The Ethernet connection screen shows the current Ethernet connection. By default, the computer assumes a DHCP connection, and that your network has assigned an IP address automatically. If DHCP is working, the Ethernet base should indicate that communication with the network is occurring.
6. (Optional) To assign a static IP address.
 - a. Tap **DHCP** and then select **Static** from the list.
 - b. Enter the required network information, and then tap **Apply**.
7. Tap **Save**.

How to Connect to Virtual Private Networks

The computer supports connecting to virtual private networks (VPNs). This section describes how to add and connect to VPNs. To configure VPN access, you must obtain details from your network administrator. You can view and change VPN settings in the Settings app.

Note: Before you can add or connect to a VPN network, you must enable a screen lock method.

Add a VPN

Before you can connect to a VPN, you must create a VPN profile.

1. Swipe up from the bottom of the Home screen to access all apps.
2. Tap **Settings**  > **Network & Internet** > **VPN**.
3. Tap **+** to add a VPN new profile.
4. Enter the required information for the VPN connection. If needed, swipe up on the screen to access all the required information fields.
5. Tap **Save**. The VPN name appears in the VPN list.

Connect to a VPN



Once a VPN profile is created, you can connect to the VPN at any time.

1. Swipe up from the bottom of the Home screen to access all apps.
2. Tap **Settings**  > **Network & Internet** > **VPN**.
3. Type the name of the VPN in the list.
4. Enter any necessary credentials when prompted.

5. Tap **Connect**. A  appears in the status bar and a notification is received. To disconnect from the VPN, tap the notification.

Edit VPN Information

Editing an existing VPN profile can be done from the VPN screen.

1. Swipe up from the bottom of the Home screen to access all apps.
2. Tap **Settings**  > **Network & Internet** > **VPN**.
3. Tap and hold the name of the VPN in the list.
4. Tap  to the right of the VPN profile you want to edit.
5. Edit the VPN settings as necessary.
6. When you are done, tap **Save**.

About Wireless Security

The computer provides these security solutions for your wireless network:

- Wi-Fi Protected Access 2 (WPA2™)
- Wi-Fi Protected Access (WPA)
- 802.1x

Honeywell recommends WPA2 security with PSK (Personal) or 802.1x (Enterprise) key management.

Before you set security, you need to enable the radio, set the date, and set the SSID on your computer. To use 802.1x security, you need to load a root certificate on your computer. To use transport layer security (TLS) with 802.1x security, you also need to load a user certificate.

Use the Settings app to access and configure all wireless security settings.

About Certificates

You can use digital certificates to identify the computer for network access or authentication to servers. To use a certificate to identify your device, you must install it in the trusted credential storage on the computer.

Android supports DER-encoded X.509 certificates saved in files with a .crt or .cer file extension. To install a valid certificate with a .der or other extension, you must change the extension to .crt or .cer to install it.

Android also supports X.509 certificates saved in PKCS#12 key store files with a .p12 or .pfx extension. To install a valid key store file with another extension, you must change the extension to .p12 or .pfx to install it. When you install a certificate from a PKCS#12 key store, Android also installs any accompanying private key or certificate authority certificates.

Load a Certificate

To use a certificate, you must install it in the trusted credential storage on the computer.

Note: Apps such as email and browsers that support certificates allow you to install certificates directly from within the app. For more information, see the help that comes with the app.

1. Copy the certificate or key store from your PC to the mobile computer.
2. Swipe up from the bottom of the Home screen to access all apps.
3. Tap **Settings**  > **Security & location** > **Encryption & credentials**.
4. Tap **Install from storage**. Navigate to the location where you saved the certificate or key store.
5. Tap the certificate or key store to install it. If prompted, enter the key store password. Tap **OK**.
6. Type the name of the certificate.
7. Select **VPN and apps** or **Wi-Fi**.
8. Enter a name for the certificate and tap **OK**.

Disable or Remove Certificates

If a user or system certificate is compromised, or your organization chooses not to trust it, you can disable or remove the certificate.

1. Swipe up from the bottom of the Home screen to access all apps.
2. Tap **Settings**  > **Security & location** > **Encryption & credentials**.
3. Select **Trusted credentials**.

The trusted credentials screen has two tabs:

- **System** shows Certificate Authorities (CA) certificates permanently installed on the computer. They can only be disabled.
 - **User** shows CA certificates you have installed yourself. You can remove these certificates.
4. Tap the name of the certificate to you want to disable or remove. The Security certificate screen appears.

5. Scroll to the bottom of the screen and tap **Disable** (for System certificates) or **Remove** (for User certificates).
6. Tap **OK**.



Note: You can enable a disabled System certificate but if you remove a User certificate, you must install it again to enable it.

About Bluetooth Communications

Your mobile computer is equipped to communicate with other devices using Bluetooth technology. The Bluetooth radio must be turned On to discover, pair and connect to other Bluetooth devices. System bar icons indicate Bluetooth radio status.

Connect a Bluetooth Device

To connect to a Bluetooth device, you must turn On the Bluetooth radio and then select the device from a list of discovered devices.

1. Swipe up from the bottom of the Home screen to access all apps.
2. Tap **Settings**  > **Connected devices** > **Bluetooth**.
3. If necessary, tap **Off**  to toggle the Bluetooth radio **On** .
4. Tap **Bluetooth**.
5. Tap **Pair new device**.
A list of available Bluetooth devices in range appears.
6. Select a device on the list to initiate a pairing request.
7. When the pairing request message appears:
 - Verify the pairing PIN is the same on both device, and then tap **Pair**.

OR

- If the pairing request requires a PIN, enter the **PIN**, and then tap **Pair**.

When the device is successfully paired with the computer, the device name appears under Paired devices.

8. (Optional) Once paired to a device, you can connect manually to the device. Tap the device under Paired devices. The word “Connected” appears under the paired device name.

The status icon changes from  to .

- To disconnect a paired device, tap the name of the paired device and then tap **OK** when the “Disconnect?” screen appears.



Rename the Computer and View File History

You can change the name of the computer to make it easier to identify when pairing with other Bluetooth enabled devices and view statistics about received files.

1. Swipe up from the bottom of the Home screen to access all apps.
2. Tap **Settings**  > **Connected devices** > **Bluetooth**.
3. Tap **Device Name**. Type the new name and then select **Rename**.

Rename, Share or Unpair a Paired Device

You can rename a paired device to make it easier to identify it on the list or unpair the device to remove it from the paired list.

1. Swipe up from the bottom of the Home screen to access all apps.
2. Tap **Settings**  > **Connected devices** > **Bluetooth**.
3. Tap  next to the paired device.
4. Take one of the following actions:
 - To rename the device, type the new name, and then tap **OK**.
 - To allow **Internet connection sharing** or **Contact Sharing**, tap the check box next to the setting.
 - To unpair the device, tap **Forget**.

About Serial and USB Communications

You can use these optional CK65 accessories to transmit data to and receive data from another device through serial or USB communications:

- Vehicle dock
- Home Base
- Ethernet Home Base

USB Troubleshooting

- If you have a problem with your workstation computer recognizing the USB device, try downloading and installing the Honeywell-aidc-usb-driver. The driver is part of the Honeywell_Mobility SDK_Android software.zip file. To learn where to get the software, see [Developer Information](#) on page 62.
- Check to make sure you have enabled the USB for file transfer. To learn more, see [Configure USB Connection and Transfer Files](#) on page 21

About Near Field Communication (NFC)

NFC technology provides the ability for short-range, wireless data transfer between the CK65 and NFC tags or other NFC enabled devices placed in close proximity to the back of the computer. All CK65 mobile computers support the following modes of operation:

- NFC tag reader/writer mode: The computer reads and/or writes digital information from or to an NFC tag.
- Peer-to-Peer (P2P) mode: The computer uses Android Beam and/or Bluetooth technology to transfer screen content (e.g., a picture, contact information, Web page url, or file) between NFC enabled devices.
- NFC card emulation mode: The computer emulates an NFC card (smart card) that an external card reader can access. You can download and install apps for card emulation mode from the Google Play Store. Some examples include digital wallets (e-wallets) offered by your bank or credit card company and Google Pay.

The app you install determines the type of emulation mode used: Card Emulation with a Secure Element or Host-based Card Emulation. Secure element use is common for financial transactions that require a high level of security in order to provide a secure memory and execution environment for running custom smart card applets and storing your personal information (e.g., account information and credentials).

Note: *When using a Universal Integrated Circuit (UICC) card for NFC Secure Element NFC link encryption, install the card in SIM slot 1.*

Developer Information

To download the Honeywell Mobility SDK for Android and EZConfig for Mobility:

1. Go to www.honeywellaidc.com.
2. Select **Get Resources > Software**.
3. Click on the *Technical Support Downloads Portal* link, <https://hsmftp.honeywell.com>.
4. Create an account if you have not already created one. You must login to download the software.
5. Install the *Honeywell Download Manager* tool on your workstation (e.g., laptop or desktop computer) prior to trying to download any files.

6. Navigate to the software:
 - *Honeywell Mobility SDK for Android*
Click on **Software** > **Software and Tools** > **Developer Library** > **SDKs for Android**.
 - *EZConfig for Mobility*
Click on **Software** > **Software and Tools** > **EZConfig for Mobility**.
7. Select **Download** next to the software zip file.

About Provisioning Mode

Once you complete the out-of-box initial setup process, Provisioning mode is automatically turned Off to improve device security against unwanted modifications to the system.

When Provisioning mode is turned Off (disabled):

- Configuration bar codes do not scan and process.
- \honeywell\autoinstall folders are inaccessible.

Note: To learn more about network and security for Honeywell mobile computers with Android operating systems, go to www.honeywellaidc.com.

Enable or Disable Provisioning Mode

1. Swipe up from the bottom of the Home screen to access all apps.
2. Tap **Settings**  > **Honeywell Settings** > **Provisioning mode**.
3. Tap the button to toggle the provisioning **On** or **Off**.

MANAGE AND MAINTAIN THE COMPUTER

Use this chapter to understand how to upgrade software, reset, and maintain the computer.

About Software Updates

Honeywell provides patches and security updates for existing software products at no additional charge. Software upgrades (from one major version to another) may involve additional charges. Some licensed software that Honeywell distributes requires user registration and log in before the software can be downloaded.

Support for Honeywell Safety and Productivity Solutions products is available online through the [Technical Support Portal](#).

Software downloads can be accessed through the [Technical Support Downloads Portal](#).



1. Go to www.honeywellaidc.com.
2. Select **Get Resources** > **Software**.
3. Click on the *Technical Support Downloads Portal* link, <https://hsmftp.honeywell.com>.
4. Create an account if you have not already created one. You must login to download the software.
5. Install the *Honeywell Download Manager* tool on your workstation (e.g., laptop or desktop computer) prior to trying to download any files.
6. Locate the app or upgrade you want to download in the Software directory tree.
7. Select **Download**. Follow the prompts to download the file.

About Transferring Files via USB Connection

If you plan on using a USB connection to transfer the upgrade files to the mobile computer, make sure you set the USB connection to allow file transfers. To learn more, see [Configure USB Connection and Transfer Files](#) on page 21.

Install Software with AutoInstall

Important: *The CK65 must have power for the entire length of the install process or it could become unstable. Do not attempt to remove the battery during the process.*

1. Swipe up from the bottom of the Home screen to access all apps.
2. Tap **Settings**  > **Honeywell Settings** > **Provisioning mode**.
3. Tap the toggle button to turn Provisioning mode **On**.
4. Save the upgrade file (*.zip or *.apk) in one of the following folders on the CK65 mobile computer:
 - **Internal shared storage\honeywell\autoinstall**
Software upgrades saved to this folder for installation, do not persist when a Erase all data (factory reset) or Enterprise data reset is performed.
 - **IPSM card\honeywell\autoinstall**
Software upgrades saved to this folder, do not persist when an Erase all data (factory reset) is performed. However, the upgrade does persist if an Enterprise data reset is performed.
5. Swipe up from the bottom of the Home screen to access all apps.
6. Tap **AutoInstall Settings**  and verify **AutoInstall** is enabled .
7. Tap **Packages Update** from the AutoInstall Settings screen.



The computer automatically initiates a reboot and installs the software upgrade. The system update screen appears during the upgrade process. When the update is finished, the lock screen appears.
8. Once installation is complete, turn Provisioning mode **Off**.

Note: *Some updates do not require the computer to reboot before installation.*

Optional microSD Card Method

The CK65 comes equipped with a microSD card socket. You can install an upgrade from a microSD card you insert in the computer.

Important: *The CK65 must have power for the entire length of the install process or it could become unstable. Do not attempt to remove the battery during the process.*

1. On the CK65, swipe up from the bottom of the Home screen to access all apps.
2. Tap **Settings**  > **Honeywell Settings** > **Provisioning mode**.
3. Tap the toggle button to turn Provisioning mode **On**.
4. Tap **AutoInstall Settings** . Verify **AutoInstall** is enabled .
5. Press and hold the **Power** button, and then tap **Power off**.

6. On your workstation (e.g., laptop, desktop computer), format the microSD card and create a **\honeywell\autoinstall** folder on the root of the card.
7. Save the upgrade file (*.zip or *.apk) file in the **autoinstall** folder.
8. Install the microSD card in the CK65, and then turn on the computer.

The computer automatically runs the upgrade found in the autoinstall folder on the card. The system update screen appears during the upgrade process. When the upgrade is finished, the lock screen appears.

9. Once installation is complete, turn Provisioning mode **Off**.

About the Honeywell Upgrader

Use the Honeywell Upgrader app (HUpgrader) to check for and install OTA updates or view the current OTA version installed on the computer.

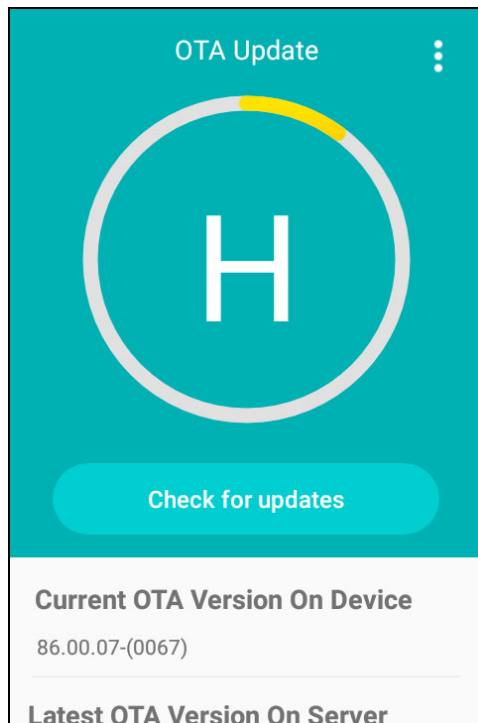

View the Installed OTA Version

1. Swipe up from the bottom of the Home screen to access all apps.
2. Tap **HUpgrader**  to open the Honeywell Updater app. The OTA version number installed on the computer appears on the screen.



Install OTA Updates

To use the HUpgrader to install an OTA update file downloaded from the [Technical Support Downloads Portal](#):

1. Swipe up from the bottom of the Home screen to access all apps.
2. Tap **Settings**  > **Honeywell Settings** > **Provisioning mode**.
3. Tap the toggle button to turn Provisioning mode **On**.
4. Save the OTA file (*.zip) in the following folder on the CK65 computer:
 - **Internal shared storage\Download**
5. Tap **HUpgrader**  to open the Honeywell Updater app.
6. Tap  in the upper right corner, and then tap **Select OTA from storage**.
7. Select the storage location (i.e., Internal Storage) where you saved the file.
8. Tap the OTA update file. The computer examines the file, and then starts the installation.

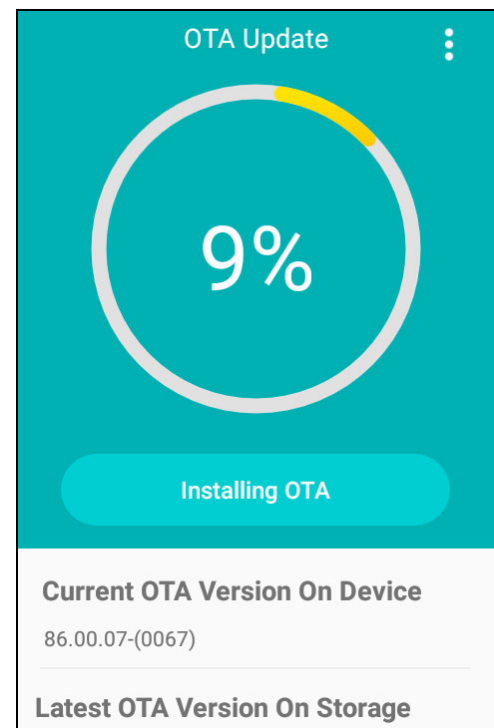
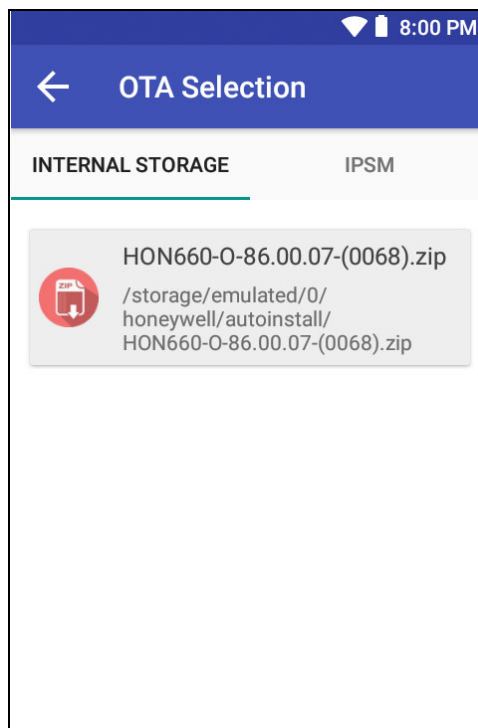

9. Once the installation is complete (100%), select **OK** when prompted to **Reboot** the computer. The computer reboots and finishes the update.

Reboot (Restart) the Computer

You may need to reboot the computer to correct conditions where an application stops responding to the system.

1. Save your files and close any open applications.
2. Press and hold the **Power** button until the options screen appears.
3. Tap **Reboot**. The computer reboots.

If the touch panel display is unresponsive:

- Press and hold the **Power** button for approximately 8 seconds until the computer reboots.

About Enterprise Data Reset

You can perform an Enterprise data reset if the methods below did not improve the computer condition and all other troubleshooting methods have failed to resolve the issue.

- Reboot
- Reset app preferences (**Settings > System > Reset options**)
- Reset Wi-Fi, Mobile & Bluetooth (**Settings > System > Reset options**)

An Enterprise data reset provides a clean configuration for troubleshooting by erasing all data from the **Internal shared storage** location on the computer. Data is not erased from the IPSM Card location.



Caution: An Enterprise data reset results in data loss, only perform this procedure if all other recovery methods have failed. All personal content is erased including, but not limited to emails, pictures, contacts, Google account information, system settings and app settings.



Note: *This method of recovery may not be available if your system administrator has set policies to prevent the reset use.*

Before You Begin

- If you recently reset your Google Account password, wait 24 hours before performing a Enterprise data reset.
- Make sure you have your screen lock password, PIN or pattern if you activated one. You will need this to reset the computer.
- If you have a Google Account, back up your data and settings to your Google Account so you can restore them if needed.

- Connect the computer to an external power source or make sure you have a full battery charge.
- Make sure you have an Internet connection.

Enterprise Data Reset the Computer

1. Swipe up from the bottom of the Home screen to access all apps.
2. Select **Settings**  > **System** > **Reset options**.
3. Tap **Enterprise data reset**.
4. Tap **Reset Phone**.
5. If prompted, type your screen lock security pattern, PIN, or password and tap next ().
6. Tap **Erase Everything**. A message appears informing you an Enterprise data reset is being performed.

About Erase All Data (Factory Reset)

A full Factory Reset should only be performed if you have exhausted all other troubleshooting options including an Enterprise data reset. This method reverts the computer back to the factory state by erasing all data in **Internal shared storage** and the **IPSM Card** storage locations on the computer.



Caution: A full Factory Reset results in data loss. Perform this procedure only if all other recovery methods have failed and have no other option. All personal content is erased including, but not limited to emails, pictures, contacts, Google account information, system settings and app settings.



Note: *This method of recovery may not be available if your system administrator has set policies to prevent the reset use.*

Before You Begin

- If you added a Google Account to the 75 Series computer, make sure you have your Google username and password associated with the computer. If you do not have the username and password, you will not be able to use the computer after the reset. This is a security measure that prevents unauthorized users from using the device if they try a Full factory reset.
- If you did not add a Google Account to the computer, the extra security level is not enabled and you will not need a Google username and password.
- If you recently reset your Google Account password, wait 24 hours before performing a Full factory reset.

- Connect the computer to an external power source or make sure you have a full battery charge.
- Make sure you have an Internet connection.

Erase All Data (Factory Reset)

1. Swipe up from the bottom of the Home screen to access all apps.
2. Select **Settings**  > **System** > **Reset options**.
3. Tap **Erase all data (factory reset)**.
4. Tap **Reset Phone**.
5. If prompted, type your screen lock security pattern, PIN, or password and tap next ().
6. Tap **Erase Everything**. A message appears informing you an Full factory reset is being performed.

Clean the Computer

To keep the computer in good working order, you may need to clean the scanner window, color camera window, and the touch screen. Clean the windows and the touch screen as often as needed for the environment in which you are using the computer. The computer withstands application of the following cleaning agents when applied to a clean soft cloth and removed immediately with a dry soft cloth:

- Acetic acid, 10% in water
- Ethyl alcohol, 10% in water
- Mild soap solutions

Note: *Always leave the battery installed when you clean the computer.*

1. Press the **Power** button to suspend the computer.
2. Dip a clean cloth towel in the cleaning agent and wring out the excess.
3. Wipe off the scanner window, camera lens, and flash area. Do not allow any abrasive material to touch these surfaces.
4. Wipe dry.
5. Let the computer completely air dry before using again.



Caution: **Ensure all components are dry prior to mating the computer terminals and batteries with peripheral devices. Mating wet components may cause damage not covered by the warranty.**

Computer Agency Information

CK65 mobile computers meet or exceed the requirements of all applicable standards organizations for safe operation. The best way to ensure safe operation is to use the mobile computer according to the agency guidelines on the product regulatory sheet, quick start guide, battery insert and in this user guide. Read all guidelines before using your computer.

Product documentation is available for download from www.honeywellaidc.com.

Public certificates are available for download from www.honeywellaidc.com/compliance.

Label Locations

Labels inside the battery compartment contain information about the computer including, compliance information, model number, serial number and MAC address. Laser safety labeling is located on the back of the computer.

Product Identification Numbers
(e.g., Serial Number, MAC address or IMEI)

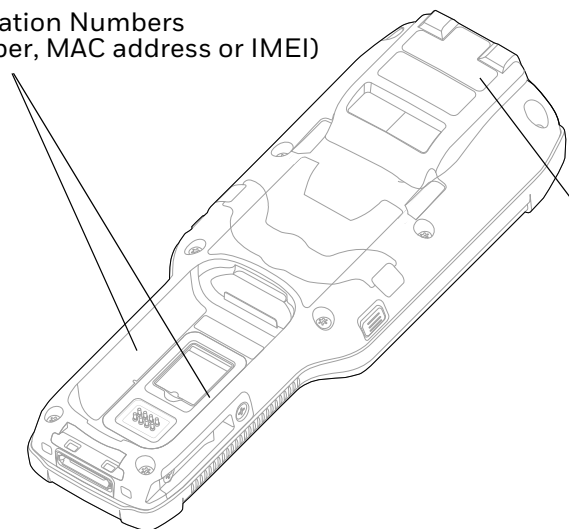

Laser Safety Label
Location

Physical and Environmental Specifications

1. Go to www.honeywellaidc.com.
2. Type CK65 in the Search box and then press **Enter**.
3. Select the **Products** tab.
4. Click the red arrow under the *CK65 Handheld Computer* description.
5. Select one of the following:
 - **Specifications**
View System Architecture, Wireless Connectivity, Mechanical, and Environmental specifications.
 - **Documents**
Download the Data Sheet, Accessory Guide, Quick Start Guide, User Guide, Regulatory Information, Battery Information and other product documentation.

Bar Code Symbolologies Supported

The computer supports the following bar code symbolologies:

1D Symbolologies		2D Symbolologies		Postal Codes	
	Default		Default		Default
Codabar	Enabled	Aztec Code	Enabled	Australian Post	Disabled
Code 39	Enabled	Codablock A	Disabled	British Post	Disabled
Code 32	Disabled	Codablock F	Disabled	Canadian Post	Disabled
Code 11	Disabled	DataMatrix	Enabled	China Post	Disabled
Code 93	Disabled	DotCode	Disabled	InfoMail	Disabled
Code 128	Enabled	Grid Matrix	Disabled	Japanese Post	Disabled
Composite	Disabled	HanXin	Disabled	Korean Post	Disabled
Digimarc Barcode	Disabled	Maxicode	Disabled	Netherlands (KIX) Post	Disabled
EAN-8	Enabled	PDF 417	Enabled	2D Postal Settings	Disabled
EAN-13	Enabled	QR Code	Disabled	Planet Code	Disabled
GS1-128	Enabled	TLC 39	Disabled	Postnet	Disabled
GS1 DataBar	Disabled	OCR-A	Disabled		
IATA 2 of 5	Disabled	OCR-B	Disabled		
Standard 2 of 5	Disabled				
Interleaved 2 of 5	Enabled				
ISBT 128	Disabled				
Matrix 2 of 5	Disabled				
MSI	Disabled				
Telepen	Disabled				

1D Symbologies		2D Symbologies		Postal Codes	
	Default		Default		Default
Trioptic Code	Disabled				
UPC-A	Enabled				
UPC-E	Enabled				
UPC-E1	Disabled				

Note: To learn about changing the symbology settings, see [Change the Scanner Settings](#) on page 34.

N6703SR Imager Engine Reading Distances

The depth of field measurements were taken using these parameters:

- Distances are measured from the front of the engine.
- +23 °C (+73 °F), 0 lux
- Photographic quality codes

Note: Time to Read and Depth of Field are impacted if the bar code symbol is at the edge of the image.

Symbology		Near Distance	Far Distance
5 mil Code 39	mm	79	270
	in.	3.11	10.63
10 mil Code 39	mm	40	450
	in.	1.34	17.72
20 mil Code 39	mm	44	674
	in.	1.50	26.53
13 mil 100% UPC-A	mm	44	515
	in.	1.50	20.27
15 mil Code 128	mm	42	572
	in.	1.42	22.52
10 mil Data Matrix	mm	83	236
	in.	3.27	9.29
5 mil PDF417	mm	119	177
	in.	4.68	6.97
6.7 mil PDF417	mm	96	236
	in.	3.78	9.29
6.7 mil QR	mm	123	147
	in.	4.84	5.79

Symbology		Near Distance	Far Distance
15 mil QR	mm	39	390
	in.	1.30	15.35

N6703SR Imager Engine Field of View/Resolution

Focus	
Horizontal Field Angle (degrees)	48
Vertical Field Angle (degrees)	31

Note: DPI can be calculated based on the following formula:
Horizontal DPI = 832 pixels/width of horizontal field of view (inches)
Vertical DPI = 640 pixels/width of vertical field of view (inches)

EX20 Imager Engine Reading Distances

The depth of field measurements were taken using these parameters:

- Distances are measured from the front of the engine.
- +23 °C (+73 °F), 0 lux
- Photographic quality codes

Note: Time to Read and Depth of Field are impacted if the bar code symbol is at the edge of the image.

Symbology		Near Distance	Far Distance
3 mil Code 39	mm	120	740
	in.	4.7	29.1
4 mil Code 39	mm	120	1010
	in.	4.7	39.8
10 mil Code 39	mm	100	2200
	in.	3.9	86.6
20 mil Code 39	mm	200	4160
	in.	7.9	163.8
40 mil Code 39	mm	390	5990
	in.	15.3	235.8
55 mil Code 39	mm	530	6960
	in.	20.9	274
13 mil EAN-UPC	mm	160	2190
	in.	6.3	86.2

EX20 Imager Engine Field of View/Resolution

Focus	
Horizontal Field Angle (degrees)	14.0°
Vertical Field Angle (degrees)	8.7°

Note: *DPI can be calculated based on the following formula:
Horizontal DPI = 832 pixels/width of horizontal field of view (inches)
Vertical DPI = 640 pixels/width of vertical field of view (inches)*

Honeywell
9680 Old Bailes Road
Fort Mill, SC 29707

www.honeywellaidc.com