

## FCC Test Report (WLAN)

**Report No.:** RF171130C26-6

**FCC ID:** HD5-660W

**Test Model:** SOM660W

**Received Date:** Nov. 30, 2017

**Test Date:** Jan. 18 to 20, 2018

**Issued Date:** Jan. 29, 2018

**Applicant:** Honeywell International Inc.

**Address:** 9680 Old Bailes Road, Fort Mill, SC 29707 USA

**Issued By:** Bureau Veritas Consumer Products Services (H.K.) Ltd., Taoyuan Branch  
Hsin Chu Laboratory

**Lab Address:** E-2, No.1, Li Hsin 1st Road, Hsinchu Science Park, Hsinchu City 300,  
Taiwan R.O.C.

**Test Location :** E-2, No.1, Li Hsin 1st Road, Hsinchu Science Park, Hsinchu City 300,  
Taiwan R.O.C.

**FCC Registration /  
Designation Number:** 723255 / TW2022



This report is for your exclusive use. Any copying or replication of this report to or for any other person or entity, or use of our name or trademark, is permitted only with our prior written permission. This report sets forth our findings solely with respect to the test samples identified herein. The results set forth in this report are not indicative or representative of the quality or characteristics of the lot from which a test sample was taken or any similar or identical product unless specifically and expressly noted. Our report includes all of the tests requested by you and the results thereof based upon the information that you provided to us. You have 60 days from date of issuance of this report to notify us of any material error or omission caused by our negligence, provided, however, that such notice shall be in writing and shall specifically address the issue you wish to raise. A failure to raise such issue within the prescribed time shall constitute your unqualified acceptance of the completeness of this report, the tests conducted and the correctness of the report contents. Unless specific mention, the uncertainty of measurement has been explicitly taken into account to declare the compliance or non-compliance to the specification. The report must not be used by the client to claim product certification, approval, or endorsement by TAF or any government agencies.

## Table of Contents

<b>Release Control Record</b> .....	<b>4</b>
<b>1 Certificate of Conformity</b> .....	<b>5</b>
<b>2 Summary of Test Results</b> .....	<b>6</b>
2.1 Measurement Uncertainty .....	6
2.2 Modification Record .....	6
<b>3 General Information</b> .....	<b>7</b>
3.1 General Description of EUT (WLAN) .....	7
3.2 Description of Test Modes .....	10
3.2.1 Test Mode Applicability and Tested Channel Detail .....	12
3.3 Duty Cycle of Test Signal .....	14
3.4 Description of Support Units .....	15
3.4.1 Configuration of System under Test .....	15
3.5 General Description of Applied Standard .....	16
<b>4 Test Types and Results</b> .....	<b>17</b>
4.1 Radiated Emission and Bandedge Measurement .....	17
4.1.1 Limits of Radiated Emission and Bandedge Measurement .....	17
4.1.2 Test Instruments .....	18
4.1.3 Test Procedure .....	19
4.1.4 Deviation from Test Standard .....	19
4.1.5 Test Setup .....	20
4.1.6 EUT Operating Condition .....	21
4.1.7 Test Results .....	22
4.2 Conducted Emission Measurement .....	65
4.2.1 Limits of Conducted Emission Measurement .....	65
4.2.2 Test Instruments .....	65
4.2.3 Test Procedure .....	66
4.2.4 Deviation from Test Standard .....	66
4.2.5 Test Setup .....	66
4.2.6 EUT Operating Condition .....	66
4.2.7 Test Results .....	67
4.3 Transmit Power Measurement .....	69
4.3.1 Limits of Transmit Power Measurement .....	69
4.3.2 Test Setup .....	69
4.3.3 Test Instruments .....	69
4.3.4 Test Procedure .....	70
4.3.5 Deviation from Test Standard .....	70
4.3.6 EUT Operating Condition .....	70
4.3.7 Test Result .....	71
4.4 Occupied Bandwidth Measurement .....	80
4.4.1 Test Setup .....	80
4.4.2 Test Instruments .....	80
4.4.3 Test Procedure .....	80
4.4.4 Test Results .....	81
4.5 Peak Power Spectral Density Measurement .....	86
4.5.1 Limits of Peak Power Spectral Density Measurement .....	86
4.5.2 Test Setup .....	86
4.5.3 Test Instruments .....	86
4.5.4 Test Procedure .....	86
4.5.5 Deviation from Test Standard .....	87
4.5.6 EUT Operating Condition .....	87
4.5.7 Test Results .....	88
4.6 Frequency Stability Measurement .....	95
4.6.1 Limits of Frequency Stability Measurement .....	95

4.6.2	Test Setup.....	95
4.6.3	Test Instruments .....	95
4.6.4	Test Procedure .....	95
4.6.5	Deviation from Test Standard .....	95
4.6.6	EUT Operating Condition .....	95
4.6.7	Test Results .....	96
4.7	6dB Bandwidth Measurement .....	97
4.7.1	Limits of 6dB Bandwidth Measurement.....	97
4.7.2	Test Setup.....	97
4.7.3	Test Instruments .....	97
4.7.4	Test Procedure .....	97
4.7.5	Deviation from Test Standard .....	97
4.7.6	EUT Operating Condition .....	97
4.7.7	Test Results .....	98
<b>5</b>	<b>Pictures of Test Arrangements.....</b>	<b>100</b>
	<b>Annex A- Radiated Out of Band Emission (OOBE) Measurement (For U-NII-3 band) .....</b>	<b>101</b>
	<b>Appendix – Information on the Testing Laboratories .....</b>	<b>105</b>

### Release Control Record

Issue No.	Description	Date Issued
RF171130C26-6	Original release.	Jan. 29, 2018

## 1 Certificate of Conformity

**Product:** HSOM660

**Brand:** Honeywell

**Test Model:** SOM660W

**Sample Status:** ENGINEERING SAMPLE

**Applicant:** Honeywell International Inc.

**Test Date:** Jan. 18 to 20, 2018

**Standard:** 47 CFR FCC Part 15, Subpart E (Section 15.407)  
ANSI C63.10: 2013

The above equipment has been tested by **Bureau Veritas Consumer Products Services (H.K.) Ltd., Taoyuan Branch**, and found compliance with the requirement of the above standards. The test record, data evaluation & Equipment Under Test (EUT) configurations represented herein are true and accurate accounts of the measurements of the sample's EMC characteristics under the conditions specified in this report.

**Prepared by :** Mary Ko , **Date:** Jan. 29, 2018  
Mary Ko / Specialist

**Approved by :** May Chen , **Date:** Jan. 29, 2018  
May Chen / Manager

## 2 Summary of Test Results

47 CFR FCC Part 15, Subpart E (Section 15.407)			
FCC Clause	Test Item	Result	Remarks
15.407(b)(6)	AC Power Conducted Emissions	Pass	Meet the requirement of limit. Minimum passing margin is -10.87dB at 0.16172MHz.
15.407(b)(1/2/3/4(i/ii)/6)	Radiated Emissions & Band Edge Measurement*	Pass	Meet the requirement of limit. Minimum passing margin is -2.4dB at 5150.00MHz, 5350.00MHz, 5470.00MHz.
15.407(a)(1/2/3)	Max Average Transmit Power	Pass	Meet the requirement of limit.
---	Occupied Bandwidth Measurement	-	Reference only.
15.407(a)(1/2/3)	Peak Power Spectral Density	Pass	Meet the requirement of limit.
15.407(e)	6dB bandwidth	Pass	Meet the requirement of limit. (U-NII-3 Band only)
15.407(g)	Frequency Stability	Pass	Meet the requirement of limit.
15.203	Antenna Requirement	PASS	Antenna connector is PIFA not a standard connector.

\*For U-NII-3 band compliance with rule part 15.407(b)(4)(i), the OOB test plots were recorded in Annex A.

### 2.1 Measurement Uncertainty

Where relevant, the following measurement uncertainty levels have been estimated for tests performed on the EUT as specified in CISPR 16-4-2:

Measurement	Frequency	Expanded Uncertainty (k=2) (±)
Conducted Emissions at mains ports	150kHz ~ 30MHz	1.84 dB
Radiated Emissions up to 1 GHz	30MHz ~ 1GHz	5.33 dB
Radiated Emissions above 1 GHz	1GHz ~ 6GHz	5.10 dB
	6GHz ~ 18GHz	4.85 dB
	18GHz ~ 40GHz	5.24 dB

### 2.2 Modification Record

There were no modifications required for compliance.

### 3 General Information

#### 3.1 General Description of EUT (WLAN)

Product	HSOM660
Brand	Honeywell
Test Model	SOM660W
Status of EUT	ENGINEERING SAMPLE
HW Version	V2.0
HW P/N	22
SW Version	HON.01.004
SW P/N	351D
Power Supply Rating	3.85Vdc
Modulation Type	CCK, DQPSK, DBPSK for DSSS 64QAM, 16QAM, QPSK, BPSK for OFDM 256QAM for OFDM in 11ac mode only
Modulation Technology	DSSS, OFDM
Transfer Rate	802.11b: up to 11Mbps 802.11a/g: up to 54Mbps 802.11n: up to 300Mbps 802.11ac: up to 866.7Mbps
Operating Frequency	<b>2.4GHz:</b> 2.412 ~ 2.462GHz <b>5GHz:</b> 5.18 ~ 5.24GHz, 5.26 ~ 5.32GHz, 5.50 ~ 5.72GHz, 5.745 ~ 5.825GHz
Number of Channel	<b>2.4GHz:</b> 802.11b, 802.11g, 802.11n (HT20): 11 <b>5GHz:</b> 802.11a, 802.11n (HT20), 802.11ac (VHT20): 25 802.11n (HT40), 802.11ac (VHT40): 12 802.11ac (VHT80): 6
Output Power	<b>2.4GHz:</b> 403.711mW <b>5GHz:</b> <b>5.18 ~ 5.24GHz:</b> 65.906mW <b>5.26 ~ 5.32GHz:</b> 66.125mW <b>5.50 ~ 5.72GHz:</b> 85.088mW <b>5.745 ~ 5.825GHz:</b> 84.701mW
Antenna Type	Refer to Note
Antenna Connector	Refer to Note
Accessory Device	NA
Data Cable Supplied	NA

Note:

1. There are WWAN, WLAN and Bluetooth technology used for the EUT.

## 2. Simultaneously transmission condition.

Condition	Technology	
1	WLAN 2.4GHz	WWAN
2	WLAN 5GHz	WWAN
3	Bluetooth	WWAN

**Note:** The emission of the simultaneous operation has been evaluated and no non-compliance was found.

## 3. The antennas provided to the EUT, please refer to the following table:

WLAN Antenna Spec.							
Chain No.	Brand	Model	Antenna Gain include trace loss and cable loss (dBi)	Frequency range (GHz)	Antenna type	Connector type	Trace loss and cable loss (dB)
Chain 0	USI	SOM-WLAN0	-0.38	2.4~2.4835	PIFA	POGO pin	2
			0.46	5.15~5.25			3.7
			0.46	5.25~5.35			
			0.46	5.47~5.725			
			0.46	5.725~5.85			
Chain 1	USI	SOM-WLAN1	3.2	2.4~2.4835	PIFA	POGO pin	1
			3.8	5.15~5.25			1.9
			3.8	5.25~5.35			
			3.8	5.47~5.725			
			3.8	5.725~5.85			
WWAN Antenna Spec.							
Chain No.	Brand	Model	Antenna Gain include trace loss (dBi)	Frequency range	Antenna type	Connector type	Trace loss (dB)
Chain 0	USI	SOM-WAN main	1.23	700~960 MHz	PIFA	POGO pin	0.7
			3.08	1.70~2.0 GHz			1
			5.28	2.1~2.4 GHz			1.3
			2.66	2.4~2.7 GHz			1.4
Chain 1	USI	SOM-WAN Aux	2.15	700~960 MHz	PIFA	POGO pin	0.7
			3.13	1.70~2.0 GHz			1
			1.78	2.1~2.4 GHz			1.3
			3.01	2.4~2.7 GHz			1.4
Bluetooth Antenna Spec.							
Brand	Model	Antenna Gain include trace loss and cable loss (dBi)	Frequency range (GHz)	Antenna type	Connector type	Trace loss and cable loss (dB)	
USI	SOM-WLAN0	-0.38	2.4~2.4835	PIFA	POGO pin	2	
		0.46	5.15~5.25			3.7	
		0.46	5.25~5.35				
		0.46	5.47~5.725				
		0.46	5.725~5.85				



4. The EUT incorporates a MIMO function.

<b>2.4GHz Band</b>			
<b>MODULATION MODE</b>	<b>DATA RATE (MCS)</b>	<b>TX &amp; RX CONFIGURATION</b>	
<b>802.11b</b>	1 ~ 11Mbps	2TX	2RX
<b>802.11g</b>	6 ~ 54Mbps	2TX	2RX
<b>802.11n (HT20)</b>	MCS 0~7	2TX	2RX
	MCS 8~15	2TX	2RX
<b>5GHz Band</b>			
<b>MODULATION MODE</b>	<b>DATA RATE (MCS)</b>	<b>TX &amp; RX CONFIGURATION</b>	
<b>802.11a</b>	6 ~ 54Mbps	2TX	2RX
<b>802.11n (HT20)</b>	MCS 0~7	2TX	2RX
	MCS 8~15	2TX	2RX
<b>802.11n (HT40)</b>	MCS 0~7	2TX	2RX
	MCS 8~15	2TX	2RX
<b>802.11ac (VHT20)</b>	MCS0~8 Nss=1	2TX	2RX
	MCS0~8 Nss=2	2TX	2RX
<b>802.11ac (VHT40)</b>	MCS0~9 Nss=1	2TX	2RX
	MCS0~9 Nss=2	2TX	2RX
<b>802.11ac (VHT80)</b>	MCS0~9 Nss=1	2TX	2RX
	MCS0~9 Nss=2	2TX	2RX

5. The above EUT information is declared by manufacturer and for more detailed features description, please refer to the manufacturer's specifications or user's manual.

### 3.2 Description of Test Modes

#### FOR 5180 ~ 5240MHz

4 channels are provided for 802.11a, 802.11n (HT20), 802.11ac (VHT20):

Channel	Frequency	Channel	Frequency
36	5180 MHz	44	5220 MHz
40	5200 MHz	48	5240 MHz

2 channels are provided for 802.11n (HT40), 802.11ac (VHT40):

Channel	Frequency	Channel	Frequency
38	5190 MHz	46	5230 MHz

1 channel is provided for 802.11ac (VHT80):

Channel	Frequency
42	5210 MHz

#### FOR 5260 ~ 5320MHz

4 channels are provided for 802.11a, 802.11n (HT20), 802.11ac (VHT20):

Channel	Frequency	Channel	Frequency
52	5260 MHz	60	5300 MHz
56	5280 MHz	64	5320 MHz

2 channels are provided for 802.11n (HT40), 802.11ac (VHT40):

Channel	Frequency	Channel	Frequency
54	5270 MHz	62	5310 MHz

1 channel is provided for 802.11ac (VHT80):

Channel	Frequency
58	5290 MHz

### FOR 5500 ~ 5720MHz

12 channels are provided for 802.11a, 802.11n (HT20), 802.11ac (VHT20):

Channel	Frequency	Channel	Frequency
100	5500 MHz	124	5620 MHz
104	5520 MHz	128	5640 MHz
108	5540 MHz	132	5660 MHz
112	5560 MHz	136	5680 MHz
116	5580 MHz	140	5700 MHz
120	5600 MHz	144	5720 MHz

6 channels are provided for 802.11n (HT40), 802.11ac (VHT40):

Channel	Frequency	Channel	Frequency
102	5510 MHz	126	5630 MHz
110	5550 MHz	134	5670 MHz
118	5590 MHz	142	5710 MHz

3 channels are provided for 802.11ac (VHT80):

Channel	Frequency	Channel	Frequency
106	5530 MHz	138	5690 MHz
122	5610 MHz		

### FOR 5745 ~ 5825MHz:

5 channels are provided for 802.11a, 802.11n (HT20), 802.11ac (VHT20):

Channel	Frequency	Channel	Frequency
149	5745 MHz	161	5805 MHz
153	5765 MHz	165	5825 MHz
157	5785 MHz		

2 channels are provided for 802.11n (HT40), 802.11ac (VHT40):

Channel	Frequency	Channel	Frequency
151	5755 MHz	159	5795 MHz

1 channel is provided for 802.11ac (VHT80):

Channel	Frequency
155	5775 MHz

### 3.2.1 Test Mode Applicability and Tested Channel Detail

EUT Configure Mode	Applicable To				Description
	RE $\geq$ 1G	RE $<$ 1G	PLC	APCM	
-	√	√	√	√	-

Where **RE $\geq$ 1G**: Radiated Emission above 1GHz

**RE $<$ 1G**: Radiated Emission below 1GHz

**PLC**: Power Line Conducted Emission

**APCM**: Antenna Port Conducted Measurement

**NOTE**: The EUT had been pre-tested on the positioned of each 3 axis. The worst case was found when positioned on **X-plane**.

#### **Radiated Emission Test (Above 1GHz):**

- Pre-Scan has been conducted to determine the worst-case mode from all possible combinations between available modulations, data rates and antenna ports (if EUT with antenna diversity architecture).
- Following channel(s) was (were) selected for the final test as listed below.

Mode	FREQ. Band (MHz)	Available Channel	Tested Channel	Modulation Technology	Modulation Type	Data Rate (Mbps)
802.11a	5180-5240	36 to 48	36, 40, 48	OFDM	BPSK	6
802.11ac (VHT20)		36 to 48	36, 40, 48	OFDM	BPSK	6.5
802.11ac (VHT40)		38 to 46	38, 46	OFDM	BPSK	13.5
802.11ac (VHT80)		42	42	OFDM	BPSK	29.3
802.11a	5260-5320	52 to 64	52, 60, 64	OFDM	BPSK	6
802.11ac (VHT20)		52 to 64	52, 60, 64	OFDM	BPSK	6.5
802.11ac (VHT40)		54 to 62	54, 62	OFDM	BPSK	13.5
802.11ac (VHT80)		58	58	OFDM	BPSK	29.3
802.11a	5500-5720	100 to 144	100, 116, 140, 144	OFDM	BPSK	6
802.11ac (VHT20)		100 to 144	100, 116, 140, 144	OFDM	BPSK	6.5
802.11ac (VHT40)		102 to 142	102, 110, 134, 142	OFDM	BPSK	13.5
802.11ac (VHT80)		106 to 138	106, 122, 138	OFDM	BPSK	29.3
802.11a	5745-5825	149 to 165	149, 157, 165	OFDM	BPSK	6
802.11ac (VHT20)		149 to 165	149, 157, 165	OFDM	BPSK	6.5
802.11ac (VHT40)		151 to 159	151, 159	OFDM	BPSK	13.5
802.11ac (VHT80)		155	155	OFDM	BPSK	29.3

#### **Radiated Emission Test (Below 1GHz):**

- Pre-Scan has been conducted to determine the worst-case mode from all possible combinations between available modulations, data rates and antenna ports (if EUT with antenna diversity architecture).
- Following channel(s) was (were) selected for the final test as listed below.

Mode	FREQ. Band (MHz)	Available Channel	Tested Channel	Modulation Technology	Modulation Type	Data Rate (Mbps)
802.11ac (VHT40)	5180-5240 5745-5825 5500-5720 5745-5825	38 to 46 54 to 62 102 to 142 151 to 159	134	OFDM	BPSK	13.5

### Power Line Conducted Emission Test:

- Pre-Scan has been conducted to determine the worst-case mode from all possible combinations between available modulations, data rates and antenna ports (if EUT with antenna diversity architecture).
- Following channel(s) was (were) selected for the final test as listed below.

Mode	FREQ. Band (MHz)	Available Channel	Tested Channel	Modulation Technology	Modulation Type	Data Rate (Mbps)
802.11ac (VHT40)	5180-5240	38 to 46	134	OFDM	BPSK	13.5
	5745-5825	54 to 62				
	5500-5720	102 to 142				
	5745-5825	151 to 159				

### Antenna Port Conducted Measurement:

- This item includes all test value of each mode, but only includes spectrum plot of worst value of each mode.
- Pre-Scan has been conducted to determine the worst-case mode from all possible combinations between available modulations, data rates and antenna ports (if EUT with antenna diversity architecture).
- Following channel(s) was (were) selected for the final test as listed below.

Mode	FREQ. Band (MHz)	Available Channel	Tested Channel	Modulation Technology	Modulation Type	Data Rate (Mbps)
802.11a	5180-5240	36 to 48	36, 40, 48	OFDM	BPSK	6
802.11ac (VHT20)		36 to 48	36, 40, 48	OFDM	BPSK	6.5
802.11ac (VHT40)		38 to 46	38, 46	OFDM	BPSK	13.5
802.11ac (VHT80)		42	42	OFDM	BPSK	29.3
802.11a	5260-5320	52 to 64	52, 60, 64	OFDM	BPSK	6
802.11ac (VHT20)		52 to 64	52, 60, 64	OFDM	BPSK	6.5
802.11ac (VHT40)		54 to 62	54, 62	OFDM	BPSK	13.5
802.11ac (VHT80)		58	58	OFDM	BPSK	29.3
802.11a	5500-5720	100 to 144	100, 116, 140, 144	OFDM	BPSK	6
802.11ac (VHT20)		100 to 144	100, 116, 140, 144	OFDM	BPSK	6.5
802.11ac (VHT40)		102 to 142	102, 110, 134, 142	OFDM	BPSK	13.5
802.11ac (VHT80)		106 to 138	106, 122, 138	OFDM	BPSK	29.3
802.11a	5745-5825	149 to 165	149, 157, 165	OFDM	BPSK	6
802.11ac (VHT20)		149 to 165	149, 157, 165	OFDM	BPSK	6.5
802.11ac (VHT40)		151 to 159	151, 159	OFDM	BPSK	13.5
802.11ac (VHT80)		155	155	OFDM	BPSK	29.3

### Test Condition:

Applicable To	ENVIRONMENTAL CONDITIONS	INPUT POWER (System)	TESTED BY
RE $\geq$ 1G	22deg. C, 68%RH	120Vac, 60Hz	Andy Ho
RE $<$ 1G	23deg. C, 70%RH	120Vac, 60Hz	Andy Ho
PLC	25deg. C, 75%RH	120Vac, 60Hz	Andy Ho
APCM	25deg. C, 60%RH	120Vac, 60Hz	Jyunchun Lin

### 3.3 Duty Cycle of Test Signal

If duty cycle of test signal is < 98%, duty factor shall be considered.

**802.11a:** Duty cycle = 2.026 ms/2.145 ms = 0.945, Duty factor =  $10 * \log(1/0.945) = 0.25$

**802.11ac (VHT20):** Duty cycle = 1.897 ms/1.999 ms = 0.949, Duty factor =  $10 * \log(1/0.949) = 0.23$

**802.11ac (VHT40):** Duty cycle = 0.934 ms/1.025 ms = 0.911, Duty factor =  $10 * \log(1/0.911) = 0.4$

**802.11ac (VHT80):** Duty cycle = 0.455 ms/0.555 ms = 0.82, Duty factor =  $10 * \log(1/0.82) = 0.86$

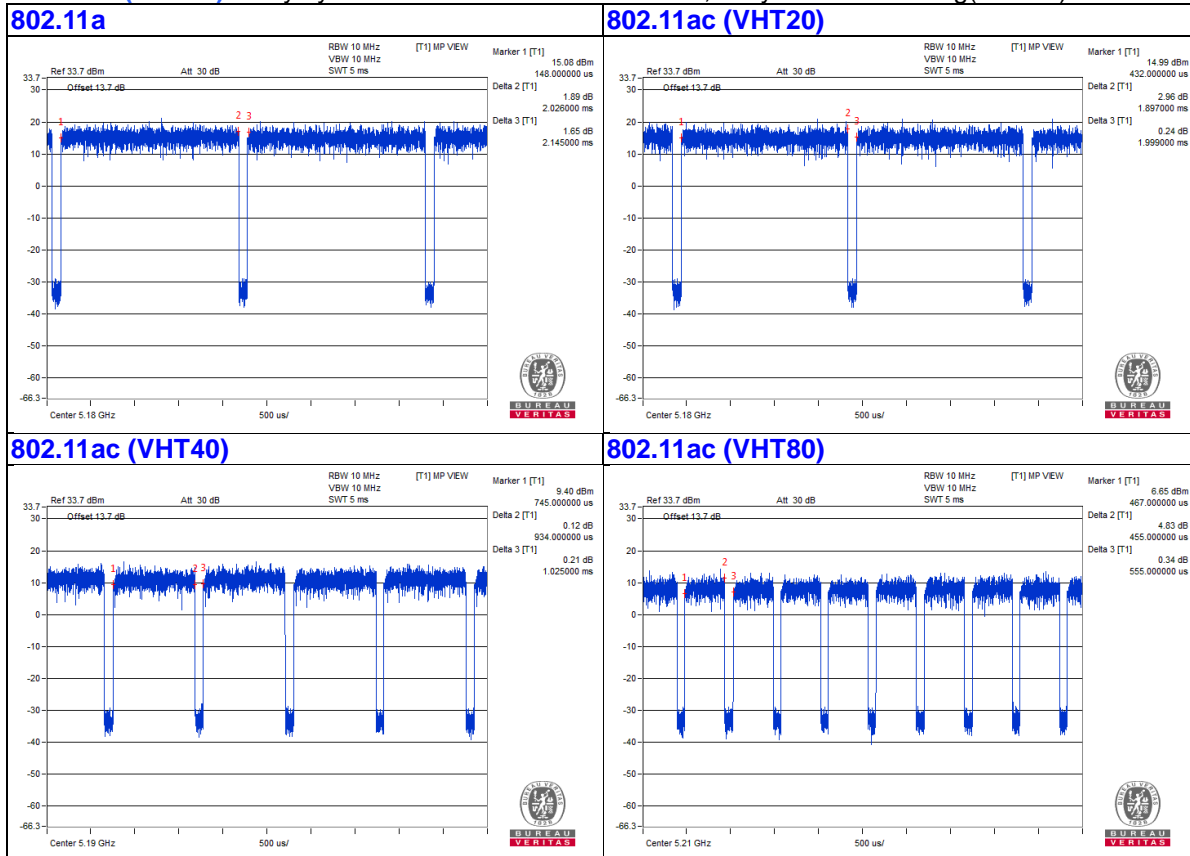

### 3.4 Description of Support Units

The EUT has been tested as an independent unit together with other necessary accessories or support units. The following support units or accessories were used to form a representative test configuration during the tests.

ID	Product	Brand	Model No.	Serial No.	FCC ID	Remarks
A.	Laptop	DELL	P54G	NA	NA	Supplied by client
B.	Test Tool	NA	NA	NA	NA	Supplied by client
C.	Battery	Inventus Power, Inc.	CW-BAT	CX80-BAT-EXT-WRLS1	NA	Supplied by client

Note:

1. All power cords of the above support units are non-shielded (1.8m).

ID	Descriptions	Qty.	Length (m)	Shielding (Yes/No)	Cores (Qty.)	Remarks
1.	USB Cable	1	1	Yes	1	Supplied by client

Note: The core(s) is(are) originally attached to the cable(s).

#### 3.4.1 Configuration of System under Test

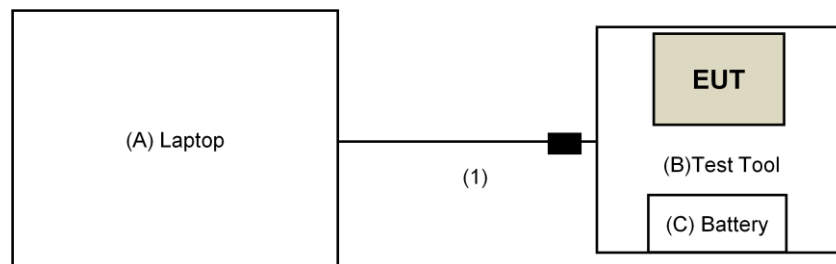

### 3.5 General Description of Applied Standard

The EUT is a RF Product. According to the specifications of the manufacturer, it must comply with the requirements of the following standards:

**FCC Part 15, Subpart E (15.407)**  
**KDB 789033 D02 General UNII Test Procedure New Rules v02r01**  
**KDB 662911 D01 Multiple Transmitter Output v02r01**  
**ANSI C63.10-2013**

All test items have been performed and recorded as per the above standards.

**NOTE:** The EUT has been verified to comply with the requirements of FCC Part 15, Subpart B, Class B (DoC). The test report has been issued separately.



## 4 Test Types and Results

### 4.1 Radiated Emission and Bandedge Measurement

#### 4.1.1 Limits of Radiated Emission and Bandedge Measurement

Radiated emissions which fall in the restricted bands must comply with the radiated emission limits specified as below table.

Frequencies (MHz)	Field Strength (microvolts/meter)	Measurement Distance (meters)
0.009 ~ 0.490	2400/F(kHz)	300
0.490 ~ 1.705	24000/F(kHz)	30
1.705 ~ 30.0	30	30
30 ~ 88	100	3
88 ~ 216	150	3
216 ~ 960	200	3
Above 960	500	3

#### NOTE:

1. The lower limit shall apply at the transition frequencies.
2. Emission level (dBuV/m) = 20 log Emission level (uV/m).
3. For frequencies above 1000MHz, the field strength limits are based on average detector, however, the peak field strength of any emission shall not exceed the maximum permitted average limits, specified above by more than 20dB under any condition of modulation.

Limits of unwanted emission out of the restricted bands

Applicable To		Limit	
789033 D02 General UNII Test Procedure New Rules v02r01		Field Strength at 3m	
		PK:74 (dBuV/m)	AV:54 (dBuV/m)
Frequency Band	Applicable To	EIRP Limit	Equivalent Field Strength at 3m
5150~5250 MHz	15.407(b)(1)	PK:-27 (dBm/MHz)	PK:68.2(dBuV/m)
5250~5350 MHz	15.407(b)(2)		
5470~5725 MHz	15.407(b)(3)		
5725~5850 MHz	<input checked="" type="checkbox"/> 15.407(b)(4)(i)	PK:-27 (dBm/MHz) <sup>*1</sup> PK:10 (dBm/MHz) <sup>*2</sup> PK:15.6 (dBm/MHz) <sup>*3</sup> PK:27 (dBm/MHz) <sup>*4</sup>	PK: 68.2(dBuV/m) <sup>*1</sup> PK:105.2 (dBuV/m) <sup>*2</sup> PK: 110.8(dBuV/m) <sup>*3</sup> PK:122.2 (dBuV/m) <sup>*4</sup>
	<input type="checkbox"/> 15.407(b)(4)(ii)	Emission limits in section 15.247(d)	
<sup>*1</sup> beyond 75 MHz or more above of the band edge.		<sup>*2</sup> below the band edge increasing linearly to 10 dBm/MHz at 25 MHz above.	
<sup>*3</sup> below the band edge increasing linearly to a level of 15.6 dBm/MHz at 5 MHz above.		<sup>*4</sup> from 5 MHz above or below the band edge increasing linearly to a level of 27 dBm/MHz at the band edge.	

#### Note:

The following formula is used to convert the equipment isotropic radiated power (eirp) to field strength:

$$E = \frac{1000000\sqrt{30P}}{3} \mu\text{V/m, where P is the eirp (Watts).}$$

## 4.1.2 Test Instruments

DESCRIPTION & MANUFACTURER	MODEL NO.	SERIAL NO.	CALIBRATED DATE	CALIBRATED UNTIL
Test Receiver Keysight	N9038A	MY54450088	July 08, 2017	July 07, 2018
Loop Antenna <sup>(*)</sup> TESEQ	HLA 6121	45745	May 19, 2017	May 18, 2018
Pre-Amplifier Mini-Circuits	ZFL-1000VH2B	AMP-ZFL-01	Nov. 09, 2017	Nov. 08, 2018
Trilog Broadband Antenna SCHWARZBECK	VULB 9168	9168-406	Nov. 29, 2017	Nov. 28, 2018
RF Cable	8D	966-4-1 966-4-2 966-4-3	Apr. 01, 2017	Mar. 31, 2018
Fixed attenuator Mini-Circuits	UNAT-5+	PAD-3m-4-01	Oct. 03, 2017	Oct. 02, 2018
Horn_Antenna SCHWARZBECK	BBHA 9120D	9120D-783	Dec. 12, 2017	Dec. 11, 2018
Pre-Amplifier EMCI	EMC12630SE	980385	Feb. 02, 2017	Feb. 01, 2018
RF Cable	EMC104-SM-SM-1200 EMC104-SM-SM-2000 EMC104-SM-SM-5000	160923 150318 150321	Feb. 02, 2017 Mar. 29, 2017 Mar. 29, 2017	Feb. 01, 2018 Mar. 28, 2018 Mar. 28, 2018
Pre-Amplifier EMCI	EMC184045SE	980387	Feb. 02, 2017	Feb. 01, 2018
Horn_Antenna SCHWARZBECK	BBHA 9170	BBHA9170608	Dec. 14, 2017	Dec. 13, 2018
RF Cable	SUCOFLEX 102	36432/2 36433/2	Jan. 11, 2018	Jan. 10, 2019
Software	ADT_Radiated_V8.7.08	NA	NA	NA
Antenna Tower & Turn Table Max-Full	MF-7802	MF780208410	NA	NA
Boresight Antenna Fixture	FBA-01	FBA-SIP02	NA	NA
Spectrum Analyzer R&S	FSV40	100964	July 1, 2017	June 30, 2018
Power meter Anritsu	ML2495A	1014008	May 11, 2017	May 10, 2018
Power sensor Anritsu	MA2411B	0917122	May 11, 2017	May 10, 2018
Temperature & Humidity Chamber Giant Force	GTH-150-40-SP-AR	MAA0812-008	Jan. 10, 2018	Jan. 09, 2019
DC Power Supply Topward	6603D	795558	NA	NA
True RMS Clamp Meter FLUKE	325	31130711WS	May 29, 2017	May 28, 2018

**Note:**

1. The calibration interval of the above test instruments is 12 months and the calibrations are traceable to NML/ROC and NIST/USA.
2. \*The calibration interval of the above test instruments is 24 months and the calibrations are traceable to NML/ROC and NIST/USA.
3. The test was performed in 966 Chamber No. 4.
4. Loop antenna was used for all emissions below 30 MHz.
5. The CANADA Site Registration No. is 20331-2
6. Tested Date: Jan. 18 to 19, 2018

#### 4.1.3 Test Procedure

##### **For Radiated emission below 30MHz**

- a. The EUT was placed on the top of a rotating table 0.8 meters above the ground at a 3 meter chamber room. The table was rotated 360 degrees to determine the position of the highest radiation.
- b. The EUT was set 3 meters away from the interference-receiving antenna, which was mounted on the top of a variable-height antenna tower.
- c. Both X and Y axes of the antenna are set to make the measurement.
- d. For each suspected emission, the EUT was arranged to its worst case and the rotatable table was turned from 0 degrees to 360 degrees to find the maximum reading.
- e. The test-receiver system was set to Quasi-Peak Detect Function and Specified Bandwidth with Maximum Hold Mode.

##### **NOTE:**

1. The resolution bandwidth and video bandwidth of test receiver/spectrum analyzer is 9kHz at frequency below 30MHz.

##### **For Radiated emission above 30MHz**

- a. The EUT was placed on the top of a rotating table 0.8 meters (for 30MHz ~ 1GHz) / 1.5 meters (for above 1GHz) above the ground at 3 meter chamber room for test. The table was rotated 360 degrees to determine the position of the highest radiation.
- b. The EUT was set 3 meters away from the interference-receiving antenna, which was mounted on the top of a variable-height antenna tower.
- c. The height of antenna is varied from one meter to four meters above the ground to determine the maximum value of the field strength. Both horizontal and vertical polarizations of the antenna are set to make the measurement.
- d. For each suspected emission, the EUT was arranged to its worst case and then the antenna was tuned to heights from 1 meter to 4 meters and the rotatable table was turned from 0 degrees to 360 degrees to find the maximum reading.
- e. The test-receiver system was set to quasi-peak detect function and specified bandwidth with maximum hold mode when the test frequency is below 1 GHz.
- f. The test-receiver system was set to peak and average detect function and specified bandwidth with maximum hold mode when the test frequency is above 1 GHz. If the peak reading value also meets average limit, measurement with the average detector is unnecessary.

##### **Note:**

1. The resolution bandwidth and video bandwidth of test receiver/spectrum analyzer is 120kHz for Quasi-peak detection (QP) at frequency below 1GHz.
2. The resolution bandwidth of test receiver/spectrum analyzer is 1 MHz and the video bandwidth is 3 MHz for Peak detection (PK) at frequency above 1GHz.
3. The resolution bandwidth of test receiver/spectrum analyzer is 1MHz and the video bandwidth is  $\geq 1/T$  (Duty cycle < 98%) or 10Hz (Duty cycle  $\geq 98\%$ ) for Average detection (AV) at frequency above 1GHz.
4. All modes of operation were investigated and the worst-case emissions are reported.

#### 4.1.4 Deviation from Test Standard

No deviation.

#### 4.1.5 Test Setup

##### For Radiated emission below 30MHz

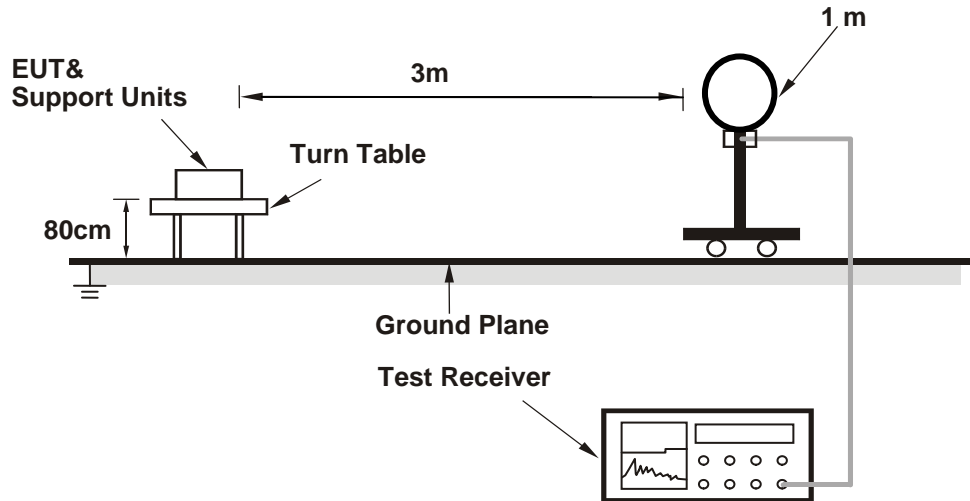

##### For Radiated emission 30MHz to 1GHz

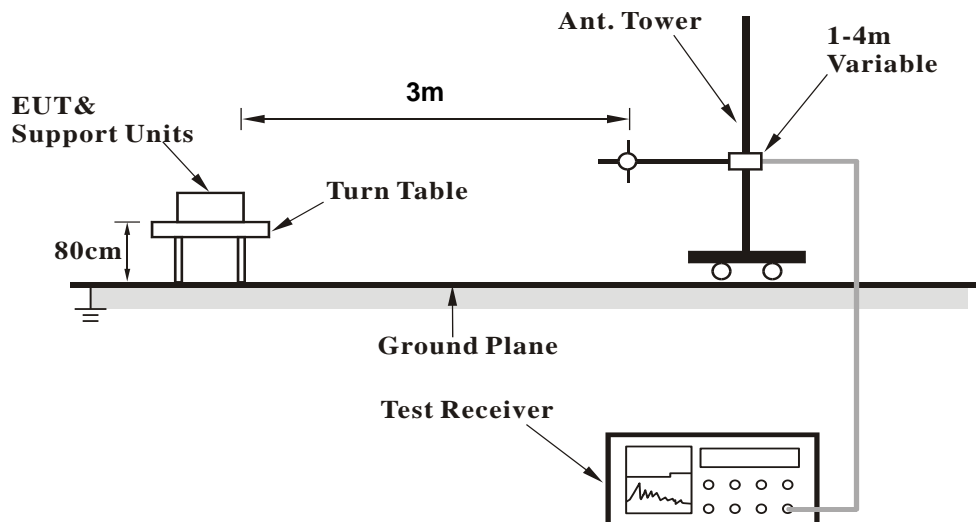

### For Radiated emission above 1GHz

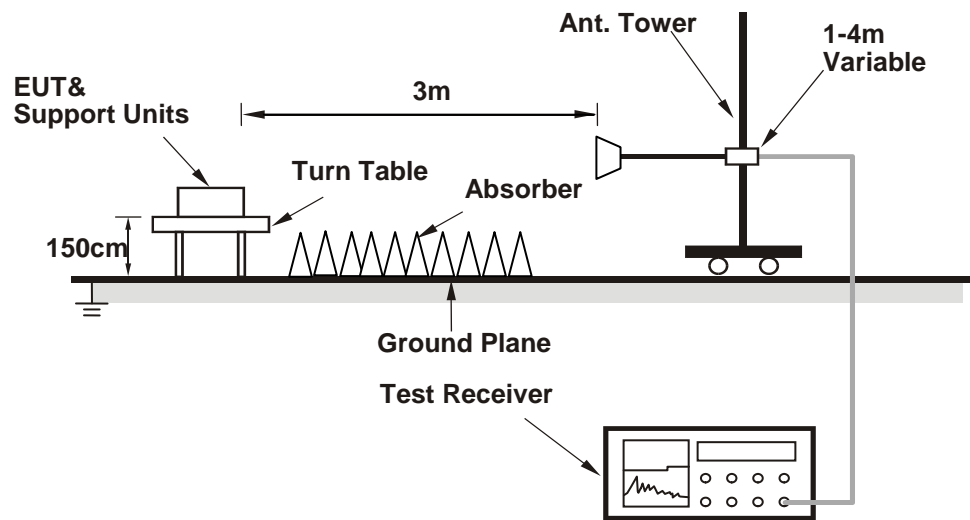

For the actual test configuration, please refer to the attached file (Test Setup Photo).

#### 4.1.6 EUT Operating Condition

- Connected the EUT with the Laptop.
- Controlling software (QRCT.exe V3.0.268.0) has been activated to set the EUT on specific status.

4.1.7 Test Results

Above 1GHz Data:

802.11a

<b>CHANNEL</b>	TX Channel 36	<b>DETECTOR FUNCTION</b>	Peak (PK)
<b>FREQUENCY RANGE</b>	1GHz ~ 40GHz		Average (AV)

ANTENNA POLARITY & TEST DISTANCE: HORIZONTAL AT 3 M								
NO.	FREQ. (MHz)	EMISSION LEVEL (dBuV/m)	LIMIT (dBuV/m)	MARGIN (dB)	ANTENNA HEIGHT (m)	TABLE ANGLE (Degree)	RAW VALUE (dBuV)	CORRECTION FACTOR (dB/m)
1	5150.00	60.1 PK	74.0	-13.9	2.66 H	137	55.8	4.3
2	5150.00	44.2 AV	54.0	-9.8	2.66 H	137	39.9	4.3
3	*5180.00	105.5 PK			2.66 H	137	101.4	4.1
4	*5180.00	95.1 AV			2.66 H	137	91.0	4.1
5	#10360.00	46.2 PK	74.0	-27.8	1.65 H	167	32.9	13.3
6	#10360.00	34.7 AV	54.0	-19.3	1.65 H	167	21.4	13.3
7	15540.00	46.9 PK	74.0	-27.1	1.90 H	221	34.0	12.9
8	15540.00	35.3 AV	54.0	-18.7	1.90 H	221	22.4	12.9

ANTENNA POLARITY & TEST DISTANCE: VERTICAL AT 3 M								
NO.	FREQ. (MHz)	EMISSION LEVEL (dBuV/m)	LIMIT (dBuV/m)	MARGIN (dB)	ANTENNA HEIGHT (m)	TABLE ANGLE (Degree)	RAW VALUE (dBuV)	CORRECTION FACTOR (dB/m)
1	5150.00	63.5 PK	74.0	-10.5	2.42 V	103	59.2	4.3
2	5150.00	47.6 AV	54.0	-6.4	2.42 V	103	43.3	4.3
3	*5180.00	109.9 PK			2.42 V	103	105.8	4.1
4	*5180.00	99.7 AV			2.42 V	103	95.6	4.1
5	#10360.00	46.1 PK	74.0	-27.9	1.71 V	343	32.8	13.3
6	#10360.00	34.9 AV	54.0	-19.1	1.71 V	343	21.6	13.3
7	15540.00	47.2 PK	74.0	-26.8	1.72 V	266	34.3	12.9
8	15540.00	35.6 AV	54.0	-18.4	1.72 V	266	22.7	12.9

REMARKS:

1. Emission Level(dBuV/m) = Raw Value(dBuV) + Correction Factor(dB/m)
2. Correction Factor(dB/m) = Antenna Factor(dB/m) + Cable Factor(dB) – Pre-Amplifier Factor(dB)
3. The other emission levels were very low against the limit.
4. Margin value = Emission Level – Limit value
5. " \* ": Fundamental frequency.
6. " # ": The radiated frequency is out of the restricted band.

<b>CHANNEL</b>	TX Channel 40	<b>DETECTOR FUNCTION</b>	Peak (PK)
<b>FREQUENCY RANGE</b>	1GHz ~ 40GHz		Average (AV)

**ANTENNA POLARITY & TEST DISTANCE: HORIZONTAL AT 3 M**

NO.	FREQ. (MHz)	EMISSION LEVEL (dBuV/m)	LIMIT (dBuV/m)	MARGIN (dB)	ANTENNA HEIGHT (m)	TABLE ANGLE (Degree)	RAW VALUE (dBuV)	CORRECTION FACTOR (dB/m)
1	5150.00	54.4 PK	74.0	-19.6	2.64 H	122	50.1	4.3
2	5150.00	38.4 AV	54.0	-15.6	2.64 H	122	34.1	4.3
3	*5200.00	106.1 PK			2.64 H	122	102.1	4.0
4	*5200.00	95.9 AV			2.64 H	122	91.9	4.0
5	5350.00	50.9 PK	74.0	-23.1	2.64 H	122	46.9	4.0
6	5350.00	37.8 AV	54.0	-16.2	2.64 H	122	33.8	4.0
7	#10400.00	45.6 PK	74.0	-28.4	1.64 H	158	32.1	13.5
8	#10400.00	34.6 AV	54.0	-19.4	1.64 H	158	21.1	13.5
9	15600.00	47.7 PK	74.0	-26.3	1.89 H	218	34.6	13.1
10	15600.00	35.6 AV	54.0	-18.4	1.89 H	218	22.5	13.1

**ANTENNA POLARITY & TEST DISTANCE: VERTICAL AT 3 M**

NO.	FREQ. (MHz)	EMISSION LEVEL (dBuV/m)	LIMIT (dBuV/m)	MARGIN (dB)	ANTENNA HEIGHT (m)	TABLE ANGLE (Degree)	RAW VALUE (dBuV)	CORRECTION FACTOR (dB/m)
1	5150.00	57.8 PK	74.0	-16.2	2.54 V	103	53.5	4.3
2	5150.00	41.8 AV	54.0	-12.2	2.54 V	103	37.5	4.3
3	*5200.00	110.5 PK			2.54 V	103	106.5	4.0
4	*5200.00	100.5 AV			2.54 V	103	96.5	4.0
5	5350.00	51.5 PK	74.0	-22.5	2.54 V	103	47.5	4.0
6	5350.00	38.2 AV	54.0	-15.8	2.54 V	103	34.2	4.0
7	#10400.00	45.3 PK	74.0	-28.7	1.67 V	359	31.8	13.5
8	#10400.00	34.5 AV	54.0	-19.5	1.67 V	359	21.0	13.5
9	15600.00	46.8 PK	74.0	-27.2	1.82 V	265	33.7	13.1
10	15600.00	35.3 AV	54.0	-18.7	1.82 V	265	22.2	13.1

**REMARKS:**

- Emission Level(dBuV/m) = Raw Value(dBuV) + Correction Factor(dB/m)
- Correction Factor(dB/m) = Antenna Factor(dB/m) + Cable Factor(dB) – Pre-Amplifier Factor(dB)
- The other emission levels were very low against the limit.
- Margin value = Emission Level – Limit value
- " \* ": Fundamental frequency.
- " # ": The radiated frequency is out of the restricted band.

<b>CHANNEL</b>	TX Channel 48	<b>DETECTOR FUNCTION</b>	Peak (PK)
<b>FREQUENCY RANGE</b>	1GHz ~ 40GHz		Average (AV)

**ANTENNA POLARITY & TEST DISTANCE: HORIZONTAL AT 3 M**

NO.	FREQ. (MHz)	EMISSION LEVEL (dBuV/m)	LIMIT (dBuV/m)	MARGIN (dB)	ANTENNA HEIGHT (m)	TABLE ANGLE (Degree)	RAW VALUE (dBuV)	CORRECTION FACTOR (dB/m)
1	*5240.00	107.6 PK			2.70 H	124	103.7	3.9
2	*5240.00	97.5 AV			2.70 H	124	93.6	3.9
3	5350.00	56.4 PK	74.0	-17.6	2.70 H	124	52.4	4.0
4	5350.00	37.8 AV	54.0	-16.2	2.70 H	124	33.8	4.0
5	#10480.00	45.9 PK	74.0	-28.1	1.65 H	155	31.9	14.0
6	#10480.00	34.6 AV	54.0	-19.4	1.65 H	155	20.6	14.0
7	15720.00	47.5 PK	74.0	-26.5	1.87 H	233	34.0	13.5
8	15720.00	35.6 AV	54.0	-18.4	1.87 H	233	22.1	13.5

**ANTENNA POLARITY & TEST DISTANCE: VERTICAL AT 3 M**

NO.	FREQ. (MHz)	EMISSION LEVEL (dBuV/m)	LIMIT (dBuV/m)	MARGIN (dB)	ANTENNA HEIGHT (m)	TABLE ANGLE (Degree)	RAW VALUE (dBuV)	CORRECTION FACTOR (dB/m)
1	*5240.00	112.0 PK			2.50 V	100	108.1	3.9
2	*5240.00	102.1 AV			2.50 V	100	98.2	3.9
3	5350.00	57.9 PK	74.0	-16.1	2.50 V	100	53.9	4.0
4	5350.00	38.4 AV	54.0	-15.6	2.50 V	100	34.4	4.0
5	#10480.00	45.6 PK	74.0	-28.4	1.66 V	354	31.6	14.0
6	#10480.00	34.7 AV	54.0	-19.3	1.66 V	354	20.7	14.0
7	15720.00	47.2 PK	74.0	-26.8	1.77 V	261	33.7	13.5
8	15720.00	35.4 AV	54.0	-18.6	1.77 V	261	21.9	13.5

**REMARKS:**

1. Emission Level(dBuV/m) = Raw Value(dBuV) + Correction Factor(dB/m)
2. Correction Factor(dB/m) = Antenna Factor(dB/m) + Cable Factor(dB) – Pre-Amplifier Factor(dB)
3. The other emission levels were very low against the limit.
4. Margin value = Emission Level – Limit value
5. " \* ": Fundamental frequency.
6. " # ": The radiated frequency is out of the restricted band.



<b>CHANNEL</b>	TX Channel 52	<b>DETECTOR FUNCTION</b>	Peak (PK)
<b>FREQUENCY RANGE</b>	1GHz ~ 40GHz		Average (AV)

**ANTENNA POLARITY & TEST DISTANCE: HORIZONTAL AT 3 M**

NO.	FREQ. (MHz)	EMISSION LEVEL (dBuV/m)	LIMIT (dBuV/m)	MARGIN (dB)	ANTENNA HEIGHT (m)	TABLE ANGLE (Degree)	RAW VALUE (dBuV)	CORRECTION FACTOR (dB/m)
1	5150.00	48.9 PK	74.0	-25.1	2.72 H	125	44.6	4.3
2	5150.00	37.5 AV	54.0	-16.5	2.72 H	125	33.2	4.3
3	*5260.00	108.1 PK			2.72 H	125	104.3	3.8
4	*5260.00	98.3 AV			2.72 H	125	94.5	3.8
5	#10520.00	46.1 PK	74.0	-27.9	1.63 H	142	32.1	14.0
6	#10520.00	34.7 AV	54.0	-19.3	1.63 H	142	20.7	14.0
7	15780.00	48.1 PK	74.0	-25.9	1.88 H	223	34.5	13.6
8	15780.00	36.0 AV	54.0	-18.0	1.88 H	223	22.4	13.6

**ANTENNA POLARITY & TEST DISTANCE: VERTICAL AT 3 M**

NO.	FREQ. (MHz)	EMISSION LEVEL (dBuV/m)	LIMIT (dBuV/m)	MARGIN (dB)	ANTENNA HEIGHT (m)	TABLE ANGLE (Degree)	RAW VALUE (dBuV)	CORRECTION FACTOR (dB/m)
1	5150.00	49.3 PK	74.0	-24.7	2.66 V	100	45.0	4.3
2	5150.00	37.7 AV	54.0	-16.3	2.66 V	100	33.4	4.3
3	*5260.00	112.5 PK			2.66 V	100	108.7	3.8
4	*5260.00	102.9 AV			2.66 V	100	99.1	3.8
5	#10520.00	45.8 PK	74.0	-28.2	1.69 V	355	31.8	14.0
6	#10520.00	34.7 AV	54.0	-19.3	1.69 V	355	20.7	14.0
7	15780.00	47.5 PK	74.0	-26.5	1.76 V	262	33.9	13.6
8	15780.00	35.4 AV	54.0	-18.6	1.76 V	262	21.8	13.6

**REMARKS:**

1. Emission Level(dBuV/m) = Raw Value(dBuV) + Correction Factor(dB/m)
2. Correction Factor(dB/m) = Antenna Factor(dB/m) + Cable Factor(dB) – Pre-Amplifier Factor(dB)
3. The other emission levels were very low against the limit.
4. Margin value = Emission Level – Limit value
5. " \* ": Fundamental frequency.
6. " # ": The radiated frequency is out of the restricted band.

<b>CHANNEL</b>	TX Channel 60	<b>DETECTOR FUNCTION</b>	Peak (PK)
<b>FREQUENCY RANGE</b>	1GHz ~ 40GHz		Average (AV)

**ANTENNA POLARITY & TEST DISTANCE: HORIZONTAL AT 3 M**

NO.	FREQ. (MHz)	EMISSION LEVEL (dBuV/m)	LIMIT (dBuV/m)	MARGIN (dB)	ANTENNA HEIGHT (m)	TABLE ANGLE (Degree)	RAW VALUE (dBuV)	CORRECTION FACTOR (dB/m)
1	*5300.00	109.3 PK			2.70 H	127	105.4	3.9
2	*5300.00	99.1 AV			2.70 H	127	95.2	3.9
3	10600.00	45.5 PK	74.0	-28.5	1.67 H	151	32.1	13.4
4	10600.00	34.3 AV	54.0	-19.7	1.67 H	151	20.9	13.4
5	15900.00	47.6 PK	74.0	-26.4	1.92 H	229	35.1	12.5
6	15900.00	35.7 AV	54.0	-18.3	1.92 H	229	23.2	12.5

**ANTENNA POLARITY & TEST DISTANCE: VERTICAL AT 3 M**

NO.	FREQ. (MHz)	EMISSION LEVEL (dBuV/m)	LIMIT (dBuV/m)	MARGIN (dB)	ANTENNA HEIGHT (m)	TABLE ANGLE (Degree)	RAW VALUE (dBuV)	CORRECTION FACTOR (dB/m)
1	*5300.00	113.7 PK			2.68 V	103	109.8	3.9
2	*5300.00	103.7 AV			2.68 V	103	99.8	3.9
3	10600.00	45.6 PK	74.0	-28.4	1.66 V	346	32.2	13.4
4	10600.00	34.8 AV	54.0	-19.2	1.66 V	346	21.4	13.4
5	15900.00	47.4 PK	74.0	-26.6	1.77 V	276	34.9	12.5
6	15900.00	35.5 AV	54.0	-18.5	1.77 V	276	23.0	12.5

**REMARKS:**

1. Emission Level(dBuV/m) = Raw Value(dBuV) + Correction Factor(dB/m)
2. Correction Factor(dB/m) = Antenna Factor(dB/m) + Cable Factor(dB) – Pre-Amplifier Factor(dB)
3. The other emission levels were very low against the limit.
4. Margin value = Emission Level – Limit value
5. " \* ": Fundamental frequency.

<b>CHANNEL</b>	TX Channel 64	<b>DETECTOR FUNCTION</b>	Peak (PK)
<b>FREQUENCY RANGE</b>	1GHz ~ 40GHz		Average (AV)

**ANTENNA POLARITY & TEST DISTANCE: HORIZONTAL AT 3 M**

NO.	FREQ. (MHz)	EMISSION LEVEL (dBuV/m)	LIMIT (dBuV/m)	MARGIN (dB)	ANTENNA HEIGHT (m)	TABLE ANGLE (Degree)	RAW VALUE (dBuV)	CORRECTION FACTOR (dB/m)
1	*5320.00	108.6 PK			2.69 H	117	104.7	3.9
2	*5320.00	98.6 AV			2.69 H	117	94.7	3.9
3	5350.00	67.6 PK	74.0	-6.4	2.69 H	117	63.6	4.0
4	5350.00	47.8 AV	54.0	-6.2	2.69 H	117	43.8	4.0
5	10640.00	45.2 PK	74.0	-28.8	1.67 H	147	31.6	13.6
6	10640.00	34.1 AV	54.0	-19.9	1.67 H	147	20.5	13.6
7	15960.00	48.0 PK	74.0	-26.0	1.88 H	244	35.1	12.9
8	15960.00	36.1 AV	54.0	-17.9	1.88 H	244	23.2	12.9

**ANTENNA POLARITY & TEST DISTANCE: VERTICAL AT 3 M**

NO.	FREQ. (MHz)	EMISSION LEVEL (dBuV/m)	LIMIT (dBuV/m)	MARGIN (dB)	ANTENNA HEIGHT (m)	TABLE ANGLE (Degree)	RAW VALUE (dBuV)	CORRECTION FACTOR (dB/m)
1	*5320.00	113.0 PK			2.65 V	103	109.1	3.9
2	*5320.00	103.2 AV			2.65 V	103	99.3	3.9
3	5350.00	71.0 PK	74.0	-3.0	2.65 V	103	67.0	4.0
4	5350.00	51.2 AV	54.0	-2.8	2.65 V	103	47.2	4.0
5	10640.00	45.5 PK	74.0	-28.5	1.70 V	348	31.9	13.6
6	10640.00	34.7 AV	54.0	-19.3	1.70 V	348	21.1	13.6
7	15960.00	47.6 PK	74.0	-26.4	1.73 V	275	34.7	12.9
8	15960.00	35.9 AV	54.0	-18.1	1.73 V	275	23.0	12.9

**REMARKS:**

1. Emission Level(dBuV/m) = Raw Value(dBuV) + Correction Factor(dB/m)
2. Correction Factor(dB/m) = Antenna Factor(dB/m) + Cable Factor(dB) – Pre-Amplifier Factor(dB)
3. The other emission levels were very low against the limit.
4. Margin value = Emission Level – Limit value
5. " \* ": Fundamental frequency.

<b>CHANNEL</b>	TX Channel 100	<b>DETECTOR FUNCTION</b>	Peak (PK)
<b>FREQUENCY RANGE</b>	1GHz ~ 40GHz		Average (AV)

**ANTENNA POLARITY & TEST DISTANCE: HORIZONTAL AT 3 M**

NO.	FREQ. (MHz)	EMISSION LEVEL (dBuV/m)	LIMIT (dBuV/m)	MARGIN (dB)	ANTENNA HEIGHT (m)	TABLE ANGLE (Degree)	RAW VALUE (dBuV)	CORRECTION FACTOR (dB/m)
1	#5470.00	66.8 PK	74.0	-7.2	2.64 H	106	62.5	4.3
2	#5470.00	47.6 AV	54.0	-6.4	2.64 H	106	43.3	4.3
3	*5500.00	107.3 PK			2.64 H	106	103.0	4.3
4	*5500.00	97.2 AV			2.64 H	106	92.9	4.3
5	11000.00	45.5 PK	74.0	-28.5	1.69 H	147	31.6	13.9
6	11000.00	34.4 AV	54.0	-19.6	1.69 H	147	20.5	13.9
7	#16500.00	47.9 PK	74.0	-26.1	1.89 H	219	32.3	15.6
8	#16500.00	36.1 AV	54.0	-17.9	1.89 H	219	20.5	15.6

**ANTENNA POLARITY & TEST DISTANCE: VERTICAL AT 3 M**

NO.	FREQ. (MHz)	EMISSION LEVEL (dBuV/m)	LIMIT (dBuV/m)	MARGIN (dB)	ANTENNA HEIGHT (m)	TABLE ANGLE (Degree)	RAW VALUE (dBuV)	CORRECTION FACTOR (dB/m)
1	#5470.00	70.2 PK	74.0	-3.8	2.63 V	103	65.9	4.3
2	#5470.00	51.0 AV	54.0	-3.0	2.63 V	103	46.7	4.3
3	*5500.00	111.7 PK			2.63 V	103	107.4	4.3
4	*5500.00	101.8 AV			2.63 V	103	97.5	4.3
5	11000.00	46.3 PK	74.0	-27.7	1.62 V	342	32.4	13.9
6	11000.00	35.1 AV	54.0	-18.9	1.62 V	342	21.2	13.9
7	#16500.00	47.4 PK	74.0	-26.6	1.78 V	248	31.8	15.6
8	#16500.00	35.4 AV	54.0	-18.6	1.78 V	248	19.8	15.6

**REMARKS:**

1. Emission Level(dBuV/m) = Raw Value(dBuV) + Correction Factor(dB/m)
2. Correction Factor(dB/m) = Antenna Factor(dB/m) + Cable Factor(dB) – Pre-Amplifier Factor(dB)
3. The other emission levels were very low against the limit.
4. Margin value = Emission Level – Limit value
5. " \* ": Fundamental frequency.
6. " # ": The radiated frequency is out of the restricted band.

<b>CHANNEL</b>	TX Channel 116	<b>DETECTOR FUNCTION</b>	Peak (PK)
<b>FREQUENCY RANGE</b>	1GHz ~ 40GHz		Average (AV)

**ANTENNA POLARITY & TEST DISTANCE: HORIZONTAL AT 3 M**

NO.	FREQ. (MHz)	EMISSION LEVEL (dBuV/m)	LIMIT (dBuV/m)	MARGIN (dB)	ANTENNA HEIGHT (m)	TABLE ANGLE (Degree)	RAW VALUE (dBuV)	CORRECTION FACTOR (dB/m)
1	*5580.00	107.9 PK			2.58 H	109	103.5	4.4
2	*5580.00	97.5 AV			2.58 H	109	93.1	4.4
3	11160.00	45.5 PK	74.0	-28.5	1.63 H	145	31.8	13.7
4	11160.00	34.3 AV	54.0	-19.7	1.63 H	145	20.6	13.7
5	#16740.00	47.1 PK	74.0	-26.9	1.82 H	237	30.5	16.6
6	#16740.00	35.2 AV	54.0	-18.8	1.82 H	237	18.6	16.6

**ANTENNA POLARITY & TEST DISTANCE: VERTICAL AT 3 M**

NO.	FREQ. (MHz)	EMISSION LEVEL (dBuV/m)	LIMIT (dBuV/m)	MARGIN (dB)	ANTENNA HEIGHT (m)	TABLE ANGLE (Degree)	RAW VALUE (dBuV)	CORRECTION FACTOR (dB/m)
1	*5580.00	112.3 PK			2.69 V	112	107.9	4.4
2	*5580.00	102.1 AV			2.69 V	112	97.7	4.4
3	11160.00	45.6 PK	74.0	-28.4	1.66 V	360	31.9	13.7
4	11160.00	34.5 AV	54.0	-19.5	1.66 V	360	20.8	13.7
5	#16740.00	47.1 PK	74.0	-26.9	1.77 V	260	30.5	16.6
6	#16740.00	35.6 AV	54.0	-18.4	1.77 V	260	19.0	16.6

**REMARKS:**

1. Emission Level(dBuV/m) = Raw Value(dBuV) + Correction Factor(dB/m)
2. Correction Factor(dB/m) = Antenna Factor(dB/m) + Cable Factor(dB) – Pre-Amplifier Factor(dB)
3. The other emission levels were very low against the limit.
4. Margin value = Emission Level – Limit value
5. " \* ": Fundamental frequency.
6. " # ": The radiated frequency is out of the restricted band.

<b>CHANNEL</b>	TX Channel 140	<b>DETECTOR FUNCTION</b>	Peak (PK)
<b>FREQUENCY RANGE</b>	1GHz ~ 40GHz		Average (AV)

**ANTENNA POLARITY & TEST DISTANCE: HORIZONTAL AT 3 M**

NO.	FREQ. (MHz)	EMISSION LEVEL (dBuV/m)	LIMIT (dBuV/m)	MARGIN (dB)	ANTENNA HEIGHT (m)	TABLE ANGLE (Degree)	RAW VALUE (dBuV)	CORRECTION FACTOR (dB/m)
1	*5700.00	106.1 PK			2.53 H	114	101.6	4.5
2	*5700.00	96.1 AV			2.53 H	114	91.6	4.5
3	#5725.00	62.1 PK	74.0	-11.9	2.53 H	114	57.6	4.5
4	#5725.00	46.3 AV	54.0	-7.7	2.53 H	114	41.8	4.5
5	11400.00	47.1 PK	74.0	-26.9	1.57 H	143	32.6	14.5
6	11400.00	35.2 AV	54.0	-18.8	1.57 H	143	20.7	14.5
7	#17100.00	51.1 PK	74.0	-22.9	1.70 H	203	33.8	17.3
8	#17100.00	39.0 AV	54.0	-15.0	1.70 H	203	21.7	17.3

**ANTENNA POLARITY & TEST DISTANCE: VERTICAL AT 3 M**

NO.	FREQ. (MHz)	EMISSION LEVEL (dBuV/m)	LIMIT (dBuV/m)	MARGIN (dB)	ANTENNA HEIGHT (m)	TABLE ANGLE (Degree)	RAW VALUE (dBuV)	CORRECTION FACTOR (dB/m)
1	*5700.00	110.5 PK			2.77 V	110	106.0	4.5
2	*5700.00	100.7 AV			2.77 V	110	96.2	4.5
3	#5725.00	65.5 PK	74.0	-8.5	2.77 V	110	61.0	4.5
4	#5725.00	49.7 AV	54.0	-4.3	2.77 V	110	45.2	4.5
5	11400.00	47.0 PK	74.0	-27.0	1.63 V	298	32.5	14.5
6	11400.00	34.8 AV	54.0	-19.2	1.63 V	298	20.3	14.5
7	#17100.00	51.7 PK	74.0	-22.3	1.95 V	150	34.4	17.3
8	#17100.00	39.3 AV	54.0	-14.7	1.95 V	150	22.0	17.3

**REMARKS:**

1. Emission Level(dBuV/m) = Raw Value(dBuV) + Correction Factor(dB/m)
2. Correction Factor(dB/m) = Antenna Factor(dB/m) + Cable Factor(dB) – Pre-Amplifier Factor(dB)
3. The other emission levels were very low against the limit.
4. Margin value = Emission Level – Limit value
5. " \* ": Fundamental frequency.
6. " # ": The radiated frequency is out of the restricted band.

<b>CHANNEL</b>	TX Channel 144	<b>DETECTOR FUNCTION</b>	Peak (PK)
<b>FREQUENCY RANGE</b>	1GHz ~ 40GHz		Average (AV)

**ANTENNA POLARITY & TEST DISTANCE: HORIZONTAL AT 3 M**

NO.	FREQ. (MHz)	EMISSION LEVEL (dBuV/m)	LIMIT (dBuV/m)	MARGIN (dB)	ANTENNA HEIGHT (m)	TABLE ANGLE (Degree)	RAW VALUE (dBuV)	CORRECTION FACTOR (dB/m)
1	#5470.00	50.4 PK	74.0	-23.6	2.58 H	117	46.1	4.3
2	#5470.00	37.6 AV	54.0	-16.4	2.58 H	117	33.3	4.3
3	*5720.00	105.3 PK			2.58 H	117	100.8	4.5
4	*5720.00	95.6 AV			2.58 H	117	91.1	4.5
5	#5850.00	49.9 PK	74.0	-24.1	2.58 H	117	45.1	4.8
6	#5850.00	37.9 AV	54.0	-16.1	2.58 H	117	33.1	4.8
7	11440.00	46.7 PK	74.0	-27.3	1.60 H	118	32.5	14.2
8	11440.00	34.8 AV	54.0	-19.2	1.60 H	118	20.6	14.2
9	#17160.00	50.7 PK	74.0	-23.3	1.65 H	213	33.8	16.9
10	#17160.00	38.9 AV	54.0	-15.1	1.65 H	213	22.0	16.9

**ANTENNA POLARITY & TEST DISTANCE: VERTICAL AT 3 M**

NO.	FREQ. (MHz)	EMISSION LEVEL (dBuV/m)	LIMIT (dBuV/m)	MARGIN (dB)	ANTENNA HEIGHT (m)	TABLE ANGLE (Degree)	RAW VALUE (dBuV)	CORRECTION FACTOR (dB/m)
1	#5470.00	50.6 PK	74.0	-23.4	2.78 V	109	46.3	4.3
2	#5470.00	37.9 AV	54.0	-16.1	2.78 V	109	33.6	4.3
3	*5720.00	109.9 PK			2.78 V	109	105.4	4.5
4	*5720.00	100.2 AV			2.78 V	109	95.7	4.5
5	#5850.00	50.2 PK	74.0	-23.8	2.78 V	109	45.4	4.8
6	#5850.00	38.9 AV	54.0	-15.1	2.78 V	109	34.1	4.8
7	11440.00	47.3 PK	74.0	-26.7	1.64 V	290	33.1	14.2
8	11440.00	35.1 AV	54.0	-18.9	1.64 V	290	20.9	14.2
9	#17160.00	51.2 PK	74.0	-22.8	1.98 V	169	34.3	16.9
10	#17160.00	39.1 AV	54.0	-14.9	1.98 V	169	22.2	16.9

**REMARKS:**

1. Emission Level(dBuV/m) = Raw Value(dBuV) + Correction Factor(dB/m)
2. Correction Factor(dB/m) = Antenna Factor(dB/m) + Cable Factor(dB) – Pre-Amplifier Factor(dB)
3. The other emission levels were very low against the limit.
4. Margin value = Emission Level – Limit value
5. " \* ": Fundamental frequency.
6. " # ": The radiated frequency is out of the restricted band.

<b>CHANNEL</b>	TX Channel 149	<b>DETECTOR FUNCTION</b>	Peak (PK)
<b>FREQUENCY RANGE</b>	1GHz ~ 40GHz		Average (AV)

**ANTENNA POLARITY & TEST DISTANCE: HORIZONTAL AT 3 M**

NO.	FREQ. (MHz)	EMISSION LEVEL (dBuV/m)	LIMIT (dBuV/m)	MARGIN (dB)	ANTENNA HEIGHT (m)	TABLE ANGLE (Degree)	RAW VALUE (dBuV)	CORRECTION FACTOR (dB/m)
1	*5745.00	105.5 PK			2.66 H	128	100.9	4.6
2	*5745.00	96.9 AV			2.66 H	128	92.3	4.6
3	11490.00	47.2 PK	74.0	-26.8	1.57 H	133	33.1	14.1
4	11490.00	35.2 AV	54.0	-18.8	1.57 H	133	21.1	14.1
5	#17235.00	50.9 PK	74.0	-23.1	1.69 H	211	34.0	16.9
6	#17235.00	38.8 AV	54.0	-15.2	1.69 H	211	21.9	16.9

**ANTENNA POLARITY & TEST DISTANCE: VERTICAL AT 3 M**

NO.	FREQ. (MHz)	EMISSION LEVEL (dBuV/m)	LIMIT (dBuV/m)	MARGIN (dB)	ANTENNA HEIGHT (m)	TABLE ANGLE (Degree)	RAW VALUE (dBuV)	CORRECTION FACTOR (dB/m)
1	*5745.00	109.9 PK			2.64 V	58	105.3	4.6
2	*5745.00	101.5 AV			2.64 V	58	96.9	4.6
3	11490.00	47.3 PK	74.0	-26.7	1.66 V	287	33.2	14.1
4	11490.00	35.3 AV	54.0	-18.7	1.66 V	287	21.2	14.1
5	#17235.00	51.2 PK	74.0	-22.8	1.98 V	156	34.3	16.9
6	#17235.00	38.9 AV	54.0	-15.1	1.98 V	156	22.0	16.9

**REMARKS:**

- Emission Level(dBuV/m) = Raw Value(dBuV) + Correction Factor(dB/m)
- Correction Factor(dB/m) = Antenna Factor(dB/m) + Cable Factor(dB) – Pre-Amplifier Factor(dB)
- The other emission levels were very low against the limit.
- Margin value = Emission Level – Limit value
- " \* ": Fundamental frequency.
- " # ": The radiated frequency is out of the restricted band.



<b>CHANNEL</b>	TX Channel 157	<b>DETECTOR FUNCTION</b>	Peak (PK)
<b>FREQUENCY RANGE</b>	1GHz ~ 40GHz		Average (AV)

**ANTENNA POLARITY & TEST DISTANCE: HORIZONTAL AT 3 M**

NO.	FREQ. (MHz)	EMISSION LEVEL (dBuV/m)	LIMIT (dBuV/m)	MARGIN (dB)	ANTENNA HEIGHT (m)	TABLE ANGLE (Degree)	RAW VALUE (dBuV)	CORRECTION FACTOR (dB/m)
1	*5785.00	104.8 PK			2.66 H	128	100.2	4.6
2	*5785.00	96.4 AV			2.66 H	128	91.8	4.6
3	11570.00	46.4 PK	74.0	-27.6	1.59 H	130	32.3	14.1
4	11570.00	34.7 AV	54.0	-19.3	1.59 H	130	20.6	14.1
5	#17355.00	51.6 PK	74.0	-22.4	1.74 H	215	33.8	17.8
6	#17355.00	39.2 AV	54.0	-14.8	1.74 H	215	21.4	17.8

**ANTENNA POLARITY & TEST DISTANCE: VERTICAL AT 3 M**

NO.	FREQ. (MHz)	EMISSION LEVEL (dBuV/m)	LIMIT (dBuV/m)	MARGIN (dB)	ANTENNA HEIGHT (m)	TABLE ANGLE (Degree)	RAW VALUE (dBuV)	CORRECTION FACTOR (dB/m)
1	*5785.00	109.4 PK			2.52 V	54	104.8	4.6
2	*5785.00	100.6 AV			2.52 V	54	96.0	4.6
3	11570.00	46.8 PK	74.0	-27.2	1.72 V	280	32.7	14.1
4	11570.00	34.8 AV	54.0	-19.2	1.72 V	280	20.7	14.1
5	#17355.00	51.4 PK	74.0	-22.6	2.04 V	160	33.6	17.8
6	#17355.00	38.9 AV	54.0	-15.1	2.04 V	160	21.1	17.8

**REMARKS:**

- Emission Level(dBuV/m) = Raw Value(dBuV) + Correction Factor(dB/m)
- Correction Factor(dB/m) = Antenna Factor(dB/m) + Cable Factor(dB) – Pre-Amplifier Factor(dB)
- The other emission levels were very low against the limit.
- Margin value = Emission Level – Limit value
- " \* ": Fundamental frequency.
- " # ": The radiated frequency is out of the restricted band.

<b>CHANNEL</b>	TX Channel 165	<b>DETECTOR FUNCTION</b>	Peak (PK)
<b>FREQUENCY RANGE</b>	1GHz ~ 40GHz		Average (AV)

**ANTENNA POLARITY & TEST DISTANCE: HORIZONTAL AT 3 M**

NO.	FREQ. (MHz)	EMISSION LEVEL (dBuV/m)	LIMIT (dBuV/m)	MARGIN (dB)	ANTENNA HEIGHT (m)	TABLE ANGLE (Degree)	RAW VALUE (dBuV)	CORRECTION FACTOR (dB/m)
1	*5825.00	104.6 PK			2.68 H	131	99.8	4.8
2	*5825.00	96.5 AV			2.68 H	131	91.7	4.8
3	11650.00	47.2 PK	74.0	-26.8	1.59 H	138	33.2	14.0
4	11650.00	35.1 AV	54.0	-18.9	1.59 H	138	21.1	14.0
5	#17475.00	50.7 PK	74.0	-23.3	1.74 H	218	31.7	19.0
6	#17475.00	38.8 AV	54.0	-15.2	1.74 H	218	19.8	19.0

**ANTENNA POLARITY & TEST DISTANCE: VERTICAL AT 3 M**

NO.	FREQ. (MHz)	EMISSION LEVEL (dBuV/m)	LIMIT (dBuV/m)	MARGIN (dB)	ANTENNA HEIGHT (m)	TABLE ANGLE (Degree)	RAW VALUE (dBuV)	CORRECTION FACTOR (dB/m)
1	*5825.00	110.3 PK			2.55 V	58	105.5	4.8
2	*5825.00	101.2 AV			2.55 V	58	96.4	4.8
3	11650.00	47.5 PK	74.0	-26.5	1.63 V	295	33.5	14.0
4	11650.00	35.4 AV	54.0	-18.6	1.63 V	295	21.4	14.0
5	#17475.00	51.4 PK	74.0	-22.6	2.01 V	158	32.4	19.0
6	#17475.00	38.9 AV	54.0	-15.1	2.01 V	158	19.9	19.0

**REMARKS:**

1. Emission Level(dBuV/m) = Raw Value(dBuV) + Correction Factor(dB/m)
2. Correction Factor(dB/m) = Antenna Factor(dB/m) + Cable Factor(dB) – Pre-Amplifier Factor(dB)
3. The other emission levels were very low against the limit.
4. Margin value = Emission Level – Limit value
5. " \* ": Fundamental frequency.
6. " # ": The radiated frequency is out of the restricted band.

**802.11ac (VHT20)**

<b>CHANNEL</b>	TX Channel 36	<b>DETECTOR FUNCTION</b>	Peak (PK)
<b>FREQUENCY RANGE</b>	1GHz ~ 40GHz		Average (AV)

**ANTENNA POLARITY & TEST DISTANCE: HORIZONTAL AT 3 M**

NO.	FREQ. (MHz)	EMISSION LEVEL (dBuV/m)	LIMIT (dBuV/m)	MARGIN (dB)	ANTENNA HEIGHT (m)	TABLE ANGLE (Degree)	RAW VALUE (dBuV)	CORRECTION FACTOR (dB/m)
1	5150.00	57.9 PK	74.0	-16.1	2.70 H	133	53.6	4.3
2	5150.00	45.0 AV	54.0	-9.0	2.70 H	133	40.7	4.3
3	*5180.00	104.9 PK			2.70 H	133	100.8	4.1
4	*5180.00	95.4 AV			2.70 H	133	91.3	4.1
5	#10360.00	46.2 PK	74.0	-27.8	1.60 H	166	32.9	13.3
6	#10360.00	34.9 AV	54.0	-19.1	1.60 H	166	21.6	13.3
7	15540.00	48.0 PK	74.0	-26.0	1.92 H	224	35.1	12.9
8	15540.00	36.0 AV	54.0	-18.0	1.92 H	224	23.1	12.9

**ANTENNA POLARITY & TEST DISTANCE: VERTICAL AT 3 M**

NO.	FREQ. (MHz)	EMISSION LEVEL (dBuV/m)	LIMIT (dBuV/m)	MARGIN (dB)	ANTENNA HEIGHT (m)	TABLE ANGLE (Degree)	RAW VALUE (dBuV)	CORRECTION FACTOR (dB/m)
1	5150.00	61.3 PK	74.0	-12.7	2.65 V	288	57.0	4.3
2	5150.00	48.4 AV	54.0	-5.6	2.65 V	288	44.1	4.3
3	*5180.00	109.3 PK			2.65 V	288	105.2	4.1
4	*5180.00	100.0 AV			2.65 V	288	95.9	4.1
5	#10360.00	45.4 PK	74.0	-28.6	1.71 V	352	32.1	13.3
6	#10360.00	34.8 AV	54.0	-19.2	1.71 V	352	21.5	13.3
7	15540.00	47.4 PK	74.0	-26.6	1.83 V	263	34.5	12.9
8	15540.00	35.3 AV	54.0	-18.7	1.83 V	263	22.4	12.9

**REMARKS:**

- Emission Level(dBuV/m) = Raw Value(dBuV) + Correction Factor(dB/m)
- Correction Factor(dB/m) = Antenna Factor(dB/m) + Cable Factor(dB) – Pre-Amplifier Factor(dB)
- The other emission levels were very low against the limit.
- Margin value = Emission Level – Limit value
- " \* ": Fundamental frequency.
- " # ": The radiated frequency is out of the restricted band.

<b>CHANNEL</b>	TX Channel 40	<b>DETECTOR FUNCTION</b>	Peak (PK)
<b>FREQUENCY RANGE</b>	1GHz ~ 40GHz		Average (AV)

**ANTENNA POLARITY & TEST DISTANCE: HORIZONTAL AT 3 M**

NO.	FREQ. (MHz)	EMISSION LEVEL (dBuV/m)	LIMIT (dBuV/m)	MARGIN (dB)	ANTENNA HEIGHT (m)	TABLE ANGLE (Degree)	RAW VALUE (dBuV)	CORRECTION FACTOR (dB/m)
1	5150.00	54.8 PK	74.0	-19.2	2.72 H	119	50.5	4.3
2	5150.00	39.8 AV	54.0	-14.2	2.72 H	119	35.5	4.3
3	*5200.00	105.7 PK			2.72 H	119	101.7	4.0
4	*5200.00	95.8 AV			2.72 H	119	91.8	4.0
5	5350.00	49.4 PK	74.0	-24.6	2.72 H	119	45.4	4.0
6	5350.00	37.5 AV	54.0	-16.5	2.72 H	119	33.5	4.0
7	#10400.00	45.7 PK	74.0	-28.3	1.62 H	148	32.2	13.5
8	#10400.00	34.6 AV	54.0	-19.4	1.62 H	148	21.1	13.5
9	15600.00	48.3 PK	74.0	-25.7	1.85 H	203	35.2	13.1
10	15600.00	36.0 AV	54.0	-18.0	1.85 H	203	22.9	13.1

**ANTENNA POLARITY & TEST DISTANCE: VERTICAL AT 3 M**

NO.	FREQ. (MHz)	EMISSION LEVEL (dBuV/m)	LIMIT (dBuV/m)	MARGIN (dB)	ANTENNA HEIGHT (m)	TABLE ANGLE (Degree)	RAW VALUE (dBuV)	CORRECTION FACTOR (dB/m)
1	5150.00	58.2 PK	74.0	-15.8	2.64 V	295	53.9	4.3
2	5150.00	43.2 AV	54.0	-10.8	2.64 V	295	38.9	4.3
3	*5200.00	110.1 PK			2.64 V	295	106.1	4.0
4	*5200.00	100.4 AV			2.64 V	295	96.4	4.0
5	5350.00	49.6 PK	74.0	-24.4	2.64 V	295	45.6	4.0
6	5350.00	37.6 AV	54.0	-16.4	2.64 V	295	33.6	4.0
7	#10400.00	45.6 PK	74.0	-28.4	1.66 V	348	32.1	13.5
8	#10400.00	34.6 AV	54.0	-19.4	1.66 V	348	21.1	13.5
9	15600.00	47.4 PK	74.0	-26.6	1.72 V	262	34.3	13.1
10	15600.00	35.7 AV	54.0	-18.3	1.72 V	262	22.6	13.1

**REMARKS:**

1. Emission Level(dBuV/m) = Raw Value(dBuV) + Correction Factor(dB/m)
2. Correction Factor(dB/m) = Antenna Factor(dB/m) + Cable Factor(dB) – Pre-Amplifier Factor(dB)
3. The other emission levels were very low against the limit.
4. Margin value = Emission Level – Limit value
5. " \* ": Fundamental frequency.
6. " # ": The radiated frequency is out of the restricted band.

<b>CHANNEL</b>	TX Channel 48	<b>DETECTOR FUNCTION</b>	Peak (PK)
<b>FREQUENCY RANGE</b>	1GHz ~ 40GHz		Average (AV)

**ANTENNA POLARITY & TEST DISTANCE: HORIZONTAL AT 3 M**

NO.	FREQ. (MHz)	EMISSION LEVEL (dBuV/m)	LIMIT (dBuV/m)	MARGIN (dB)	ANTENNA HEIGHT (m)	TABLE ANGLE (Degree)	RAW VALUE (dBuV)	CORRECTION FACTOR (dB/m)
1	*5240.00	106.5 PK			2.72 H	105	102.6	3.9
2	*5240.00	96.4 AV			2.72 H	105	92.5	3.9
3	5350.00	49.9 PK	74.0	-24.1	2.72 H	105	45.9	4.0
4	5350.00	37.9 AV	54.0	-16.1	2.72 H	105	33.9	4.0
5	#10480.00	45.6 PK	74.0	-28.4	1.58 H	157	31.6	14.0
6	#10480.00	34.8 AV	54.0	-19.2	1.58 H	157	20.8	14.0
7	15720.00	48.1 PK	74.0	-25.9	1.91 H	207	34.6	13.5
8	15720.00	35.8 AV	54.0	-18.2	1.91 H	207	22.3	13.5

**ANTENNA POLARITY & TEST DISTANCE: VERTICAL AT 3 M**

NO.	FREQ. (MHz)	EMISSION LEVEL (dBuV/m)	LIMIT (dBuV/m)	MARGIN (dB)	ANTENNA HEIGHT (m)	TABLE ANGLE (Degree)	RAW VALUE (dBuV)	CORRECTION FACTOR (dB/m)
1	*5240.00	110.9 PK			2.65 V	291	107.0	3.9
2	*5240.00	101.0 AV			2.65 V	291	97.1	3.9
3	5350.00	50.8 PK	74.0	-23.2	2.65 V	291	46.8	4.0
4	5350.00	38.1 AV	54.0	-15.9	2.65 V	291	34.1	4.0
5	#10480.00	45.0 PK	74.0	-29.0	1.60 V	345	31.0	14.0
6	#10480.00	34.3 AV	54.0	-19.7	1.60 V	345	20.3	14.0
7	15720.00	47.2 PK	74.0	-26.8	1.80 V	272	33.7	13.5
8	15720.00	35.1 AV	54.0	-18.9	1.80 V	272	21.6	13.5

**REMARKS:**

1. Emission Level(dBuV/m) = Raw Value(dBuV) + Correction Factor(dB/m)
2. Correction Factor(dB/m) = Antenna Factor(dB/m) + Cable Factor(dB) – Pre-Amplifier Factor(dB)
3. The other emission levels were very low against the limit.
4. Margin value = Emission Level – Limit value
5. " \* ": Fundamental frequency.
6. " # ": The radiated frequency is out of the restricted band.

<b>CHANNEL</b>	TX Channel 52	<b>DETECTOR FUNCTION</b>	Peak (PK)
<b>FREQUENCY RANGE</b>	1GHz ~ 40GHz		Average (AV)

**ANTENNA POLARITY & TEST DISTANCE: HORIZONTAL AT 3 M**

NO.	FREQ. (MHz)	EMISSION LEVEL (dBuV/m)	LIMIT (dBuV/m)	MARGIN (dB)	ANTENNA HEIGHT (m)	TABLE ANGLE (Degree)	RAW VALUE (dBuV)	CORRECTION FACTOR (dB/m)
1	5150.00	48.5 PK	74.0	-25.5	2.70 H	97	44.2	4.3
2	5150.00	37.4 AV	54.0	-16.6	2.70 H	97	33.1	4.3
3	*5260.00	107.9 PK			2.70 H	97	104.1	3.8
4	*5260.00	97.8 AV			2.70 H	97	94.0	3.8
5	#10520.00	45.8 PK	74.0	-28.2	1.65 H	151	31.8	14.0
6	#10520.00	35.0 AV	54.0	-19.0	1.65 H	151	21.0	14.0
7	15780.00	48.0 PK	74.0	-26.0	1.90 H	228	34.4	13.6
8	15780.00	36.0 AV	54.0	-18.0	1.90 H	228	22.4	13.6

**ANTENNA POLARITY & TEST DISTANCE: VERTICAL AT 3 M**

NO.	FREQ. (MHz)	EMISSION LEVEL (dBuV/m)	LIMIT (dBuV/m)	MARGIN (dB)	ANTENNA HEIGHT (m)	TABLE ANGLE (Degree)	RAW VALUE (dBuV)	CORRECTION FACTOR (dB/m)
1	5150.00	48.6 PK	74.0	-25.4	2.64 V	291	44.3	4.3
2	5150.00	37.5 AV	54.0	-16.5	2.64 V	291	33.2	4.3
3	*5260.00	112.3 PK			2.64 V	291	108.5	3.8
4	*5260.00	102.4 AV			2.64 V	291	98.6	3.8
5	#10520.00	45.1 PK	74.0	-28.9	1.71 V	340	31.1	14.0
6	#10520.00	34.3 AV	54.0	-19.7	1.71 V	340	20.3	14.0
7	15780.00	47.4 PK	74.0	-26.6	1.74 V	252	33.8	13.6
8	15780.00	35.4 AV	54.0	-18.6	1.74 V	252	21.8	13.6

**REMARKS:**

1. Emission Level(dBuV/m) = Raw Value(dBuV) + Correction Factor(dB/m)
2. Correction Factor(dB/m) = Antenna Factor(dB/m) + Cable Factor(dB) – Pre-Amplifier Factor(dB)
3. The other emission levels were very low against the limit.
4. Margin value = Emission Level – Limit value
5. " \* ": Fundamental frequency.
6. " # ": The radiated frequency is out of the restricted band.

<b>CHANNEL</b>	TX Channel 60	<b>DETECTOR FUNCTION</b>	Peak (PK)
<b>FREQUENCY RANGE</b>	1GHz ~ 40GHz		Average (AV)

**ANTENNA POLARITY & TEST DISTANCE: HORIZONTAL AT 3 M**

NO.	FREQ. (MHz)	EMISSION LEVEL (dBuV/m)	LIMIT (dBuV/m)	MARGIN (dB)	ANTENNA HEIGHT (m)	TABLE ANGLE (Degree)	RAW VALUE (dBuV)	CORRECTION FACTOR (dB/m)
1	*5300.00	107.7 PK			2.73 H	111	103.8	3.9
2	*5300.00	97.7 AV			2.73 H	111	93.8	3.9
3	10600.00	46.0 PK	74.0	-28.0	1.69 H	166	32.6	13.4
4	10600.00	35.0 AV	54.0	-19.0	1.69 H	166	21.6	13.4
5	15900.00	48.0 PK	74.0	-26.0	1.83 H	209	35.5	12.5
6	15900.00	35.6 AV	54.0	-18.4	1.83 H	209	23.1	12.5

**ANTENNA POLARITY & TEST DISTANCE: VERTICAL AT 3 M**

NO.	FREQ. (MHz)	EMISSION LEVEL (dBuV/m)	LIMIT (dBuV/m)	MARGIN (dB)	ANTENNA HEIGHT (m)	TABLE ANGLE (Degree)	RAW VALUE (dBuV)	CORRECTION FACTOR (dB/m)
1	*5300.00	112.1 PK			2.68 V	295	108.2	3.9
2	*5300.00	102.3 AV			2.68 V	295	98.4	3.9
3	10600.00	45.3 PK	74.0	-28.7	1.61 V	346	31.9	13.4
4	10600.00	34.6 AV	54.0	-19.4	1.61 V	346	21.2	13.4
5	15900.00	47.4 PK	74.0	-26.6	1.78 V	246	34.9	12.5
6	15900.00	35.5 AV	54.0	-18.5	1.78 V	246	23.0	12.5

**REMARKS:**

1. Emission Level(dBuV/m) = Raw Value(dBuV) + Correction Factor(dB/m)
2. Correction Factor(dB/m) = Antenna Factor(dB/m) + Cable Factor(dB) – Pre-Amplifier Factor(dB)
3. The other emission levels were very low against the limit.
4. Margin value = Emission Level – Limit value
5. " \* ": Fundamental frequency.

<b>CHANNEL</b>	TX Channel 64	<b>DETECTOR FUNCTION</b>	Peak (PK)
<b>FREQUENCY RANGE</b>	1GHz ~ 40GHz		Average (AV)

**ANTENNA POLARITY & TEST DISTANCE: HORIZONTAL AT 3 M**

NO.	FREQ. (MHz)	EMISSION LEVEL (dBuV/m)	LIMIT (dBuV/m)	MARGIN (dB)	ANTENNA HEIGHT (m)	TABLE ANGLE (Degree)	RAW VALUE (dBuV)	CORRECTION FACTOR (dB/m)
1	*5320.00	107.4 PK			2.72 H	122	103.5	3.9
2	*5320.00	97.2 AV			2.72 H	122	93.3	3.9
3	5350.00	63.9 PK	74.0	-10.1	2.72 H	122	59.9	4.0
4	5350.00	47.9 AV	54.0	-6.1	2.72 H	122	43.9	4.0
5	10640.00	45.6 PK	74.0	-28.4	1.63 H	163	32.0	13.6
6	10640.00	34.6 AV	54.0	-19.4	1.63 H	163	21.0	13.6
7	15960.00	47.5 PK	74.0	-26.5	1.88 H	215	34.6	12.9
8	15960.00	35.6 AV	54.0	-18.4	1.88 H	215	22.7	12.9

**ANTENNA POLARITY & TEST DISTANCE: VERTICAL AT 3 M**

NO.	FREQ. (MHz)	EMISSION LEVEL (dBuV/m)	LIMIT (dBuV/m)	MARGIN (dB)	ANTENNA HEIGHT (m)	TABLE ANGLE (Degree)	RAW VALUE (dBuV)	CORRECTION FACTOR (dB/m)
1	*5320.00	111.8 PK			2.63 V	297	107.9	3.9
2	*5320.00	101.8 AV			2.63 V	297	97.9	3.9
3	5350.00	67.3 PK	74.0	-6.7	2.63 V	297	63.3	4.0
4	5350.00	51.3 AV	54.0	-2.7	2.63 V	297	47.3	4.0
5	10640.00	45.8 PK	74.0	-28.2	1.67 V	360	32.2	13.6
6	10640.00	34.9 AV	54.0	-19.1	1.67 V	360	21.3	13.6
7	15960.00	47.1 PK	74.0	-26.9	1.71 V	254	34.2	12.9
8	15960.00	35.4 AV	54.0	-18.6	1.71 V	254	22.5	12.9

**REMARKS:**

1. Emission Level(dBuV/m) = Raw Value(dBuV) + Correction Factor(dB/m)
2. Correction Factor(dB/m) = Antenna Factor(dB/m) + Cable Factor(dB) – Pre-Amplifier Factor(dB)
3. The other emission levels were very low against the limit.
4. Margin value = Emission Level – Limit value
5. " \* ": Fundamental frequency.



<b>CHANNEL</b>	TX Channel 100	<b>DETECTOR FUNCTION</b>	Peak (PK)
<b>FREQUENCY RANGE</b>	1GHz ~ 40GHz		Average (AV)

**ANTENNA POLARITY & TEST DISTANCE: HORIZONTAL AT 3 M**

NO.	FREQ. (MHz)	EMISSION LEVEL (dBuV/m)	LIMIT (dBuV/m)	MARGIN (dB)	ANTENNA HEIGHT (m)	TABLE ANGLE (Degree)	RAW VALUE (dBuV)	CORRECTION FACTOR (dB/m)
1	#5470.00	65.5 PK	74.0	-8.5	2.78 H	133	61.2	4.3
2	#5470.00	43.3 AV	54.0	-10.7	2.78 H	133	39.0	4.3
3	*5500.00	106.7 PK			2.78 H	133	102.4	4.3
4	*5500.00	96.6 AV			2.78 H	133	92.3	4.3
5	11000.00	45.9 PK	74.0	-28.1	1.58 H	174	32.0	13.9
6	11000.00	34.8 AV	54.0	-19.2	1.58 H	174	20.9	13.9
7	#16500.00	46.9 PK	74.0	-27.1	1.85 H	209	31.3	15.6
8	#16500.00	35.2 AV	54.0	-18.8	1.85 H	209	19.6	15.6

**ANTENNA POLARITY & TEST DISTANCE: VERTICAL AT 3 M**

NO.	FREQ. (MHz)	EMISSION LEVEL (dBuV/m)	LIMIT (dBuV/m)	MARGIN (dB)	ANTENNA HEIGHT (m)	TABLE ANGLE (Degree)	RAW VALUE (dBuV)	CORRECTION FACTOR (dB/m)
1	#5470.00	68.9 PK	74.0	-5.1	2.64 V	291	64.6	4.3
2	#5470.00	46.7 AV	54.0	-7.3	2.64 V	291	42.4	4.3
3	*5500.00	111.1 PK			2.64 V	291	106.8	4.3
4	*5500.00	101.2 AV			2.64 V	291	96.9	4.3
5	11000.00	45.2 PK	74.0	-28.8	1.63 V	360	31.3	13.9
6	11000.00	34.5 AV	54.0	-19.5	1.63 V	360	20.6	13.9
7	#16500.00	47.4 PK	74.0	-26.6	1.71 V	273	31.8	15.6
8	#16500.00	35.4 AV	54.0	-18.6	1.71 V	273	19.8	15.6

**REMARKS:**

1. Emission Level(dBuV/m) = Raw Value(dBuV) + Correction Factor(dB/m)
2. Correction Factor(dB/m) = Antenna Factor(dB/m) + Cable Factor(dB) – Pre-Amplifier Factor(dB)
3. The other emission levels were very low against the limit.
4. Margin value = Emission Level – Limit value
5. " \* ": Fundamental frequency.
6. " # ": The radiated frequency is out of the restricted band.

<b>CHANNEL</b>	TX Channel 116	<b>DETECTOR FUNCTION</b>	Peak (PK)
<b>FREQUENCY RANGE</b>	1GHz ~ 40GHz		Average (AV)

**ANTENNA POLARITY & TEST DISTANCE: HORIZONTAL AT 3 M**

NO.	FREQ. (MHz)	EMISSION LEVEL (dBuV/m)	LIMIT (dBuV/m)	MARGIN (dB)	ANTENNA HEIGHT (m)	TABLE ANGLE (Degree)	RAW VALUE (dBuV)	CORRECTION FACTOR (dB/m)
1	*5580.00	106.1 PK			2.75 H	130	101.7	4.4
2	*5580.00	96.2 AV			2.75 H	130	91.8	4.4
3	11160.00	45.2 PK	74.0	-28.8	1.61 H	150	31.5	13.7
4	11160.00	34.1 AV	54.0	-19.9	1.61 H	150	20.4	13.7
5	#16740.00	47.8 PK	74.0	-26.2	1.86 H	207	31.2	16.6
6	#16740.00	36.1 AV	54.0	-17.9	1.86 H	207	19.5	16.6

**ANTENNA POLARITY & TEST DISTANCE: VERTICAL AT 3 M**

NO.	FREQ. (MHz)	EMISSION LEVEL (dBuV/m)	LIMIT (dBuV/m)	MARGIN (dB)	ANTENNA HEIGHT (m)	TABLE ANGLE (Degree)	RAW VALUE (dBuV)	CORRECTION FACTOR (dB/m)
1	*5580.00	110.5 PK			2.68 V	295	106.1	4.4
2	*5580.00	100.8 AV			2.68 V	295	96.4	4.4
3	11160.00	44.9 PK	74.0	-29.1	1.71 V	354	31.2	13.7
4	11160.00	34.3 AV	54.0	-19.7	1.71 V	354	20.6	13.7
5	#16740.00	46.9 PK	74.0	-27.1	1.75 V	246	30.3	16.6
6	#16740.00	35.3 AV	54.0	-18.7	1.75 V	246	18.7	16.6

**REMARKS:**

1. Emission Level(dBuV/m) = Raw Value(dBuV) + Correction Factor(dB/m)
2. Correction Factor(dB/m) = Antenna Factor(dB/m) + Cable Factor(dB) – Pre-Amplifier Factor(dB)
3. The other emission levels were very low against the limit.
4. Margin value = Emission Level – Limit value
5. " \* ": Fundamental frequency.
6. " # ": The radiated frequency is out of the restricted band.

<b>CHANNEL</b>	TX Channel 140	<b>DETECTOR FUNCTION</b>	Peak (PK)
<b>FREQUENCY RANGE</b>	1GHz ~ 40GHz		Average (AV)

**ANTENNA POLARITY & TEST DISTANCE: HORIZONTAL AT 3 M**

NO.	FREQ. (MHz)	EMISSION LEVEL (dBuV/m)	LIMIT (dBuV/m)	MARGIN (dB)	ANTENNA HEIGHT (m)	TABLE ANGLE (Degree)	RAW VALUE (dBuV)	CORRECTION FACTOR (dB/m)
1	*5700.00	107.0 PK			2.71 H	139	102.5	4.5
2	*5700.00	96.9 AV			2.71 H	139	92.4	4.5
3	#5725.00	65.8 PK	74.0	-8.2	2.71 H	139	61.3	4.5
4	#5725.00	47.7 AV	54.0	-6.3	2.71 H	139	43.2	4.5
5	11400.00	47.0 PK	74.0	-27.0	1.54 H	124	32.5	14.5
6	11400.00	35.1 AV	54.0	-18.9	1.54 H	124	20.6	14.5
7	#17100.00	50.9 PK	74.0	-23.1	1.65 H	229	33.6	17.3
8	#17100.00	39.2 AV	54.0	-14.8	1.65 H	229	21.9	17.3

**ANTENNA POLARITY & TEST DISTANCE: VERTICAL AT 3 M**

NO.	FREQ. (MHz)	EMISSION LEVEL (dBuV/m)	LIMIT (dBuV/m)	MARGIN (dB)	ANTENNA HEIGHT (m)	TABLE ANGLE (Degree)	RAW VALUE (dBuV)	CORRECTION FACTOR (dB/m)
1	*5700.00	111.4 PK			2.57 V	306	106.9	4.5
2	*5700.00	101.5 AV			2.57 V	306	97.0	4.5
3	#5725.00	69.2 PK	74.0	-4.8	2.75 V	306	64.7	4.5
4	#5725.00	51.1 AV	54.0	-2.9	2.75 V	306	46.6	4.5
5	11400.00	47.9 PK	74.0	-26.1	1.65 V	280	33.4	14.5
6	11400.00	35.6 AV	54.0	-18.4	1.65 V	280	21.1	14.5
7	#17100.00	50.8 PK	74.0	-23.2	2.00 V	155	33.5	17.3
8	#17100.00	38.5 AV	54.0	-15.5	2.00 V	155	21.2	17.3

**REMARKS:**

1. Emission Level(dBuV/m) = Raw Value(dBuV) + Correction Factor(dB/m)
2. Correction Factor(dB/m) = Antenna Factor(dB/m) + Cable Factor(dB) – Pre-Amplifier Factor(dB)
3. The other emission levels were very low against the limit.
4. Margin value = Emission Level – Limit value
5. " \* ": Fundamental frequency.
6. " # ": The radiated frequency is out of the restricted band.

<b>CHANNEL</b>	TX Channel 144	<b>DETECTOR FUNCTION</b>	Peak (PK)
<b>FREQUENCY RANGE</b>	1GHz ~ 40GHz		Average (AV)

**ANTENNA POLARITY & TEST DISTANCE: HORIZONTAL AT 3 M**

NO.	FREQ. (MHz)	EMISSION LEVEL (dBuV/m)	LIMIT (dBuV/m)	MARGIN (dB)	ANTENNA HEIGHT (m)	TABLE ANGLE (Degree)	RAW VALUE (dBuV)	CORRECTION FACTOR (dB/m)
1	#5470.00	49.5 PK	74.0	-24.5	2.73 H	134	45.2	4.3
2	#5470.00	37.4 AV	54.0	-16.6	2.73 H	134	33.1	4.3
3	*5720.00	108.0 PK			2.73 H	134	103.5	4.5
4	*5720.00	97.5 AV			2.73 H	134	93.0	4.5
5	#5850.00	50.9 PK	74.0	-23.1	2.73 H	134	46.1	4.8
6	#5850.00	37.8 AV	54.0	-16.2	2.73 H	134	33.0	4.8
7	11440.00	46.5 PK	74.0	-27.5	1.61 H	129	32.3	14.2
8	11440.00	34.8 AV	54.0	-19.2	1.61 H	129	20.6	14.2
9	#17160.00	50.7 PK	74.0	-23.3	1.68 H	203	33.8	16.9
10	#17160.00	39.0 AV	54.0	-15.0	1.68 H	203	22.1	16.9

**ANTENNA POLARITY & TEST DISTANCE: VERTICAL AT 3 M**

NO.	FREQ. (MHz)	EMISSION LEVEL (dBuV/m)	LIMIT (dBuV/m)	MARGIN (dB)	ANTENNA HEIGHT (m)	TABLE ANGLE (Degree)	RAW VALUE (dBuV)	CORRECTION FACTOR (dB/m)
1	#5470.00	49.6 PK	74.0	-24.4	2.87 V	305	45.3	4.3
2	#5470.00	37.5 AV	54.0	-16.5	2.87 V	305	33.2	4.3
3	*5720.00	112.4 PK			2.87 V	305	107.9	4.5
4	*5720.00	102.1 AV			2.87 V	305	97.6	4.5
5	#5850.00	51.2 PK	74.0	-22.8	2.87 V	305	46.4	4.8
6	#5850.00	38.9 AV	54.0	-15.1	2.87 V	305	34.1	4.8
7	11440.00	47.4 PK	74.0	-26.6	1.60 V	297	33.2	14.2
8	11440.00	35.4 AV	54.0	-18.6	1.60 V	297	21.2	14.2
9	#17160.00	50.6 PK	74.0	-23.4	1.96 V	168	33.7	16.9
10	#17160.00	38.5 AV	54.0	-15.5	1.96 V	168	21.6	16.9

**REMARKS:**

- Emission Level(dBuV/m) = Raw Value(dBuV) + Correction Factor(dB/m)
- Correction Factor(dB/m) = Antenna Factor(dB/m) + Cable Factor(dB) – Pre-Amplifier Factor(dB)
- The other emission levels were very low against the limit.
- Margin value = Emission Level – Limit value
- " \* ": Fundamental frequency.
- " # ": The radiated frequency is out of the restricted band.

<b>CHANNEL</b>	TX Channel 149	<b>DETECTOR FUNCTION</b>	Peak (PK)
<b>FREQUENCY RANGE</b>	1GHz ~ 40GHz		Average (AV)

**ANTENNA POLARITY & TEST DISTANCE: HORIZONTAL AT 3 M**

NO.	FREQ. (MHz)	EMISSION LEVEL (dBuV/m)	LIMIT (dBuV/m)	MARGIN (dB)	ANTENNA HEIGHT (m)	TABLE ANGLE (Degree)	RAW VALUE (dBuV)	CORRECTION FACTOR (dB/m)
1	*5745.00	105.5 PK			2.63 H	130	100.9	4.6
2	*5745.00	97.1 AV			2.63 H	130	92.5	4.6
3	11490.00	46.8 PK	74.0	-27.2	1.60 H	107	32.7	14.1
4	11490.00	34.9 AV	54.0	-19.1	1.60 H	107	20.8	14.1
5	#17235.00	50.5 PK	74.0	-23.5	1.71 H	201	33.6	16.9
6	#17235.00	38.6 AV	54.0	-15.4	1.71 H	201	21.7	16.9

**ANTENNA POLARITY & TEST DISTANCE: VERTICAL AT 3 M**

NO.	FREQ. (MHz)	EMISSION LEVEL (dBuV/m)	LIMIT (dBuV/m)	MARGIN (dB)	ANTENNA HEIGHT (m)	TABLE ANGLE (Degree)	RAW VALUE (dBuV)	CORRECTION FACTOR (dB/m)
1	*5745.00	110.3 PK			2.61 V	56	105.7	4.6
2	*5745.00	101.3 AV			2.61 V	56	96.7	4.6
3	11490.00	47.4 PK	74.0	-26.6	1.70 V	271	33.3	14.1
4	11490.00	35.5 AV	54.0	-18.5	1.70 V	271	21.4	14.1
5	#17235.00	51.2 PK	74.0	-22.8	1.94 V	145	34.3	16.9
6	#17235.00	39.1 AV	54.0	-14.9	1.94 V	145	22.2	16.9

**REMARKS:**

1. Emission Level(dBuV/m) = Raw Value(dBuV) + Correction Factor(dB/m)
2. Correction Factor(dB/m) = Antenna Factor(dB/m) + Cable Factor(dB) – Pre-Amplifier Factor(dB)
3. The other emission levels were very low against the limit.
4. Margin value = Emission Level – Limit value
5. " \* ": Fundamental frequency.
6. " # ": The radiated frequency is out of the restricted band.

<b>CHANNEL</b>	TX Channel 157	<b>DETECTOR FUNCTION</b>	Peak (PK)
<b>FREQUENCY RANGE</b>	1GHz ~ 40GHz		Average (AV)

**ANTENNA POLARITY & TEST DISTANCE: HORIZONTAL AT 3 M**

NO.	FREQ. (MHz)	EMISSION LEVEL (dBuV/m)	LIMIT (dBuV/m)	MARGIN (dB)	ANTENNA HEIGHT (m)	TABLE ANGLE (Degree)	RAW VALUE (dBuV)	CORRECTION FACTOR (dB/m)
1	*5785.00	105.2 PK			2.67 H	131	100.6	4.6
2	*5785.00	96.8 AV			2.67 H	131	92.2	4.6
3	11570.00	46.1 PK	74.0	-27.9	1.65 H	125	32.0	14.1
4	11570.00	34.4 AV	54.0	-19.6	1.65 H	125	20.3	14.1
5	#17355.00	50.0 PK	74.0	-24.0	1.60 H	218	32.2	17.8
6	#17355.00	38.5 AV	54.0	-15.5	1.60 H	218	20.7	17.8

**ANTENNA POLARITY & TEST DISTANCE: VERTICAL AT 3 M**

NO.	FREQ. (MHz)	EMISSION LEVEL (dBuV/m)	LIMIT (dBuV/m)	MARGIN (dB)	ANTENNA HEIGHT (m)	TABLE ANGLE (Degree)	RAW VALUE (dBuV)	CORRECTION FACTOR (dB/m)
1	*5785.00	110.1 PK			2.60 V	59	105.5	4.6
2	*5785.00	101.1 AV			2.60 V	59	96.5	4.6
3	11570.00	47.6 PK	74.0	-26.4	1.63 V	293	33.5	14.1
4	11570.00	35.5 AV	54.0	-18.5	1.63 V	293	21.4	14.1
5	#17355.00	51.0 PK	74.0	-23.0	2.03 V	166	33.2	17.8
6	#17355.00	38.7 AV	54.0	-15.3	2.03 V	166	20.9	17.8

**REMARKS:**

1. Emission Level(dBuV/m) = Raw Value(dBuV) + Correction Factor(dB/m)
2. Correction Factor(dB/m) = Antenna Factor(dB/m) + Cable Factor(dB) – Pre-Amplifier Factor(dB)
3. The other emission levels were very low against the limit.
4. Margin value = Emission Level – Limit value
5. " \* ": Fundamental frequency.
6. " # ": The radiated frequency is out of the restricted band.

<b>CHANNEL</b>	TX Channel 165	<b>DETECTOR FUNCTION</b>	Peak (PK)
<b>FREQUENCY RANGE</b>	1GHz ~ 40GHz		Average (AV)

**ANTENNA POLARITY & TEST DISTANCE: HORIZONTAL AT 3 M**

NO.	FREQ. (MHz)	EMISSION LEVEL (dBuV/m)	LIMIT (dBuV/m)	MARGIN (dB)	ANTENNA HEIGHT (m)	TABLE ANGLE (Degree)	RAW VALUE (dBuV)	CORRECTION FACTOR (dB/m)
1	*5825.00	104.1 PK			2.71 H	128	99.3	4.8
2	*5825.00	95.8 AV			2.71 H	128	91.0	4.8
3	11650.00	46.2 PK	74.0	-27.8	1.60 H	132	32.2	14.0
4	11650.00	34.6 AV	54.0	-19.4	1.60 H	132	20.6	14.0
5	#17475.00	50.5 PK	74.0	-23.5	1.64 H	220	31.5	19.0
6	#17475.00	39.0 AV	54.0	-15.0	1.64 H	220	20.0	19.0

**ANTENNA POLARITY & TEST DISTANCE: VERTICAL AT 3 M**

NO.	FREQ. (MHz)	EMISSION LEVEL (dBuV/m)	LIMIT (dBuV/m)	MARGIN (dB)	ANTENNA HEIGHT (m)	TABLE ANGLE (Degree)	RAW VALUE (dBuV)	CORRECTION FACTOR (dB/m)
1	*5825.00	108.6 PK			2.59 V	60	103.8	4.8
2	*5825.00	100.0 AV			2.59 V	60	95.2	4.8
3	11650.00	46.8 PK	74.0	-27.2	1.72 V	300	32.8	14.0
4	11650.00	34.9 AV	54.0	-19.1	1.72 V	300	20.9	14.0
5	#17475.00	50.9 PK	74.0	-23.1	2.04 V	163	31.9	19.0
6	#17475.00	38.6 AV	54.0	-15.4	2.04 V	163	19.6	19.0

**REMARKS:**

1. Emission Level(dBuV/m) = Raw Value(dBuV) + Correction Factor(dB/m)
2. Correction Factor(dB/m) = Antenna Factor(dB/m) + Cable Factor(dB) – Pre-Amplifier Factor(dB)
3. The other emission levels were very low against the limit.
4. Margin value = Emission Level – Limit value
5. " \* ": Fundamental frequency.
6. " # ": The radiated frequency is out of the restricted band.

**802.11ac (VHT40)**

<b>CHANNEL</b>	TX Channel 38	<b>DETECTOR FUNCTION</b>	Peak (PK)
<b>FREQUENCY RANGE</b>	1GHz ~ 40GHz		Average (AV)

**ANTENNA POLARITY & TEST DISTANCE: HORIZONTAL AT 3 M**

NO.	FREQ. (MHz)	EMISSION LEVEL (dBuV/m)	LIMIT (dBuV/m)	MARGIN (dB)	ANTENNA HEIGHT (m)	TABLE ANGLE (Degree)	RAW VALUE (dBuV)	CORRECTION FACTOR (dB/m)
1	5150.00	66.8 PK	74.0	-7.2	2.72 H	127	62.5	4.3
2	5150.00	48.2 AV	54.0	-5.8	2.72 H	127	43.9	4.3
3	*5190.00	101.9 PK			2.72 H	127	97.8	4.1
4	*5190.00	92.6 AV			2.72 H	127	88.5	4.1
5	5350.00	51.8 PK	74.0	-22.2	2.72 H	127	47.8	4.0
6	5350.00	37.9 AV	54.0	-16.1	2.72 H	127	33.9	4.0
7	#10380.00	46.4 PK	74.0	-27.6	1.70 H	168	33.0	13.4
8	#10380.00	35.5 AV	54.0	-18.5	1.70 H	168	22.1	13.4
9	15570.00	48.7 PK	74.0	-25.3	1.82 H	215	35.7	13.0
10	15570.00	36.1 AV	54.0	-17.9	1.82 H	215	23.1	13.0

**ANTENNA POLARITY & TEST DISTANCE: VERTICAL AT 3 M**

NO.	FREQ. (MHz)	EMISSION LEVEL (dBuV/m)	LIMIT (dBuV/m)	MARGIN (dB)	ANTENNA HEIGHT (m)	TABLE ANGLE (Degree)	RAW VALUE (dBuV)	CORRECTION FACTOR (dB/m)
1	5150.00	70.2 PK	74.0	-3.8	2.64 V	286	65.9	4.3
2	<b>5150.00</b>	<b>51.6 AV</b>	<b>54.0</b>	<b>-2.4</b>	<b>2.64 V</b>	<b>286</b>	<b>47.3</b>	<b>4.3</b>
3	*5190.00	106.3 PK			2.64 V	286	102.2	4.1
4	*5190.00	97.2 AV			2.64 V	286	93.1	4.1
5	5350.00	52.7 PK	74.0	-21.3	2.64 V	286	48.7	4.0
6	5350.00	38.7 AV	54.0	-15.3	2.64 V	286	34.7	4.0
7	#10380.00	44.7 PK	74.0	-29.3	1.77 V	357	31.3	13.4
8	#10380.00	34.4 AV	54.0	-19.6	1.77 V	357	21.0	13.4
9	15570.00	47.1 PK	74.0	-26.9	1.87 V	273	34.1	13.0
10	15570.00	35.2 AV	54.0	-18.8	1.87 V	273	22.2	13.0

**REMARKS:**

- Emission Level(dBuV/m) = Raw Value(dBuV) + Correction Factor(dB/m)
- Correction Factor(dB/m) = Antenna Factor(dB/m) + Cable Factor(dB) – Pre-Amplifier Factor(dB)
- The other emission levels were very low against the limit.
- Margin value = Emission Level – Limit value
- " \* ": Fundamental frequency.
- " # ": The radiated frequency is out of the restricted band.



<b>CHANNEL</b>	TX Channel 46	<b>DETECTOR FUNCTION</b>	Peak (PK)
<b>FREQUENCY RANGE</b>	1GHz ~ 40GHz		Average (AV)

**ANTENNA POLARITY & TEST DISTANCE: HORIZONTAL AT 3 M**

NO.	FREQ. (MHz)	EMISSION LEVEL (dBuV/m)	LIMIT (dBuV/m)	MARGIN (dB)	ANTENNA HEIGHT (m)	TABLE ANGLE (Degree)	RAW VALUE (dBuV)	CORRECTION FACTOR (dB/m)
1	5150.00	58.1 PK	74.0	-15.9	2.72 H	123	53.8	4.3
2	5150.00	43.9 AV	54.0	-10.1	2.72 H	123	39.6	4.3
3	*5230.00	106.5 PK			2.72 H	123	102.6	3.9
4	*5230.00	96.2 AV			2.72 H	123	92.3	3.9
5	5350.00	52.8 PK	74.0	-21.2	2.72 H	123	48.8	4.0
6	5350.00	38.4 AV	54.0	-15.6	2.72 H	123	34.4	4.0
7	#10460.00	46.2 PK	74.0	-27.8	1.73 H	158	32.3	13.9
8	#10460.00	35.4 AV	54.0	-18.6	1.73 H	158	21.5	13.9
9	15690.00	47.9 PK	74.0	-26.1	1.82 H	207	34.3	13.6
10	15690.00	35.7 AV	54.0	-18.3	1.82 H	207	22.1	13.6

**ANTENNA POLARITY & TEST DISTANCE: VERTICAL AT 3 M**

NO.	FREQ. (MHz)	EMISSION LEVEL (dBuV/m)	LIMIT (dBuV/m)	MARGIN (dB)	ANTENNA HEIGHT (m)	TABLE ANGLE (Degree)	RAW VALUE (dBuV)	CORRECTION FACTOR (dB/m)
1	5150.00	61.5 PK	74.0	-12.5	2.65 V	293	57.2	4.3
2	5150.00	47.3 AV	54.0	-6.7	2.65 V	293	43.0	4.3
3	*5230.00	110.9 PK			2.65 V	293	107.0	3.9
4	*5230.00	100.8 AV			2.65 V	293	96.9	3.9
5	5350.00	56.2 PK	74.0	-17.8	2.65 V	293	52.2	4.0
6	5350.00	41.8 AV	54.0	-12.2	2.65 V	293	37.8	4.0
7	#10460.00	44.9 PK	74.0	-29.1	1.77 V	348	31.0	13.9
8	#10460.00	34.4 AV	54.0	-19.6	1.77 V	348	20.5	13.9
9	15690.00	46.9 PK	74.0	-27.1	1.86 V	268	33.3	13.6
10	15690.00	34.8 AV	54.0	-19.2	1.86 V	268	21.2	13.6

**REMARKS:**

1. Emission Level(dBuV/m) = Raw Value(dBuV) + Correction Factor(dB/m)
2. Correction Factor(dB/m) = Antenna Factor(dB/m) + Cable Factor(dB) – Pre-Amplifier Factor(dB)
3. The other emission levels were very low against the limit.
4. Margin value = Emission Level – Limit value
5. " \* ": Fundamental frequency.
6. " # ": The radiated frequency is out of the restricted band.

<b>CHANNEL</b>	TX Channel 54	<b>DETECTOR FUNCTION</b>	Peak (PK)
<b>FREQUENCY RANGE</b>	1GHz ~ 40GHz		Average (AV)

**ANTENNA POLARITY & TEST DISTANCE: HORIZONTAL AT 3 M**

NO.	FREQ. (MHz)	EMISSION LEVEL (dBuV/m)	LIMIT (dBuV/m)	MARGIN (dB)	ANTENNA HEIGHT (m)	TABLE ANGLE (Degree)	RAW VALUE (dBuV)	CORRECTION FACTOR (dB/m)
1	5150.00	51.8 PK	74.0	-22.2	2.73 H	111	47.5	4.3
2	5150.00	37.6 AV	54.0	-16.4	2.73 H	111	33.3	4.3
3	*5270.00	105.0 PK			2.73 H	111	101.2	3.8
4	*5270.00	95.4 AV			2.73 H	111	91.6	3.8
5	#10540.00	46.0 PK	74.0	-28.0	1.74 H	156	32.2	13.8
6	#10540.00	35.3 AV	54.0	-18.7	1.74 H	156	21.5	13.8
7	15810.00	48.3 PK	74.0	-25.7	1.84 H	197	34.9	13.4
8	15810.00	35.8 AV	54.0	-18.2	1.84 H	197	22.4	13.4

**ANTENNA POLARITY & TEST DISTANCE: VERTICAL AT 3 M**

NO.	FREQ. (MHz)	EMISSION LEVEL (dBuV/m)	LIMIT (dBuV/m)	MARGIN (dB)	ANTENNA HEIGHT (m)	TABLE ANGLE (Degree)	RAW VALUE (dBuV)	CORRECTION FACTOR (dB/m)
1	5150.00	53.3 PK	74.0	-20.7	2.70 V	291	49.0	4.3
2	5150.00	39.4 AV	54.0	-14.6	2.70 V	291	35.1	4.3
3	*5270.00	109.4 PK			2.70 V	291	105.6	3.8
4	*5270.00	100.0 AV			2.70 V	291	96.2	3.8
5	#10540.00	45.4 PK	74.0	-28.6	1.70 V	360	31.6	13.8
6	#10540.00	34.6 AV	54.0	-19.4	1.70 V	360	20.8	13.8
7	15810.00	46.7 PK	74.0	-27.3	1.81 V	251	33.3	13.4
8	15810.00	34.8 AV	54.0	-19.2	1.81 V	251	21.4	13.4

**REMARKS:**

1. Emission Level(dBuV/m) = Raw Value(dBuV) + Correction Factor(dB/m)
2. Correction Factor(dB/m) = Antenna Factor(dB/m) + Cable Factor(dB) – Pre-Amplifier Factor(dB)
3. The other emission levels were very low against the limit.
4. Margin value = Emission Level – Limit value
5. " \* ": Fundamental frequency.
6. " # ": The radiated frequency is out of the restricted band.

<b>CHANNEL</b>	TX Channel 62	<b>DETECTOR FUNCTION</b>	Peak (PK)
<b>FREQUENCY RANGE</b>	1GHz ~ 40GHz		Average (AV)

**ANTENNA POLARITY & TEST DISTANCE: HORIZONTAL AT 3 M**

NO.	FREQ. (MHz)	EMISSION LEVEL (dBuV/m)	LIMIT (dBuV/m)	MARGIN (dB)	ANTENNA HEIGHT (m)	TABLE ANGLE (Degree)	RAW VALUE (dBuV)	CORRECTION FACTOR (dB/m)
1	*5310.00	101.6 PK			2.73 H	116	97.7	3.9
2	*5310.00	91.6 AV			2.73 H	116	87.7	3.9
3	5350.00	65.2 PK	74.0	-8.8	2.73 H	116	61.2	4.0
4	5350.00	48.1 AV	54.0	-5.9	2.73 H	116	44.1	4.0
5	10620.00	46.3 PK	74.0	-27.7	1.69 H	169	32.8	13.5
6	10620.00	35.1 AV	54.0	-18.9	1.69 H	169	21.6	13.5
7	15930.00	47.4 PK	74.0	-26.6	1.84 H	220	34.7	12.7
8	15930.00	35.1 AV	54.0	-18.9	1.84 H	220	22.4	12.7

**ANTENNA POLARITY & TEST DISTANCE: VERTICAL AT 3 M**

NO.	FREQ. (MHz)	EMISSION LEVEL (dBuV/m)	LIMIT (dBuV/m)	MARGIN (dB)	ANTENNA HEIGHT (m)	TABLE ANGLE (Degree)	RAW VALUE (dBuV)	CORRECTION FACTOR (dB/m)
1	*5310.00	106.0 PK			2.57 V	294	102.1	3.9
2	*5310.00	96.2 AV			2.57 V	294	92.3	3.9
3	5350.00	68.6 PK	74.0	-5.4	2.57 V	294	64.6	4.0
4	5350.00	51.5 AV	54.0	-2.5	2.57 V	294	47.5	4.0
5	10620.00	45.1 PK	74.0	-28.9	1.69 V	359	31.6	13.5
6	10620.00	34.4 AV	54.0	-19.6	1.69 V	359	20.9	13.5
7	15930.00	47.5 PK	74.0	-26.5	1.86 V	276	34.8	12.7
8	15930.00	35.4 AV	54.0	-18.6	1.86 V	276	22.7	12.7

**REMARKS:**

1. Emission Level(dBuV/m) = Raw Value(dBuV) + Correction Factor(dB/m)
2. Correction Factor(dB/m) = Antenna Factor(dB/m) + Cable Factor(dB) – Pre-Amplifier Factor(dB)
3. The other emission levels were very low against the limit.
4. Margin value = Emission Level – Limit value
5. " \* ": Fundamental frequency.

<b>CHANNEL</b>	TX Channel 102	<b>DETECTOR FUNCTION</b>	Peak (PK)
<b>FREQUENCY RANGE</b>	1GHz ~ 40GHz		Average (AV)

**ANTENNA POLARITY & TEST DISTANCE: HORIZONTAL AT 3 M**

NO.	FREQ. (MHz)	EMISSION LEVEL (dBuV/m)	LIMIT (dBuV/m)	MARGIN (dB)	ANTENNA HEIGHT (m)	TABLE ANGLE (Degree)	RAW VALUE (dBuV)	CORRECTION FACTOR (dB/m)
1	#5470.00	66.6 PK	74.0	-7.4	2.77 H	114	62.3	4.3
2	#5470.00	48.1 AV	54.0	-5.9	2.77 H	114	43.8	4.3
3	*5510.00	101.8 PK			2.77 H	114	97.5	4.3
4	*5510.00	91.9 AV			2.77 H	114	87.6	4.3
5	11020.00	45.9 PK	74.0	-28.1	1.73 H	154	32.1	13.8
6	11020.00	35.0 AV	54.0	-19.0	1.73 H	154	21.2	13.8
7	#16530.00	48.3 PK	74.0	-25.7	1.85 H	197	32.5	15.8
8	#16530.00	35.7 AV	54.0	-18.3	1.85 H	197	19.9	15.8

**ANTENNA POLARITY & TEST DISTANCE: VERTICAL AT 3 M**

NO.	FREQ. (MHz)	EMISSION LEVEL (dBuV/m)	LIMIT (dBuV/m)	MARGIN (dB)	ANTENNA HEIGHT (m)	TABLE ANGLE (Degree)	RAW VALUE (dBuV)	CORRECTION FACTOR (dB/m)
1	#5470.00	70.0 PK	74.0	-4.0	2.59 V	294	65.7	4.3
2	#5470.00	51.5 AV	54.0	-2.5	2.59 V	294	47.2	4.3
3	*5510.00	106.2 PK			2.59 V	294	101.9	4.3
4	*5510.00	96.5 AV			2.59 V	294	92.2	4.3
5	11020.00	44.8 PK	74.0	-29.2	1.68 V	358	31.0	13.8
6	11020.00	34.4 AV	54.0	-19.6	1.68 V	358	20.6	13.8
7	#16530.00	47.6 PK	74.0	-26.4	1.88 V	263	31.8	15.8
8	#16530.00	35.7 AV	54.0	-18.3	1.88 V	263	19.9	15.8

**REMARKS:**

1. Emission Level(dBuV/m) = Raw Value(dBuV) + Correction Factor(dB/m)
2. Correction Factor(dB/m) = Antenna Factor(dB/m) + Cable Factor(dB) – Pre-Amplifier Factor(dB)
3. The other emission levels were very low against the limit.
4. Margin value = Emission Level – Limit value
5. " \* ": Fundamental frequency.
6. " # ": The radiated frequency is out of the restricted band.

<b>CHANNEL</b>	TX Channel 110	<b>DETECTOR FUNCTION</b>	Peak (PK)
<b>FREQUENCY RANGE</b>	1GHz ~ 40GHz		Average (AV)

**ANTENNA POLARITY & TEST DISTANCE: HORIZONTAL AT 3 M**

NO.	FREQ. (MHz)	EMISSION LEVEL (dBuV/m)	LIMIT (dBuV/m)	MARGIN (dB)	ANTENNA HEIGHT (m)	TABLE ANGLE (Degree)	RAW VALUE (dBuV)	CORRECTION FACTOR (dB/m)
1	#5470.00	57.9 PK	74.0	-16.1	2.72 H	129	53.6	4.3
2	#5470.00	39.8 AV	54.0	-14.2	2.72 H	129	35.5	4.3
3	*5550.00	103.4 PK			2.72 H	129	99.1	4.3
4	*5550.00	92.6 AV			2.72 H	129	88.3	4.3
5	#5725.00	50.4 PK	74.0	-23.6	2.72 H	129	45.9	4.5
6	#5725.00	37.8 AV	54.0	-16.2	2.72 H	129	33.3	4.5
7	11100.00	46.6 PK	74.0	-27.4	1.65 H	160	32.8	13.8
8	11100.00	35.3 AV	54.0	-18.7	1.65 H	160	21.5	13.8
9	#16650.00	47.4 PK	74.0	-26.6	1.87 H	221	30.9	16.5
10	#16650.00	35.2 AV	54.0	-18.8	1.87 H	221	18.7	16.5

**ANTENNA POLARITY & TEST DISTANCE: VERTICAL AT 3 M**

NO.	FREQ. (MHz)	EMISSION LEVEL (dBuV/m)	LIMIT (dBuV/m)	MARGIN (dB)	ANTENNA HEIGHT (m)	TABLE ANGLE (Degree)	RAW VALUE (dBuV)	CORRECTION FACTOR (dB/m)
1	#5470.00	61.3 PK	74.0	-12.7	2.56 V	296	57.0	4.3
2	#5470.00	43.2 AV	54.0	-10.8	2.56 V	296	38.9	4.3
3	*5550.00	107.8 PK			2.56 V	296	103.5	4.3
4	*5550.00	97.2 AV			2.56 V	296	92.9	4.3
5	#5725.00	51.5 PK	74.0	-22.5	2.56 V	296	47.0	4.5
6	#5725.00	38.8 AV	54.0	-15.2	2.56 V	296	34.3	4.5
7	11100.00	45.3 PK	74.0	-28.7	1.66 V	358	31.5	13.8
8	11100.00	34.7 AV	54.0	-19.3	1.66 V	358	20.9	13.8
9	#16650.00	47.0 PK	74.0	-27.0	1.83 V	263	30.5	16.5
10	#16650.00	35.1 AV	54.0	-18.9	1.83 V	263	18.6	16.5

**REMARKS:**

1. Emission Level(dBuV/m) = Raw Value(dBuV) + Correction Factor(dB/m)
2. Correction Factor(dB/m) = Antenna Factor(dB/m) + Cable Factor(dB) – Pre-Amplifier Factor(dB)
3. The other emission levels were very low against the limit.
4. Margin value = Emission Level – Limit value
5. " \* ": Fundamental frequency.
6. " # ": The radiated frequency is out of the restricted band.

<b>CHANNEL</b>	TX Channel 134	<b>DETECTOR FUNCTION</b>	Peak (PK)
<b>FREQUENCY RANGE</b>	1GHz ~ 40GHz		Average (AV)

**ANTENNA POLARITY & TEST DISTANCE: HORIZONTAL AT 3 M**

NO.	FREQ. (MHz)	EMISSION LEVEL (dBuV/m)	LIMIT (dBuV/m)	MARGIN (dB)	ANTENNA HEIGHT (m)	TABLE ANGLE (Degree)	RAW VALUE (dBuV)	CORRECTION FACTOR (dB/m)
1	*5670.00	103.3 PK			2.67 H	135	98.9	4.4
2	*5670.00	93.1 AV			2.67 H	135	88.7	4.4
3	#5725.00	61.8 PK	74.0	-12.2	2.67 H	135	57.3	4.5
4	#5725.00	45.6 AV	54.0	-8.4	2.67 H	135	41.1	4.5
5	11340.00	46.2 PK	74.0	-27.8	1.67 H	172	32.1	14.1
6	11340.00	35.1 AV	54.0	-18.9	1.67 H	172	21.0	14.1
7	#17010.00	48.1 PK	74.0	-25.9	1.88 H	216	30.6	17.5
8	#17010.00	35.7 AV	54.0	-18.3	1.88 H	216	18.2	17.5

**ANTENNA POLARITY & TEST DISTANCE: VERTICAL AT 3 M**

NO.	FREQ. (MHz)	EMISSION LEVEL (dBuV/m)	LIMIT (dBuV/m)	MARGIN (dB)	ANTENNA HEIGHT (m)	TABLE ANGLE (Degree)	RAW VALUE (dBuV)	CORRECTION FACTOR (dB/m)
1	*5670.00	107.7 PK			2.51 V	289	103.3	4.4
2	*5670.00	97.7 AV			2.51 V	289	93.3	4.4
3	#5725.00	65.2 PK	74.0	-8.8	2.51 V	289	60.7	4.5
4	#5725.00	49.0 AV	54.0	-5.0	2.51 V	289	44.5	4.5
5	11340.00	45.6 PK	74.0	-28.4	1.74 V	346	31.5	14.1
6	11340.00	35.2 AV	54.0	-18.8	1.74 V	346	21.1	14.1
7	#17010.00	46.9 PK	74.0	-27.1	1.84 V	276	29.4	17.5
8	#17010.00	34.8 AV	54.0	-19.2	1.84 V	276	17.3	17.5

**REMARKS:**

1. Emission Level(dBuV/m) = Raw Value(dBuV) + Correction Factor(dB/m)
2. Correction Factor(dB/m) = Antenna Factor(dB/m) + Cable Factor(dB) – Pre-Amplifier Factor(dB)
3. The other emission levels were very low against the limit.
4. Margin value = Emission Level – Limit value
5. " \* ": Fundamental frequency.
6. " # ": The radiated frequency is out of the restricted band.

<b>CHANNEL</b>	TX Channel 142	<b>DETECTOR FUNCTION</b>	Peak (PK)
<b>FREQUENCY RANGE</b>	1GHz ~ 40GHz		Average (AV)

**ANTENNA POLARITY & TEST DISTANCE: HORIZONTAL AT 3 M**

NO.	FREQ. (MHz)	EMISSION LEVEL (dBuV/m)	LIMIT (dBuV/m)	MARGIN (dB)	ANTENNA HEIGHT (m)	TABLE ANGLE (Degree)	RAW VALUE (dBuV)	CORRECTION FACTOR (dB/m)
1	#5470.00	51.1 PK	74.0	-22.9	2.65 H	143	46.8	4.3
2	#5470.00	37.4 AV	54.0	-16.6	2.65 H	143	33.1	4.3
3	*5710.00	103.3 PK			2.65 H	143	98.8	4.5
4	*5710.00	93.3 AV			2.65 H	143	88.8	4.5
5	#5850.00	50.9 PK	74.0	-23.1	2.65 H	143	46.1	4.8
6	#5850.00	37.8 AV	54.0	-16.2	2.65 H	143	33.0	4.8
7	11420.00	47.1 PK	74.0	-26.9	1.67 H	129	32.8	14.3
8	11420.00	35.2 AV	54.0	-18.8	1.67 H	129	20.9	14.3
9	#17130.00	50.5 PK	74.0	-23.5	1.73 H	188	33.3	17.2
10	#17130.00	39.0 AV	54.0	-15.0	1.73 H	188	21.8	17.2

**ANTENNA POLARITY & TEST DISTANCE: VERTICAL AT 3 M**

NO.	FREQ. (MHz)	EMISSION LEVEL (dBuV/m)	LIMIT (dBuV/m)	MARGIN (dB)	ANTENNA HEIGHT (m)	TABLE ANGLE (Degree)	RAW VALUE (dBuV)	CORRECTION FACTOR (dB/m)
1	#5470.00	51.2 PK	74.0	-22.8	2.54 V	295	46.9	4.3
2	#5470.00	37.4 AV	54.0	-16.6	2.54 V	295	33.1	4.3
3	*5710.00	107.7 PK			2.54 V	295	103.2	4.5
4	*5710.00	97.9 AV			2.54 V	295	93.4	4.5
5	#5850.00	51.3 PK	74.0	-22.7	2.54 V	295	46.5	4.8
6	#5850.00	38.9 AV	54.0	-15.1	2.54 V	295	34.1	4.8
7	11420.00	47.6 PK	74.0	-26.4	1.59 V	298	33.3	14.3
8	11420.00	35.7 AV	54.0	-18.3	1.59 V	298	21.4	14.3
9	#17130.00	51.2 PK	74.0	-22.8	2.02 V	170	34.0	17.2
10	#17130.00	39.0 AV	54.0	-15.0	2.02 V	170	21.8	17.2

**REMARKS:**

1. Emission Level(dBuV/m) = Raw Value(dBuV) + Correction Factor(dB/m)
2. Correction Factor(dB/m) = Antenna Factor(dB/m) + Cable Factor(dB) – Pre-Amplifier Factor(dB)
3. The other emission levels were very low against the limit.
4. Margin value = Emission Level – Limit value
5. " \* ": Fundamental frequency.
6. " # ": The radiated frequency is out of the restricted band.

<b>CHANNEL</b>	TX Channel 151	<b>DETECTOR FUNCTION</b>	Peak (PK)
<b>FREQUENCY RANGE</b>	1GHz ~ 40GHz		Average (AV)

**ANTENNA POLARITY & TEST DISTANCE: HORIZONTAL AT 3 M**

NO.	FREQ. (MHz)	EMISSION LEVEL (dBuV/m)	LIMIT (dBuV/m)	MARGIN (dB)	ANTENNA HEIGHT (m)	TABLE ANGLE (Degree)	RAW VALUE (dBuV)	CORRECTION FACTOR (dB/m)
1	*5755.00	102.6 PK			2.63 H	128	98.0	4.6
2	*5755.00	95.0 AV			2.63 H	128	90.4	4.6
3	11510.00	46.7 PK	74.0	-27.3	1.66 H	144	32.6	14.1
4	11510.00	34.9 AV	54.0	-19.1	1.66 H	144	20.8	14.1
5	#17265.00	50.8 PK	74.0	-23.2	1.66 H	196	33.7	17.1
6	#17265.00	39.2 AV	54.0	-14.8	1.66 H	196	22.1	17.1

**ANTENNA POLARITY & TEST DISTANCE: VERTICAL AT 3 M**

NO.	FREQ. (MHz)	EMISSION LEVEL (dBuV/m)	LIMIT (dBuV/m)	MARGIN (dB)	ANTENNA HEIGHT (m)	TABLE ANGLE (Degree)	RAW VALUE (dBuV)	CORRECTION FACTOR (dB/m)
1	*5755.00	106.1 PK			3.23 V	344	101.5	4.6
2	*5755.00	98.2 AV			3.23 V	344	93.6	4.6
3	11510.00	47.3 PK	74.0	-26.7	1.61 V	297	33.2	14.1
4	11510.00	35.3 AV	54.0	-18.7	1.61 V	297	21.2	14.1
5	#17265.00	51.3 PK	74.0	-22.7	1.92 V	163	34.2	17.1
6	#17265.00	38.9 AV	54.0	-15.1	1.92 V	163	21.8	17.1

**REMARKS:**

1. Emission Level(dBuV/m) = Raw Value(dBuV) + Correction Factor(dB/m)
2. Correction Factor(dB/m) = Antenna Factor(dB/m) + Cable Factor(dB) – Pre-Amplifier Factor(dB)
3. The other emission levels were very low against the limit.
4. Margin value = Emission Level – Limit value
5. " \* ": Fundamental frequency.
6. " # ": The radiated frequency is out of the restricted band.



<b>CHANNEL</b>	TX Channel 159	<b>DETECTOR FUNCTION</b>	Peak (PK)
<b>FREQUENCY RANGE</b>	1GHz ~ 40GHz		Average (AV)

**ANTENNA POLARITY & TEST DISTANCE: HORIZONTAL AT 3 M**

NO.	FREQ. (MHz)	EMISSION LEVEL (dBuV/m)	LIMIT (dBuV/m)	MARGIN (dB)	ANTENNA HEIGHT (m)	TABLE ANGLE (Degree)	RAW VALUE (dBuV)	CORRECTION FACTOR (dB/m)
1	*5795.00	102.8 PK			2.65 H	129	98.1	4.7
2	*5795.00	95.4 AV			2.65 H	129	90.7	4.7
3	11590.00	47.0 PK	74.0	-27.0	1.58 H	135	32.9	14.1
4	11590.00	35.1 AV	54.0	-18.9	1.58 H	135	21.0	14.1
5	#17385.00	51.1 PK	74.0	-22.9	1.66 H	209	33.1	18.0
6	#17385.00	39.3 AV	54.0	-14.7	1.66 H	209	21.3	18.0

**ANTENNA POLARITY & TEST DISTANCE: VERTICAL AT 3 M**

NO.	FREQ. (MHz)	EMISSION LEVEL (dBuV/m)	LIMIT (dBuV/m)	MARGIN (dB)	ANTENNA HEIGHT (m)	TABLE ANGLE (Degree)	RAW VALUE (dBuV)	CORRECTION FACTOR (dB/m)
1	*5795.00	106.5 PK			2.48 V	52	101.8	4.7
2	*5795.00	97.8 AV			2.48 V	52	93.1	4.7
3	11590.00	47.4 PK	74.0	-26.6	1.56 V	286	33.3	14.1
4	11590.00	35.1 AV	54.0	-18.9	1.56 V	286	21.0	14.1
5	#17385.00	50.5 PK	74.0	-23.5	1.93 V	170	32.5	18.0
6	#17385.00	38.3 AV	54.0	-15.7	1.93 V	170	20.3	18.0

**REMARKS:**

1. Emission Level(dBuV/m) = Raw Value(dBuV) + Correction Factor(dB/m)
2. Correction Factor(dB/m) = Antenna Factor(dB/m) + Cable Factor(dB) – Pre-Amplifier Factor(dB)
3. The other emission levels were very low against the limit.
4. Margin value = Emission Level – Limit value
5. " \* ": Fundamental frequency.
6. " # ": The radiated frequency is out of the restricted band.

**802.11ac (VHT80)**

<b>CHANNEL</b>	TX Channel 42	<b>DETECTOR FUNCTION</b>	Peak (PK)
<b>FREQUENCY RANGE</b>	1GHz ~ 40GHz		Average (AV)

**ANTENNA POLARITY & TEST DISTANCE: HORIZONTAL AT 3 M**

NO.	FREQ. (MHz)	EMISSION LEVEL (dBuV/m)	LIMIT (dBuV/m)	MARGIN (dB)	ANTENNA HEIGHT (m)	TABLE ANGLE (Degree)	RAW VALUE (dBuV)	CORRECTION FACTOR (dB/m)
1	5150.00	63.0 PK	74.0	-11.0	1.08 H	333	58.7	4.3
2	5150.00	47.4 AV	54.0	-6.6	1.08 H	333	43.1	4.3
3	*5210.00	98.3 PK			1.08 H	333	94.2	4.1
4	*5210.00	89.5 AV			1.08 H	333	85.4	4.1
5	5365.00	52.5 PK	74.0	-21.5	1.08 H	333	48.4	4.1
6	5365.00	39.8 AV	54.0	-14.2	1.08 H	333	35.7	4.1
7	#10420.00	46.5 PK	74.0	-27.5	1.50 H	300	32.9	13.6
8	#10420.00	35.0 AV	54.0	-19.0	1.50 H	300	21.4	13.6
9	15630.00	47.0 PK	74.0	-27.0	1.50 H	300	33.7	13.3
10	15630.00	35.5 AV	54.0	-18.5	1.50 H	300	22.2	13.3

**ANTENNA POLARITY & TEST DISTANCE: VERTICAL AT 3 M**

NO.	FREQ. (MHz)	EMISSION LEVEL (dBuV/m)	LIMIT (dBuV/m)	MARGIN (dB)	ANTENNA HEIGHT (m)	TABLE ANGLE (Degree)	RAW VALUE (dBuV)	CORRECTION FACTOR (dB/m)
1	5150.00	65.8 PK	74.0	-8.2	1.31 V	20	61.5	4.3
2	5150.00	51.5 AV	54.0	-2.5	1.31 V	20	47.2	4.3
3	*5210.00	98.6 PK			1.31 V	20	94.5	4.1
4	*5210.00	89.8 AV			1.31 V	20	85.7	4.1
5	5365.00	52.7 PK	74.0	-21.3	1.31 V	20	48.6	4.1
6	5365.00	39.9 AV	54.0	-14.1	1.31 V	20	35.8	4.1
7	#10420.00	46.4 PK	74.0	-27.6	1.50 V	10	32.8	13.6
8	#10420.00	34.9 AV	54.0	-19.1	1.50 V	10	21.3	13.6
9	15630.00	46.9 PK	74.0	-27.1	1.50 V	50	33.6	13.3
10	15630.00	35.4 AV	54.0	-18.6	1.50 V	50	22.1	13.3

**REMARKS:**

- Emission Level(dBuV/m) = Raw Value(dBuV) + Correction Factor(dB/m)
- Correction Factor(dB/m) = Antenna Factor(dB/m) + Cable Factor(dB) – Pre-Amplifier Factor(dB)
- The other emission levels were very low against the limit.
- Margin value = Emission Level – Limit value
- " \* ": Fundamental frequency.
- " # ": The radiated frequency is out of the restricted band.

<b>CHANNEL</b>	TX Channel 58	<b>DETECTOR FUNCTION</b>	Peak (PK)
<b>FREQUENCY RANGE</b>	1GHz ~ 40GHz		Average (AV)

**ANTENNA POLARITY & TEST DISTANCE: HORIZONTAL AT 3 M**

NO.	FREQ. (MHz)	EMISSION LEVEL (dBuV/m)	LIMIT (dBuV/m)	MARGIN (dB)	ANTENNA HEIGHT (m)	TABLE ANGLE (Degree)	RAW VALUE (dBuV)	CORRECTION FACTOR (dB/m)
1	5150.00	53.4 PK	74.0	-20.6	1.11 H	322	49.1	4.3
2	5150.00	43.5 AV	54.0	-10.5	1.11 H	322	39.2	4.3
3	*5290.00	97.8 PK			1.11 H	322	93.9	3.9
4	*5290.00	87.8 AV			1.11 H	322	83.9	3.9
5	5350.00	62.9 PK	74.0	-11.1	1.11 H	322	58.9	4.0
6	5350.00	48.2 AV	54.0	-5.8	1.11 H	322	44.2	4.0
7	#10580.00	46.0 PK	74.0	-28.0	1.72 H	171	32.4	13.6
8	#10580.00	34.9 AV	54.0	-19.1	1.72 H	171	21.3	13.6
9	15870.00	47.0 PK	74.0	-27.0	1.81 H	230	34.2	12.8
10	15870.00	34.9 AV	54.0	-19.1	1.81 H	230	22.1	12.8

**ANTENNA POLARITY & TEST DISTANCE: VERTICAL AT 3 M**

NO.	FREQ. (MHz)	EMISSION LEVEL (dBuV/m)	LIMIT (dBuV/m)	MARGIN (dB)	ANTENNA HEIGHT (m)	TABLE ANGLE (Degree)	RAW VALUE (dBuV)	CORRECTION FACTOR (dB/m)
1	5150.00	56.8 PK	74.0	-17.2	1.49 V	297	52.5	4.3
2	5150.00	46.9 AV	54.0	-7.1	1.49 V	297	42.6	4.3
3	*5290.00	98.3 PK			1.49 V	297	94.4	3.9
4	*5290.00	89.5 AV			1.49 V	297	85.6	3.9
5	5350.00	66.3 PK	74.0	-7.7	1.49 V	297	62.3	4.0
<b>6</b>	<b>5350.00</b>	<b>51.6 AV</b>	<b>54.0</b>	<b>-2.4</b>	<b>1.49 V</b>	<b>297</b>	<b>47.6</b>	<b>4.0</b>
7	#10580.00	46.6 PK	74.0	-27.4	1.49 V	4	33.0	13.6
8	#10580.00	34.8 AV	54.0	-19.2	1.49 V	4	21.2	13.6
9	15870.00	46.7 PK	74.0	-27.3	1.52 V	61	33.9	12.8
10	15870.00	35.4 AV	54.0	-18.6	1.52 V	61	22.6	12.8

**REMARKS:**

- Emission Level(dBuV/m) = Raw Value(dBuV) + Correction Factor(dB/m)
- Correction Factor(dB/m) = Antenna Factor(dB/m) + Cable Factor(dB) – Pre-Amplifier Factor(dB)
- The other emission levels were very low against the limit.
- Margin value = Emission Level – Limit value
- " \* ": Fundamental frequency.
- " # ": The radiated frequency is out of the restricted band.

<b>CHANNEL</b>	TX Channel 106	<b>DETECTOR FUNCTION</b>	Peak (PK)
<b>FREQUENCY RANGE</b>	1GHz ~ 40GHz		Average (AV)

**ANTENNA POLARITY & TEST DISTANCE: HORIZONTAL AT 3 M**

NO.	FREQ. (MHz)	EMISSION LEVEL (dBuV/m)	LIMIT (dBuV/m)	MARGIN (dB)	ANTENNA HEIGHT (m)	TABLE ANGLE (Degree)	RAW VALUE (dBuV)	CORRECTION FACTOR (dB/m)
1	#5470.00	67.4 PK	74.0	-6.6	1.14 H	308	63.1	4.3
2	#5470.00	48.2 AV	54.0	-5.8	1.14 H	308	43.9	4.3
3	*5530.00	97.1 PK			1.14 H	308	92.8	4.3
4	*5530.00	88.4 AV			1.14 H	308	84.1	4.3
5	#5725.00	49.8 PK	74.0	-24.2	1.14 H	308	45.3	4.5
6	#5725.00	37.5 AV	54.0	-16.5	1.14 H	308	33.0	4.5
7	11060.00	46.7 PK	74.0	-27.3	1.68 H	183	32.9	13.8
8	11060.00	35.4 AV	54.0	-18.6	1.68 H	183	21.6	13.8
9	#16590.00	47.1 PK	74.0	-26.9	1.88 H	235	30.4	16.7
10	#16590.00	34.9 AV	54.0	-19.1	1.88 H	235	18.2	16.7

**ANTENNA POLARITY & TEST DISTANCE: VERTICAL AT 3 M**

NO.	FREQ. (MHz)	EMISSION LEVEL (dBuV/m)	LIMIT (dBuV/m)	MARGIN (dB)	ANTENNA HEIGHT (m)	TABLE ANGLE (Degree)	RAW VALUE (dBuV)	CORRECTION FACTOR (dB/m)
1	#5470.00	70.8 PK	74.0	-3.2	1.54 V	311	66.5	4.3
2	#5470.00	51.6 AV	54.0	-2.4	1.54 V	311	47.3	4.3
3	*5530.00	99.2 PK			1.54 V	311	94.9	4.3
4	*5530.00	90.5 AV			1.54 V	311	86.2	4.3
5	#5725.00	50.8 PK	74.0	-23.2	1.54 V	311	46.3	4.5
6	#5725.00	39.5 AV	54.0	-14.5	1.54 V	311	35.0	4.5
7	11060.00	46.4 PK	74.0	-27.6	1.53 V	8	32.6	13.8
8	11060.00	34.5 AV	54.0	-19.5	1.53 V	8	20.7	13.8
9	#16590.00	46.0 PK	74.0	-28.0	1.54 V	51	29.3	16.7
10	#16590.00	35.0 AV	54.0	-19.0	1.54 V	51	18.3	16.7

**REMARKS:**

- Emission Level(dBuV/m) = Raw Value(dBuV) + Correction Factor(dB/m)
- Correction Factor(dB/m) = Antenna Factor(dB/m) + Cable Factor(dB) – Pre-Amplifier Factor(dB)
- The other emission levels were very low against the limit.
- Margin value = Emission Level – Limit value
- " \* ": Fundamental frequency.
- " # ": The radiated frequency is out of the restricted band.

<b>CHANNEL</b>	TX Channel 122	<b>DETECTOR FUNCTION</b>	Peak (PK)
<b>FREQUENCY RANGE</b>	1GHz ~ 40GHz		Average (AV)

**ANTENNA POLARITY & TEST DISTANCE: HORIZONTAL AT 3 M**

NO.	FREQ. (MHz)	EMISSION LEVEL (dBuV/m)	LIMIT (dBuV/m)	MARGIN (dB)	ANTENNA HEIGHT (m)	TABLE ANGLE (Degree)	RAW VALUE (dBuV)	CORRECTION FACTOR (dB/m)
1	*5610.00	101.1 PK			1.15 H	299	96.7	4.4
2	*5610.00	92.1 AV			1.15 H	299	87.7	4.4
3	#5725.00	58.9 PK	74.0	-15.1	1.15 H	299	54.4	4.5
4	#5725.00	46.8 AV	54.0	-7.2	1.15 H	299	42.3	4.5
5	11220.00	46.0 PK	74.0	-28.0	1.74 H	170	32.3	13.7
6	11220.00	35.0 AV	54.0	-19.0	1.74 H	170	21.3	13.7
7	#16830.00	47.5 PK	74.0	-26.5	1.80 H	229	30.5	17.0
8	#16830.00	35.0 AV	54.0	-19.0	1.80 H	229	18.0	17.0

**ANTENNA POLARITY & TEST DISTANCE: VERTICAL AT 3 M**

NO.	FREQ. (MHz)	EMISSION LEVEL (dBuV/m)	LIMIT (dBuV/m)	MARGIN (dB)	ANTENNA HEIGHT (m)	TABLE ANGLE (Degree)	RAW VALUE (dBuV)	CORRECTION FACTOR (dB/m)
1	*5610.00	104.2 PK			1.68 V	308	99.8	4.4
2	*5610.00	95.2 AV			1.68 V	308	90.8	4.4
3	#5725.00	62.3 PK	74.0	-11.7	1.70 V	308	57.8	4.5
4	#5725.00	50.2 AV	54.0	-3.8	1.70 V	308	45.7	4.5
5	11220.00	46.7 PK	74.0	-27.3	1.54 V	0	33.0	13.7
6	11220.00	35.1 AV	54.0	-18.9	1.54 V	0	21.4	13.7
7	#16830.00	47.1 PK	74.0	-26.9	1.47 V	54	30.1	17.0
8	#16830.00	35.6 AV	54.0	-18.4	1.47 V	54	18.6	17.0

**REMARKS:**

1. Emission Level(dBuV/m) = Raw Value(dBuV) + Correction Factor(dB/m)
2. Correction Factor(dB/m) = Antenna Factor(dB/m) + Cable Factor(dB) – Pre-Amplifier Factor(dB)
3. The other emission levels were very low against the limit.
4. Margin value = Emission Level – Limit value
5. " \* ": Fundamental frequency.
6. " # ": The radiated frequency is out of the restricted band.

<b>CHANNEL</b>	TX Channel 138	<b>DETECTOR FUNCTION</b>	Peak (PK)
<b>FREQUENCY RANGE</b>	1GHz ~ 40GHz		Average (AV)

**ANTENNA POLARITY & TEST DISTANCE: HORIZONTAL AT 3 M**

NO.	FREQ. (MHz)	EMISSION LEVEL (dBuV/m)	LIMIT (dBuV/m)	MARGIN (dB)	ANTENNA HEIGHT (m)	TABLE ANGLE (Degree)	RAW VALUE (dBuV)	CORRECTION FACTOR (dB/m)
1	#5470.00	49.8 PK	74.0	-24.2	1.14 H	289	45.5	4.3
2	#5470.00	37.4 AV	54.0	-16.6	1.14 H	289	33.1	4.3
3	*5690.00	102.3 PK			1.14 H	289	97.9	4.4
4	*5690.00	93.2 AV			1.14 H	289	88.8	4.4
5	#5850.00	52.4 PK	74.0	-21.6	1.14 H	289	47.6	4.8
6	#5850.00	38.2 AV	54.0	-15.8	1.14 H	289	33.4	4.8
7	11380.00	47.4 PK	74.0	-26.6	1.55 H	41	33.1	14.3
8	11380.00	35.8 AV	54.0	-18.2	1.55 H	41	21.5	14.3
9	#17070.00	50.8 PK	74.0	-23.2	1.45 H	71	33.5	17.3
10	#17070.00	39.8 AV	54.0	-14.2	1.45 H	71	22.5	17.3

**ANTENNA POLARITY & TEST DISTANCE: VERTICAL AT 3 M**

NO.	FREQ. (MHz)	EMISSION LEVEL (dBuV/m)	LIMIT (dBuV/m)	MARGIN (dB)	ANTENNA HEIGHT (m)	TABLE ANGLE (Degree)	RAW VALUE (dBuV)	CORRECTION FACTOR (dB/m)
1	#5470.00	50.6 PK	74.0	-23.4	1.76 V	307	46.3	4.3
2	#5470.00	38.7 AV	54.0	-15.3	1.76 V	307	34.4	4.3
3	*5690.00	105.4 PK			1.76 V	307	101.0	4.4
4	*5690.00	95.9 AV			1.76 V	307	91.5	4.4
5	#5850.00	55.8 PK	74.0	-18.2	1.76 V	307	51.0	4.8
6	#5850.00	41.6 AV	54.0	-12.4	1.76 V	307	36.8	4.8
7	11380.00	47.5 PK	74.0	-26.5	1.63 V	312	33.2	14.3
8	11380.00	35.3 AV	54.0	-18.7	1.63 V	312	21.0	14.3
9	#17070.00	51.4 PK	74.0	-22.6	2.06 V	170	34.1	17.3
10	#17070.00	39.3 AV	54.0	-14.7	2.06 V	170	22.0	17.3

**REMARKS:**

- Emission Level(dBuV/m) = Raw Value(dBuV) + Correction Factor(dB/m)
- Correction Factor(dB/m) = Antenna Factor(dB/m) + Cable Factor(dB) – Pre-Amplifier Factor(dB)
- The other emission levels were very low against the limit.
- Margin value = Emission Level – Limit value
- " \* ": Fundamental frequency.
- " # ": The radiated frequency is out of the restricted band.

<b>CHANNEL</b>	TX Channel 155	<b>DETECTOR FUNCTION</b>	Peak (PK)
<b>FREQUENCY RANGE</b>	1GHz ~ 40GHz		Average (AV)

**ANTENNA POLARITY & TEST DISTANCE: HORIZONTAL AT 3 M**

NO.	FREQ. (MHz)	EMISSION LEVEL (dBuV/m)	LIMIT (dBuV/m)	MARGIN (dB)	ANTENNA HEIGHT (m)	TABLE ANGLE (Degree)	RAW VALUE (dBuV)	CORRECTION FACTOR (dB/m)
1	*5775.00	100.4 PK			3.77 H	215	95.8	4.6
2	*5775.00	91.1 AV			3.77 H	215	86.5	4.6
3	11550.00	47.4 PK	74.0	-26.6	1.50 H	50	33.3	14.1
4	11550.00	36.0 AV	54.0	-18.0	1.50 H	50	21.9	14.1
5	#17325.00	51.1 PK	74.0	-22.9	1.50 H	55	33.7	17.4
6	#17325.00	39.8 AV	54.0	-14.2	1.50 H	55	22.4	17.4

**ANTENNA POLARITY & TEST DISTANCE: VERTICAL AT 3 M**

NO.	FREQ. (MHz)	EMISSION LEVEL (dBuV/m)	LIMIT (dBuV/m)	MARGIN (dB)	ANTENNA HEIGHT (m)	TABLE ANGLE (Degree)	RAW VALUE (dBuV)	CORRECTION FACTOR (dB/m)
1	*5775.00	102.5 PK			1.50 V	211	97.9	4.6
2	*5775.00	93.0 AV			1.50 V	211	88.4	4.6
3	11550.00	47.5 PK	74.0	-26.5	1.50 V	100	33.4	14.1
4	11550.00	36.3 AV	54.0	-17.7	1.50 V	100	22.2	14.1
5	#17325.00	51.2 PK	74.0	-22.8	1.50 V	308	33.8	17.4
6	#17325.00	39.8 AV	54.0	-14.2	1.50 V	308	22.4	17.4

**REMARKS:**

1. Emission Level(dBuV/m) = Raw Value(dBuV) + Correction Factor(dB/m)
2. Correction Factor(dB/m) = Antenna Factor(dB/m) + Cable Factor(dB) – Pre-Amplifier Factor(dB)
3. The other emission levels were very low against the limit.
4. Margin value = Emission Level – Limit value
5. " \* ": Fundamental frequency.
6. " # ": The radiated frequency is out of the restricted band.

**Below 1GHz Data:**

**802.11ac (VHT40)**

<b>CHANNEL</b>	TX Channel 134	<b>DETECTOR FUNCTION</b>	Quasi-Peak (QP)
<b>FREQUENCY RANGE</b>	9kHz ~ 1GHz		

**ANTENNA POLARITY & TEST DISTANCE: HORIZONTAL AT 3 M**

NO.	FREQ. (MHz)	EMISSION LEVEL (dBuV/m)	LIMIT (dBuV/m)	MARGIN (dB)	ANTENNA HEIGHT (m)	TABLE ANGLE (Degree)	RAW VALUE (dBuV)	CORRECTION FACTOR (dB/m)
1	37.49	30.2 QP	40.0	-9.8	2.42 H	209	38.7	-8.5
2	71.02	34.4 QP	40.0	-5.6	2.43 H	209	44.6	-10.2
3	159.60	32.5 QP	43.5	-11.0	1.92 H	201	40.2	-7.7
4	300.00	39.3 QP	46.0	-6.7	2.11 H	183	46.5	-7.2
5	350.00	36.0 QP	46.0	-10.0	1.59 H	84	42.0	-6.0
6	927.72	34.5 QP	46.0	-11.5	1.34 H	203	29.6	4.9

**ANTENNA POLARITY & TEST DISTANCE: VERTICAL AT 3 M**

NO.	FREQ. (MHz)	EMISSION LEVEL (dBuV/m)	LIMIT (dBuV/m)	MARGIN (dB)	ANTENNA HEIGHT (m)	TABLE ANGLE (Degree)	RAW VALUE (dBuV)	CORRECTION FACTOR (dB/m)
1	31.09	33.2 QP	40.0	-6.8	1.02 V	318	42.1	-8.9
2	71.20	32.9 QP	40.0	-7.1	1.14 V	138	43.2	-10.3
3	158.57	29.5 QP	43.5	-14.0	1.51 V	274	37.1	-7.6
4	350.00	34.6 QP	46.0	-11.4	1.31 V	279	40.6	-6.0
5	399.98	33.2 QP	46.0	-12.8	1.42 V	56	37.8	-4.6
6	850.86	35.0 QP	46.0	-11.0	1.44 V	152	31.3	3.7

**REMARKS:**

1. Emission Level(dBuV/m) = Raw Value(dBuV) + Correction Factor(dB/m)
2. Correction Factor(dB/m) = Antenna Factor(dB/m) + Cable Factor(dB) – Pre-Amplifier Factor(dB)
3. The other emission levels were very low against the limit.
4. Margin value = Emission Level – Limit value



## 4.2 Conducted Emission Measurement

### 4.2.1 Limits of Conducted Emission Measurement

Frequency (MHz)	Conducted Limit (dBuV)	
	Quasi-peak	Average
0.15 - 0.5	66 - 56	56 - 46
0.50 - 5.0	56	46
5.0 - 30.0	60	50

Note: 1. The lower limit shall apply at the transition frequencies.

2. The limit decreases in line with the logarithm of the frequency in the range of 0.15 to 0.50MHz.

### 4.2.2 Test Instruments

DESCRIPTION & MANUFACTURER	MODEL NO.	SERIAL NO.	CALIBRATED DATE	CALIBRATED UNTIL
Test Receiver R&S	ESCS 30	847124/029	Nov. 01, 2017	Oct. 31, 2018
Line-Impedance Stabilization Network (for EUT) R&S	ESH3-Z5	848773/004	Nov. 15, 2017	Nov. 14, 2018
Line-Impedance Stabilization Network (for Peripheral) R&S	ENV216	100072	June 03, 2017	June 02, 2018
50 ohms Terminator	N/A	EMC-02	Sep. 22, 2017	Sep. 21, 2018
RF Cable	5D-FB	COCCAB-001	Sep. 29, 2017	Sep. 28, 2018
10 dB PAD Mini-Circuits	HAT-10+	CONATT-004	June 18, 2017	June 17, 2018
Software BVADT	BVADT_Cond_ V7.3.7.4	NA	NA	NA

**Note:**

1. The calibration interval of the above test instruments are 12 months and the calibrations are traceable to NML/ROC and NIST/USA.
2. The test was performed in Shielded Room No. 1.
- 3 Tested Date: Jan. 20, 2018

#### 4.2.3 Test Procedure

- The EUT was placed 0.4 meters from the conducting wall of the shielded room with EUT being connected to the power mains through a line impedance stabilization network (LISN). Other support units were connected to the power mains through another LISN. The two LISNs provide 50 ohm/ 50uH of coupling impedance for the measuring instrument.
- Both lines of the power mains connected to the EUT were checked for maximum conducted interference.
- The frequency range from 150kHz to 30MHz was searched. Emission levels under (Limit - 20dB) was not recorded.

**NOTE:** All modes of operation were investigated and the worst-case emissions are reported.

#### 4.2.4 Deviation from Test Standard

No deviation.

#### 4.2.5 Test Setup

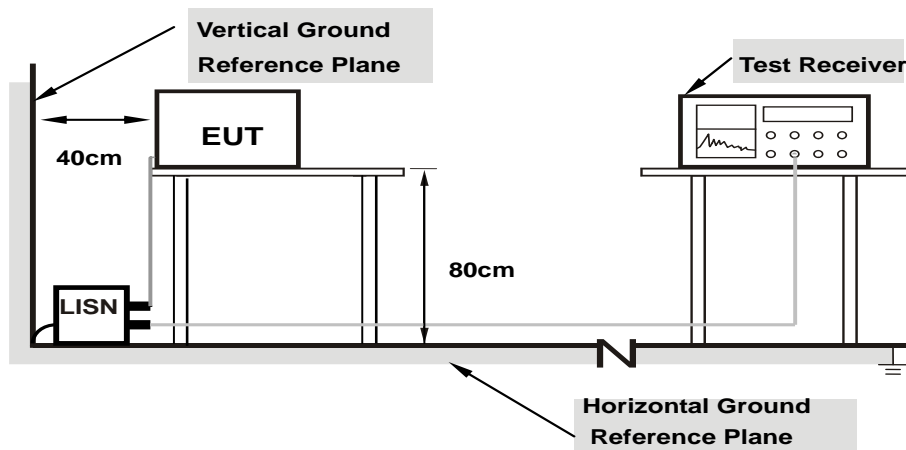

**Note: 1.Support units were connected to second LISN.**

For the actual test configuration, please refer to the attached file (Test Setup Photo).

#### 4.2.6 EUT Operating Condition

Controlling software (QRCT.exe V3.0.268.0) has been activated to set the EUT on specific status.

#### 4.2.7 Test Results

Phase	Line (L)	Detector Function	Quasi-Peak (QP) / Average (AV)
-------	----------	-------------------	--------------------------------

No	Freq. [MHz]	Corr. Factor	Reading Value [dB (uV)]		Emission Level [dB (uV)]		Limit [dB (uV)]		Margin (dB)	
		(dB)	Q.P.	AV.	Q.P.	AV.	Q.P.	AV.	Q.P.	AV.
	1	0.15391	10.13	43.32	30.13	53.45	40.26	65.79	55.79	-12.34
<b>2</b>	<b>0.16172</b>	<b>10.13</b>	<b>44.38</b>	<b>31.01</b>	<b>54.51</b>	<b>41.14</b>	<b>65.38</b>	<b>55.38</b>	<b>-10.87</b>	<b>-14.24</b>
3	0.23203	10.15	33.35	21.30	43.50	31.45	62.38	52.38	-18.88	-20.93
4	0.40781	10.19	23.30	5.06	33.49	15.25	57.69	47.69	-24.20	-32.44
5	0.79844	10.22	30.83	17.24	41.05	27.46	56.00	46.00	-14.95	-18.54
6	2.28125	10.28	31.11	19.19	41.39	29.47	56.00	46.00	-14.61	-16.53
7	2.43750	10.29	31.23	19.40	41.52	29.69	56.00	46.00	-14.48	-16.31
8	2.55859	10.30	29.73	18.07	40.03	28.37	56.00	46.00	-15.97	-17.63
9	8.23828	10.56	26.10	16.88	36.66	27.44	60.00	50.00	-23.34	-22.56

#### REMARKS:

1. Q.P. and AV. are abbreviations of quasi-peak and average individually.
2. The emission levels of other frequencies were very low against the limit.
3. Margin value = Emission level - Limit value
4. Correction factor = Insertion loss + Cable loss
5. Emission Level = Correction Factor + Reading Value.



Phase	Neutral (N)	Detector Function	Quasi-Peak (QP) / Average (AV)
-------	-------------	-------------------	--------------------------------

No	Freq. [MHz]	Corr.	Reading Value		Emission Level		Limit		Margin	
		Factor	[dB (uV)]		[dB (uV)]		[dB (uV)]		(dB)	
	(dB)	Q.P.	AV.	Q.P.	AV.	Q.P.	AV.	Q.P.	AV.	
1	0.18125	10.04	42.42	28.86	52.46	38.90	64.43	54.43	-11.97	-15.53
2	0.23984	10.05	34.25	20.18	44.30	30.23	62.10	52.10	-17.80	-21.87
3	0.75938	10.10	30.63	14.81	40.73	24.91	56.00	46.00	-15.27	-21.09
4	1.68359	10.14	28.76	15.71	38.90	25.85	56.00	46.00	-17.10	-20.15
5	9.34766	10.46	27.19	17.28	37.65	27.74	60.00	50.00	-22.35	-22.26
6	25.20703	11.04	25.79	18.63	36.83	29.67	60.00	50.00	-23.17	-20.33

**REMARKS:**

1. Q.P. and AV. are abbreviations of quasi-peak and average individually.
2. The emission levels of other frequencies were very low against the limit.
3. Margin value = Emission level - Limit value
4. Correction factor = Insertion loss + Cable loss
5. Emission Level = Correction Factor + Reading Value.

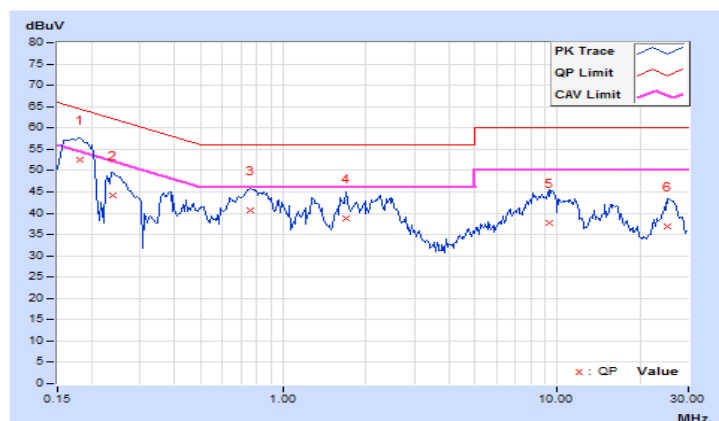

### 4.3 Transmit Power Measurement

#### 4.3.1 Limits of Transmit Power Measurement

Operation Band	EUT Category		Limit
U-NII-1		Outdoor Access Point	1 Watt (30 dBm) (Max. e.i.r.p $\leq$ 125mW(21 dBm) at any elevation angle above 30 degrees as measured from the horizon)
		Fixed point-to-point Access Point	1 Watt (30 dBm)
		Indoor Access Point	1 Watt (30 dBm)
	√	Client device	250mW (24 dBm)
U-NII-2A		√	250mW (24 dBm) or 11 dBm+10 log B*
U-NII-2C		√	250mW (24 dBm) or 11 dBm+10 log B*
U-NII-3		√	1 Watt (30 dBm)

\*B is the 26 dB emission bandwidth in megahertz

Per KDB 662911 Method of conducted output power measurement on IEEE 802.11 devices,

Array Gain = 0 dB (i.e., no array gain) for  $N_{ANT} \leq 4$ ;

Array Gain = 0 dB (i.e., no array gain) for channel widths  $\geq 40$  MHz for any  $N_{ANT}$ ;

Array Gain =  $5 \log(N_{ANT}/N_{SS})$  dB or 3 dB, whichever is less for 20-MHz channel widths with  $N_{ANT} \geq 5$ .

For power measurements on all other devices: Array Gain =  $10 \log(N_{ANT}/N_{SS})$  dB.

#### 4.3.2 Test Setup

##### FOR POWER OUTPUT MEASUREMENT

For channel straddling 5725MHz:

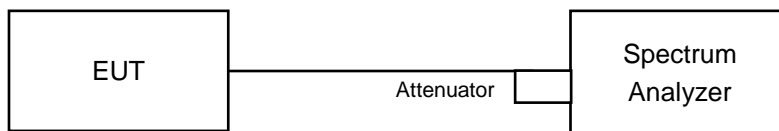

For other channels:

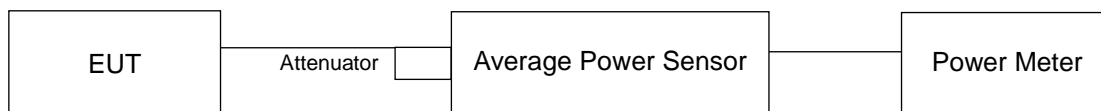

##### FOR 26dB OCCUPIED BANDWIDTH

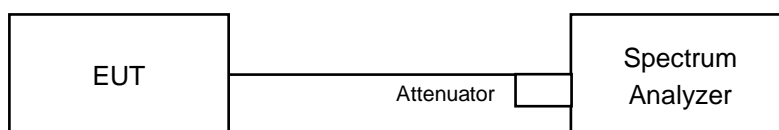

#### 4.3.3 Test Instruments

Refer to section 4.1.2 to get information of above instrument.

#### 4.3.4 Test Procedure

##### For Average Power Measurement

##### For channel straddling 5725MHz:

Method SA-2

1. Set span to encompass the emission bandwidth (EBW) of the signal.
2. Set RBW =1MHz.
3. Set the VBW  $\geq 3 \times$  RBW.
4. Number of points in sweep  $\geq 2$  Span / RBW.
5. Sweep time = auto.
6. Detector = RMS.
7. Trace average at least 100 traces in power averaging mode
8. Compute power by integrating the spectrum across the 26 dB EBW of the signal.
9. Duty factor need added to measured value (duty cycle < 98 percent).

##### Other Modulation mode

Method PM is used to perform output power measurement, trigger and gating function of wide band power meter is enabled to measure max output power of TX on burst. Duty factor is not added to measured value.

##### FOR 26dB OCCUPIED BANDWIDTH

1. Set RBW = approximately 1% of the emission bandwidth.
2. Set the VBW > RBW.
3. Detector = Peak.
4. Trace mode = max hold.
5. Measure the maximum width of the emission that is 26 dB down from the peak of the emission. Compare this with the RBW setting of the analyzer. Readjust RBW and repeat measurement as needed until the RBW/EBW ratio is approximately 1%.

#### 4.3.5 Deviation from Test Standard

No deviation.

#### 4.3.6 EUT Operating Condition

The software provided by client to enable the EUT under transmission condition continuously at lowest, middle and highest channel frequencies individually.

#### 4.3.7 Test Result

##### 802.11a

##### Power Output:

Chan.	Chan. Freq. (MHz)	Maximum Conducted Power (dBm)		Total Power (mW)	Total Power (dBm)	Limit (dBm)	Pass / Fail
		Chain 0	Chain 1				
36	5180	14.06	13.32	46.946	16.72	24.00	Pass
40	5200	13.62	13.37	44.741	16.51	24.00	Pass
48	5240	13.56	13.74	46.358	16.66	24.00	Pass
52	5260	15.01	15.33	65.815	18.18	24.00	Pass
60	5300	15.02	15.36	66.125	18.20	24.00	Pass
64	5320	14.67	15.33	63.428	18.02	24.00	Pass
100	5500	16.23	16.32	84.831	19.29	24.00	Pass
120	5600	16.07	16.46	84.717	19.28	24.00	Pass
140	5700	15.88	16.61	84.54	19.27	24.00	Pass
*144 (UNII-2C Band)	5720	12.03	12.00	33.676	15.27	23.07	Pass
*144 (UNII-3 Band)	5720	6.18	6.10	8.707	9.40	30.00	Pass
149	5745	15.52	16.62	81.565	19.12	30.00	Pass
157	5785	15.57	16.75	83.373	19.21	30.00	Pass
165	5825	15.65	16.81	84.701	19.28	30.00	Pass

Note: \* Test was performed in accordance with Measurement follow FCC KDB 789033 UNII test procedure Method SA-2 and use spectrum analyzer test.

The Average Power for the straddle channel:

Chan.	Chan. Freq. (MHz)	Average Power (mW)	Average Power (dBm)
144	5720	42.383	16.27

Note: The total power was calculated through formula and record the value for reference only.

### 26dB OCCUPIED BANDWIDTH

Channel	Frequency (MHz)	26dBc Bandwidth (MHz)	
		Chain 0	Chain 1
52	5260	27.27	32.53
60	5300	30.26	29.61
64	5320	27.54	25.90
100	5500	29.47	28.70
116	5580	28.81	27.87
140	5700	32.15	24.97
144 (UNII-2C Band)	5720	18.98	16.11

**Note: For U-NII-2A, U-NII-2C Band output power limitation is determined based on 26dBc bandwidth**

Power Limit = 11dBm + 10logB < U-NII-2A, U-NII-2C >			
Channel Number	Freq.(MHz)	Min. B(MHz)	Determined Conducted Limit (dBm)
52	5260	27.27	25.35 > 24
60	5300	29.61	25.71 > 24
64	5320	25.90	25.13 > 24
100	5500	28.70	25.57 > 24
116	5580	27.87	25.45 > 24
140	5700	24.97	24.97 > 24
144 (UNII-2C Band)	5720	16.11	23.07 < 24



## 802.11ac (VHT20)

### Power Output:

Chan.	Chan. Freq. (MHz)	Maximum Conducted Power (dBm)		Total Power (mW)	Total Power (dBm)	Limit (dBm)	Pass / Fail
		Chain 0	Chain 1				
36	5180	13.78	13.27	45.11	16.54	24.00	Pass
40	5200	13.72	13.71	47.046	16.73	24.00	Pass
48	5240	13.40	13.85	46.144	16.64	24.00	Pass
52	5260	14.91	15.36	65.33	18.15	24.00	Pass
60	5300	14.89	15.36	65.188	18.14	24.00	Pass
64	5320	14.77	15.22	63.258	18.01	24.00	Pass
100	5500	16.12	16.43	84.88	19.29	24.00	Pass
116	5580	16.09	16.45	84.801	19.28	24.00	Pass
140	5700	15.77	16.67	84.209	19.25	24.00	Pass
*144 (UNII-2C Band)	5720	12.02	12.06	33.711	15.28	23.79	Pass
*144 (UNII-3 Band)	5720	6.59	6.69	9.723	9.88	30.00	Pass
149	5745	15.52	16.76	83.069	19.19	30.00	Pass
157	5785	15.51	16.68	82.122	19.14	30.00	Pass
165	5825	15.54	16.54	80.892	19.08	30.00	Pass

Note: \* Test was performed in accordance with Measurement follow FCC KDB 789033 UNII test procedure Method SA-2 and use spectrum analyzer test.

The Average Power for the straddle channel:

Chan.	Chan. Freq. (MHz)	Average Power (mW)	Average Power (dBm)
144	5720	43.434	16.38

Note: The total power was calculated through formula and record the value for reference only.

## 26dB OCCUPIED BANDWIDTH

Channel	Frequency (MHz)	26dBc Bandwidth (MHz)	
		Chain 0	Chain 1
52	5260	28.44	36.10
60	5300	28.60	39.64
64	5320	30.21	30.33
100	5500	38.29	30.18
116	5580	37.69	34.23
140	5700	36.05	30.37
144 (UNII-2C Band)	5720	19.05	20.61

**Note: For U-NII-2A, U-NII-2C Band output power limitation is determined based on 26dBc bandwidth**

Power Limit = 11dBm + 10logB < U-NII-2A, U-NII-2C >			
Channel Number	Freq.(MHz)	Min. B(MHz)	Determined Conducted Limit (dBm)
52	5260	28.44	25.53 > 24
60	5300	28.60	25.56 > 24
64	5320	30.21	25.8 > 24
100	5500	30.18	25.79 > 24
116	5580	34.23	26.34 > 24
140	5700	30.37	25.82 > 24
144 (UNII-2C Band)	5720	19.05	23.79 < 24

## 802.11ac (VHT40)

### Power Output:

Chan.	Chan. Freq. (MHz)	Maximum Conducted Power (dBm)		Total Power (mW)	Total Power (dBm)	Limit (dBm)	Pass / Fail
		Chain 0	Chain 1				
38	5190	12.90	13.10	39.915	16.01	24.00	Pass
46	5230	14.99	15.36	65.906	18.19	24.00	Pass
54	5270	15.02	15.33	65.888	18.19	24.00	Pass
62	5310	11.76	12.36	32.216	15.08	24.00	Pass
102	5510	14.22	14.35	53.651	17.30	24.00	Pass
110	5550	15.98	16.12	80.554	19.06	24.00	Pass
134	5670	16.01	16.55	85.088	19.30	24.00	Pass
*142 (UNII-2C Band)	5710	11.75	11.53	32.029	15.06	24.00	Pass
*142 (UNII-3 Band)	5710	1.38	1.78	3.162	5.00	30.00	Pass
151	5755	15.52	16.67	82.097	19.14	30.00	Pass
159	5795	15.67	16.68	83.457	19.21	30.00	Pass

Note: \* Test was performed in accordance with Measurement follow FCC KDB 789033 UNII test procedure Method SA-2 and use spectrum analyzer test.

The Average Power for the straddle channel:

Chan.	Chan. Freq. (MHz)	Average Power (mW)	Average Power (dBm)
142	5710	35.191	15.46

Note: The total power was calculated through formula and record the value for reference only.

### 26dB OCCUPIED BANDWIDTH

Channel	Frequency (MHz)	26dBc Bandwidth (MHz)	
		Chain 0	Chain 1
54	5270	78.77	80.03
62	5310	43.51	57.26
102	5510	57.71	54.57
110	5550	85.49	75.42
134	5670	87.45	59.69
142 (UNII-2C Band)	5710	55.22	39.09

**Note: For U-NII-2A, U-NII-2C Band output power limitation is determined based on 26dBc bandwidth**

Power Limit = 11dBm + 10logB < U-NII-2A, U-NII-2C >			
Channel Number	Freq.(MHz)	Min. B(MHz)	Determined Conducted Limit (dBm)
54	5270	78.77	29.96 > 24
62	5310	43.51	27.38 > 24
102	5510	54.57	28.36 > 24
110	5550	75.42	29.77 > 24
134	5670	59.69	28.75 > 24
142 (UNII-2C Band)	5710	39.09	26.92 > 24

## 802.11ac (VHT80)

### Power Output:

Chan.	Chan. Freq. (MHz)	Maximum Conducted Power (dBm)		Total Power (mW)	Total Power (dBm)	Limit (dBm)	Pass / Fail
		Chain 0	Chain 1				
42	5210	13.55	13.38	44.423	16.48	24.00	Pass
58	5290	12.56	12.99	37.937	15.79	24.00	Pass
106	5530	13.62	13.92	47.674	16.78	24.00	Pass
122	5610	15.78	16.21	79.627	19.01	24.00	Pass
*138 (UNII-2C Band)	5690	8.75	9.66	20.426	13.10	24.00	Pass
*138 (UNII-3 Band)	5690	-3.66	-4.49	0.9589	-0.18	30.00	Pass
155	5775	15.52	16.67	82.097	19.14	30.00	Pass

Note: \* Test was performed in accordance with Measurement follow FCC KDB 789033 UNII test procedure Method SA-2 and use spectrum analyzer test.

The Average Power for the straddle channel:

Chan.	Chan. Freq. (MHz)	Average Power (mW)	Average Power (dBm)
138	5690	21.3849	13.3

Note: The total power was calculated through formula and record the value for reference only.

### 26dB OCCUPIED BANDWIDTH

Channel	Frequency (MHz)	26dBc Bandwidth (MHz)	
		Chain 0	Chain 1
58	5290	86.15	85.91
106	5530	85.49	85.52
122	5610	114.81	88.63
138 (UNII-2C Band)	5690	91.71	80.18

**Note: For U-NII-2A, U-NII-2C Band output power limitation is determined based on 26dBc bandwidth**

Power Limit = 11dBm + 10logB < U-NII-2A, U-NII-2C >			
Channel Number	Freq.(MHz)	Min. B(MHz)	Determined Conducted Limit (dBm)
58	5290	85.91	30.34 > 24
106	5530	85.49	30.31 > 24
122	5610	88.63	30.47 > 24
138 (UNII-2C Band)	5690	80.18	30.04 > 24

### Spectrum Plot of Worst Value

**802.11a / Chain 1 : CH144 (UNII-2C)**

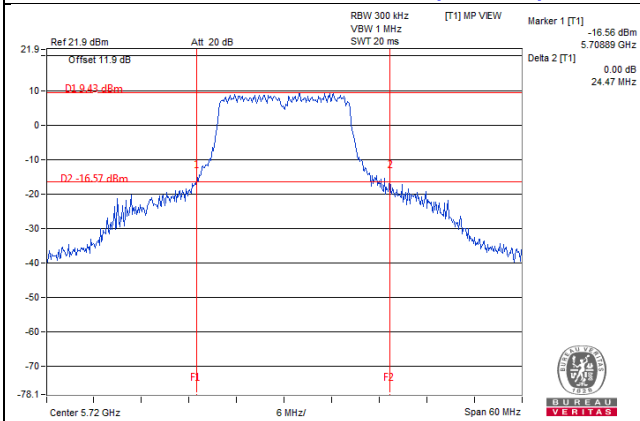

**802.11ac (VHT20) / Chain 0 : CH144 (UNII-2C)**

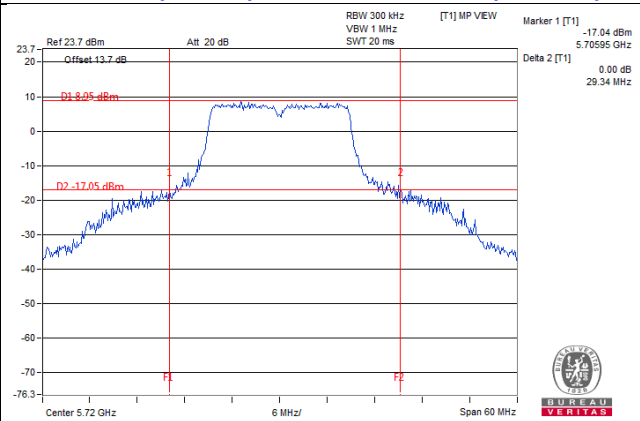

**802.11ac (VHT40) / Chain 1 : CH142 (UNII-2C)**

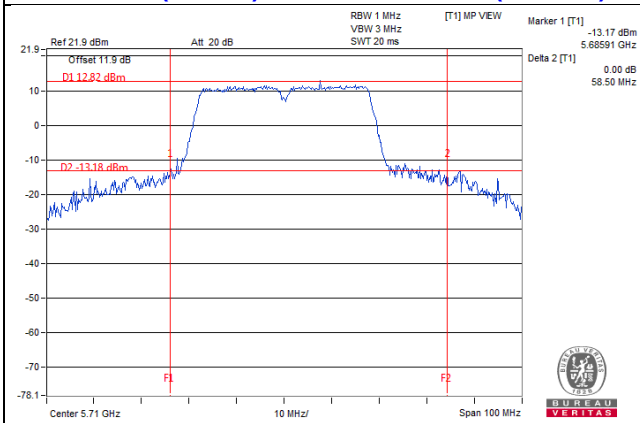

**802.11ac (VHT80) / Chain 1 : CH138 (UNII-2C)**

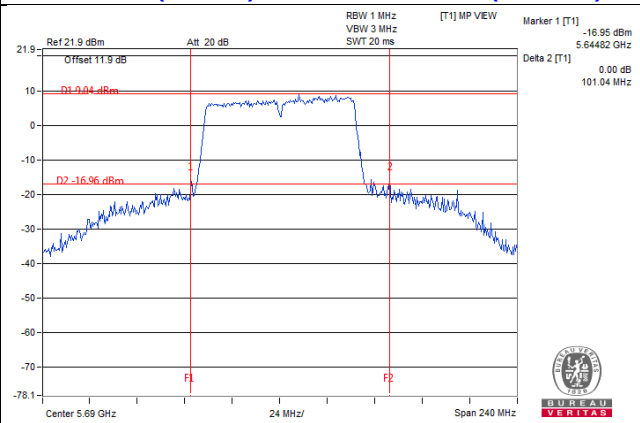

### For Reference only – Power meter value

The power value was measured by power meter with average sensor.

#### 802.11a

Chan.	Chan. Freq. (MHz)	Average Power (mW)	Average Power (dBm)
144	5720	83.136	19.20

#### 802.11ac (VHT20)

Chan.	Chan. Freq. (MHz)	Average Power (mW)	Average Power (dBm)
144	5720	83.18	19.20

#### 802.11ac (VHT40)

Chan.	Chan. Freq. (MHz)	Average Power (mW)	Average Power (dBm)
142	5710	83.074	19.19

#### 802.11ac (VHT80)

Chan.	Chan. Freq. (MHz)	Average Power (mW)	Average Power (dBm)
138	5690	79.782	19.02

## 4.4 Occupied Bandwidth Measurement

### 4.4.1 Test Setup



### 4.4.2 Test Instruments

Refer to section 4.1.2 to get information of above instrument.

### 4.4.3 Test Procedure

The transmitter output was connected to the spectrum analyzer through an attenuator. The bandwidth of the fundamental frequency was measured by spectrum analyzer with resolution bandwidth in the range of 1% to 5% of the anticipated emission bandwidth, and a video bandwidth at least 3x the resolution bandwidth and set the detector to SAMPLE. The width of a frequency band such that, below the lower and above the upper frequency limits, the mean powers emitted are each equal to a specified percentage 0.5 %of the total mean power of a given emission.



## 4.4.4 Test Results

## 802.11a

Channel	Channel Frequency (MHz)	Occupied Bandwidth (MHz)	
		Chain 0	Chain 1
36	5180	16.80	16.80
40	5200	16.80	16.80
48	5240	16.92	16.92
52	5260	17.04	17.04
60	5300	17.04	16.92
64	5320	16.92	16.92
100	5500	17.28	17.04
116	5580	16.92	16.92
140	5700	17.04	16.80
144 (UNII-2C Band)	5720	13.52	13.52
144 (UNII-3 Band)	5720	3.52	3.40
149	5745	17.04	16.80
157	5785	16.92	16.92
165	5825	16.92	16.92

## 802.11ac (VHT20)

Channel	Channel Frequency (MHz)	Occupied Bandwidth (MHz)	
		Chain 0	Chain 1
36	5180	18.00	18.00
40	5200	18.00	18.00
48	5240	18.12	18.12
52	5260	18.00	18.36
60	5300	18.00	18.12
64	5320	18.12	18.24
100	5500	18.36	18.12
116	5580	18.12	18.12
140	5700	18.12	18.12
144 (UNII-2C Band)	5720	14.24	14.12
144 (UNII-3 Band)	5720	4.00	4.00
149	5745	18.00	18.12
157	5785	18.00	18.12
165	5825	18.12	18.00

**802.11ac (VHT40)**

Channel	Channel Frequency (MHz)	Occupied Bandwidth (MHz)	
		Chain 0	Chain 1
38	5190	36.96	36.96
46	5230	37.20	37.44
54	5270	36.96	36.96
62	5310	36.96	36.96
102	5510	36.72	36.72
110	5550	36.96	36.96
134	5670	37.44	37.20
142 (UNII-2C Band)	5710	33.60	33.40
142 (UNII-3 Band)	5710	3.40	3.40
151	5755	37.44	37.44
159	5795	37.68	36.96

**802.11ac (VHT80)**

Channel	Channel Frequency (MHz)	Occupied Bandwidth (MHz)	
		Chain 0	Chain 1
42	5210	75.84	75.84
58	5290	75.84	76.32
106	5530	76.32	76.32
122	5610	76.32	76.32
138 (UNII-2C Band)	5690	72.92	72.92
138 (UNII-3 Band)	5690	2.92	2.92
155	5775	76.32	76.32

### Spectrum Plot of Worst Value

#### 802.11a / Chain 0 : CH100

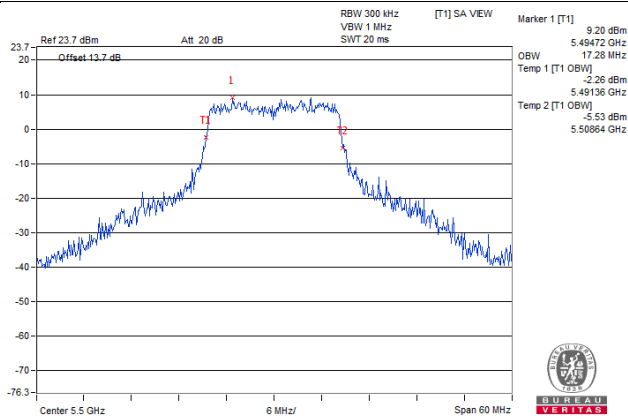

#### 802.11ac (VHT20) / Chain 0 : CH100

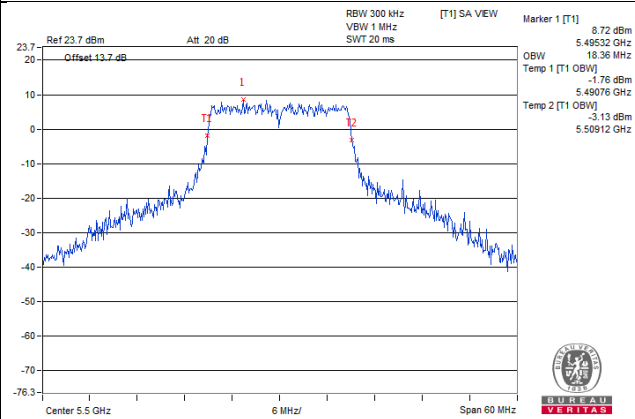

#### 802.11ac (VHT40) / Chain 0 : CH159

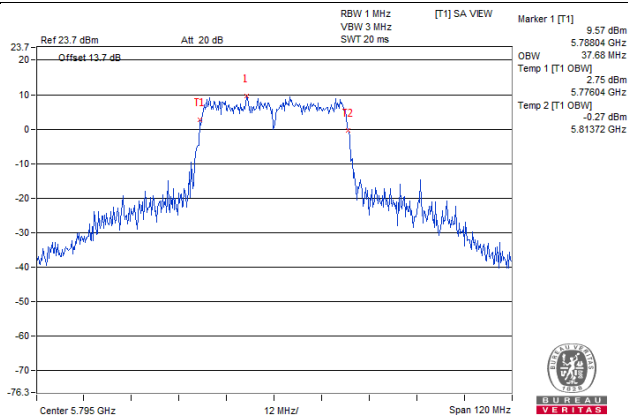

#### 802.11ac (VHT80) / Chain 0 : CH106

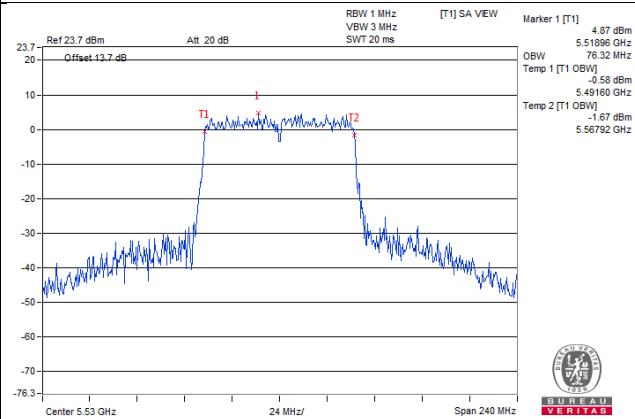

### Spectrum Plot for near by DFS band (DFS is required, if 99% OCP straddle into U-NII-2A band)

**802.11a\_Chain0 / CH48**

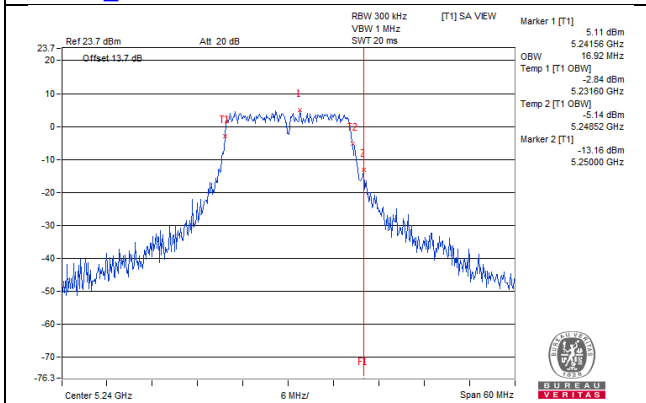

**802.11a\_Chain1 / CH48**

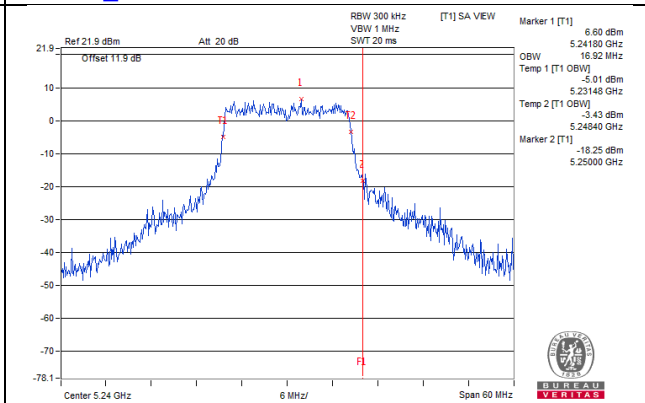

**802.11ac(VHT20)\_Chain0 / CH48**

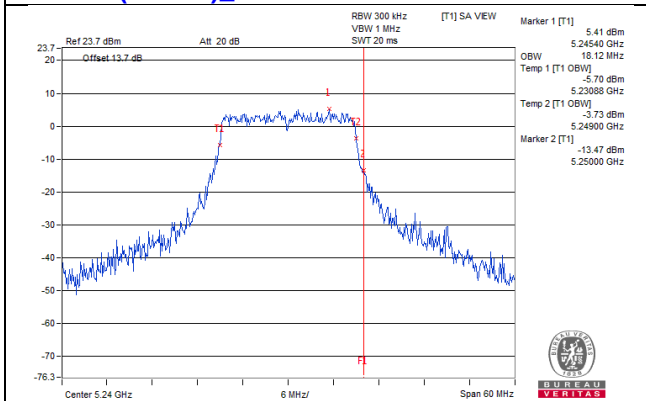

**802.11ac(VHT20)\_Chain1 / CH48**

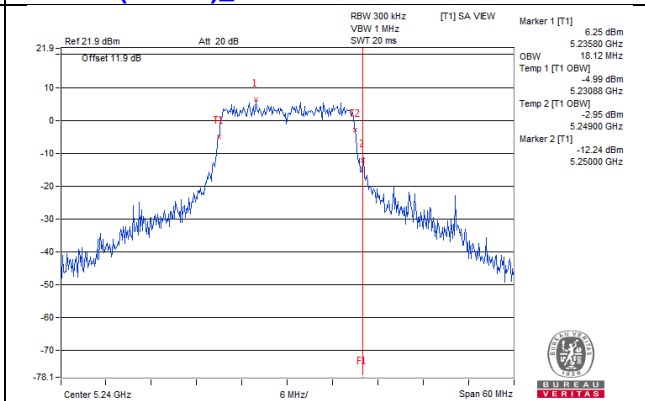

**802.11ac(VHT40)\_Chain0 / CH46**

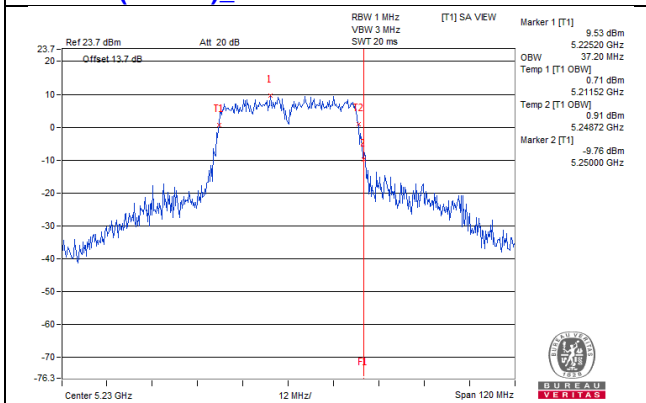

**802.11ac(VHT40)\_Chain1 / CH46**

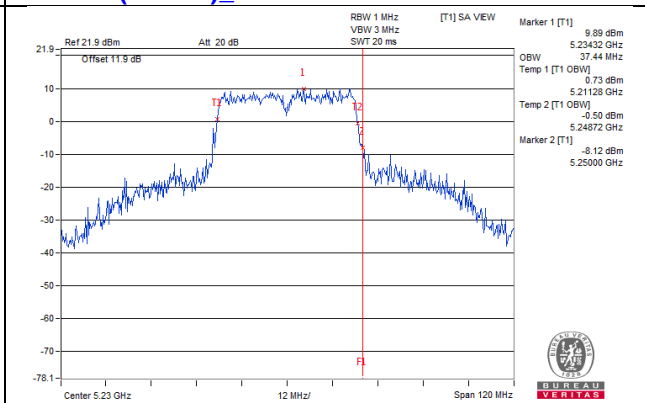

**802.11ac(VHT80)\_Chain0 / CH42**

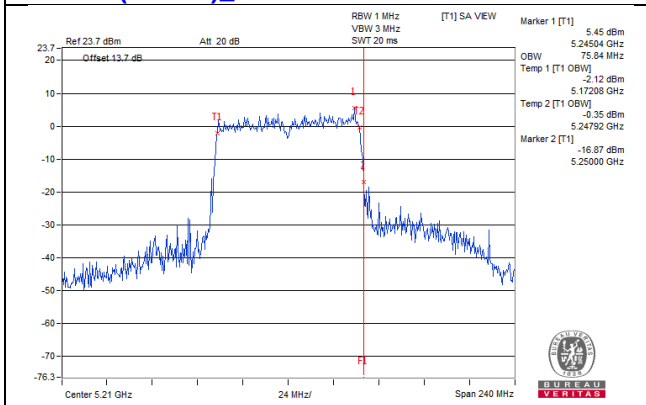

**802.11ac(VHT80)\_Chain1 / CH42**

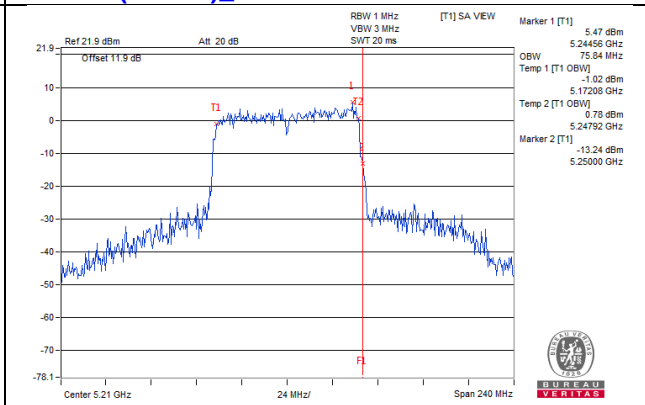

**Spectrum Plot for near by DFS band  
(DFS is required, if 99% OCP straddle into U-NII-2C band)**

**802.11a\_Chain0 / CH149**

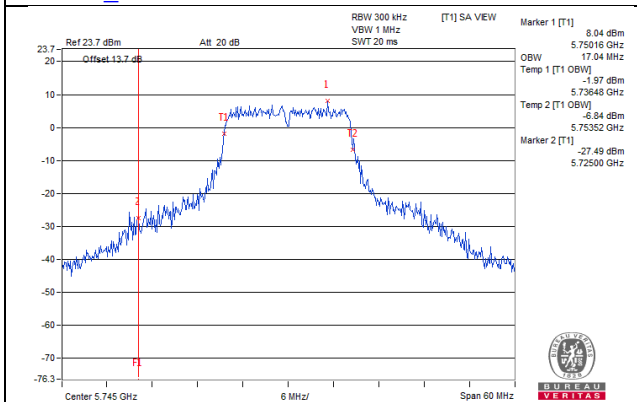

**802.11a\_Chain1 / CH149**

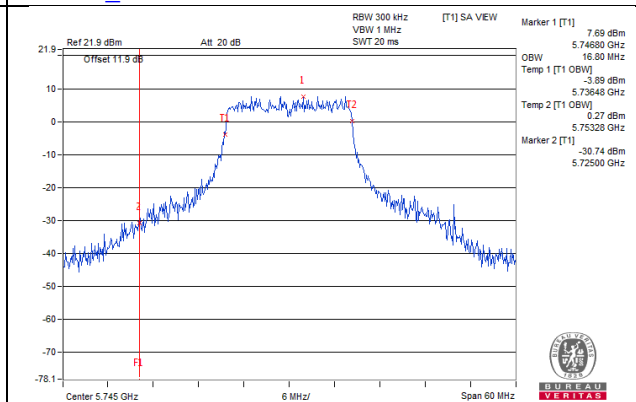

**802.11ac(VHT20)\_Chain0 / CH149**

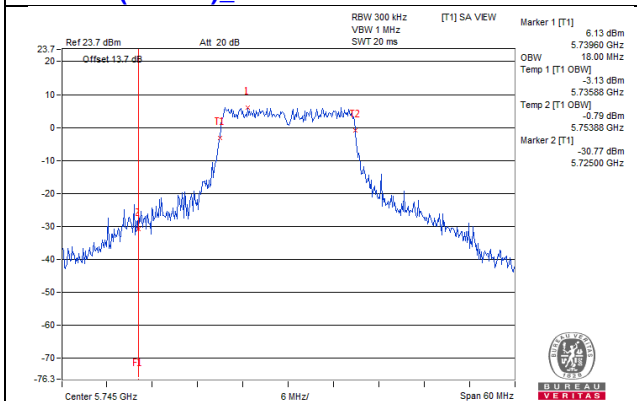

**802.11ac(VHT20)\_Chain1 / CH149**

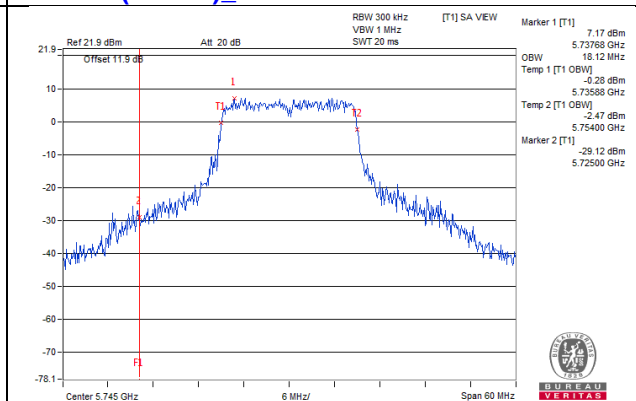

**802.11ac(VHT40)\_Chain0 / CH151**

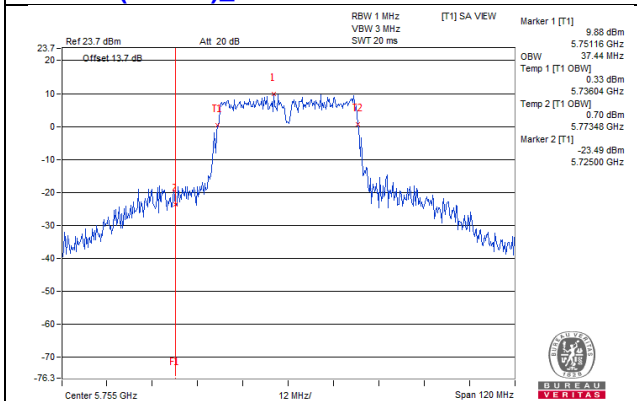

**802.11ac(VHT40)\_Chain1 / CH151**

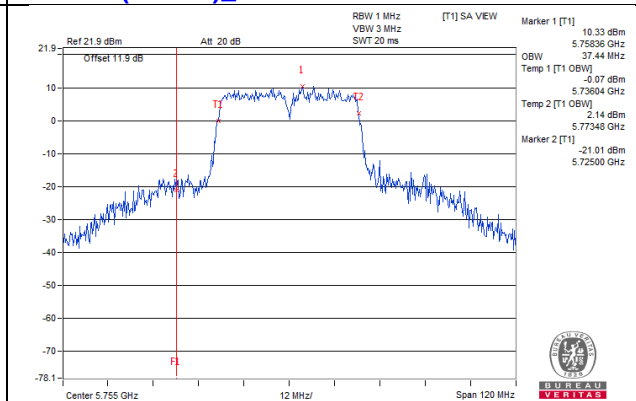

**802.11ac(VHT80)\_Chain0 / CH155**

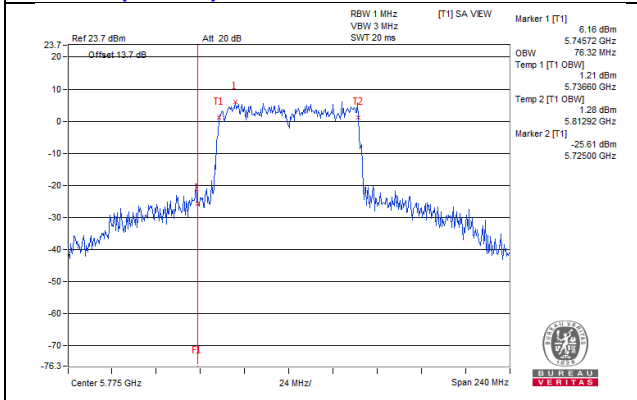

**802.11ac(VHT80)\_Chain1 / CH155**

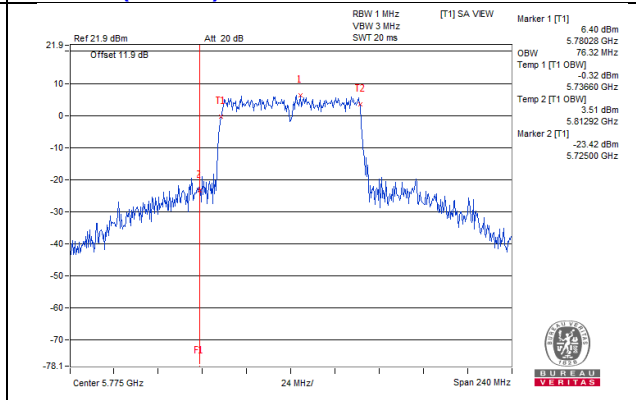

## 4.5 Peak Power Spectral Density Measurement

### 4.5.1 Limits of Peak Power Spectral Density Measurement

Operation Band	EUT Category		Limit
U-NII-1		Outdoor Access Point	17dBm/ MHz
		Fixed point-to-point Access Point	
		Indoor Access Point	
	√	Client device	11dBm/ MHz
U-NII-2A		√	11dBm/ MHz
U-NII-2C		√	11dBm/ MHz
U-NII-3		√	30dBm/ 500kHz

### 4.5.2 Test Setup

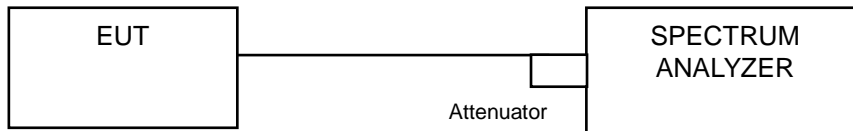

### 4.5.3 Test Instruments

Refer to section 4.1.2 to get information of above instrument.

### 4.5.4 Test Procedure

#### For U-NII-1, U-NII-2A, U-NII-2C:

Using method SA-2

1. Set span to encompass the entire emission bandwidth (EBW) of the signal.
2. Set RBW = 1 MHz, Set VBW  $\geq$  3 MHz, Detector = RMS
3. Sweep time = auto, trigger set to "free run".
4. Trace average at least 100 traces in power averaging mode.
5. Record the max value and add 10 log (1/duty cycle)

#### For U-NII-3:

1. Set span to encompass the entire emission bandwidth (EBW) of the signal.
2. Set RBW = 300 kHz, Set VBW  $\geq$  1 MHz, Detector = RMS
3. Use the peak marker function to determine the maximum power level in any 300 kHz band segment within the fundamental EBW.
4. Scale the observed power level to an equivalent value in 500 kHz by adjusting (reducing) the measured power by a bandwidth correction factor (BWCF) where  $BWCF = 10\log(500\text{ kHz}/300\text{kHz})$
5. Sweep time = auto, trigger set to "free run".
6. Trace average at least 100 traces in power averaging mode.
7. Record the max value and add 10 log (1/duty cycle)

#### 4.5.5 Deviation from Test Standard

No deviation.

#### 4.5.6 EUT Operating Condition

Same as Item 4.3.6.

#### 4.5.7 Test Results

**For U-NII-1, U-NII-2A, U-NII-2C:**

##### 802.11a

Chan.	Chan. Freq. (MHz)	PSD W/O Duty Factor (dBm/MHz)		Duty Factor (dB)	Total PSD With Duty Factor (dBm/MHz)	MAX. Limit (dBm/MHz)	Pass / Fail
		Chain 0	Chain 1				
36	5180	-0.11	0.42	0.25	3.42	11.00	Pass
40	5200	-0.02	1.01	0.25	3.78	11.00	Pass
48	5240	0.21	0.66	0.25	3.70	11.00	Pass
52	5260	1.77	2.68	0.25	5.51	11.00	Pass
60	5300	2.70	2.94	0.25	6.08	11.00	Pass
64	5320	2.46	3.30	0.25	6.16	11.00	Pass
100	5500	3.63	3.31	0.25	6.73	11.00	Pass
116	5580	4.00	3.19	0.25	6.87	11.00	Pass
140	5700	2.91	3.33	0.25	6.38	11.00	Pass
144 (UNII-2C Band)	5720	2.64	2.42	0.25	5.79	11.00	Pass

- Note:**
- Method a) of power density measurement of KDB 662911 is using for calculating total power density. Total power density is summing entire spectra across corresponding frequency bins on the various outputs by computer.
  - Directional gain =  $10 \log[(10^{G_0/20} + 10^{G_1/20})^2 / 2] = 5.3 < 6\text{dBi}$ , so the power density limit shall not be reduced.
  - Refer to section 3.3 for duty cycle spectrum plot.



### 802.11ac (VHT20)

Chan.	Chan. Freq. (MHz)	PSD W/O Duty Factor (dBm/MHz)		Duty Factor (dB)	Total PSD With Duty Factor (dBm/MHz)	MAX. Limit (dBm/MHz)	Pass / Fail
		Chain 0	Chain 1				
36	5180	-0.20	0.26	0.23	3.27	11.00	Pass
40	5200	0.03	0.13	0.23	3.32	11.00	Pass
48	5240	0.69	0.44	0.23	3.80	11.00	Pass
52	5260	2.13	2.10	0.23	5.35	11.00	Pass
60	5300	2.83	2.71	0.23	6.01	11.00	Pass
64	5320	2.51	2.14	0.23	5.57	11.00	Pass
100	5500	3.93	2.97	0.23	6.71	11.00	Pass
116	5580	3.58	3.28	0.23	6.67	11.00	Pass
140	5700	3.15	2.68	0.23	6.16	11.00	Pass
144 (UNII-2C Band)	5720	2.68	2.45	0.23	5.80	11.00	Pass

- Note:**
- Method a) of power density measurement of KDB 662911 is using for calculating total power density. Total power density is summing entire spectra across corresponding frequency bins on the various outputs by computer.
  - Directional gain =  $10 \log[(10^{G0/20} + 10^{G1/20})^2 / 2] = 5.3 < 6\text{dBi}$ , so the power density limit shall not be reduced.
  - Refer to section 3.3 for duty cycle spectrum plot.

**802.11ac (VHT40)**

Chan.	Chan. Freq. (MHz)	PSD W/O Duty Factor (dBm/MHz)		Duty Factor (dB)	Total PSD With Duty Factor (dBm/MHz)	MAX. Limit (dBm/MHz)	Pass / Fail
		Chain 0	Chain 1				
38	5190	-3.92	-5.15	0.40	-1.08	11.00	Pass
46	5230	-2.44	-0.09	0.40	2.31	11.00	Pass
54	5270	-1.91	-2.26	0.40	1.33	11.00	Pass
62	5310	-4.45	-3.75	0.40	-0.67	11.00	Pass
102	5510	-1.80	-3.17	0.40	0.98	11.00	Pass
110	5550	-0.19	-1.52	0.40	2.61	11.00	Pass
134	5670	-0.78	-0.82	0.40	2.61	11.00	Pass
142 (UNII-2C Band)	5710	0.42	0.04	0.40	3.65	11.00	Pass

- Note:**
- Method a) of power density measurement of KDB 662911 is using for calculating total power density. Total power density is summing entire spectra across corresponding frequency bins on the various outputs by computer.
  - Directional gain =  $10 \log[(10^{G0/20} + 10^{G1/20})^2 / 2] = 5.3 < 6\text{dBi}$ , so the power density limit shall not be reduced.
  - Refer to section 3.3 for duty cycle spectrum plot.

**802.11ac (VHT80)**

Chan.	Chan. Freq. (MHz)	PSD W/O Duty Factor (dBm/MHz)		Duty Factor (dB)	Total PSD With Duty Factor (dBm/MHz)	MAX. Limit (dBm/MHz)	Pass / Fail
		Chain 0	Chain 1				
42	5210	-10.22	-7.72	0.86	-4.92	11.00	Pass
58	5290	-7.56	-7.02	0.86	-3.41	11.00	Pass
106	5530	-6.35	-10.72	0.86	-4.13	11.00	Pass
122	5610	-5.05	-4.66	0.86	-0.98	11.00	Pass
138 (UNII-2C Band)	5690	-5.62	-4.67	0.86	-1.25	11.00	Pass

- Note:**
- Method a) of power density measurement of KDB 662911 is using for calculating total power density. Total power density is summing entire spectra across corresponding frequency bins on the various outputs by computer.
  - Directional gain =  $10 \log[(10^{G0/20} + 10^{G1/20})^2 / 2] = 5.3 < 6\text{dBi}$ , so the power density limit shall not be reduced.
  - Refer to section 3.3 for duty cycle spectrum plot.

### Spectrum Plot of Worst Value

**802.11a / Chain 0 : CH116**

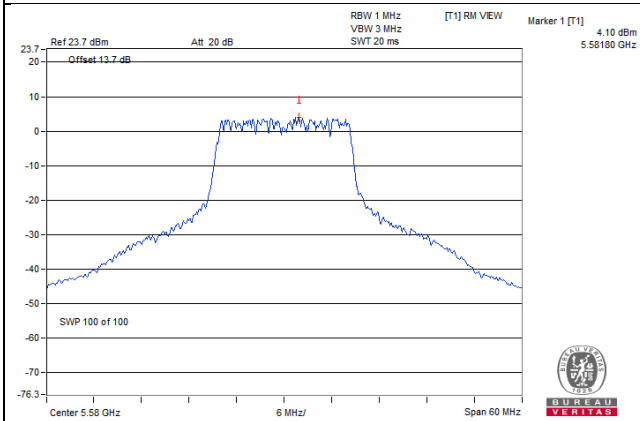

**802.11ac (VHT20) / Chain 0 : CH100**

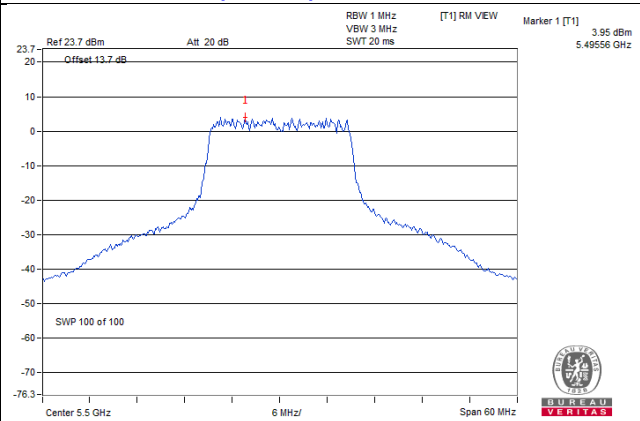

**802.11ac (VHT40) / Chain 0 : CH142 (UNII-2C)**

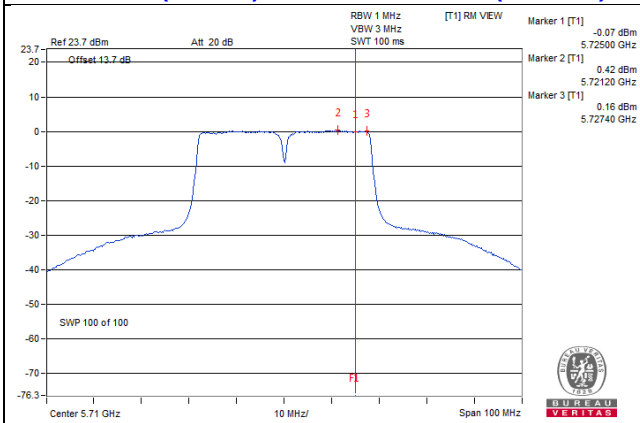

**802.11ac (VHT80) / Chain 1 : CH122**

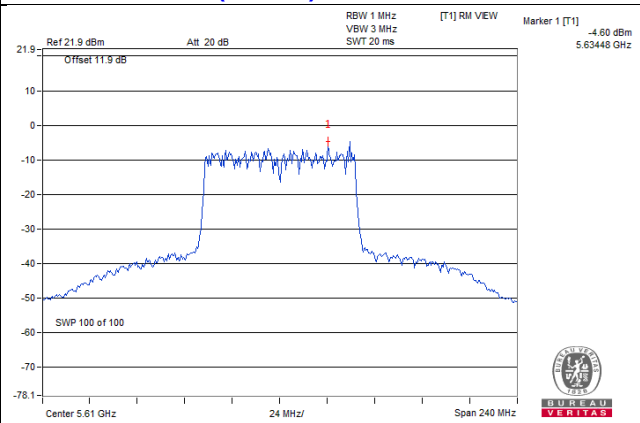

**For U-NII-3:**
**802.11a**

TX chain	Chan.	Chan. Freq. (MHz)	PSD W/O Duty Factor		10 log (N=2) dB	Duty Factor (dB)	Total PSD With Duty Factor (dBm/500kHz)	Limit (dBm/500kHz)	Pass /Fail
			(dBm/300kHz)	(dBm/500kHz)					
0	144 (U-NII-3 Band)	5720	-5.82	-3.60	3.01	0.25	-0.34	30.00	Pass
	149	5745	-5.45	-3.23	3.01	0.25	0.03	30.00	Pass
	157	5785	-5.56	-3.34	3.01	0.25	-0.08	30.00	Pass
	165	5825	-5.02	-2.80	3.01	0.25	0.46	30.00	Pass
1	144 (U-NII-3 Band)	5720	-6.03	-3.81	3.01	0.25	-0.55	30.00	Pass
	149	5745	-5.37	-3.15	3.01	0.25	0.11	30.00	Pass
	157	5785	-4.65	-2.43	3.01	0.25	0.83	30.00	Pass
	165	5825	-4.92	-2.70	3.01	0.25	0.56	30.00	Pass

**Note:** 1. Directional gain =  $10 \log[(10^{G0/20} + 10^{G1/20})^2 / 2] = 5.3\text{dBi} < 6\text{dBi}$ , so the power density limit shall not be reduced.

2. Refer to section 3.3 for duty cycle spectrum plot.

**802.11ac (VHT20)**

TX chain	Chan.	Chan. Freq. (MHz)	PSD W/O Duty Factor		10 log (N=2) dB	Duty Factor (dB)	Total PSD With Duty Factor (dBm/500kHz)	Limit (dBm/500kHz)	Pass /Fail
			(dBm/300kHz)	(dBm/500kHz)					
0	144 (U-NII-3 Band)	5720	-5.08	-2.86	3.01	0.23	0.38	30.00	Pass
	149	5745	-5.11	-2.89	3.01	0.23	0.35	30.00	Pass
	157	5785	-5.93	-3.71	3.01	0.23	-0.47	30.00	Pass
	165	5825	-5.96	-3.74	3.01	0.23	-0.50	30.00	Pass
1	144 (U-NII-3 Band)	5720	-5.08	-2.86	3.01	0.23	0.38	30.00	Pass
	149	5745	-5.30	-3.08	3.01	0.23	0.16	30.00	Pass
	157	5785	-5.12	-2.90	3.01	0.23	0.34	30.00	Pass
	165	5825	-4.99	-2.77	3.01	0.23	0.47	30.00	Pass

**Note:** 1. Directional gain =  $10 \log[(10^{G0/20} + 10^{G1/20})^2 / 2] = 5.3\text{dBi} < 6\text{dBi}$ , so the power density limit shall not be reduced.

2. Refer to section 3.3 for duty cycle spectrum plot.

### 802.11ac (VHT40)

TX chain	Chan.	Chan. Freq. (MHz)	PSD W/O Duty Factor		10 log (N=2) dB	Duty Factor (dB)	Total PSD With Duty Factor (dBm/500kHz)	Limit (dBm/500kHz)	Pass /Fail
			(dBm/300kHz)	(dBm/500kHz)					
0	142 (U-NII-3 Band)	5710	-8.00	-5.78	3.01	0.40	-2.37	30.00	Pass
	151	5755	-9.96	-7.74	3.01	0.40	-4.33	30.00	Pass
	159	5795	-10.30	-8.08	3.01	0.40	-4.67	30.00	Pass
1	142 (U-NII-3 Band)	5710	-8.14	-5.92	3.01	0.40	-2.51	30.00	Pass
	151	5755	-9.24	-7.02	3.01	0.40	-3.61	30.00	Pass
	159	5795	-9.05	-6.83	3.01	0.40	-3.42	30.00	Pass

**Note:** 1. Directional gain =  $10 \log[(10^{G0/20} + 10^{G1/20})^2 / 2] = 5.3\text{dBi} < 6\text{dBi}$ , so the power density limit shall not be reduced.

2. Refer to section 3.3 for duty cycle spectrum plot.

### 802.11ac (VHT80)

TX chain	Chan.	Chan. Freq. (MHz)	PSD W/O Duty Factor		10 log (N=2) dB	Duty Factor (dB)	Total PSD With Duty Factor (dBm/500kHz)	Limit (dBm/500kHz)	Pass /Fail
			(dBm/300kHz)	(dBm/500kHz)					
0	138 (U-NII-3 Band)	5690	-13.18	-10.96	3.01	0.86	-7.09	30.00	Pass
	155	5775	-12.87	-10.65	3.01	0.86	-6.78	30.00	Pass
1	138 (U-NII-3 Band)	5690	-12.51	-10.29	3.01	0.86	-6.42	30.00	Pass
	155	5775	-12.44	-10.22	3.01	0.86	-6.35	30.00	Pass

**Note:** 1. Directional gain =  $10 \log[(10^{G0/20} + 10^{G1/20})^2 / 2] = 5.3\text{dBi} < 6\text{dBi}$ , so the power density limit shall not be reduced.

2. Refer to section 3.3 for duty cycle spectrum plot.

**Spectrum Plot of Worst Value**

**802.11a / Chain 1 : CH157**

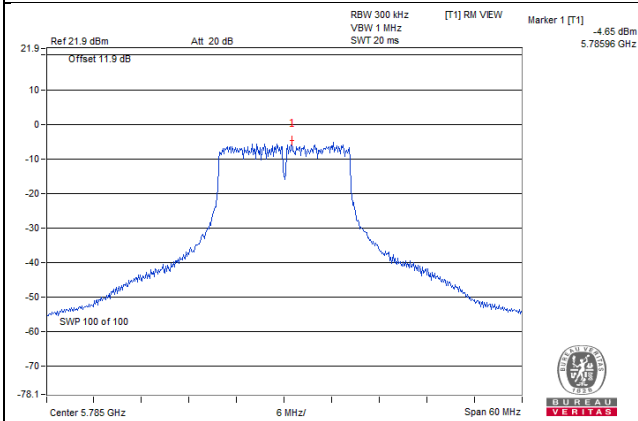

**802.11ac (VHT20) / Chain 1 : CH165**

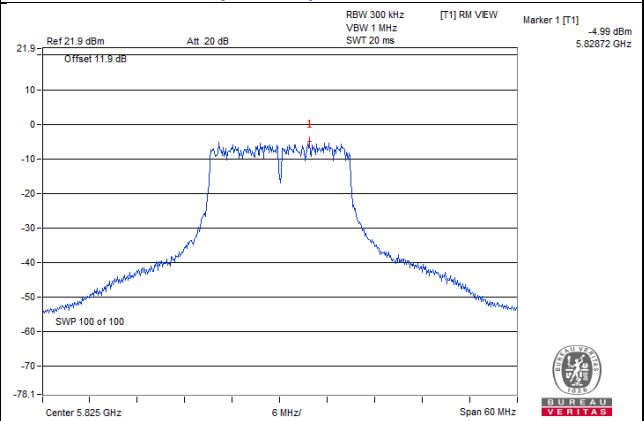

**802.11ac (VHT40) / Chain 0 : CH142 (UNII-3)**

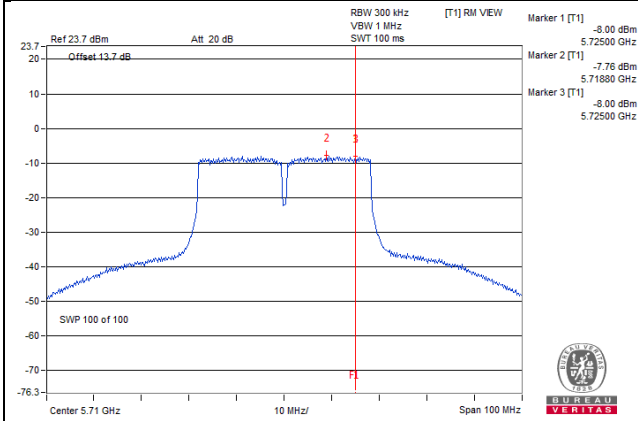

**802.11ac (VHT80) / Chain 1 : CH155**

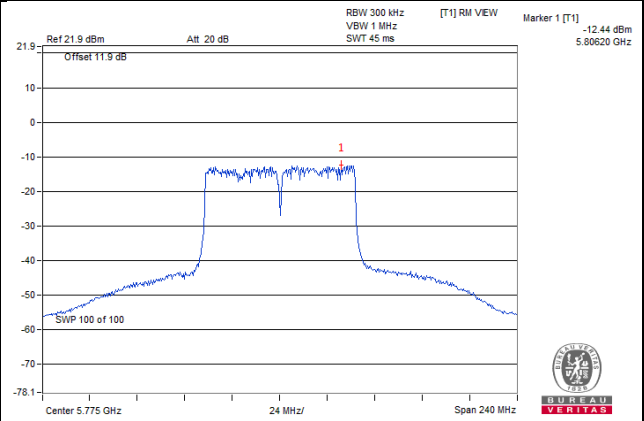

## 4.6 Frequency Stability Measurement

### 4.6.1 Limits of Frequency Stability Measurement

The frequency of the carrier signal shall be maintained within band of operation

### 4.6.2 Test Setup

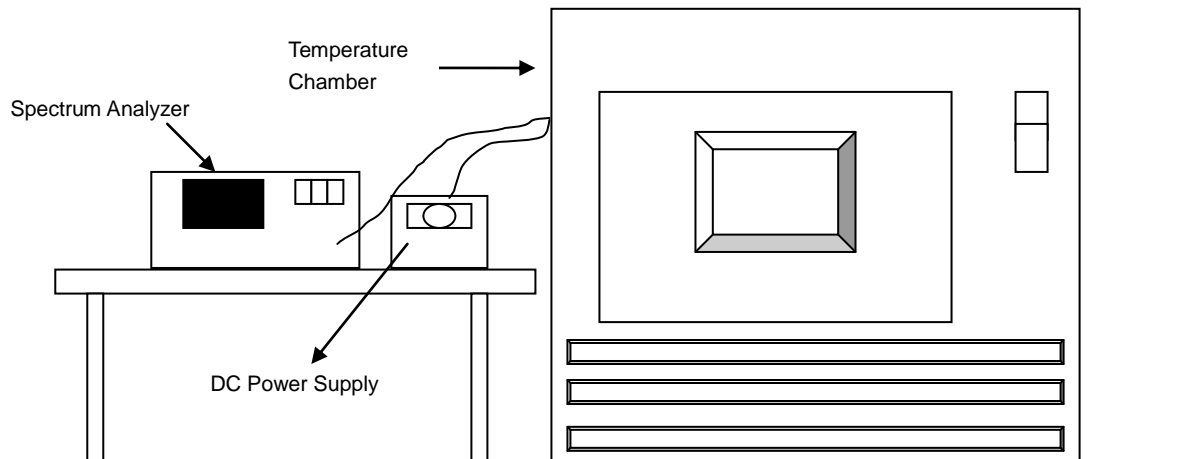

### 4.6.3 Test Instruments

Refer to section 4.1.2 to get information of above instrument.

### 4.6.4 Test Procedure

- The EUT was placed inside the environmental test chamber and powered by nominal DC voltage.
- Turn the EUT on and couple its output to a spectrum analyzer.
- Turn the EUT off and set the chamber to the highest temperature specified.
- Allow sufficient time (approximately 30 min) for the temperature of the chamber to stabilize, turn the EUT on and measure the operating frequency after 2, 5, and 10 Minutes.
- Repeat step 2 and 3 with the temperature chamber set to the lowest temperature.
- The test chamber was allowed to stabilize at +20 degree C for a minimum of 30 Minutes. The supply voltage was then adjusted on the EUT from 85% to 115% and the frequency record.

### 4.6.5 Deviation from Test Standard

No deviation.

### 4.6.6 EUT Operating Condition

Set the EUT transmit at un-modulation mode to test frequency stability.

## 4.6.7 Test Results

Frequency Stability Versus Temp.									
Operating Frequency: 5180 MHz									
TEMP. (°C)	Power Supply (Vdc)	0 Minute		2 Minutes		5 Minutes		10 Minutes	
		Measured Frequency (MHz)	Pass/Fail	Measured Frequency (MHz)	Pass/Fail	Measured Frequency (MHz)	Pass/Fail	Measured Frequency (MHz)	Pass/Fail
50	3.85	5179.9901	PASS	5179.9916	PASS	5179.9931	PASS	5179.9897	PASS
40	3.85	5180.0011	PASS	5180.0006	PASS	5179.9987	PASS	5179.9986	PASS
30	3.85	5180.0241	PASS	5180.0208	PASS	5180.0209	PASS	5180.0253	PASS
20	3.85	5179.9752	PASS	5179.9768	PASS	5179.9772	PASS	5179.9729	PASS
10	3.85	5179.9755	PASS	5179.9734	PASS	5179.9731	PASS	5179.9769	PASS
0	3.85	5180.0242	PASS	5180.0279	PASS	5180.0259	PASS	5180.025	PASS
-10	3.85	5179.9787	PASS	5179.9747	PASS	5179.9789	PASS	5179.9752	PASS
-20	3.85	5180.0133	PASS	5180.0108	PASS	5180.0112	PASS	5180.0121	PASS
-30	3.85	5180.0015	PASS	5179.9982	PASS	5180.0012	PASS	5180.0007	PASS

Frequency Stability Versus Voltage									
Operating Frequency: 5180 MHz									
TEMP. (°C)	Power Supply (Vdc)	0 Minute		2 Minutes		5 Minutes		10 Minutes	
		Measured Frequency (MHz)	Pass/Fail	Measured Frequency (MHz)	Pass/Fail	Measured Frequency (MHz)	Pass/Fail	Measured Frequency (MHz)	Pass/Fail
20	4.4275	5179.9744	PASS	5179.977	PASS	5179.977	PASS	5179.9727	PASS
	3.85	5179.9752	PASS	5179.9768	PASS	5179.9772	PASS	5179.9729	PASS
	3.2725	5179.975	PASS	5179.9772	PASS	5179.9771	PASS	5179.9735	PASS



## 4.7 6dB Bandwidth Measurement

### 4.7.1 Limits of 6dB Bandwidth Measurement

The minimum of 6dB Bandwidth Measurement is 0.5MHz.

### 4.7.2 Test Setup

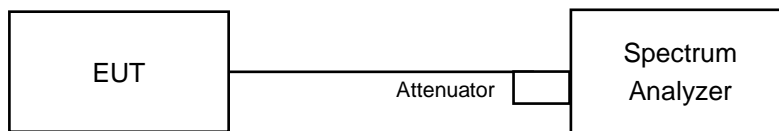

### 4.7.3 Test Instruments

Refer to section 4.1.2 to get information of above instrument.

### 4.7.4 Test Procedure

#### MEASUREMENT PROCEDURE REF

- a. Set resolution bandwidth (RBW) = 100kHz
- b. Set the video bandwidth (VBW)  $\geq 3 \times$  RBW, Detector = Peak.
- c. Trace mode = max hold.
- d. Sweep = auto couple.
- e. Measure the maximum width of the emission that is constrained by the frequencies associated with the two amplitude points (upper and lower) that are attenuated by 6 dB relative to the maximum level measured in the fundamental emission

### 4.7.5 Deviation from Test Standard

No deviation.

### 4.7.6 EUT Operating Condition

The software provided by client to enable the EUT under transmission condition continuously at lowest, middle and highest channel frequencies individually.

#### 4.7.7 Test Results

##### 802.11a

Channel	Frequency (MHz)	6dB Bandwidth (MHz)		Minimum Limit (MHz)	Pass / Fail
		Chain 0	Chain 1		
144 (UNII-3 Band)	5720	3.18	3.18	0.5	PASS
149	5745	16.43	16.42	0.5	PASS
157	5785	16.41	16.43	0.5	PASS
165	5825	16.43	16.41	0.5	PASS

##### 802.11ac (VHT20)

Channel	Frequency (MHz)	6dB Bandwidth (MHz)		Minimum Limit (MHz)	Pass / Fail
		Chain 0	Chain 1		
144 (UNII-3 Band)	5720	3.81	3.81	0.5	PASS
149	5745	17.67	17.65	0.5	PASS
157	5785	17.63	17.66	0.5	PASS
165	5825	17.64	17.64	0.5	PASS

##### 802.11ac (VHT40)

Channel	Frequency (MHz)	6dB Bandwidth (MHz)		Minimum Limit (MHz)	Pass / Fail
		Chain 0	Chain 1		
142 (UNII-3 Band)	5710	3.23	3.24	0.5	PASS
151	5755	36.48	36.47	0.5	PASS
159	5795	36.49	36.46	0.5	PASS

##### 802.11ac (VHT80)

Channel	Frequency (MHz)	6dB Bandwidth (MHz)		Minimum Limit (MHz)	Pass / Fail
		Chain 0	Chain 1		
138 (UNII-3 Band)	5690	3.21	3.25	0.5	PASS
155	5775	76.48	76.29	0.5	PASS

**Spectrum Plot of Worst Value**

**802.11a / Chain 0 : CH144 (U-NII-3)**

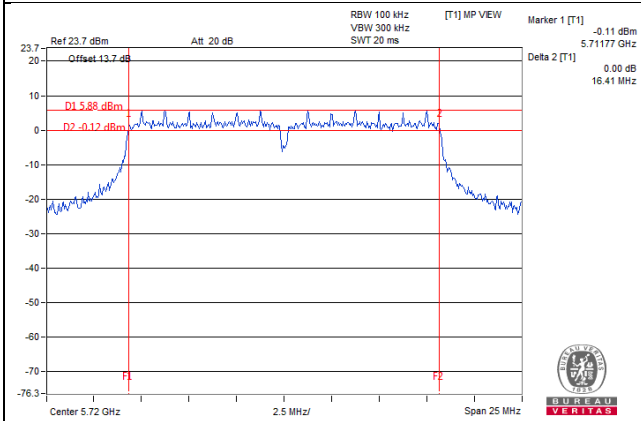

**802.11ac (VHT20) / Chain 0 : CH144 (U-NII-3)**

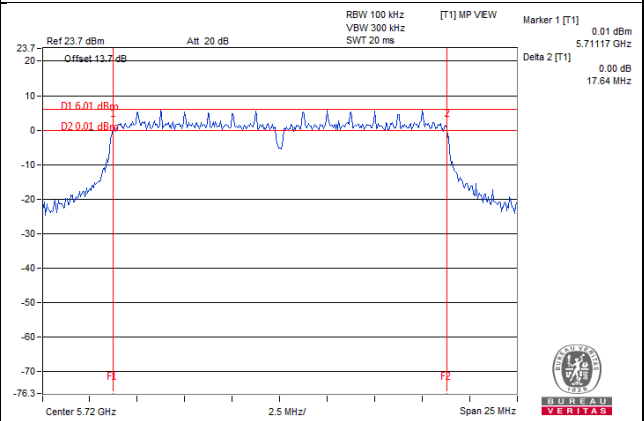

**802.11ac (VHT40) / Chain 0 : CH142 (U-NII-3)**

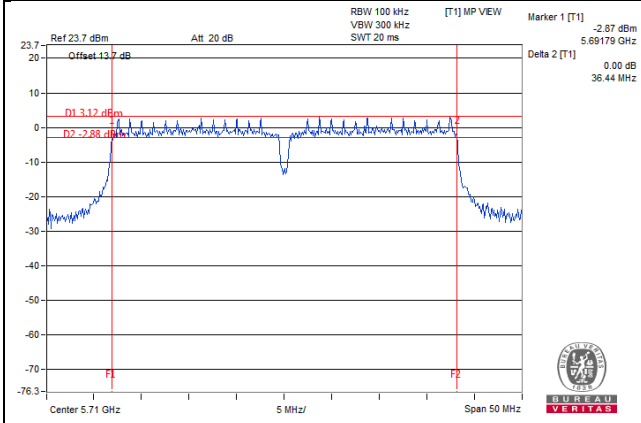

**802.11ac (VHT80) / Chain 0 : CH138 (U-NII-3)**

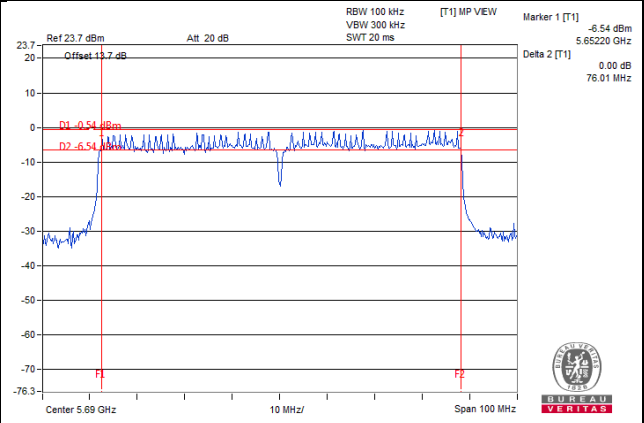

Note: The 6dB bandwidth above 5725MHz = Marker 1 + Delta 2 - 5725MHz

## 5 Pictures of Test Arrangements

Please refer to the attached file (Test Setup Photo).

### Annex A- Radiated Out of Band Emission (OOBE) Measurement (For U-NII-3 band)

802.11a

**CH 149 5745 MHz**

**Horizontal**

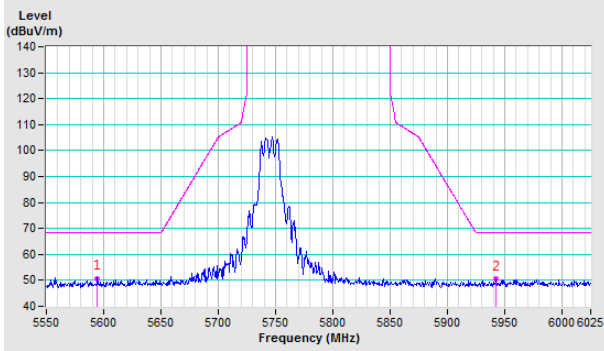

**Vertical**

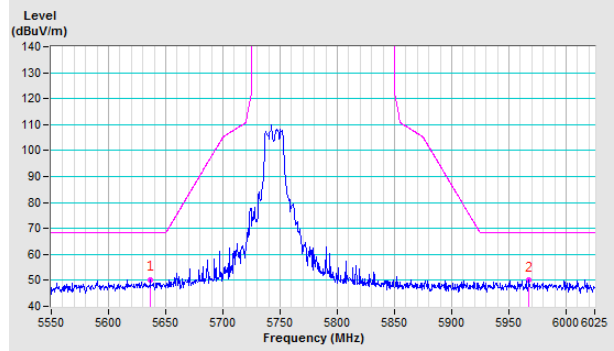

**CH 157 5785 MHz**

**Horizontal**

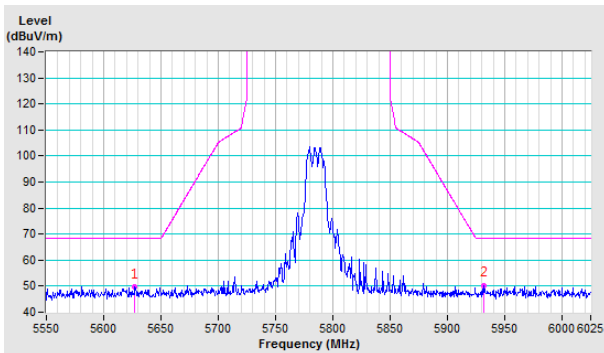

**Vertical**

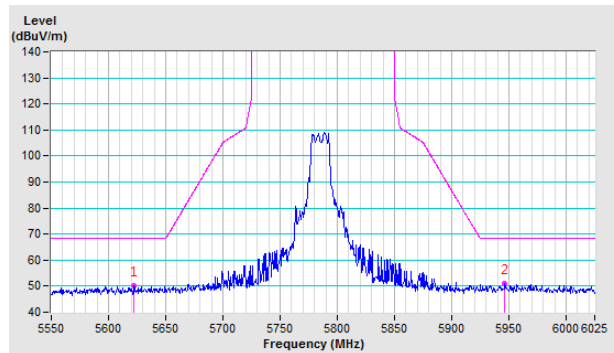

**CH 165 5825 MHz**

**Horizontal**

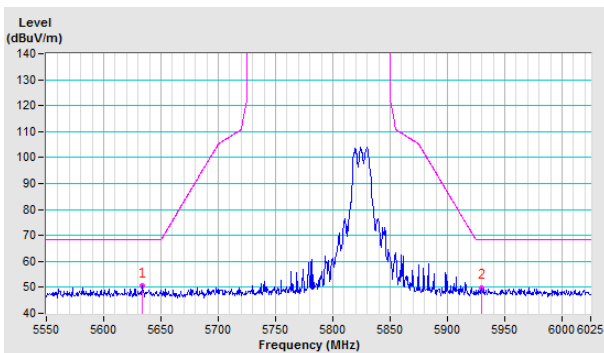

**Vertical**

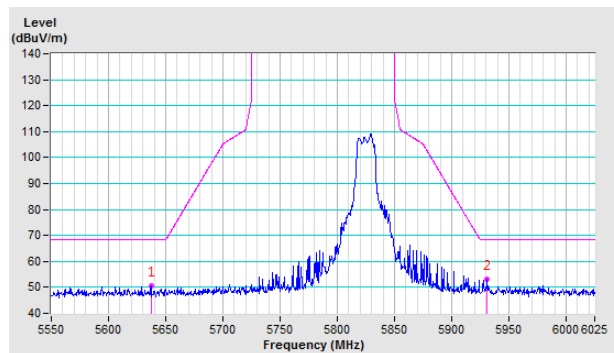

802.11ac (VHT20)

CH 149 5745 MHz

Horizontal

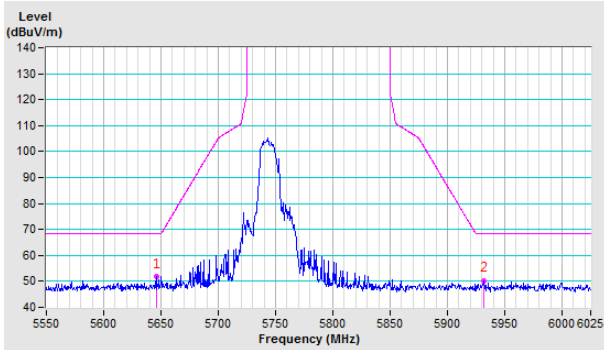

Vertical

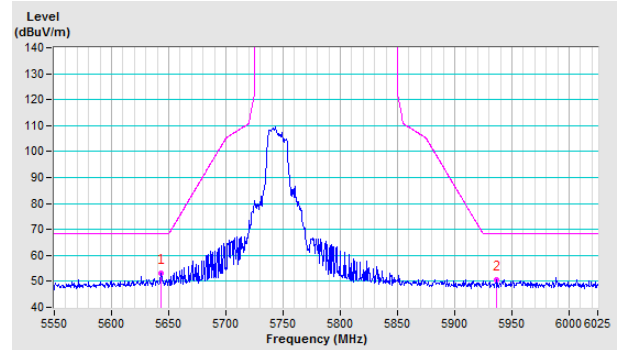

CH 157 5785 MHz

Horizontal

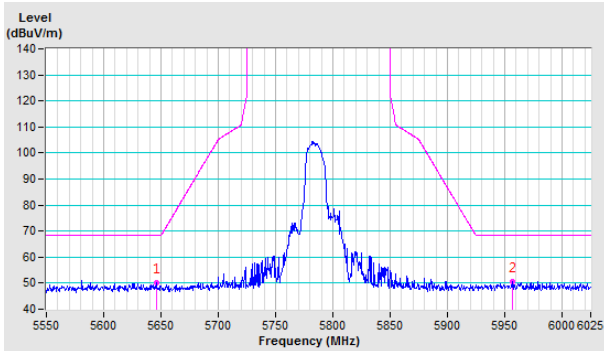

Vertical

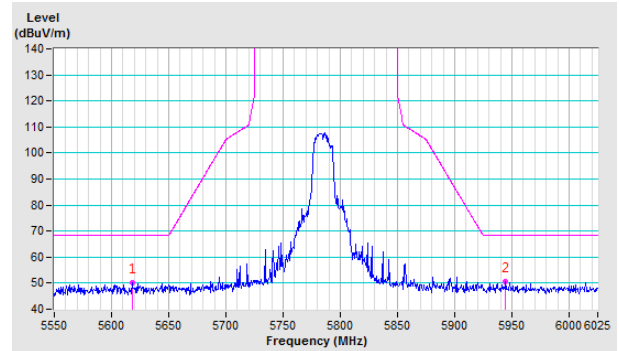

CH 165 5825 MHz

Horizontal

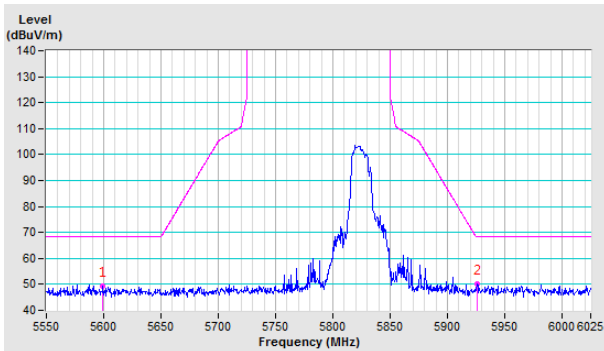

Vertical

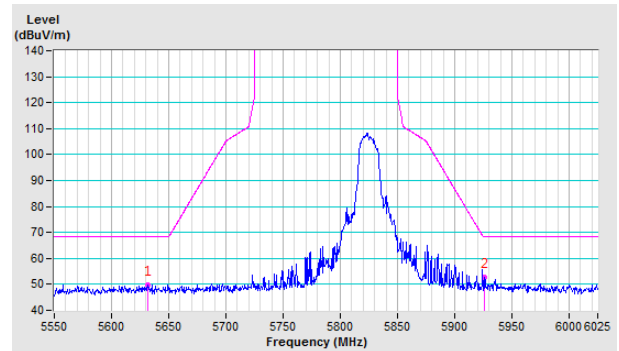

802.11ac (VHT40)

CH 151 5755 MHz

Horizontal

Vertical

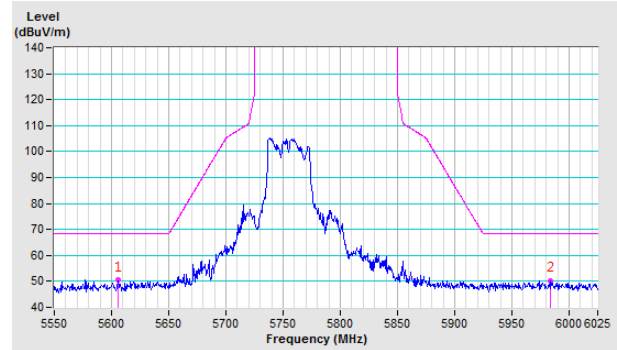
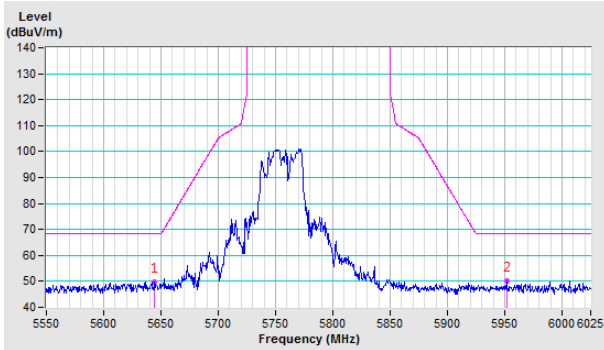

CH 159 5795 MHz

Horizontal

Vertical

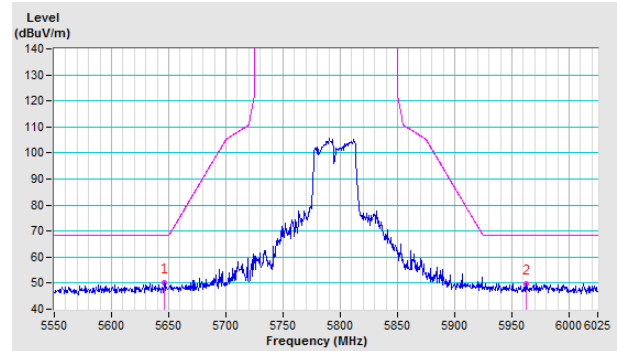
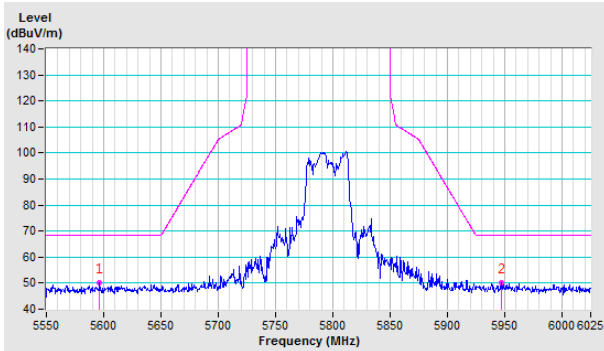

802.11ac (VHT80)

CH 155 5775 MHz

Horizontal

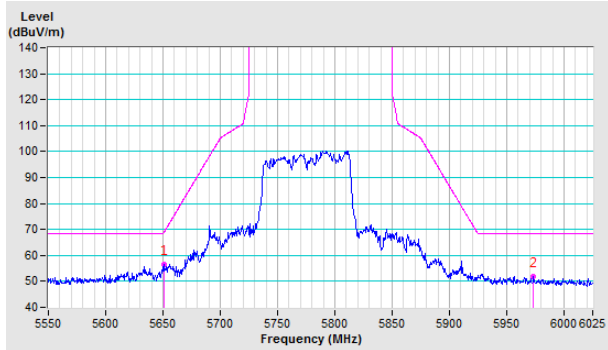

Vertical

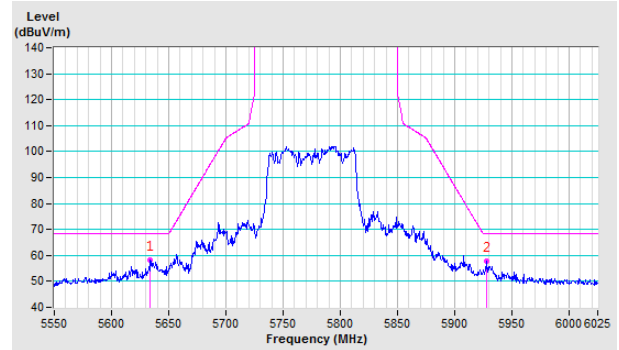



## Appendix – Information on the Testing Laboratories

We, Bureau Veritas Consumer Products Services (H.K.) Ltd., Taoyuan Branch, were founded in 1988 to provide our best service in EMC, Radio, Telecom and Safety consultation. Our laboratories are FCC recognized accredited test firms and accredited according to ISO/IEC 17025.

If you have any comments, please feel free to contact us at the following:

**Linko EMC/RF Lab**

Tel: 886-2-26052180

Fax: 886-2-26051924

**Hsin Chu EMC/RF/Telecom Lab**

Tel: 886-3-6668565

Fax: 886-3-6668323

**Hwa Ya EMC/RF/Safety Lab**

Tel: 886-3-3183232

Fax: 886-3-3270892

**Email:** [service.adt@tw.bureauveritas.com](mailto:service.adt@tw.bureauveritas.com)

**Web Site:** [www.bureauveritas-adt.com](http://www.bureauveritas-adt.com)

The address and road map of all our labs can be found in our web site also.

--- END ---