



Test report No:
2350171R-RF-US-P06V01

FCC & ISED TEST REPORT

| | |
|---|--|
| Product Name | Charge Base |
| Trademark | Honeywell |
| Model and /or type reference | 1962 Horizontal |
| FCC ID | HD5-1962CCBH |
| IC | 1693B-1962CCBH |
| Applicant's name / address | HONEYWELL INTERNATIONAL INC Honeywell Safety and Productivity Solutions 9680 OLD BAILES RD FORT MILL SC 29707-7539,USA |
| Test method requested, standard | CFR 47, FCC Part 15 C ANSI C63.10: 2013 RSS-Gen / RSS-247 |
| Verdict Summary | IN COMPLIANCE |
| Tested by (name / position & signature) | Jun Xu/ Project Engineer  |
| Approved by (name / position & signature) | Jack Zhang/ Manager  |
| Date of issue | 2023-06-16 |
| Report Version | V1.0 |
| Report template No | Template_FCC 15.247-RF-V1.0 |

INDEX

| | page |
|--|------|
| General conditions | 5 |
| Environmental conditions | 5 |
| Possible test case verdicts | 6 |
| Abbreviations..... | 6 |
| Document History..... | 7 |
| Remarks and Comments | 7 |
| Used Equipment..... | 8 |
| Uncertainty | 10 |
| 1 General Information | 11 |
| 1.1 General Description of the Item(s)..... | 11 |
| 1.2 Antenna Information | 12 |
| 1.3 Channel List..... | 13 |
| 2 Description of Test Setup..... | 14 |
| 2.1 Operating mode(s) used for tests | 14 |
| 2.2 Auxiliary equipment /Accessories/Test software for the EUT | 14 |
| 2.3 Test Configuration / Block diagram used for tests..... | 15 |
| 2.4 Testing process | 17 |
| 3 Verdict summary section..... | 18 |
| 3.1 Standards | 18 |
| 3.2 Deviation(s) from the Standard(s) / Test Specification(s)..... | 18 |
| 3.3 Overview of results | 19 |
| 3.4 Power setting in test | 21 |
| 3.5 Test Matrix | 22 |
| 3.6 Test Facility..... | 23 |
| 4 Test Items of limit/setup/procedure..... | 24 |
| 4.1 20dB Emission Bandwidth..... | 24 |
| 4.1.1 Limit | 24 |
| 4.1.2 Test Setup | 24 |
| 4.1.3 Test Procedure | 24 |
| 4.2 Occupied Channel Bandwidth | 25 |
| 4.2.1 Limit | 25 |
| 4.2.1 Test Setup | 25 |
| 4.2.3 Test Procedure | 25 |
| 4.3 Maximum Conducted Output Power..... | 26 |

| | | |
|--------|---------------------------------------|----|
| 4.3.1 | Limit | 26 |
| 4.3.2 | Test Setup | 26 |
| 4.3.3 | Test Procedure | 26 |
| 4.4 | Carrier Frequency Separation | 27 |
| 4.4.1 | Limit | 27 |
| 4.4.2 | Test Setup | 27 |
| 4.4.3 | Test Procedure | 27 |
| 4.5 | Time of Occupancy..... | 28 |
| 4.5.1 | Limit | 28 |
| 4.5.2 | Test Setup | 28 |
| 4.5.3 | Test Procedure | 28 |
| 4.6 | Number of hopping Frequencies | 29 |
| 4.6.1 | Limit | 29 |
| 4.6.2 | Test Setup | 29 |
| 4.6.3 | Test Procedure | 29 |
| 4.7 | Band edge measurements | 30 |
| 4.7.1 | Limit | 30 |
| 4.7.2 | Test Setup | 30 |
| 4.7.3 | Test Procedure | 30 |
| 4.8 | Conducted Spurious Emission | 31 |
| 4.8.1 | Limit | 31 |
| 4.8.2 | Test Setup | 31 |
| 4.8.3 | Test Procedure | 31 |
| 4.9 | Duty cycle | 32 |
| 4.9.1 | Limit | 32 |
| 4.9.2 | Test Setup | 32 |
| 4.9.3 | Test Procedure | 32 |
| 4.10 | Emissions in Restricted Bands | 33 |
| 4.10.1 | Limit | 33 |
| 4.10.2 | Test Setup | 35 |
| 4.10.3 | Test Procedure | 36 |
| 4.11 | AC Power Line Conducted Emission..... | 37 |
| 4.11.1 | Limit | 37 |
| 4.11.2 | Test Setup | 37 |
| 4.11.3 | Test Procedure | 37 |
| 4.12 | Antenna Requirement..... | 38 |
| 4.12.1 | Limit | 38 |

| | |
|--|-----|
| 4.12.2 Antenna Connector Construction: | 38 |
| 5 Test setup photo and EUT Photo | 39 |
| 6 Test Result | 40 |
| Appendix A: 20dB Emission Bandwidth..... | 40 |
| Appendix B: Occupied Channel Bandwidth | 44 |
| Appendix C: Maximum conducted output power | 48 |
| Appendix D: Carrier frequency separation..... | 49 |
| Appendix E: Time of occupancy | 51 |
| Appendix F: Number of hopping channels..... | 53 |
| Appendix G: Band edge measurements..... | 55 |
| Appendix H: Conducted Spurious Emission | 79 |
| Appendix I: Duty Cycle..... | 130 |
| Appendix J: Emissions in Restricted Band | 134 |
| Appendix J: AC Power Line Conducted Emission | 154 |

COMPETENCES AND GUARANTEES

DEKRA is a testing laboratory competent to carry out the tests described in this report.

In order to assure the traceability to other national and international laboratories, DEKRA has a calibration and maintenance program for its measurement equipment.

DEKRA guarantees the reliability of the data presented in this report, which is the result of the measurements and the tests performed to the item under test on the date and under the conditions stated in the report and it is based on the knowledge and technical facilities available at DEKRA at the time of performance of the test.

DEKRA is liable to the client for the maintenance of the confidentiality of all information related to the item under test and the results of the test.

The results presented in this Test Report apply only to the particular item under test established in this document.

IMPORTANT: No parts of this report may be reproduced or quoted out of context, in any form or by any means, except in full, without the previous written permission of DEKRA.

GENERAL CONDITIONS

| | |
|----------------------|--|
| Test Location | No. 99, Hongye Road, Suzhou Industrial Park Suzhou, 215006, P.R. China |
| Date(receive sample) | May. 08, 2023 |
| Date (start test) | May. 09, 2023 |
| Date (finish test) | Jun. 14, 2023 |

1. This report is only referred to the item that has undergone the test.
2. This report does not constitute or imply on its own an approval of the product by the Certification Bodies or Competent Authorities.
3. This document is only valid if complete; no partial reproduction can be made without previous written permission of DEKRA.
4. This test report cannot be used partially or in full for publicity and/or promotional purposes without previous written permission of DEKRA.

ENVIRONMENTAL CONDITIONS

The climatic conditions during the tests are within the limits specified by the manufacturer for the operation of the EUT and the test equipment. The climatic conditions during the tests were within the following limits:

| | |
|-----------------------|---------------|
| Ambient temperature | 15 °C – 35 °C |
| Relative Humidity air | 30% - 60% |

If explicitly required in the basic standard or applied product / product family standard the climatic values are recorded and documented separately in this test report.

POSSIBLE TEST CASE VERDICTS

| | |
|---|-----------------|
| Test case does not apply to test object | N/A |
| Test object does meet requirement | P (Pass) / PASS |
| Test object does not meet requirement | F (Fail) / FAIL |
| Not measured | N/M |

ABBREVIATIONS

For the purposes of the present document, the following abbreviations apply:

| | |
|-------|-------------------------------|
| EUT | : Equipment Under Test |
| QP | : Quasi-Peak |
| CAV | : CISPR Average |
| AV | : Average |
| CDN | : Coupling Decoupling Network |
| SAC | : Semi-Anechoic Chamber |
| OATS | : Open Area Test Site |
| BW | : Bandwidth |
| AM | : Amplitude Modulation |
| PM | : Pulse Modulation |
| HCP | : Horizontal Coupling Plane |
| VCP | : Vertical Coupling Plane |
| U_N | : Nominal voltage |
| T_x | : Transmitter |
| R_x | : Receiver |
| N/A | : Not Applicable |
| N/M | : Not Measured |

DOCUMENT HISTORY

| Report No. | Version | Description | Issued Date |
|-----------------------|---------|--------------------------|-------------|
| 2350171R-RF-US-P06V01 | V1.0 | Initial issue of report. | 2023-06-16 |
| | | | |
| | | | |
| | | | |
| | | | |
| | | | |
| | | | |
| | | | |
| | | | |

REMARKS AND COMMENTS

1. The equipment under test (EUT) does meet the essential requirements of the stated standard(s)/test(s).
2. These test results on a sample of the device are for the purpose of demonstrating Compliance with Part 15 Subpart C Paragraph 15.247, RSS-Gen Issue 5, RSS-247 Issue 2.
3. The measurement result is considered in conformance with the requirement if it is within the prescribed limit, It is not necessary to account the uncertainty associated with the measurement result.
4. The test results presented in this report relate only to the object tested.
5. The test report shall not be reproduced without the written approval of DEKRA Testing and Certification (Suzhou) Co., Ltd.
6. This report will not be used for social proof function in China market.
7. DEKRA declines any responsibility with the following test data provided by customer that may affect the validity of result:
 - Chapter 1.1 General Description of the Item(s);
 - Chapter 1.2 Antenna Information;
 - Chapter 1.3Channel List.

USED EQUIPMENT

AC Power Line Conducted Emission / TR1

| Instrument | Manufacturer | Model No. | Serial No. | Cal. Date | Next Cal. Date |
|---------------------------------|--------------|-------------|------------|------------|----------------|
| EMI Test Receiver | R&S | ESCI | 100906 | 2022.09.04 | 2023.09.03 |
| Two-Line V-Network | R&S | ENV216 | 101189 | 2023.05.14 | 2024.05.13 |
| Two-Line V-Network | R&S | ENV216 | 101044 | 2023.01.07 | 2024.01.06 |
| Artificial Mains Network | SCHWARZBECK | NNLK 8129 | 8129-294 | 2023.02.25 | 2024.02.24 |
| Impedance Stabilization Network | Teseq GmbH | ISN T800 | 57318 | 2023.03.07 | 2024.03.06 |
| Impedance Stabilization Network | Teseq GmbH | ISN T8-Cat6 | 29680 | 2023.03.07 | 2024.03.06 |
| 50ohm Coaxial Switch | Anritsu | MP59B | 6200464462 | N/A | N/A |
| Coaxial Cable | Suhner | RG 223 | TR1-C1 | 2023.05.14 | 2024.05.13 |
| Temperature/Humidity Meter | RTS | RTS-8S | TR1-TH | 2022.07.07 | 2023.07.06 |

Conducted Test/ TR8

| Instrument | Manufacturer | Model No. | Serial No. | Cal. Date | Next Cal. Date |
|---|--------------|---------------|------------|------------|----------------|
| Wireless Connectivity Tester | R&S | CMW 270 | 102593 | 2022.05.21 | 2023.05.20 |
| Wireless Connectivity Tester | R&S | CMW 270 | 102593 | 2023.05.20 | 2024.05.19 |
| Coaxial Cable | woken | N/A | N/A | 2023.02.02 | 2024.02.01 |
| High and low temperature and fast temperature change test box | ASTUOD | ASTD-FBT-225K | N/A | 2022.08.24 | 2023.08.23 |
| Temperature/Humidity Meter | RTS | RTS-8S | RF08 | 2022.07.07 | 2023.07.06 |
| Test system | | | | | |
| 4TX MIMO Power Sensor | Keysight | X8750A | MY59400102 | 2023.02.25 | 2024.02.24 |
| MAX Signal Analyzer | Keysight | N9020B | MY59050482 | 2022.09.17 | 2023.09.16 |
| Switch Box | Keysight | X8749A | N/A | N/A | N/A |
| High and low temperature and fast temperature change test box | ASTUOD | ASTD-FBT-225K | N/A | 2022.08.24 | 2023.08.23 |
| MXG-B RF Vector Signal Generator | Keysight | N5182B | MY61252529 | 2022.07.14 | 2023.07.13 |
| Frequency extender for EXG or MXG | Keysight | N5182BX07 | MY59362500 | 2022.07.14 | 2023.07.13 |
| EXG-B MW Analog Signal Generator | Keysight | N5173B | MY61252566 | 2022.09.28 | 2023.09.27 |

Radiated Emission(9KHz-1GHz) / AC3

| Instrument | Manufacturer | Model No. | Serial No. | Cal. Date | Next Cal. Date |
|----------------------------|--------------|-----------|------------|------------|----------------|
| EMI Test Receiver | R&S | ESCI | 100573 | 2022.07.10 | 2023.07.09 |
| Bilog Antenna | Teseq GmbH | CBL6112D | 27611 | 2022.08.28 | 2023.08.27 |
| Coaxial Cable | Huber+Suhner | RG 214 | AC2-C | 2023.03.15 | 2024.03.14 |
| Loop Antenna | R&S | HFH2-Z2 | 833799/003 | 2023.02.25 | 2024.02.24 |
| Temperature/Humidity Meter | RTS | RTS-8S | AC2-TH | 2022.07.07 | 2023.07.06 |

Radiated Emission (1GHz-40GHz) / AC5

| Instrument | Manufacturer | Model No. | Serial No. | Cal. Date | Next Cal. Date |
|-------------------------|--------------|--------------------|------------|------------|----------------|
| MXA Signal Analyzer | Keysight | N9020B | MY60112218 | 2022.12.08 | 2023.12.07 |
| Preamplifier | Chengyi | EMC184045SE | 980263 | 2022.07.19 | 2023.07.18 |
| DRG Horn | ETS-Lindgren | 3117 | 00123988 | 2022.08.29 | 2023.08.28 |
| Broad-Band Horn Antenna | SCHWARZBECK | BBHA 9170 | 01249 | 2022.09.22 | 2023.09.21 |
| Coaxial Cable | ROSENBERGER | LA1-C011-2000/3000 | AC5-40G | 2023.03.04 | 2024.03.03 |

UNCERTAINTY

Uncertainties have been calculated according to the DEKRA internal document. The reported expanded uncertainties are based on a standard uncertainty multiplied by a coverage factor of $k=2$, providing a level of confidence of approximately 95%. The Uncertainties is comply with standard required as below.

| Test item | Uncertainty |
|---|--|
| AC Power Line Conducted Emission | 9kHz~150kHz: 2.80dB 150kHz~30MHz: 2.40dB |
| Radiated Emission(30MHz~1GHz) | Horizontal: 30MHz~200MHz: 3.50 dB 300MHz~1GHz: 3.60 dB Vertical: 30MHz~200MHz: 3.60 dB 300MHz~1GHz: 3.50 dB |
| Radiated Emission(1GHz~26.5GHz) | Horizontal: 1GHz~18GHz: 5.00 dB Vertical: 1GHz~18GHz: 4.80 dB Horizontal: 18GHz~26.5GHz: 5.30 dB Vertical: 18GHz~26.5GHz: 4.90 dB |
| 20dB Bandwidth | ± 1 kHz |
| Carrier Frequency Separation | ± 1 kHz |
| Number of Hopping Frequencies | ± 1 kHz |
| Time of Occupancy (Dwell Time) | ± 0.1 us |
| Peak Output Power | ± 1.27 dB |
| Emissions in non-restricted frequency bands | ± 1.0 dB |
| Radiated Emission Band Edge | ± 3.9 dB |

1 GENERAL INFORMATION

1.1 General Description of the Item(s)

| | |
|----------------------------|--|
| Product Name | Charge Base |
| Model No. | 1962 Horizontal |
| Trademark. | Honeywell |
| FCC ID | HD5-1962CCBH |
| IC | 1693B-1962CCBH |
| Hardware Version | 1962 Horizontal ver01 |
| Software Version | 1962 Horizontal ver02 |
| Manufacturer | HONEYWELL INTERNATIONAL INC Honeywell Safety and Productivity Solutions |
| Manufacturer Address | 9680 OLD BAILES RD FORT MILL SC 29707-7539,USA |
| Factory | Metro(Suzhou)Technologies Co.,Ltd |
| Factory address..... | No.221 Xinghai street China-Singapore Suzhou Industrial Park |

| | | | | |
|------------------------------------|---|--|---|--|
| Wireless specification..... | Bluetooth (BR/EDR) | | | |
| Operating frequency range(s) | 2402~2480MHz | | | |
| Type of Modulation..... | GFSK | | | |
| PHYs | <input checked="" type="checkbox"/> GFSK | <input checked="" type="checkbox"/> Pi/4 DQPSK | <input checked="" type="checkbox"/> 8DPSK | |
| Data Rate | <input checked="" type="checkbox"/> 1Mbit/s | <input checked="" type="checkbox"/> 2Mbit/s | <input checked="" type="checkbox"/> 3Mbit/s | |
| Number of channel | 79 | | | |

| | | | | |
|--------------------------|-------------------------------------|----------------------------------|--|--|
| Rated power supply | Voltage and Frequency | | | |
| | <input type="checkbox"/> | AC: 220 – 240 V, 50 / 60 Hz, | | |
| | <input type="checkbox"/> | AC: 100 – 240 V, 50 / 60 Hz | | |
| | <input type="checkbox"/> | DC: 12 V | | |
| | <input type="checkbox"/> | Battery: 12 Vdc | | |
| | <input checked="" type="checkbox"/> | Adapter: | | |
| Adapter | Model: ADS-25SGP-06 05015E | | | |
| | INPUT: 100-240V~50-60Hz Max.0.7A | | | |
| | OUTPUT: 5.0V ,3.0A, 15.0W | | | |
| Mounting position | <input checked="" type="checkbox"/> | Table top equipment | | |
| | <input type="checkbox"/> | Wall/Ceiling mounted equipment | | |
| | <input type="checkbox"/> | Floor standing equipment | | |
| | <input type="checkbox"/> | Hand-held equipment | | |
| | <input type="checkbox"/> | Other: vehicle-mounted equipment | | |

1.2 Antenna Information

| | | | |
|-----------------------------------|-------------------------------------|---------------|--|
| Antenna model / type number | N/A | | |
| Antenna serial number | N/A | | |
| Antenna Delivery | <input checked="" type="checkbox"/> | 1TX + 1RX | |
| | <input type="checkbox"/> | 2TX + 2RX | |
| | <input type="checkbox"/> | Others: | |
| Antenna technology | <input checked="" type="checkbox"/> | SISO | |
| | <input type="checkbox"/> | MIMO | <input type="checkbox"/> CDD |
| | | | <input type="checkbox"/> Beam-forming |
| Antenna Type | <input type="checkbox"/> | External | <input type="checkbox"/> Dipole |
| | | | <input type="checkbox"/> Sectorized |
| | | | <input type="checkbox"/> Ceramic Chip |
| | <input checked="" type="checkbox"/> | Internal | <input type="checkbox"/> PIFA |
| | | | <input checked="" type="checkbox"/> Chip Antenna |
| | | | <input type="checkbox"/> Others..... |
| Antenna Gain | 2.90dBi | | |

1.3 Channel List

| Bluetooth Working Frequency of Each Channel: (For FHSS) | | | | | | | |
|---|-----------|---------|-----------|---------|-----------|---------|-----------|
| Channel | Frequency | Channel | Frequency | Channel | Frequency | Channel | Frequency |
| 00 | 2402 MHz | 01 | 2403 MHz | 02 | 2404 MHz | 03 | 2405 MHz |
| 04 | 2406 MHz | 05 | 2407 MHz | 06 | 2408 MHz | 07 | 2409 MHz |
| 08 | 2410 MHz | 09 | 2411 MHz | 10 | 2412 MHz | 11 | 2413 MHz |
| 12 | 2414 MHz | 13 | 2415 MHz | 14 | 2416 MHz | 15 | 2417 MHz |
| 16 | 2418 MHz | 17 | 2419 MHz | 18 | 2420 MHz | 19 | 2421 MHz |
| 20 | 2422 MHz | 21 | 2423 MHz | 22 | 2424 MHz | 23 | 2425 MHz |
| 24 | 2426 MHz | 25 | 2427 MHz | 26 | 2428 MHz | 27 | 2429 MHz |
| 28 | 2430 MHz | 29 | 2431 MHz | 30 | 2432 MHz | 31 | 2433 MHz |
| 32 | 2434 MHz | 33 | 2435 MHz | 34 | 2436 MHz | 35 | 2437 MHz |
| 36 | 2438 MHz | 37 | 2439 MHz | 38 | 2440 MHz | 39 | 2441 MHz |
| 40 | 2442 MHz | 41 | 2443 MHz | 42 | 2444 MHz | 43 | 2445 MHz |
| 44 | 2446 MHz | 45 | 2447 MHz | 46 | 2448 MHz | 47 | 2449 MHz |
| 48 | 2450 MHz | 49 | 2451 MHz | 50 | 2452 MHz | 51 | 2453 MHz |
| 52 | 2454 MHz | 53 | 2455 MHz | 54 | 2456 MHz | 55 | 2457 MHz |
| 56 | 2458 MHz | 57 | 2459 MHz | 58 | 2460 MHz | 59 | 2461 MHz |
| 60 | 2462 MHz | 61 | 2463 MHz | 62 | 2464 MHz | 63 | 2465 MHz |
| 64 | 2466 MHz | 65 | 2467 MHz | 66 | 2468 MHz | 67 | 2469 MHz |
| 68 | 2470 MHz | 69 | 2471 MHz | 70 | 2472 MHz | 71 | 2473 MHz |
| 72 | 2474 MHz | 73 | 2475 MHz | 74 | 2476 MHz | 75 | 2477 MHz |
| 76 | 2478 MHz | 77 | 2479 MHz | 78 | 2480 MHz | N/A | N/A |

Note: The general description of the Item(s), antenna information and channel list in clause 1 are provided and confirmed by the client.

2 DESCRIPTION OF TEST SETUP

2.1 Operating mode(s) used for tests

During the tests the following operating mode(s) has(have) been used.

| | |
|-------------------------|---|
| Test Mode For Bluetooth | Mode 1: Transmitter-1Mbps(GFSK_DH5) |
| | Mode 2: Transmitter-2Mbps(Pi/4 DQPSK_DH5) |
| | Mode 3: Transmitter-3Mbps(8DPSK_DH5) |
| | Mode 4: Transmitter-Hopping-1Mbps(GFSK_DH5) |
| | Mode 5: Transmitter-Hopping-2Mbps(Pi/4 DQPSK_DH5) |
| | Mode 6: Transmitter-Hopping-3Mbps(8DPSK_DH5) |

2.2 Auxiliary equipment /Accessories/Test software for the EUT

| Auxiliary equipment | Type / Version | Manufacturer | Supplied by |
|-----------------------|----------------|--------------|-------------|
| (1) CMW 270 | N/A | R&S | 230Vac |
| (2) USB Control Cable | N/A | N/A | N/A |
| (3) USB Control Cable | N/A | N/A | N/A |
| software | Type / Version | Manufacturer | Supplied by |
| N/A | N/A | N/A | N/A |

| Accessories Information | Cable | | |
|-------------------------|--------------------------------|-------------------------------------|-------------------------------------|
| | Length used during test [m] | Attached during test | Shielded |
| (2)USB Control Cable | 1 | <input checked="" type="checkbox"/> | <input checked="" type="checkbox"/> |
| (3)USB Control Cable | 8 | <input checked="" type="checkbox"/> | <input checked="" type="checkbox"/> |

2.3 Test Configuration / Block diagram used for tests

Test setup Diagram- AC Line Conducted Emission Test

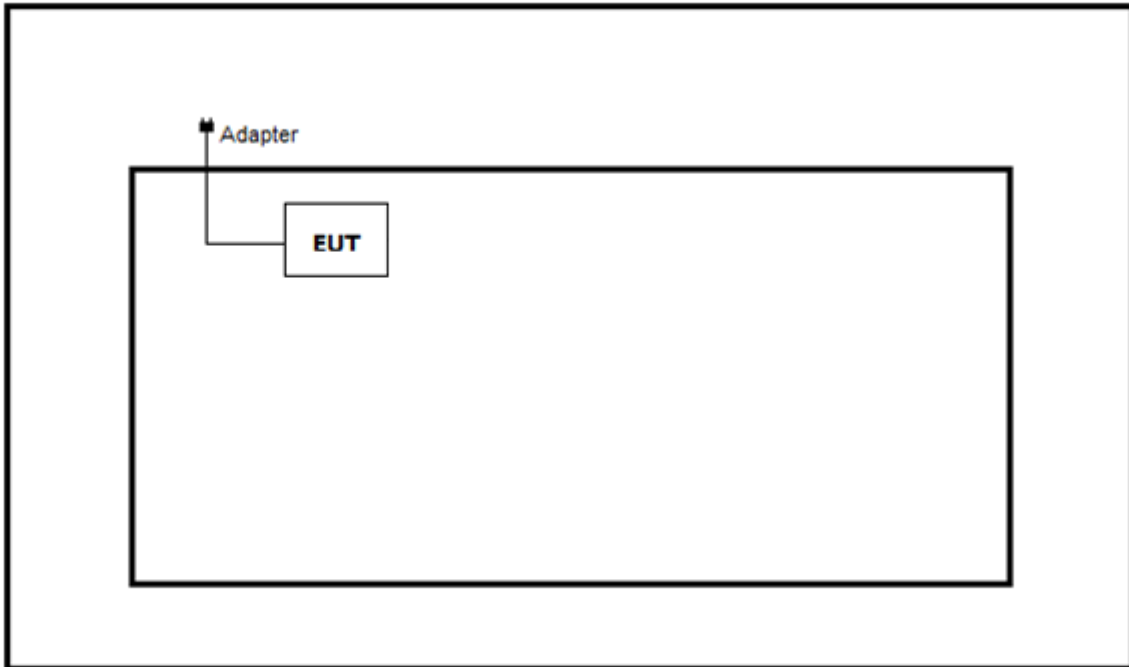

Test setup Diagram- Conducted test

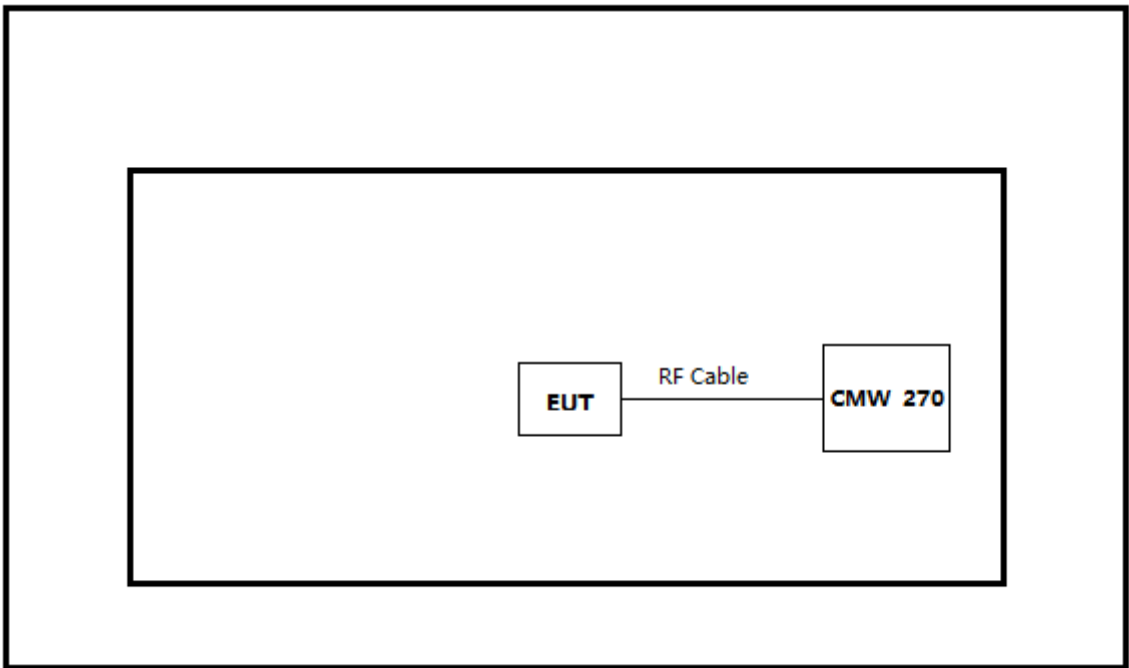

Test setup Diagram- Ratiated test

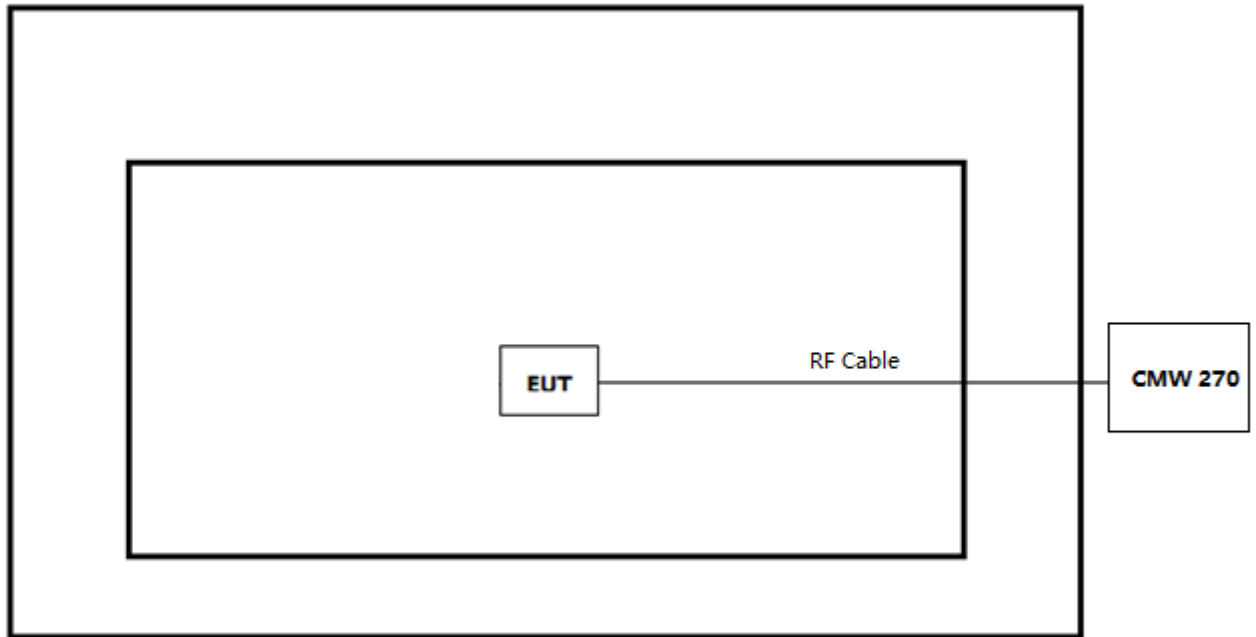

2.4 Testing process

| | |
|---|---|
| 1 | Setup the EUT shown in Section 2.3. |
| 2 | Configure the test mode, the test channel, and the data rate. |
| 3 | Verify that the EUT works properly. |

3 VERDICT SUMMARY SECTION

This chapter presents an overview of standards and results. Refer to the next chapters for details of measured test results and applied test levels.

3.1 Standards

| Standard | Year | Description |
|-----------------------------|------|--|
| CFR 47, FCC Part 15 C | 2023 | Operation within the bands 902–928 MHz, 2400–2483.5 MHz, and 5725–5850 MHz. |
| CFR 47, FCC Part 15 A | 2023 | Measurement detector functions and bandwidths. |
| ANSI C63.10 | 2013 | American National Standard of Procedures for Compliance Testing of Unlicensed Wireless Devices |
| RSS-Gen Issue 5 Amendment 1 | 2019 | General Requirements for Compliance of Radio Apparatus |
| RSS-247 Issue 2 | 2017 | Digital Transmission Systems (DTSs), Frequency Hopping Systems (FHSs) and Licence-Exempt Local Area Network (LE-LAN) Devices |

3.2 Deviation(s) from the Standard(s) / Test Specification(s)

The following deviation(s) was / were made from the published requirements of the listed standards: N/A.

(Please define the deviations from the standard(s) if applicable)

3.3 Overview of results

| Requirement – Test Item of FCC | Standard(s) | Verdict | Remark |
|----------------------------------|---------------------------|---------|---|
| 20dB Emission Bandwidth | FCC 15.247(a)(1) | PASS | Test data please refer to Appendix A |
| Maximum conducted output power | FCC 15.247(b)(1) | PASS | Test data please refer to Appendix C |
| Carrier Frequency Separation | FCC 15.247(a)(1) | PASS | Test data please refer to Appendix D |
| Time of Occupancy (Dwell Time) | FCC 15.247(a)(1)(iii) | PASS | Test data please refer to Appendix E |
| Number of Hopping Frequencies | FCC 15.247(a)(1)(iii) | PASS | Test data please refer to Appendix F |
| Band edge measurements | FCC 15.247(d) | PASS | Test data please refer to Appendix G |
| Conducted Spurious Emission | FCC 15.247(d), FCC 15.209 | PASS | Test data please refer to Appendix H |
| Duty Cycle | ANSI C63.10:2013 | PASS | Test data please refer to Appendix I |
| Emissions in Restricted Bands | FCC 15.247(b)(3) | PASS | Test data please refer to Appendix J |
| AC Power Line Conducted Emission | FCC 15.207 | PASS | Test data please refer to Appendix K |
| Antenna Requirement | FCC 15.203 | PASS | --- |

| Requirement – Test Item of ISED | Standard(s) | Verdict | Remark |
|----------------------------------|--|---------|--|
| 20dB Emission Bandwidth | RSS-Gen Issue 5 Paragraph 6.7 RSS-247 Issue 2 Paragraph 5.1 | PASS | Test data please refer to Appendix A |
| Occupied Channel Bandwidth | RSS-Gen Issue 5 Paragraph 6.7 RSS-247 Issue 2 Paragraph 5.1 | PASS | Test data please refer to Appendix B |
| Maximum conducted output power | FCC 15.247(b)(1) | PASS | Test data please refer to Appendix C |
| Carrier frequency separation | RSS-247 Issue 2 Paragraph 5.1 | PASS | Test data please refer to Appendix D |
| Time of occupancy | RSS-247 Issue 2 Paragraph 5.1 | PASS | Test data please refer to Appendix E |
| Number of Hopping Frequencies | RSS-247 Issue 2 Paragraph 5.1 | PASS | Test data please refer to Appendix F |
| Band edge measurements | RSS-Gen Issue 5 Paragraph 8.10 | PASS | Test data please refer to Appendix G |
| Conducted Spurious Emission | RSS-247 Issue 2 Paragraph 5.5 | PASS | Test data please refer to Appendix H |
| Duty cycle | ANSI C63.10:2013 | PASS | Test data please refer to Appendix I |
| Emissions in Restricted Bands | RSS-Gen Issue 5 Paragraph 8.9 | PASS | Test data please refer to Appendix J |
| AC Power Line Conducted Emission | RSS-Gen Issue 5 Paragraph 8.8 | PASS | Test data please refer to Appendix K |
| Antenna Requirement | RSS-Gen Issue 5 Paragraph 6.8 | PASS | --- |

3.4 Power setting in test

| Mode | Channel | Frequency (MHz) | Power Setting |
|------------------------|---------|-----------------|---------------|
| 1Mbps (GFSK_DH5) | 00 | 2402 | Default |
| | 39 | 2440 | Default |
| | 78 | 2480 | Default |
| 2Mbps (Pi/4 DQPSK_DH5) | 00 | 2402 | Default |
| | 39 | 2440 | Default |
| | 78 | 2480 | Default |
| 3Mbps (8DPSK_DH5) | 00 | 2402 | Default |
| | 39 | 2440 | Default |
| | 78 | 2480 | Default |

3.5 Test Matrix

| Test item | 1962 Horizontal | |
|----------------------------------|-------------------------------------|-------------------------------------|
| | 1(#1) | 2(#2) |
| 20dB Emission Bandwidth | <input checked="" type="checkbox"/> | <input type="checkbox"/> |
| Occupied Channel Bandwidth | <input checked="" type="checkbox"/> | <input type="checkbox"/> |
| Maximum conducted output power | <input checked="" type="checkbox"/> | <input type="checkbox"/> |
| Carrier frequency separation | <input checked="" type="checkbox"/> | <input type="checkbox"/> |
| Time of occupancy | <input checked="" type="checkbox"/> | <input type="checkbox"/> |
| Number of Hopping Frequencies | <input checked="" type="checkbox"/> | <input type="checkbox"/> |
| Band edge measurements | <input type="checkbox"/> | <input checked="" type="checkbox"/> |
| Conducted Spurious Emission | <input checked="" type="checkbox"/> | <input type="checkbox"/> |
| Duty cycle | <input checked="" type="checkbox"/> | <input type="checkbox"/> |
| Emissions in Restricted Bands | <input type="checkbox"/> | <input checked="" type="checkbox"/> |
| AC Power Line Conducted Emission | <input type="checkbox"/> | <input checked="" type="checkbox"/> |

3.6 Test Facility

USA : FCC Designation Number: CN1199

CA : ISED CAB identifier: CN0040

4 TEST ITEMS OF LIMIT/SETUP/PROCEDURE

| | |
|------------------------------------|----------------------|
| 4.1 20dB Emission Bandwidth | VERDICT: PASS |
|------------------------------------|----------------------|

| 4.1.1 Limit | |
|-------------------------------------|---|
| Standard | FCC Part 15 Subpart C Paragraph 15.247(a) |
| <input checked="" type="checkbox"/> | For frequency hopping systems operating in 2400-2483.5 MHz band, within frequency range. |
| <input type="checkbox"/> | For frequency hopping systems operating in 902-928 MHz band, the maximum allowed 20 dB bandwidth of the hopping channel is 500 kHz. |
| <input type="checkbox"/> | For frequency hopping systems operating in 5725-5850 MHz band, the maximum 20 dB bandwidth of the hopping channel is 1 MHz. |

4.1.2 Test Setup

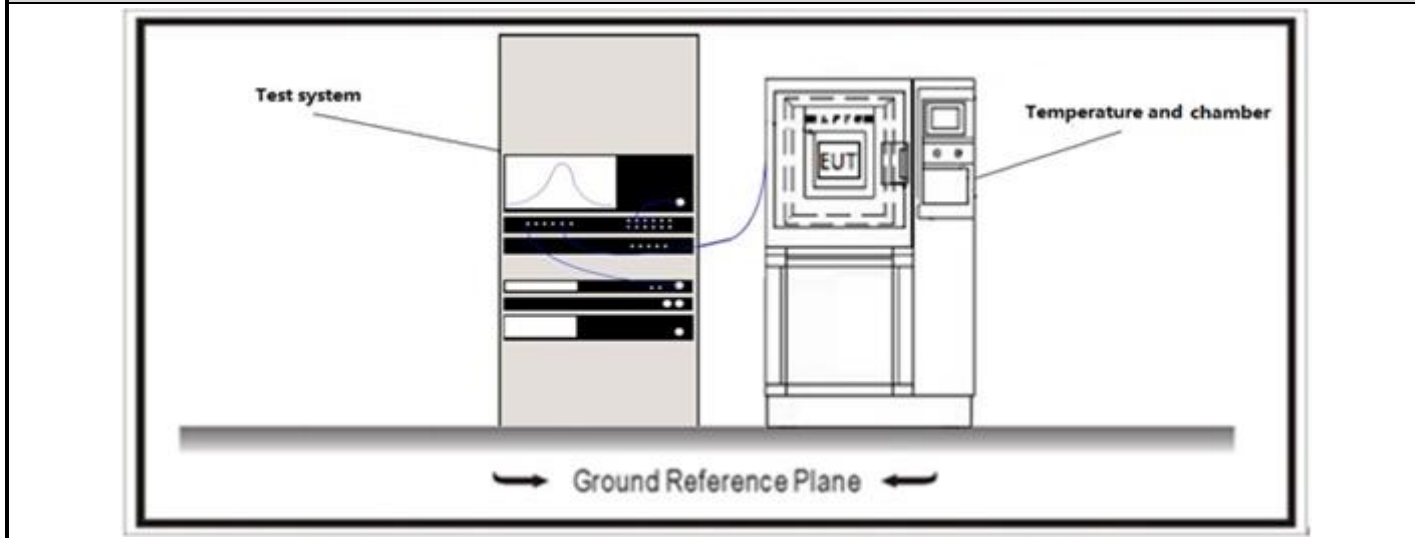

| 4.1.3 Test Procedure | | | |
|-------------------------------------|-------------|-------------|---|
| References Rule | Chapter | Description | |
| <input checked="" type="checkbox"/> | ANSI C63.10 | 6.9 | Occupied bandwidth tests |
| <input checked="" type="checkbox"/> | ANSI C63.10 | 6.9.2 | Occupied bandwidth—relative measurement procedure |

| | |
|---------------------------------------|----------------------|
| 4.2 Occupied Channel Bandwidth | VERDICT: PASS |
|---------------------------------------|----------------------|

4.2.1 Limit

| | |
|-----------------|---|
| Standard | RSS-Gen Issue 5 Paragraph 6.7, RSS-247 Issue 2 Paragraph 5.1. |
|-----------------|---|

The occupied bandwidth or the “99% emission bandwidth” is defined as the frequency range between two points, one above and the other below the carrier frequency, within which 99% of the total transmitted power of the fundamental transmitted emission is contained. The occupied bandwidth shall be reported for all equipment in addition to the specified bandwidth required in the applicable RSSs

4.2.1 Test Setup

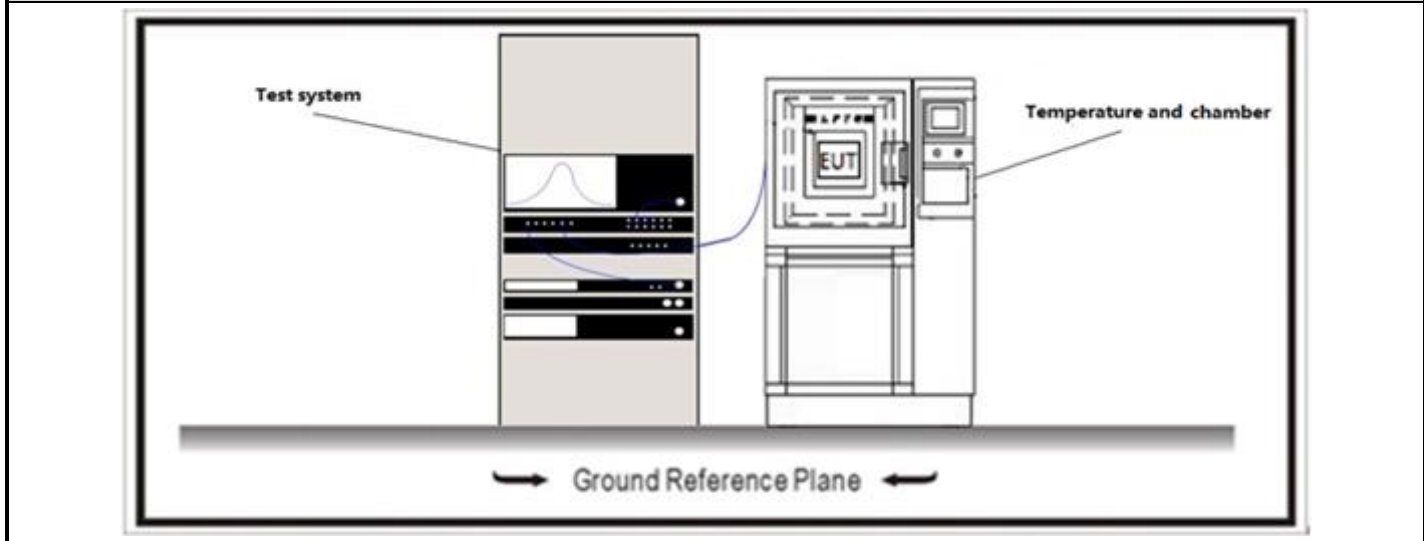

4.2.3 Test Procedure

| | References Rule | Chapter | Description |
|-------------------------------------|-----------------|---------|---|
| <input checked="" type="checkbox"/> | ANSI C63.10 | 6.9 | Occupied bandwidth tests |
| <input checked="" type="checkbox"/> | ANSI C63.10 | 6.9.2 | Occupied bandwidth—relative measurement procedure |

| | |
|---|----------------------|
| 4.3 Maximum Conducted Output Power | VERDICT: PASS |
|---|----------------------|

4.3.1 Limit

| | |
|-------------------------------------|--|
| Standard | FCC Part 15 Subpart C Paragraph 15.247(b); RSS-247 Issue 2 Paragraph 5.1. |
| <input checked="" type="checkbox"/> | Frequency hopping systems operating in the 2400-2483.5 MHz band employing at least 75 non-overlapping hopping channels, and all frequency hopping systems in the 5725-5850 MHz band: 1 watt. For all other frequency hopping systems in the 2400-2483.5 MHz band: 0.125 watts. |
| <input checked="" type="checkbox"/> | Frequency hopping systems operating in the 2400-2483.5 MHz band may have hopping channel carrier frequencies that are separated by 25 kHz or two-thirds of the 20 dB bandwidth of the hopping channel, whichever is greater, provided the systems operate with an output power no greater than 125 mW. |
| <input type="checkbox"/> | For frequency hopping systems operating in the 902-928 MHz band: 1 watt for systems employing at least 50 hopping channels; and, 0.25 watts for systems employing less than 50 hopping channels, but at least 25 hopping channels |

4.3.2 Test Setup

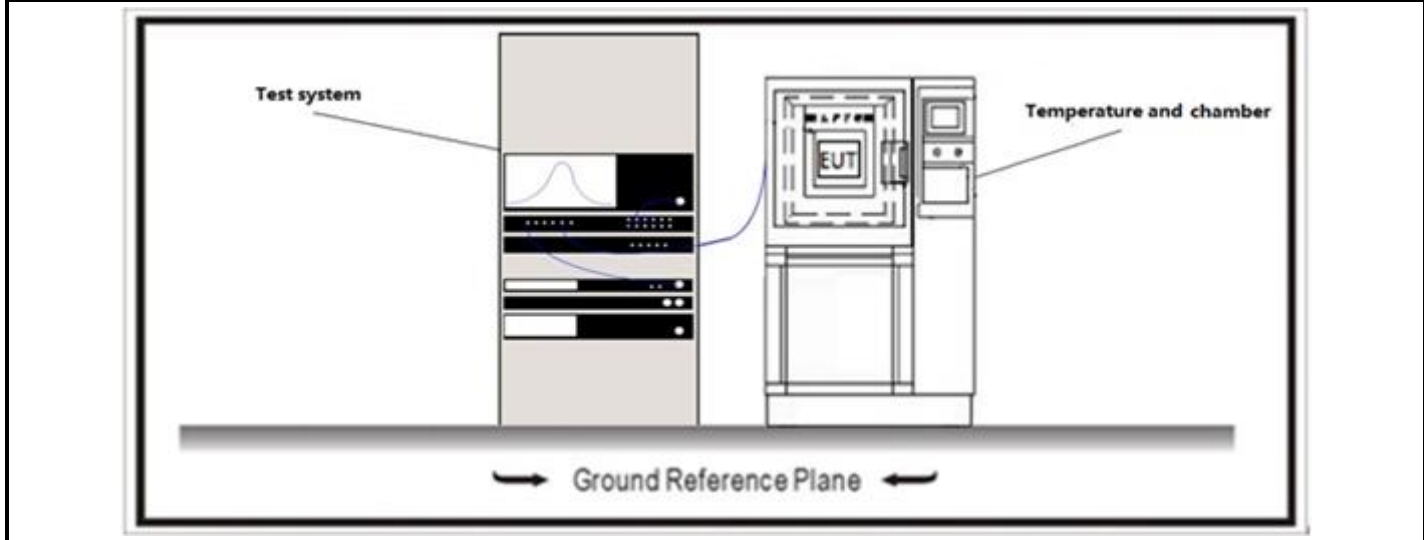

4.3.3 Test Procedure

| | References Rule | Chapter | Description |
|-------------------------------------|-----------------|---------|--|
| <input checked="" type="checkbox"/> | ANSI C63.10 | 7.8 | Evaluation of frequency-hopping device parameters |
| <input checked="" type="checkbox"/> | ANSI C63.10 | 7.8.5 | Output power test procedure for frequency-hopping spread-spectrum (FHSS) devices |

| | |
|---|----------------------|
| 4.4 Carrier Frequency Separation | VERDICT: PASS |
|---|----------------------|

4.4.1 Limit

| Standard | FCC Part 15 Subpart C Paragraph 15.247(a); RSS-247 Issue 2 Paragraph 5.1. |
|-------------------------------------|---|
| <input type="checkbox"/> | Frequency hopping systems shall have hopping channel carrier frequencies separated by a minimum of 25 kHz or the 20 dB bandwidth of the hopping channel, whichever is greater. |
| <input checked="" type="checkbox"/> | Frequency hopping systems operating in the 2400-2483.5 MHz band may have hopping channel carrier frequencies that are separated by 25 kHz or two-thirds of the 20 dB bandwidth of the hopping channel. |
| <input type="checkbox"/> | The 20 dB bandwidth of the hopping channel is less than 250 kHz, the system shall use at least 50 hopping frequencies and the average time of occupancy on any frequency shall not be greater than 0.4 seconds within a 20 second period; |
| <input type="checkbox"/> | The 20 dB bandwidth of the hopping channel is 250 kHz or greater, the system shall use at least 25 hopping frequencies and the average time of occupancy on any frequency shall not be greater than 0.4 seconds within a 10 second period. The maximum allowed 20 dB bandwidth of the hopping channel is 500 kHz. |
| <input type="checkbox"/> | Frequency hopping systems operating in the 5725-5850 MHz band shall use at least 75 hopping frequencies. The maximum 20 dB bandwidth of the hopping channel is 1 MHz. |

4.4.2 Test Setup

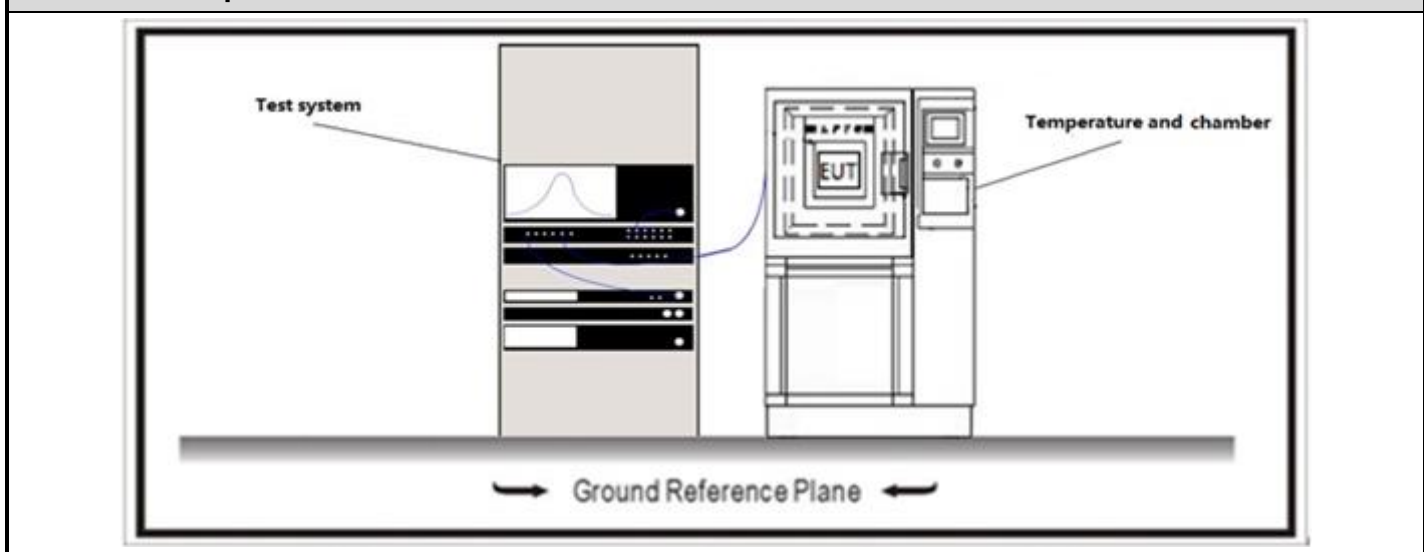

4.4.3 Test Procedure

| References Rule | Chapter | Description |
|---|---------|---|
| <input checked="" type="checkbox"/> ANSI C63.10 | 7.8 | Evaluation of frequency-hopping device parameters |
| <input checked="" type="checkbox"/> ANSI C63.10 | 7.8.2 | Carrier frequency separation |

| | |
|------------------------------|----------------------|
| 4.5 Time of Occupancy | VERDICT: PASS |
|------------------------------|----------------------|

4.5.1 Limit

| Standard | FCC Part 15 Subpart C Paragraph 15.247(a); RSS-247 Issue 2 Paragraph 5.1. |
|-------------------------------------|--|
| <input checked="" type="checkbox"/> | Frequency hopping systems in the 2400-2483.5 MHz band shall use at least 15 channels. The average time of occupancy on any channel shall not be greater than 0.4 seconds within a period of 0.4 seconds multiplied by the number of hopping channels employed. |
| <input type="checkbox"/> | For frequency hopping systems operating in the 902-928 MHz band: if the 20 dB bandwidth of the hopping channel is less than 250 kHz, the system shall use at least 50 hopping frequencies and the average time of occupancy on any frequency shall not be greater than 0.4 seconds within a 20 second period |
| <input type="checkbox"/> | For frequency hopping systems operating in the 902-928 MHz band: if the 20 dB bandwidth of the hopping channel is 250 kHz or greater, the system shall use at least 25 hopping frequencies and the average time of occupancy on any frequency shall not be greater than 0.4 seconds within a 10 second period. |
| <input type="checkbox"/> | Frequency hopping systems operating in the 5725-5850 MHz band shall use at least 75 hopping frequencies. The maximum 20 dB bandwidth of the hopping channel is 1 MHz. The average time of occupancy on any frequency shall not be greater than 0.4 seconds within a 30 second period. |

4.5.2 Test Setup

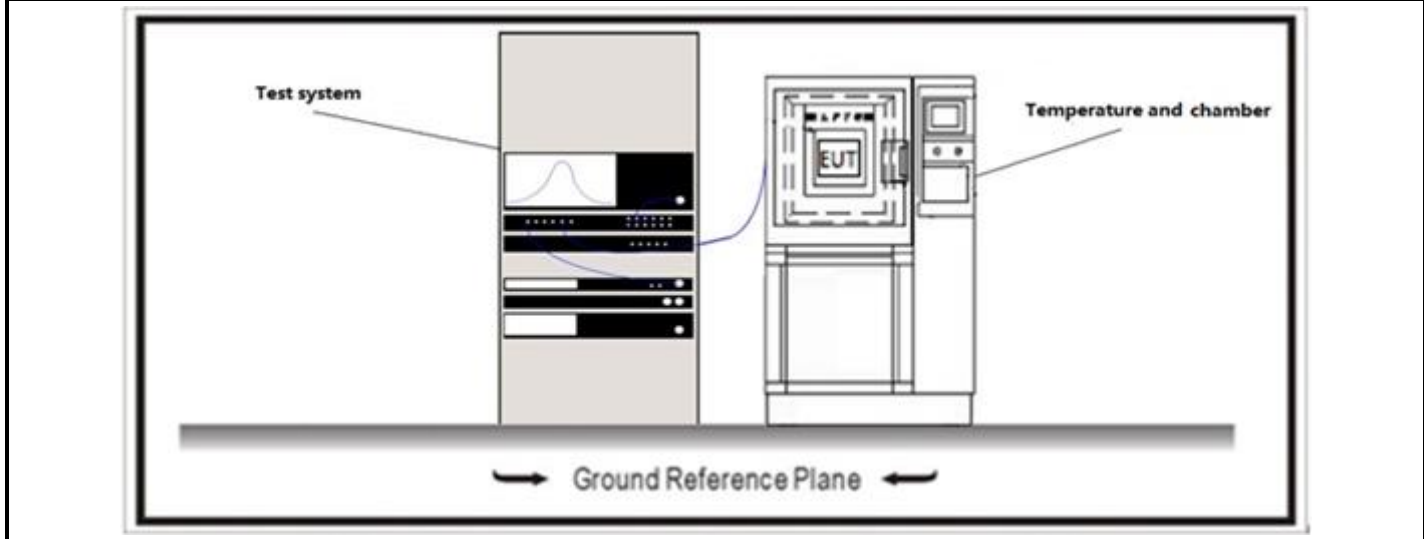

4.5.3 Test Procedure

| | References Rule | Chapter | Description |
|-------------------------------------|-----------------|---------|---|
| <input checked="" type="checkbox"/> | ANSI C63.10 | 7.8 | Evaluation of frequency-hopping device parameters |
| <input checked="" type="checkbox"/> | ANSI C63.10 | 7.8.4 | Time of occupancy (dwell time) |

| | |
|--|----------------------|
| 4.6 Number of hopping Frequencies | VERDICT: PASS |
|--|----------------------|

| 4.6.1 Limit | |
|-------------------------------------|---|
| Standard | FCC Part 15 Subpart C Paragraph 15.247(a); RSS-247 Issue 2 Paragraph 5.1. |
| <input checked="" type="checkbox"/> | For frequency hopping systems operating in the 2400-2483.5 MHz band shall use at least 15 hopping frequencies. |
| <input type="checkbox"/> | For frequency hopping systems operating in 902-928 MHz band, if the 20 dB bandwidth of the hopping channel is less than 250 kHz, shall use at least 50 hopping frequencies. |
| <input type="checkbox"/> | For frequency hopping systems operating in 902-928 MHz band, if the 20 dB bandwidth of the hopping channel is higher than 250 kHz, shall use at least 25 hopping frequencies. |
| <input type="checkbox"/> | For frequency hopping systems operating in the 5725-5850 MHz band shall use at least 75 hopping frequencies. |

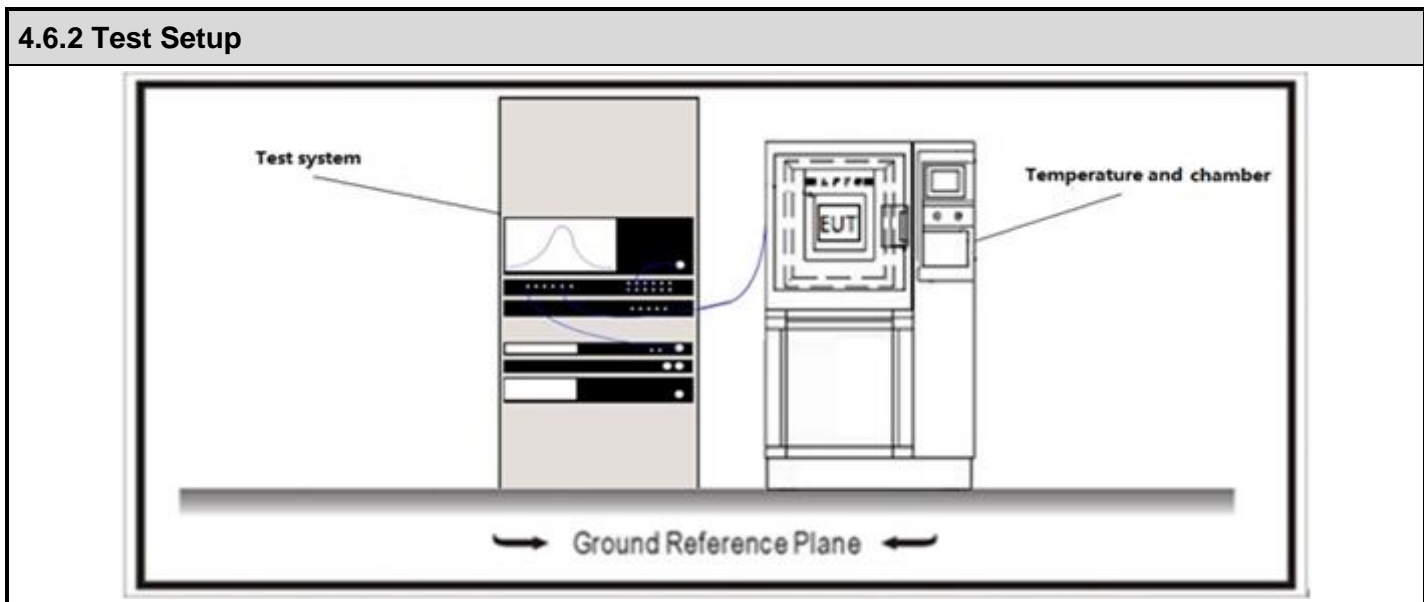

| 4.6.3 Test Procedure | | | |
|-------------------------------------|-----------------|---------|---|
| | References Rule | Chapter | Description |
| <input checked="" type="checkbox"/> | ANSI C63.10 | 7.8. | Evaluation of frequency-hopping device parameters |
| <input checked="" type="checkbox"/> | ANSI C63.10 | 7.8.3 | Number of Hopping Frequencies |

| | |
|-----------------------------------|----------------------|
| 4.7 Band edge measurements | VERDICT: PASS |
|-----------------------------------|----------------------|

4.7.1 Limit

Standard FCC Part 15 Subpart C Paragraph 15.247(d) ,15.209; RSS-Gen Issue 5 Paragraph 8.10.

| Frequency bands (MHz) | Detector | Limit (dB μ V/m) | RBW (MHz) | Distance (m) |
|-----------------------|----------|----------------------|-----------|--------------|
| 2310-2390 | PK | 74 | 1 | 3 |
| 2483.5-2500 | AV | 54 | 1 | 3 |

Note: The field strength of emissions appearing within these frequency bands shall not exceed the limits.

4.7.2 Test Setup

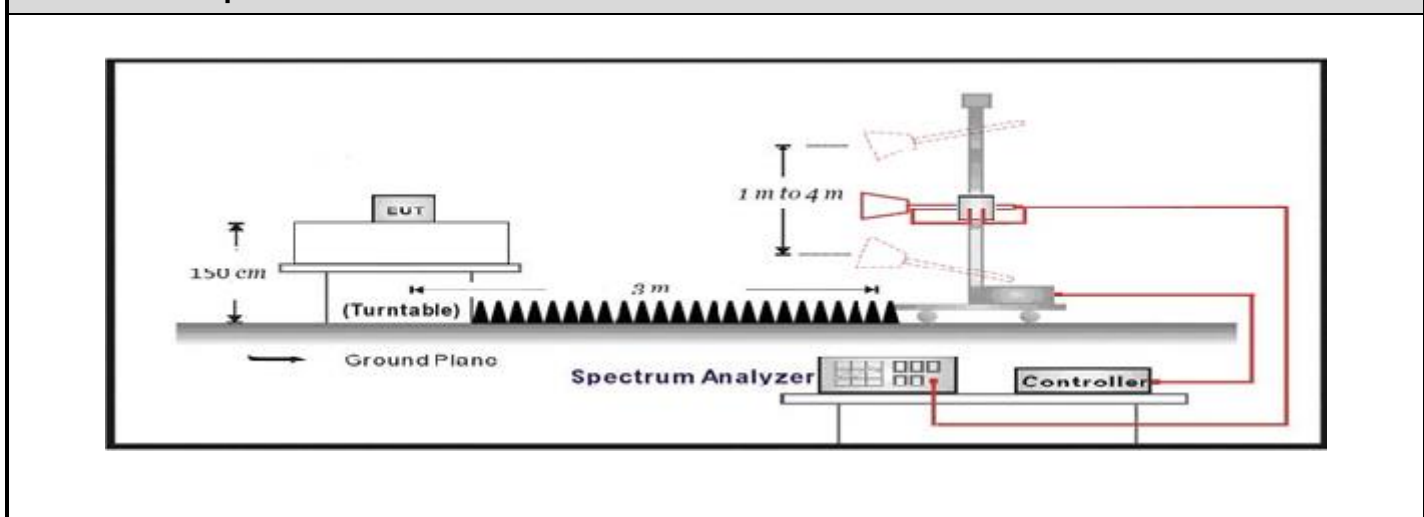

4.7.3 Test Procedure

| Test Method | | | |
|-------------------------------------|---|---------|--|
| | References Rule | Chapter | Description |
| <input type="checkbox"/> | DA 00-705 | N/A | duty cycle correction factor |
| <input checked="" type="checkbox"/> | ANSI C63.10 | 6.10 | Band-edge testing |
| | <input checked="" type="checkbox"/> ANSI C63.10 | 6.10.5 | Restricted-band band-edge measurements |
| | <input type="checkbox"/> ANSI C63.10 | 6.10.6 | Marker-delta method |
| <input type="checkbox"/> | ANSI C63.10 | 6.4 | Radiated emissions from unlicensed wireless devices below 30 MHz |
| <input type="checkbox"/> | ANSI C63.10 | 6.5 | Radiated emissions from unlicensed wireless devices in the frequency range of 30 MHz to 1000 MHz |
| <input type="checkbox"/> | ANSI C63.10 | 6.6 | Radiated emissions from unlicensed wireless devices above 1 GHz |

| | |
|--|----------------------|
| 4.8 Conducted Spurious Emission | VERDICT: PASS |
|--|----------------------|

4.8.1 Limit

| | | |
|-------------------------------------|---|--|
| Standard | FCC Part 15 Subpart C Paragraph 15.247(d); RSS-247 Issue 2 Paragraph 5.1. | |
| RF Output power (Detection methods) | Limit(dB) | |
| RF Output power(Average detector) | 30dBc(Note1) | |
| RF Output power(PK detector) | 20dBc(Note2) | |

Note 1: If maximum conducted (average) output power was used to demonstrate compliance as described in 9.2, then the peak power in any 100 kHz bandwidth outside of the authorized frequency band shall be attenuated by at least 30 dB relative to the maximum in-band peak PSD level in 100 kHz (i.e., 30 dBc).

Note 2: If the maximum peak conducted output power procedure was used, then the peak output power measured in any 100 kHz bandwidth outside of the authorized frequency band shall be attenuated by at least 20 dB relative to the maximum in-band peak PSD level in 100 kHz (i.e., 20 dBc).

4.8.2 Test Setup

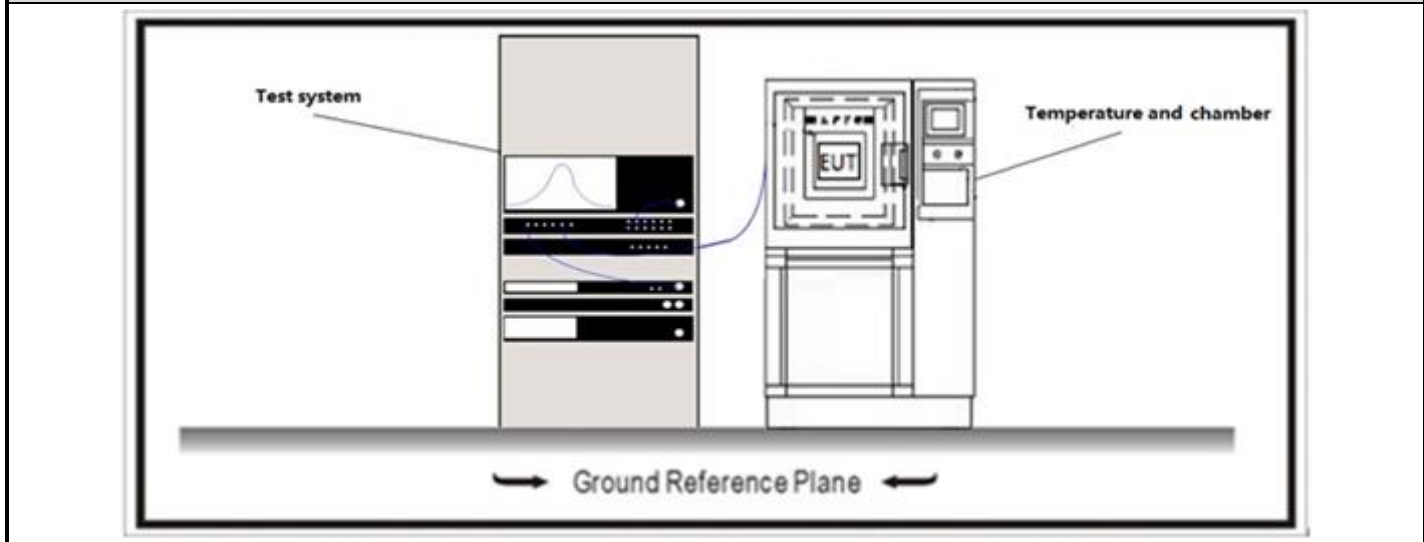

4.8.3 Test Procedure

| References | Rule | Chapter | Description |
|-------------------------------------|-------------|---------|---|
| <input checked="" type="checkbox"/> | ANSI C63.10 | 7.8 | Evaluation of frequency-hopping device parameters |
| <input checked="" type="checkbox"/> | ANSI C63.10 | 7.8.6 | Band-edge measurements for RF conducted emissions |

4.9 Duty cycle

VERDICT: PASS

4.9.1 Limit

N/A

4.9.2 Test Setup

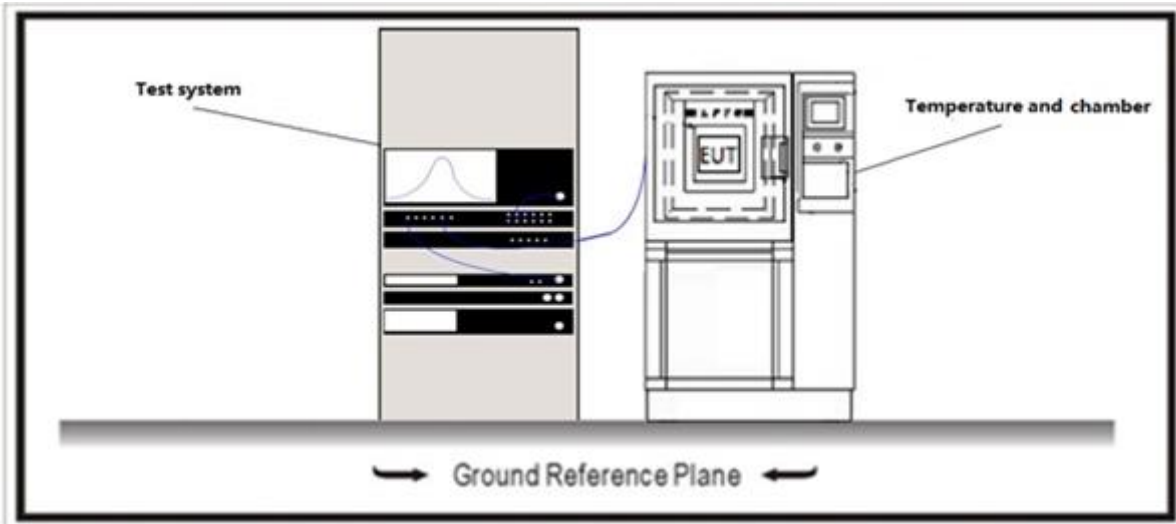

4.9.3 Test Procedure

| References Rule | Chapter | Description |
|---|---------|--|
| <input checked="" type="checkbox"/> ANSI C63.10 | 11.6 | Duty cycle (D), transmission duration (T), and maximum power control level |

4.10 Emissions in Restricted Bands**VERDICT: PASS****4.10.1 Limit****Standard**

FCC Part 15 Subpart C Paragraph 15.205

Restricted Bands of operation

| Frequency (MHz) | Frequency (MHz) | Frequency (MHz) | Frequency (GHz) |
|---------------------|-----------------------|-----------------|-----------------|
| 0.090 – 0.110 | 16.42 – 16.423 | 399.9 – 410 | 4.5 – 5.15 |
| 0.495 – 0.505 | 16.69475 – 16.69525 | 608 – 614 | 5.35 – 5.46 |
| 2.1735 – 2.1905 | 16.80425 – 16.80475 | 960 – 1240 | 7.25 – 7.75 |
| 4.125 – 4.128 | 25.5 – 25.67 | 1300 – 1427 | 8.025 – 8.5 |
| 4.17725 – 4.17775 | 37.5 – 38.25 | 1435 – 1626.5 | 9.0 – 9.2 |
| 4.20725 – 4.20775 | 73 – 74.6 | 1645.5 – 1646.5 | 9.3 – 9.5 |
| 6.215 – 6.218 | 74.8 – 75.2 | 1660 – 1710 | 10.6 – 12.7 |
| 6.26775 – 6.26825 | 108 – 121.94 | 1718.8 – 1722.2 | 13.25 – 13.4 |
| 6.31175 – 6.31225 | 123 – 138 | 2200 – 2300 | 14.47 – 14.5 |
| 8.291 – 8.294 | 149.9 – 150.05 | 2310 – 2390 | 15.35 – 16.2 |
| 8.362 – 8.366 | 156.52475 – 156.52525 | 2483.5 – 2500 | 17.7 – 21.4 |
| 8.37625 – 8.38675 | 156.7 – 156.9 | 2690 – 2900 | 22.01 – 23.12 |
| 8.81425 – 8.81475 | 162.0125 – 167.17 | 3260 – 3267 | 23.6 – 24.0 |
| 12.29 – 12.293 | 167.72 – 173.2 | 3332 – 3339 | 31.2 – 31.8 |
| 12.51975 – 12.52025 | 240 – 285 | 3345.8 – 3358 | 36.43 – 36.5 |
| 12.57675 – 12.57725 | 322 – 335.4 | 3600 – 4400 | |
| 13.36 – 13.41 | | | |

Standard

RSS-Gen Issue 5 Paragraph 8.10

Restricted Bands of operation for IC

| | | | |
|---------------------|-----------------------|-----------------|---------------|
| 0.090 - 0.110 | 13.36 - 13.41 | 960 - 1427 | 9.0 - 9.2 |
| 0.495 - 0.505 | 16.42 - 16.423 | 1435 - 1626.5 | 9.3 - 9.5 |
| 2.1735 - 2.1905 | 16.69475 - 16.69525 | 1645.5 - 1646.5 | 10.6 - 12.7 |
| 3.020 - 3.026 | 16.80425 - 16.80475 | 1660 - 1710 | 13.25 - 13.4 |
| 4.125 - 4.128 | 25.5 - 25.67 | 1718.8 - 1722.2 | 14.47 - 14.5 |
| 4.17725 - 4.17775 | 37.5 - 38.25 | 2200 - 2300 | 15.35 - 16.2 |
| 4.20725 - 4.20775 | 73 - 74.6 | 2310 - 2390 | 17.7 - 21.4 |
| 5.677 - 5.683 | 74.8 - 75.2 | 2483.5 - 2500 | 22.01 - 23.12 |
| 6.215 - 6.218 | 108 - 138 | 2655 - 2900 | 23.6 - 24.0 |
| 6.26775 - 6.26825 | 149.9 - 150.05 | 3260 - 3267 | 31.2 - 31.8 |
| 6.31175 - 6.31225 | 156.52475 - 156.52525 | 3332 - 3339 | 36.43 - 36.5 |
| 8.291 - 8.294 | 156.7 - 156.9 | 3345.8 - 3358 | Above 38.6 |
| 8.362 - 8.366 | 162.0125 - 167.17 | 3500 - 4400 | |
| 8.37625 - 8.38675 | 167.72 - 173.2 | 4500 - 5150 | |
| 8.41425 - 8.41475 | 240 - 285 | 5350 - 5460 | |
| 12.29 - 12.293 | 322 - 335.4 | 7250 - 7750 | |
| 12.51975 - 12.52025 | 399.9 - 410 | 8025 - 8500 | |
| 12.57675 - 12.57725 | 608 - 614 | -- | |

| Restricted Band Emissions Limit | | | |
|--|-----------------------|-------------------------|--------------------------|
| FCC Part 15 Subpart C Paragraph 15.209 | | | |
| Frequency (MHz) | Field strength (μV/m) | Field strength (dBμV/m) | Measurement distance (m) |
| 0.009 - 0.49 | 2400/F(kHz) | 48.5 – 13.8 | 300 _(Note 1) |
| 0.49 - 1.705 | 24000/F(kHz) | 33.8 - 23 | 30 _(Note 1) |
| 1.705 - 30 | 30 | 29.5 | 30 _(Note 1) |
| 30 - 88 | 100 | 40 | 3 _(Note 2) |
| 88 - 216 | 150 | 43.5 | 3 _(Note 2) |
| 216 - 960 | 200 | 46 | 3 _(Note 2) |
| Above 960 | 500 | 54 | 3 _(Note 2) |
| RSS-Gen Issue 5 Paragraph 8.9. | | | |
| Frequency (MHz) | Field strength | Field strength (dBμV/m) | Measurement distance (m) |
| 0.009 - 0.49 | 6.37/F(kHz) μA/m | 48.5 – 13.8 | 300 _(Note 1) |
| 0.49 - 1.705 | 63.7/F(kHz) μA/m | 33.8 - 23 | 30 _(Note 1) |
| 1.705 - 30 | 30 μV/m | 29.5 | 30 _(Note 1) |
| 30 - 88 | 100 μV/m | 40 | 3 _(Note 2) |
| 88 - 216 | 150 μV/m | 43.5 | 3 _(Note 2) |
| 216 - 960 | 200 μV/m | 46 | 3 _(Note 2) |
| Above 960 | 500 μV/m | 54 | 3 _(Note 2) |
| <p>Note 1: At frequencies below 30 MHz, measurements may be performed at a distance closer than that specified in the regulations; however, an attempt should be made to avoid making measurements in the near field. Pending the development of an appropriate measurement procedure for measurements performed below 30 MHz, when performing measurements at a closer distance than specified, the results shall be extrapolated to the specified distance by either making measurements at a minimum of two distances on at least one radial to determine the proper extrapolation factor or by using the square of an inverse linear distance extrapolation factor (40 dB/decade).</p> <p>Note 2: At frequencies at or above 30 MHz, measurements may be performed at a distance other than what is specified provided: measurements are not made in the near field except where it can be shown that near field measurements are appropriate due to the characteristics of the device; and it can be demonstrated that the signal levels needed to be measured at the distance employed can be detected by the measurement equipment. Measurements shall not be performed at a distance greater than 30 meters unless it can be further demonstrated that measurements at a distance of 30 meters or less are impractical. When performing measurements at a distance other than that specified, the results shall be extrapolated to the specified distance using an extrapolation factor of 20 dB/decade (inverse linear-distance for field strength measurements; inverse-linear-distance-squared for power density measurements).</p> | | | |

4.10.2 Test Setup

Below 30MHz Test Setup:

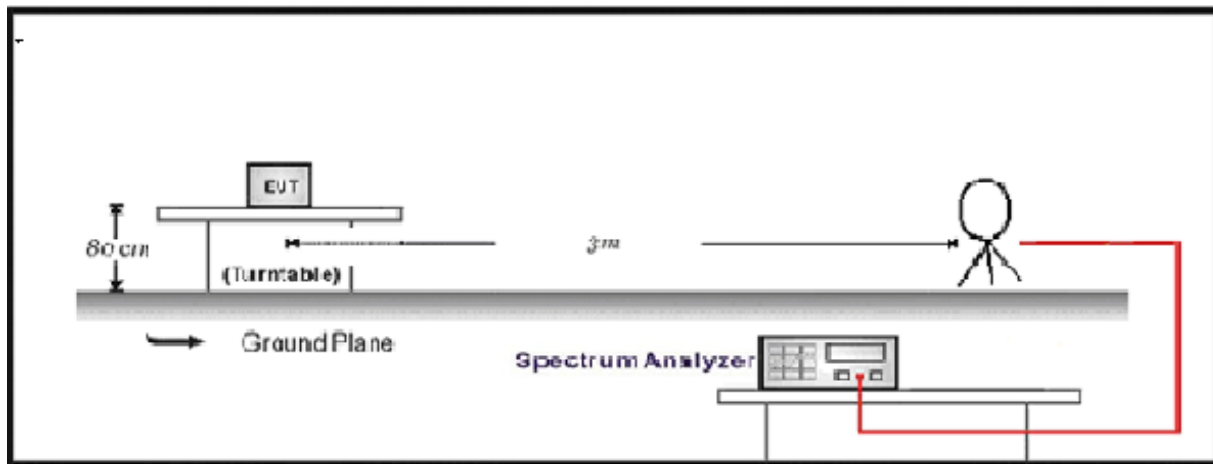

30MHz-1GHz Test Setup:

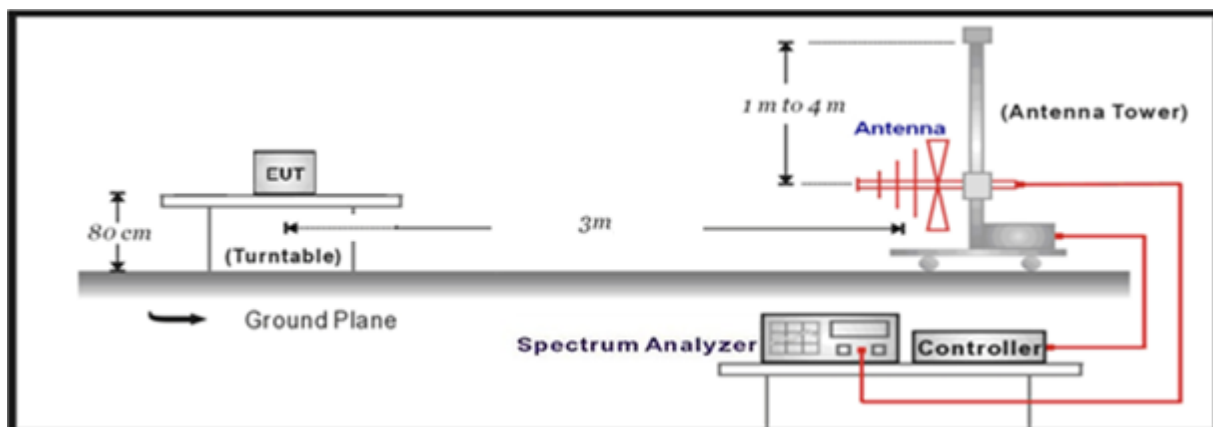

Above 1GHz Test Setup:

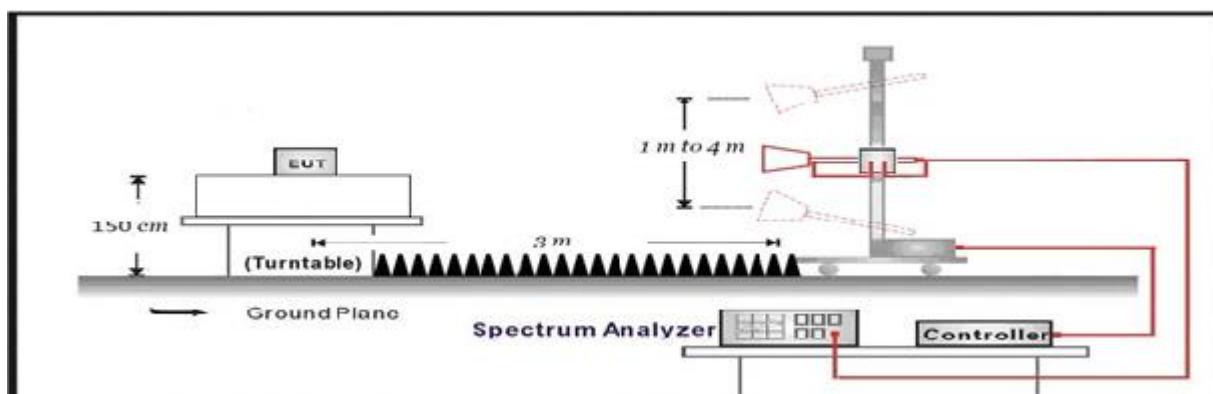

| 4.10.3 Test Procedure | | | |
|-------------------------------------|---|-----------|--|
| | References Rule | Chapter | Description |
| <input checked="" type="checkbox"/> | ANSI C63.10 | 11.12 | Emissions in restricted frequency bands |
| | <input checked="" type="checkbox"/> ANSI C63.10 | 11.12.1 | Radiated emission measurements |
| | <input checked="" type="checkbox"/> ANSI C63.10 | 11.12.2.7 | Radiated spurious emission test |
| | <input checked="" type="checkbox"/> ANSI C63.10 | 6.4 | Radiated emissions from unlicensed wireless devices below 30 MHz |
| | <input checked="" type="checkbox"/> ANSI C63.10 | 6.5 | Radiated emissions from unlicensed wireless devices in the frequency range of 30 MHz to 1000 MHz |
| | <input checked="" type="checkbox"/> ANSI C63.10 | 6.6 | Radiated emissions from unlicensed wireless devices above 1 GHz |
| <input checked="" type="checkbox"/> | CFR 47, FCC Part 15 A | 15.35 | Measurement detector functions and bandwidths. |
| | <input checked="" type="checkbox"/> CFR 47, FCC Part 15 A | 15.35(c) | Unless otherwise specified, e.g., §§ 15.255(b), and 15.256(l)(5), when the radiated emission limits are expressed in terms of the average value of the emission, and pulsed operation is employed, the measurement field strength shall be determined by averaging over one complete pulse train, including blanking intervals, as long as the pulse train does not exceed 0.1 seconds. As an alternative (provided the transmitter operates for longer than 0.1 seconds) or in cases where the pulse train exceeds 0.1 seconds, the measured field strength shall be determined from the average absolute voltage during a 0.1 second interval during which the field strength is at its maximum value. The exact method of calculating the average field strength shall be submitted with any application for certification or shall be retained in the measurement data file for equipment subject to Supplier's Declaration of Conformity. |

4.11 AC Power Line Conducted Emission

VERDICT: PASS

4.11.1 Limit

Standard FCC Part 15 Subpart C Paragraph 15.207; RSS-Gen Issue 5 Paragraph 8.8.

| Frequency range [MHz] | Limit: QP [dB(μV) ¹⁾ | Limit: AV [dB(μV) ¹⁾ |
|-----------------------|---------------------------------|---------------------------------|
| 0,15 - 0,50 | 66 - 56 ²⁾ | 56 - 46 ²⁾ |
| 0,50 - 5,0 | 56 | 46 |
| 5,0 - 30 | 60 | 50 |

¹⁾ At the transition frequency, the lower limit applies.

²⁾ The limit decreases linearly with the logarithm of the frequency.

NOTE 1: The exclusion band for transmitters shall be considered for transmitters operating at frequencies below 30 MHz.

NOTE 2: Where the AC output port is directly connected (or via a circuit breaker) to the AC power input port of the EUT the AC power output port need not to be tested.

4.11.2 Test Setup

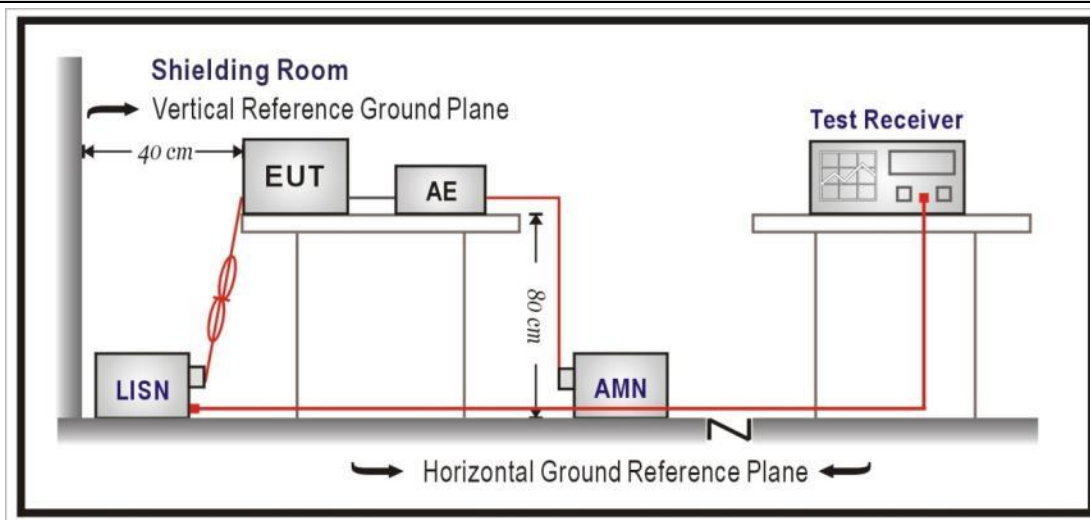

4.11.3 Test Procedure

| | References Rule | Chapter | Item |
|-------------------------------------|------------------|---------|---|
| <input checked="" type="checkbox"/> | ANSI C63.10-2013 | 6.2 | Standard test method for ac power-line conducted emissions from unlicensed wireless devices |

| | |
|---------------------------------|----------------------|
| 4.12 Antenna Requirement | VERDICT: PASS |
|---------------------------------|----------------------|

4.12.1 Limit

| | |
|-----------------|---|
| Standard | FCC Part 15 Subpart C Paragraph 15.247(d) ,15.209 RSS-Gen Issue 5 Paragraph 6.8. |
|-----------------|---|

An intentional radiator shall be designed to ensure that no antenna other than that furnished by the responsible party shall be used with the device. The use of a permanently attached antenna or of an antenna that uses a unique coupling to the intentional radiator shall be considered sufficient to comply with the provisions of this section. The manufacturer may design the unit so that a broken antenna can be replaced by the user, but the use of a standard antenna jack or electrical connector is prohibited. This requirement does not apply to carrier current devices or to devices operated under the provisions of §15.211, §15.213, §15.217, §15.219, or §15.221. Further, this requirement does not apply to intentional radiators that must be professionally installed, such as perimeter protection systems and some field disturbance sensors, or to other intentional radiators which, in accordance with §15.31(d), must be measured at the installation site. However, the installer shall be responsible for ensuring that the proper antenna is employed so that the limits in this part are not exceeded.

4.12.2 Antenna Connector Construction:

| | |
|-------------------------------------|--|
| <input checked="" type="checkbox"/> | The use of a permanently attached antenna |
| <input type="checkbox"/> | The antenna use of a unique coupling to the intentional radiator |
| <input type="checkbox"/> | The use of a nonstandard antenna jack or electrical connector |

Please refer to the attached document "Internal Photograph" to show the antenna connector.

5 TEST SETUP PHOTO AND EUT PHOTO

Remark: The test setup photo and EUT Photo please see appendix.

6 TEST RESULT

Appendix A: 20dB Emission Bandwidth

| Test Mode | Frequency[MHz] | 20db EBW[MHz] | FL[MHz] | FH[MHz] | Limit[MHz] | Verdict |
|-----------|----------------|---------------|----------|----------|-------------|---------|
| DH5 | 2402 | 0.957 | 2401.550 | 2402.507 | 2400-2483.5 | PASS |
| | 2441 | 0.885 | 2440.562 | 2441.447 | 2400-2483.5 | PASS |
| | 2480 | 0.948 | 2479.553 | 2480.501 | 2400-2483.5 | PASS |
| 2DH5 | 2402 | 1.350 | 2401.337 | 2402.687 | 2400-2483.5 | PASS |
| | 2441 | 1.341 | 2440.343 | 2441.684 | 2400-2483.5 | PASS |
| | 2480 | 1.335 | 2479.352 | 2480.687 | 2400-2483.5 | PASS |
| 3DH5 | 2402 | 1.284 | 2401.370 | 2402.654 | 2400-2483.5 | PASS |
| | 2441 | 1.341 | 2440.340 | 2441.681 | 2400-2483.5 | PASS |
| | 2480 | 1.311 | 2479.367 | 2480.678 | 2400-2483.5 | PASS |

DH5_Ant1_2402



DH5_Ant1_2441



DH5_Ant1_2480



2DH5_Ant1_2402



2DH5_Ant1_2441



2DH5_Ant1_2480



3DH5_Ant1_2402



3DH5_Ant1_2441



3DH5_Ant1_2480



Appendix B: Occupied Channel Bandwidth

| Test Mode | Frequency[MHz] | OCB [MHz] | FL[MHz] | FH[MHz] |
|-----------|----------------|-----------|-----------|-----------|
| DH5 | 2402 | 0.84267 | 2401.5900 | 2402.4326 |
| | 2441 | 0.82702 | 2440.5957 | 2441.4227 |
| | 2480 | 0.84679 | 2479.5912 | 2480.4380 |
| 2DH5 | 2402 | 1.2590 | 2401.3868 | 2402.6458 |
| | 2441 | 1.2500 | 2440.4000 | 2441.6500 |
| | 2480 | 1.2290 | 2479.3995 | 2480.6285 |
| 3DH5 | 2402 | 1.2300 | 2401.3969 | 2402.6269 |
| | 2441 | 1.2135 | 2440.4146 | 2441.6281 |
| | 2480 | 1.2146 | 2479.4046 | 2480.6192 |

DH5_Ant1_2402

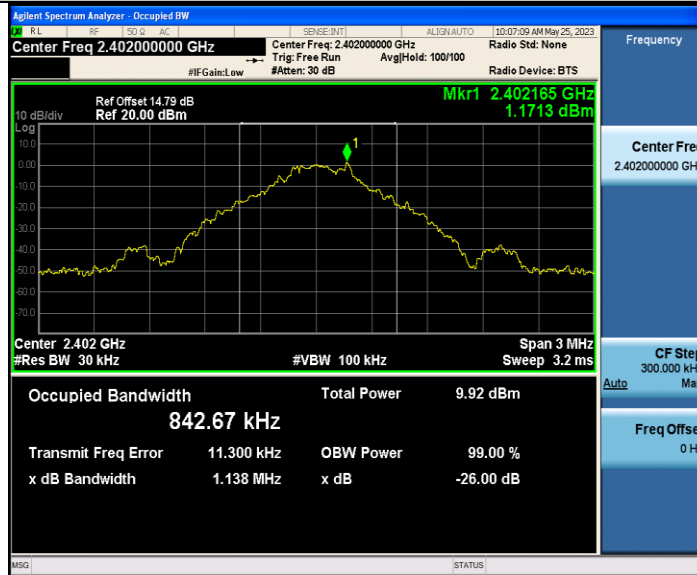

DH5_Ant1_2441



DH5_Ant1_2480



2DH5_Ant1_2402



2DH5_Ant1_2441



2DH5_Ant1_2480



3DH5_Ant1_2402



3DH5_Ant1_2441



3DH5_Ant1_2480

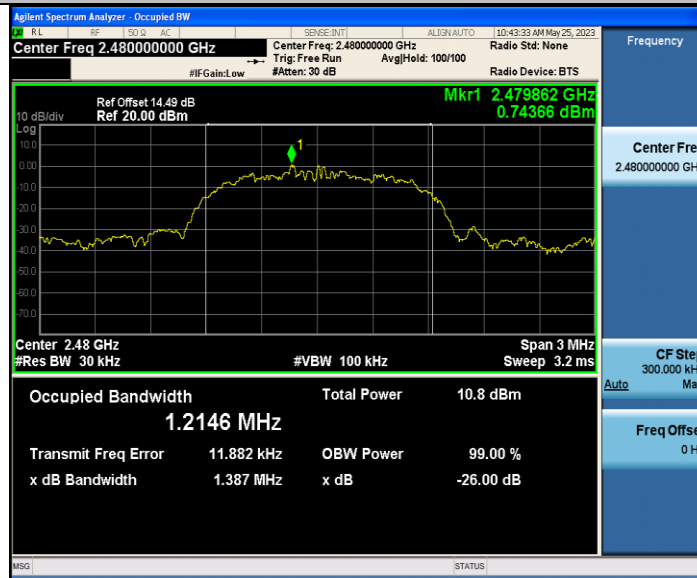

Appendix C: Maximum conducted output power

| Test Mode | Frequency[MHz] | Conducted Power [dBm] | EIRP Power[dBm] | Conducted Limit[dBm] | EIRP Limit[dBm] | Verdict |
|-----------|----------------|-----------------------|-----------------|----------------------|-----------------|---------|
| DH5 | 2402 | 5.86 | 8.76 | ≤30 | ≤36 | PASS |
| | 2441 | 5.15 | 8.05 | ≤30 | ≤36 | PASS |
| | 2480 | 5.23 | 8.13 | ≤30 | ≤36 | PASS |
| 2DH5 | 2402 | 5.81 | 8.71 | ≤20.97 | ≤36 | PASS |
| | 2441 | 5.23 | 8.13 | ≤20.97 | ≤36 | PASS |
| | 2480 | 5.31 | 8.21 | ≤20.97 | ≤36 | PASS |
| 3DH5 | 2402 | 5.79 | 8.69 | ≤20.97 | ≤36 | PASS |
| | 2441 | 5.42 | 8.32 | ≤20.97 | ≤36 | PASS |
| | 2480 | 5.29 | 8.19 | ≤20.97 | ≤36 | PASS |

Appendix D: Carrier frequency separation

| TestMode | Frequency[MHz] | Result[MHz] | Limit[MHz] | Verdict |
|----------|----------------|-------------|------------|---------|
| DH5 | Hop | 0.69 | ≥0.638 | PASS |
| 2DH5 | Hop | 1.122 | ≥0.900 | PASS |
| 3DH5 | Hop | 0.968 | ≥0.894 | PASS |

DH5_Ant1_Hop



2DH5_Ant1_Hop

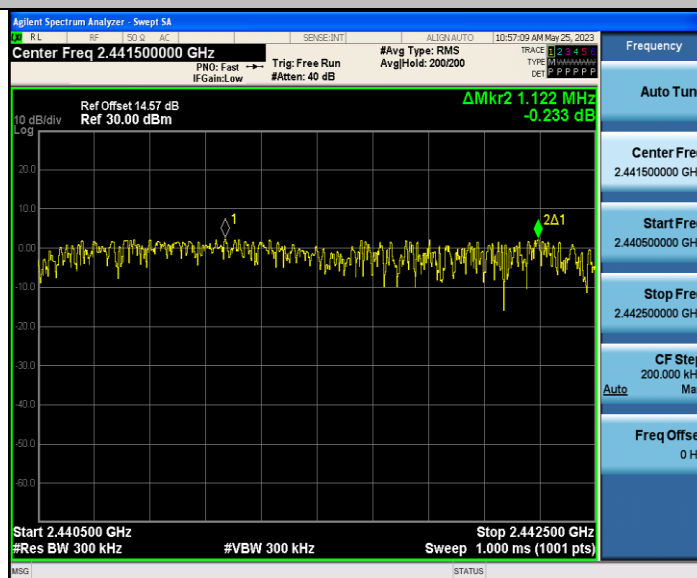

3DH5_Ant1_Hop



Appendix E: Time of occupancy

| TestMode | Frequency[MHz] | BurstWidth [ms] | TotalHops [Num] | Result[s] | Limit[s] | Verdict |
|----------|----------------|-----------------|-----------------|-----------|----------|---------|
| DH5 | Hop | 2.889 | 106.67 | 0.308 | ≤0.4 | PASS |
| 2DH5 | Hop | 2.891 | 106.67 | 0.308 | ≤0.4 | PASS |
| 3DH5 | Hop | 2.893 | 106.67 | 0.309 | ≤0.4 | PASS |

DH5_Ant1_Hop

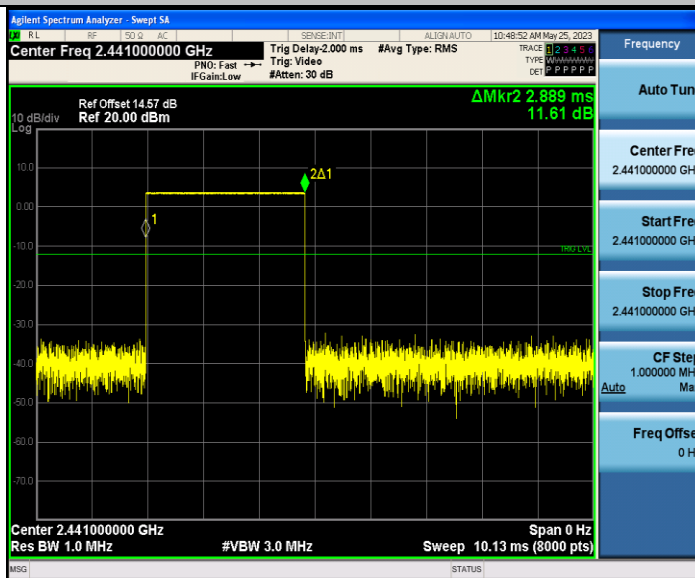

2DH5_Ant1_Hop

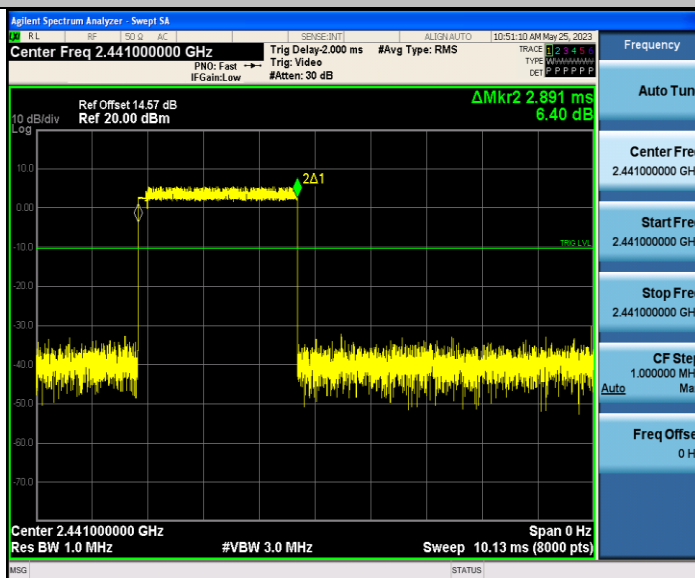

3DH5_Ant1_Hop

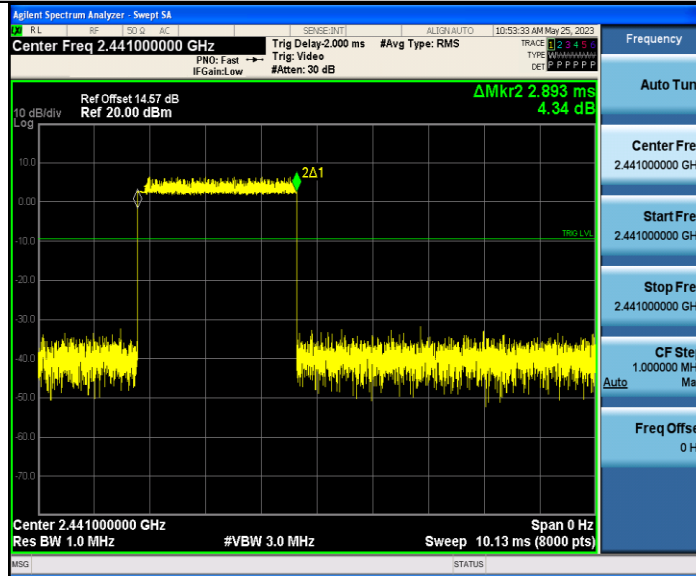

Appendix F: Number of hopping channels

| TestMode | Frequency[MHz] | Result[Num] | Limit[Num] | Verdict |
|----------|----------------|-------------|------------|---------|
| DH5 | Hop | 79 | ≥15 | PASS |
| 2DH5 | Hop | 79 | ≥15 | PASS |
| 3DH5 | Hop | 79 | ≥15 | PASS |

DH5_Ant1_Hop

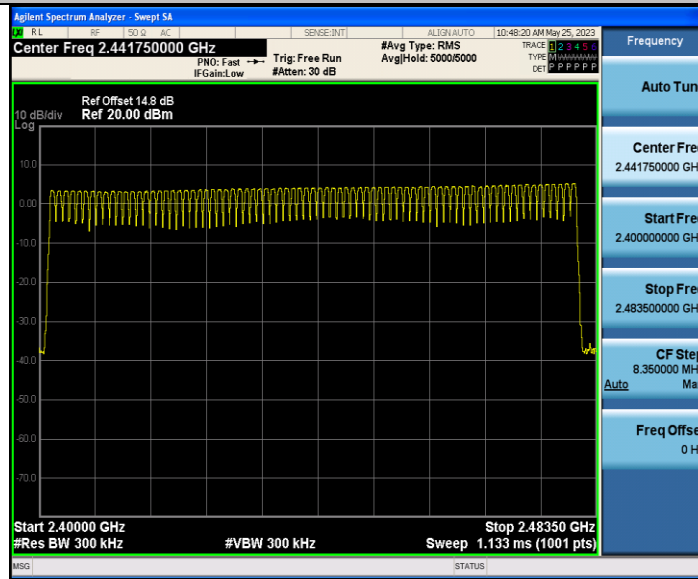

2DH5_Ant1_Hop

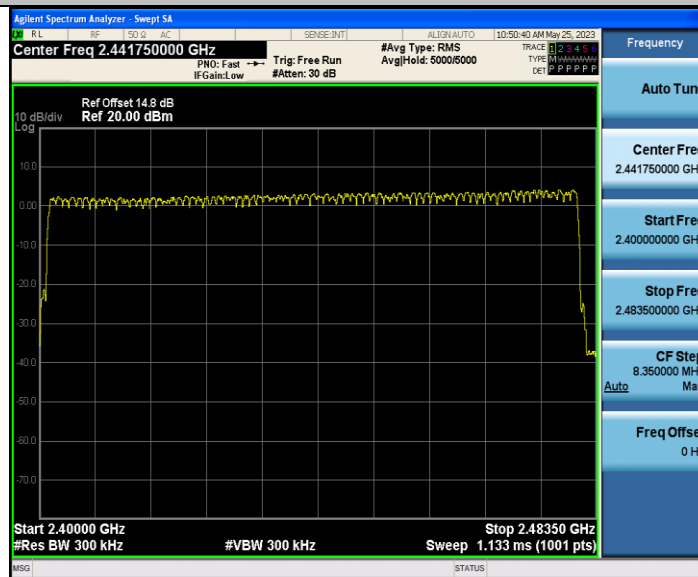

3DH5_Ant1_Hop

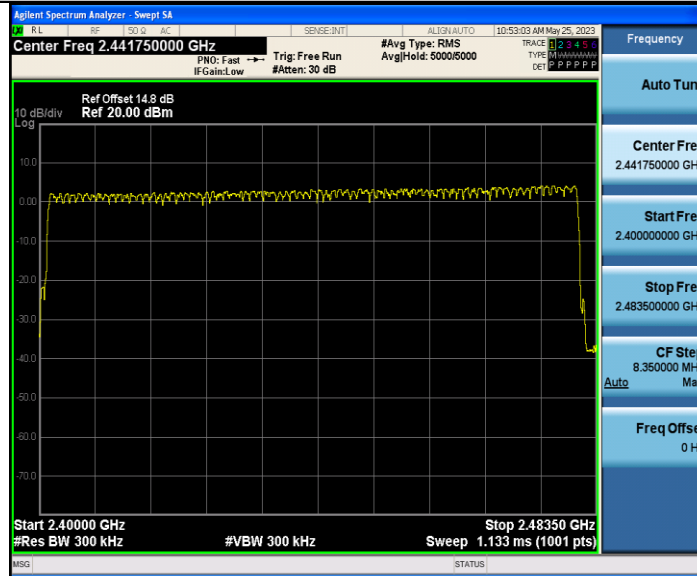

Appendix G: Band edge measurements

| | |
|---|--------------------------|
| Profile: 2350171R | Page No.: 1 |
| Engineer: Yuliu | |
| Site: AC5 | Time: 2023/05/25 - 20:03 |
| Limit: FCC_Part15.209_RE(3m) | Margin: 0 |
| Probe: Horn_3117_00167055(1-18GHz) | Polarity: Horizontal |
| EUT: Charge Base | Power: 120 Vac / 60 Hz |
| Note: Mode 1 : Transmit at 2402MHz by DH5 | |

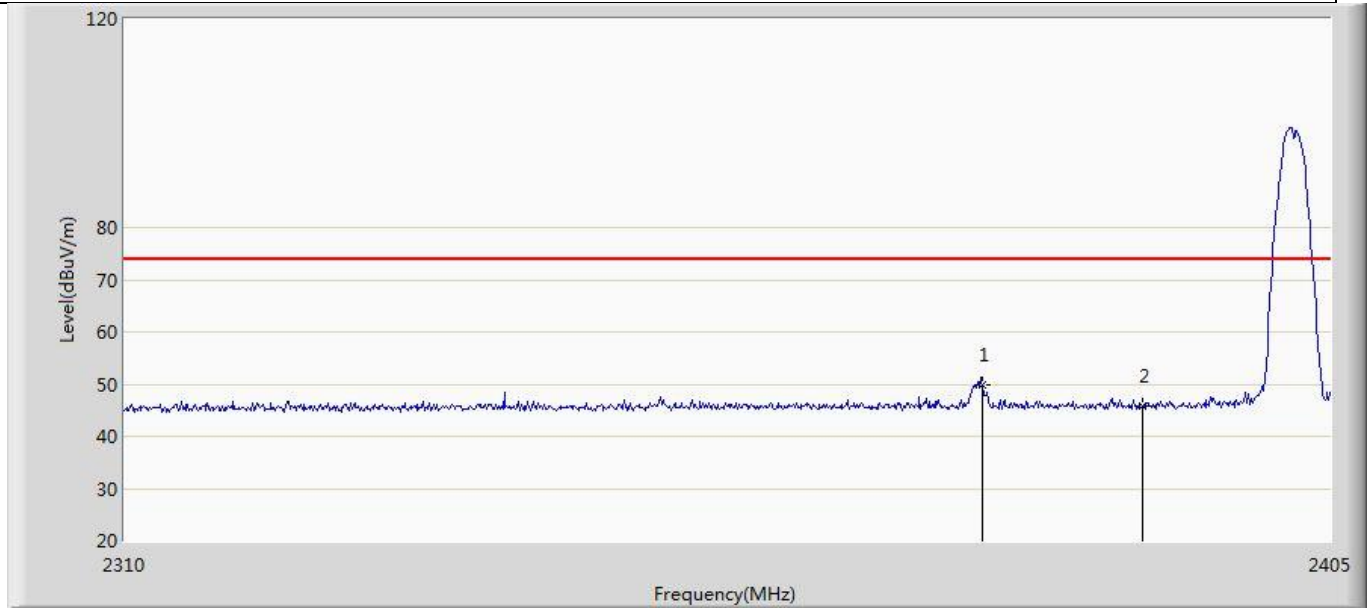

| No | Mark | Frequency (MHz) | Measure Level (dBuV/m) | Reading Level (dBuV) | Over Limit (dB) | Limit (dBuV/m) | Factor (dB) | Type |
|----|------|-----------------|------------------------|----------------------|-----------------|----------------|-------------|------|
| 1 | * | 2377.260 | 49.851 | 15.820 | -24.149 | 74.000 | 34.031 | PK |
| 2 | | 2390.000 | 45.741 | 11.657 | -28.259 | 74.000 | 34.084 | PK |

| | |
|---|--------------------------|
| Profile: 2350171R | Page No.: 2 |
| Engineer: Yuliu | |
| Site: AC5 | Time: 2023/05/25 - 20:11 |
| Limit: FCC_Part15.209_RE(3m) | Margin: 0 |
| Probe: Horn_3117_00167055(1-18GHz) | Polarity: Horizontal |
| EUT: Charge Base | Power: 120 Vac / 60 Hz |
| Note: Mode 1 : Transmit at 2402MHz by DH5 | |

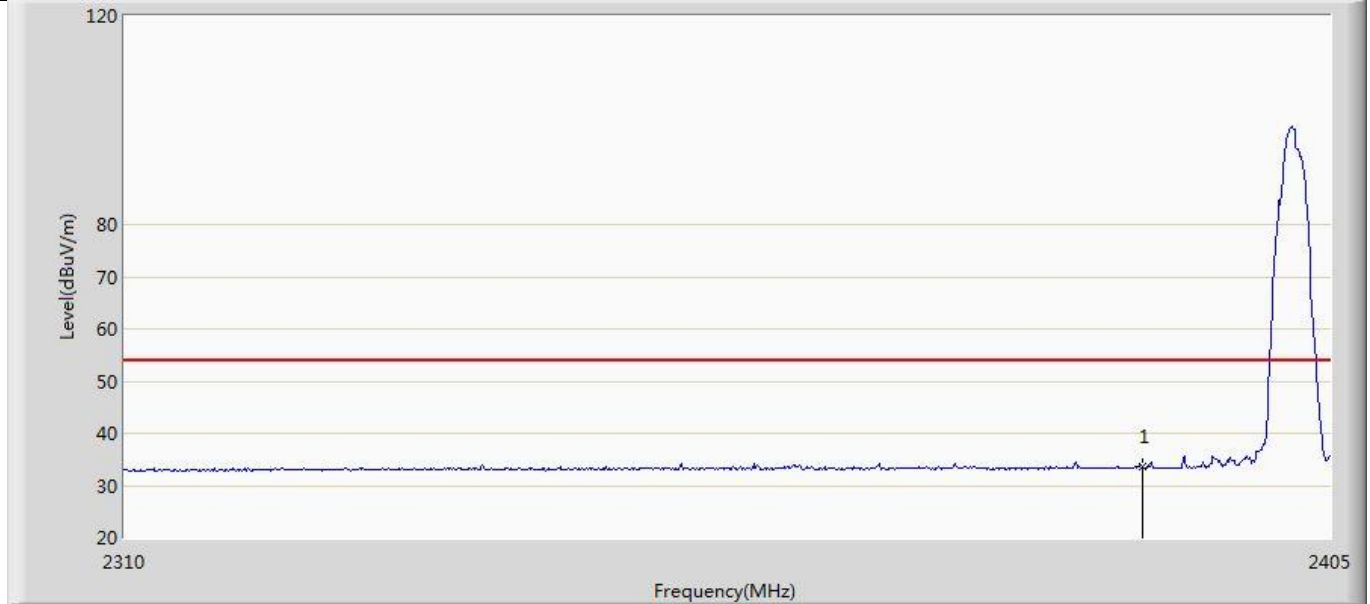

| No | Mark | Frequency (MHz) | Measure Level (dBuV/m) | Reading Level (dBuV) | Over Limit (dB) | Limit (dBuV/m) | Factor (dB) | Type |
|----|------|-----------------|------------------------|----------------------|-----------------|----------------|-------------|------|
| 1 | * | 2390.000 | 33.536 | -0.548 | -20.464 | 54.000 | 34.084 | AV |

| | |
|---|--------------------------|
| Profile: 2350171R | Page No.: 3 |
| Engineer: Yuliu | |
| Site: AC5 | Time: 2023/05/25 - 20:12 |
| Limit: FCC_Part15.209_RE(3m) | Margin: 0 |
| Probe: Horn_3117_00167055(1-18GHz) | Polarity: Vertical |
| EUT: Charge Base | Power: 120 Vac / 60 Hz |
| Note: Mode 1 : Transmit at 2402MHz by DH5 | |

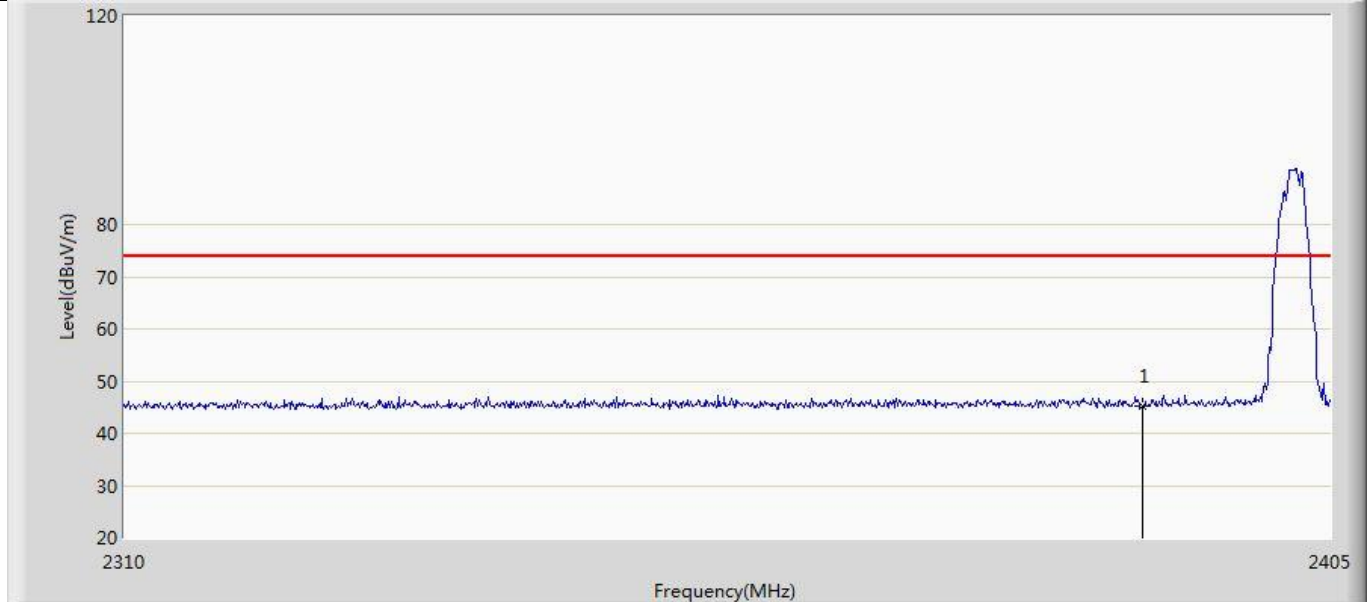

| No | Mark | Frequency (MHz) | Measure Level (dBuV/m) | Reading Level (dBuV) | Over Limit (dB) | Limit (dBuV/m) | Factor (dB) | Type |
|----|------|-----------------|------------------------|----------------------|-----------------|----------------|-------------|------|
| 1 | * | 2390.000 | 45.094 | 11.010 | -28.906 | 74.000 | 34.084 | PK |

| | |
|---|--------------------------|
| Profile: 2350171R | Page No.: 4 |
| Engineer: Yuliu | |
| Site: AC5 | Time: 2023/05/25 - 20:13 |
| Limit: FCC_Part15.209_RE(3m) | Margin: 0 |
| Probe: Horn_3117_00167055(1-18GHz) | Polarity: Vertical |
| EUT: Charge Base | Power: 120 Vac / 60 Hz |
| Note: Mode 1 : Transmit at 2402MHz by DH5 | |

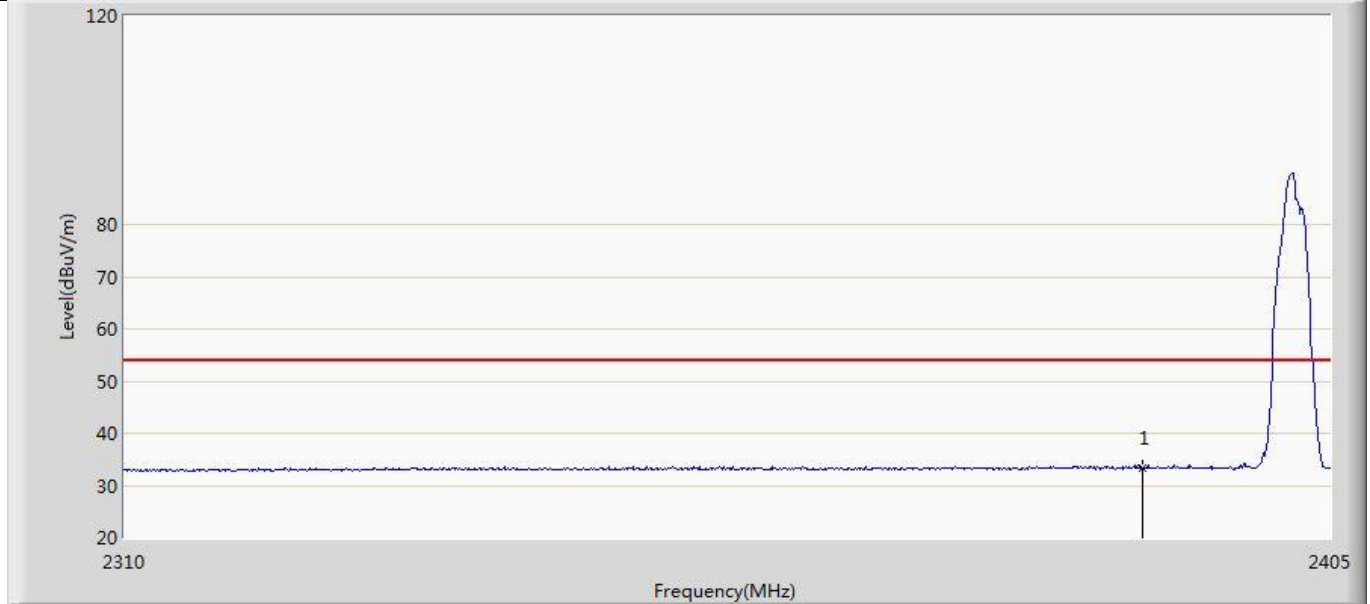

| No | Mark | Frequency (MHz) | Measure Level (dBuV/m) | Reading Level (dBuV) | Over Limit (dB) | Limit (dBuV/m) | Factor (dB) | Type |
|----|------|-----------------|------------------------|----------------------|-----------------|----------------|-------------|------|
| 1 | * | 2390.000 | 33.333 | -0.751 | -20.667 | 54.000 | 34.084 | AV |

| | |
|---|--------------------------|
| Profile: 2350171R | Page No.: 5 |
| Engineer: Yuliu | |
| Site: AC5 | Time: 2023/05/25 - 20:14 |
| Limit: FCC_Part15.209_RE(3m) | Margin: 0 |
| Probe: Horn_3117_00167055(1-18GHz) | Polarity: Horizontal |
| EUT: Charge Base | Power: 120 Vac / 60 Hz |
| Note: Mode 1 : Transmit at 2480MHz by DH5 | |

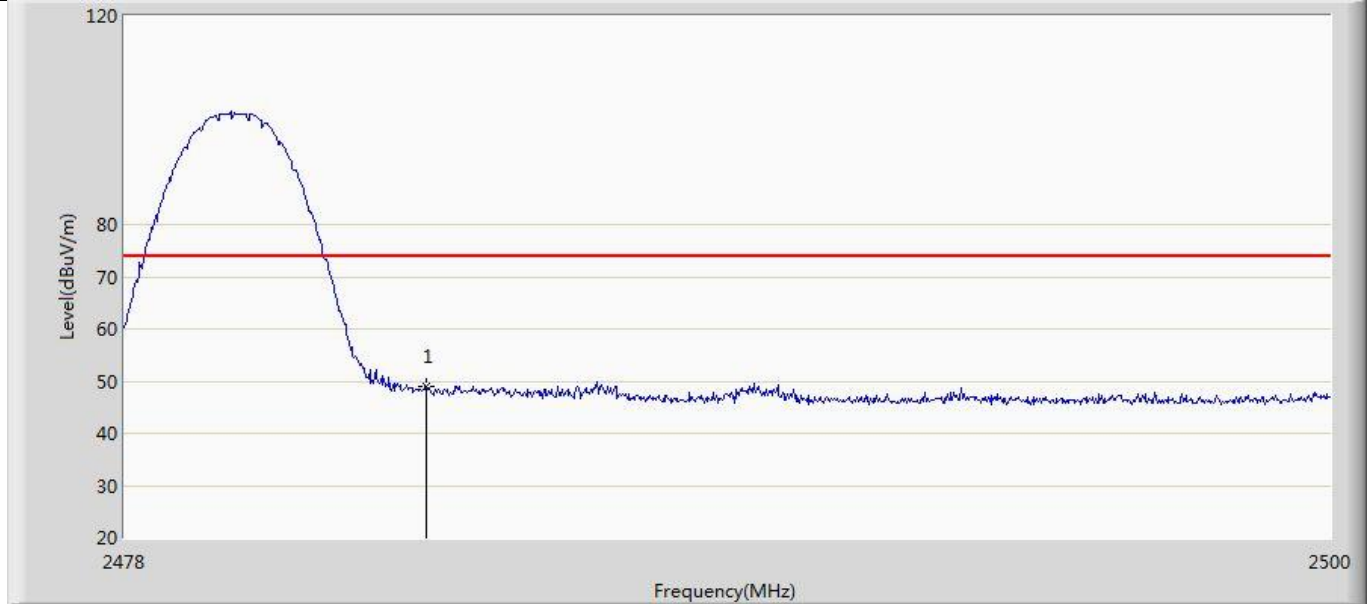

| No | Mark | Frequency (MHz) | Measure Level (dBuV/m) | Reading Level (dBuV) | Over Limit (dB) | Limit (dBuV/m) | Factor (dB) | Type |
|----|------|-----------------|------------------------|----------------------|-----------------|----------------|-------------|------|
| 1 | * | 2483.500 | 49.085 | 14.594 | -24.915 | 74.000 | 34.491 | PK |

| | |
|---|--------------------------|
| Profile: 2350171R | Page No.: 6 |
| Engineer: Yuliu | |
| Site: AC5 | Time: 2023/05/25 - 20:16 |
| Limit: FCC_Part15.209_RE(3m) | Margin: 0 |
| Probe: Horn_3117_00167055(1-18GHz) | Polarity: Horizontal |
| EUT: Charge Base | Power: 120 Vac / 60 Hz |
| Note: Mode 1 : Transmit at 2480MHz by DH5 | |

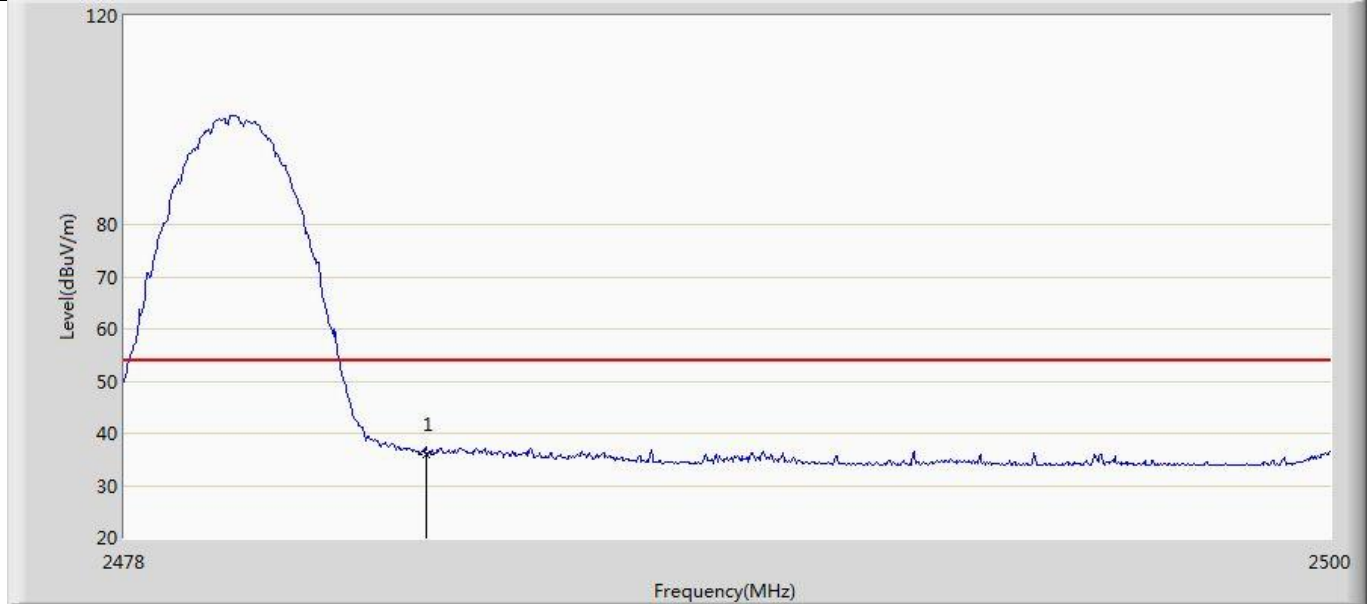

| No | Mark | Frequency (MHz) | Measure Level (dBuV/m) | Reading Level (dBuV) | Over Limit (dB) | Limit (dBuV/m) | Factor (dB) | Type |
|----|------|-----------------|------------------------|----------------------|-----------------|----------------|-------------|------|
| 1 | * | 2483.500 | 36.027 | 1.536 | -17.973 | 54.000 | 34.491 | AV |

| | |
|---|--------------------------|
| Profile: 2350171R | Page No.: 7 |
| Engineer: Yuliu | |
| Site: AC5 | Time: 2023/05/25 - 20:17 |
| Limit: FCC_Part15.209_RE(3m) | Margin: 0 |
| Probe: Horn_3117_00167055(1-18GHz) | Polarity: Vertical |
| EUT: Charge Base | Power: 120 Vac / 60 Hz |
| Note: Mode 1 : Transmit at 2480MHz by DH5 | |

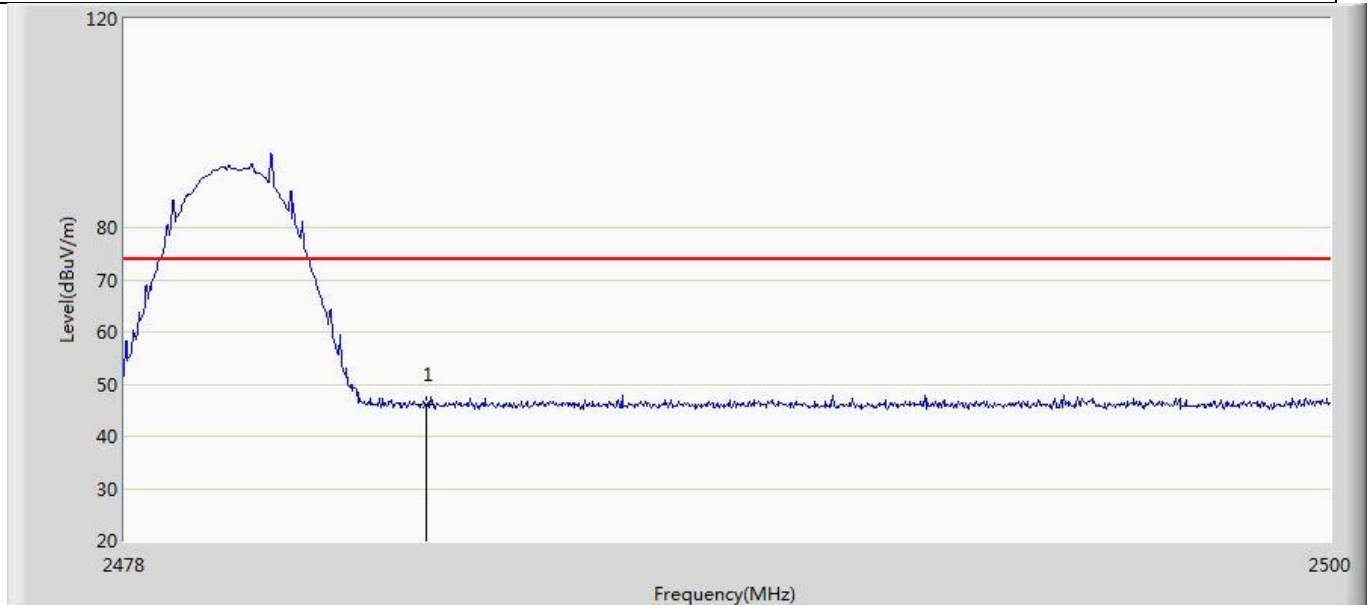

| No | Mark | Frequency (MHz) | Measure Level (dBuV/m) | Reading Level (dBuV) | Over Limit (dB) | Limit (dBuV/m) | Factor (dB) | Type |
|----|------|-----------------|------------------------|----------------------|-----------------|----------------|-------------|------|
| 1 | * | 2483.500 | 46.101 | 11.610 | -27.899 | 74.000 | 34.491 | PK |

| | |
|---|--------------------------|
| Profile: 2350171R | Page No.: 8 |
| Engineer: Yuliu | |
| Site: AC5 | Time: 2023/05/25 - 20:18 |
| Limit: FCC_Part15.209_RE(3m) | Margin: 0 |
| Probe: Horn_3117_00167055(1-18GHz) | Polarity: Vertical |
| EUT: Charge Base | Power: 120 Vac / 60 Hz |
| Note: Mode 1 : Transmit at 2480MHz by DH5 | |

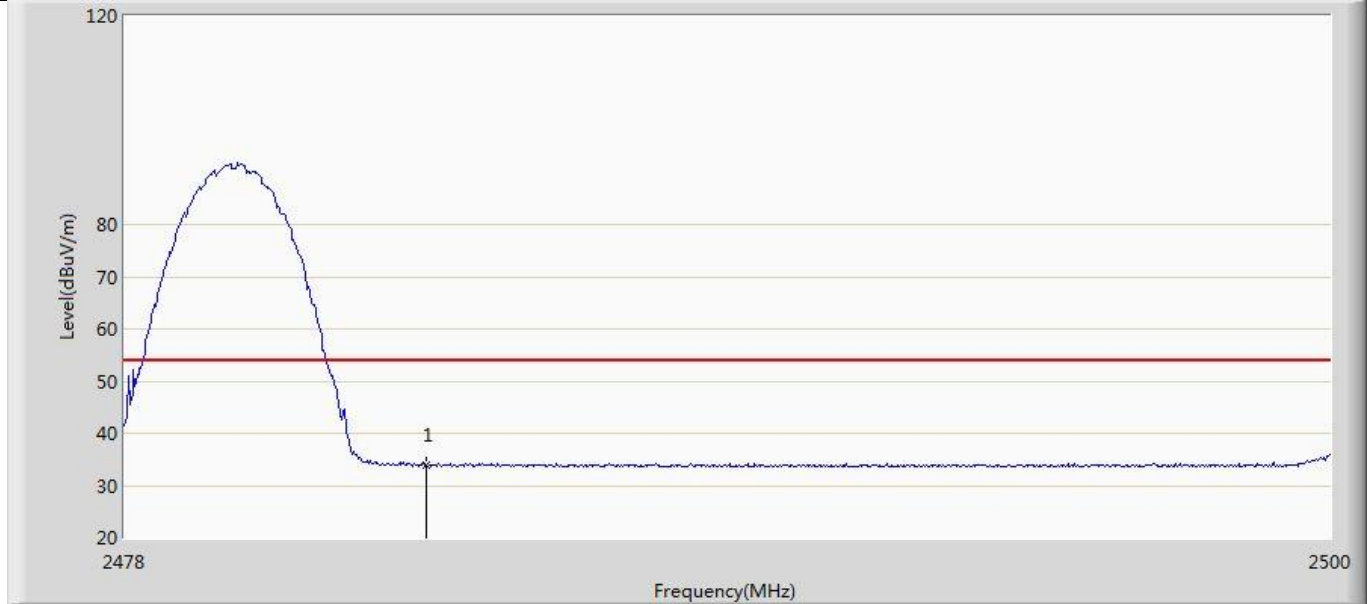

| No | Mark | Frequency (MHz) | Measure Level (dBuV/m) | Reading Level (dBuV) | Over Limit (dB) | Limit (dBuV/m) | Factor (dB) | Type |
|----|------|-----------------|------------------------|----------------------|-----------------|----------------|-------------|------|
| 1 | * | 2483.500 | 33.984 | -0.507 | -20.016 | 54.000 | 34.491 | AV |

| | |
|--|--------------------------|
| Profile: 2350171R | Page No.: 9 |
| Engineer: Yuliu | |
| Site: AC5 | Time: 2023/05/25 - 20:19 |
| Limit: FCC_Part15.209_RE(3m) | Margin: 0 |
| Probe: Horn_3117_00167055(1-18GHz) | Polarity: Horizontal |
| EUT: Charge Base | Power: 120 Vac / 60 Hz |
| Note: Mode 2 : Transmit at 2402MHz by 2DH5 | |

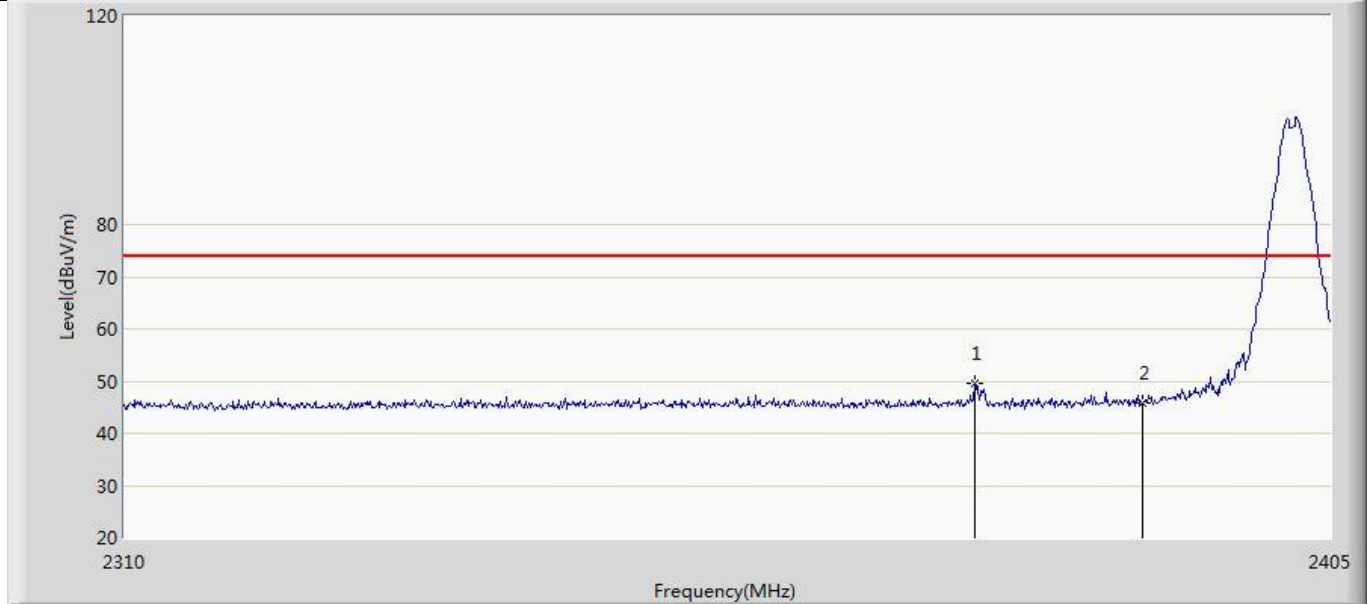

| No | Mark | Frequency (MHz) | Measure Level (dBuV/m) | Reading Level (dBuV) | Over Limit (dB) | Limit (dBuV/m) | Factor (dB) | Type |
|----|------|-----------------|------------------------|----------------------|-----------------|----------------|-------------|------|
| 1 | * | 2376.595 | 49.481 | 15.453 | -24.519 | 74.000 | 34.028 | PK |
| 2 | | 2390.000 | 45.721 | 11.637 | -28.279 | 74.000 | 34.084 | PK |

| | |
|--|--------------------------|
| Profile: 2350171R | Page No.: 10 |
| Engineer: Yuliu | |
| Site: AC5 | Time: 2023/05/25 - 20:20 |
| Limit: FCC_Part15.209_RE(3m) | Margin: 0 |
| Probe: Horn_3117_00167055(1-18GHz) | Polarity: Horizontal |
| EUT: Charge Base | Power: 120 Vac / 60 Hz |
| Note: Mode 2 : Transmit at 2402MHz by 2DH5 | |

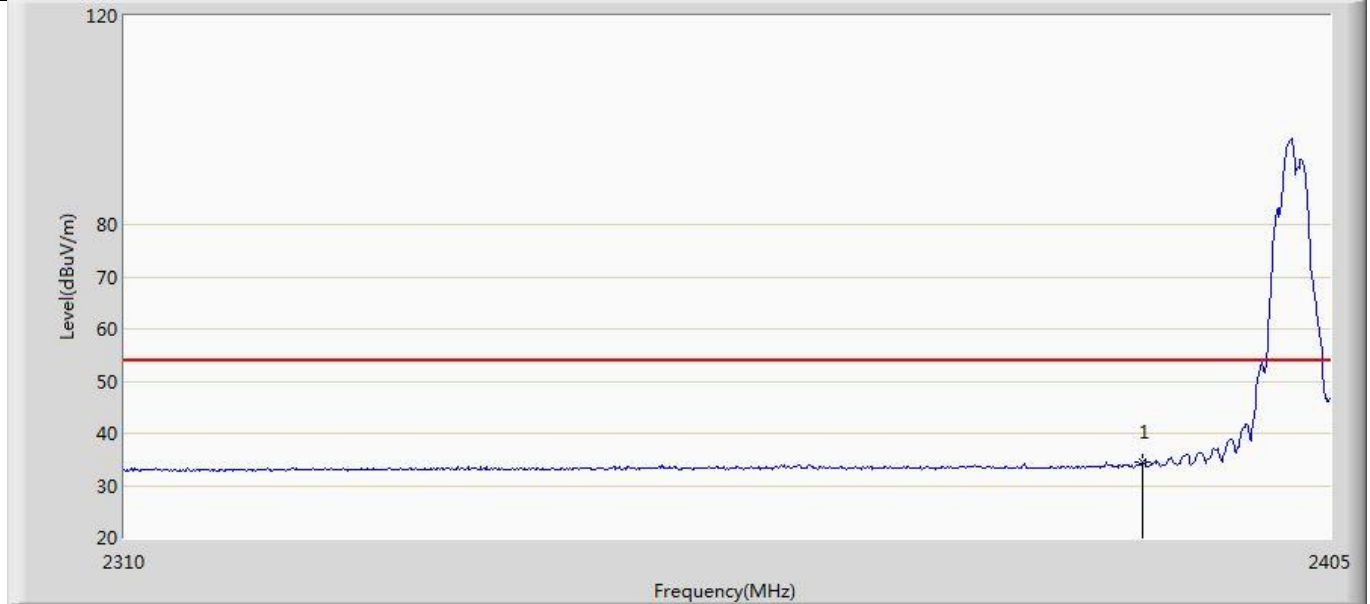

| No | Mark | Frequency (MHz) | Measure Level (dBuV/m) | Reading Level (dBuV) | Over Limit (dB) | Limit (dBuV/m) | Factor (dB) | Type |
|----|------|-----------------|------------------------|----------------------|-----------------|----------------|-------------|------|
| 1 | * | 2390.000 | 34.421 | 0.337 | -19.579 | 54.000 | 34.084 | AV |

| | |
|--|--------------------------|
| Profile: 2350171R | Page No.: 11 |
| Engineer: Yuliu | |
| Site: AC5 | Time: 2023/05/25 - 20:21 |
| Limit: FCC_Part15.209_RE(3m) | Margin: 0 |
| Probe: Horn_3117_00167055(1-18GHz) | Polarity: Vertical |
| EUT: Charge Base | Power: 120 Vac / 60 Hz |
| Note: Mode 2 : Transmit at 2402MHz by 2DH5 | |

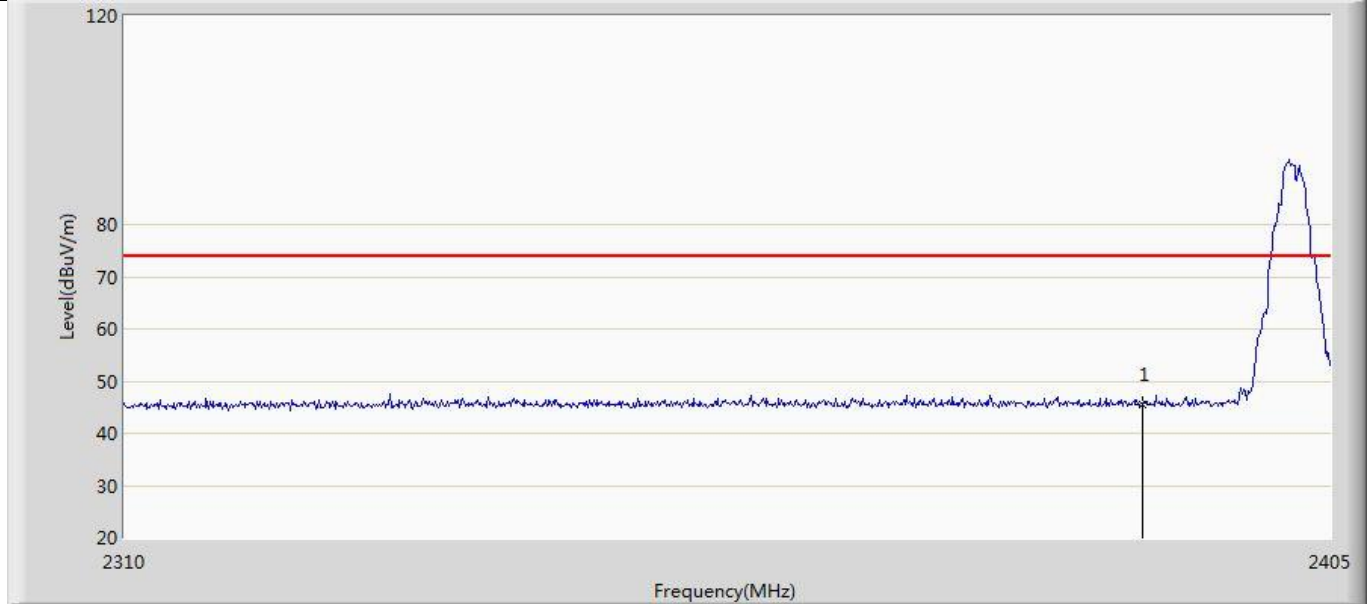

| No | Mark | Frequency (MHz) | Measure Level (dBuV/m) | Reading Level (dBuV) | Over Limit (dB) | Limit (dBuV/m) | Factor (dB) | Type |
|----|------|-----------------|------------------------|----------------------|-----------------|----------------|-------------|------|
| 1 | * | 2390.000 | 45.437 | 11.353 | -28.563 | 74.000 | 34.084 | PK |

| | |
|--|--------------------------|
| Profile: 2350171R | Page No.: 12 |
| Engineer: Yuliu | |
| Site: AC5 | Time: 2023/05/25 - 20:23 |
| Limit: FCC_Part15.209_RE(3m) | Margin: 0 |
| Probe: Horn_3117_00167055(1-18GHz) | Polarity: Vertical |
| EUT: Charge Base | Power: 120 Vac / 60 Hz |
| Note: Mode 2 : Transmit at 2402MHz by 2DH5 | |

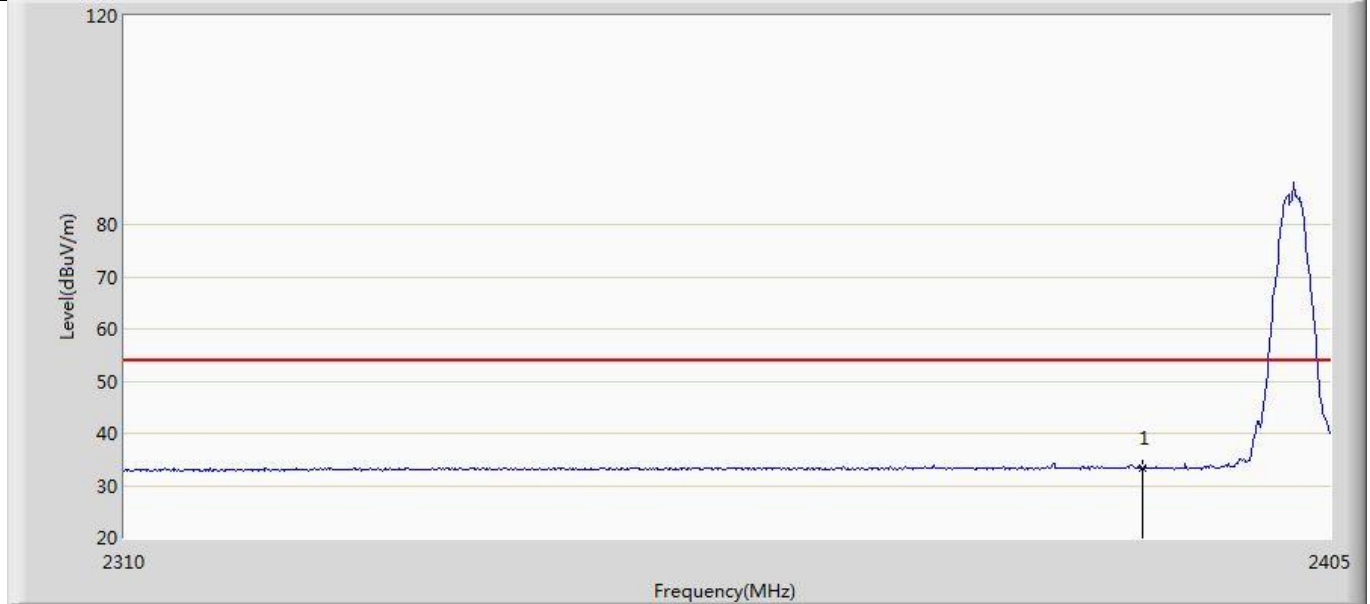

| No | Mark | Frequency (MHz) | Measure Level (dBuV/m) | Reading Level (dBuV) | Over Limit (dB) | Limit (dBuV/m) | Factor (dB) | Type |
|----|------|-----------------|------------------------|----------------------|-----------------|----------------|-------------|------|
| 1 | * | 2390.000 | 33.347 | -0.737 | -20.653 | 54.000 | 34.084 | AV |

| | |
|--|--------------------------|
| Profile: 2350171R | Page No.: 13 |
| Engineer: Yuliu | |
| Site: AC5 | Time: 2023/05/25 - 20:24 |
| Limit: FCC_Part15.209_RE(3m) | Margin: 0 |
| Probe: Horn_3117_00167055(1-18GHz) | Polarity: Horizontal |
| EUT: Charge Base | Power: 120 Vac / 60 Hz |
| Note: Mode 2 : Transmit at 2480MHz by 2DH5 | |

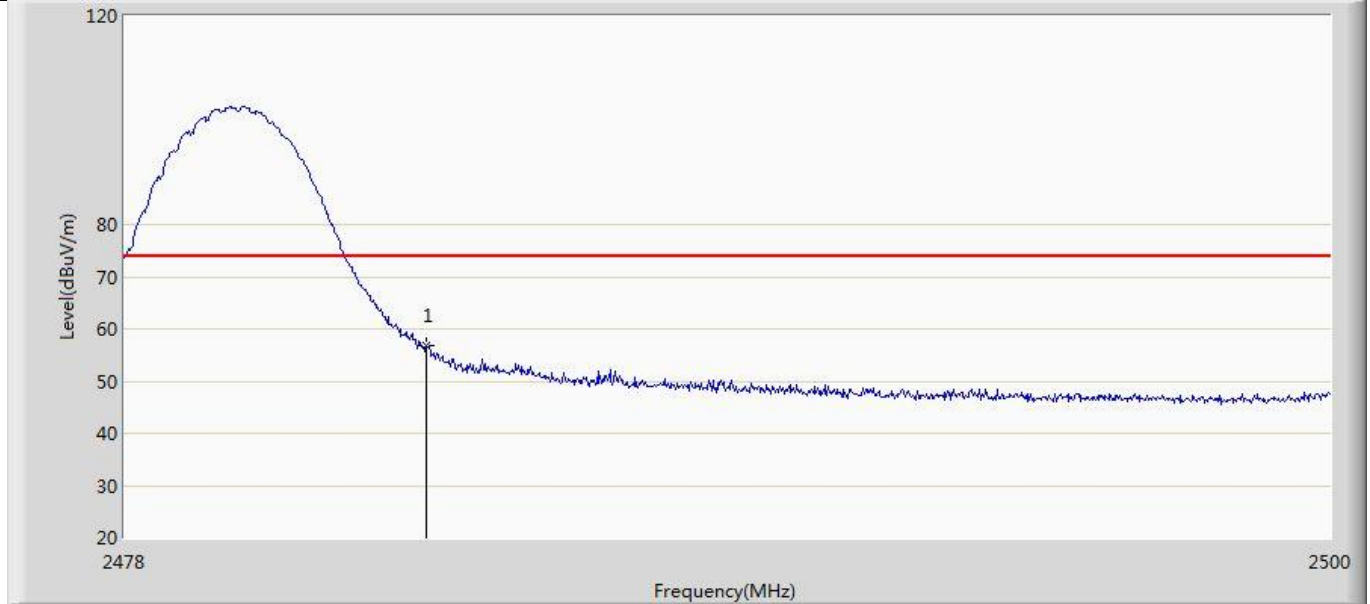

| No | Mark | Frequency (MHz) | Measure Level (dBuV/m) | Reading Level (dBuV) | Over Limit (dB) | Limit (dBuV/m) | Factor (dB) | Type |
|----|------|-----------------|------------------------|----------------------|-----------------|----------------|-------------|------|
| 1 | * | 2483.500 | 56.869 | 22.378 | -17.131 | 74.000 | 34.491 | PK |

| | |
|--|--------------------------|
| Profile: 2350171R | Page No.: 14 |
| Engineer: Yuliu | |
| Site: AC5 | Time: 2023/05/25 - 20:25 |
| Limit: FCC_Part15.209_RE(3m) | Margin: 0 |
| Probe: Horn_3117_00167055(1-18GHz) | Polarity: Horizontal |
| EUT: Charge Base | Power: 120 Vac / 60 Hz |
| Note: Mode 2 : Transmit at 2480MHz by 2DH5 | |

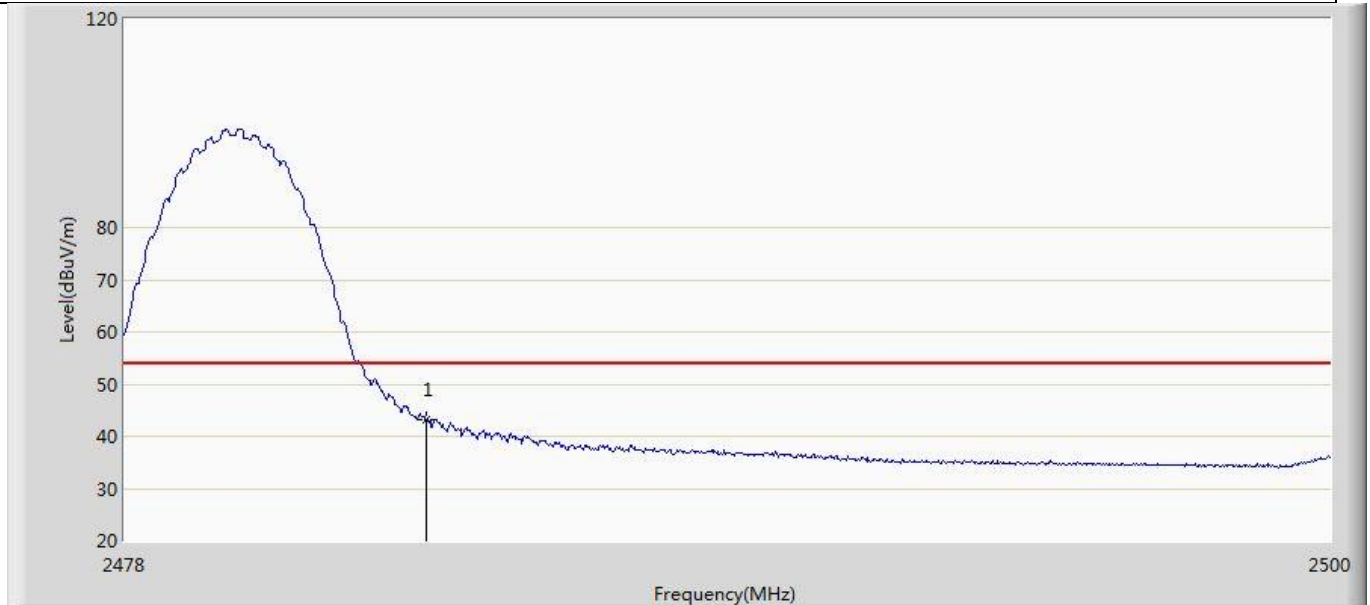

| No | Mark | Frequency (MHz) | Measure Level (dBuV/m) | Reading Level (dBuV) | Over Limit (dB) | Limit (dBuV/m) | Factor (dB) | Type |
|----|------|-----------------|------------------------|----------------------|-----------------|----------------|-------------|------|
| 1 | * | 2483.500 | 43.303 | 8.812 | -10.697 | 54.000 | 34.491 | AV |

| | |
|--|--------------------------|
| Profile: 2350171R | Page No.: 15 |
| Engineer: Yuliu | |
| Site: AC5 | Time: 2023/05/25 - 20:26 |
| Limit: FCC_Part15.209_RE(3m) | Margin: 0 |
| Probe: Horn_3117_00167055(1-18GHz) | Polarity: Vertical |
| EUT: Charge Base | Power: 120 Vac / 60 Hz |
| Note: Mode 2 : Transmit at 2480MHz by 2DH5 | |

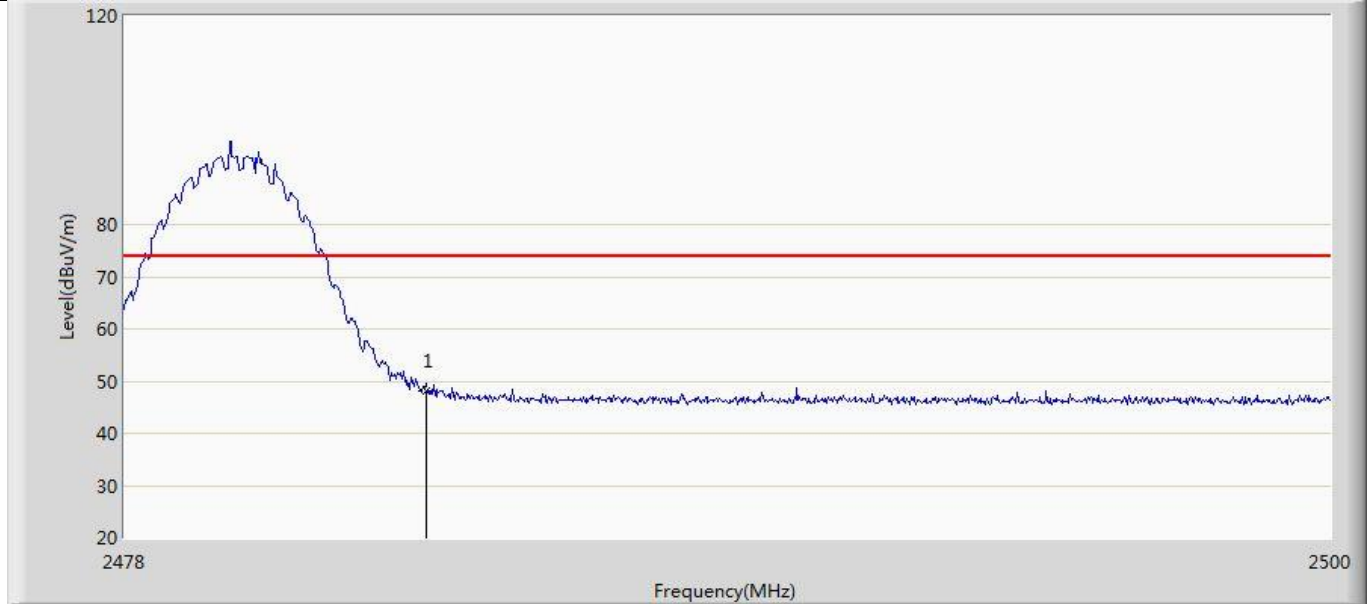

| No | Mark | Frequency (MHz) | Measure Level (dBuV/m) | Reading Level (dBuV) | Over Limit (dB) | Limit (dBuV/m) | Factor (dB) | Type |
|----|------|-----------------|------------------------|----------------------|-----------------|----------------|-------------|------|
| 1 | * | 2483.500 | 48.117 | 13.626 | -25.883 | 74.000 | 34.491 | PK |

| | |
|--|--------------------------|
| Profile: 2350171R | Page No.: 16 |
| Engineer: Yuliu | |
| Site: AC5 | Time: 2023/05/25 - 20:27 |
| Limit: FCC_Part15.209_RE(3m) | Margin: 0 |
| Probe: Horn_3117_00167055(1-18GHz) | Polarity: Vertical |
| EUT: Charge Base | Power: 120 Vac / 60 Hz |
| Note: Mode 2 : Transmit at 2480MHz by 2DH5 | |

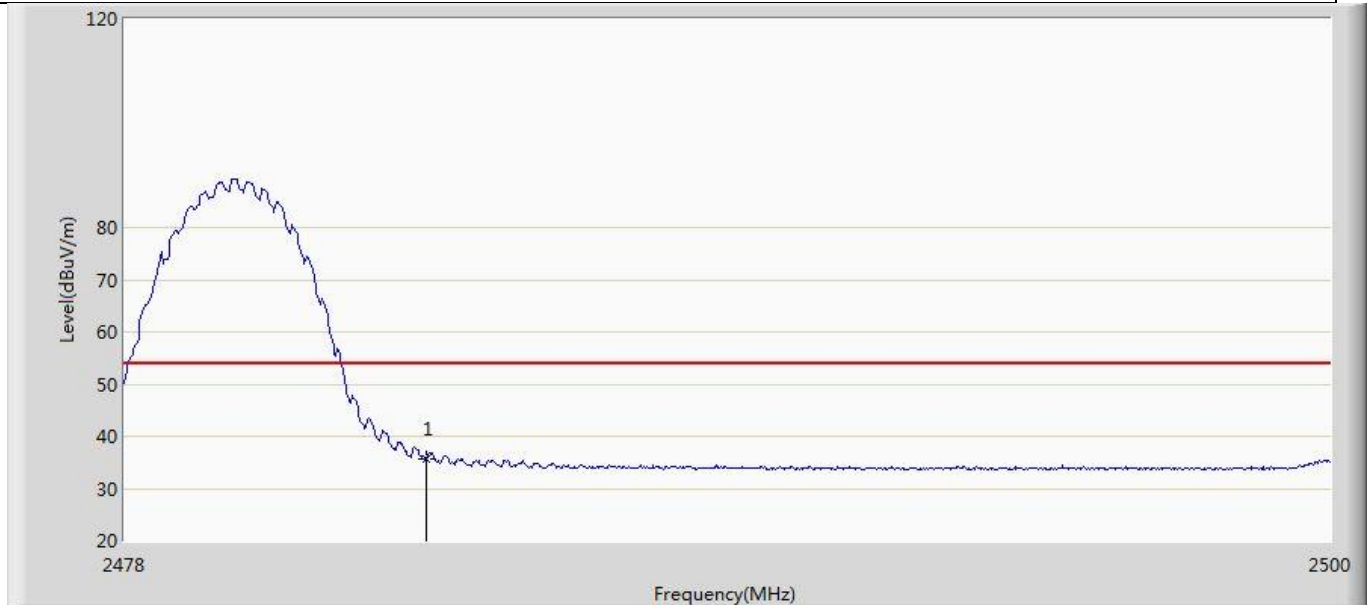

| No | Mark | Frequency (MHz) | Measure Level (dBuV/m) | Reading Level (dBuV) | Over Limit (dB) | Limit (dBuV/m) | Factor (dB) | Type |
|----|------|-----------------|------------------------|----------------------|-----------------|----------------|-------------|------|
| 1 | * | 2483.500 | 35.717 | 1.226 | -18.283 | 54.000 | 34.491 | AV |

| | |
|--|--------------------------|
| Profile: 2350171R | Page No.: 17 |
| Engineer: Yuliu | |
| Site: AC5 | Time: 2023/05/26 - 00:27 |
| Limit: FCC_Part15.209_RE(3m) | Margin: 0 |
| Probe: Horn_3117_00167055(1-18GHz) | Polarity: Horizontal |
| EUT: Charge Base | Power: 120 Vac / 60 Hz |
| Note: Mode 3 : Transmit at 2402MHz by 3DH5 | |

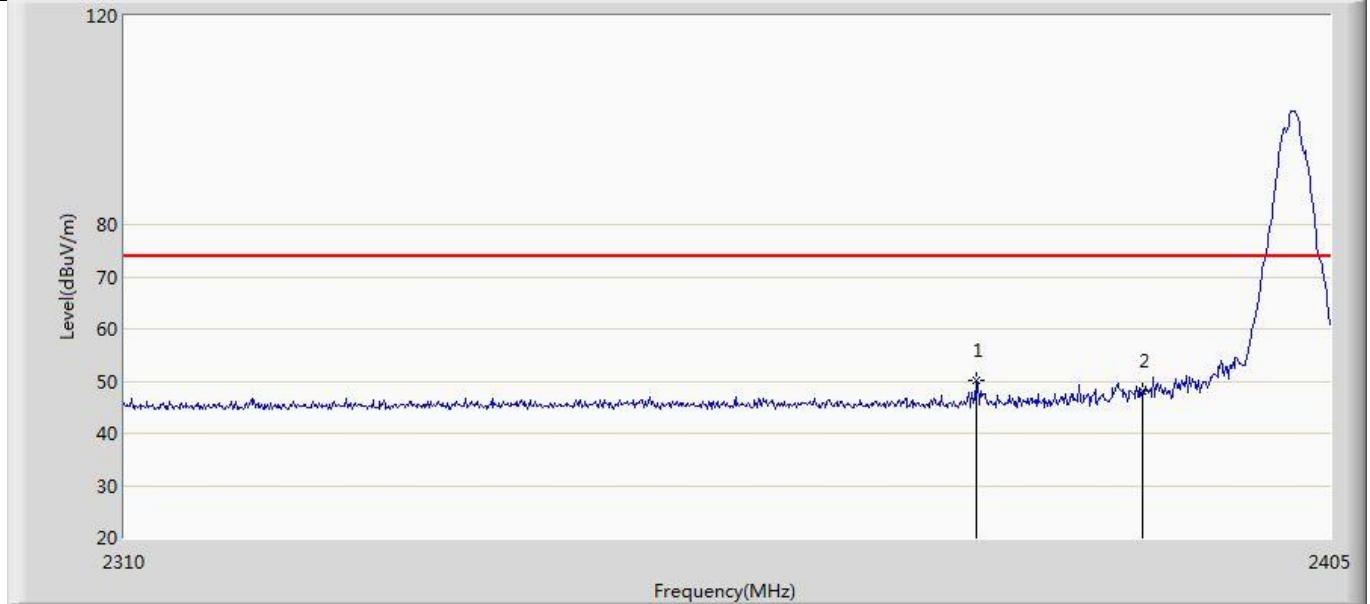

| No | Mark | Frequency (MHz) | Measure Level (dBuV/m) | Reading Level (dBuV) | Over Limit (dB) | Limit (dBuV/m) | Factor (dB) | Type |
|----|------|-----------------|------------------------|----------------------|-----------------|----------------|-------------|------|
| 1 | * | 2376.785 | 50.083 | 16.054 | -23.917 | 74.000 | 34.029 | PK |
| 2 | | 2390.000 | 48.002 | 13.918 | -25.998 | 74.000 | 34.084 | PK |

| | |
|--|--------------------------|
| Profile: 2350171R | Page No.: 18 |
| Engineer: Yuliu | |
| Site: AC5 | Time: 2023/05/26 - 00:29 |
| Limit: FCC_Part15.209_RE(3m) | Margin: 0 |
| Probe: Horn_3117_00167055(1-18GHz) | Polarity: Horizontal |
| EUT: Charge Base | Power: 120 Vac / 60 Hz |
| Note: Mode 3 : Transmit at 2402MHz by 3DH5 | |

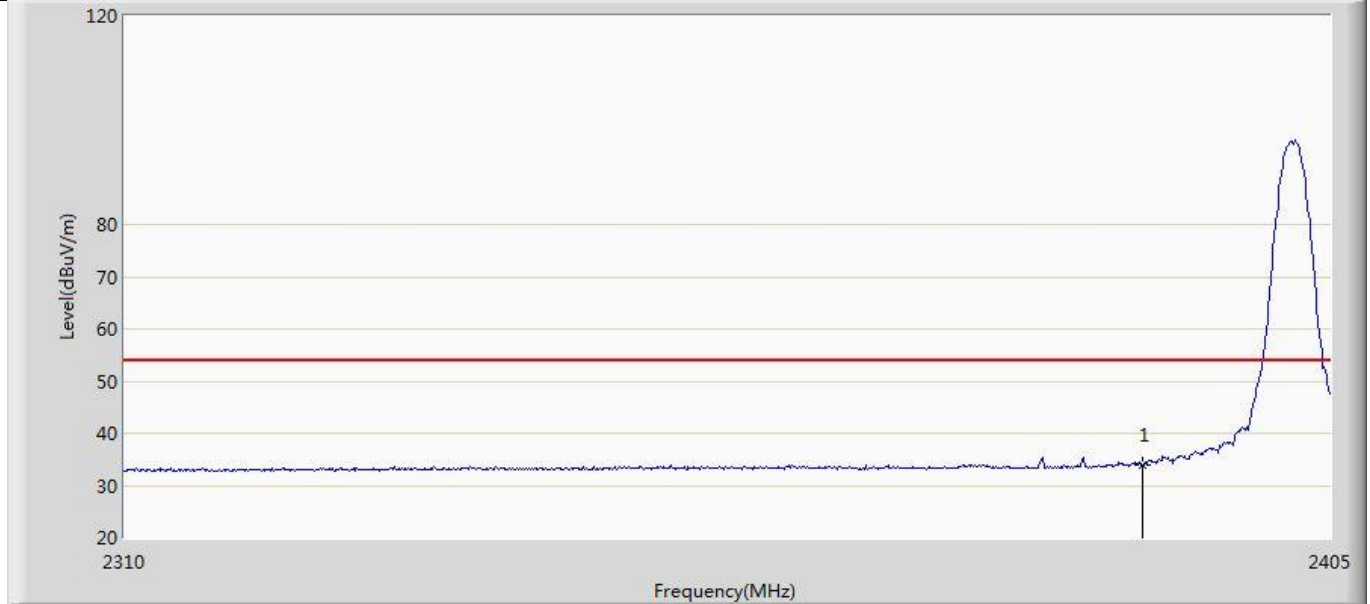

| No | Mark | Frequency (MHz) | Measure Level (dBuV/m) | Reading Level (dBuV) | Over Limit (dB) | Limit (dBuV/m) | Factor (dB) | Type |
|----|------|-----------------|------------------------|----------------------|-----------------|----------------|-------------|------|
| 1 | * | 2390.000 | 33.901 | -0.183 | -20.099 | 54.000 | 34.084 | AV |

| | |
|--|--------------------------|
| Profile: 2350171R | Page No.: 19 |
| Engineer: Yuliu | |
| Site: AC5 | Time: 2023/05/26 - 00:30 |
| Limit: FCC_Part15.209_RE(3m) | Margin: 0 |
| Probe: Horn_3117_00167055(1-18GHz) | Polarity: Vertical |
| EUT: Charge Base | Power: 120 Vac / 60 Hz |
| Note: Mode 3 : Transmit at 2402MHz by 3DH5 | |

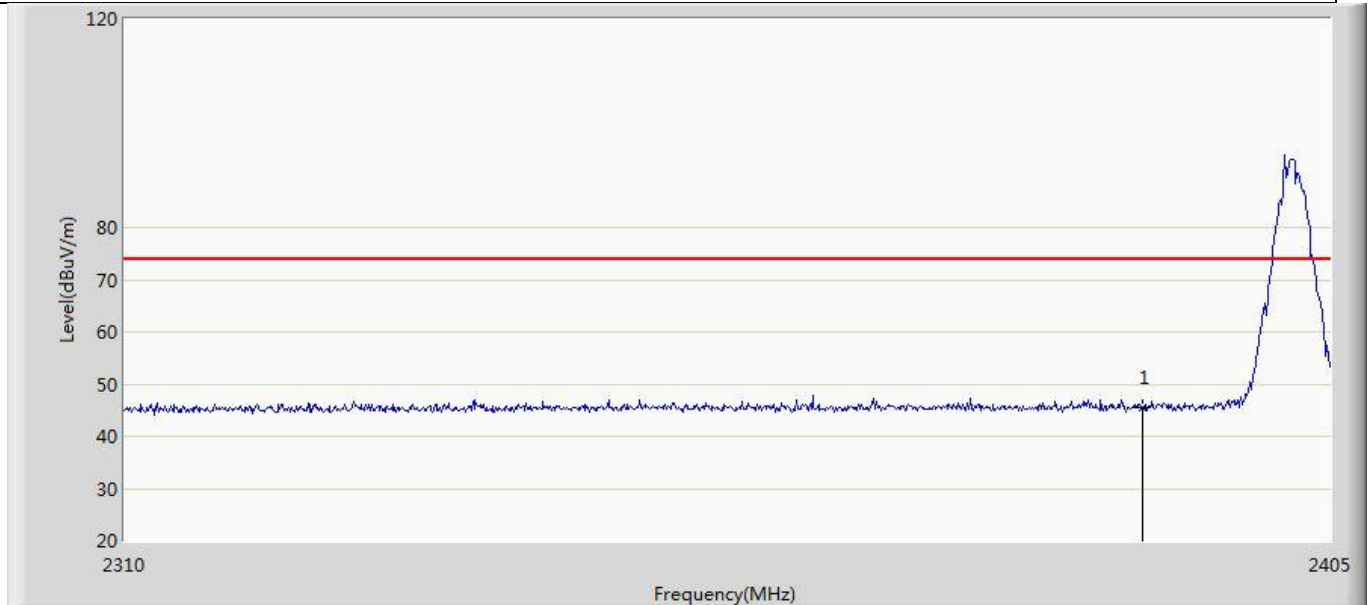

| No | Mark | Frequency (MHz) | Measure Level (dBuV/m) | Reading Level (dBuV) | Over Limit (dB) | Limit (dBuV/m) | Factor (dB) | Type |
|----|------|-----------------|------------------------|----------------------|-----------------|----------------|-------------|------|
| 1 | * | 2390.000 | 45.599 | 11.515 | -28.401 | 74.000 | 34.084 | PK |

| | |
|--|--------------------------|
| Profile: 2350171R | Page No.: 20 |
| Engineer: Yuliu | |
| Site: AC5 | Time: 2023/05/26 - 00:31 |
| Limit: FCC_Part15.209_RE(3m) | Margin: 0 |
| Probe: Horn_3117_00167055(1-18GHz) | Polarity: Vertical |
| EUT: Charge Base | Power: 120 Vac / 60 Hz |
| Note: Mode 3 : Transmit at 2402MHz by 3DH5 | |

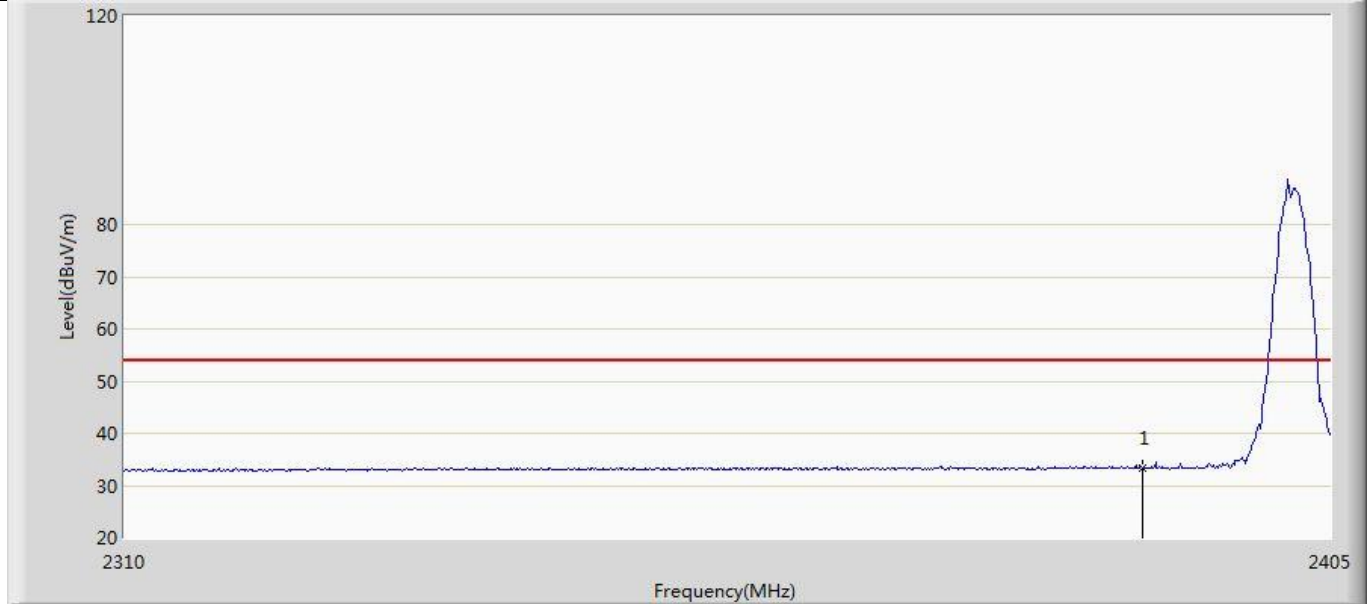

| No | Mark | Frequency (MHz) | Measure Level (dBuV/m) | Reading Level (dBuV) | Over Limit (dB) | Limit (dBuV/m) | Factor (dB) | Type |
|----|------|-----------------|------------------------|----------------------|-----------------|----------------|-------------|------|
| 1 | * | 2390.000 | 33.282 | -0.802 | -20.718 | 54.000 | 34.084 | AV |

| | |
|--|--------------------------|
| Profile: 2350171R | Page No.: 21 |
| Engineer: Yuliu | |
| Site: AC5 | Time: 2023/05/26 - 00:32 |
| Limit: FCC_Part15.209_RE(3m) | Margin: 0 |
| Probe: Horn_3117_00167055(1-18GHz) | Polarity: Horizontal |
| EUT: Charge Base | Power: 120 Vac / 60 Hz |
| Note: Mode 3 : Transmit at 2480MHz by 3DH5 | |

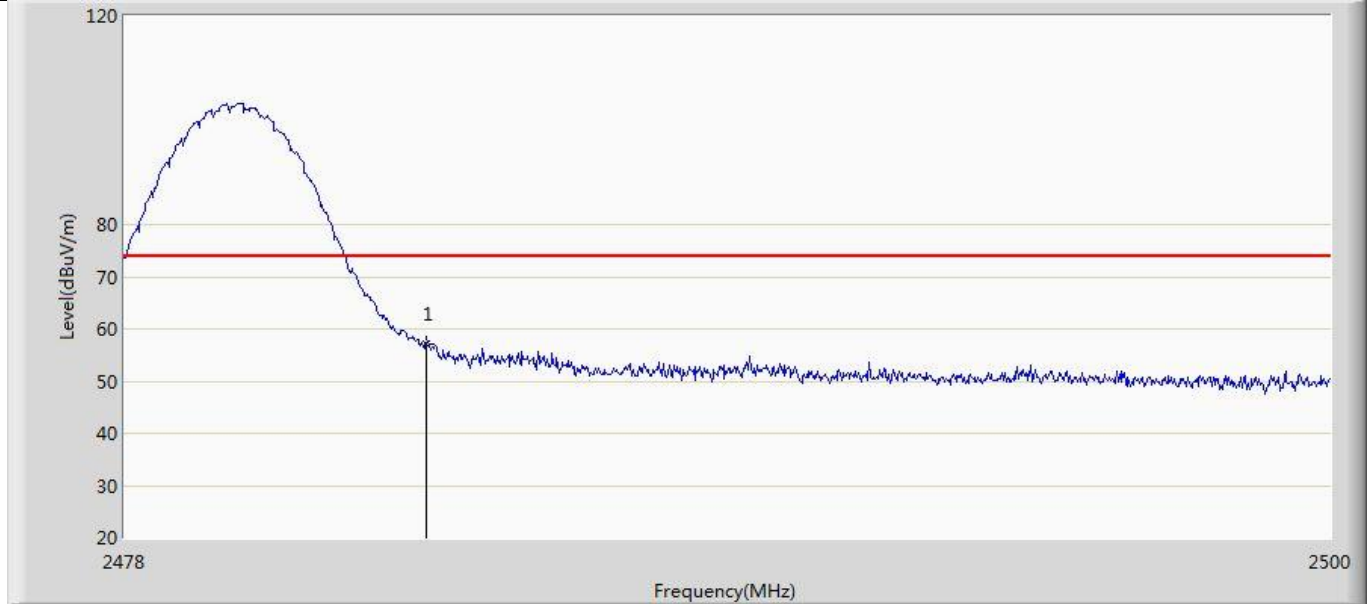

| No | Mark | Frequency (MHz) | Measure Level (dBuV/m) | Reading Level (dBuV) | Over Limit (dB) | Limit (dBuV/m) | Factor (dB) | Type |
|----|------|-----------------|------------------------|----------------------|-----------------|----------------|-------------|------|
| 1 | * | 2483.500 | 57.233 | 22.742 | -16.767 | 74.000 | 34.491 | PK |

| | |
|--|--------------------------|
| Profile: 2350171R | Page No.: 22 |
| Engineer: Yuliu | |
| Site: AC5 | Time: 2023/05/26 - 00:34 |
| Limit: FCC_Part15.209_RE(3m) | Margin: 0 |
| Probe: Horn_3117_00167055(1-18GHz) | Polarity: Horizontal |
| EUT: Charge Base | Power: 120 Vac / 60 Hz |
| Note: Mode 3 : Transmit at 2480MHz by 3DH5 | |

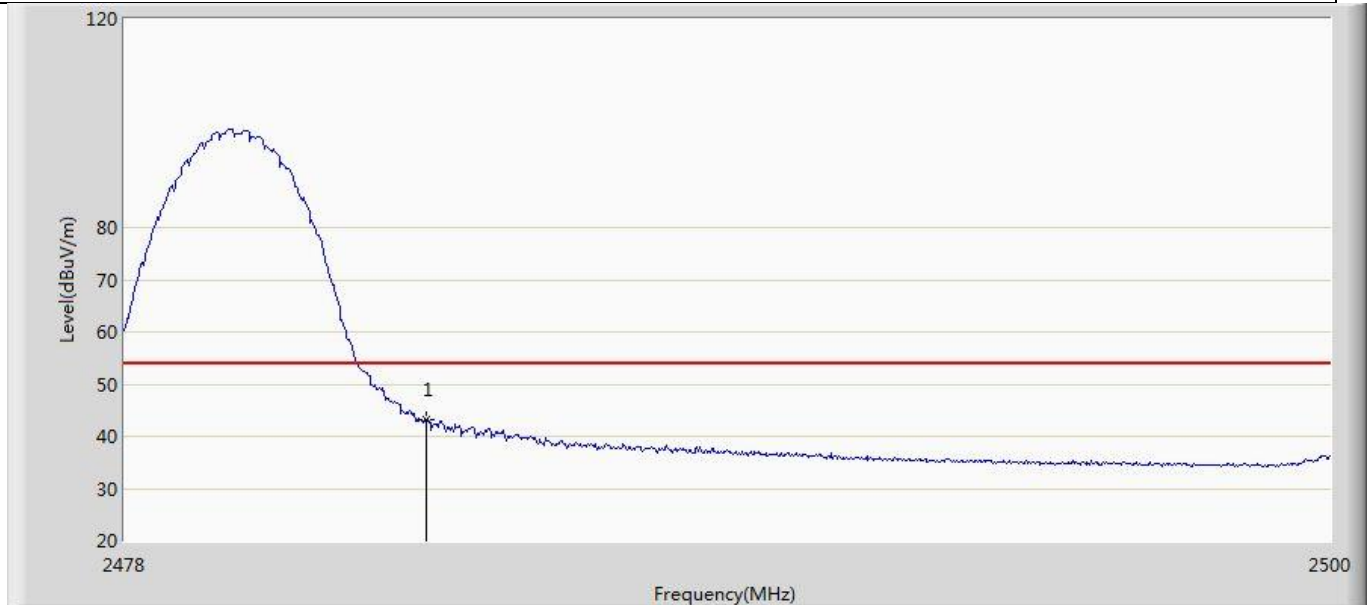

| No | Mark | Frequency (MHz) | Measure Level (dBuV/m) | Reading Level (dBuV) | Over Limit (dB) | Limit (dBuV/m) | Factor (dB) | Type |
|----|------|-----------------|------------------------|----------------------|-----------------|----------------|-------------|------|
| 1 | * | 2483.500 | 43.257 | 8.766 | -10.743 | 54.000 | 34.491 | AV |

| | |
|--|--------------------------|
| Profile: 2350171R | Page No.: 23 |
| Engineer: Yuliu | |
| Site: AC5 | Time: 2023/05/26 - 00:36 |
| Limit: FCC_Part15.209_RE(3m) | Margin: 0 |
| Probe: Horn_3117_00167055(1-18GHz) | Polarity: Vertical |
| EUT: Charge Base | Power: 120 Vac / 60 Hz |
| Note: Mode 3 : Transmit at 2480MHz by 3DH5 | |

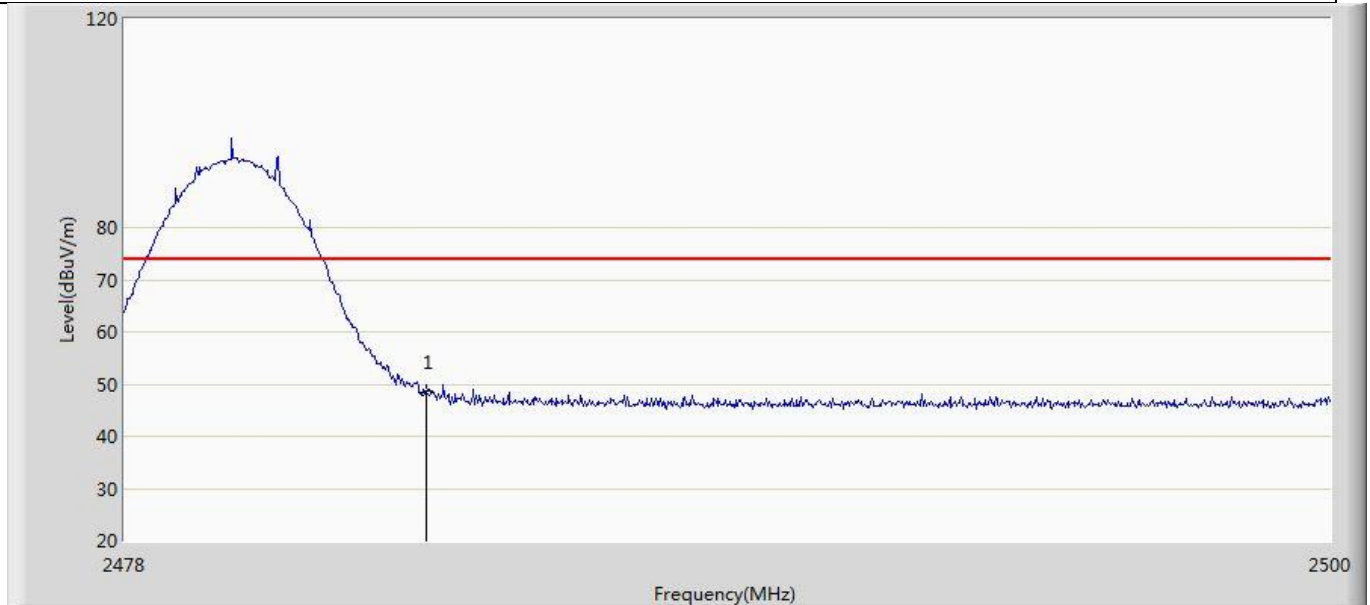

| No | Mark | Frequency (MHz) | Measure Level (dBuV/m) | Reading Level (dBuV) | Over Limit (dB) | Limit (dBuV/m) | Factor (dB) | Type |
|----|------|-----------------|------------------------|----------------------|-----------------|----------------|-------------|------|
| 1 | * | 2483.500 | 48.381 | 13.890 | -25.619 | 74.000 | 34.491 | PK |

| | |
|--|--------------------------|
| Profile: 2350171R | Page No.: 24 |
| Engineer: Yuliu | |
| Site: AC5 | Time: 2023/05/26 - 00:37 |
| Limit: FCC_Part15.209_RE(3m) | Margin: 0 |
| Probe: Horn_3117_00167055(1-18GHz) | Polarity: Vertical |
| EUT: Charge Base | Power: 120 Vac / 60 Hz |
| Note: Mode 3 : Transmit at 2480MHz by 3DH5 | |

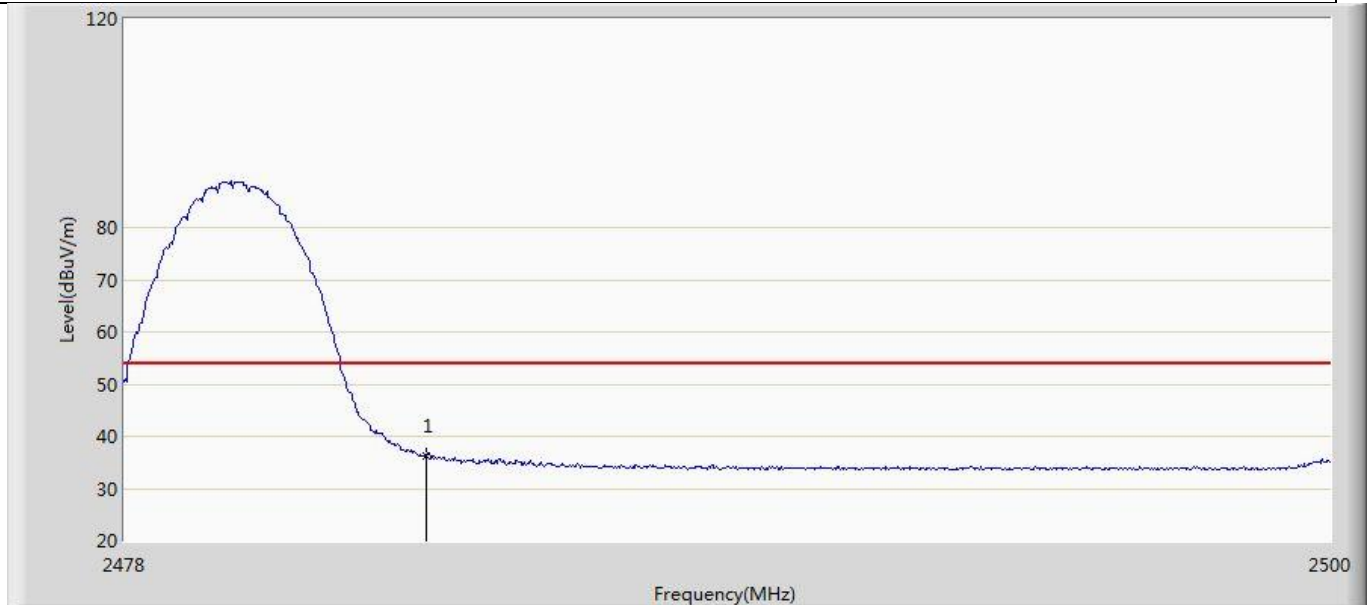

| No | Mark | Frequency (MHz) | Measure Level (dBuV/m) | Reading Level (dBuV) | Over Limit (dB) | Limit (dBuV/m) | Factor (dB) | Type |
|----|------|-----------------|------------------------|----------------------|-----------------|----------------|-------------|------|
| 1 | * | 2483.500 | 36.321 | 1.830 | -17.679 | 54.000 | 34.491 | AV |

Appendix H: Conducted Spurious Emission

Test Result for Reference level :

| TestMode | Freq(MHz) | Max.Point[MHz] | Result[dBm] |
|----------|-----------|----------------|-------------|
| DH5 | 2402 | 2402.07 | 4.62 |
| | 2441 | 2441.06 | 4.61 |
| | 2480 | 2480.06 | 3.93 |
| 2DH5 | 2402 | 2402.04 | 3.32 |
| | 2441 | 2441.05 | 3.49 |
| | 2480 | 2480.05 | 2.69 |
| 3DH5 | 2402 | 2402.11 | 3.48 |
| | 2441 | 2441.11 | 3.57 |
| | 2480 | 2480.10 | 2.78 |

Test Result for Band edge :

| TestMode | ChName | Frequency[MHz] | RefLevel [dBm] | Result [dBm] | Limit [dBm] | Verdict |
|----------|--------|----------------|----------------|--------------|-------------|---------|
| DH5 | Low | 2402 | 4.62 | -52.18 | ≤-25.38 | PASS |
| | High | 2480 | 3.93 | -53.33 | ≤-26.07 | PASS |
| | Low | Hop_2402 | 5.28 | -52.95 | ≤-24.72 | PASS |
| | High | Hop_2480 | 3.22 | -52.89 | ≤-26.78 | PASS |
| 2DH5 | Low | 2402 | 3.32 | -46.41 | ≤-26.68 | PASS |
| | High | 2480 | 2.69 | -50.32 | ≤-27.31 | PASS |
| | Low | Hop_2402 | 2.90 | -52.37 | ≤-27.1 | PASS |
| | High | Hop_2480 | 0.57 | -52.22 | ≤-29.43 | PASS |
| 3DH5 | Low | 2402 | 3.48 | -45.77 | ≤-26.52 | PASS |
| | High | 2480 | 2.78 | -52.99 | ≤-27.22 | PASS |
| | Low | Hop_2402 | 0.58 | -52.89 | ≤-29.42 | PASS |
| | High | Hop_2480 | 3.96 | -52.41 | ≤-26.04 | PASS |

Test Result for Spurious Emission :

| TestMode | Frequency[MHz] | FreqRange [MHz] | RefLevel [dBm] | Result [dBm] | Limit [dBm] | Verdict |
|-------------|----------------|-----------------|----------------|--------------|-------------|---------|
| DH5 | 2402 | 30~1000 | 4.62 | -69.15 | ≤-25.38 | PASS |
| | | 1000~3000 | 4.62 | -64.3 | ≤-25.38 | PASS |
| | | 3000~5000 | 4.62 | -48.36 | ≤-25.38 | PASS |
| | | 5000~7000 | 4.62 | -67.33 | ≤-25.38 | PASS |
| | | 7000~9000 | 4.62 | -52.14 | ≤-25.38 | PASS |
| | | 9000~11000 | 4.62 | -65.75 | ≤-25.38 | PASS |
| | | 11000~13000 | 4.62 | -52.75 | ≤-25.38 | PASS |
| | | 13000~15000 | 4.62 | -65.04 | ≤-25.38 | PASS |
| | | 15000~17000 | 4.62 | -54.12 | ≤-25.38 | PASS |
| | | 17000~19000 | 4.62 | -62.48 | ≤-25.38 | PASS |
| | | 19000~21000 | 4.62 | -54.42 | ≤-25.38 | PASS |
| | | 21000~23000 | 4.62 | -53.58 | ≤-25.38 | PASS |
| 23000~25000 | 4.62 | -58.32 | ≤-25.38 | PASS | | |

| | | | | | | |
|-------------|-------------|-------------|---------|---------|---------|------|
| | 2441 | 30~1000 | 4.61 | -68.88 | ≤-25.39 | PASS |
| | | 1000~3000 | 4.61 | -64.52 | ≤-25.39 | PASS |
| | | 3000~5000 | 4.61 | -48.45 | ≤-25.39 | PASS |
| | | 5000~7000 | 4.61 | -67.71 | ≤-25.39 | PASS |
| | | 7000~9000 | 4.61 | -53.67 | ≤-25.39 | PASS |
| | | 9000~11000 | 4.61 | -63.96 | ≤-25.39 | PASS |
| | | 11000~13000 | 4.61 | -52.69 | ≤-25.39 | PASS |
| | | 13000~15000 | 4.61 | -61.93 | ≤-25.39 | PASS |
| | | 15000~17000 | 4.61 | -63.52 | ≤-25.39 | PASS |
| | | 17000~19000 | 4.61 | -51.51 | ≤-25.39 | PASS |
| | | 19000~21000 | 4.61 | -53.29 | ≤-25.39 | PASS |
| | | 21000~23000 | 4.61 | -55.16 | ≤-25.39 | PASS |
| | 23000~25000 | 4.61 | -59.07 | ≤-25.39 | PASS | |
| | 2480 | 30~1000 | 3.93 | -68.02 | ≤-26.07 | PASS |
| | | 1000~3000 | 3.93 | -64.14 | ≤-26.07 | PASS |
| | | 3000~5000 | 3.93 | -48.19 | ≤-26.07 | PASS |
| | | 5000~7000 | 3.93 | -67.88 | ≤-26.07 | PASS |
| | | 7000~9000 | 3.93 | -56.97 | ≤-26.07 | PASS |
| | | 9000~11000 | 3.93 | -66.84 | ≤-26.07 | PASS |
| | | 11000~13000 | 3.93 | -52.92 | ≤-26.07 | PASS |
| | | 13000~15000 | 3.93 | -61.19 | ≤-26.07 | PASS |
| | | 15000~17000 | 3.93 | -64.46 | ≤-26.07 | PASS |
| | | 17000~19000 | 3.93 | -54.88 | ≤-26.07 | PASS |
| | | 19000~21000 | 3.93 | -56.76 | ≤-26.07 | PASS |
| 21000~23000 | | 3.93 | -53.44 | ≤-26.07 | PASS | |
| 23000~25000 | 3.93 | -58.37 | ≤-26.07 | PASS | | |
| 2DH5 | 2402 | 30~1000 | 3.32 | -67.73 | ≤-26.68 | PASS |
| | | 1000~3000 | 3.32 | -63.82 | ≤-26.68 | PASS |
| | | 3000~5000 | 3.32 | -41.24 | ≤-26.68 | PASS |
| | | 5000~7000 | 3.32 | -67.29 | ≤-26.68 | PASS |
| | | 7000~9000 | 3.32 | -55.7 | ≤-26.68 | PASS |
| | | 9000~11000 | 3.32 | -58.47 | ≤-26.68 | PASS |
| | | 11000~13000 | 3.32 | -62.02 | ≤-26.68 | PASS |
| | | 13000~15000 | 3.32 | -63.47 | ≤-26.68 | PASS |
| | | 15000~17000 | 3.32 | -63.38 | ≤-26.68 | PASS |
| | | 17000~19000 | 3.32 | -62.27 | ≤-26.68 | PASS |
| | | 19000~21000 | 3.32 | -53.49 | ≤-26.68 | PASS |
| | | 21000~23000 | 3.32 | -60.18 | ≤-26.68 | PASS |
| | 23000~25000 | 3.32 | -58.53 | ≤-26.68 | PASS | |
| | 2441 | 30~1000 | 3.49 | -61.74 | ≤-26.51 | PASS |
| | | 1000~3000 | 3.49 | -63.45 | ≤-26.51 | PASS |
| | | 3000~5000 | 3.49 | -39.79 | ≤-26.51 | PASS |
| | | 5000~7000 | 3.49 | -61.99 | ≤-26.51 | PASS |
| | | 7000~9000 | 3.49 | -58.85 | ≤-26.51 | PASS |
| | | 9000~11000 | 3.49 | -57.79 | ≤-26.51 | PASS |
| | | 11000~13000 | 3.49 | -61.98 | ≤-26.51 | PASS |
| | | 13000~15000 | 3.49 | -58.33 | ≤-26.51 | PASS |
| | | 15000~17000 | 3.49 | -63.46 | ≤-26.51 | PASS |
| | | 17000~19000 | 3.49 | -62.52 | ≤-26.51 | PASS |
| | | 19000~21000 | 3.49 | -53.15 | ≤-26.51 | PASS |
| 21000~23000 | | 3.49 | -61.5 | ≤-26.51 | PASS | |

| | | | | | | |
|-------------|-------------|-------------|--------|---------|---------|------|
| | 2480 | 23000~25000 | 3.49 | -58.84 | ≤-26.51 | PASS |
| | | 30~1000 | 2.69 | -60 | ≤-27.31 | PASS |
| | | 1000~3000 | 2.69 | -64.32 | ≤-27.31 | PASS |
| | | 3000~5000 | 2.69 | -40.13 | ≤-27.31 | PASS |
| | | 5000~7000 | 2.69 | -62.13 | ≤-27.31 | PASS |
| | | 7000~9000 | 2.69 | -59.28 | ≤-27.31 | PASS |
| | | 9000~11000 | 2.69 | -64.31 | ≤-27.31 | PASS |
| | | 11000~13000 | 2.69 | -60.49 | ≤-27.31 | PASS |
| | | 13000~15000 | 2.69 | -57.89 | ≤-27.31 | PASS |
| | | 15000~17000 | 2.69 | -63.87 | ≤-27.31 | PASS |
| | | 17000~19000 | 2.69 | -58.21 | ≤-27.31 | PASS |
| | | 19000~21000 | 2.69 | -53.48 | ≤-27.31 | PASS |
| | | 21000~23000 | 2.69 | -60.14 | ≤-27.31 | PASS |
| | | 23000~25000 | 2.69 | -58.27 | ≤-27.31 | PASS |
| 3DH5 | 2402 | 30~1000 | 3.48 | -67.26 | ≤-26.52 | PASS |
| | | 1000~3000 | 3.48 | -59.63 | ≤-26.52 | PASS |
| | | 3000~5000 | 3.48 | -39.47 | ≤-26.52 | PASS |
| | | 5000~7000 | 3.48 | -67.5 | ≤-26.52 | PASS |
| | | 7000~9000 | 3.48 | -55.62 | ≤-26.52 | PASS |
| | | 9000~11000 | 3.48 | -60.87 | ≤-26.52 | PASS |
| | | 11000~13000 | 3.48 | -64.42 | ≤-26.52 | PASS |
| | | 13000~15000 | 3.48 | -63.04 | ≤-26.52 | PASS |
| | | 15000~17000 | 3.48 | -63.87 | ≤-26.52 | PASS |
| | | 17000~19000 | 3.48 | -62.09 | ≤-26.52 | PASS |
| | | 19000~21000 | 3.48 | -54.04 | ≤-26.52 | PASS |
| | | 21000~23000 | 3.48 | -59.67 | ≤-26.52 | PASS |
| | | 23000~25000 | 3.48 | -59.02 | ≤-26.52 | PASS |
| | 2441 | 30~1000 | 3.57 | -62.29 | ≤-26.43 | PASS |
| | | 1000~3000 | 3.57 | -61.1 | ≤-26.43 | PASS |
| | | 3000~5000 | 3.57 | -41.2 | ≤-26.43 | PASS |
| | | 5000~7000 | 3.57 | -63.2 | ≤-26.43 | PASS |
| | | 7000~9000 | 3.57 | -58.35 | ≤-26.43 | PASS |
| | | 9000~11000 | 3.57 | -60.21 | ≤-26.43 | PASS |
| | | 11000~13000 | 3.57 | -62.73 | ≤-26.43 | PASS |
| | | 13000~15000 | 3.57 | -60.23 | ≤-26.43 | PASS |
| | | 15000~17000 | 3.57 | -63.45 | ≤-26.43 | PASS |
| | | 17000~19000 | 3.57 | -62.34 | ≤-26.43 | PASS |
| | | 19000~21000 | 3.57 | -54.24 | ≤-26.43 | PASS |
| | | 21000~23000 | 3.57 | -61.59 | ≤-26.43 | PASS |
| | 23000~25000 | 3.57 | -58.89 | ≤-26.43 | PASS | |
| | 2480 | 30~1000 | 2.78 | -59.44 | ≤-27.22 | PASS |
| | | 1000~3000 | 2.78 | -57.53 | ≤-27.22 | PASS |
| | | 3000~5000 | 2.78 | -38.94 | ≤-27.22 | PASS |
| | | 5000~7000 | 2.78 | -63.03 | ≤-27.22 | PASS |
| 7000~9000 | | 2.78 | -60.29 | ≤-27.22 | PASS | |
| 9000~11000 | | 2.78 | -65.74 | ≤-27.22 | PASS | |
| 11000~13000 | | 2.78 | -63.23 | ≤-27.22 | PASS | |
| 13000~15000 | | 2.78 | -59.01 | ≤-27.22 | PASS | |
| 15000~17000 | | 2.78 | -63.05 | ≤-27.22 | PASS | |
| 17000~19000 | | 2.78 | -58.47 | ≤-27.22 | PASS | |
| 19000~21000 | | 2.78 | -56.16 | ≤-27.22 | PASS | |

| | | | | | | |
|--|--|-------------|------|--------|---------|------|
| | | 21000~23000 | 2.78 | -61.33 | ≤-27.22 | PASS |
| | | 23000~25000 | 2.78 | -58.73 | ≤-27.22 | PASS |

Test Graphs for Reference level :

DH5_Ant1_2402



DH5_Ant1_2441



DH5_Ant1_2480



2DH5_Ant1_2402



2DH5_Ant1_2441



2DH5_Ant1_2480



3DH5_Ant1_2402

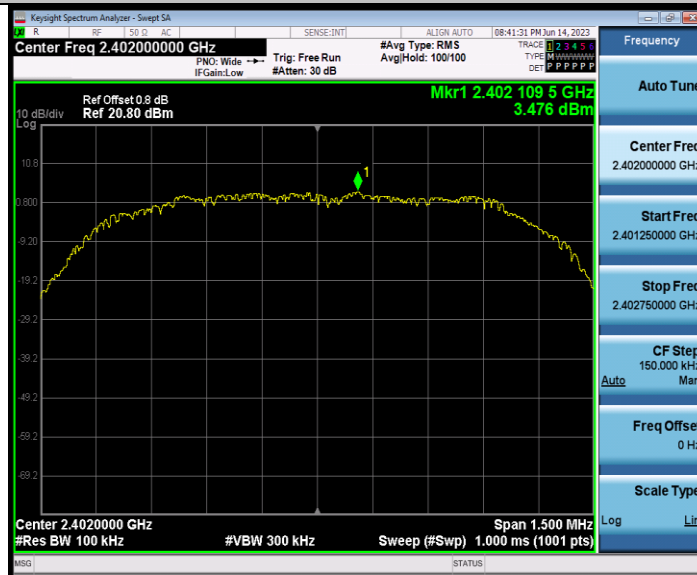

3DH5_Ant1_2441



3DH5_Ant1_2480

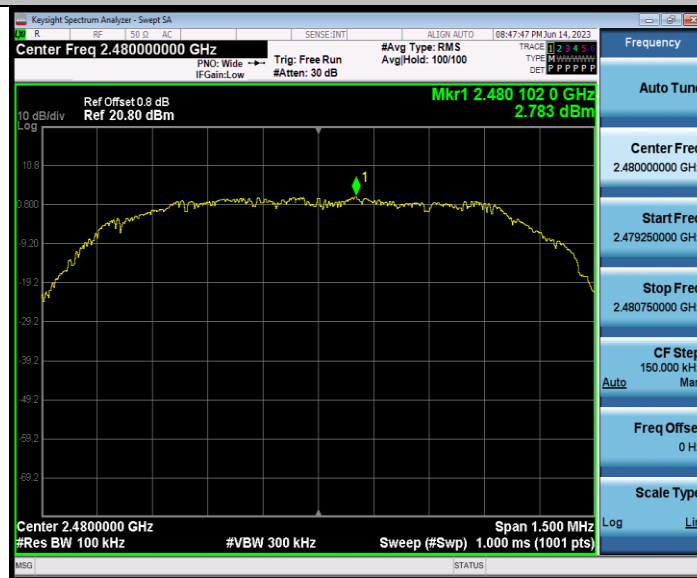

Test Graphs for Band edge :

DH5_Ant1_Low_2402

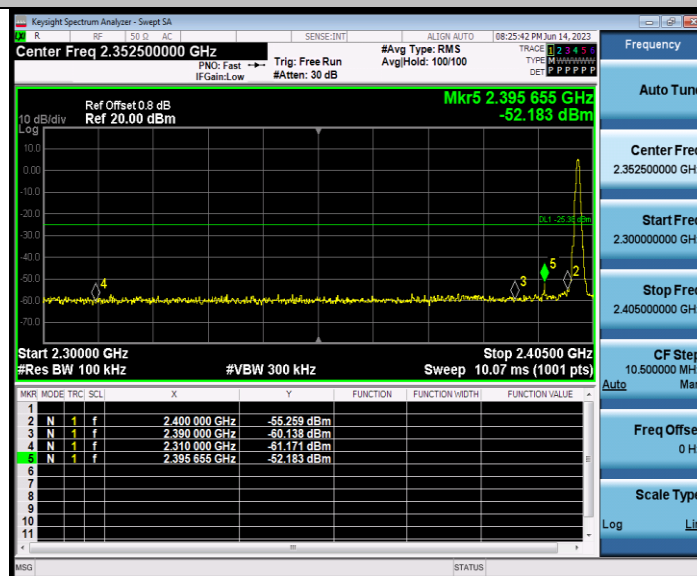

DH5_Ant1_High_2480

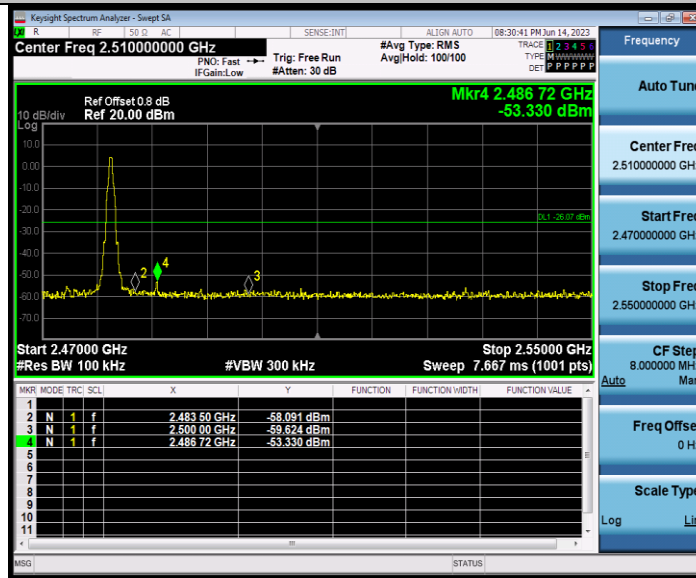

DH5_Ant1_Low_Hop_2402

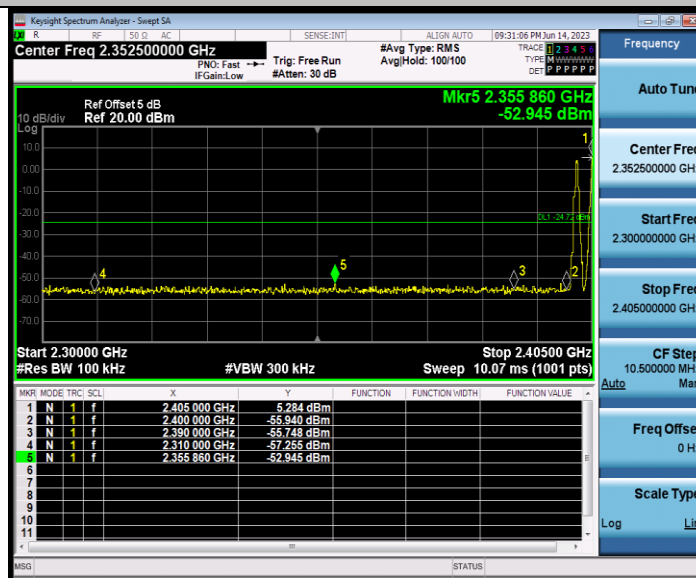

DH5_Ant1_High_Hop_2480

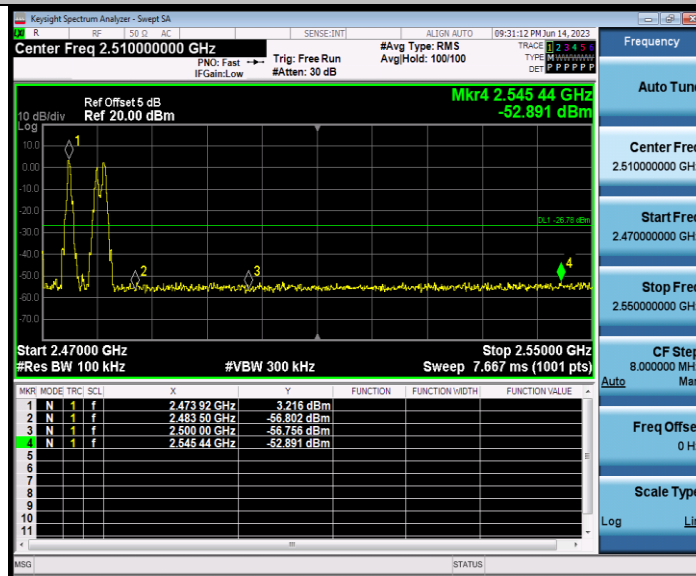

2DH5_Ant1_Low_2402

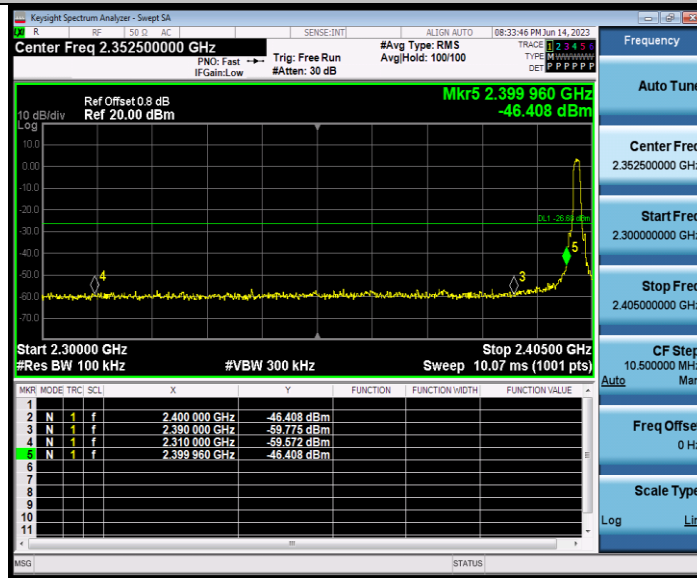

2DH5_Ant1_High_2480

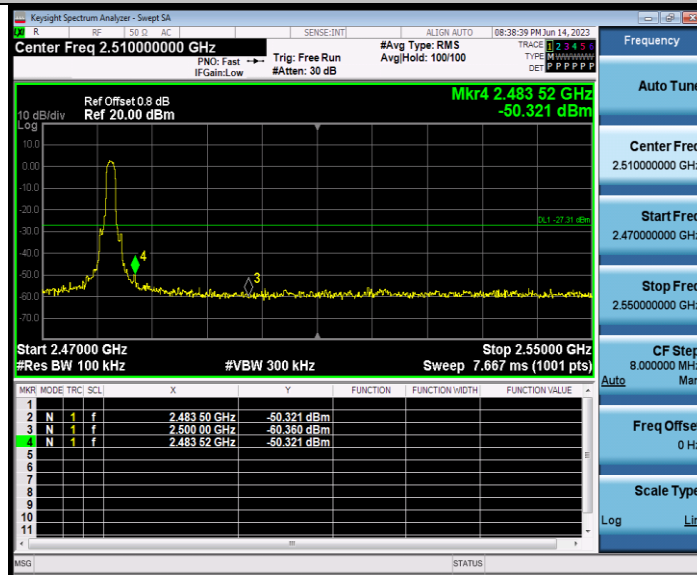

2DH5_Ant1_Low_Hop_2402

