



Test report No:
2340773R-RF-US-P06V02

FCC & ISED TEST REPORT

Product Name	Barcode Scanner
Trademark	Honeywell
Model and /or type reference	1962
FCC ID	HD5-1962A
IC	1693B-1962A
Applicant's name / address	HONEYWELL INTERNATIONAL INC Honeywell Safety and Productivity Solutions 9680 OLD BAILES RD FORT MILL SC 29707-7539,USA
Test method requested, standard	CFR 47, FCC Part 15 C ANSI C63.10: 2013 RSS-Gen / RSS-247
Verdict Summary	IN COMPLIANCE
Documented by (name / position & signature)	Jun Xu/ Project Engineer 
Approved by (name / position & signature)	Jack Zhang/ Manager 
Date of issue	2023-06-05
Report Version	V1.0
Report template No	Template_FCC Part 15C-RF-V1.0

INDEX

	page
General conditions	5
Environmental conditions	5
Possible test case verdicts	6
Abbreviations.....	6
Document History.....	7
Remarks and Comments	7
Used Equipment.....	8
Uncertainty	10
1 General Information	11
1.1 General Description of the Item(s).....	11
1.2 Antenna Information	12
1.3 Channel List.....	13
2 Description of Test Setup.....	14
2.1 Operating mode(s) used for tests	14
2.2 Auxiliary equipment / Test software for the EUT	14
2.3 Test Configuration / Block diagram used for tests.....	15
2.4 Testing process	16
3 Verdict summary section.....	17
3.1 Standards	17
3.2 Deviation(s) from the Standard(s) / Test Specification(s).....	17
3.3 Overview of results	18
3.4 Power setting in test	20
3.5 Test Matrix	20
3.6 Test Facility.....	21
4 Test Items Of Limit/Setup/Procedure.....	22
4.1 DTS Bandwidth.....	22
4.1.1 Limit	22
4.1.2 Test Setup	22
4.1.3 Test Procedure	22
4.2 Occupied Channel Bandwidth	23
4.2.1 Limit	23
4.2.2 Test Setup	23
4.2.3 Test Procedure	23
4.3 Maximum Conducted Output Power.....	24

4.3.1	Limit	24
4.3.2	Test Setup	24
4.3.3	Test Procedure	25
4.4	Maximum Power Spectral Density.....	26
4.4.1	Limit	26
4.4.2	Test Setup	26
4.4.3	Test Procedure	26
4.5	Band Edge Measurements	27
4.5.1	Limit	27
4.5.2	Test Setup	27
4.5.3	Test Procedure	27
4.6	Conducted Spurious Emission	28
4.6.1	Limit	28
4.6.2	Test Setup	28
4.6.3	Test Procedure	28
4.7	Duty cycle	29
4.7.1	Limit	29
4.7.2	Test Setup	29
4.7.3	Test Procedure	29
4.8	Emissions in Restricted Bands	30
4.8.1	Limit	30
4.8.2	Test Setup	32
4.8.3	Test Procedure	33
4.9	AC Power Line Conducted Emission.....	34
4.9.1	Limit	34
4.9.2	Test Setup	34
4.9.3	Test Procedure	34
4.10	Antenna Requirement.....	35
4.10.1	Limit:	35
4.10.2	Antenna Connector Construction:	35
5	Test setup photo and EUT Photo	35
6	Test Result.....	36
	Appendix A: DTS Bandwidth.....	36
	Appendix B: Occupied Channel Bandwidth.....	38
	Appendix C: Maximum conducted output power	40
	Appendix D: Maximum power spectral density.....	41
	Appendix E: Band edge measurements	43

Appendix F: Conducted Spurious Emission	51
Appendix G: Duty Cycle.....	69
Appendix H: Emissions in Restricted Bands.....	71

COMPETENCES AND GUARANTEES

DEKRA is a testing laboratory competent to carry out the tests described in this report.

In order to assure the traceability to other national and international laboratories, DEKRA has a calibration and maintenance program for its measurement equipment.

DEKRA guarantees the reliability of the data presented in this report, which is the result of the measurements and the tests performed to the item under test on the date and under the conditions stated in the report and it is based on the knowledge and technical facilities available at DEKRA at the time of performance of the test.

DEKRA is liable to the client for the maintenance of the confidentiality of all information related to the item under test and the results of the test.

The results presented in this Test Report apply only to the particular item under test established in this document.

IMPORTANT: No parts of this report may be reproduced or quoted out of context, in any form or by any means, except in full, without the previous written permission of DEKRA.

GENERAL CONDITIONS

Test Location	No. 99, Hongye Road, Suzhou Industrial Park Suzhou, 215006, P.R. China
Date(receive sample)	Apr. 27, 2023
Date (start test)	Apr. 28, 2023
Date (finish test)	May. 29, 2023

1. This report is only referred to the item that has undergone the test.
2. This report does not constitute or imply on its own an approval of the product by the Certification Bodies or Competent Authorities.
3. This document is only valid if complete; no partial reproduction can be made without previous written permission of DEKRA.
4. This test report cannot be used partially or in full for publicity and/or promotional purposes without previous written permission of DEKRA.

ENVIRONMENTAL CONDITIONS

The climatic conditions during the tests are within the limits specified by the manufacturer for the operation of the EUT and the test equipment. The climatic conditions during the tests were within the following limits:

Ambient temperature	15 °C – 35 °C
Relative Humidity air	30% - 60%

If explicitly required in the basic standard or applied product / product family standard the climatic values are recorded and documented separately in this test report.

POSSIBLE TEST CASE VERDICTS

Test case does not apply to test object	N/A
Test object does meet requirement	P (Pass) / PASS
Test object does not meet requirement	F (Fail) / FAIL
Not measured	N/M

ABBREVIATIONS

For the purposes of the present document, the following abbreviations apply:

EUT	: Equipment Under Test
QP	: Quasi-Peak
CAV	: CISPR Average
AV	: Average
CDN	: Coupling Decoupling Network
SAC	: Semi-Anechoic Chamber
OATS	: Open Area Test Site
BW	: Bandwidth
AM	: Amplitude Modulation
PM	: Pulse Modulation
HCP	: Horizontal Coupling Plane
VCP	: Vertical Coupling Plane
U_N	: Nominal voltage
T_x	: Transmitter
R_x	: Receiver
N/A	: Not Applicable
N/M	: Not Measured

DOCUMENT HISTORY

Report No.	Version	Description	Issued Date
2340773R-RF-US-P06V02	V1.0	Initial issue of report.	2023-06-05

REMARKS AND COMMENTS

1. The equipment under test (EUT) does meet the essential requirements of the stated standard(s)/test(s).
2. These test results on a sample of the device are for the purpose of demonstrating Compliance with Part 15 Subpart C Paragraph 15.247, RSS-Gen Issue 5, RSS-247 Issue 2.
3. The measurement result is considered in conformance with the requirement if it is within the prescribed limit, It is not necessary to account the uncertainty associated with the measurement result.
4. The test results presented in this report relate only to the object tested.
5. The test report shall not be reproduced without the written approval of DEKRA Testing and Certification (Suzhou) Co., Ltd.
6. This report will not be used for social proof function in China market.
7. DEKRA declines any responsibility with the following test data provided by customer that may affect the validity of result:
 - Chapter 1.1 General Description of the Item(s);
 - Chapter 1.2 Antenna Informaion;
 - Chapter 1.3 Channel List.

USED EQUIPMENT

Conducted Test/ TR8

Instrument	Manufacturer	Model No.	Serial No.	Cal. Date	Next Cal. Date
Wireless Connectivity Tester	R&S	CMW 270	102593	2022.05.21	2023.05.20
Wireless Connectivity Tester	R&S	CMW 270	102593	2023.05.20	2024.05.19
Coaxial Cable	N/A	N/A	2189	2022.06.09	2023.06.08
High and low temperature and fast temperature change test box	ASTUOD	ASTD-FBT-225K	N/A	2022.08.24	2023.08.23
Temperature/Humidity Meter	RTS	RTS-8S	RF08	2022.07.07	2023.07.06
Test system					
4TX MIMO Power Sensor	Keysight	X8750A	MY59400102	2023.02.25	2024.02.24
MAX Signal Analyzer	Keysight	N9020B	MY59050482	2022.09.17	2023.09.16
Switch Box	Keysight	X8749A	N/A	N/A	N/A
High and low temperature and fast temperature change test box	ASTUOD	ASTD-FBT-225K	N/A	2022.08.24	2023.08.23
MXG-B RF Vector Signal Generator	Keysight	N5182B	MY61252529	2022.07.14	2023.07.13
Frequency extender for EXG or MXG	Keysight	N5182BX07	MY59362500	2022.07.14	2023.07.13
EXG-B MW Analog Signal Generator	Keysight	N5173B	MY61252566	2022.09.28	2023.09.27

Radiated Emission(9KHz-1GHz) / AC3

Instrument	Manufacturer	Model No.	Serial No.	Cal. Date	Next Cal. Date
EMI Test Receiver	R&S	ESCI	100573	2022.07.10	2023.07.09
Bilog Antenna	Teseq GmbH	CBL6112D	27611	2022.08.28	2023.08.27
Coaxial Cable	Huber+Suhner	RG 214	AC2-C	2023.03.15	2024.03.14
Loop Antenna	R&S	HFH2-Z2	833799/003	2023.02.25	2024.02.24
Temperature/Humidity Meter	RTS	RTS-8S	AC2-TH	2022.07.07	2023.07.06

Radiated Emission (1GHz-40GHz) / AC5

Instrument	Manufacturer	Model No.	Serial No.	Cal. Date	Next Cal. Date
MXA Signal Analyzer	Keysight	N9020B	MY60112218	2022.12.08	2023.12.07
Preamplifier	Chengyi	EMC184045SE	980263	2022.07.19	2023.07.18
DRG Horn	ETS-Lindgren	3117	00123988	2022.08.29	2023.08.28
Broad-Band Horn Antenna	SCHWARZBECK	BBHA 9170	01249	2022.09.22	2023.09.21
Coaxial Cable	ROSENBERGER	LA1-C011-2000/3000	AC5-40G	2023.03.04	2024.03.03

UNCERTAINTY

Uncertainties have been calculated according to the DEKRA internal document. The reported expanded uncertainties are based on a standard uncertainty multiplied by a coverage factor of $k=2$, providing a level of confidence of approximately 95% .

Test item	Uncertainty
AC Power Line Conducted Emission	9kHz~150kHz: 2.80dB 150kHz~30MHz: 2.40dB
Peak Power Output	± 1.27 dB
Radiated Emission(30MHz~1GHz)	Horizontal: 30MHz~200MHz: 3.50 dB 300MHz~1GHz: 3.60 dB Vertical: 30MHz~200MHz: 3.60 dB 300MHz~1GHz: 3.50 dB
Radiated Emission(1GHz~26.5GHz)	Horizontal: 1GHz~18GHz: 5.00 dB Vertical: 1GHz~18GHz: 4.80 dB Horizontal: 18GHz~26.5GHz: 5.30 dB Vertical: 18GHz~26.5GHz: 4.90 dB
RF antenna conducted test	± 1.27 dB
Radiated Emission Band Edge	± 3.9 dB
DTS Bandwidth	± 150 Hz
Occupied Bandwidth	± 1 kHz
Power Density	± 1.27 dB

1 GENERAL INFORMATION

1.1 General Description of the Item(s)

Product Name	Barcode Scanner
Model No.	1962
Trademark.	Honeywell
FCC ID	HD5-1962A
IC	1693B-1962A
Hardware Version	1962 ver01
Software Version	1962 ver02
Manufacturer	HONEYWELL INTERNATIONAL INC Honeywell Safety and Productivity Solutions
Manufacturer Address	9680 OLD BAILES RD FORT MILL SC 29707-7539,USA
Factory	Metro(Suzhou)Technologies Co.,Ltd
Factory address.....	No.221 Xinghai street China-Singapore Suzhou Industrial Park

Wireless specification.....	Bluetooth (LE)					
Operating frequency range(s)	2402~2480MHz					
Type of Modulation.....	GFSK					
PHYs	<input checked="" type="checkbox"/>	LE 1M	<input type="checkbox"/>	LE 2M	<input type="checkbox"/>	LE Coded S=2/8
Data Rate	<input checked="" type="checkbox"/>	1Mbit/s	<input type="checkbox"/>	2Mbit/s	<input type="checkbox"/>	500/125 Kbit/s
Number of channel.....	40					

Rated power supply	Voltage and Frequency					
	<input type="checkbox"/>	AC: 220 - 240 V, 50/60 Hz				
	<input type="checkbox"/>	AC: 100 - 240 V, 50/60 Hz				
	<input type="checkbox"/>	DC: 24 Vdc				
	<input checked="" type="checkbox"/>	Battery:3.635V				
	<input type="checkbox"/>	Adapter:				
Mounting position	<input type="checkbox"/>	Tabletop equipment				
	<input type="checkbox"/>	Wall/Ceiling mounted equipment				
	<input type="checkbox"/>	Floor standing equipment				
	<input checked="" type="checkbox"/>	Hand-held/Portable equipment				
	<input type="checkbox"/>	Other:				

1.2 Antenna Information

Antenna model / type number	N/A		
Antenna serial number	N/A		
Antenna Delivery	<input checked="" type="checkbox"/>	1TX + 1RX	
	<input type="checkbox"/>	2TX + 2RX	
	<input type="checkbox"/>	Others:	
Antenna technology	<input checked="" type="checkbox"/>	SISO	
	<input type="checkbox"/>	MIMO	<input type="checkbox"/> CDD
			<input type="checkbox"/> Beam-forming
Antenna Type	<input type="checkbox"/>	External	<input type="checkbox"/> Dipole
			<input type="checkbox"/> Sectorized
			<input type="checkbox"/> Ceramic Chip
	<input checked="" type="checkbox"/>	Internal	<input type="checkbox"/> PIFA
			<input checked="" type="checkbox"/> Chip Antenna
			<input type="checkbox"/> Others.....
Antenna Gain	2.90dBi		

1.3 Channel List

Bluetooth Working Frequency of Each Channel: (For LE)							
Channel	Frequency	Channel	Frequency	Channel	Frequency	Channel	Frequency
00	2402 MHz	01	2404 MHz	02	2406 MHz	03	2408 MHz
04	2410 MHz	05	2412 MHz	06	2414 MHz	07	2416 MHz
08	2418 MHz	09	2420 MHz	10	2422 MHz	11	2424 MHz
12	2426 MHz	13	2428 MHz	14	2430 MHz	15	2432 MHz
16	2434 MHz	17	2436 MHz	18	2438 MHz	19	2440 MHz
20	2442 MHz	21	2444 MHz	22	2446 MHz	23	2448 MHz
24	2450 MHz	25	2452 MHz	26	2454 MHz	27	2456 MHz
28	2458 MHz	29	2460 MHz	30	2462 MHz	31	2464 MHz
32	2466 MHz	33	2468 MHz	34	2470 MHz	35	2472 MHz
36	2474 MHz	37	2476 MHz	38	2478 MHz	39	2480 MHz

Note: The General Description of the Item , antenna information and Channel List for the EUT in clause 1 are provided and confirmed by the client.

2 DESCRIPTION OF TEST SETUP

2.1 Operating mode(s) used for tests

During the tests the following operating mode(s) has(have) been used.

Test Mode For Bluetooth	Mode 1: Transmit by LE_1Mbps
-------------------------	------------------------------

Note 1: Regards to the frequency band operation: the lowest, middle and highest frequency channel were selected to perform the test, then shown on this report.

Note 2: For portable device, radiated tests was verified over X, Y, Z axis, and shown the worst case on this report.

2.2 Auxiliary equipment / Test software for the EUT

Auxiliary equipment	Type / Version	Manufacturer	Supplied by
(1) CMA 270	N/A	R&S	230Vac
(2) USB Control Cable	N/A	N/A	N/A
(3) USB Control Cable	N/A	N/A	N/A
software	Type / Version	Manufacturer	Supplied by
N/A	N/A	N/A	N/A

Accessories Information	Cable		
	Length used during test [m]	Attached during test	Shielded
(2)USB Control Cable	1	<input checked="" type="checkbox"/>	<input checked="" type="checkbox"/>
(3)USB Control Cable	8	<input checked="" type="checkbox"/>	<input checked="" type="checkbox"/>

2.3 Test Configuration / Block diagram used for tests

Test setup Diagram- Conducted test

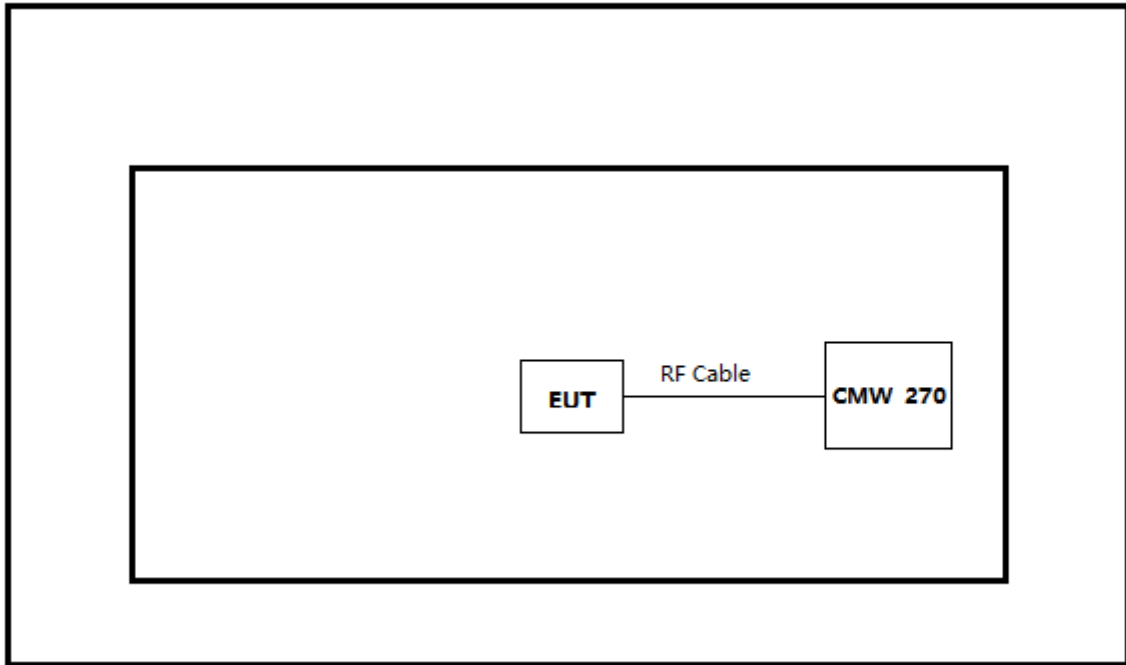

Test setup Diagram- Radiated test

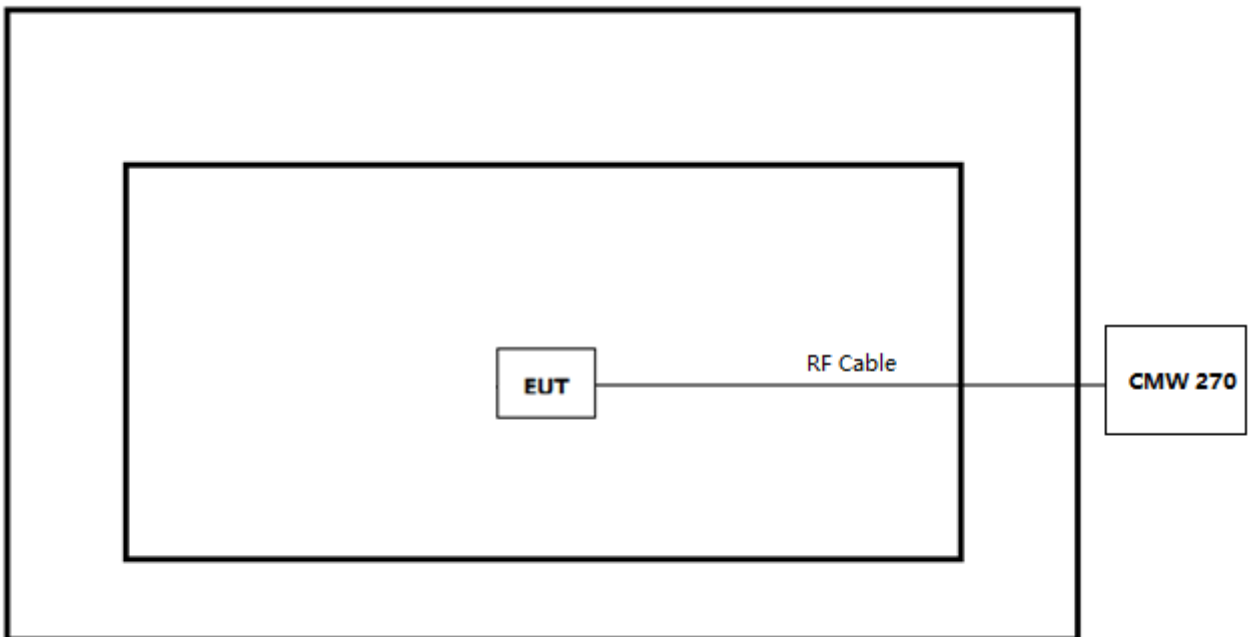

2.4 Testing process

1	Setup the EUT shown in Section 2.3.
2	Configure the test mode, the test channel, and the data rate.
3	Verify that the EUT works properly.

3 VERDICT SUMMARY SECTION

This chapter presents an overview of standards and results. Refer to the next chapters for details of measured test results and applied test levels.

3.1 Standards

Standard	Year	Description
CFR 47, FCC Part 15 C	2023	Operation within the bands 902–928 MHz, 2400–2483.5 MHz, and 5725–5850 MHz.
ANSI C63.10	2013	American National Standard of Procedures for Compliance Testing of Unlicensed Wireless Devices
RSS-Gen Issue 5 Amendment 1	2019	General Requirements for Compliance of Radio Apparatus
RSS-247 Issue 2	2017	Digital Transmission Systems (DTSs), Frequency Hopping Systems (FHSs) and Licence-Exempt Local Area Network (LE-LAN) Devices

3.2 Deviation(s) from the Standard(s) / Test Specification(s)

The following deviation(s) was / were made from the published requirements of the listed standards: N/A.

(Please define the deviations from the standard(s) if applicable)

3.3 Overview of results

Requirement – Test Item of FCC	Standard(s)	Verdict	Remark
20dB Emission Bandwidth	FCC 15.247(a)(2)	PASS	Test data please refer to Appendix A
Maximum conducted output power	15.247 (b)(3)	PASS	Test data please refer to Appendix C
Maximum power spectral density	FCC 15.247(e)	PASS	Test data please refer to Appendix D
Band edge measurements	FCC 15.247(d) FCC 15.205 FCC 15.209	PASS	Test data please refer to Appendix E
Conducted Spurious Emission	FCC 15.247(d), FCC 15.209	PASS	Test data please refer to Appendix F
Duty cycle	ANSI C63.10:2013	PASS	Test data please refer to Appendix G
Emissions in Restricted Bands	FCC 15.205 FCC 15.209	PASS	Test data please refer to Appendix H
AC Power Line Conducted Emission	FCC 15.207	N/A	Not applicable, EUT is battery operated.
Antenna Requirement	FCC 15.203	PASS	---

Requirement – Test case of ISED	Standard(s)	Verdict	Remark
DTS Bandwidth	RSS-Gen Issue 5 Paragraph 6.7 RSS-247 Issue 2 Paragraph 5.2	PASS	Test data please refer to Appendix A
Occupied Channel Bandwidth	RSS-Gen Issue 5 Paragraph 6.7 RSS-247 Issue 2 Paragraph 5.2	PASS	Test data please refer to Appendix B
Maximum conducted output power	RSS-247 Issue 2 Paragraph 5.4(d)	PASS	Test data please refer to Appendix C
Maximum power spectral density	RSS-247 Issue 2 Paragraph 5.2(b)	PASS	Test data please refer to Appendix D
Band edge measurements	RSS-Gen Issue 5 Paragraph 8.10	PASS	Test data please refer to Appendix E
Conducted Spurious Emission	RSS-247 Issue 2 Paragraph 5.5	PASS	Test data please refer to Appendix F
Duty cycle	ANSI C63.10:2013	PASS	Test data please refer to Appendix G
Emissions in Restricted Bands	RSS-Gen Issue 5 Paragraph 8.9	PASS	Test data please refer to Appendix H
AC Power Line Conducted Emission	RSS-Gen Issue 5 Paragraph 8.8	N/A	Not applicable, EUT is battery operated.
Antenna Requirement	RSS-Gen Issue 5 Paragraph 6.8	PASS	---

3.4 Power setting in test

Mode	Channel	Frequency (MHz)	Power setting
LE_1Mbps	00	2402	40
	19	2440	40
	39	2480	40

3.5 Test Matrix

Test item	1962	
	1(#1)	2(#2)
DTS Bandwidth	<input checked="" type="checkbox"/>	<input type="checkbox"/>
Occupied Channel Bandwidth	<input checked="" type="checkbox"/>	<input type="checkbox"/>
Maximum conducted output power	<input checked="" type="checkbox"/>	<input type="checkbox"/>
Maximum power spectral density	<input checked="" type="checkbox"/>	<input type="checkbox"/>
Band edge measurements	<input type="checkbox"/>	<input checked="" type="checkbox"/>
Conducted Spurious Emission	<input checked="" type="checkbox"/>	<input type="checkbox"/>
Duty cycle	<input checked="" type="checkbox"/>	<input type="checkbox"/>
Emissions in Restricted Bands	<input type="checkbox"/>	<input checked="" type="checkbox"/>

3.6 Test Facility

USA	:	FCC Designation Number: CN1199
CA	:	ISED CAB identifier: CN0040

4 TEST ITEMS OF LIMIT/SETUP/PROCEDURE

4.1 DTS Bandwidth

VERDICT: PASS

4.1.1 Limit

Standard

FCC Part 15 Subpart C Paragraph 15.247 (a)(2); RSS-247 Issue 2 Paragraph 5.2.

Systems using digital modulation techniques operate in the 2400-2483.5 MHz. The minimum 6 dB bandwidth shall be at least 500 kHz

4.1.2 Test Setup

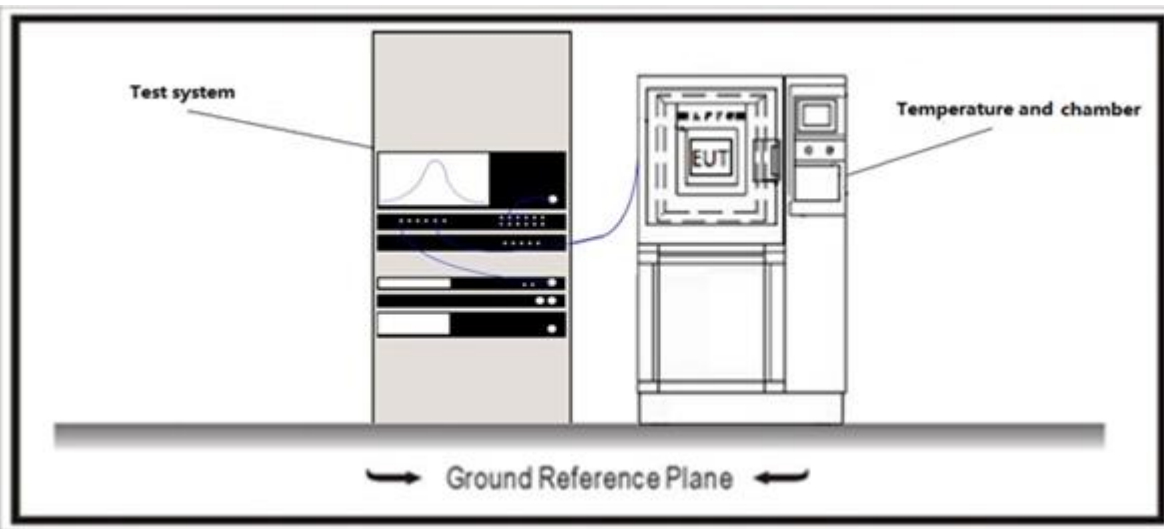

4.1.3 Test Procedure

	Reference Rule	Chapter	Description
<input checked="" type="checkbox"/>	ANSI C63.10	11.8	DTS bandwidth
<input type="checkbox"/>	ANSI C63.10	11.8.1	Option 1
<input checked="" type="checkbox"/>	ANSI C63.10	11.8.2	Option 2

4.2 Occupied Channel Bandwidth	VERDICT: PASS
---------------------------------------	----------------------

4.2.1 Limit

Standard	RSS-Gen Issue 5 Paragraph 6.7
-----------------	-------------------------------

The occupied bandwidth or the “99% emission bandwidth” is defined as the frequency range between two points, one above and the other below the carrier frequency, within which 99% of the total transmitted power of the fundamental transmitted emission is contained. The occupied bandwidth shall be reported for all equipment in addition to the specified bandwidth required in the applicable RSSs

4.2.2 Test Setup

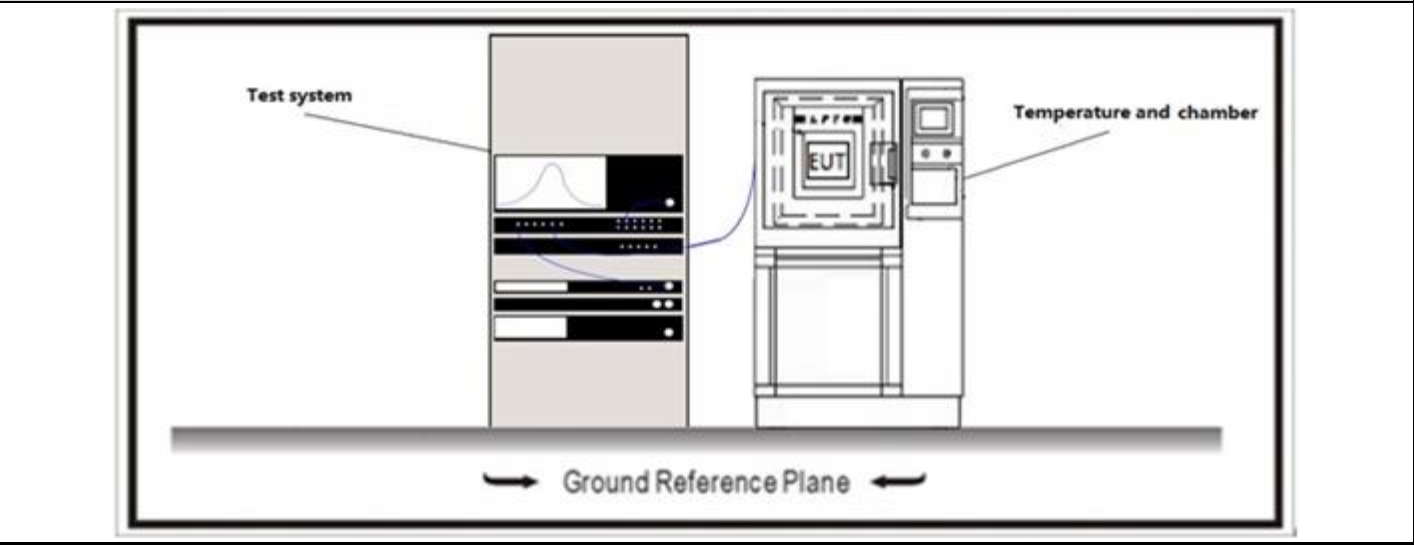

4.2.3 Test Procedure

	Reference Rule	Chapter	Description
<input checked="" type="checkbox"/>	ANSI C63.10	11.8	DTS bandwidth
<input type="checkbox"/>	ANSI C63.10	11.8.1	Option 1
<input checked="" type="checkbox"/>	ANSI C63.10	11.8.2	Option 2

4.3 Maximum Conducted Output Power	VERDICT: PASS
---	----------------------

4.3.1 Limit

Standard	FCC Part 15 Subpart C Paragraph 15.247 (b)(3); RSS-247 Issue 2 Paragraph 5.4(d).	
<input checked="" type="checkbox"/>	GTX < 6dBi	$P_{out} \leq 30 \text{ dBm}$
<input type="checkbox"/>	GTX > 6dBi	
<input type="checkbox"/>	Non-Fix point-point	$P_{out} \leq 30 - (GTX - 6)$
<input type="checkbox"/>	Fix point-point	$P_{out} \leq 30 - [(GTX - 6)]/3$
<input type="checkbox"/>	Point-to-multipoint	$P_{out} \leq 30 - (GTX - 6)$
<input type="checkbox"/>	Overlap Beams	$P_{out} \leq 30 - [(GTX - 6)]/3$
<input type="checkbox"/>	Aggregate power transmitted simultaneously on all beams	$P_{out} \leq 30 - [(GTX - 6)]/3$
<input type="checkbox"/>	single directional beam	$P_{out} \leq 30 - [(GTX - 6)]/3 + 8 \text{ dB}$

Note 1 : GTX directional gain of transmitting antennas.

Note 2 : Pout is maximum peak conducted output power .

4.3.2 Test Setup

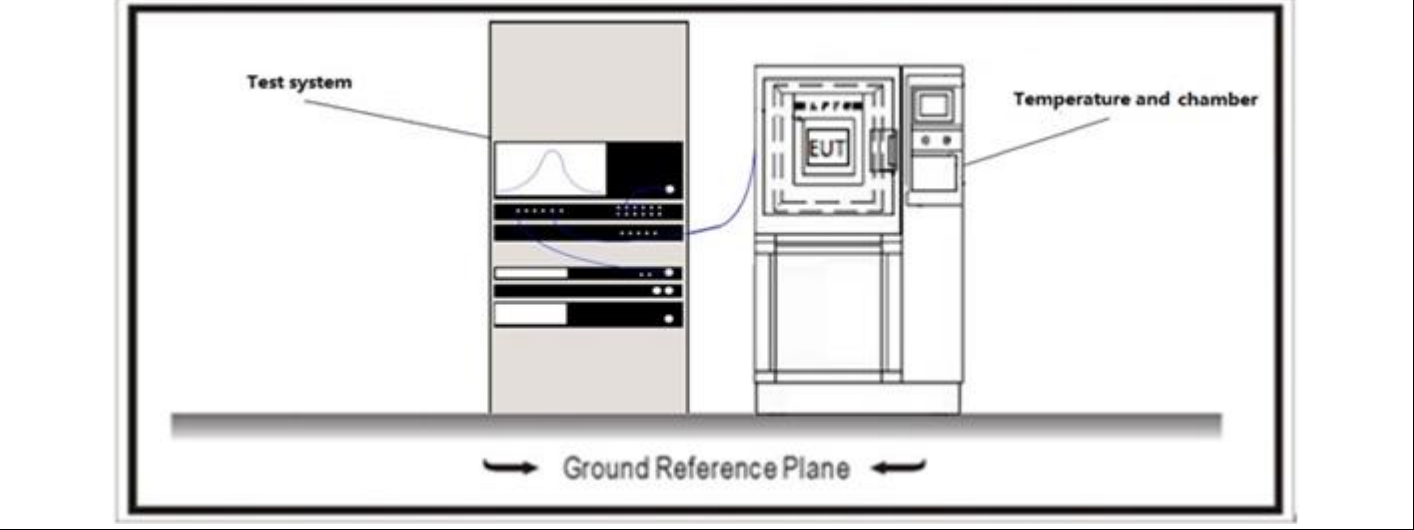

4.3.3 Test Procedure				
	References Rule		Chapter	Description
<input checked="" type="checkbox"/>	ANSI C63.10		11.9	Fundamental emission output power
	<input checked="" type="checkbox"/>	ANSI C63.10	11.9.1	Maximum peak conducted output power
	<input type="checkbox"/>	ANSI C63.10	11.9.1.1	RBW \geq DTS bandwidth
	<input type="checkbox"/>	ANSI C63.10	11.9.1.2	Integrated band power method
	<input type="checkbox"/>	ANSI C63.10	11.9.1.3	PKPM1 Peak power meter method
	<input type="checkbox"/>	ANSI C63.10	11.9.2	Maximum conducted (average) output power
	<input type="checkbox"/>	ANSI C63.10	11.9.2.2	Measurement using a spectrum analyzer (SA)
	<input type="checkbox"/>	ANSI C63.10	11.9.2.2.2	Method AVGSA-1(Duty cycle \geq 98%)
	<input type="checkbox"/>	ANSI C63.10	11.9.2.2.3	Method AVGSA-1A(Duty cycle \geq 98%)
	<input type="checkbox"/>	ANSI C63.10	11.9.2.2.4	Method AVGSA-2(Duty cycle \leq 98%)
	<input type="checkbox"/>	ANSI C63.10	11.9.2.2.5	Method AVGSA-2A(Duty cycle \leq 98%)
	<input type="checkbox"/>	ANSI C63.10	11.9.2.2.4	Method AVGSA-3
	<input type="checkbox"/>	ANSI C63.10	11.9.2.2.5	Method AVGSA-3A
	<input checked="" type="checkbox"/>	ANSI C63.10	11.9.2.3	Measurement using a power meter (PM)
	<input checked="" type="checkbox"/>	ANSI C63.10	11.9.2.3.1	Method AVGPM
	<input type="checkbox"/>	ANSI C63.10	11.9.2.3.2	Method AVGPM-G

4.4 Maximum Power Spectral Density	VERDICT: PASS
---	----------------------

4.4.1 Limit

Standard	FCC Part 15 Subpart C Paragraph 15.247 (b)(3); RSS-247 Issue 2 Paragraph 5.2(b).
Power Spectral Density ≤ 8dBm/3kHz	

4.4.2 Test Setup

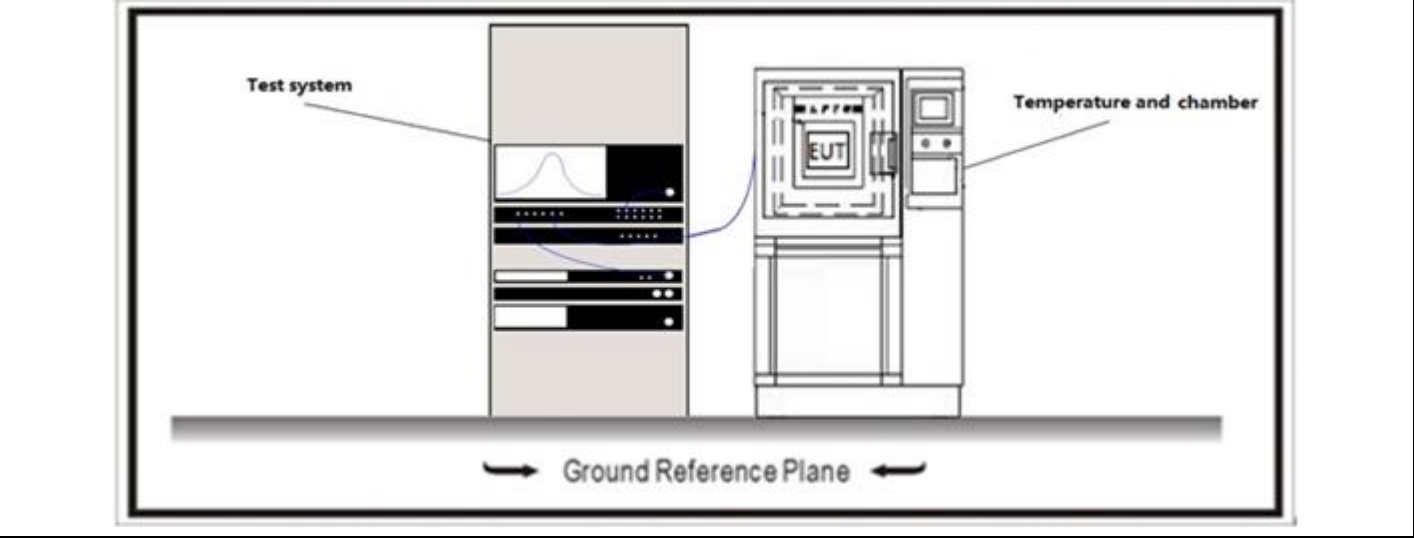

4.4.3 Test Procedure

	References Rule	Chapter	Description
<input checked="" type="checkbox"/>	ANSI C63.10	11.10	Maximum power spectral density level in the fundamental emission
<input checked="" type="checkbox"/>	ANSI C63.10	11.10.2	Method PKPSD (peak PSD)
<input type="checkbox"/>	ANSI C63.10	11.10.3	Method AVGPSD-1(Duty cycle ≥ 98%)
<input type="checkbox"/>	ANSI C63.10	11.10.4	Method AVGPSD-1A(Duty cycle ≥ 98%)
<input type="checkbox"/>	ANSI C63.10	11.10.5	Method AVGPSD-2(Duty cycle < 98%)
<input type="checkbox"/>	ANSI C63.10	11.10.6	Method AVGPSD-2A(Duty cycle < 98%)
<input type="checkbox"/>	ANSI C63.10	11.10.7	Method AVGPSD-3
<input type="checkbox"/>	ANSI C63.10	11.10.8	Method AVGPSD-3A

4.5 Band Edge Measurements	VERDICT: PASS
-----------------------------------	----------------------

4.5.1 Limit

Standard	FCC Part 15 Subpart C Paragraph 15.247(d) , 15.209; RSS-Gen Issue 5 Paragraph 8.10.			
Frequency bands (MHz)	Detector	Limit (dBµV/m)	RBW (MHz)	Distance (m)
2310-2390	PK	74	1	3
2483.5-2500	AV	54	1	3

Note: The field strength of emissions appearing within these frequency bands shall not exceed the limits.

4.5.2 Test Setup

Above 1GHz Test Setup:

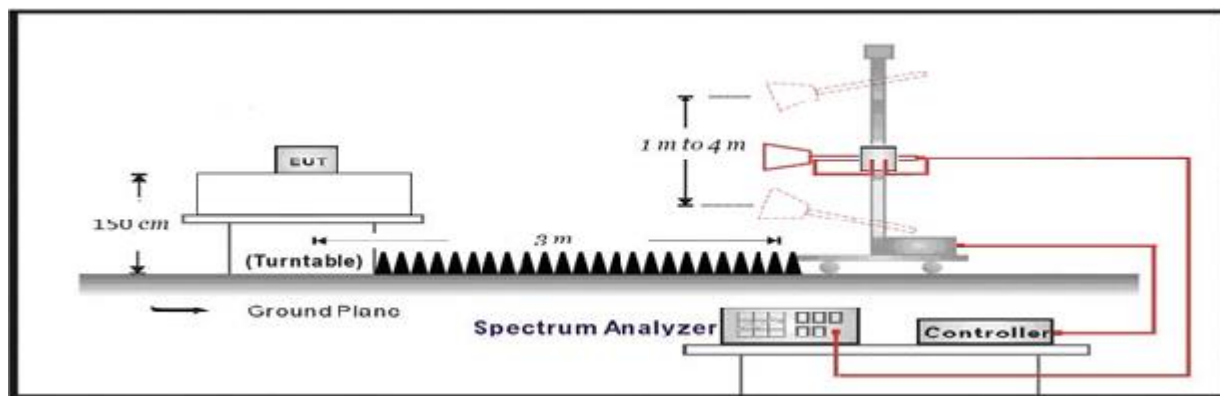

4.5.3 Test Procedure

	References Rule	Chapter	Description
<input checked="" type="checkbox"/>	ANSI C63.10	6.10	Band-edge testing
	<input checked="" type="checkbox"/> ANSI C63.10	6.10.5	Restricted-band band-edge measurements
	<input type="checkbox"/> ANSI C63.10	6.10.6	Marker-delta method
<input checked="" type="checkbox"/>	ANSI C63.10	11.12	Emissions in restricted frequency bands
	<input checked="" type="checkbox"/> ANSI C63.10	11.12.1	Radiated emission measurements
	<input checked="" type="checkbox"/> ANSI C63.10	11.12.2.7	Radiated spurious emission test
<input type="checkbox"/>	ANSI C63.10	6.4	Radiated emissions from unlicensed wireless devices below 30 MHz
<input type="checkbox"/>	ANSI C63.10	6.5	Radiated emissions from unlicensed wireless devices in the frequency range of 30 MHz to 1000 MHz
<input checked="" type="checkbox"/>	ANSI C63.10	6.6	Radiated emissions from unlicensed wireless devices above 1 GHz

4.6 Conducted Spurious Emission	VERDICT: PASS
--	----------------------

4.6.1 Limit

Standard	FCC Part 15 Subpart C Paragraph 15.247(d); RSS-247 Issue 2 Paragraph 5.5.
RF Output power (Detection methods)	Limit(dB)
RF Output power(Average detector)	30dBc(Note1)
RF Output power(PK detector)	20dBc(Note2)

Note 1: If maximum conducted (average) output power was used to demonstrate compliance as described in 9.2, then the peak power in any 100 kHz bandwidth outside of the authorized frequency band shall be attenuated by at least 30 dB relative to the maximum in-band peak PSD level in 100 kHz (i.e., 30 dBc).

Note 2: If the maximum peak conducted output power procedure was used, then the peak output power measured in any 100 kHz bandwidth outside of the authorized frequency band shall be attenuated by at least 20 dB relative to the maximum in-band peak PSD level in 100 kHz (i.e., 20 dBc).

4.6.2 Test Setup

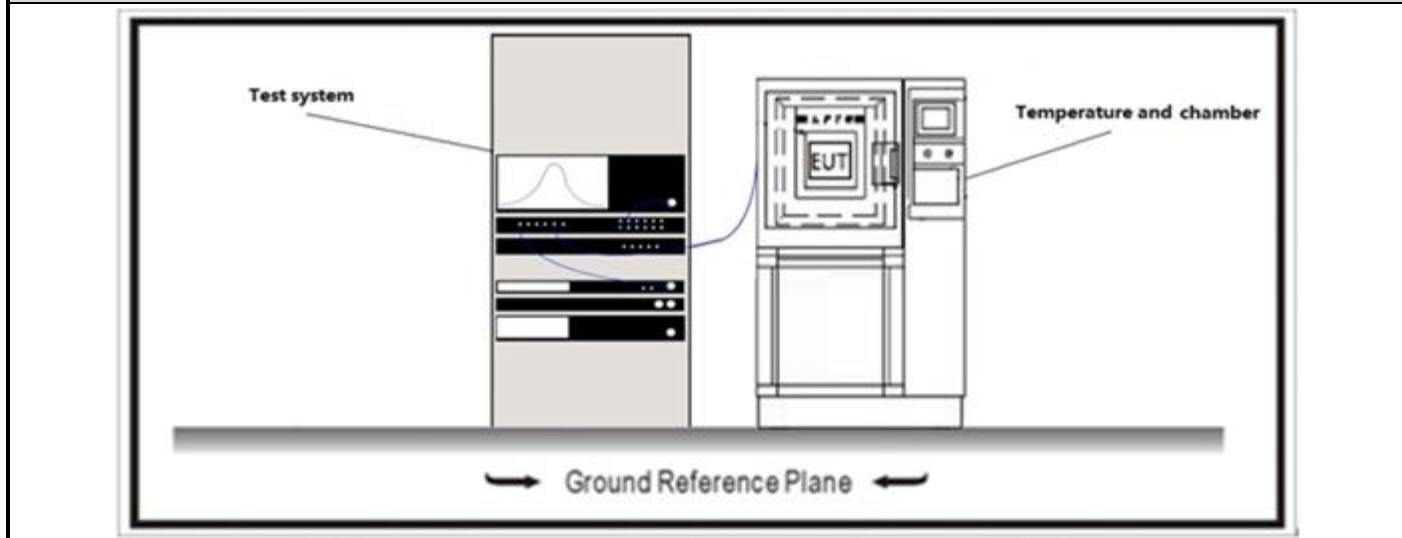

4.6.3 Test Procedure

References Rule	Chapter	Description
<input checked="" type="checkbox"/> ANSI C63.10	11.11	Emissions in non-restricted frequency bands
<input checked="" type="checkbox"/> ANSI C63.10	11.11.1	General
<input checked="" type="checkbox"/> ANSI C63.10	11.11.2	Reference level measurement
<input checked="" type="checkbox"/> ANSI C63.10	11.11.3	Emission level measurement

4.7 Duty cycle	VERDICT: PASS
-----------------------	----------------------

4.7.1 Limit

N/A

4.7.2 Test Setup

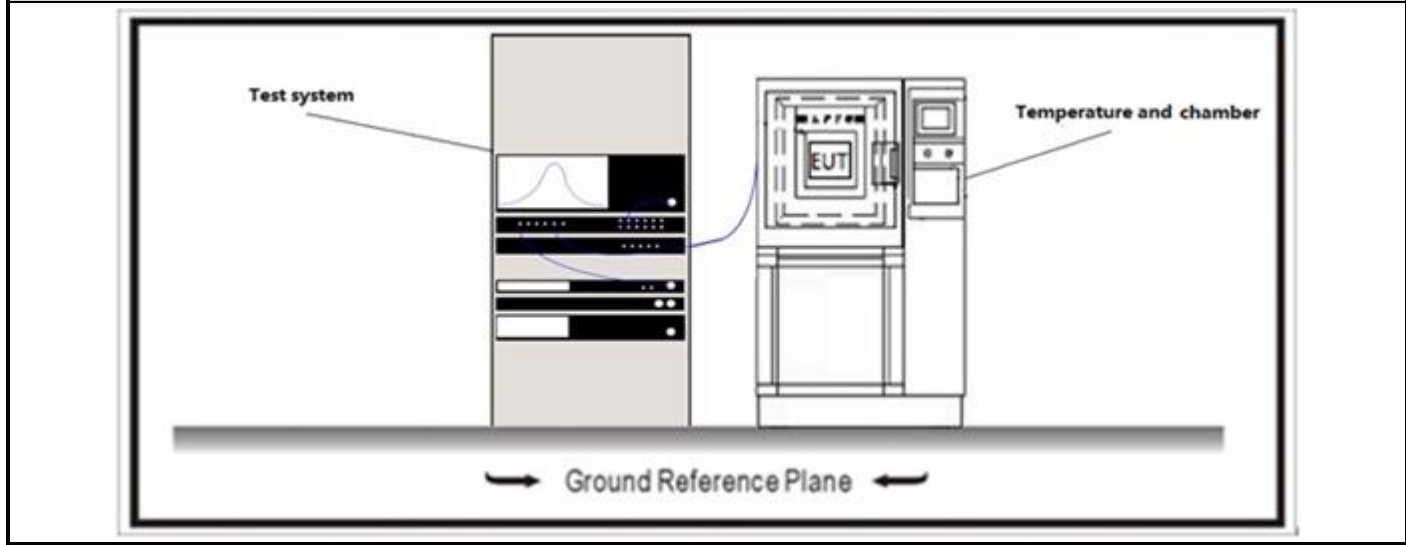

4.7.3 Test Procedure

References Rule	Chapter	Description
<input checked="" type="checkbox"/> ANSI C63.10	11.6	Duty cycle (D), transmission duration (T), and maximum power control level

4.8 Emissions in Restricted Bands	VERDICT: PASS
--	----------------------

4.8.1 Limit

Standard	FCC Part 15 Subpart C Paragraph 15.205
-----------------	--

Restricted Bands of operation

Frequency (MHz)	Frequency (MHz)	Frequency (MHz)	Frequency (GHz)
0.090 – 0.110	16.42 – 16.423	399.9 – 410	4.5 – 5.15
0.495 – 0.505	16.69475 – 16.69525	608 – 614	5.35 – 5.46
2.1735 – 2.1905	16.80425 – 16.80475	960 – 1240	7.25 – 7.75
4.125 – 4.128	25.5 – 25.67	1300 – 1427	8.025 – 8.5
4.17725 – 4.17775	37.5 – 38.25	1435 – 1626.5	9.0 – 9.2
4.20725 – 4.20775	73 – 74.6	1645.5 – 1646.5	9.3 – 9.5
6.215 – 6.218	74.8 – 75.2	1660 – 1710	10.6 – 12.7
6.26775 – 6.26825	108 – 121.94	1718.8 – 1722.2	13.25 – 13.4
6.31175 – 6.31225	123 – 138	2200 – 2300	14.47 – 14.5
8.291 – 8.294	149.9 – 150.05	2310 – 2390	15.35 – 16.2
8.362 – 8.366	156.52475 – 156.52525	2483.5 – 2500	17.7 – 21.4
8.37625 – 8.38675	156.7 – 156.9	2690 – 2900	22.01 – 23.12
8.81425 – 8.81475	162.0125 – 167.17	3260 – 3267	23.6 – 24.0
12.29 – 12.293	167.72 – 173.2	3332 – 3339	31.2 – 31.8
12.51975 – 12.52025	240 – 285	3345.8 – 3358	36.43 – 36.5
12.57675 – 12.57725	322 – 335.4	3600 – 4400	
13.36 – 13.41			

Standard	RSS-Gen Issue 5 Paragraph 8.10
-----------------	--------------------------------

Restricted Bands of operation for IC

0.090 - 0.110	13.36 - 13.41	960 - 1427	9.0 - 9.2
0.495 - 0.505	16.42 - 16.423	1435 - 1626.5	9.3 - 9.5
2.1735 - 2.1905	16.69475 - 16.69525	1645.5 - 1646.5	10.6 - 12.7
3.020 - 3.026	16.80425 - 16.80475	1660 - 1710	13.25 - 13.4
4.125 - 4.128	25.5 - 25.67	1718.8 - 1722.2	14.47 - 14.5
4.17725 - 4.17775	37.5 - 38.25	2200 - 2300	15.35 - 16.2
4.20725 - 4.20775	73 - 74.6	2310 - 2390	17.7 - 21.4
5.677 - 5.683	74.8 - 75.2	2483.5 - 2500	22.01 - 23.12
6.215 - 6.218	108 - 138	2655 - 2900	23.6 - 24.0
6.26775 - 6.26825	149.9 - 150.05	3260 - 3267	31.2 - 31.8
6.31175 - 6.31225	156.52475 - 156.52525	3332 - 3339	36.43 - 36.5
8.291 - 8.294	156.7 - 156.9	3345.8 - 3358	Above 38.6
8.362 - 8.366	162.0125 - 167.17	3500 - 4400	
8.37625 - 8.38675	167.72 - 173.2	4500 - 5150	
8.41425 - 8.41475	240 - 285	5350 - 5460	
12.29 - 12.293	322 - 335.4	7250 - 7750	
12.51975 - 12.52025	399.9 - 410	8025 - 8500	
12.57675 - 12.57725	608 - 614	--	

Restricted Band Emissions Limit			
FCC Part 15 Subpart C Paragraph 15.209			
Frequency (MHz)	Field strength (μV/m)	Field strength (dBμV/m)	Measurement distance (m)
0.009 - 0.49	2400/F(kHz)	48.5 – 13.8	300 _(Note 1)
0.49 - 1.705	24000/F(kHz)	33.8 - 23	30 _(Note 1)
1.705 - 30	30	29.5	30 _(Note 1)
30 - 88	100	40	3 _(Note 2)
88 - 216	150	43.5	3 _(Note 2)
216 - 960	200	46	3 _(Note 2)
Above 960	500	54	3 _(Note 2)
RSS-Gen Issue 5 Paragraph 8.9.			
Frequency (MHz)	Field strength	Field strength (dBμV/m)	Measurement distance (m)
0.009 - 0.49	6.37/F(kHz) μA/m	48.5 – 13.8	300 _(Note 1)
0.49 - 1.705	63.7/F(kHz) μA/m	33.8 - 23	30 _(Note 1)
1.705 - 30	30 μV/m	29.5	30 _(Note 1)
30 - 88	100 μV/m	40	3 _(Note 2)
88 - 216	150 μV/m	43.5	3 _(Note 2)
216 - 960	200 μV/m	46	3 _(Note 2)
Above 960	500 μV/m	54	3 _(Note 2)
<p>Note 1: At frequencies below 30 MHz, measurements may be performed at a distance closer than that specified in the regulations; however, an attempt should be made to avoid making measurements in the near field. Pending the development of an appropriate measurement procedure for measurements performed below 30 MHz, when performing measurements at a closer distance than specified, the results shall be extrapolated to the specified distance by either making measurements at a minimum of two distances on at least one radial to determine the proper extrapolation factor or by using the square of an inverse linear distance extrapolation factor (40 dB/decade).</p> <p>Note 2: At frequencies at or above 30 MHz, measurements may be performed at a distance other than what is specified provided: measurements are not made in the near field except where it can be shown that near field measurements are appropriate due to the characteristics of the device; and it can be demonstrated that the signal levels needed to be measured at the distance employed can be detected by the measurement equipment. Measurements shall not be performed at a distance greater than 30 meters unless it can be further demonstrated that measurements at a distance of 30 meters or less are impractical. When performing measurements at a distance other than that specified, the results shall be extrapolated to the specified distance using an extrapolation factor of 20 dB/decade (inverse linear-distance for field strength measurements; inverse-linear-distance-squared for power density measurements).</p>			

4.8.2 Test Setup

Below 30MHz Test Setup:

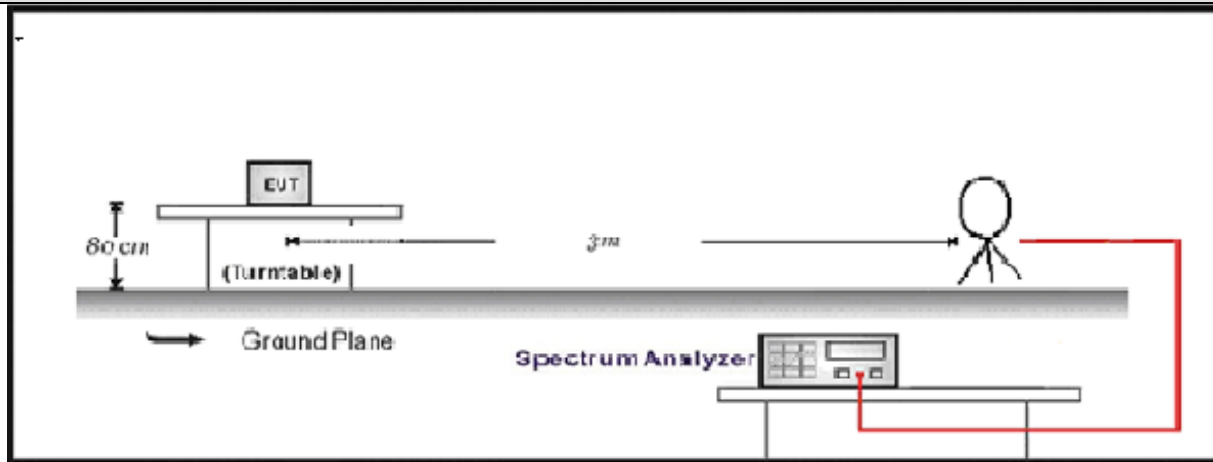

30MHz-1GHz Test Setup:

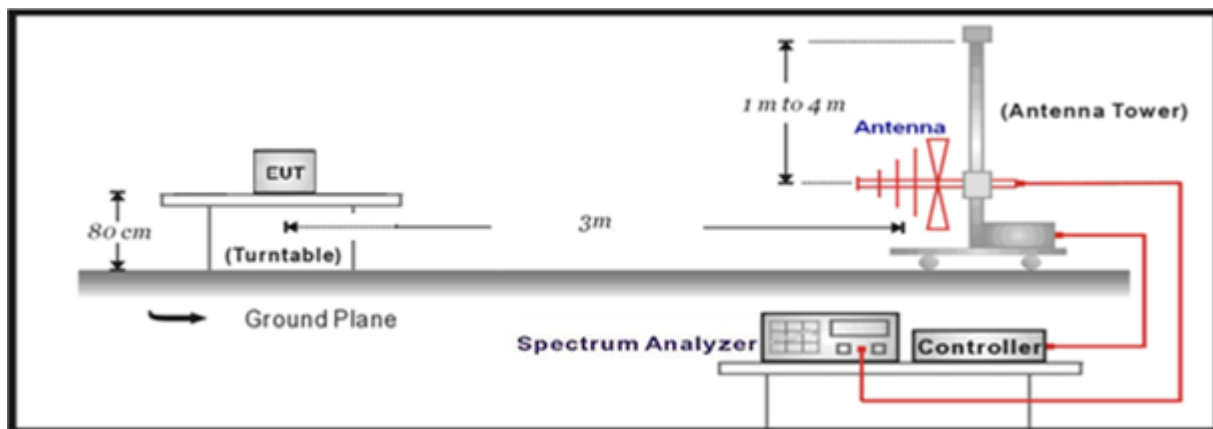

Above 1GHz Test Setup:

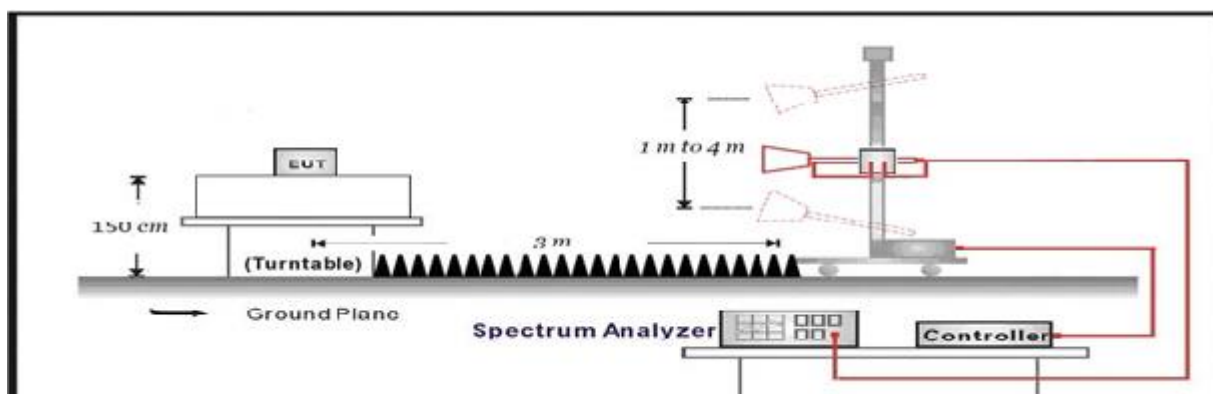

4.8.3 Test Procedure			
	References Rule	Chapter	Description
<input checked="" type="checkbox"/>	ANSI C63.10	11.12	Emissions in restricted frequency bands
<input checked="" type="checkbox"/>	<input checked="" type="checkbox"/> ANSI C63.10	11.12.1	Radiated emission measurements
<input checked="" type="checkbox"/>	<input checked="" type="checkbox"/> ANSI C63.10	11.12.2.7	Radiated spurious emission test
<input checked="" type="checkbox"/>	<input checked="" type="checkbox"/> ANSI C63.10	6.4	Radiated emissions from unlicensed wireless devices below 30 MHz
<input checked="" type="checkbox"/>	<input checked="" type="checkbox"/> ANSI C63.10	6.5	Radiated emissions from unlicensed wireless devices in the frequency range of 30 MHz to 1000 MHz
<input checked="" type="checkbox"/>	<input checked="" type="checkbox"/> ANSI C63.10	6.6	Radiated emissions from unlicensed wireless devices above 1 GHz

4.9 AC Power Line Conducted Emission	VERDICT: N/A
---	---------------------

4.9.1 Limit

Standard	FCC Part 15 Subpart C Paragraph 15.207; RSS-Gen Issue 5 Paragraph 8.8.	
Frequency range [MHz]	Limit: QP [dB(μV) ¹⁾	Limit: AV [dB(μV) ¹⁾
0,15 - 0,50	66 - 56 ²⁾	56 - 46 ²⁾
0,50 - 5,0	56	46
5,0 - 30	60	50

¹⁾ At the transition frequency, the lower limit applies.

²⁾ The limit decreases linearly with the logarithm of the frequency.

NOTE 1: The exclusion band for transmitters shall be considered for transmitters operating at frequencies below 30 MHz.

NOTE 2: Where the AC output port is directly connected (or via a circuit breaker) to the AC power input port of the EUT the AC power output port need not to be tested.

4.9.2 Test Setup

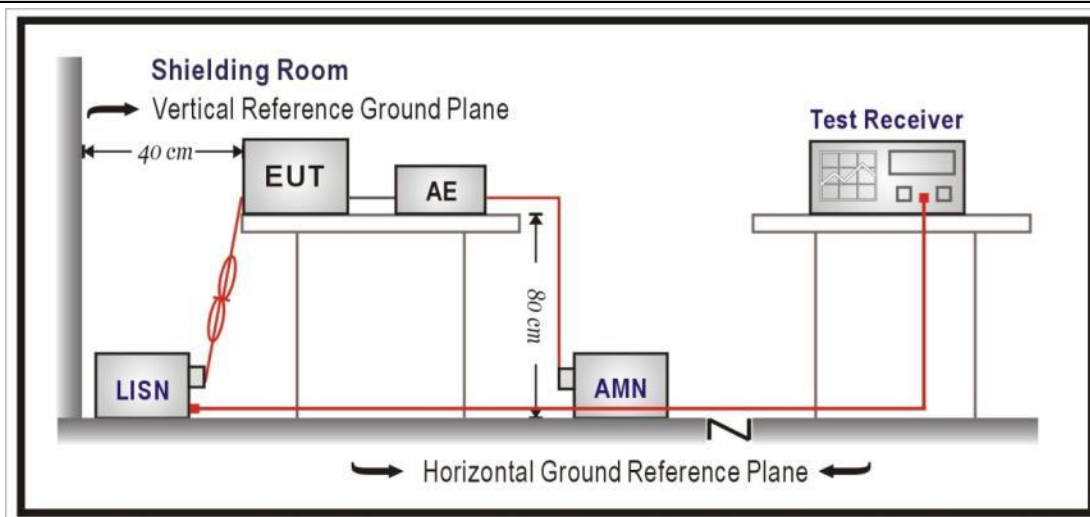

4.9.3 Test Procedure

	References Rule	Chapter	Item
☒	ANSI C63.10-2013	6.2	Standard test method for ac power-line conducted emissions from unlicensed wireless devices

4.10 Antenna Requirement	VERDICT: PASS
---------------------------------	----------------------

4.10.1 Limit:

Standard	FCC Part 15 Subpart C Paragraph 15.203; RSS-Gen Issue 5 Paragraph 6.8.
-----------------	---

An intentional radiator shall be designed to ensure that no antenna other than that furnished by the responsible party shall be used with the device. The use of a permanently attached antenna or of an antenna that uses a unique coupling to the intentional radiator shall be considered sufficient to comply with the provisions of this section. The manufacturer may design the unit so that a broken antenna can be replaced by the user, but the use of a standard antenna jack or electrical connector is prohibited. This requirement does not apply to carrier current devices or to devices operated under the provisions of §15.211, §15.213, §15.217, §15.219, or §15.221. Further, this requirement does not apply to intentional radiators that must be professionally installed, such as perimeter protection systems and some field disturbance sensors, or to other intentional radiators which, in accordance with §15.31(d), must be measured at the installation site. However, the installer shall be responsible for ensuring that the proper antenna is employed so that the limits in this part are not exceeded.

4.10.2 Antenna Connector Construction:

<input checked="" type="checkbox"/>	The use of a permanently attached antenna
<input type="checkbox"/>	The antenna use of a unique coupling to the intentional radiator
<input type="checkbox"/>	The use of a nonstandard antenna jack or electrical connector

Please refer to the attached document "Internal Photograph" to show the antenna connector.

5 TEST SETUP PHOTO AND EUT PHOTO

Remark: The test setup photo and EUT Photo please see appendix.

6 TEST RESULT

Appendix A: DTS Bandwidth

TestMode	Frequency[MHz]	DTS BW [MHz]	FL[MHz]	FH[MHz]	Limit[MHz]	Verdict
BLE_1M	2402	0.640	2401.692	2402.332	0.5	PASS
	2440	0.648	2439.688	2440.336	0.5	PASS
	2480	0.648	2479.688	2480.336	0.5	PASS

BLE_1M_Ant1_2402



BLE_1M_Ant1_2440

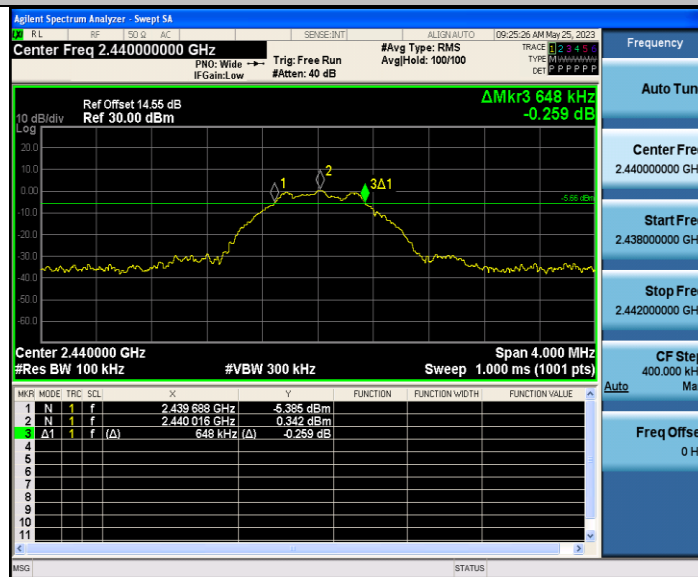

BLE_1M_Ant1_2480

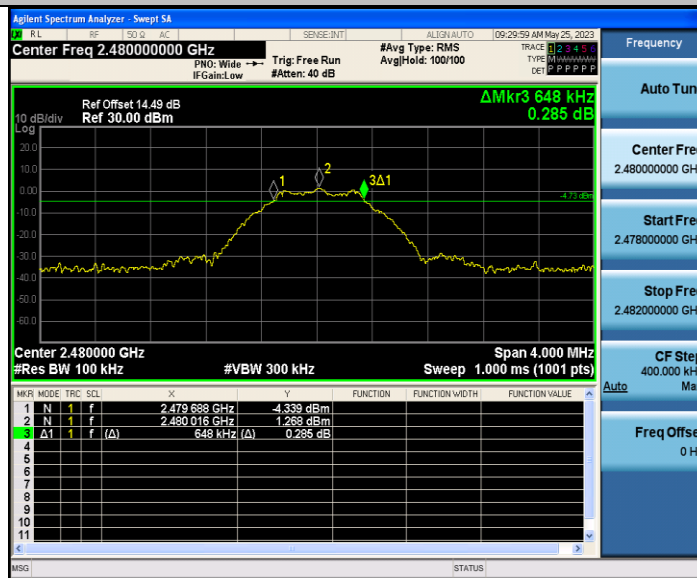

Appendix B: Occupied Channel Bandwidth

TestMode	Frequency[MHz]	OCB [MHz]	FL[MHz]	FH[MHz]	Limit[MHz]
BLE_1M	2402	1.0382	2401.5077	2402.5459	N/A
	2440	1.0256	2439.5071	2440.5327	N/A
	2480	1.0287	2479.5099	2480.5386	N/A

BLE_1M_Ant1_2402

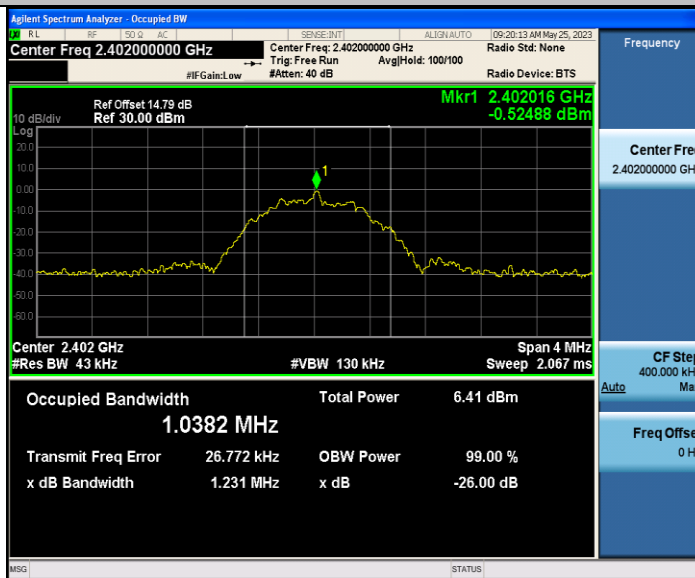

BLE_1M_Ant1_2440

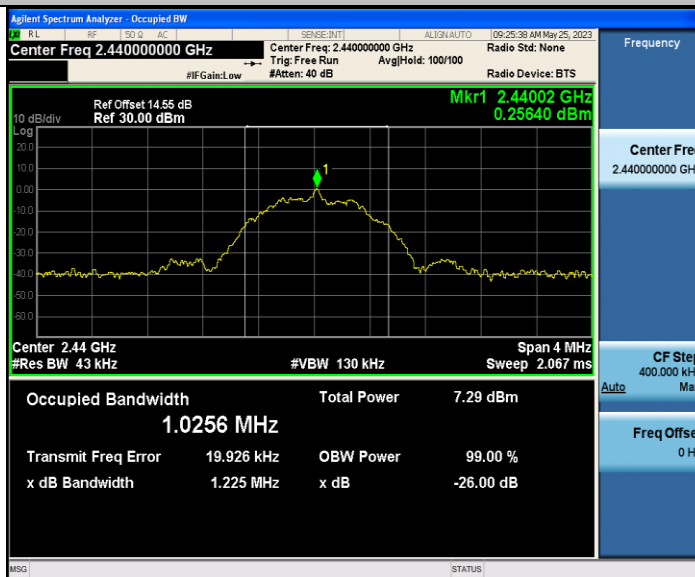

BLE_1M_Ant1_2480

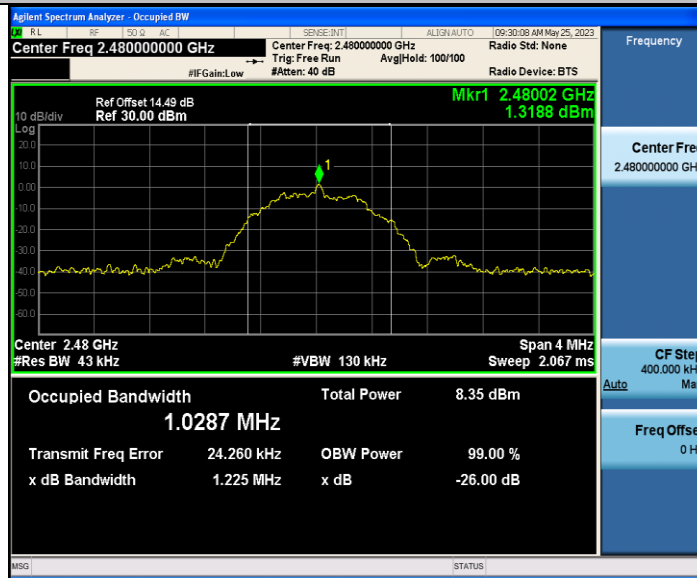

Appendix C: Maximum conducted output power

Test Mode	Frequency[MHz]	Conducted Power[dBm]	Conducted Limit[dBm]	EIRP[dBm]	EIRP Limit[dBm]	Verdict
BLE_1M	2402	-0.93	≤30	1.97	≤36	PASS
	2440	-0.38	≤30	2.52	≤36	PASS
	2480	0.58	≤30	3.48	≤36	PASS

Appendix D: Maximum power spectral density

TestMode	Frequency[MHz]	Result[dBm/3kHz]	Limit[dBm/3kHz]	Verdict
BLE_1M	2402	-14.98	≤8.00	PASS
	2440	-14.14	≤8.00	PASS
	2480	-13.33	≤8.00	PASS

BLE_1M_Ant1_2402

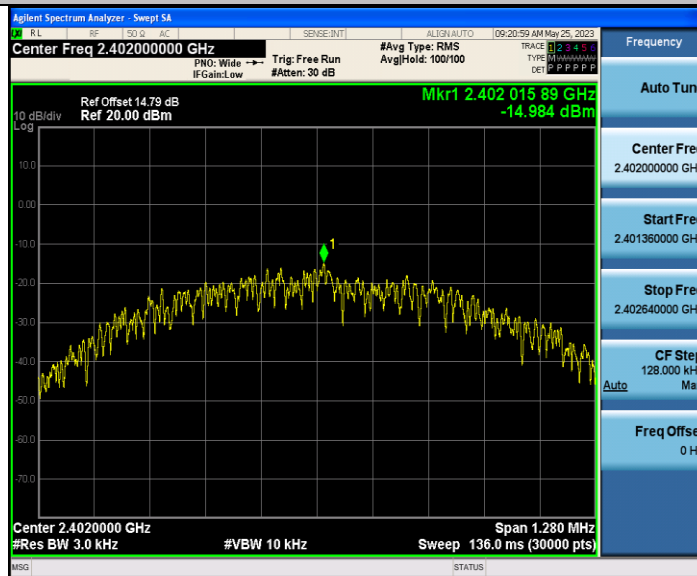

BLE_1M_Ant1_2440

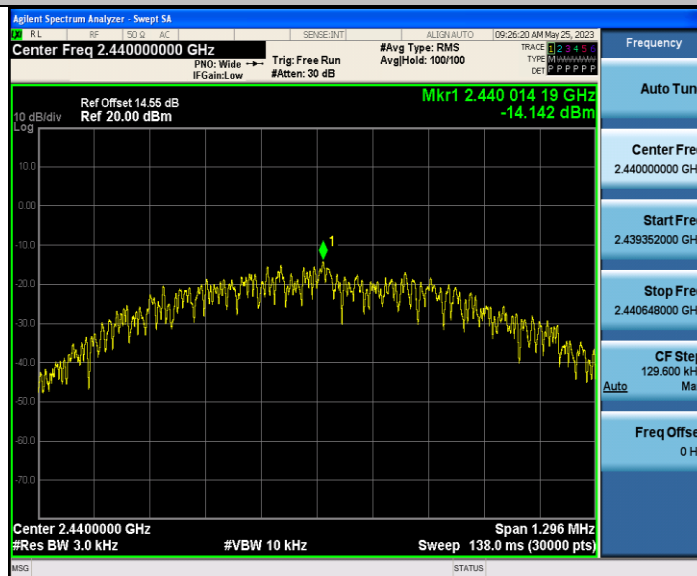

BLE_1M_Ant1_2480

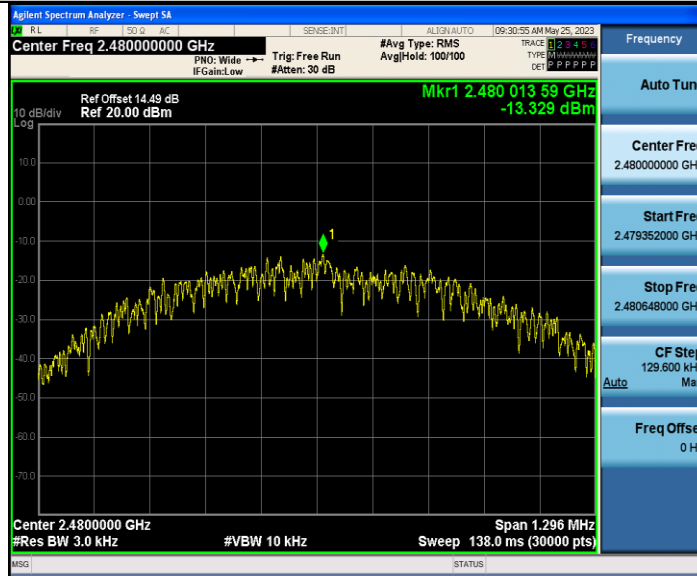

Appendix E: Band edge measurements

Profile: 2340773R	Page No.: 1
Engineer: Yuliu	
Site: AC5	Time: 2023/05/16 - 20:03
Limit: FCC_Part15.209_RE(3m)	Margin: 0
Probe: Horn_3117_00167055(1-18GHz)	Polarity: Horizontal
EUT: Barcode Scanner	Power: By Battery
Note: Mode 1 : Transmit at 2402MHz by LE_1Mbps	

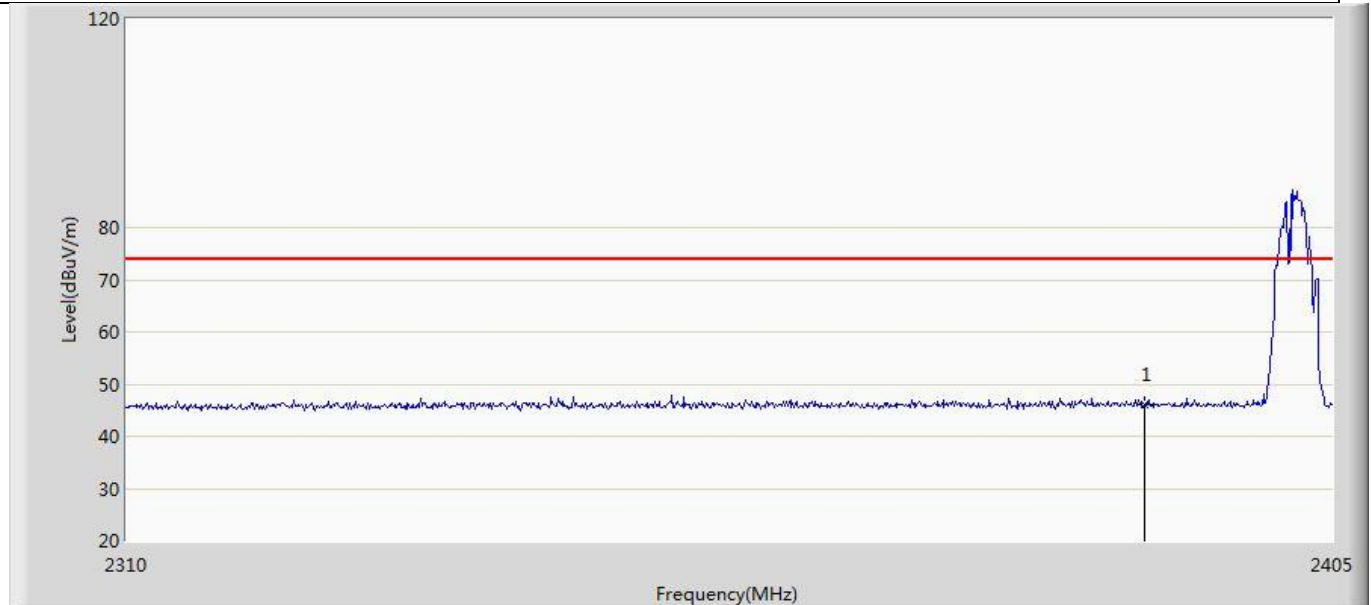

No	Mark	Frequency (MHz)	Measure Level (dBuV/m)	Reading Level (dBuV)	Over Limit (dB)	Limit (dBuV/m)	Factor (dB)	Type
1	*	2390.000	46.112	12.028	-27.888	74.000	34.084	PK

Profile: 2340773R	Page No.: 2
Engineer: Yuliu	
Site: AC5	Time: 2023/05/16 - 20:11
Limit: FCC_Part15.209_RE(3m)	Margin: 0
Probe: Horn_3117_00167055(1-18GHz)	Polarity: Horizontal
EUT: Barcode Scanner	Power: By Battery
Note: Mode 1 : Transmit at 2402MHz by LE_1Mbps	

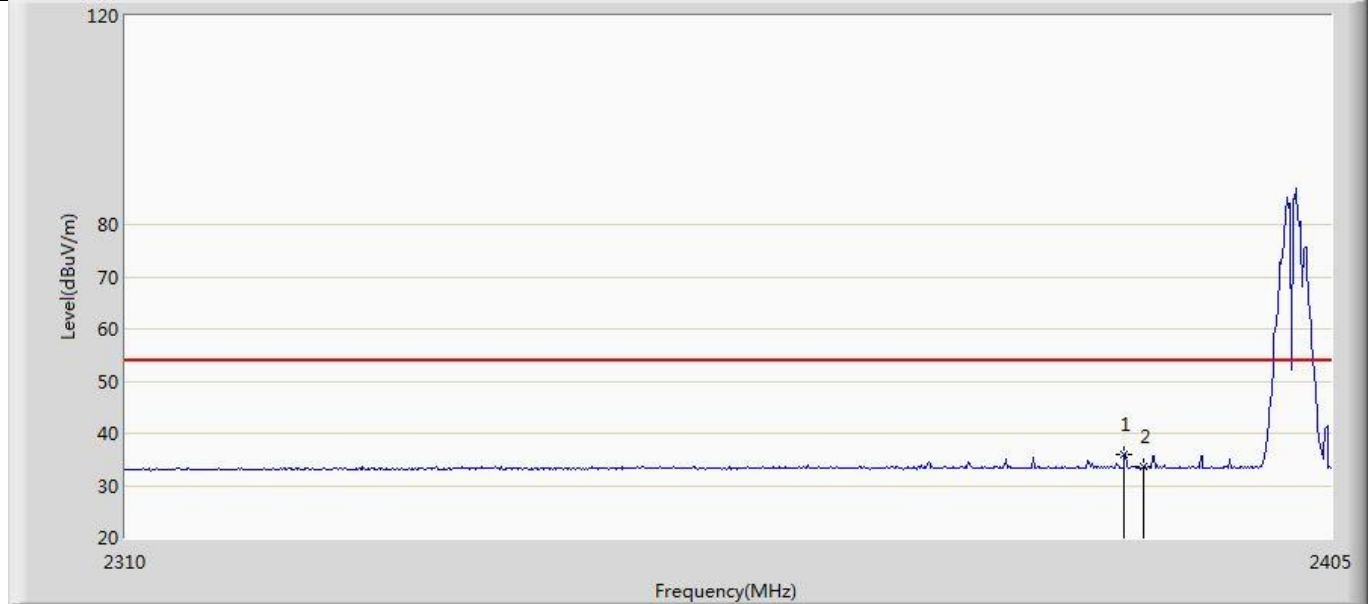

No	Mark	Frequency (MHz)	Measure Level (dBuV/m)	Reading Level (dBuV)	Over Limit (dB)	Limit (dBuV/m)	Factor (dB)	Type
1	*	2388.470	36.051	33.991	-17.949	54.000	2.060	AV
2		2390.000	33.631	-0.453	-20.369	54.000	34.084	AV

Profile: 2340773R	Page No.: 3
Engineer: Yuliu	
Site: AC5	Time: 2023/05/16 - 20:12
Limit: FCC_Part15.209_RE(3m)	Margin: 0
Probe: Horn_3117_00167055(1-18GHz)	Polarity: Vertical
EUT: Barcode Scanner	Power: By Battery
Note: Mode 1 : Transmit at 2402MHz by LE_1Mbps	

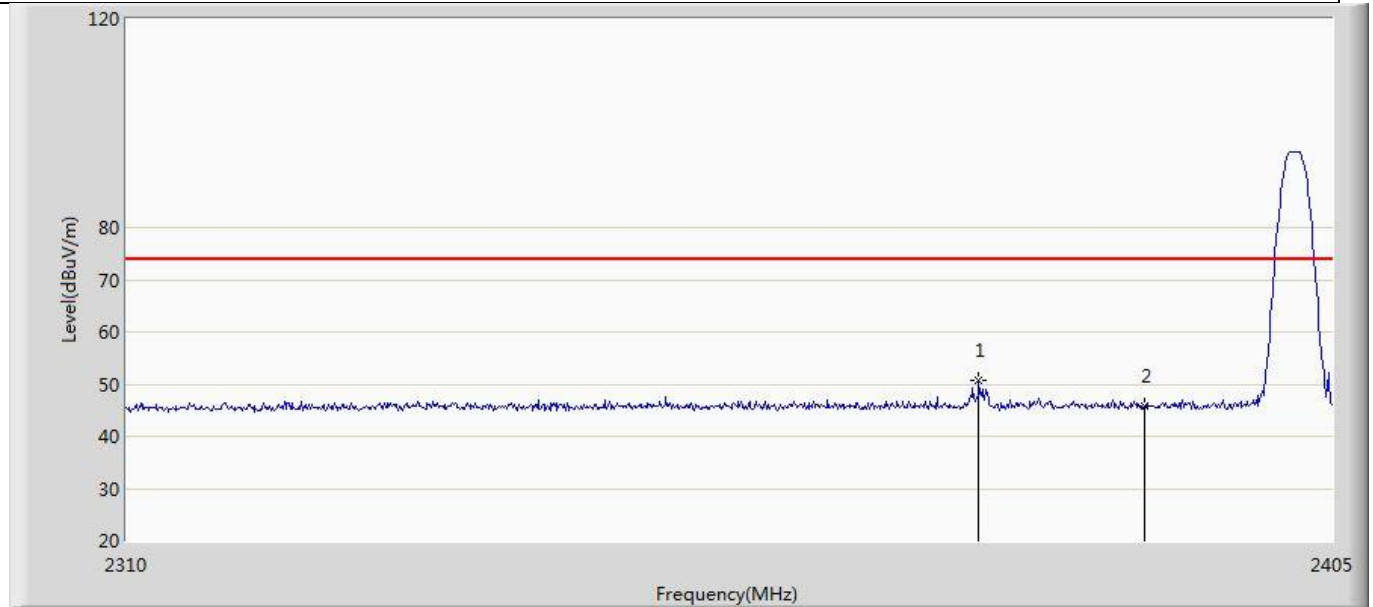

No	Mark	Frequency (MHz)	Measure Level (dBuV/m)	Reading Level (dBuV)	Over Limit (dB)	Limit (dBuV/m)	Factor (dB)	Type
1	*	2376.785	50.663	48.623	-23.337	74.000	2.040	PK
2		2390.000	45.680	11.596	-28.320	74.000	34.084	PK

Profile: 2340773R	Page No.: 4
Engineer: Yuliu	
Site: AC5	Time: 2023/05/16 - 20:13
Limit: FCC_Part15.209_RE(3m)	Margin: 0
Probe: Horn_3117_00167055(1-18GHz)	Polarity: Vertical
EUT: Barcode Scanner	Power: By Battery
Note: Mode 1 : Transmit at 2402MHz by LE_1Mbps	

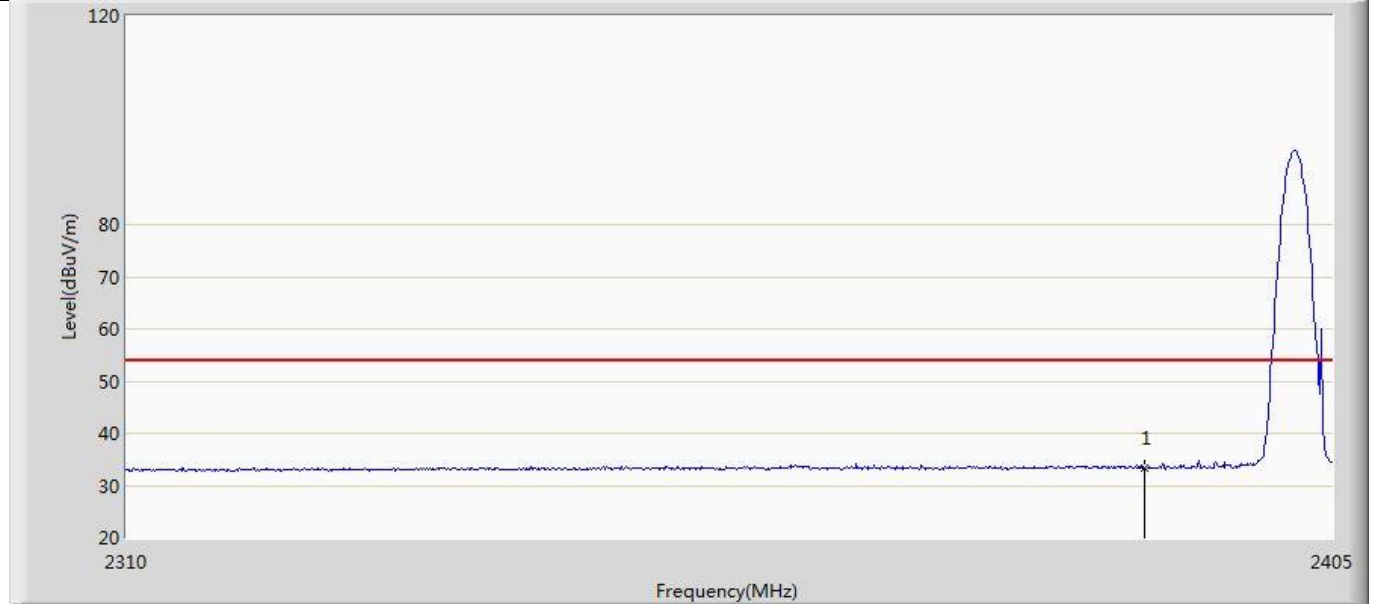

No	Mark	Frequency (MHz)	Measure Level (dBuV/m)	Reading Level (dBuV)	Over Limit (dB)	Limit (dBuV/m)	Factor (dB)	Type
1	*	2390.000	33.360	-0.724	-20.640	54.000	34.084	AV

Profile: 2340773R	Page No.: 5
Engineer: Yuliu	
Site: AC5	Time: 2023/05/16 - 20:14
Limit: FCC_Part15.209_RE(3m)	Margin: 0
Probe: Horn_3117_00167055(1-18GHz)	Polarity: Horizontal
EUT: Barcode Scanner	Power: By Battery
Note: Mode 1 : Transmit at 2480MHz by LE_1Mbps	

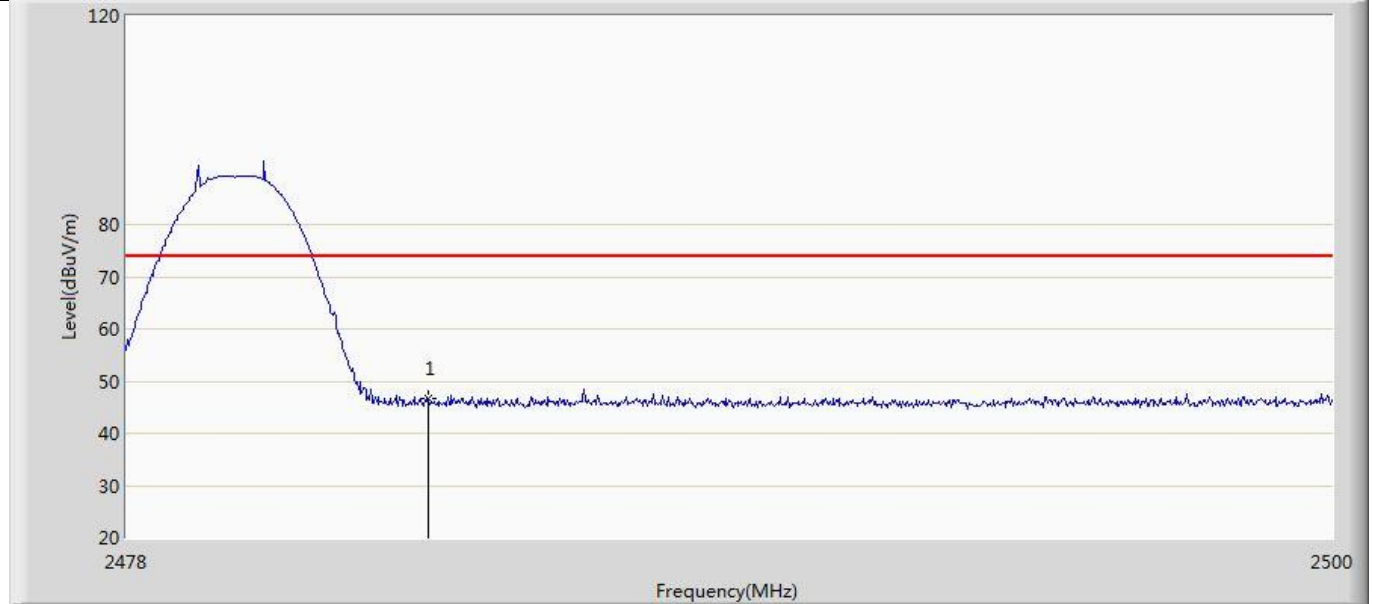

No	Mark	Frequency (MHz)	Measure Level (dBuV/m)	Reading Level (dBuV)	Over Limit (dB)	Limit (dBuV/m)	Factor (dB)	Type
1	*	2483.500	46.687	12.196	-27.313	74.000	34.491	PK

Profile: 2340773R	Page No.: 6
Engineer: Yuliu	
Site: AC5	Time: 2023/05/16 - 20:16
Limit: FCC_Part15.209_RE(3m)	Margin: 0
Probe: Horn_3117_00167055(1-18GHz)	Polarity: Horizontal
EUT: Barcode Scanner	Power: By Battery
Note: Mode 1 : Transmit at 2480MHz by LE_1Mbps	

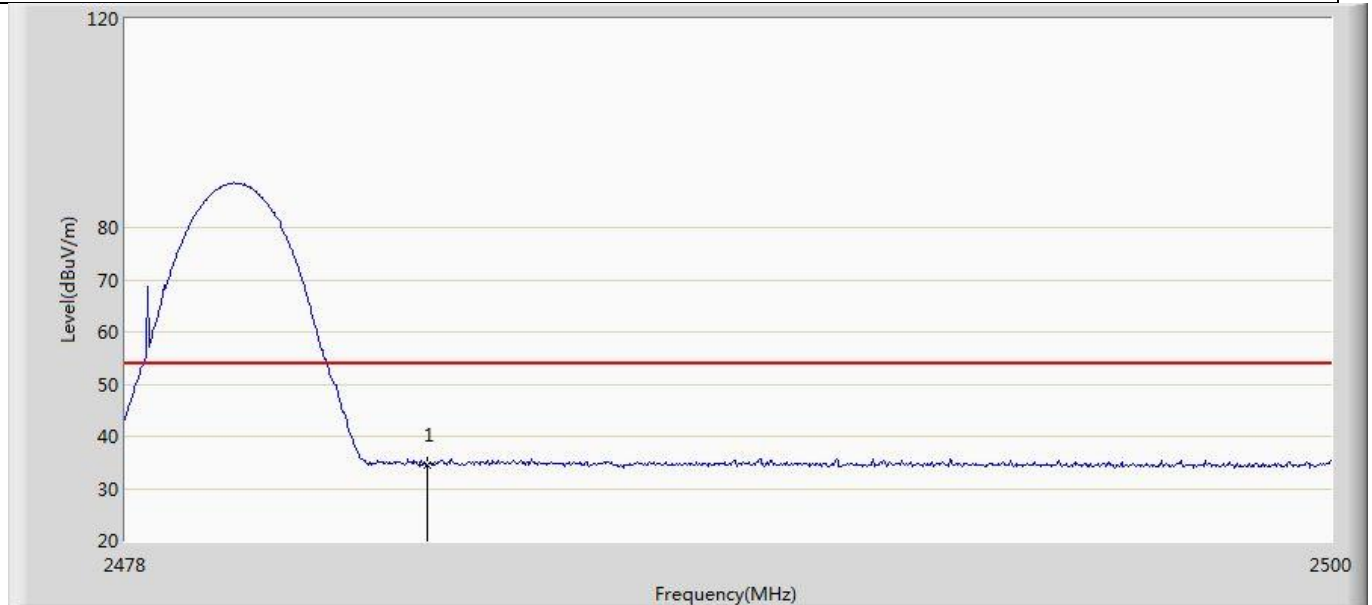

No	Mark	Frequency (MHz)	Measure Level (dBuV/m)	Reading Level (dBuV)	Over Limit (dB)	Limit (dBuV/m)	Factor (dB)	Type
1	*	2483.500	34.540	0.049	-19.460	54.000	34.491	AV

Profile: 2340773R	Page No.: 7
Engineer: Yuliu	
Site: AC5	Time: 2023/05/16 - 20:17
Limit: FCC_Part15.209_RE(3m)	Margin: 0
Probe: Horn_3117_00167055(1-18GHz)	Polarity: Vertical
EUT: Barcode Scanner	Power: By Battery
Note: Mode 1 : Transmit at 2480MHz by LE_1Mbps	

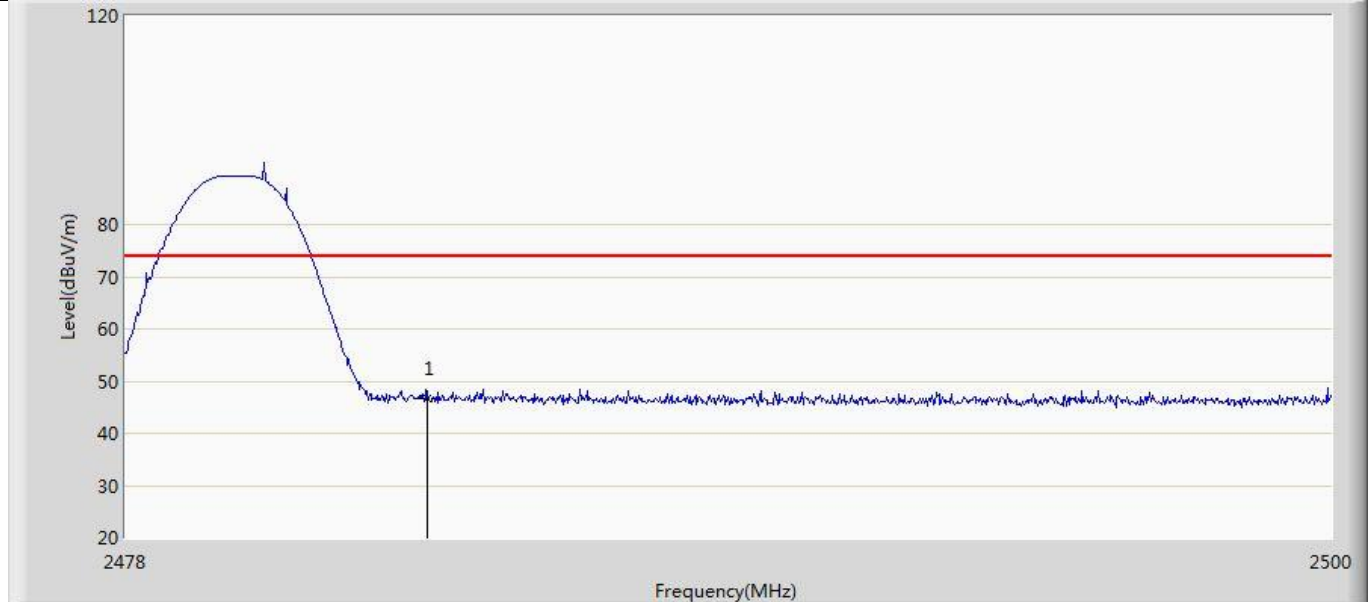

No	Mark	Frequency (MHz)	Measure Level (dBuV/m)	Reading Level (dBuV)	Over Limit (dB)	Limit (dBuV/m)	Factor (dB)	Type
1	*	2483.500	46.730	12.239	-27.270	74.000	34.491	PK

Profile: 2340773R	Page No.: 8
Engineer: Yuliu	
Site: AC5	Time: 2023/05/16 - 20:18
Limit: FCC_Part15.209_RE(3m)	Margin: 0
Probe: Horn_3117_00167055(1-18GHz)	Polarity: Vertical
EUT: Barcode Scanner	Power: By Battery
Note: Mode 1 : Transmit at 2480MHz by LE_1Mbps	

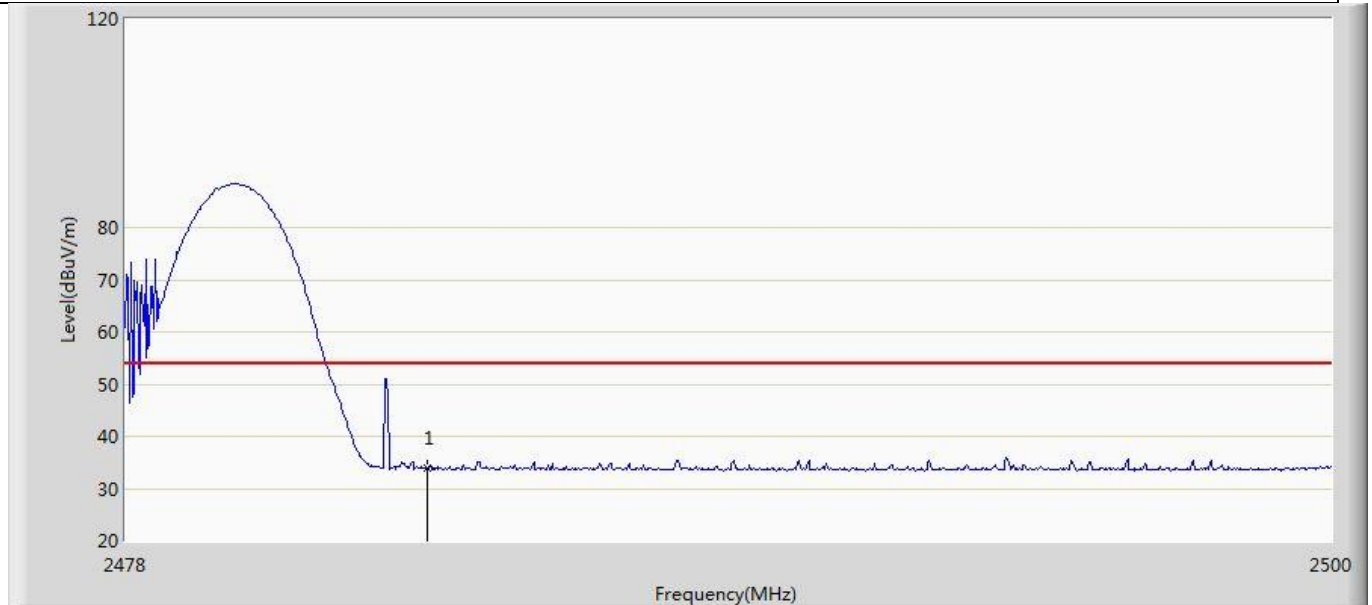

No	Mark	Frequency (MHz)	Measure Level (dBuV/m)	Reading Level (dBuV)	Over Limit (dB)	Limit (dBuV/m)	Factor (dB)	Type
1	*	2483.500	33.956	-0.535	-20.044	54.000	34.491	AV

Appendix F: Conducted Spurious Emission

Test Result for Reference level :

TestMode	Freq(MHz)	Max.Point[MHz]	Result[dBm]
BLE_1M	2402	2402.02	-0.64
	2440	2440.02	0.23
	2480	2480.01	1.23

Test Result for Band edge :

TestMode	ChName	Frequency [MHz]	RefLevel[dBm]	Result[dBm]	Limit[dBm]	Verdict
BLE_1M	Low	2402	-0.64	-40.24	≤-30.64	PASS
	High	2480	1.23	-40.63	≤-28.77	PASS

Test Result for Spurious Emission :

TestMode	Frequency [MHz]	FreqRange [MHz]	RefLevel [dBm]	Result[dBm]	Limit[dBm]	Verdict
BLE_1M	2402	30~1000	-0.64	-50.77	≤-30.64	PASS
		1000~3000	-0.64	-48.2	≤-30.64	PASS
		3000~5000	-0.64	-46.28	≤-30.64	PASS
		5000~7000	-0.64	-47.95	≤-30.64	PASS
		7000~9000	-0.64	-49.11	≤-30.64	PASS
		9000~11000	-0.64	-47.1	≤-30.64	PASS
		11000~13000	-0.64	-48.74	≤-30.64	PASS
		13000~15000	-0.64	-43.64	≤-30.64	PASS
		15000~17000	-0.64	-42.01	≤-30.64	PASS
		17000~19000	-0.64	-41.49	≤-30.64	PASS
		19000~21000	-0.64	-40.01	≤-30.64	PASS
		21000~23000	-0.64	-39.78	≤-30.64	PASS
	23000~25000	-0.64	-38.16	≤-30.64	PASS	
	2440	30~1000	0.23	-50.32	≤-29.77	PASS
		1000~3000	0.23	-48.89	≤-29.77	PASS
		3000~5000	0.23	-47.1	≤-29.77	PASS
		5000~7000	0.23	-47.44	≤-29.77	PASS
		7000~9000	0.23	-47.71	≤-29.77	PASS
		9000~11000	0.23	-48.36	≤-29.77	PASS
		11000~13000	0.23	-48.24	≤-29.77	PASS
		13000~15000	0.23	-43.57	≤-29.77	PASS
		15000~17000	0.23	-41.9	≤-29.77	PASS
		17000~19000	0.23	-41.5	≤-29.77	PASS
		19000~21000	0.23	-39.9	≤-29.77	PASS
		21000~23000	0.23	-38.9	≤-29.77	PASS
	23000~25000	0.23	-38.83	≤-29.77	PASS	
	2480	30~1000	1.23	-50.51	≤-28.77	PASS
		1000~3000	1.23	-48.86	≤-28.77	PASS
		3000~5000	1.23	-46.76	≤-28.77	PASS
		5000~7000	1.23	-47.71	≤-28.77	PASS

	7000~9000	1.23	-49.21	≤-28.77	PASS
	9000~11000	1.23	-47.13	≤-28.77	PASS
	11000~13000	1.23	-48.3	≤-28.77	PASS
	13000~15000	1.23	-44.04	≤-28.77	PASS
	15000~17000	1.23	-42.25	≤-28.77	PASS
	17000~19000	1.23	-41.36	≤-28.77	PASS
	19000~21000	1.23	-40.12	≤-28.77	PASS
	21000~23000	1.23	-40.07	≤-28.77	PASS
	23000~25000	1.23	-37.83	≤-28.77	PASS

Test Graphs for Reference level :

BLE_1M_Ant1_2402



BLE_1M_Ant1_2440



BLE_1M_Ant1_2480



Test Graphs for Band edge :

BLE_1M_Ant1_Low_2402

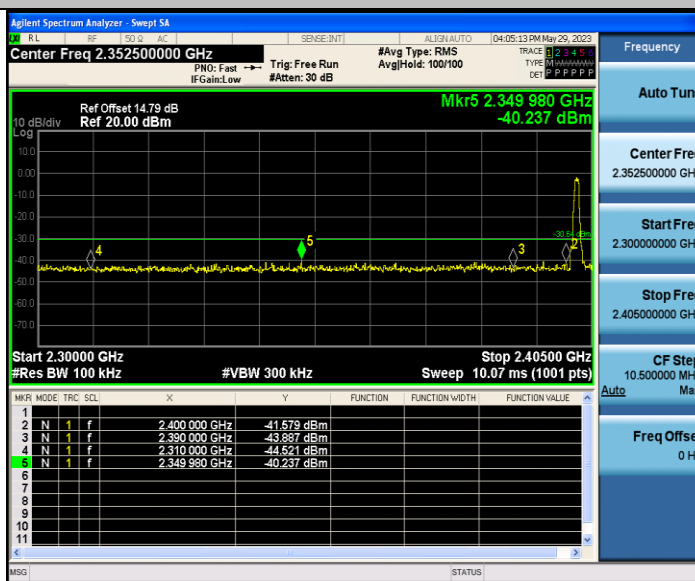

BLE_1M_Ant1_High_2480

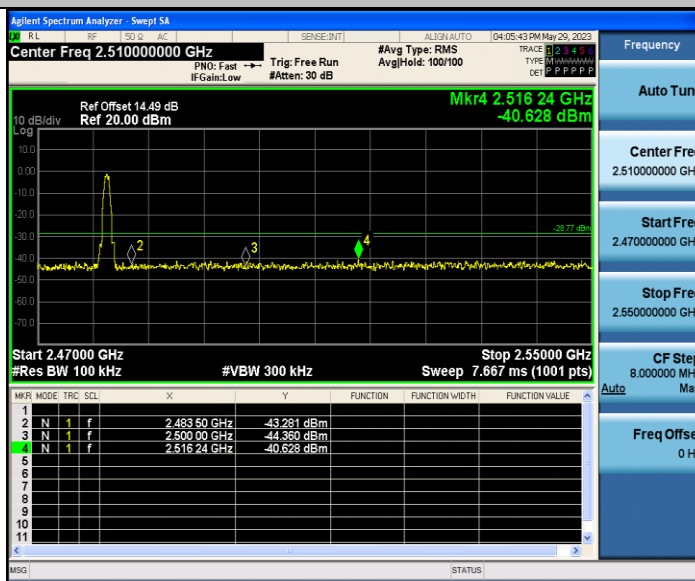

Test Graphs for Spurious Emission :

BLE_1M_Ant1_2402_30~1000

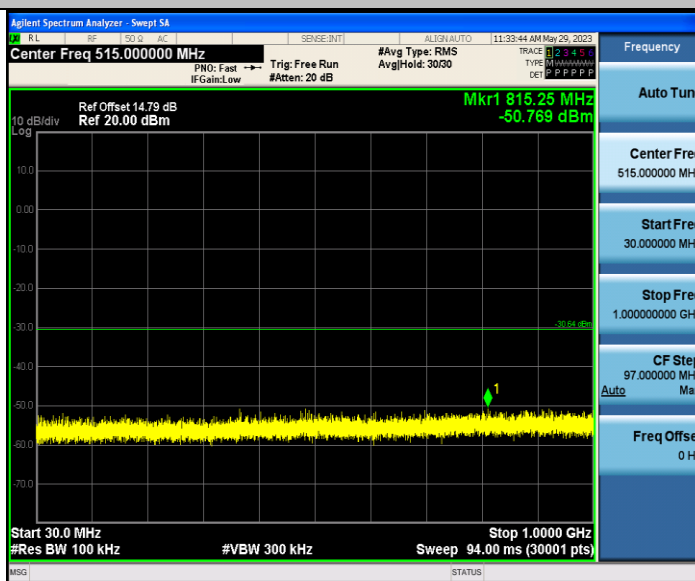

BLE_1M_Ant1_2402_1000~3000

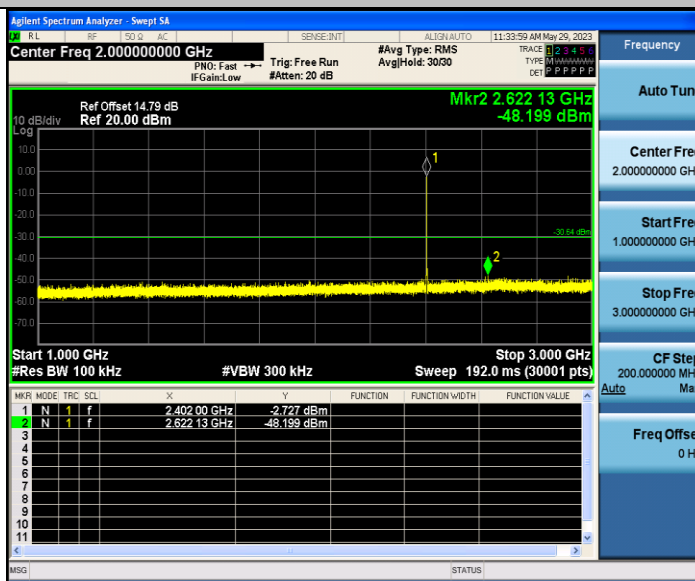

BLE_1M_Ant1_2402_3000~5000

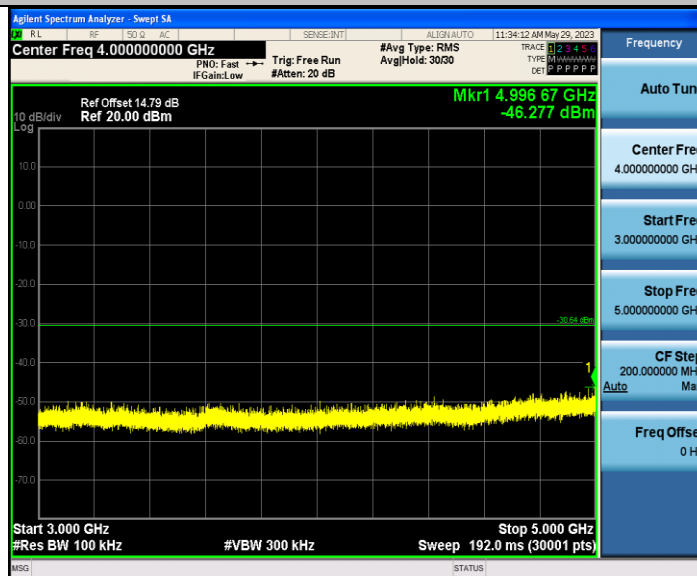

BLE_1M_Ant1_2402_5000~7000

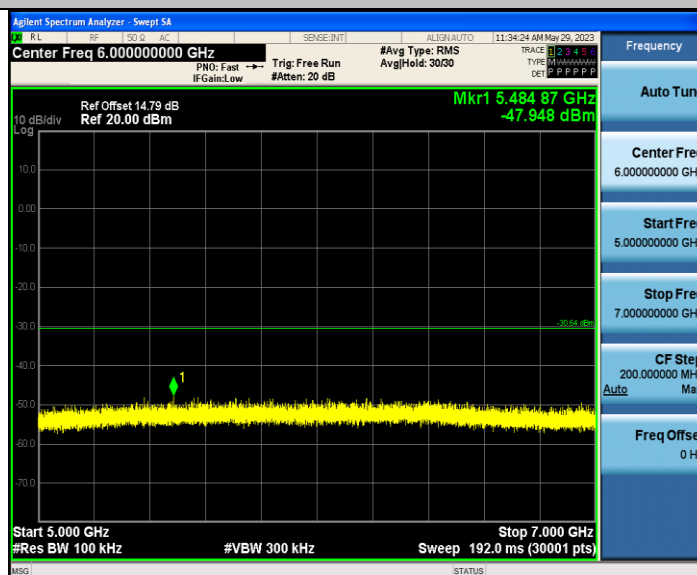

BLE_1M_Ant1_2402_7000~9000

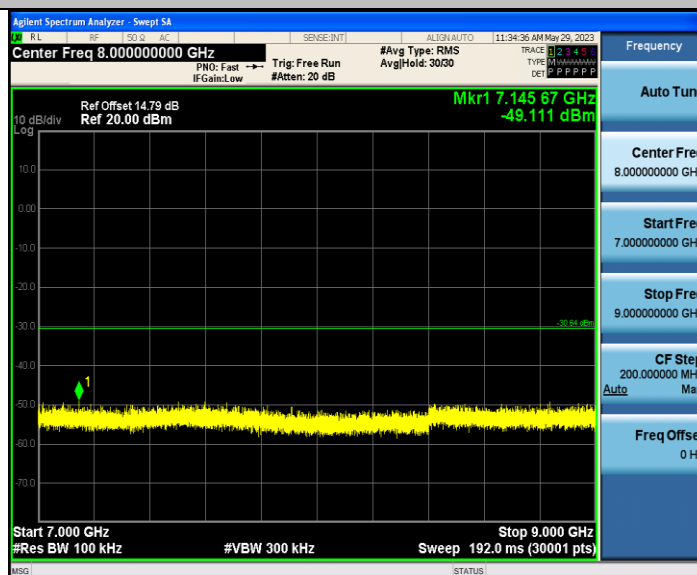

BLE_1M_Ant1_2402_9000~11000

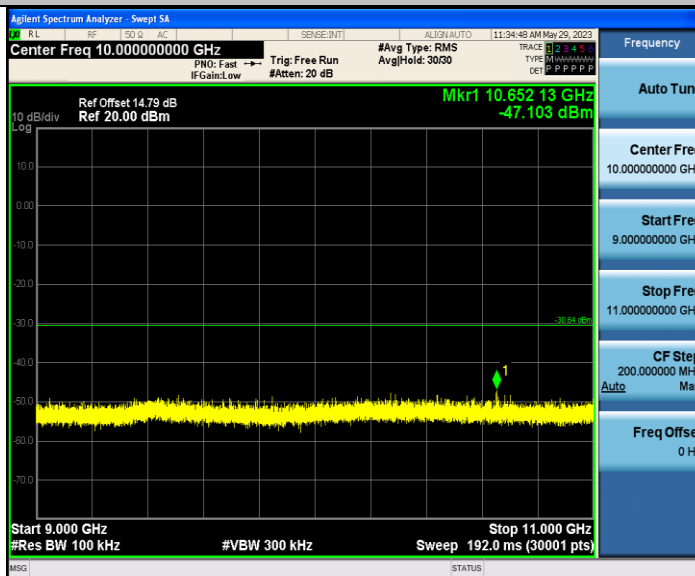

BLE_1M_Ant1_2402_11000~13000

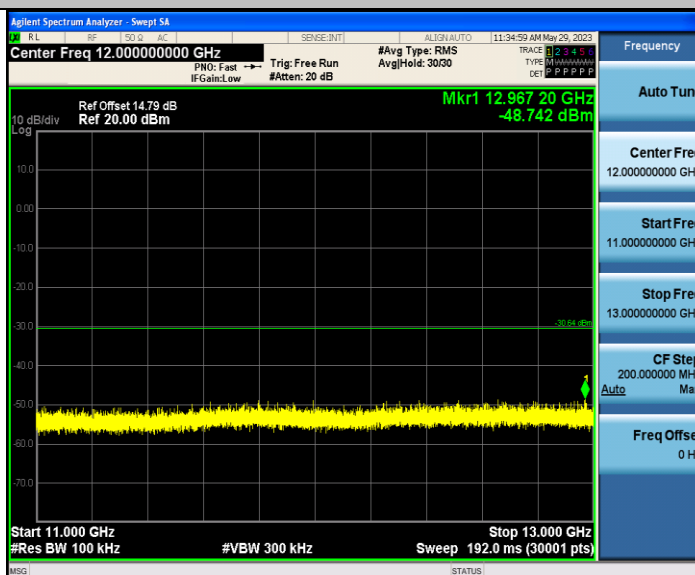

BLE_1M_Ant1_2402_13000~15000

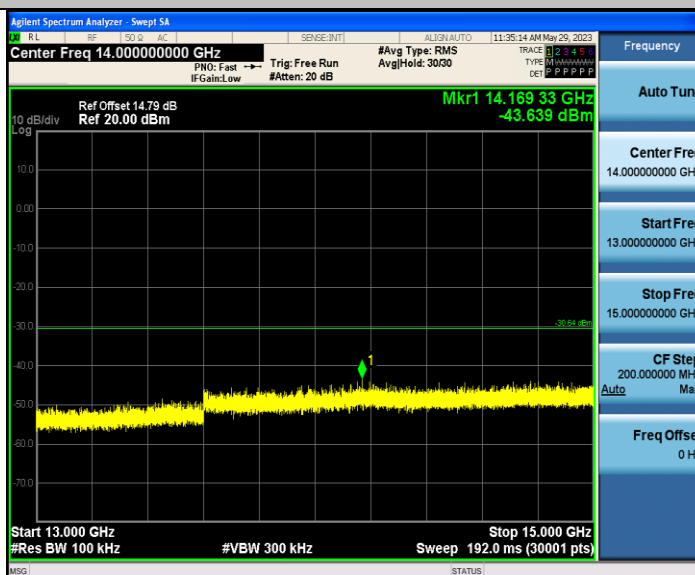

BLE_1M_Ant1_2402_15000~17000

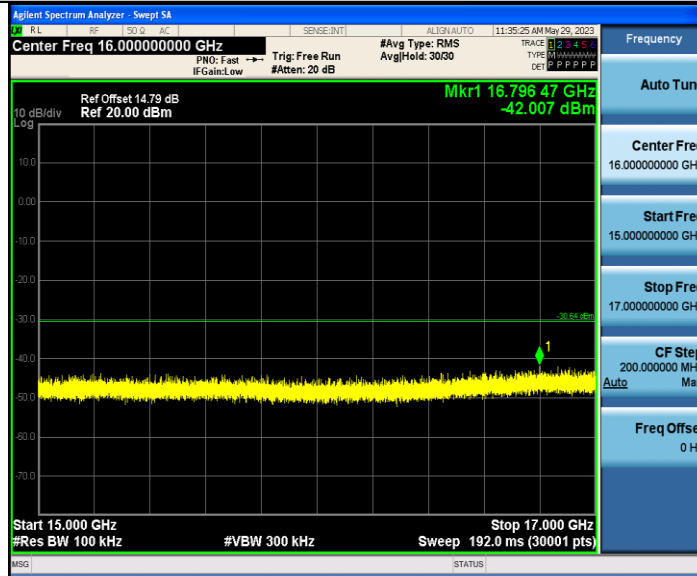

BLE_1M_Ant1_2402_17000~19000

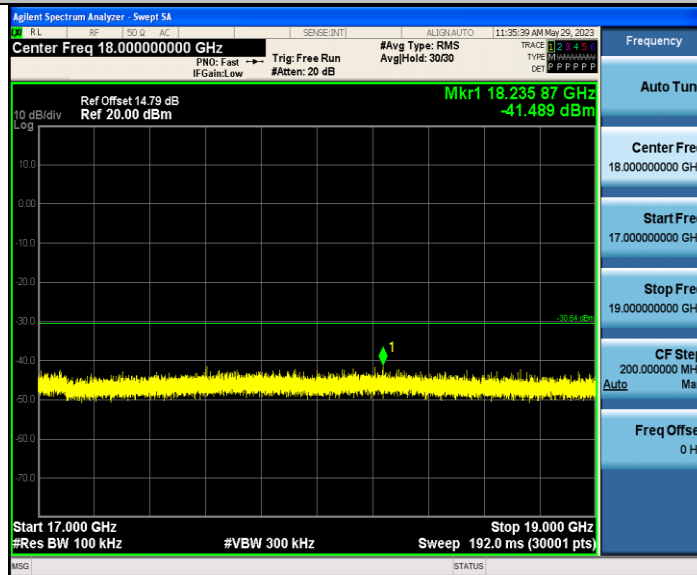

BLE_1M_Ant1_2402_19000~21000

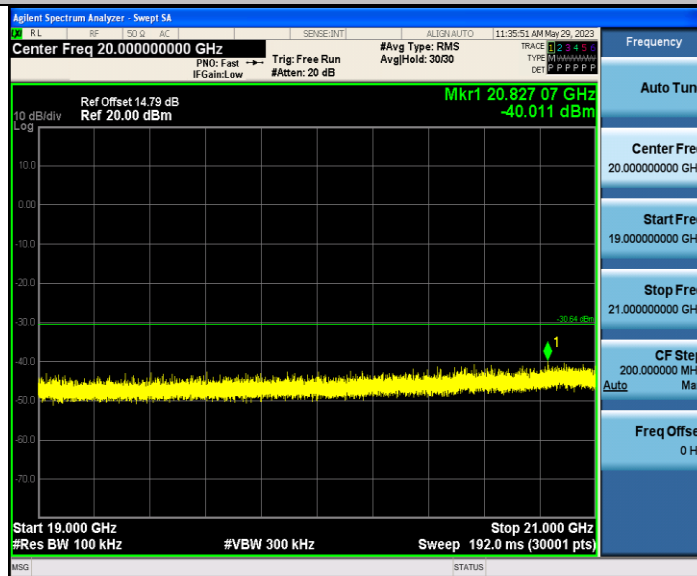

BLE_1M_Ant1_2402_21000~23000

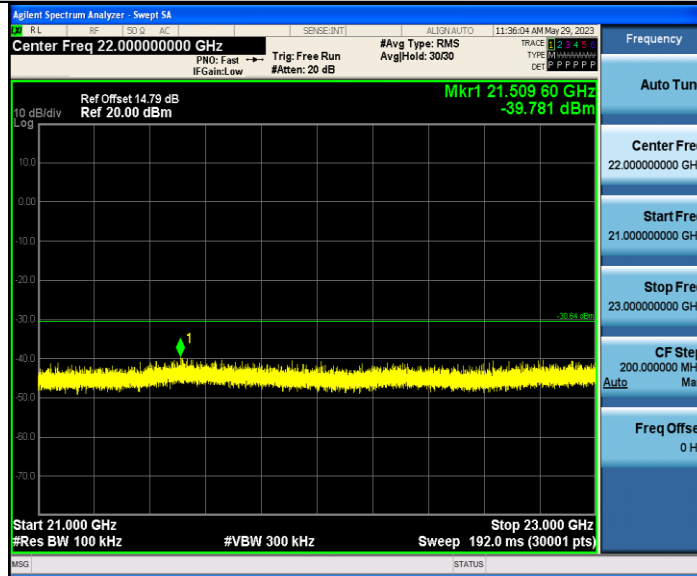

BLE_1M_Ant1_2402_23000~25000

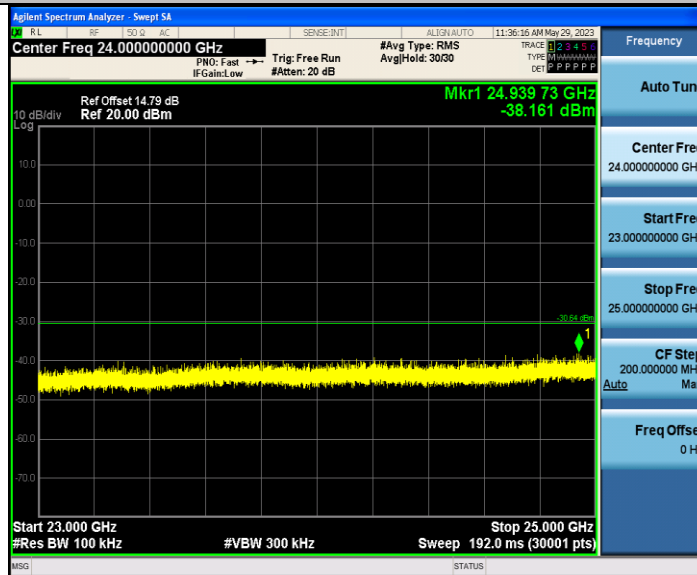

BLE_1M_Ant1_2440_30~1000

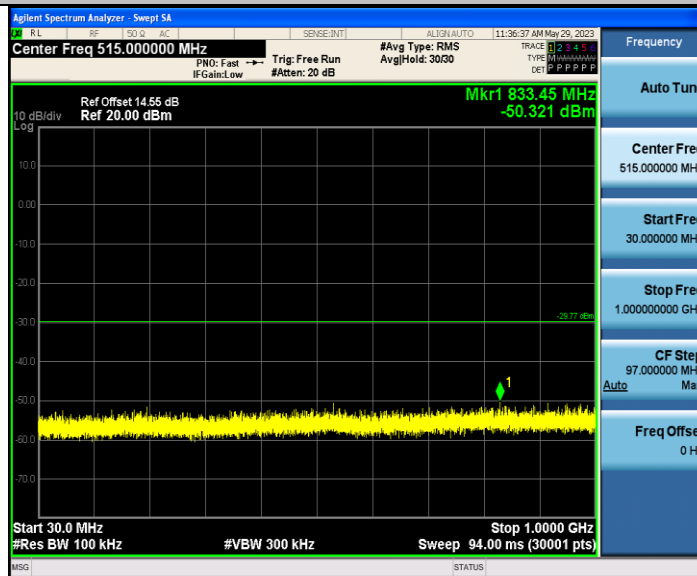

BLE_1M_Ant1_2440_1000~3000

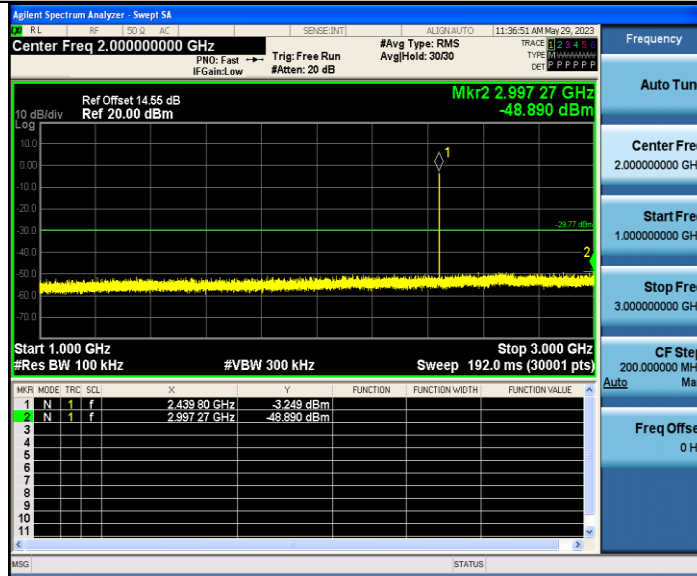

BLE_1M_Ant1_2440_3000~5000

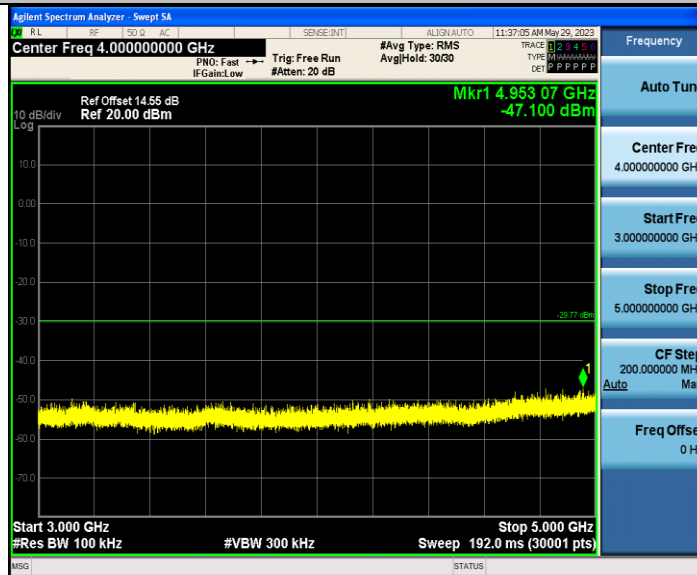

BLE_1M_Ant1_2440_5000~7000

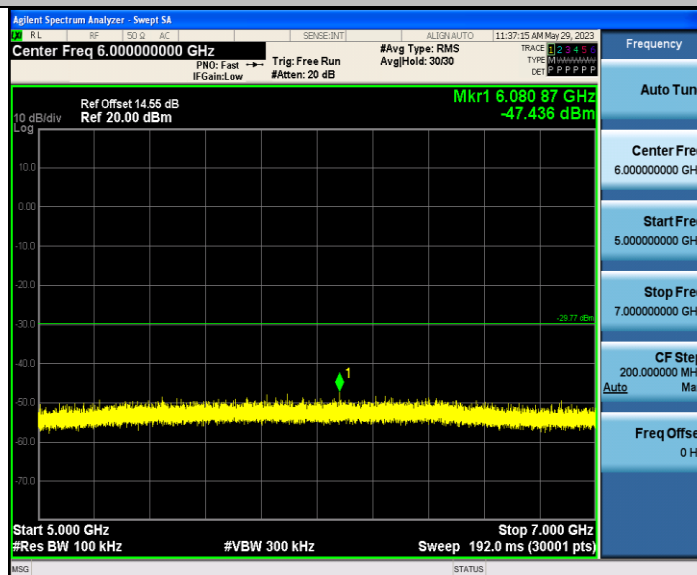

BLE_1M_Ant1_2440_7000~9000

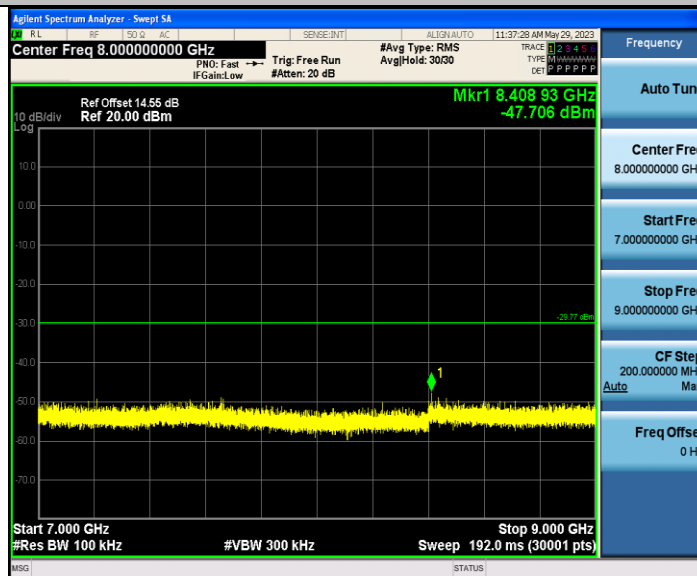

BLE_1M_Ant1_2440_9000~11000

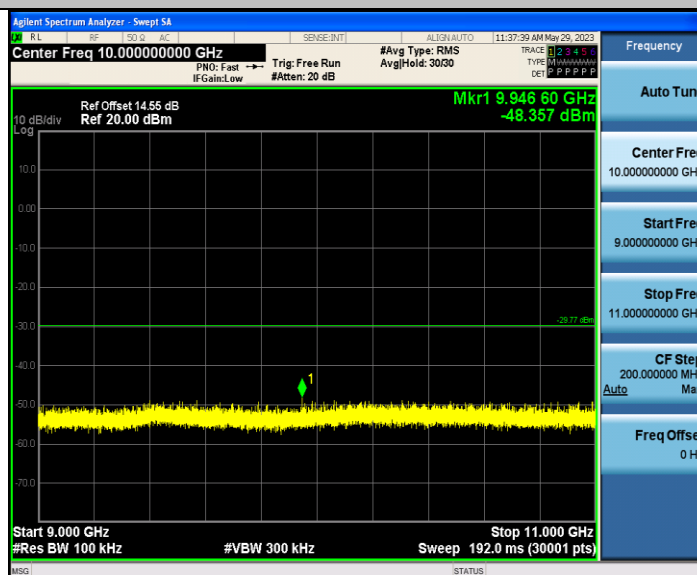

BLE_1M_Ant1_2440_11000~13000

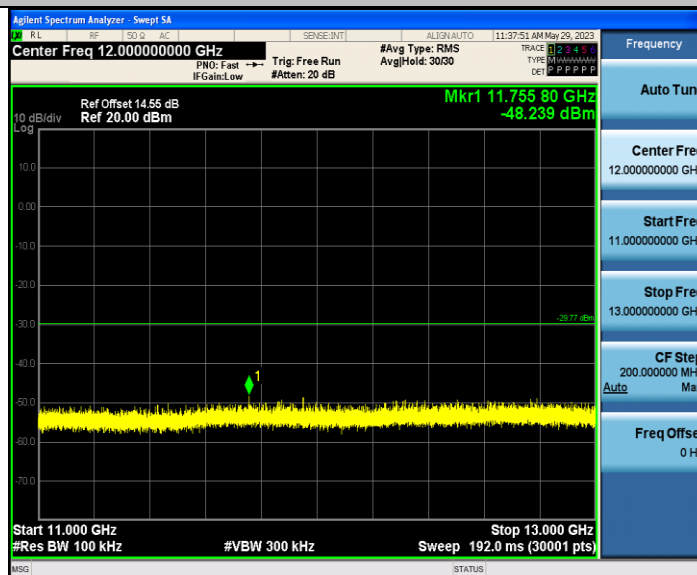

BLE_1M_Ant1_2440_13000~15000

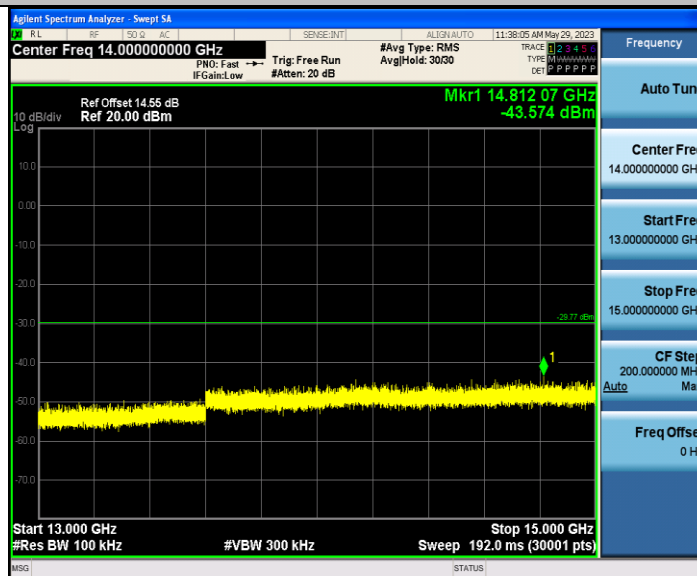

BLE_1M_Ant1_2440_15000~17000

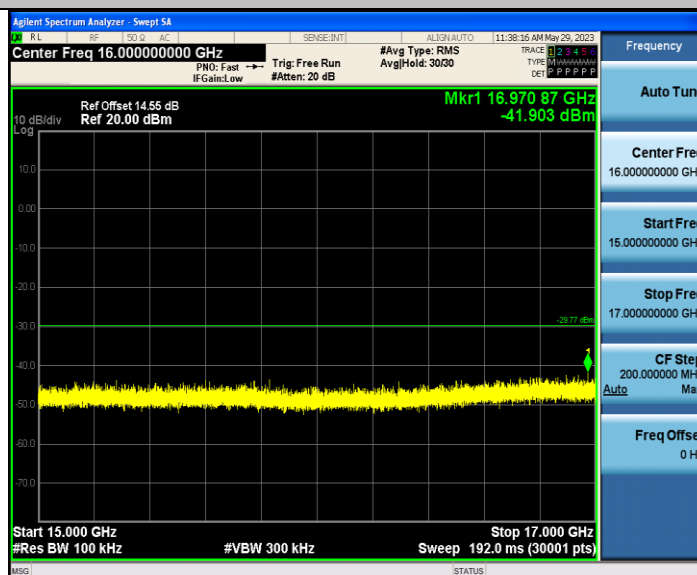

BLE_1M_Ant1_2440_17000~19000

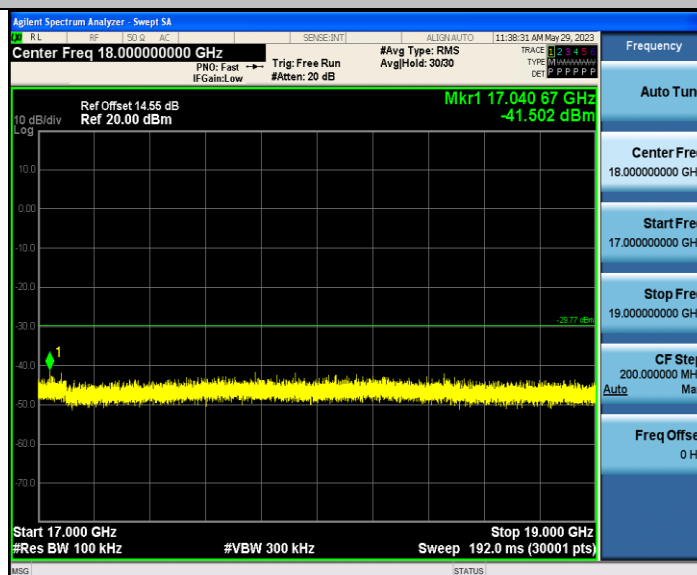

BLE_1M_Ant1_2440_19000~21000



BLE_1M_Ant1_2440_21000~23000

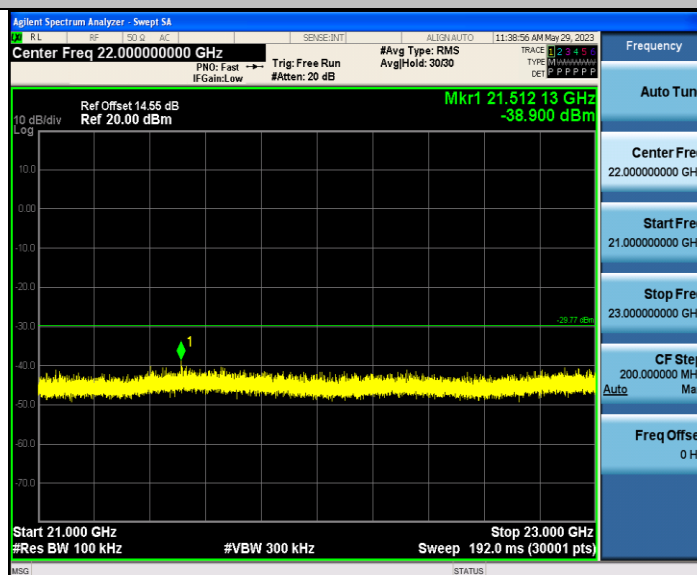

BLE_1M_Ant1_2440_23000~25000

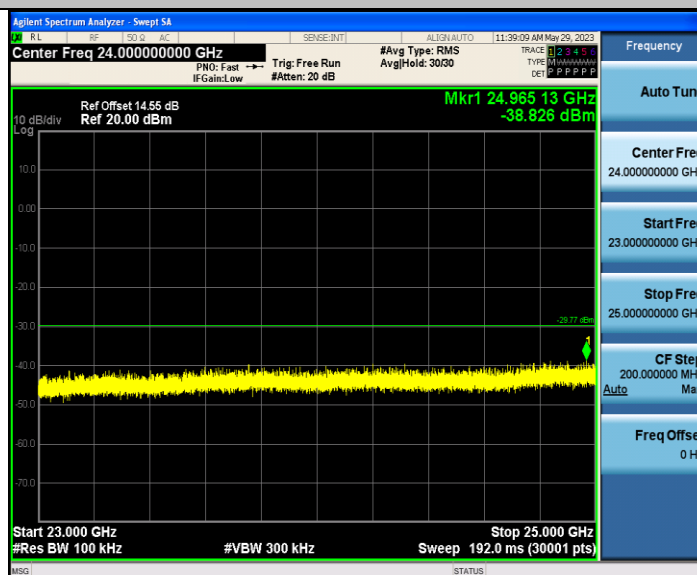

BLE_1M_Ant1_2480_30~1000

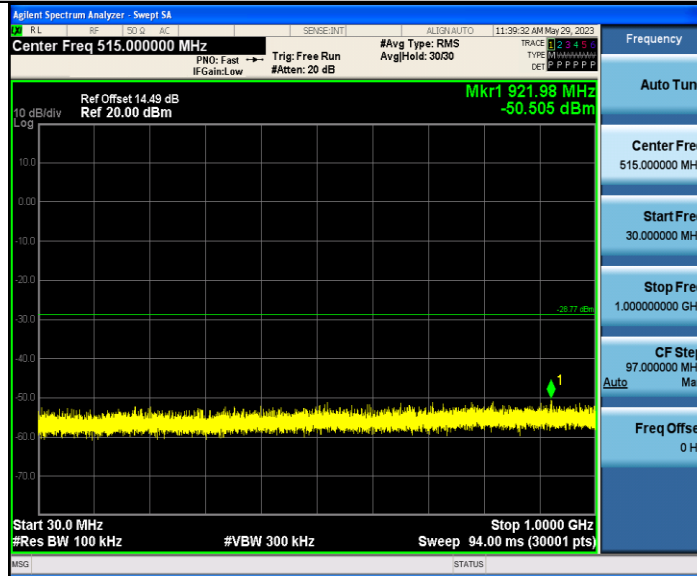

BLE_1M_Ant1_2480_1000~3000

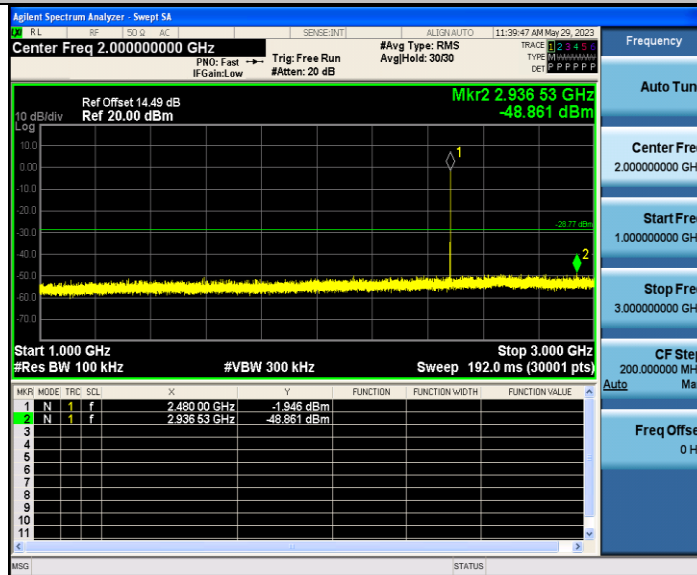

BLE_1M_Ant1_2480_3000~5000

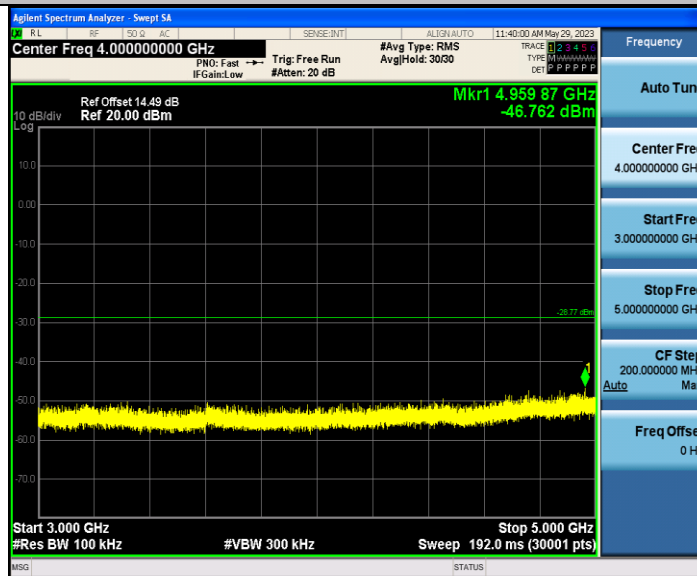

BLE_1M_Ant1_2480_5000~7000

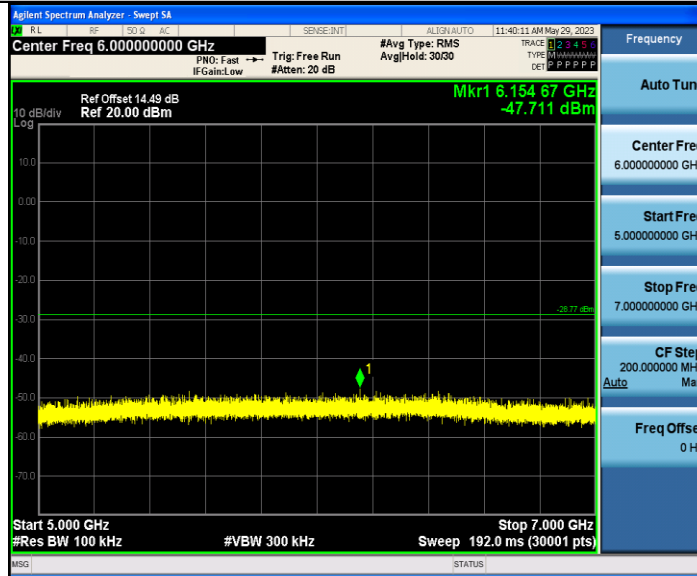

BLE_1M_Ant1_2480_7000~9000

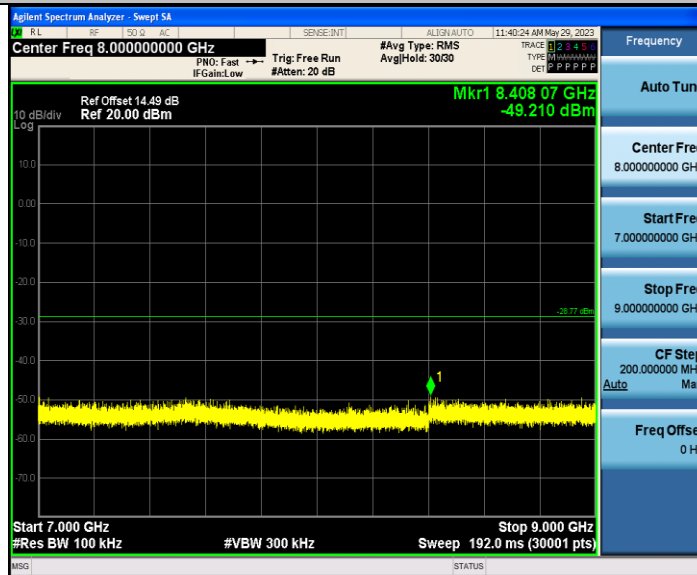

BLE_1M_Ant1_2480_9000~11000

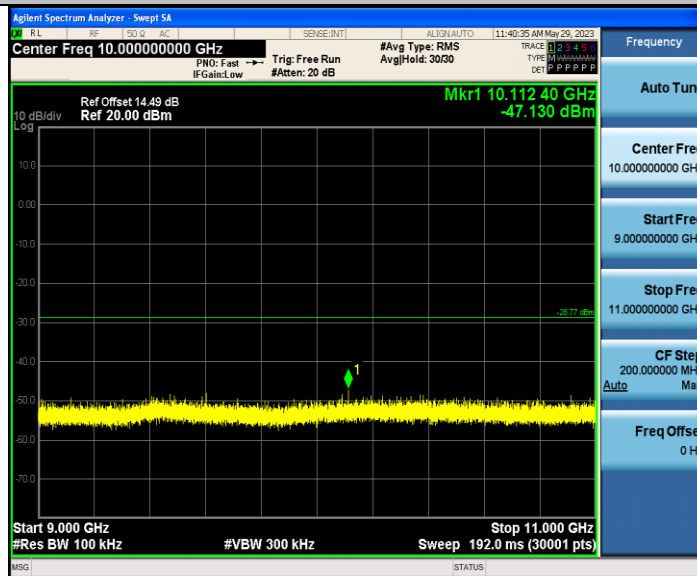

BLE_1M_Ant1_2480_11000~13000

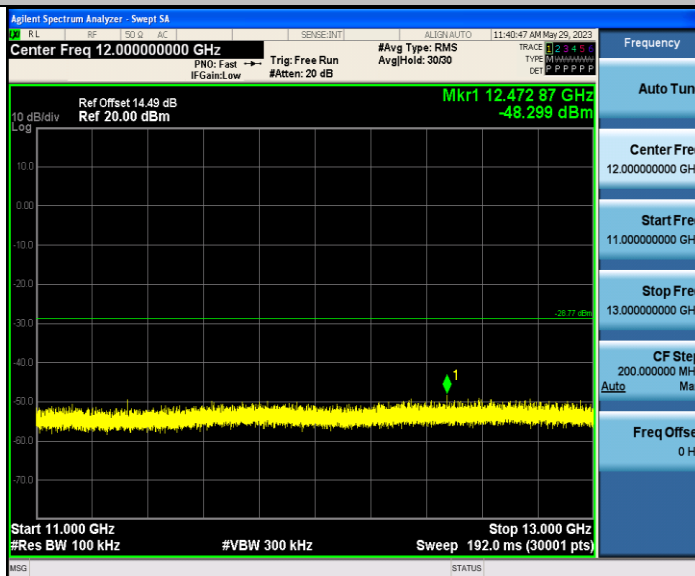

BLE_1M_Ant1_2480_13000~15000

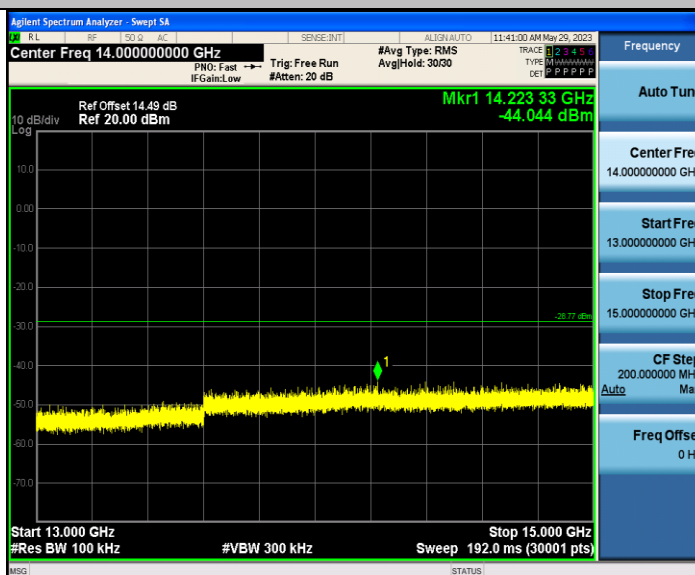

BLE_1M_Ant1_2480_15000~17000

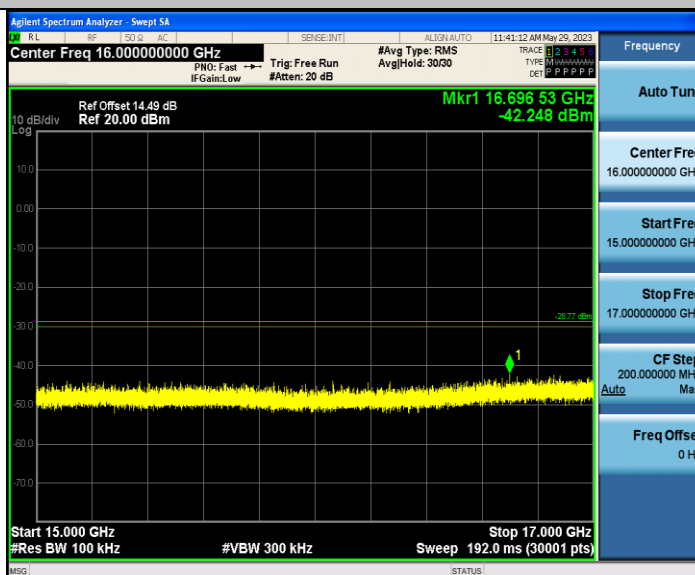

BLE_1M_Ant1_2480_17000~19000

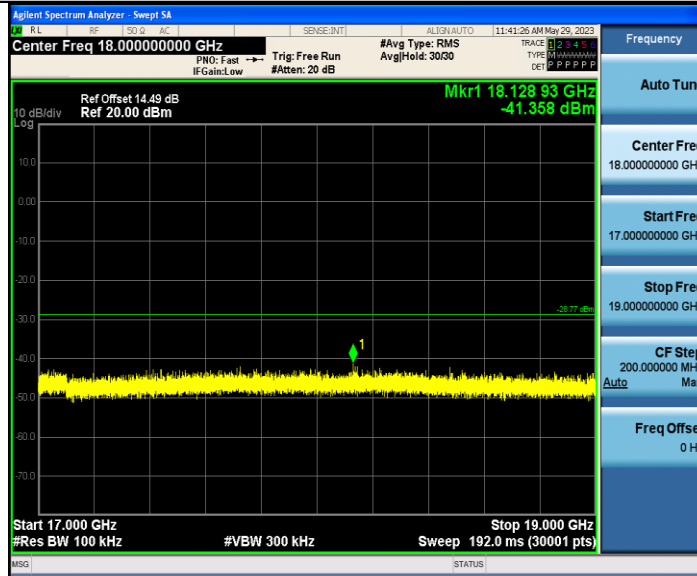

BLE_1M_Ant1_2480_19000~21000

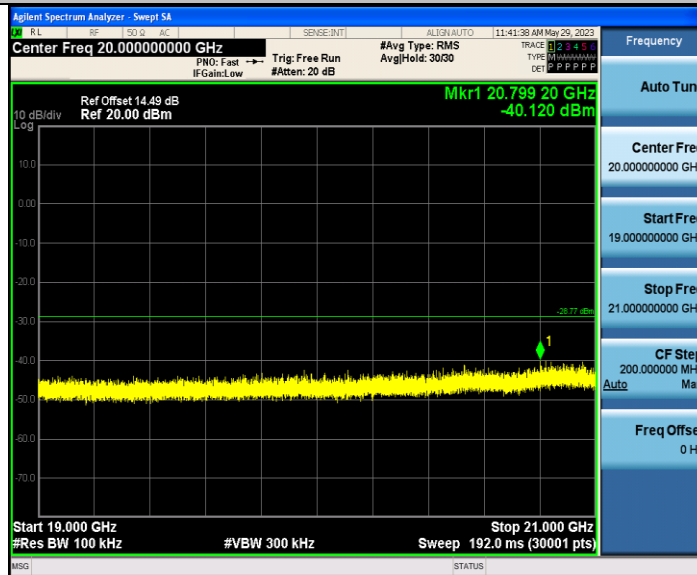

BLE_1M_Ant1_2480_21000~23000

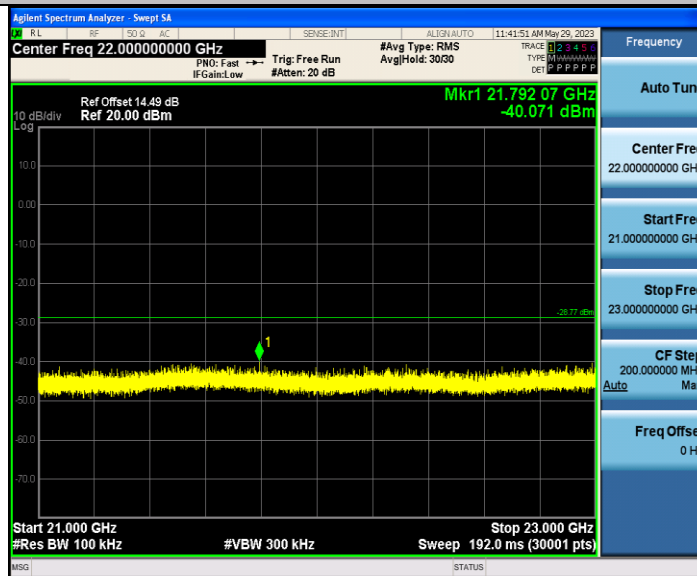

BLE_1M_Ant1_2480_23000~25000

