



Test report No:
2340773R-RF-US-P06V01

FCC & ISED TEST REPORT

Product Name	Barcode Scanner
Trademark	Honeywell
Model and /or type reference	1962
FCC ID	HD5-1962A
IC	1693B-1962A
Applicant's name / address	HONEYWELL INTERNATIONAL INC Honeywell Safety and Productivity Solutions 9680 OLD BAILES RD FORT MILL SC 29707-7539,USA
Test method requested, standard	CFR 47, FCC Part 15 C ANSI C63.10: 2013 RSS-Gen / RSS-247
Verdict Summary	IN COMPLIANCE
Tested by (name / position & signature)	Jun Xu/ Project Engineer 
Approved by (name / position & signature)	Jack Zhang/ Manager 
Date of issue	2023-06-05
Report Version	V1.0
Report template No	Template_FCC 15.247-RF-V1.0

INDEX

	page
General conditions	5
Environmental conditions	5
Possible test case verdicts	6
Abbreviations.....	6
Document History.....	7
Remarks and Comments	7
Used Equipment.....	8
Uncertainty	10
1 General Information	11
1.1 General Description of the Item(s).....	11
1.2 Antenna Information	12
1.3 Channel List.....	13
2 Description of Test Setup.....	14
2.1 Operating mode(s) used for tests	14
2.2 Auxiliary equipment /Accessories/Test software for the EUT	14
2.3 Test Configuration / Block diagram used for tests.....	15
2.4 Testing process	16
3 Verdict summary section.....	17
3.1 Standards	17
3.2 Deviation(s) from the Standard(s) / Test Specification(s).....	17
3.3 Overview of results	18
3.4 Power setting in test	20
3.5 Test Matrix	21
3.6 Test Facility.....	22
4 Test Items of limit/setup/procedure.....	23
4.1 20dB Emission Bandwidth.....	23
4.1.1 Limit	23
4.1.2 Test Setup	23
4.1.3 Test Procedure	23
4.2 Occupied Channel Bandwidth	24
4.2.1 Limit	24
4.2.1 Test Setup	24
4.2.3 Test Procedure	24
4.3 Maximum Conducted Output Power.....	25

4.3.1	Limit	25
4.3.2	Test Setup	25
4.3.3	Test Procedure	25
4.4	Carrier Frequency Separation	26
4.4.1	Limit	26
4.4.2	Test Setup	26
4.4.3	Test Procedure	26
4.5	Time of Occupancy.....	27
4.5.1	Limit	27
4.5.2	Test Setup	27
4.5.3	Test Procedure	27
4.6	Number of hopping Frequencies	28
4.6.1	Limit	28
4.6.2	Test Setup	28
4.6.3	Test Procedure	28
4.7	Band edge measurements	29
4.7.1	Limit	29
4.7.2	Test Setup	29
4.7.3	Test Procedure	29
4.8	Conducted Spurious Emission	30
4.8.1	Limit	30
4.8.2	Test Setup	30
4.8.3	Test Procedure	30
4.9	Duty cycle	31
4.9.1	Limit	31
4.9.2	Test Setup	31
4.9.3	Test Procedure	31
4.10	Emissions in Restricted Bands	32
4.10.1	Limit	32
4.10.2	Test Setup	34
4.10.3	Test Procedure	35
4.11	AC Power Line Conducted Emission.....	36
4.11.1	Limit	36
4.11.2	Test Setup	36
4.11.3	Test Procedure	36
4.12	Antenna Requirement.....	37
4.12.1	Limit	37

4.12.2 Antenna Connector Construction:	37
5 Test setup photo and EUT Photo	38
6 Test Result	39
Appendix A: 20dB Emission Bandwidth.....	39
Appendix B: Occupied Channel Bandwidth	43
Appendix C: Maximum conducted output power	47
Appendix D: Carrier frequency separation.....	48
Appendix E: Time of occupancy	50
Appendix F: Number of hopping channels.....	52
Appendix G: Band edge measurements.....	54
Appendix H: Conducted Spurious Emission	78
Appendix I: Duty Cycle.....	130
Appendix J: Emissions in Restricted Band	134

COMPETENCES AND GUARANTEES

DEKRA is a testing laboratory competent to carry out the tests described in this report.

In order to assure the traceability to other national and international laboratories, DEKRA has a calibration and maintenance program for its measurement equipment.

DEKRA guarantees the reliability of the data presented in this report, which is the result of the measurements and the tests performed to the item under test on the date and under the conditions stated in the report and it is based on the knowledge and technical facilities available at DEKRA at the time of performance of the test.

DEKRA is liable to the client for the maintenance of the confidentiality of all information related to the item under test and the results of the test.

The results presented in this Test Report apply only to the particular item under test established in this document.

IMPORTANT: No parts of this report may be reproduced or quoted out of context, in any form or by any means, except in full, without the previous written permission of DEKRA.

GENERAL CONDITIONS

Test Location	No. 99, Hongye Road, Suzhou Industrial Park Suzhou, 215006, P.R. China
Date(receive sample)	Apr. 27, 2023
Date (start test)	Apr. 28, 2023
Date (finish test)	May. 29, 2023

1. This report is only referred to the item that has undergone the test.
2. This report does not constitute or imply on its own an approval of the product by the Certification Bodies or Competent Authorities.
3. This document is only valid if complete; no partial reproduction can be made without previous written permission of DEKRA.
4. This test report cannot be used partially or in full for publicity and/or promotional purposes without previous written permission of DEKRA.

ENVIRONMENTAL CONDITIONS

The climatic conditions during the tests are within the limits specified by the manufacturer for the operation of the EUT and the test equipment. The climatic conditions during the tests were within the following limits:

Ambient temperature	15 °C – 35 °C
Relative Humidity air	30% - 60%

If explicitly required in the basic standard or applied product / product family standard the climatic values are recorded and documented separately in this test report.

POSSIBLE TEST CASE VERDICTS

Test case does not apply to test object	N/A
Test object does meet requirement	P (Pass) / PASS
Test object does not meet requirement	F (Fail) / FAIL
Not measured	N/M

ABBREVIATIONS

For the purposes of the present document, the following abbreviations apply:

EUT	: Equipment Under Test
QP	: Quasi-Peak
CAV	: CISPR Average
AV	: Average
CDN	: Coupling Decoupling Network
SAC	: Semi-Anechoic Chamber
OATS	: Open Area Test Site
BW	: Bandwidth
AM	: Amplitude Modulation
PM	: Pulse Modulation
HCP	: Horizontal Coupling Plane
VCP	: Vertical Coupling Plane
U_N	: Nominal voltage
T_x	: Transmitter
R_x	: Receiver
N/A	: Not Applicable
N/M	: Not Measured

DOCUMENT HISTORY

Report No.	Version	Description	Issued Date
2340773R-RF-US-P06V01	V1.0	Initial issue of report.	2023-06-05

REMARKS AND COMMENTS

1. The equipment under test (EUT) does meet the essential requirements of the stated standard(s)/test(s).
2. These test results on a sample of the device are for the purpose of demonstrating Compliance with Part 15 Subpart C Paragraph 15.247, RSS-Gen Issue 5, RSS-247 Issue 2.
3. The measurement result is considered in conformance with the requirement if it is within the prescribed limit, It is not necessary to account the uncertainty associated with the measurement result.
4. The test results presented in this report relate only to the object tested.
5. The test report shall not be reproduced without the written approval of DEKRA Testing and Certification (Suzhou) Co., Ltd.
6. This report will not be used for social proof function in China market.
7. DEKRA declines any responsibility with the following test data provided by customer that may affect the validity of result:
 - Chapter 1.1 General Description of the Item(s);
 - Chapter 1.2 Antenna Information;
 - Chapter 1.3Channel List.

USED EQUIPMENT

Conducted Test/ TR8

Instrument	Manufacturer	Model No.	Serial No.	Cal. Date	Next Cal. Date
Wireless Connectivity Tester	R&S	CMW 270	102593	2022.05.21	2023.05.20
Wireless Connectivity Tester	R&S	CMW 270	102593	2023.05.20	2024.05.19
Coaxial Cable	N/A	N/A	2189	2022.06.09	2023.06.08
High and low temperature and fast temperature change test box	ASTUOD	ASTD-FBT-225K	N/A	2022.08.24	2023.08.23
Temperature/Humidity Meter	RTS	RTS-8S	RF08	2022.07.07	2023.07.06
Test system					
4TX MIMO Power Sensor	Keysight	X8750A	MY59400102	2023.02.25	2024.02.24
MAX Signal Analyzer	Keysight	N9020B	MY59050482	2022.09.17	2023.09.16
Switch Box	Keysight	X8749A	N/A	N/A	N/A
High and low temperature and fast temperature change test box	ASTUOD	ASTD-FBT-225K	N/A	2022.08.24	2023.08.23
MXG-B RF Vector Signal Generator	Keysight	N5182B	MY61252529	2022.07.14	2023.07.13
Frequency extender for EXG or MXG	Keysight	N5182BX07	MY59362500	2022.07.14	2023.07.13
EXG-B MW Analog Signal Generator	Keysight	N5173B	MY61252566	2022.09.28	2023.09.27

Radiated Emission(9KHz-1GHz) / AC3

Instrument	Manufacturer	Model No.	Serial No.	Cal. Date	Next Cal. Date
EMI Test Receiver	R&S	ESCI	100573	2022.07.10	2023.07.09
Bilog Antenna	Teseq GmbH	CBL6112D	27611	2022.08.28	2023.08.27
Coaxial Cable	Huber+Suhner	RG 214	AC2-C	2023.03.15	2024.03.14
Loop Antenna	R&S	HFH2-Z2	833799/003	2023.02.25	2024.02.24
Temperature/Humidity Meter	RTS	RTS-8S	AC2-TH	2022.07.07	2023.07.06

Radiated Emission (1GHz-40GHz) / AC5

Instrument	Manufacturer	Model No.	Serial No.	Cal. Date	Next Cal. Date
MXA Signal Analyzer	Keysight	N9020B	MY60112218	2022.12.08	2023.12.07
Preamplifier	Chengyi	EMC184045SE	980263	2022.07.19	2023.07.18
DRG Horn	ETS-Lindgren	3117	00123988	2022.08.29	2023.08.28
Broad-Band Horn Antenna	SCHWARZBECK	BBHA 9170	01249	2022.09.22	2023.09.21
Coaxial Cable	ROSENBERGER	LA1-C011-2000/3000	AC5-40G	2023.03.04	2024.03.03

UNCERTAINTY

Uncertainties have been calculated according to the DEKRA internal document. The reported expanded uncertainties are based on a standard uncertainty multiplied by a coverage factor of $k=2$, providing a level of confidence of approximately 95%. The Uncertainties is comply with standard required as below.

Test item	Uncertainty
AC Power Line Conducted Emission	9kHz~150kHz: 2.80dB 150kHz~30MHz: 2.40dB
Radiated Emission(30MHz~1GHz)	Horizontal: 30MHz~200MHz: 3.50 dB 300MHz~1GHz: 3.60 dB Vertical: 30MHz~200MHz: 3.60 dB 300MHz~1GHz: 3.50 dB
Radiated Emission(1GHz~26.5GHz)	Horizontal: 1GHz~18GHz: 5.00 dB Vertical: 1GHz~18GHz: 4.80 dB Horizontal: 18GHz~26.5GHz: 5.30 dB Vertical: 18GHz~26.5GHz: 4.90 dB
20dB Bandwidth	± 1 kHz
Carrier Frequency Separation	± 1 kHz
Number of Hopping Frequencies	± 1 kHz
Time of Occupancy (Dwell Time)	± 0.1 us
Peak Output Power	± 1.27 dB
Emissions in non-restricted frequency bands	± 1.0 dB
Radiated Emission Band Edge	± 3.9 dB

1 GENERAL INFORMATION

1.1 General Description of the Item(s)

Product Name	Barcode Scanner
Model No.	1962
Trademark	Honeywell
FCC ID	HD5-1962A
IC	1693B-1962A
Hardware Version	1962 ver01
Software Version	1962 ver02
Manufacturer	HONEYWELL INTERNATIONAL INC Honeywell Safety and Productivity Solutions
Manufacturer Address	9680 OLD BAILES RD FORT MILL SC 29707-7539,USA
Factory	Metro(Suzhou)Technologies Co.,Ltd
Factory address.....	No.221 Xinghai street China-Singapore Suzhou Industrial Park

Wireless specification.....	Bluetooth (BR/EDR)					
Operating frequency range(s)	2402~2480MHz					
Type of Modulation.....	GFSK					
PHYs	<input checked="" type="checkbox"/>	GFSK	<input checked="" type="checkbox"/>	Pi/4 DQPSK	<input checked="" type="checkbox"/>	8DPSK
Data Rate	<input checked="" type="checkbox"/>	1Mbit/s	<input checked="" type="checkbox"/>	2Mbit/s	<input checked="" type="checkbox"/>	3Mbit/s
Number of channel	79					

Rated power supply	Voltage and Frequency				
	<input type="checkbox"/>	AC: 220 - 240 V, 50/60 Hz			
	<input type="checkbox"/>	AC: 100 - 240 V, 50/60 Hz			
	<input type="checkbox"/>	DC: 24 Vdc			
	<input checked="" type="checkbox"/>	Battery:3.635V			
	<input type="checkbox"/>	Adapter:			
Mounting position	<input type="checkbox"/>	Tabletop equipment			
	<input type="checkbox"/>	Wall/Ceiling mounted equipment			
	<input type="checkbox"/>	Floor standing equipment			
	<input checked="" type="checkbox"/>	Hand-held/Portable equipment			
	<input type="checkbox"/>	Other:			

1.2 Antenna Information

Antenna model / type number	N/A		
Antenna serial number	N/A		
Antenna Delivery	<input checked="" type="checkbox"/>	1TX + 1RX	
	<input type="checkbox"/>	2TX + 2RX	
	<input type="checkbox"/>	Others:	
Antenna technology	<input checked="" type="checkbox"/>	SISO	
	<input type="checkbox"/>	MIMO	<input type="checkbox"/> CDD
			<input type="checkbox"/> Beam-forming
Antenna Type	<input type="checkbox"/>	External	<input type="checkbox"/> Dipole
			<input type="checkbox"/> Sectorized
			<input type="checkbox"/> Ceramic Chip
	<input checked="" type="checkbox"/>	Internal	<input type="checkbox"/> PIFA
			<input checked="" type="checkbox"/> Chip Antenna
			<input type="checkbox"/> Others.....
Antenna Gain	2.90dBi		

1.3 Channel List

Bluetooth Working Frequency of Each Channel: (For FHSS)							
Channel	Frequency	Channel	Frequency	Channel	Frequency	Channel	Frequency
00	2402 MHz	01	2403 MHz	02	2404 MHz	03	2405 MHz
04	2406 MHz	05	2407 MHz	06	2408 MHz	07	2409 MHz
08	2410 MHz	09	2411 MHz	10	2412 MHz	11	2413 MHz
12	2414 MHz	13	2415 MHz	14	2416 MHz	15	2417 MHz
16	2418 MHz	17	2419 MHz	18	2420 MHz	19	2421 MHz
20	2422 MHz	21	2423 MHz	22	2424 MHz	23	2425 MHz
24	2426 MHz	25	2427 MHz	26	2428 MHz	27	2429 MHz
28	2430 MHz	29	2431 MHz	30	2432 MHz	31	2433 MHz
32	2434 MHz	33	2435 MHz	34	2436 MHz	35	2437 MHz
36	2438 MHz	37	2439 MHz	38	2440 MHz	39	2441 MHz
40	2442 MHz	41	2443 MHz	42	2444 MHz	43	2445 MHz
44	2446 MHz	45	2447 MHz	46	2448 MHz	47	2449 MHz
48	2450 MHz	49	2451 MHz	50	2452 MHz	51	2453 MHz
52	2454 MHz	53	2455 MHz	54	2456 MHz	55	2457 MHz
56	2458 MHz	57	2459 MHz	58	2460 MHz	59	2461 MHz
60	2462 MHz	61	2463 MHz	62	2464 MHz	63	2465 MHz
64	2466 MHz	65	2467 MHz	66	2468 MHz	67	2469 MHz
68	2470 MHz	69	2471 MHz	70	2472 MHz	71	2473 MHz
72	2474 MHz	73	2475 MHz	74	2476 MHz	75	2477 MHz
76	2478 MHz	77	2479 MHz	78	2480 MHz	N/A	N/A

Note: The general description of the Item(s), antenna information and channel list in clause 1 are provided and confirmed by the client.

2 DESCRIPTION OF TEST SETUP

2.1 Operating mode(s) used for tests

During the tests the following operating mode(s) has(have) been used.

Test Mode For Bluetooth	Mode 1: Transmitter-1Mbps(GFSK_DH5)
	Mode 2: Transmitter-2Mbps(Pi/4 DQPSK_DH5)
	Mode 3: Transmitter-3Mbps(8DPSK_DH5)
	Mode 4: Transmitter-Hopping-1Mbps(GFSK_DH5)
	Mode 5: Transmitter-Hopping-2Mbps(Pi/4 DQPSK_DH5)
	Mode 6: Transmitter-Hopping-3Mbps(8DPSK_DH5)

Note 1: Regards to the frequency band operation: the lowest, middle and highest frequency channel were selected to perform the test, then shown on this report.

Note 2: For portable device, radiated tests was verified over X, Y, Z axis, and shown the worst case on this report.

2.2 Auxiliary equipment /Accessories/Test software for the EUT

Auxiliary equipment	Type / Version	Manufacturer	Supplied by
(1) CMW 270	N/A	R&S	230Vac
(2) USB Control Cable	N/A	N/A	N/A
(3) USB Control Cable	N/A	N/A	N/A
software	Type / Version	Manufacturer	Supplied by
N/A	N/A	N/A	N/A

Accessories Information	Cable		
	Length used during test [m]	Attached during test	Shielded
(2)USB Control Cable	1	<input checked="" type="checkbox"/>	<input checked="" type="checkbox"/>
(3)USB Control Cable	8	<input checked="" type="checkbox"/>	<input checked="" type="checkbox"/>

2.3 Test Configuration / Block diagram used for tests

Test setup Diagram- Conducted test

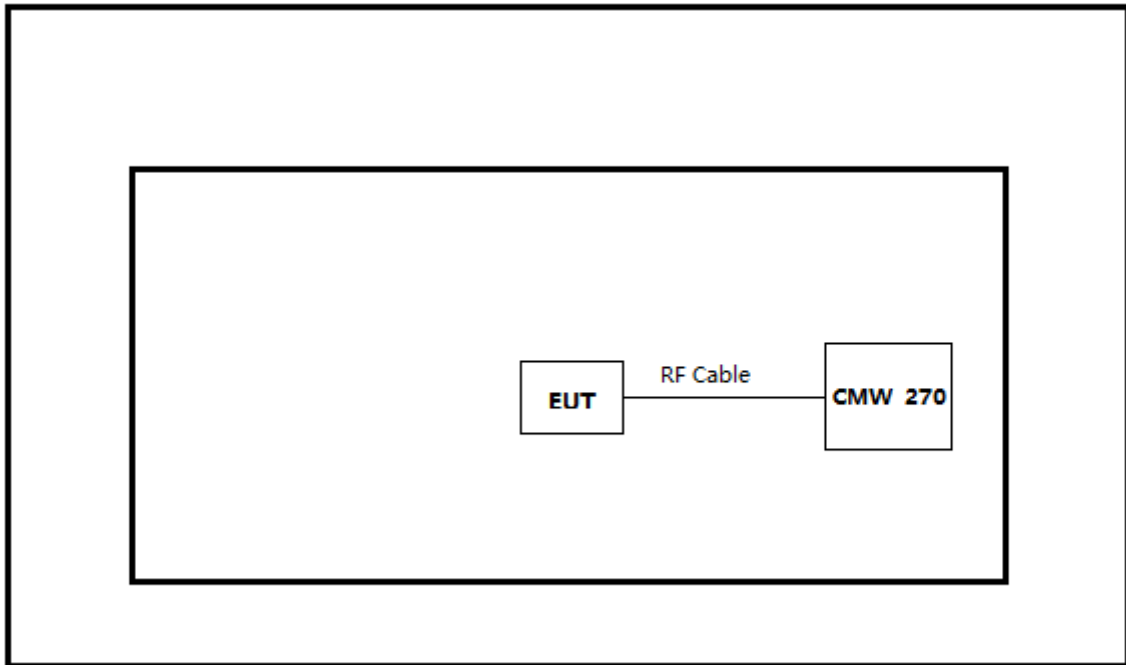

Test setup Diagram- Radiated test

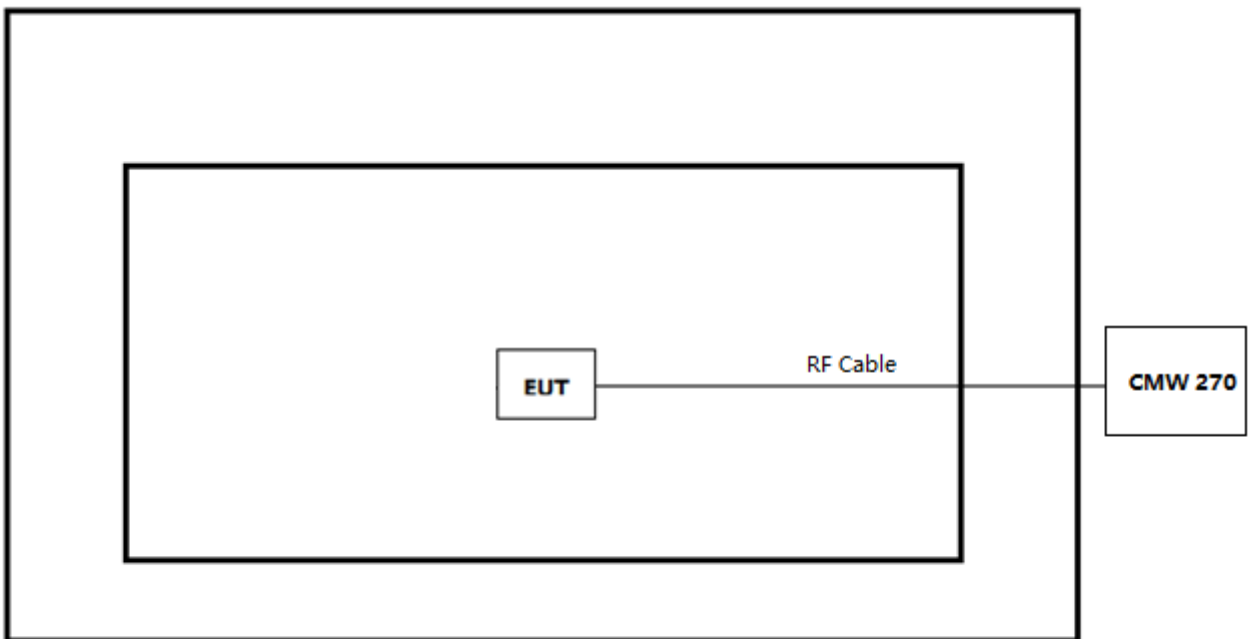

2.4 Testing process

1	Setup the EUT shown in Section 2.3.
2	Configure the test mode, the test channel, and the data rate.
3	Verify that the EUT works properly.

3 VERDICT SUMMARY SECTION

This chapter presents an overview of standards and results. Refer to the next chapters for details of measured test results and applied test levels.

3.1 Standards

Standard	Year	Description
CFR 47, FCC Part 15 C	2023	Operation within the bands 902–928 MHz, 2400–2483.5 MHz, and 5725–5850 MHz.
CFR 47, FCC Part 15 A	2023	Measurement detector functions and bandwidths.
ANSI C63.10	2013	American National Standard of Procedures for Compliance Testing of Unlicensed Wireless Devices
RSS-Gen Issue 5 Amendment 1	2019	General Requirements for Compliance of Radio Apparatus
RSS-247 Issue 2	2017	Digital Transmission Systems (DTSs), Frequency Hopping Systems (FHSs) and Licence-Exempt Local Area Network (LE-LAN) Devices

3.2 Deviation(s) from the Standard(s) / Test Specification(s)

The following deviation(s) was / were made from the published requirements of the listed standards: N/A.

(Please define the deviations from the standard(s) if applicable)

3.3 Overview of results

Requirement – Test Item of FCC	Standard(s)	Verdict	Remark
20dB Emission Bandwidth	FCC 15.247(a)(1)	PASS	Test data please refer to Appendix A
Maximum conducted output power	FCC 15.247(b)(1)	PASS	Test data please refer to Appendix C
Carrier Frequency Separation	FCC 15.247(a)(1)	PASS	Test data please refer to Appendix D
Time of Occupancy (Dwell Time)	FCC 15.247(a)(1)(iii)	PASS	Test data please refer to Appendix E
Number of Hopping Frequencies	FCC 15.247(a)(1)(iii)	PASS	Test data please refer to Appendix F
Band edge measurements	FCC 15.247(d)	PASS	Test data please refer to Appendix G
Conducted Spurious Emission	FCC 15.247(d), FCC 15.209	PASS	Test data please refer to Appendix H
Duty Cycle	ANSI C63.10:2013	PASS	Test data please refer to Appendix I
Emissions in Restricted Bands	FCC 15.247(b)(3)	PASS	Test data please refer to Appendix J
AC Power Line Conducted Emission	FCC 15.207	N/A	Not applicable, EUT is battery operated.
Antenna Requirement	FCC 15.203	PASS	---

Requirement – Test Item of ISED	Standard(s)	Verdict	Remark
20dB Emission Bandwidth	RSS-Gen Issue 5 Paragraph 6.7 RSS-247 Issue 2 Paragraph 5.1	PASS	Test data please refer to Appendix A
Occupied Channel Bandwidth	RSS-Gen Issue 5 Paragraph 6.7 RSS-247 Issue 2 Paragraph 5.1	PASS	Test data please refer to Appendix B
Maximum conducted output power	FCC 15.247(b)(1)	PASS	Test data please refer to Appendix C
Carrier frequency separation	RSS-247 Issue 2 Paragraph 5.1	PASS	Test data please refer to Appendix D
Time of occupancy	RSS-247 Issue 2 Paragraph 5.1	PASS	Test data please refer to Appendix E
Number of Hopping Frequencies	RSS-247 Issue 2 Paragraph 5.1	PASS	Test data please refer to Appendix F
Band edge measurements	RSS-Gen Issue 5 Paragraph 8.10	PASS	Test data please refer to Appendix G
Conducted Spurious Emission	RSS-247 Issue 2 Paragraph 5.5	PASS	Test data please refer to Appendix H
Duty cycle	ANSI C63.10:2013	PASS	Test data please refer to Appendix I
Emissions in Restricted Bands	RSS-Gen Issue 5 Paragraph 8.9	PASS	Test data please refer to Appendix J
AC Power Line Conducted Emission	RSS-Gen Issue 5 Paragraph 8.8	N/A	Not applicable, EUT is battery operated.
Antenna Requirement	RSS-Gen Issue 5 Paragraph 6.8	PASS	---

3.4 Power setting in test

Mode	Channel	Frequency (MHz)	Power Setting
1Mbps (GFSK_DH5)	00	2402	85
	39	2440	85
	78	2480	85
2Mbps (Pi/4 DQPSK_DH5)	00	2402	85
	39	2440	85
	78	2480	85
3Mbps (8DPSK_DH5)	00	2402	85
	39	2440	85
	78	2480	85

3.5 Test Matrix

Test item	1962	
	1(#1)	2(#2)
20dB Emission Bandwidth	<input checked="" type="checkbox"/>	<input type="checkbox"/>
Occupied Channel Bandwidth	<input checked="" type="checkbox"/>	<input type="checkbox"/>
Maximum conducted output power	<input checked="" type="checkbox"/>	<input type="checkbox"/>
Carrier frequency separation	<input checked="" type="checkbox"/>	<input type="checkbox"/>
Time of occupancy	<input checked="" type="checkbox"/>	<input type="checkbox"/>
Number of Hopping Frequencies	<input checked="" type="checkbox"/>	<input type="checkbox"/>
Band edge measurements	<input type="checkbox"/>	<input checked="" type="checkbox"/>
Conducted Spurious Emission	<input checked="" type="checkbox"/>	<input type="checkbox"/>
Duty cycle	<input checked="" type="checkbox"/>	<input type="checkbox"/>
Emissions in Restricted Bands	<input type="checkbox"/>	<input checked="" type="checkbox"/>

3.6 Test Facility

USA : FCC Designation Number: CN1199

CA : ISED CAB identifier: CN0040

4 TEST ITEMS OF LIMIT/SETUP/PROCEDURE

4.1 20dB Emission Bandwidth	VERDICT: PASS
------------------------------------	----------------------

4.1.1 Limit	
Standard	FCC Part 15 Subpart C Paragraph 15.247(a)
<input checked="" type="checkbox"/>	For frequency hopping systems operating in 2400-2483.5 MHz band, within frequency range.
<input type="checkbox"/>	For frequency hopping systems operating in 902-928 MHz band, the maximum allowed 20 dB bandwidth of the hopping channel is 500 kHz.
<input type="checkbox"/>	For frequency hopping systems operating in 5725-5850 MHz band, the maximum 20 dB bandwidth of the hopping channel is 1 MHz.

4.1.2 Test Setup

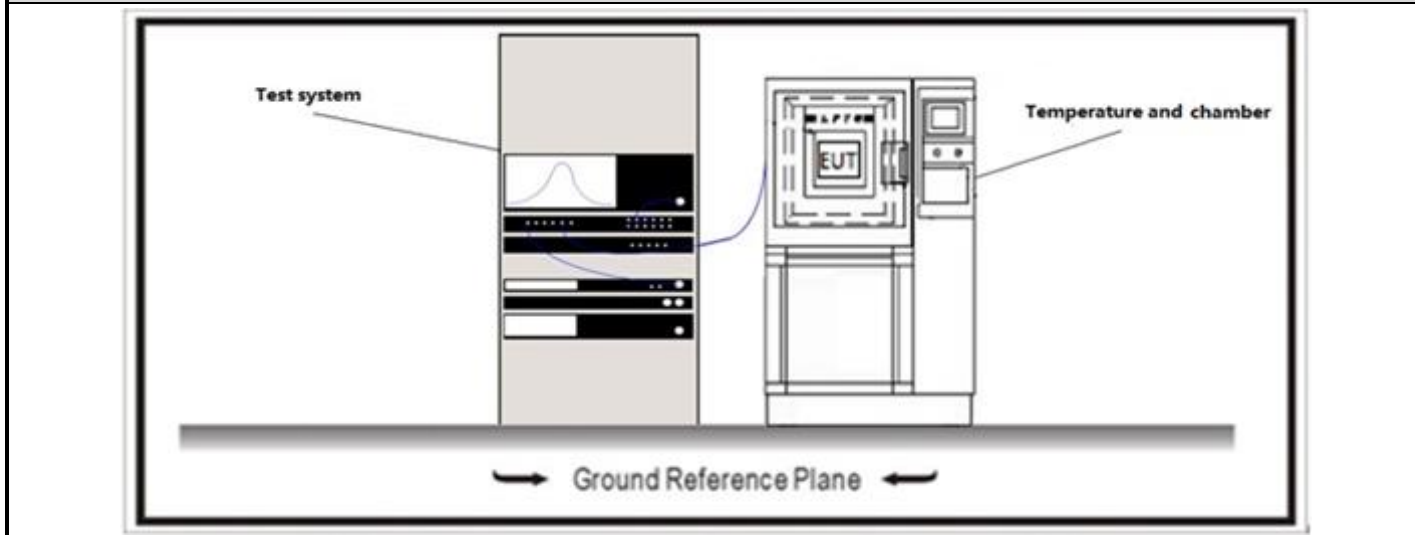

4.1.3 Test Procedure			
References Rule	Chapter	Description	
<input checked="" type="checkbox"/>	ANSI C63.10	6.9	Occupied bandwidth tests
<input checked="" type="checkbox"/>	ANSI C63.10	6.9.2	Occupied bandwidth—relative measurement procedure

4.2 Occupied Channel Bandwidth	VERDICT: PASS
---------------------------------------	----------------------

4.2.1 Limit

Standard	RSS-Gen Issue 5 Paragraph 6.7, RSS-247 Issue 2 Paragraph 5.1.
-----------------	---

The occupied bandwidth or the “99% emission bandwidth” is defined as the frequency range between two points, one above and the other below the carrier frequency, within which 99% of the total transmitted power of the fundamental transmitted emission is contained. The occupied bandwidth shall be reported for all equipment in addition to the specified bandwidth required in the applicable RSSs

4.2.1 Test Setup

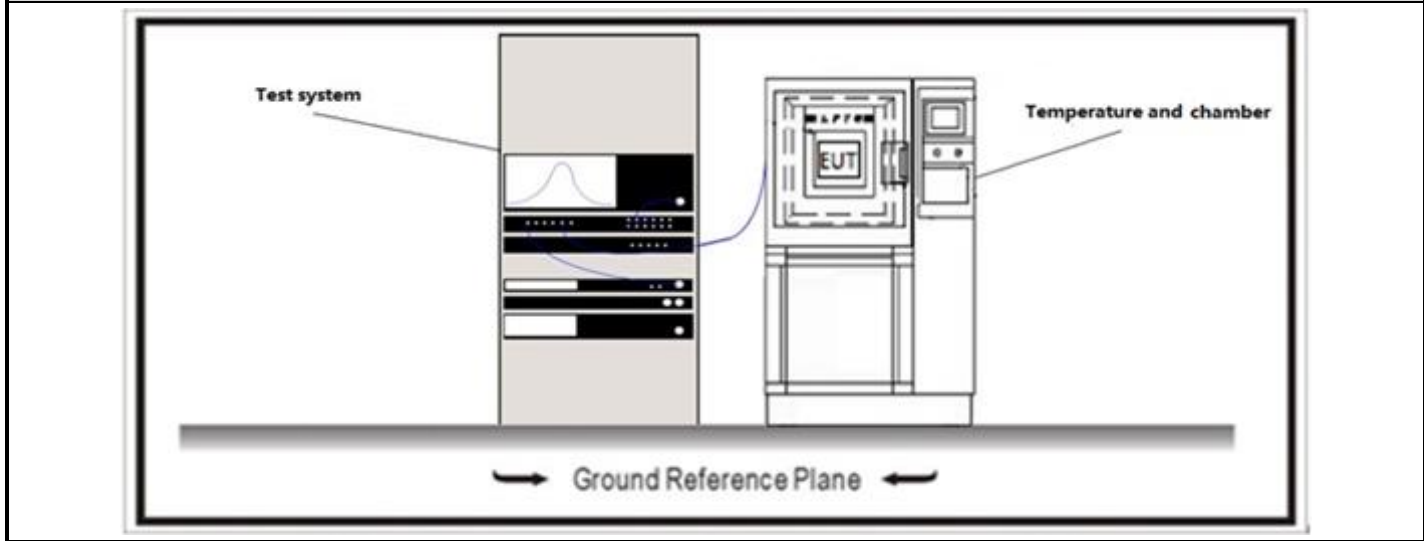

4.2.3 Test Procedure

	References Rule	Chapter	Description
<input checked="" type="checkbox"/>	ANSI C63.10	6.9	Occupied bandwidth tests
<input checked="" type="checkbox"/>	ANSI C63.10	6.9.2	Occupied bandwidth—relative measurement procedure

4.3 Maximum Conducted Output Power	VERDICT: PASS
---	----------------------

4.3.1 Limit

Standard	FCC Part 15 Subpart C Paragraph 15.247(b); RSS-247 Issue 2 Paragraph 5.1.
<input checked="" type="checkbox"/>	Frequency hopping systems operating in the 2400-2483.5 MHz band employing at least 75 non-overlapping hopping channels, and all frequency hopping systems in the 5725-5850 MHz band: 1 watt. For all other frequency hopping systems in the 2400-2483.5 MHz band: 0.125 watts.
<input checked="" type="checkbox"/>	Frequency hopping systems operating in the 2400-2483.5 MHz band may have hopping channel carrier frequencies that are separated by 25 kHz or two-thirds of the 20 dB bandwidth of the hopping channel, whichever is greater, provided the systems operate with an output power no greater than 125 mW.
<input type="checkbox"/>	For frequency hopping systems operating in the 902-928 MHz band: 1 watt for systems employing at least 50 hopping channels; and, 0.25 watts for systems employing less than 50 hopping channels, but at least 25 hopping channels

4.3.2 Test Setup

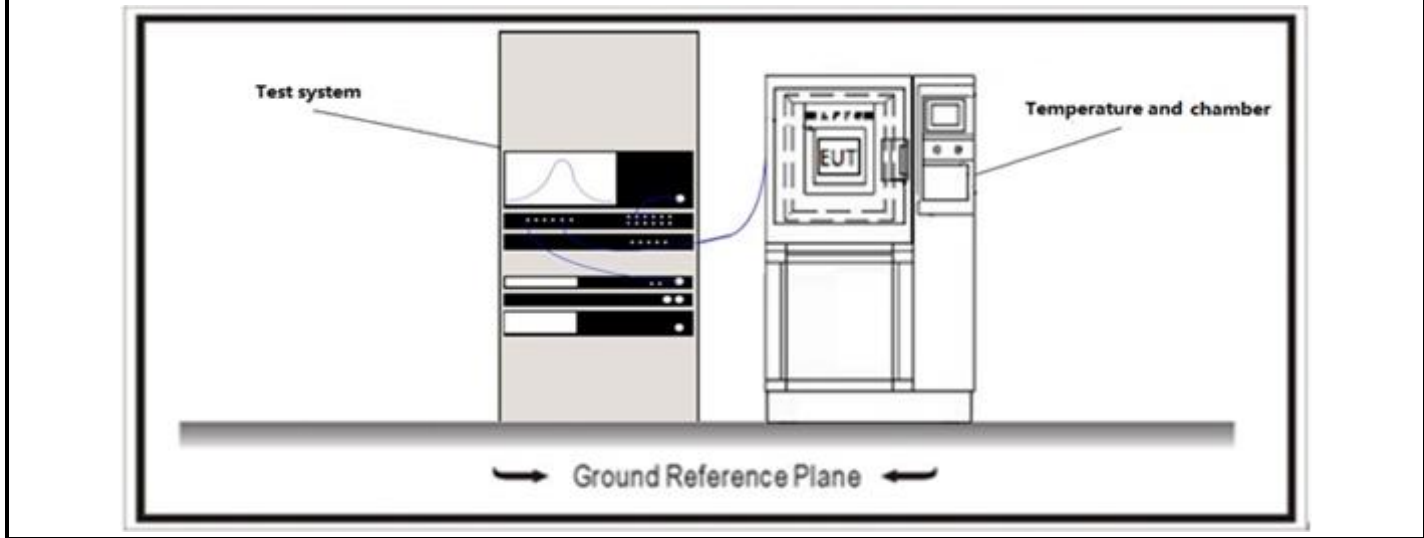

4.3.3 Test Procedure

	References Rule	Chapter	Description
<input checked="" type="checkbox"/>	ANSI C63.10	7.8	Evaluation of frequency-hopping device parameters
<input checked="" type="checkbox"/>	ANSI C63.10	7.8.5	Output power test procedure for frequency-hopping spread-spectrum (FHSS) devices

4.4 Carrier Frequency Separation	VERDICT: PASS
---	----------------------

4.4.1 Limit

Standard	FCC Part 15 Subpart C Paragraph 15.247(a); RSS-247 Issue 2 Paragraph 5.1.
<input type="checkbox"/>	Frequency hopping systems shall have hopping channel carrier frequencies separated by a minimum of 25 kHz or the 20 dB bandwidth of the hopping channel, whichever is greater.
<input checked="" type="checkbox"/>	Frequency hopping systems operating in the 2400-2483.5 MHz band may have hopping channel carrier frequencies that are separated by 25 kHz or two-thirds of the 20 dB bandwidth of the hopping channel.
<input type="checkbox"/>	The 20 dB bandwidth of the hopping channel is less than 250 kHz, the system shall use at least 50 hopping frequencies and the average time of occupancy on any frequency shall not be greater than 0.4 seconds within a 20 second period;
<input type="checkbox"/>	The 20 dB bandwidth of the hopping channel is 250 kHz or greater, the system shall use at least 25 hopping frequencies and the average time of occupancy on any frequency shall not be greater than 0.4 seconds within a 10 second period. The maximum allowed 20 dB bandwidth of the hopping channel is 500 kHz.
<input type="checkbox"/>	Frequency hopping systems operating in the 5725-5850 MHz band shall use at least 75 hopping frequencies. The maximum 20 dB bandwidth of the hopping channel is 1 MHz.

4.4.2 Test Setup

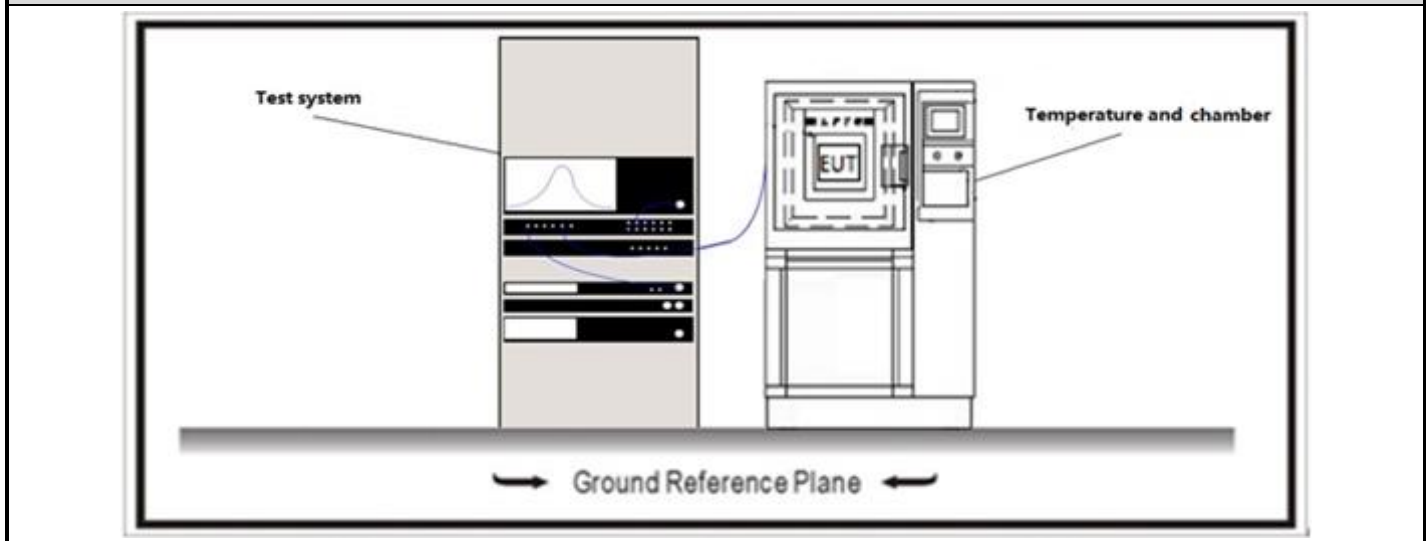

4.4.3 Test Procedure

	References Rule	Chapter	Description
<input checked="" type="checkbox"/>	ANSI C63.10	7.8	Evaluation of frequency-hopping device parameters
<input checked="" type="checkbox"/>	ANSI C63.10	7.8.2	Carrier frequency separation

4.5 Time of Occupancy	VERDICT: PASS
------------------------------	----------------------

4.5.1 Limit

Standard	FCC Part 15 Subpart C Paragraph 15.247(a); RSS-247 Issue 2 Paragraph 5.1.
<input checked="" type="checkbox"/>	Frequency hopping systems in the 2400-2483.5 MHz band shall use at least 15 channels. The average time of occupancy on any channel shall not be greater than 0.4 seconds within a period of 0.4 seconds multiplied by the number of hopping channels employed.
<input type="checkbox"/>	For frequency hopping systems operating in the 902-928 MHz band: if the 20 dB bandwidth of the hopping channel is less than 250 kHz, the system shall use at least 50 hopping frequencies and the average time of occupancy on any frequency shall not be greater than 0.4 seconds within a 20 second period
<input type="checkbox"/>	For frequency hopping systems operating in the 902-928 MHz band: if the 20 dB bandwidth of the hopping channel is 250 kHz or greater, the system shall use at least 25 hopping frequencies and the average time of occupancy on any frequency shall not be greater than 0.4 seconds within a 10 second period.
<input type="checkbox"/>	Frequency hopping systems operating in the 5725-5850 MHz band shall use at least 75 hopping frequencies. The maximum 20 dB bandwidth of the hopping channel is 1 MHz. The average time of occupancy on any frequency shall not be greater than 0.4 seconds within a 30 second period.

4.5.2 Test Setup

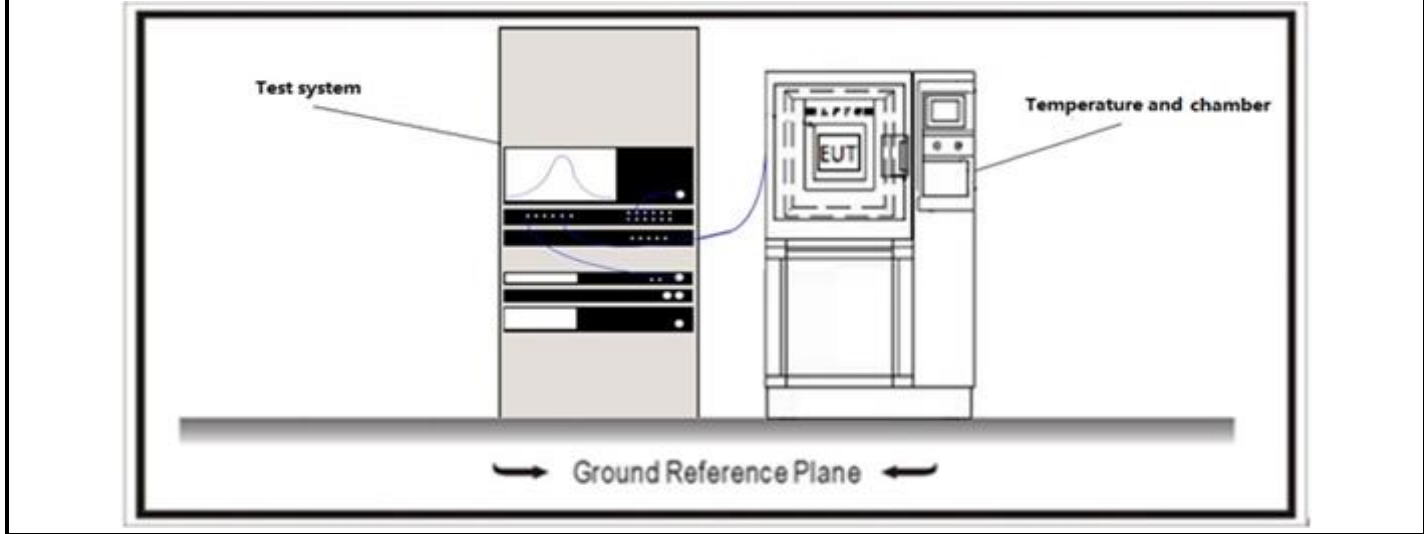

4.5.3 Test Procedure

References Rule	Chapter	Description
<input checked="" type="checkbox"/> ANSI C63.10	7.8	Evaluation of frequency-hopping device parameters
<input checked="" type="checkbox"/> ANSI C63.10	7.8.4	Time of occupancy (dwell time)

4.6 Number of hopping Frequencies	VERDICT: PASS
--	----------------------

4.6.1 Limit

Standard	FCC Part 15 Subpart C Paragraph 15.247(a); RSS-247 Issue 2 Paragraph 5.1.
<input checked="" type="checkbox"/>	For frequency hopping systems operating in the 2400-2483.5 MHz band shall use at least 15 hopping frequencies.
<input type="checkbox"/>	For frequency hopping systems operating in 902-928 MHz band, if the 20 dB bandwidth of the hopping channel is less than 250 kHz, shall use at least 50 hopping frequencies.
<input type="checkbox"/>	For frequency hopping systems operating in 902-928 MHz band, if the 20 dB bandwidth of the hopping channel is higher than 250 kHz, shall use at least 25 hopping frequencies.
<input type="checkbox"/>	For frequency hopping systems operating in the 5725-5850 MHz band shall use at least 75 hopping frequencies.

4.6.2 Test Setup

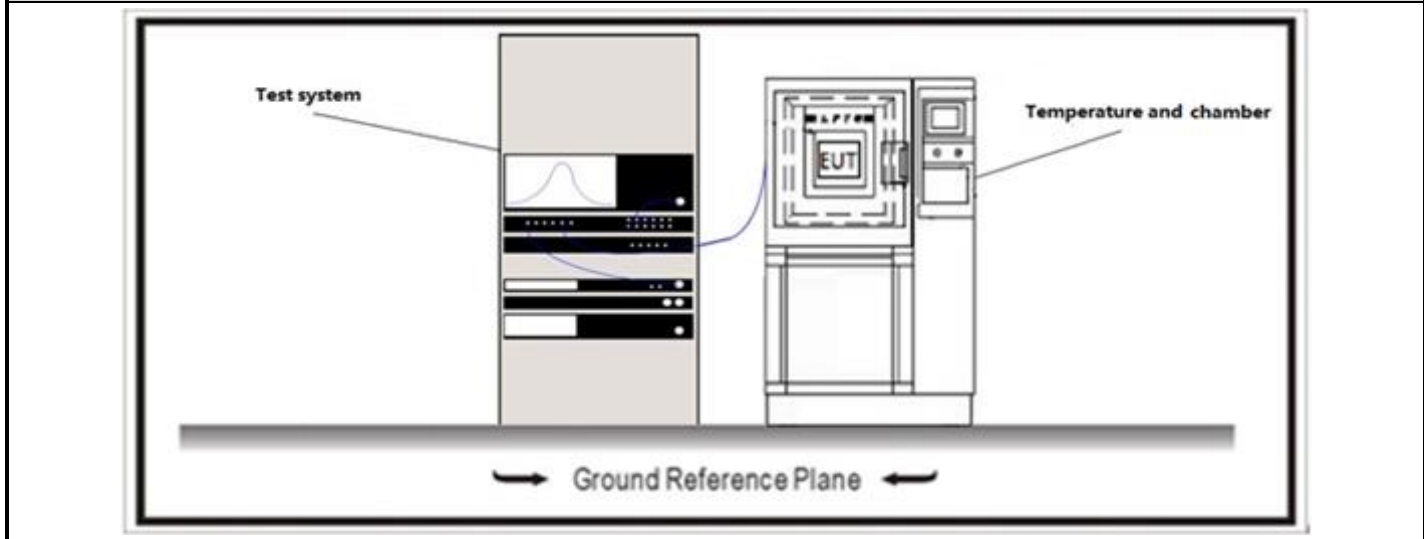

4.6.3 Test Procedure

	References Rule	Chapter	Description
<input checked="" type="checkbox"/>	ANSI C63.10	7.8.	Evaluation of frequency-hopping device parameters
<input checked="" type="checkbox"/>	ANSI C63.10	7.8.3	Number of Hopping Frequencies

4.7 Band edge measurements	VERDICT: PASS
-----------------------------------	----------------------

4.7.1 Limit

Standard FCC Part 15 Subpart C Paragraph 15.247(d) ,15.209; RSS-Gen Issue 5 Paragraph 8.10.

Frequency bands (MHz)	Detector	Limit (dB μ V/m)	RBW (MHz)	Distance (m)
2310-2390	PK	74	1	3
2483.5-2500	AV	54	1	3

Note: The field strength of emissions appearing within these frequency bands shall not exceed the limits.

4.7.2 Test Setup

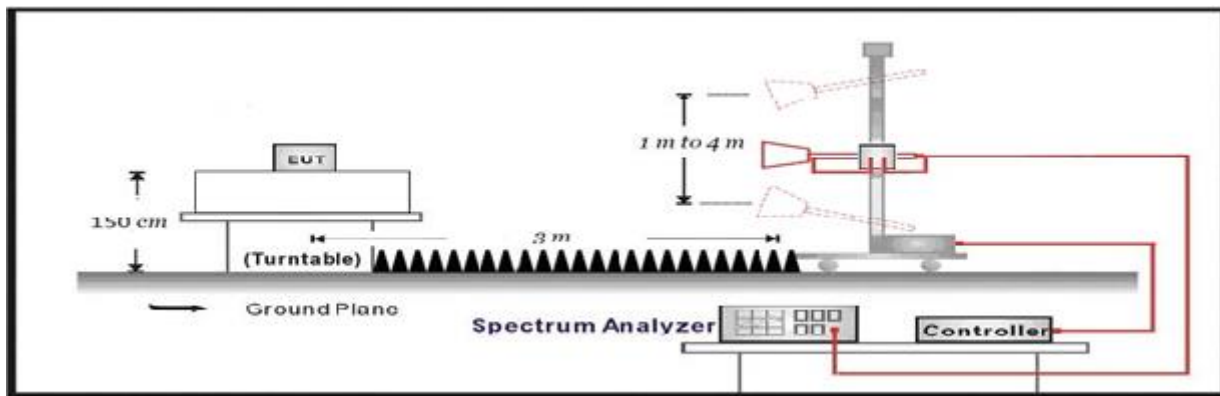

4.7.3 Test Procedure

Test Method			
	References Rule	Chapter	Description
<input type="checkbox"/>	DA 00-705	N/A	duty cycle correction factor
<input checked="" type="checkbox"/>	ANSI C63.10	6.10	Band-edge testing
<input checked="" type="checkbox"/>	ANSI C63.10	6.10.5	Restricted-band band-edge measurements
<input type="checkbox"/>	ANSI C63.10	6.10.6	Marker-delta method
<input type="checkbox"/>	ANSI C63.10	6.4	Radiated emissions from unlicensed wireless devices below 30 MHz
<input type="checkbox"/>	ANSI C63.10	6.5	Radiated emissions from unlicensed wireless devices in the frequency range of 30 MHz to 1000 MHz
<input type="checkbox"/>	ANSI C63.10	6.6	Radiated emissions from unlicensed wireless devices above 1 GHz

4.8 Conducted Spurious Emission	VERDICT: PASS
--	----------------------

4.8.1 Limit

Standard	FCC Part 15 Subpart C Paragraph 15.247(d); RSS-247 Issue 2 Paragraph 5.1.	
RF Output power (Detection methods)		Limit(dB)
RF Output power(Average detector)		30dBc(Note1)
RF Output power(PK detector)		20dBc(Note2)

Note 1: If maximum conducted (average) output power was used to demonstrate compliance as described in 9.2, then the peak power in any 100 kHz bandwidth outside of the authorized frequency band shall be attenuated by at least 30 dB relative to the maximum in-band peak PSD level in 100 kHz (i.e., 30 dBc).

Note 2: If the maximum peak conducted output power procedure was used, then the peak output power measured in any 100 kHz bandwidth outside of the authorized frequency band shall be attenuated by at least 20 dB relative to the maximum in-band peak PSD level in 100 kHz (i.e., 20 dBc).

4.8.2 Test Setup

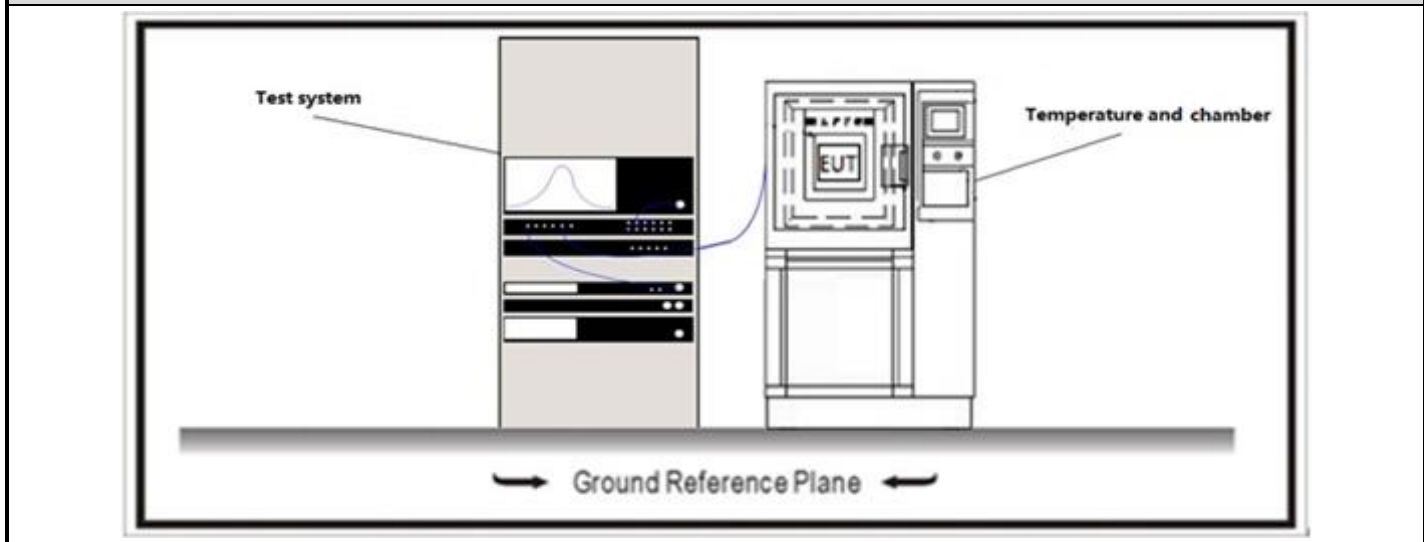

4.8.3 Test Procedure

	References Rule	Chapter	Description
<input checked="" type="checkbox"/>	ANSI C63.10	7.8	Evaluation of frequency-hopping device parameters
<input checked="" type="checkbox"/>	ANSI C63.10	7.8.6	Band-edge measurements for RF conducted emissions

4.9 Duty cycle	VERDICT: PASS
-----------------------	----------------------

4.9.1 Limit

N/A

4.9.2 Test Setup

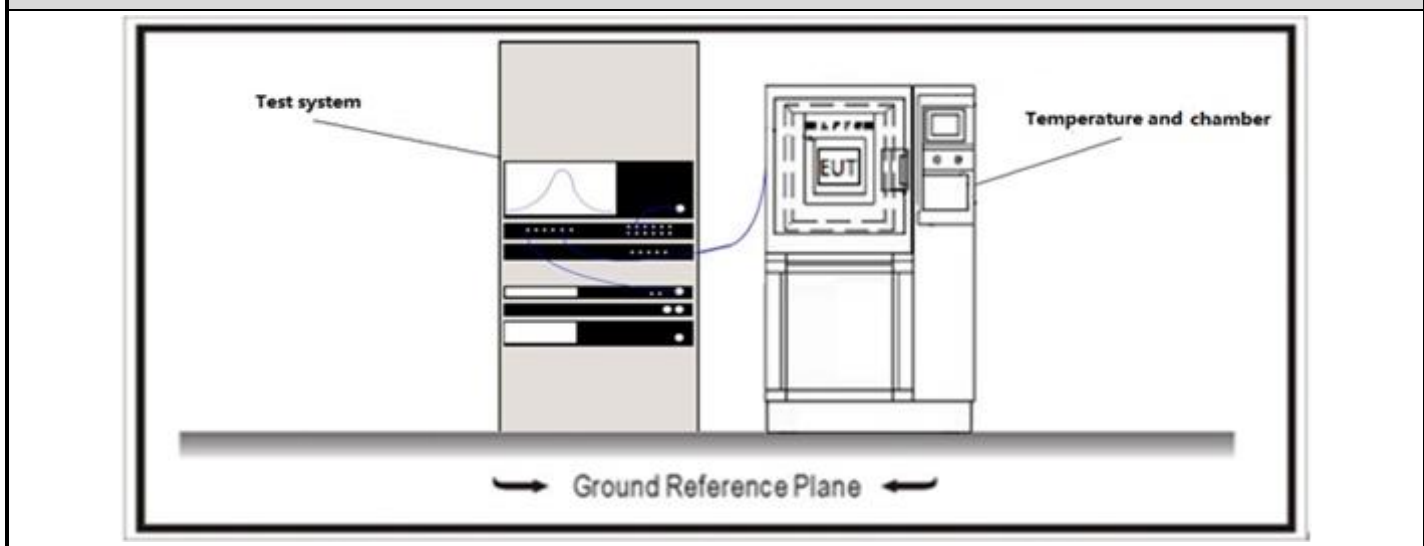

4.9.3 Test Procedure

References Rule	Chapter	Description
<input checked="" type="checkbox"/> ANSI C63.10	11.6	Duty cycle (D), transmission duration (T), and maximum power control level

4.10 Emissions in Restricted Bands	VERDICT: PASS
---	----------------------

4.10.1 Limit

Standard	FCC Part 15 Subpart C Paragraph 15.205
-----------------	--

Restricted Bands of operation

Frequency (MHz)	Frequency (MHz)	Frequency (MHz)	Frequency (GHz)
0.090 – 0.110	16.42 – 16.423	399.9 – 410	4.5 – 5.15
0.495 – 0.505	16.69475 – 16.69525	608 – 614	5.35 – 5.46
2.1735 – 2.1905	16.80425 – 16.80475	960 – 1240	7.25 – 7.75
4.125 – 4.128	25.5 – 25.67	1300 – 1427	8.025 – 8.5
4.17725 – 4.17775	37.5 – 38.25	1435 – 1626.5	9.0 – 9.2
4.20725 – 4.20775	73 – 74.6	1645.5 – 1646.5	9.3 – 9.5
6.215 – 6.218	74.8 – 75.2	1660 – 1710	10.6 – 12.7
6.26775 – 6.26825	108 – 121.94	1718.8 – 1722.2	13.25 – 13.4
6.31175 – 6.31225	123 – 138	2200 – 2300	14.47 – 14.5
8.291 – 8.294	149.9 – 150.05	2310 – 2390	15.35 – 16.2
8.362 – 8.366	156.52475 – 156.52525	2483.5 – 2500	17.7 – 21.4
8.37625 – 8.38675	156.7 – 156.9	2690 – 2900	22.01 – 23.12
8.81425 – 8.81475	162.0125 – 167.17	3260 – 3267	23.6 – 24.0
12.29 – 12.293	167.72 – 173.2	3332 – 3339	31.2 – 31.8
12.51975 – 12.52025	240 – 285	3345.8 – 3358	36.43 – 36.5
12.57675 – 12.57725	322 – 335.4	3600 – 4400	
13.36 – 13.41			

Standard	RSS-Gen Issue 5 Paragraph 8.10
-----------------	--------------------------------

Restricted Bands of operation for IC

0.090 - 0.110	13.36 - 13.41	960 - 1427	9.0 - 9.2
0.495 - 0.505	16.42 - 16.423	1435 - 1626.5	9.3 - 9.5
2.1735 - 2.1905	16.69475 - 16.69525	1645.5 - 1646.5	10.6 - 12.7
3.020 - 3.026	16.80425 - 16.80475	1660 - 1710	13.25 - 13.4
4.125 - 4.128	25.5 - 25.67	1718.8 - 1722.2	14.47 - 14.5
4.17725 - 4.17775	37.5 - 38.25	2200 - 2300	15.35 - 16.2
4.20725 - 4.20775	73 - 74.6	2310 - 2390	17.7 - 21.4
5.677 - 5.683	74.8 - 75.2	2483.5 - 2500	22.01 - 23.12
6.215 - 6.218	108 - 138	2655 - 2900	23.6 - 24.0
6.26775 - 6.26825	149.9 - 150.05	3260 - 3267	31.2 - 31.8
6.31175 - 6.31225	156.52475 - 156.52525	3332 - 3339	36.43 - 36.5
8.291 - 8.294	156.7 - 156.9	3345.8 - 3358	Above 38.6
8.362 - 8.366	162.0125 - 167.17	3500 - 4400	
8.37625 - 8.38675	167.72 - 173.2	4500 - 5150	
8.41425 - 8.41475	240 - 285	5350 - 5460	
12.29 - 12.293	322 - 335.4	7250 - 7750	
12.51975 - 12.52025	399.9 - 410	8025 - 8500	
12.57675 - 12.57725	608 - 614	--	

Restricted Band Emissions Limit			
FCC Part 15 Subpart C Paragraph 15.209			
Frequency (MHz)	Field strength ($\mu\text{V/m}$)	Field strength ($\text{dB}\mu\text{V/m}$)	Measurement distance (m)
0.009 - 0.49	2400/F(kHz)	48.5 – 13.8	300 _(Note 1)
0.49 - 1.705	24000/F(kHz)	33.8 - 23	30 _(Note 1)
1.705 - 30	30	29.5	30 _(Note 1)
30 - 88	100	40	3 _(Note 2)
88 - 216	150	43.5	3 _(Note 2)
216 - 960	200	46	3 _(Note 2)
Above 960	500	54	3 _(Note 2)
RSS-Gen Issue 5 Paragraph 8.9.			
Frequency (MHz)	Field strength	Field strength ($\text{dB}\mu\text{V/m}$)	Measurement distance (m)
0.009 - 0.49	6.37/F(kHz) $\mu\text{A/m}$	48.5 – 13.8	300 _(Note 1)
0.49 - 1.705	63.7/F(kHz) $\mu\text{A/m}$	33.8 - 23	30 _(Note 1)
1.705 - 30	30 $\mu\text{V/m}$	29.5	30 _(Note 1)
30 - 88	100 $\mu\text{V/m}$	40	3 _(Note 2)
88 - 216	150 $\mu\text{V/m}$	43.5	3 _(Note 2)
216 - 960	200 $\mu\text{V/m}$	46	3 _(Note 2)
Above 960	500 $\mu\text{V/m}$	54	3 _(Note 2)
<p>Note 1: At frequencies below 30 MHz, measurements may be performed at a distance closer than that specified in the regulations; however, an attempt should be made to avoid making measurements in the near field. Pending the development of an appropriate measurement procedure for measurements performed below 30 MHz, when performing measurements at a closer distance than specified, the results shall be extrapolated to the specified distance by either making measurements at a minimum of two distances on at least one radial to determine the proper extrapolation factor or by using the square of an inverse linear distance extrapolation factor (40 dB/decade).</p> <p>Note 2: At frequencies at or above 30 MHz, measurements may be performed at a distance other than what is specified provided: measurements are not made in the near field except where it can be shown that near field measurements are appropriate due to the characteristics of the device; and it can be demonstrated that the signal levels needed to be measured at the distance employed can be detected by the measurement equipment. Measurements shall not be performed at a distance greater than 30 meters unless it can be further demonstrated that measurements at a distance of 30 meters or less are impractical. When performing measurements at a distance other than that specified, the results shall be extrapolated to the specified distance using an extrapolation factor of 20 dB/decade (inverse linear-distance for field strength measurements; inverse-linear-distance-squared for power density measurements).</p>			

4.10.2 Test Setup

Below 30MHz Test Setup:

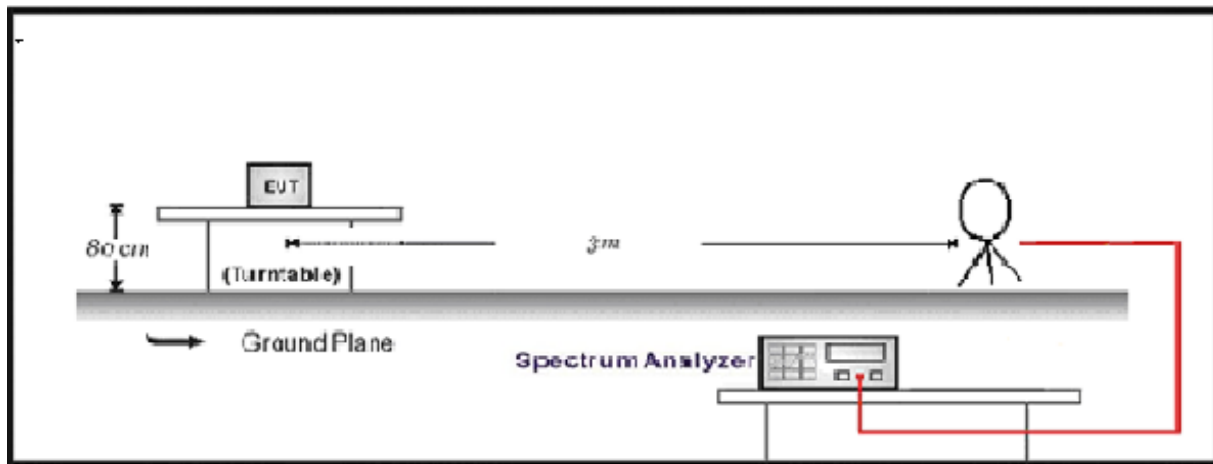

30MHz-1GHz Test Setup:

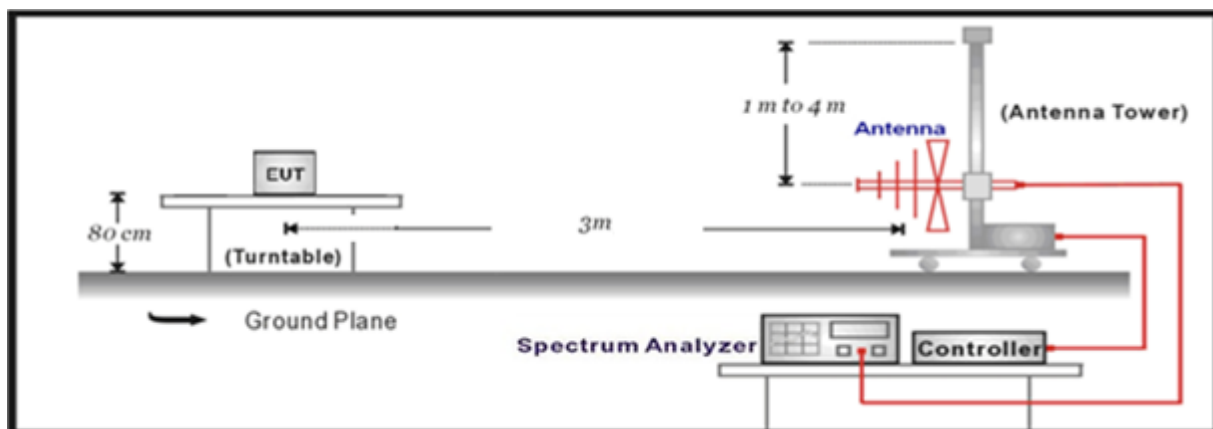

Above 1GHz Test Setup:

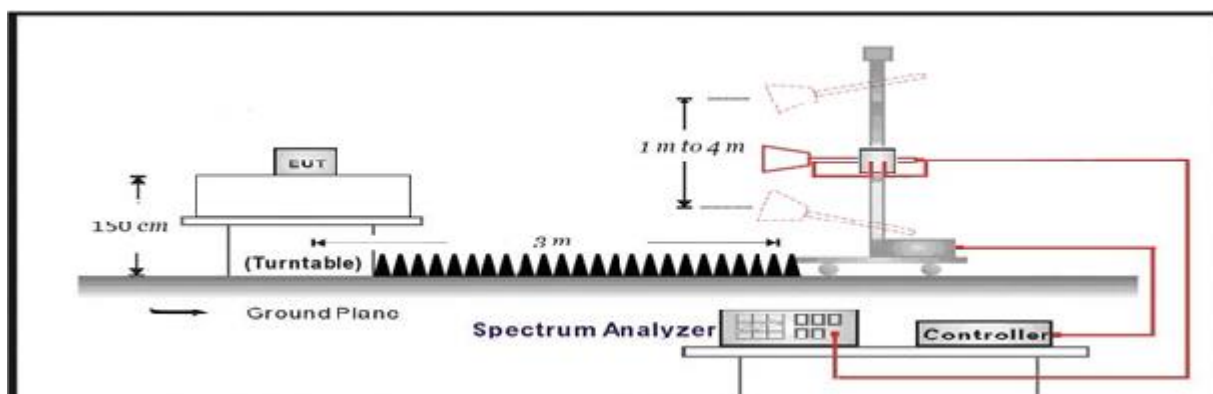

4.10.3 Test Procedure			
	References Rule	Chapter	Description
<input checked="" type="checkbox"/>	ANSI C63.10	11.12	Emissions in restricted frequency bands
	<input checked="" type="checkbox"/> ANSI C63.10	11.12.1	Radiated emission measurements
	<input checked="" type="checkbox"/> ANSI C63.10	11.12.2.7	Radiated spurious emission test
	<input checked="" type="checkbox"/> ANSI C63.10	6.4	Radiated emissions from unlicensed wireless devices below 30 MHz
	<input checked="" type="checkbox"/> ANSI C63.10	6.5	Radiated emissions from unlicensed wireless devices in the frequency range of 30 MHz to 1000 MHz
	<input checked="" type="checkbox"/> ANSI C63.10	6.6	Radiated emissions from unlicensed wireless devices above 1 GHz
<input checked="" type="checkbox"/>	CFR 47, FCC Part 15 A	15.35	Measurement detector functions and bandwidths.
	<input checked="" type="checkbox"/> CFR 47, FCC Part 15 A	15.35(c)	Unless otherwise specified, e.g., §§ 15.255(b), and 15.256(l)(5), when the radiated emission limits are expressed in terms of the average value of the emission, and pulsed operation is employed, the measurement field strength shall be determined by averaging over one complete pulse train, including blanking intervals, as long as the pulse train does not exceed 0.1 seconds. As an alternative (provided the transmitter operates for longer than 0.1 seconds) or in cases where the pulse train exceeds 0.1 seconds, the measured field strength shall be determined from the average absolute voltage during a 0.1 second interval during which the field strength is at its maximum value. The exact method of calculating the average field strength shall be submitted with any application for certification or shall be retained in the measurement data file for equipment subject to Supplier's Declaration of Conformity.

4.11 AC Power Line Conducted Emission

VERDICT: N/A

4.11.1 Limit

Standard FCC Part 15 Subpart C Paragraph 15.207; RSS-Gen Issue 5 Paragraph 8.8.

Frequency range [MHz]	Limit: QP [dB(μV) ¹⁾	Limit: AV [dB(μV) ¹⁾
0,15 - 0,50	66 - 56 ²⁾	56 - 46 ²⁾
0,50 - 5,0	56	46
5,0 - 30	60	50

¹⁾ At the transition frequency, the lower limit applies.

²⁾ The limit decreases linearly with the logarithm of the frequency.

NOTE 1: The exclusion band for transmitters shall be considered for transmitters operating at frequencies below 30 MHz.

NOTE 2: Where the AC output port is directly connected (or via a circuit breaker) to the AC power input port of the EUT the AC power output port need not to be tested.

4.11.2 Test Setup

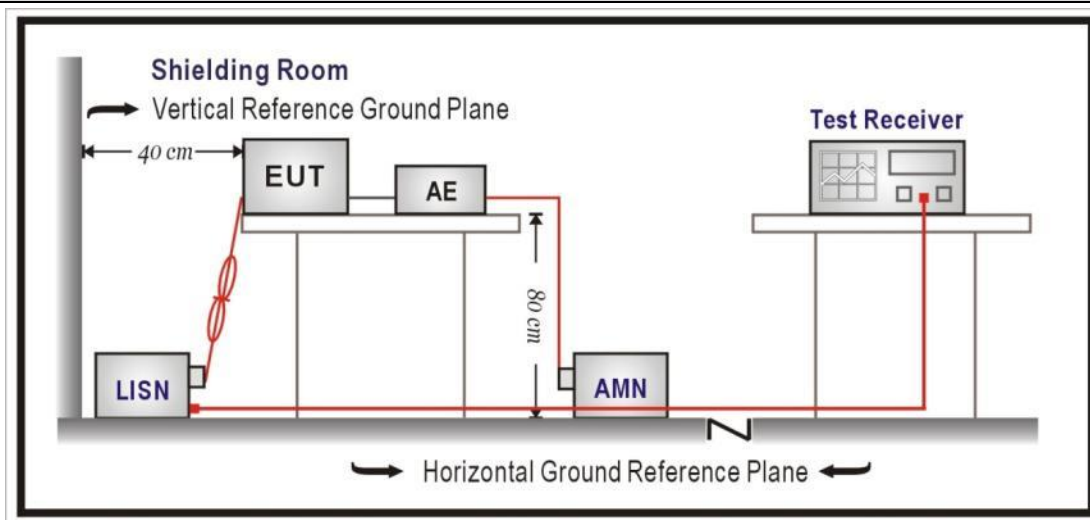

4.11.3 Test Procedure

	References Rule	Chapter	Item
<input checked="" type="checkbox"/>	ANSI C63.10-2013	6.2	Standard test method for ac power-line conducted emissions from unlicensed wireless devices

4.12 Antenna Requirement	VERDICT: PASS
---------------------------------	----------------------

4.12.1 Limit	
Standard	FCC Part 15 Subpart C Paragraph 15.247(d) ,15.209 RSS-Gen Issue 5 Paragraph 6.8.
<p>An intentional radiator shall be designed to ensure that no antenna other than that furnished by the responsible party shall be used with the device. The use of a permanently attached antenna or of an antenna that uses a unique coupling to the intentional radiator shall be considered sufficient to comply with the provisions of this section. The manufacturer may design the unit so that a broken antenna can be replaced by the user, but the use of a standard antenna jack or electrical connector is prohibited. This requirement does not apply to carrier current devices or to devices operated under the provisions of §15.211, §15.213, §15.217, §15.219, or §15.221. Further, this requirement does not apply to intentional radiators that must be professionally installed, such as perimeter protection systems and some field disturbance sensors, or to other intentional radiators which, in accordance with §15.31(d), must be measured at the installation site. However, the installer shall be responsible for ensuring that the proper antenna is employed so that the limits in this part are not exceeded.</p>	

4.12.2 Antenna Connector Construction:	
<input checked="" type="checkbox"/>	The use of a permanently attached antenna
<input type="checkbox"/>	The antenna use of a unique coupling to the intentional radiator
<input type="checkbox"/>	The use of a nonstandard antenna jack or electrical connector
Please refer to the attached document "Internal Photograph" to show the antenna connector.	

5 TEST SETUP PHOTO AND EUT PHOTO

Remark: The test setup photo and EUT Photo please see appendix.

6 TEST RESULT

Appendix A: 20dB Emission Bandwidth

TestMode	Frequency[MHz]	20db EBW[MHz]	FL[MHz]	FH[MHz]	Limit[MHz]	Verdict
DH5	2402	0.927	2401.553	2402.480	2400-2483.5	Pass
	2441	0.957	2440.550	2441.507	2400-2483.5	Pass
	2480	0.963	2479.544	2480.507	2400-2483.5	Pass
2DH5	2402	1.338	2401.349	2402.687	2400-2483.5	Pass
	2441	1.329	2440.337	2441.666	2400-2483.5	Pass
	2480	1.299	2479.376	2480.675	2400-2483.5	Pass
3DH5	2402	1.314	2401.358	2402.672	2400-2483.5	Pass
	2441	1.296	2440.358	2441.654	2400-2483.5	Pass
	2480	1.326	2479.355	2480.681	2400-2483.5	Pass

DH5_Ant1_2402

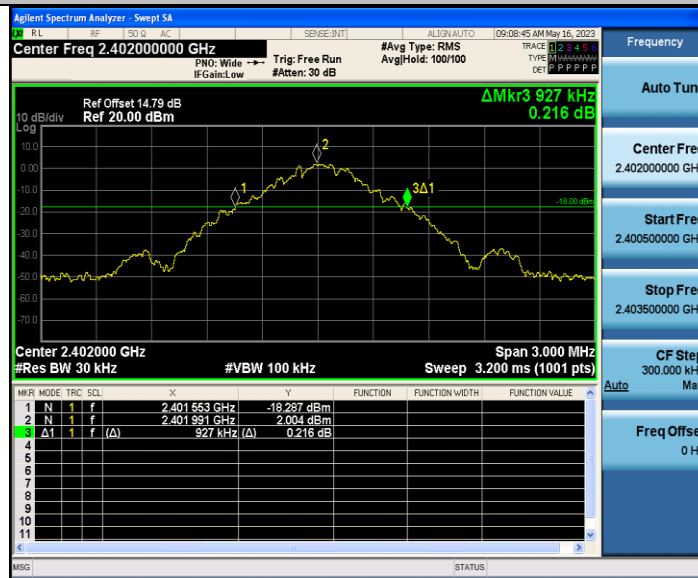

DH5_Ant1_2441



DH5_Ant1_2480



2DH5_Ant1_2402



2DH5_Ant1_2441



2DH5_Ant1_2480



3DH5_Ant1_2402



3DH5_Ant1_2441



3DH5_Ant1_2480



Appendix B: Occupied Channel Bandwidth

TestMode	Frequency[MHz]	OCB [MHz]	FL[MHz]	FH[MHz]	Limit[MHz]
DH5	2402	0.84058	2401.5914	2402.4320	N/A
	2441	0.86701	2440.5778	2441.4448	N/A
	2480	0.87818	2479.5704	2480.4485	N/A
2DH5	2402	1.2356	2401.3922	2402.6278	N/A
	2441	1.2551	2440.3893	2441.6444	N/A
	2480	1.2172	2479.4047	2480.6219	N/A
3DH5	2402	1.2171	2401.3988	2402.6159	N/A
	2441	1.2102	2440.4109	2441.6211	N/A
	2480	1.2155	2479.3964	2480.6119	N/A

DH5_Ant1_2402



DH5_Ant1_2441

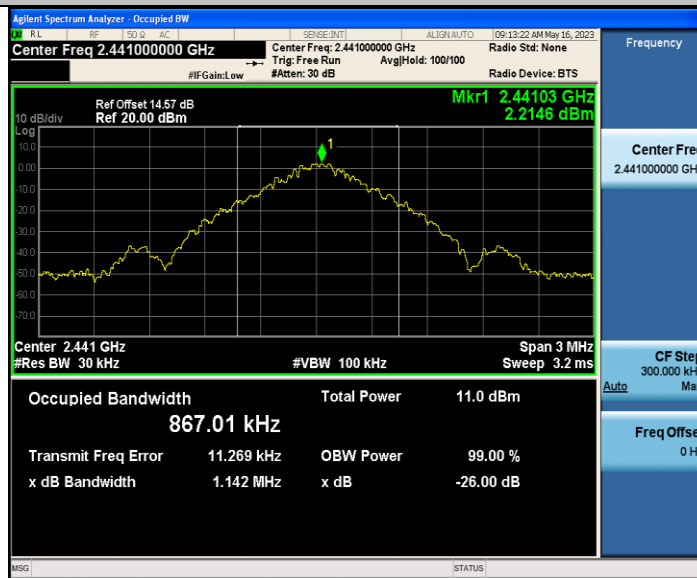

DH5_Ant1_2480



2DH5_Ant1_2402

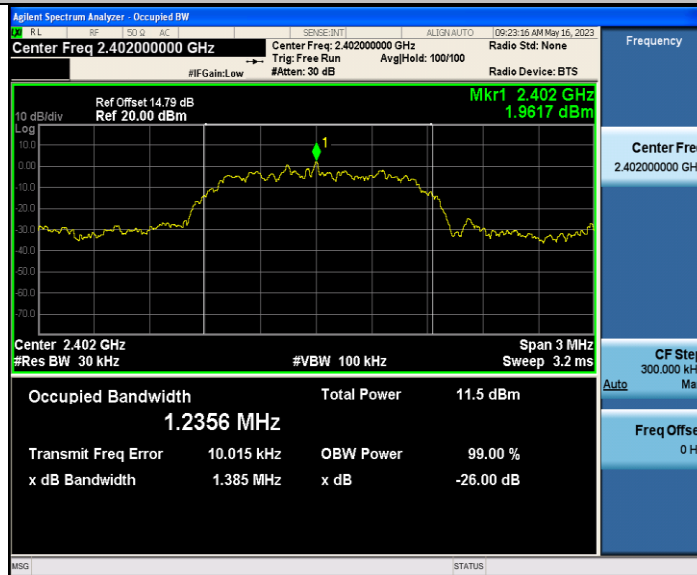

2DH5_Ant1_2441



2DH5_Ant1_2480



3DH5_Ant1_2402

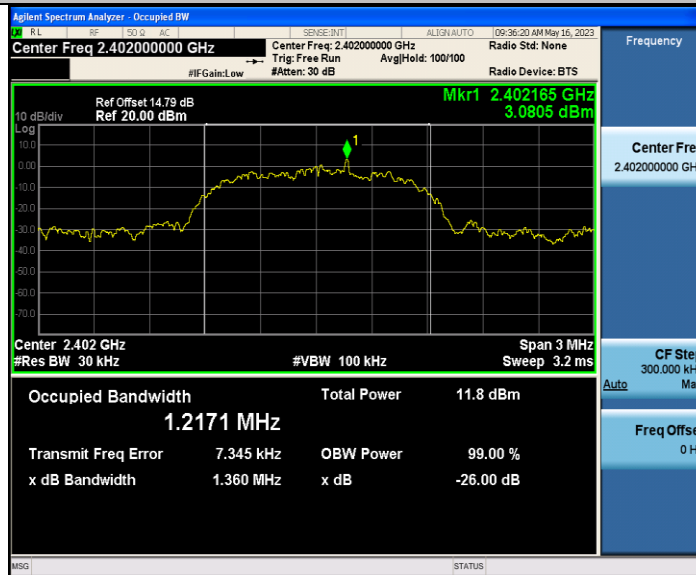

3DH5_Ant1_2441

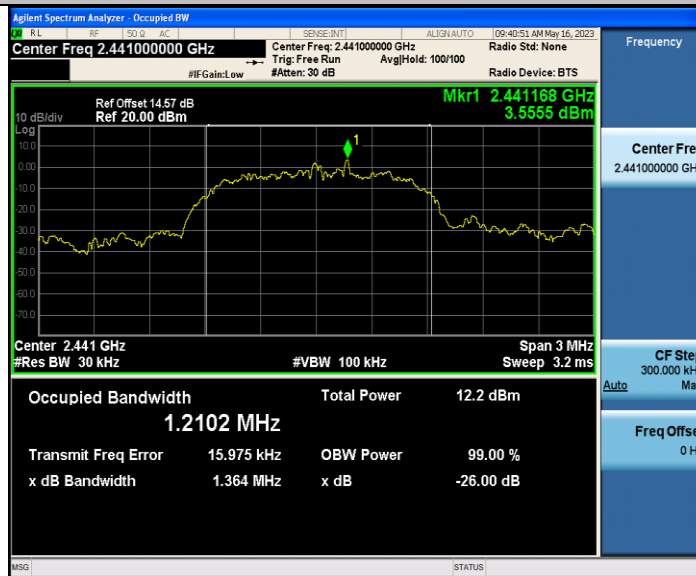

3DH5_Ant1_2480

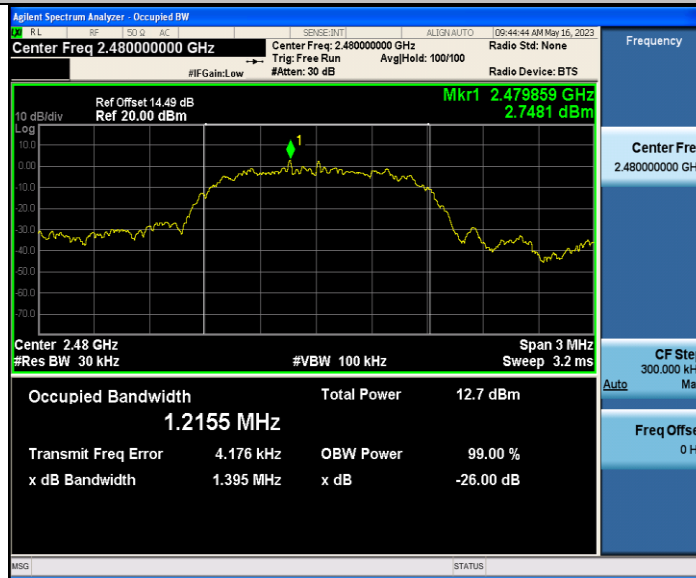

Appendix C: Maximum conducted output power

Test Mode	Frequency[MHz]	Conducted Power [dBm]	EIRP Power[dBm]	Conducted Limit[dBm]	EIRP Limit[dBm]	Verdict
DH5	2402	4.96	7.86	≤30	≤36	PASS
	2441	5.35	8.25	≤30	≤36	PASS
	2480	6.31	9.21	≤30	≤36	PASS
2DH5	2402	4.86	7.76	≤20.97	≤36	PASS
	2441	4.91	7.81	≤20.97	≤36	PASS
	2480	5.96	8.86	≤20.97	≤36	PASS
3DH5	2402	4.89	7.79	≤20.97	≤36	PASS
	2441	5.18	8.08	≤20.97	≤36	PASS
	2480	6.11	9.01	≤20.97	≤36	PASS

Appendix D: Carrier frequency separation

Test Mode	Frequency[MHz]	Result[MHz]	Limit[MHz]	Verdict
DH5	Hop	1.294	≥0.960	PASS
2DH5	Hop	1.306	≥0.892	PASS
3DH5	Hop	1.260	≥0.884	PASS

DH5_Ant1_Hop



2DH5_Ant1_Hop

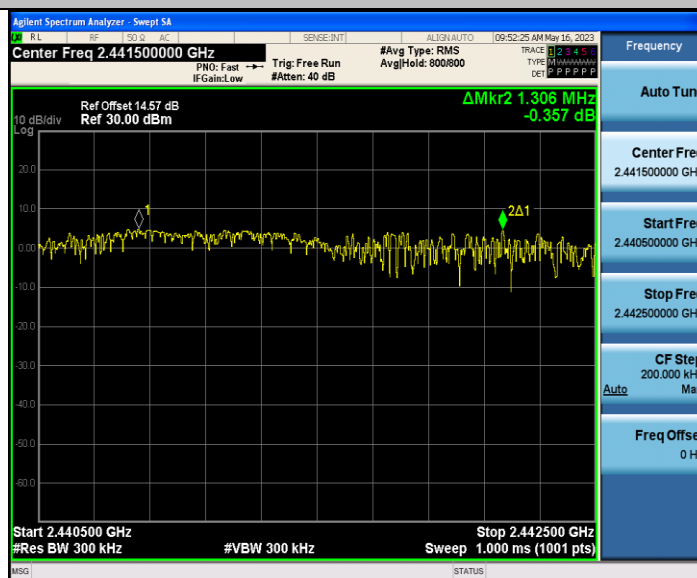

3DH5_Ant1_Hop

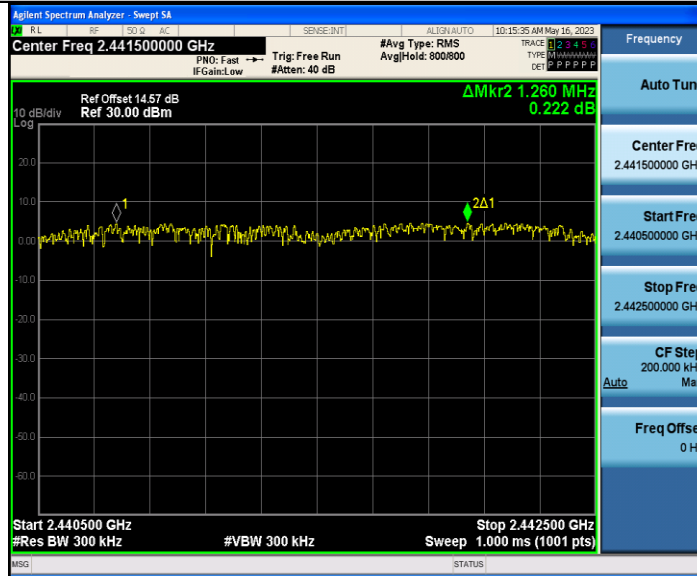

Appendix E: Time of occupancy

Test Mode	Frequency[MHz]	BurstWidth [ms]	TotalHops [Num]	Result[s]	Limit[s]	Verdict
DH5	Hop	2.889	106.67	0.308	≤0.4	PASS
2DH5	Hop	2.892	106.67	0.308	≤0.4	PASS
3DH5	Hop	2.893	106.67	0.309	≤0.4	PASS

DH5_Ant1_Hop

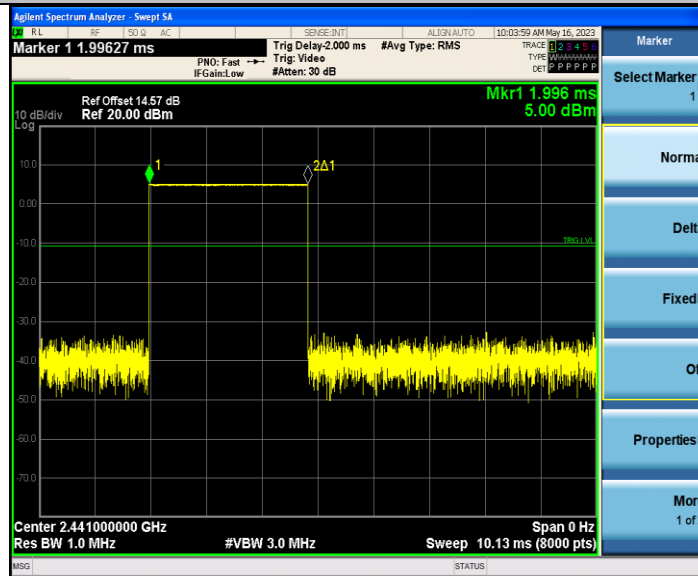

2DH5_Ant1_Hop

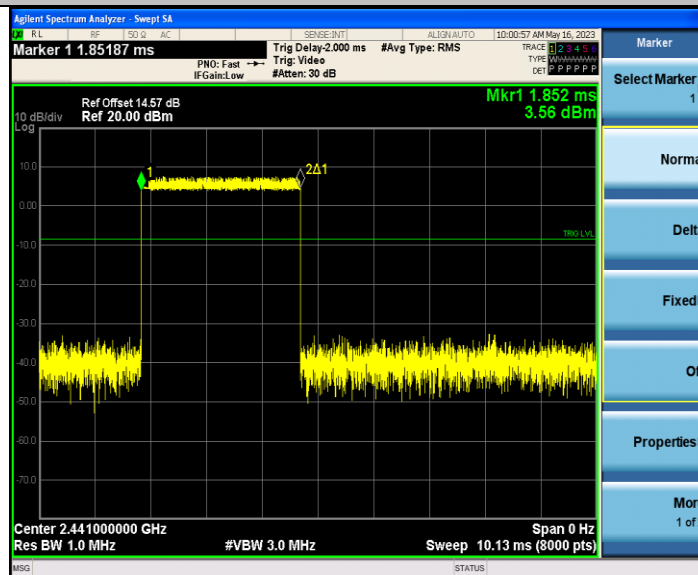

3DH5_Ant1_Hop

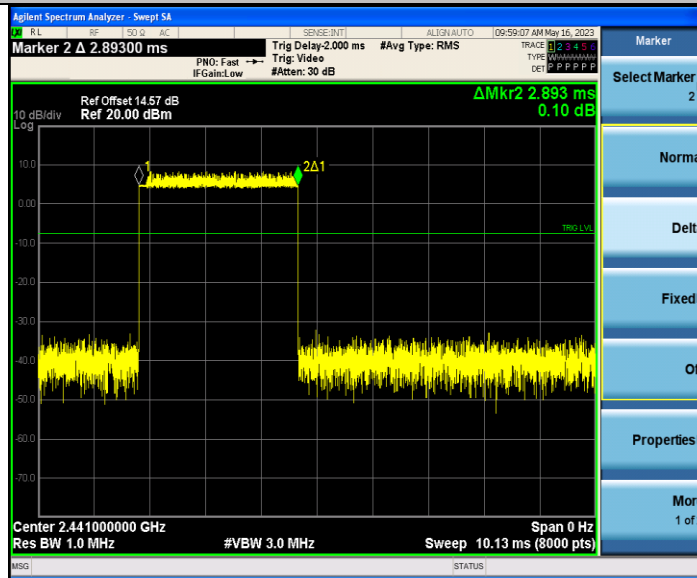

Appendix F: Number of hopping channels

Test Mode	Frequency[MHz]	Result[Num]	Limit[Num]	Verdict
DH5	Hop	79	≥15	PASS
2DH5	Hop	79	≥15	PASS
3DH5	Hop	79	≥15	PASS

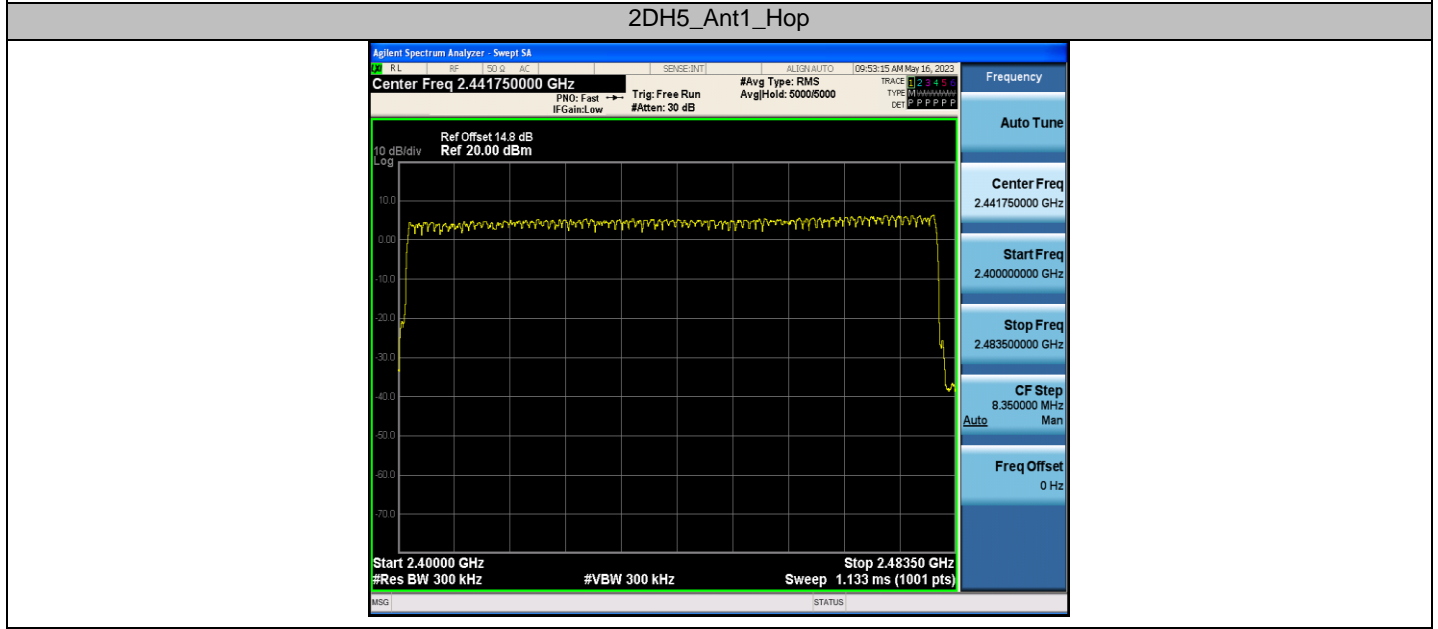
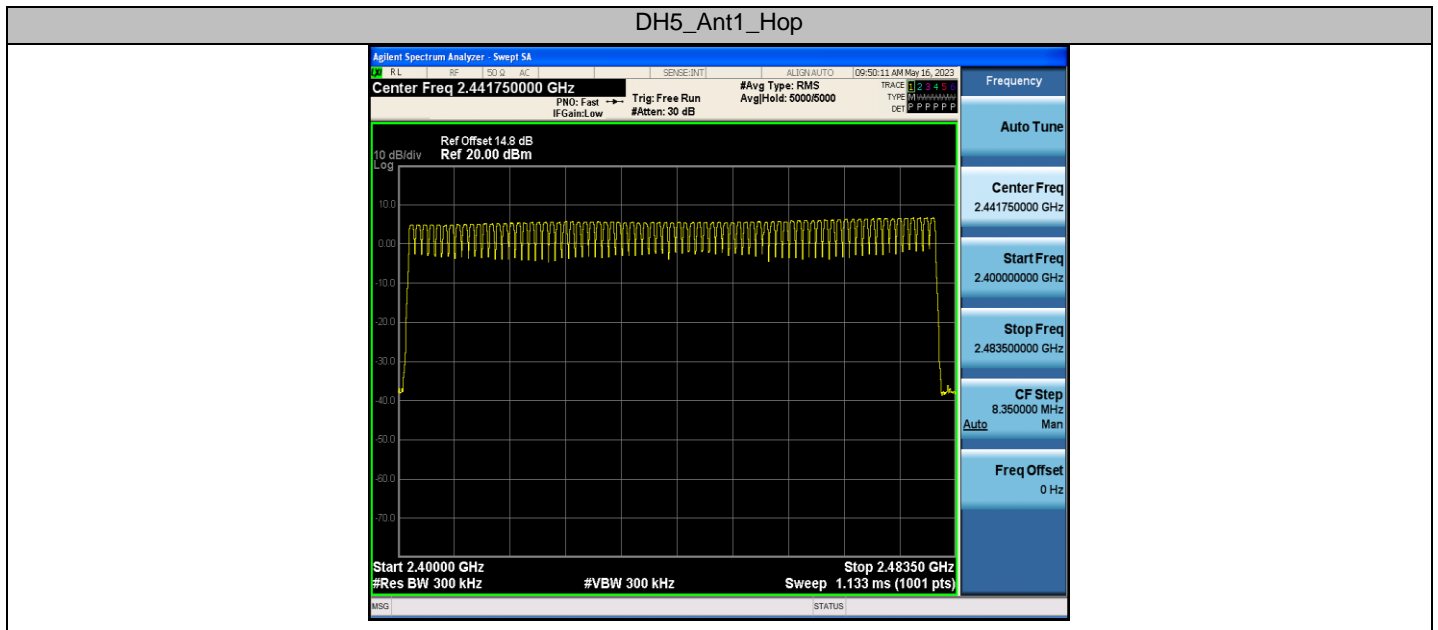

3DH5_Ant1_Hop

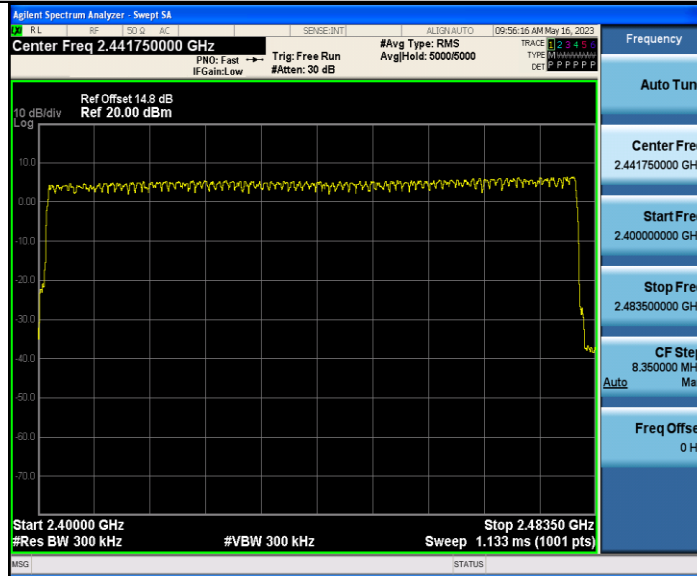

Appendix G: Band edge measurements

Profile: 2340773R	Page No.: 1
Engineer: Yuliu	
Site: AC5	Time: 2023/05/17 - 21:03
Limit: FCC_Part15.209_RE(3m)	Margin: 0
Probe: Horn_3117_00167055(1-18GHz)	Polarity: Horizontal
EUT: Barcode Scanner	Power: By Battery
Note: Mode 1 : Transmit at 2402MHz by DH5	

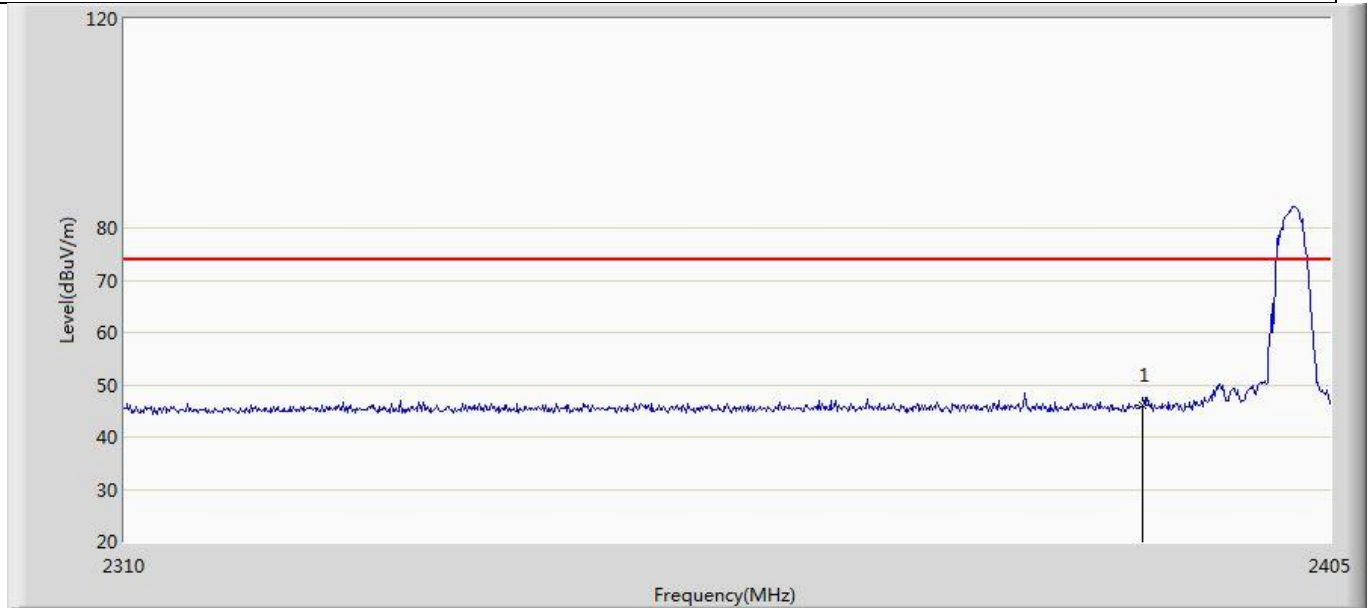

No	Mark	Frequency (MHz)	Measure Level (dBuV/m)	Reading Level (dBuV)	Over Limit (dB)	Limit (dBuV/m)	Factor (dB)	Type
1	*	2390.000	46.166	12.082	-27.834	74.000	34.084	PK

Profile: 2340773R	Page No.: 2
Engineer: Yuliu	
Site: AC5	Time: 2023/05/17 - 20:11
Limit: FCC_Part15.209_RE(3m)	Margin: 0
Probe: Horn_3117_00167055(1-18GHz)	Polarity: Horizontal
EUT: Barcode Scanner	Power: By Battery
Note: Mode 1 : Transmit at 2402MHz by DH5	

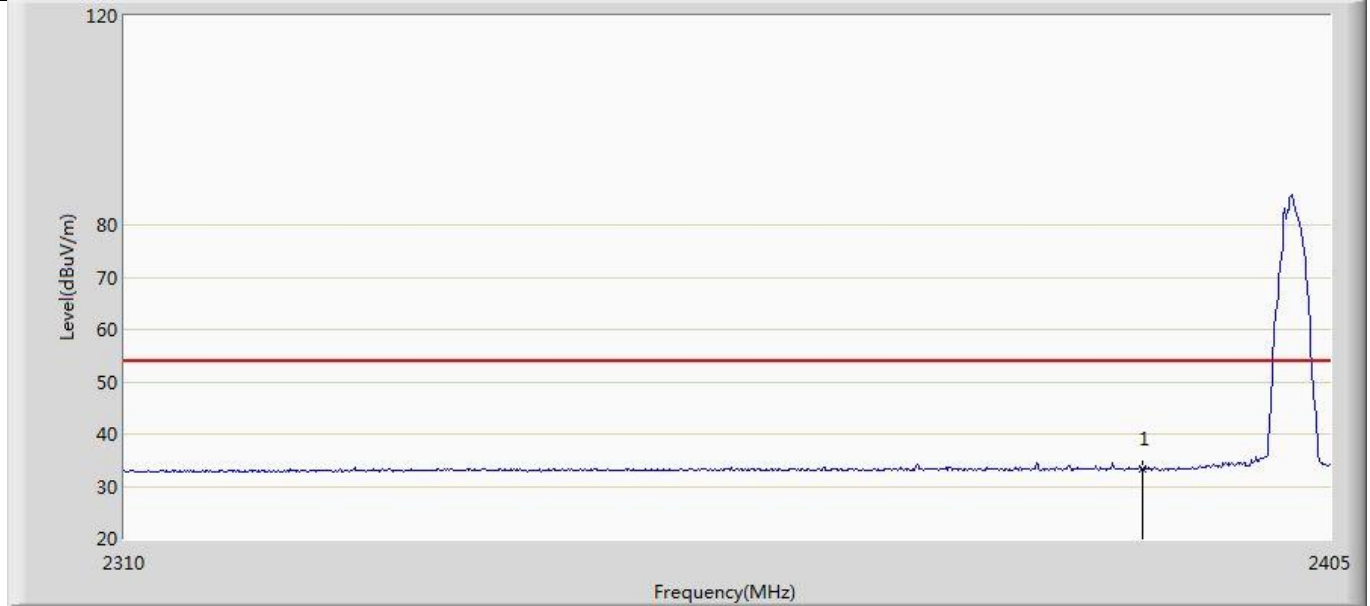

No	Mark	Frequency (MHz)	Measure Level (dBuV/m)	Reading Level (dBuV)	Over Limit (dB)	Limit (dBuV/m)	Factor (dB)	Type
1	*	2390.000	33.247	-0.837	-20.753	54.000	34.084	AV

Profile: 2340773R	Page No.: 3
Engineer: Yuliu	
Site: AC5	Time: 2023/05/17 - 20:12
Limit: FCC_Part15.209_RE(3m)	Margin: 0
Probe: Horn_3117_00167055(1-18GHz)	Polarity: Vertical
EUT: Barcode Scanner	Power: By Battery
Note: Mode 1 : Transmit at 2402MHz by DH5	

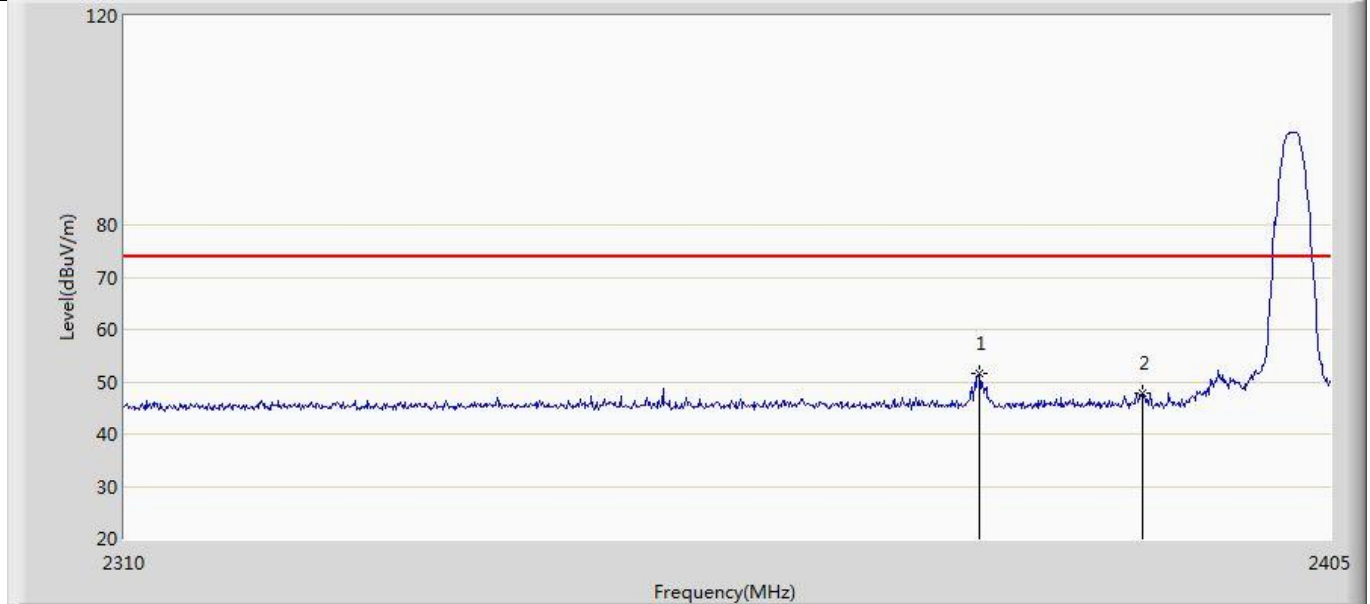

No	Mark	Frequency (MHz)	Measure Level (dBuV/m)	Reading Level (dBuV)	Over Limit (dB)	Limit (dBuV/m)	Factor (dB)	Type
1	*	2376.975	51.661	17.631	-22.339	74.000	34.030	PK
2		2390.000	47.738	13.654	-26.262	74.000	34.084	PK

Profile: 2340773R	Page No.: 4
Engineer: Yuliu	
Site: AC5	Time: 2023/05/17 - 20:13
Limit: FCC_Part15.209_RE(3m)	Margin: 0
Probe: Horn_3117_00167055(1-18GHz)	Polarity: Vertical
EUT: Barcode Scanner	Power: By Battery
Note: Mode 1 : Transmit at 2402MHz by DH5	

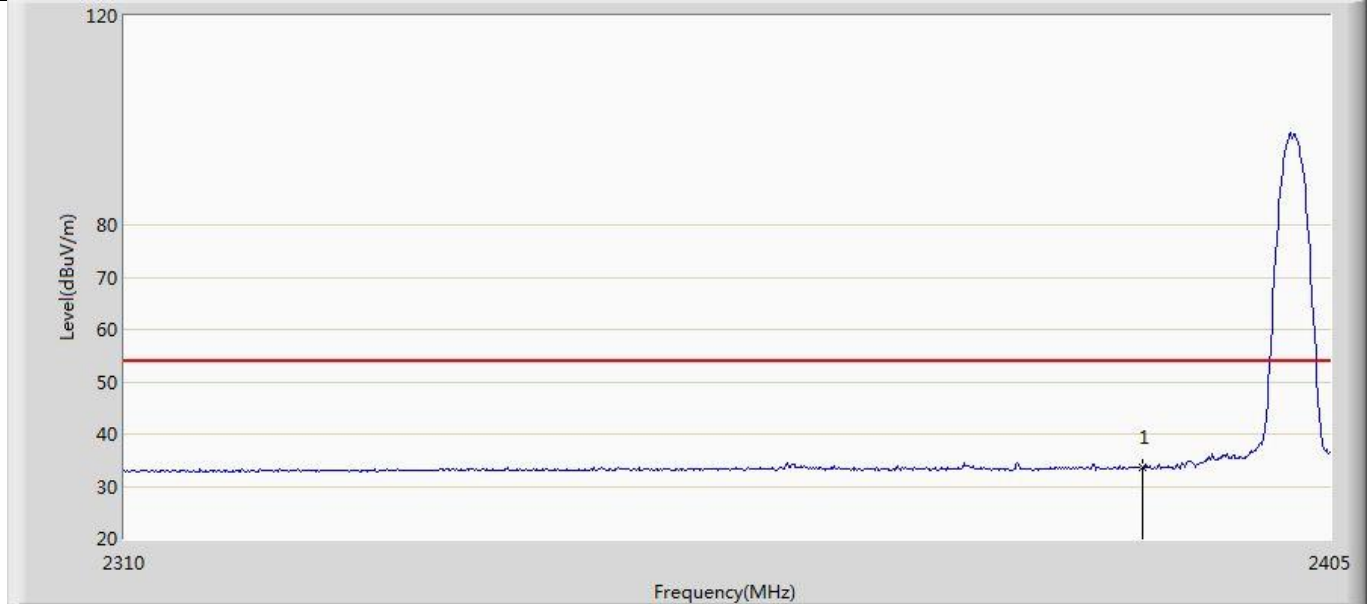

No	Mark	Frequency (MHz)	Measure Level (dBuV/m)	Reading Level (dBuV)	Over Limit (dB)	Limit (dBuV/m)	Factor (dB)	Type
1	*	2390.000	33.598	-0.486	-20.402	54.000	34.084	AV

Profile: 2340773R	Page No.: 5
Engineer: Yuliu	
Site: AC5	Time: 2023/05/17 - 20:14
Limit: FCC_Part15.209_RE(3m)	Margin: 0
Probe: Horn_3117_00167055(1-18GHz)	Polarity: Horizontal
EUT: Barcode Scanner	Power: By Battery
Note: Mode 1 : Transmit at 2480MHz by DH5	

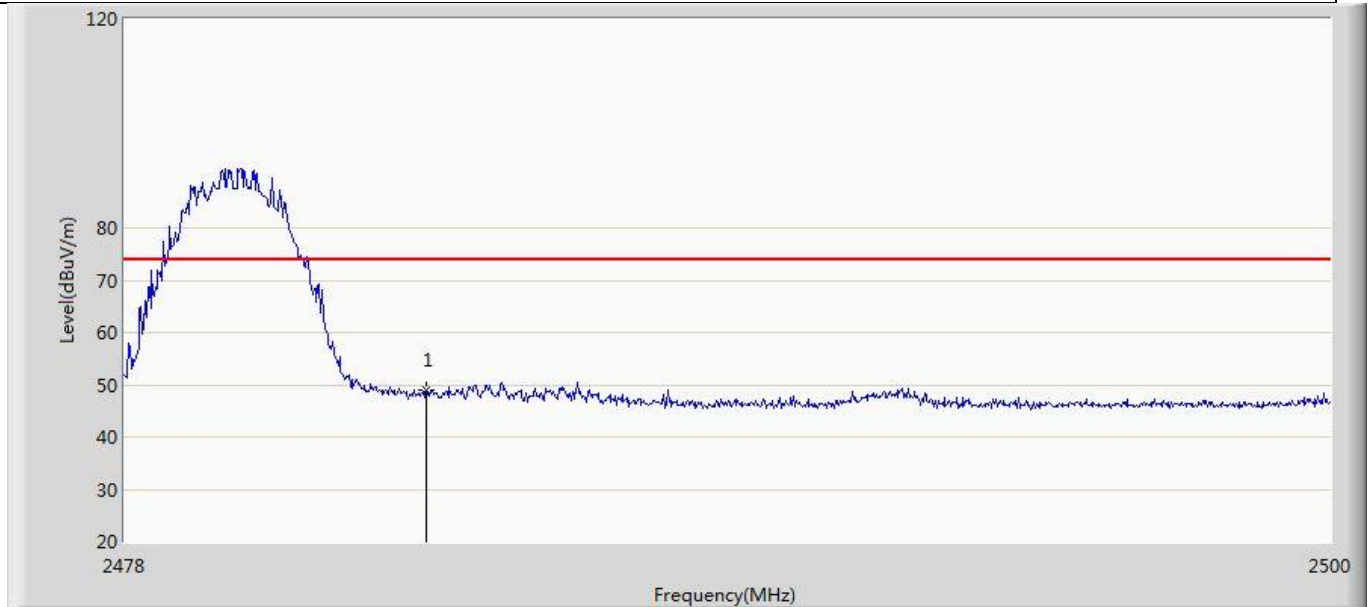

No	Mark	Frequency (MHz)	Measure Level (dBuV/m)	Reading Level (dBuV)	Over Limit (dB)	Limit (dBuV/m)	Factor (dB)	Type
1	*	2483.500	49.078	14.587	-24.922	74.000	34.491	PK

Profile: 2340773R	Page No.: 6
Engineer: Yuliu	
Site: AC5	Time: 2023/05/17 - 20:16
Limit: FCC_Part15.209_RE(3m)	Margin: 0
Probe: Horn_3117_00167055(1-18GHz)	Polarity: Horizontal
EUT: Barcode Scanner	Power: By Battery
Note: Mode 1 : Transmit at 2480MHz by DH5	

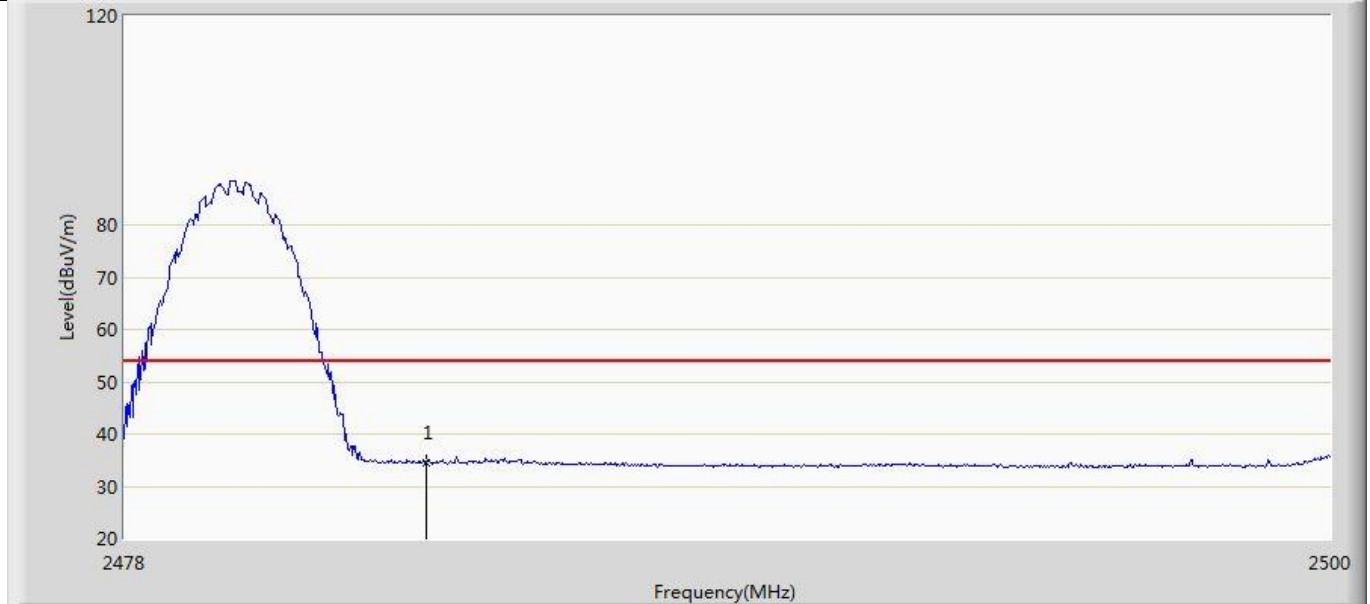

No	Mark	Frequency (MHz)	Measure Level (dBuV/m)	Reading Level (dBuV)	Over Limit (dB)	Limit (dBuV/m)	Factor (dB)	Type
1	*	2483.500	34.530	0.039	-19.470	54.000	34.491	AV

Profile: 2340773R	Page No.: 7
Engineer: Yuliu	
Site: AC5	Time: 2023/05/17 - 20:17
Limit: FCC_Part15.209_RE(3m)	Margin: 0
Probe: Horn_3117_00167055(1-18GHz)	Polarity: Vertical
EUT: Barcode Scanner	Power: By Battery
Note: Mode 1 : Transmit at 2480MHz by DH5	

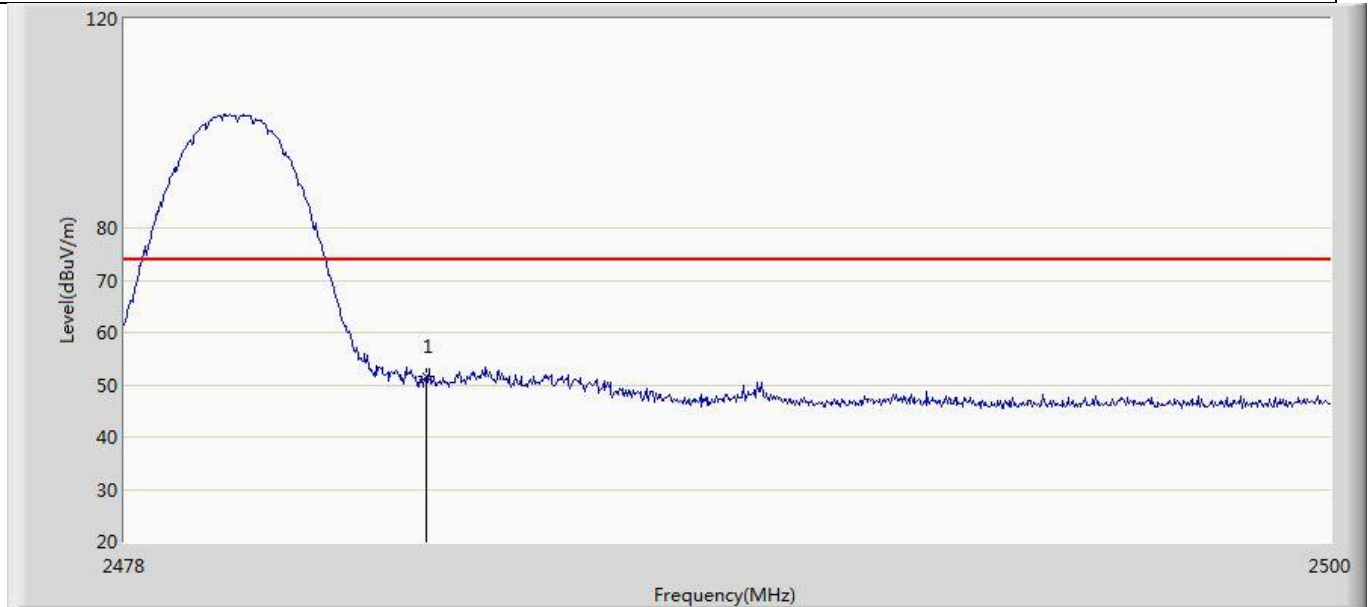

No	Mark	Frequency (MHz)	Measure Level (dBuV/m)	Reading Level (dBuV)	Over Limit (dB)	Limit (dBuV/m)	Factor (dB)	Type
1	*	2483.500	51.490	16.999	-22.510	74.000	34.491	PK

Profile: 2340773R	Page No.: 8
Engineer: Yuliu	
Site: AC5	Time: 2023/05/17 - 20:18
Limit: FCC_Part15.209_RE(3m)	Margin: 0
Probe: Horn_3117_00167055(1-18GHz)	Polarity: Vertical
EUT: Barcode Scanner	Power: By Battery
Note: Mode 1 : Transmit at 2480MHz by DH5	

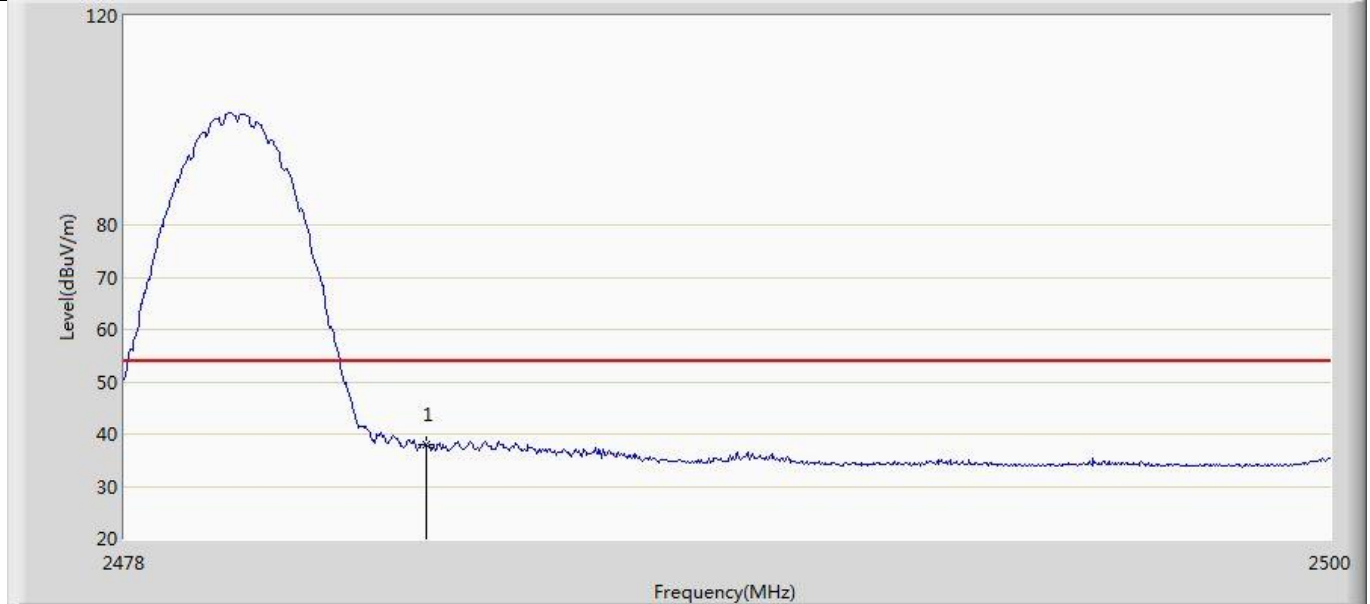

No	Mark	Frequency (MHz)	Measure Level (dBuV/m)	Reading Level (dBuV)	Over Limit (dB)	Limit (dBuV/m)	Factor (dB)	Type
1	*	2483.500	37.833	3.342	-16.167	54.000	34.491	AV

Profile: 2340773R	Page No.: 9
Engineer: Yuliu	
Site: AC5	Time: 2023/05/17 - 20:19
Limit: FCC_Part15.209_RE(3m)	Margin: 0
Probe: Horn_3117_00167055(1-18GHz)	Polarity: Horizontal
EUT: Barcode Scanner	Power: By Battery
Note: Mode 2 : Transmit at 2402MHz by 2DH5	

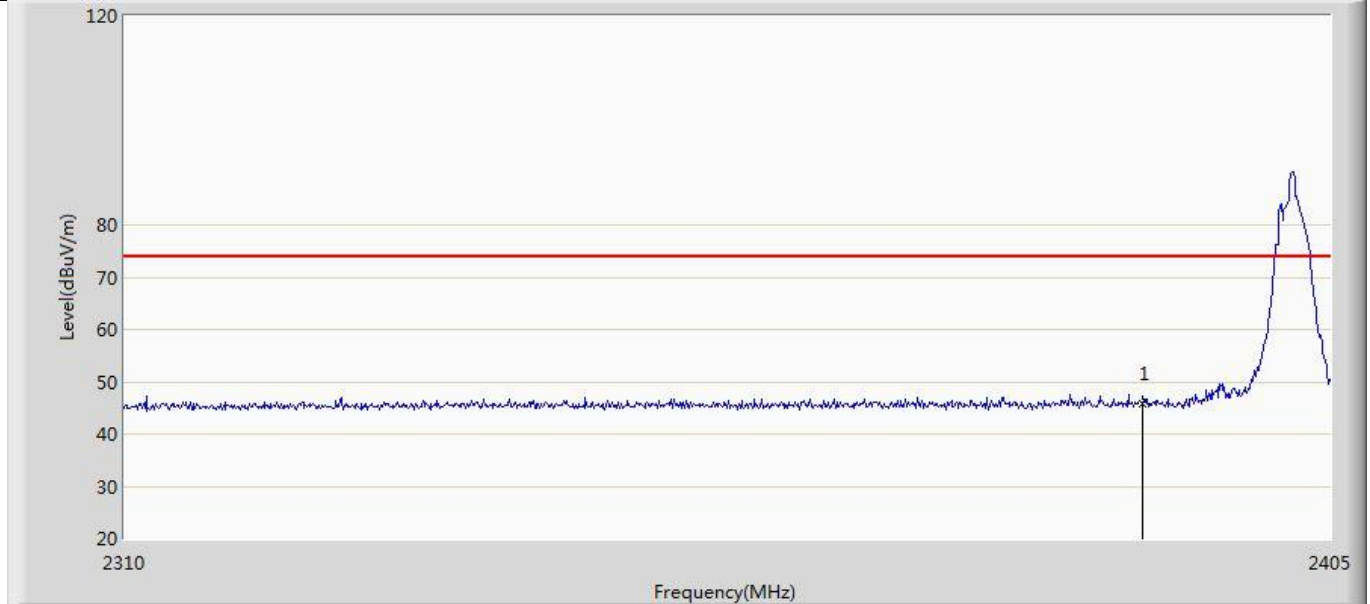

No	Mark	Frequency (MHz)	Measure Level (dBuV/m)	Reading Level (dBuV)	Over Limit (dB)	Limit (dBuV/m)	Factor (dB)	Type
1	*	2390.000	45.922	11.838	-28.078	74.000	34.084	PK

Profile: 2340773R	Page No.: 10
Engineer: Yuliu	
Site: AC5	Time: 2023/05/17 - 20:20
Limit: FCC_Part15.209_RE(3m)	Margin: 0
Probe: Horn_3117_00167055(1-18GHz)	Polarity: Horizontal
EUT: Barcode Scanner	Power: By Battery
Note: Mode 2 : Transmit at 2402MHz by 2DH5	

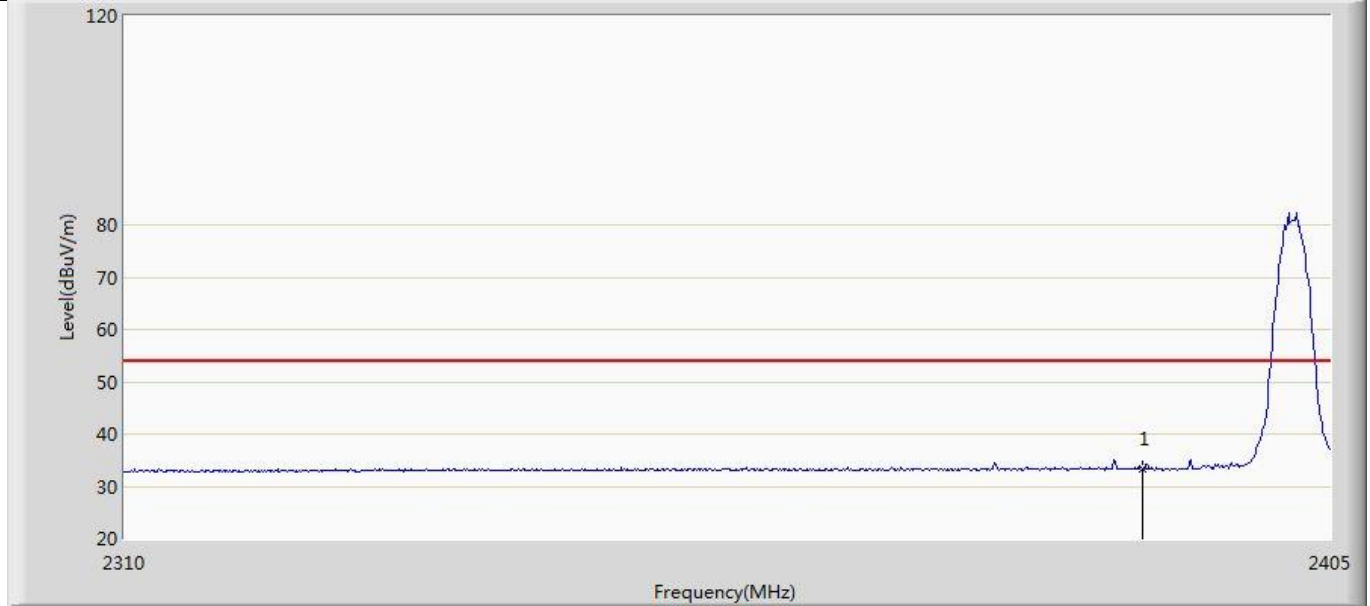

No	Mark	Frequency (MHz)	Measure Level (dBuV/m)	Reading Level (dBuV)	Over Limit (dB)	Limit (dBuV/m)	Factor (dB)	Type
1	*	2390.000	33.295	-0.789	-20.705	54.000	34.084	AV

Profile: 2340773R	Page No.: 11
Engineer: Yuliu	
Site: AC5	Time: 2023/05/17 - 20:21
Limit: FCC_Part15.209_RE(3m)	Margin: 0
Probe: Horn_3117_00167055(1-18GHz)	Polarity: Vertical
EUT: Barcode Scanner	Power: By Battery
Note: Mode 2 : Transmit at 2402MHz by 2DH5	

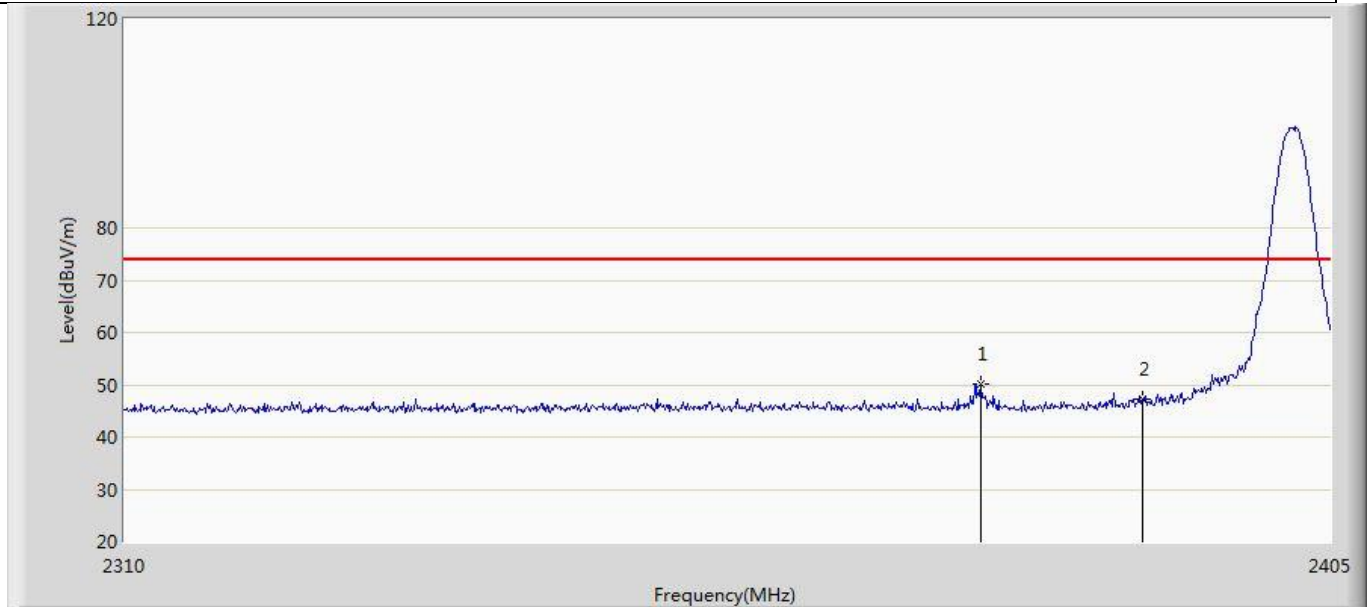

No	Mark	Frequency (MHz)	Measure Level (dBuV/m)	Reading Level (dBuV)	Over Limit (dB)	Limit (dBuV/m)	Factor (dB)	Type
1	*	2377.070	50.201	16.171	-23.799	74.000	34.030	PK
2		2390.000	47.118	13.034	-26.882	74.000	34.084	PK

Profile: 2340773R	Page No.: 12
Engineer: Yuliu	
Site: AC5	Time: 2023/05/17 - 20:23
Limit: FCC_Part15.209_RE(3m)	Margin: 0
Probe: Horn_3117_00167055(1-18GHz)	Polarity: Vertical
EUT: Barcode Scanner	Power: By Battery
Note: Mode 2 : Transmit at 2402MHz by 2DH5	

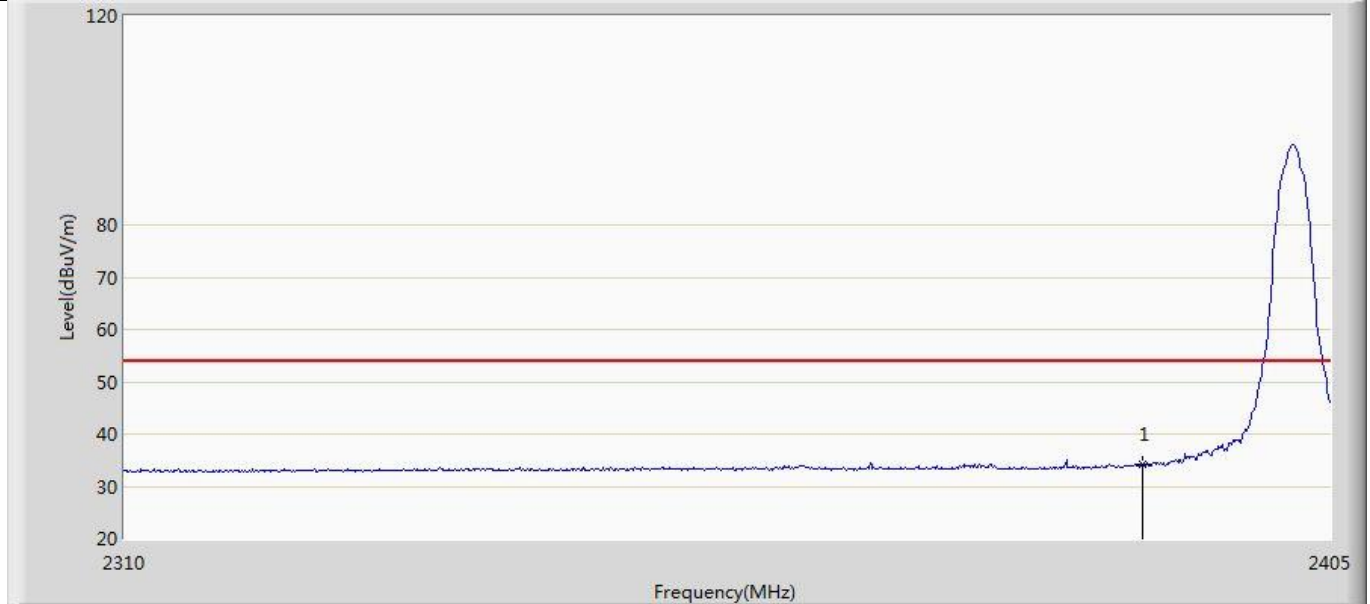

No	Mark	Frequency (MHz)	Measure Level (dBuV/m)	Reading Level (dBuV)	Over Limit (dB)	Limit (dBuV/m)	Factor (dB)	Type
1	*	2390.000	34.173	0.089	-19.827	54.000	34.084	AV

Profile: 2340773R	Page No.: 13
Engineer: Yuliu	
Site: AC5	Time: 2023/05/17 - 20:24
Limit: FCC_Part15.209_RE(3m)	Margin: 0
Probe: Horn_3117_00167055(1-18GHz)	Polarity: Horizontal
EUT: Barcode Scanner	Power: By Battery
Note: Mode 2 : Transmit at 2480MHz by 2DH5	

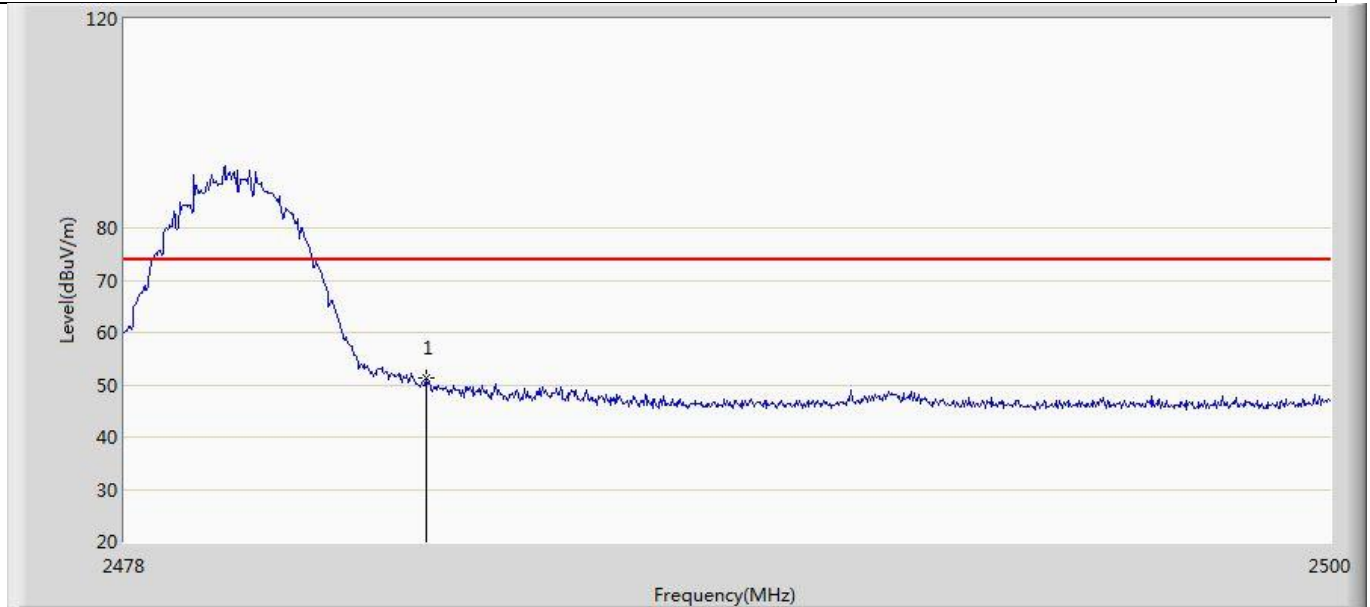

No	Mark	Frequency (MHz)	Measure Level (dBuV/m)	Reading Level (dBuV)	Over Limit (dB)	Limit (dBuV/m)	Factor (dB)	Type
1	*	2483.500	51.180	16.689	-22.820	74.000	34.491	PK

Profile: 2340773R	Page No.: 14
Engineer: Yuliu	
Site: AC5	Time: 2023/05/17 - 20:25
Limit: FCC_Part15.209_RE(3m)	Margin: 0
Probe: Horn_3117_00167055(1-18GHz)	Polarity: Horizontal
EUT: Barcode Scanner	Power: By Battery
Note: Mode 2 : Transmit at 2480MHz by 2DH5	

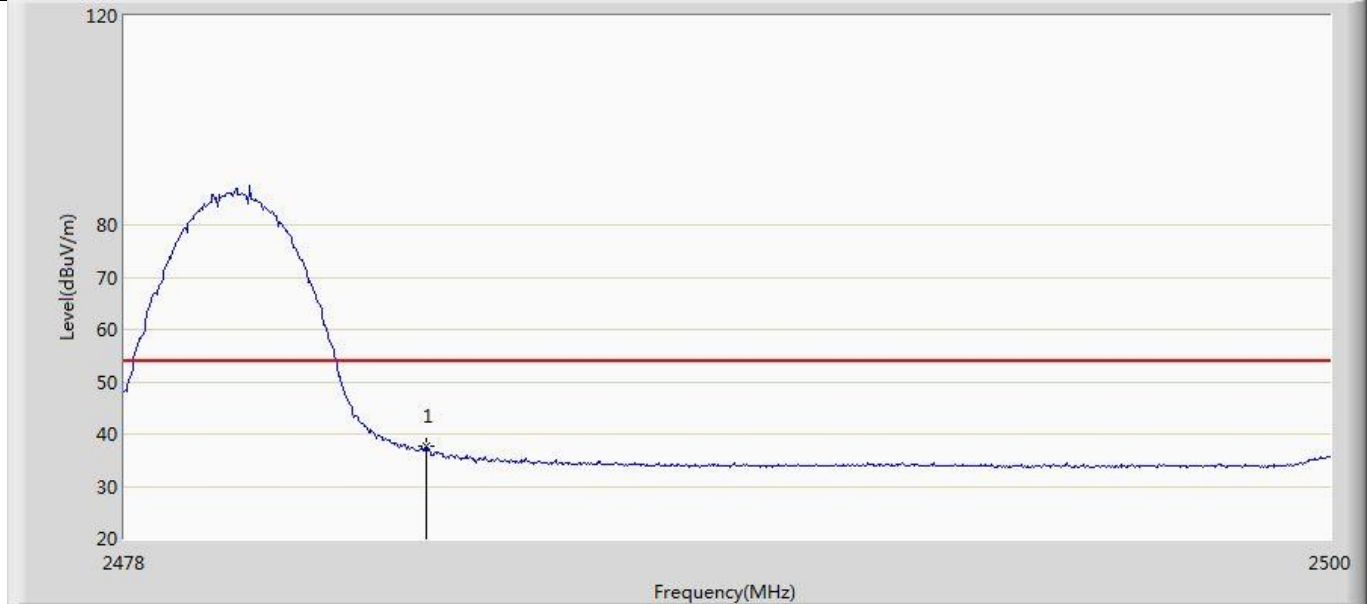

No	Mark	Frequency (MHz)	Measure Level (dBuV/m)	Reading Level (dBuV)	Over Limit (dB)	Limit (dBuV/m)	Factor (dB)	Type
1	*	2483.500	37.605	3.114	-16.395	54.000	34.491	AV

Profile: 2340773R	Page No.: 15
Engineer: Yuliu	
Site: AC5	Time: 2023/05/17 - 20:26
Limit: FCC_Part15.209_RE(3m)	Margin: 0
Probe: Horn_3117_00167055(1-18GHz)	Polarity: Vertical
EUT: Barcode Scanner	Power: By Battery
Note: Mode 2 : Transmit at 2480MHz by 2DH5	

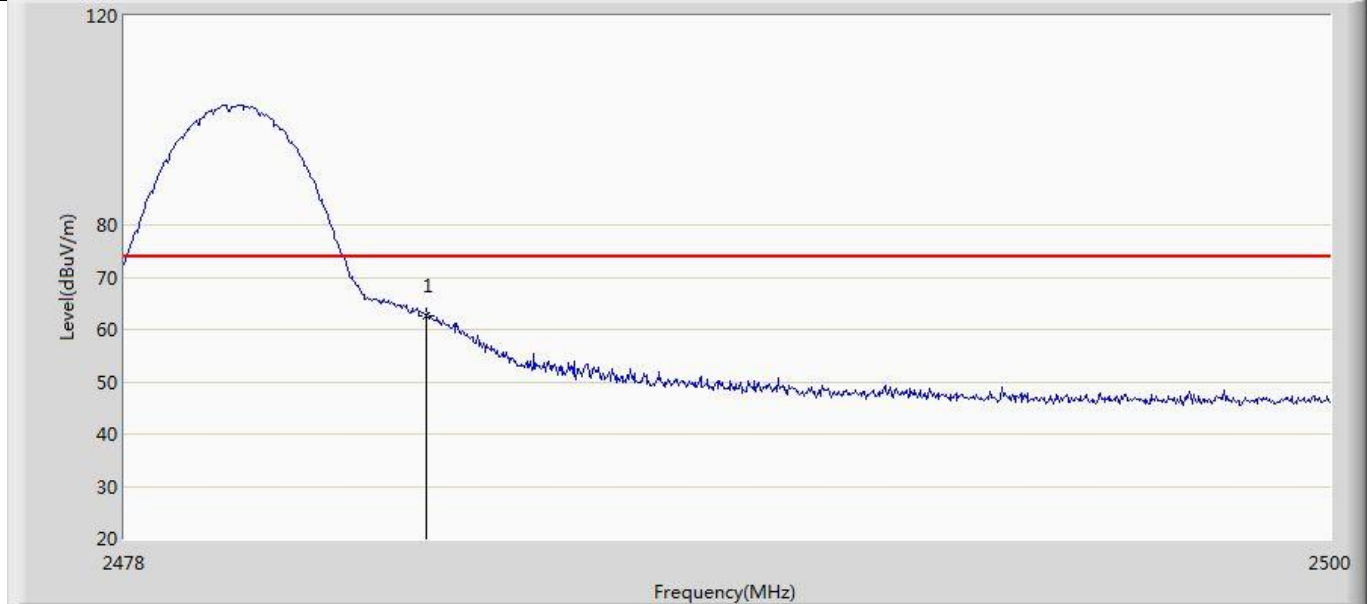

No	Mark	Frequency (MHz)	Measure Level (dBuV/m)	Reading Level (dBuV)	Over Limit (dB)	Limit (dBuV/m)	Factor (dB)	Type
1	*	2483.500	62.715	28.224	-11.285	74.000	34.491	PK

Profile: 2340773R	Page No.: 16
Engineer: Yuliu	
Site: AC5	Time: 2023/05/17 - 20:27
Limit: FCC_Part15.209_RE(3m)	Margin: 0
Probe: Horn_3117_00167055(1-18GHz)	Polarity: Vertical
EUT: Barcode Scanner	Power: By Battery
Note: Mode 2 : Transmit at 2480MHz by 2DH5	

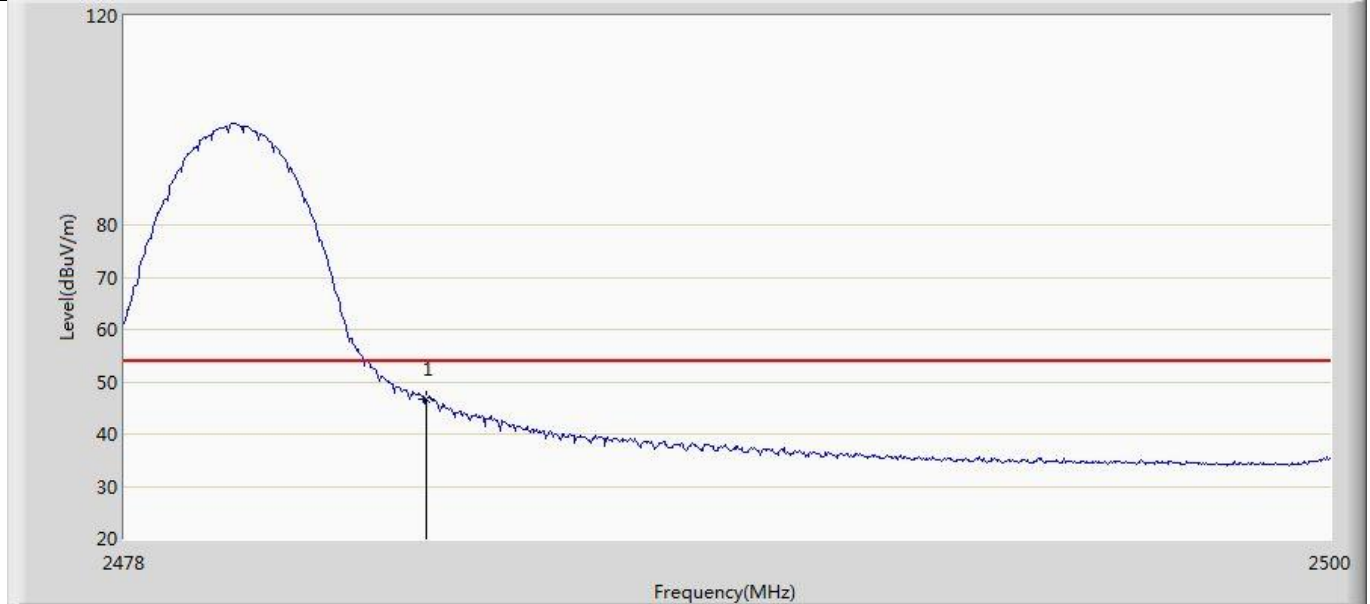

No	Mark	Frequency (MHz)	Measure Level (dBuV/m)	Reading Level (dBuV)	Over Limit (dB)	Limit (dBuV/m)	Factor (dB)	Type
1	*	2483.500	46.642	12.151	-7.358	54.000	34.491	AV

Profile: 2340773R	Page No.: 17
Engineer: Yuliu	
Site: AC5	Time: 2023/05/17 - 00:27
Limit: FCC_Part15.209_RE(3m)	Margin: 0
Probe: Horn_3117_00167055(1-18GHz)	Polarity: Horizontal
EUT: Barcode Scanner	Power: By Battery
Note: Mode 3 : Transmit at 2402MHz by 3DH5	

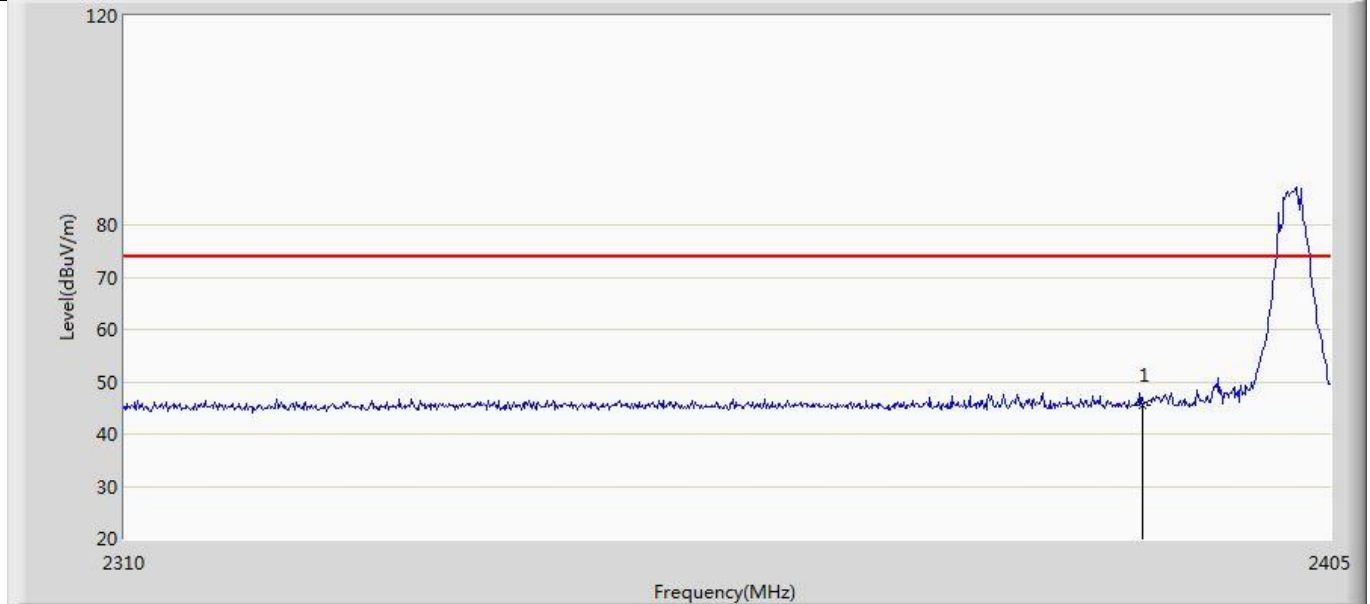

No	Mark	Frequency (MHz)	Measure Level (dBuV/m)	Reading Level (dBuV)	Over Limit (dB)	Limit (dBuV/m)	Factor (dB)	Type
1	*	2390.000	45.613	11.529	-28.387	74.000	34.084	PK

Profile: 2340773R	Page No.: 18
Engineer: Yuliu	
Site: AC5	Time: 2023/05/17 - 00:29
Limit: FCC_Part15.209_RE(3m)	Margin: 0
Probe: Horn_3117_00167055(1-18GHz)	Polarity: Horizontal
EUT: Barcode Scanner	Power: By Battery
Note: Mode 3 : Transmit at 2402MHz by 3DH5	

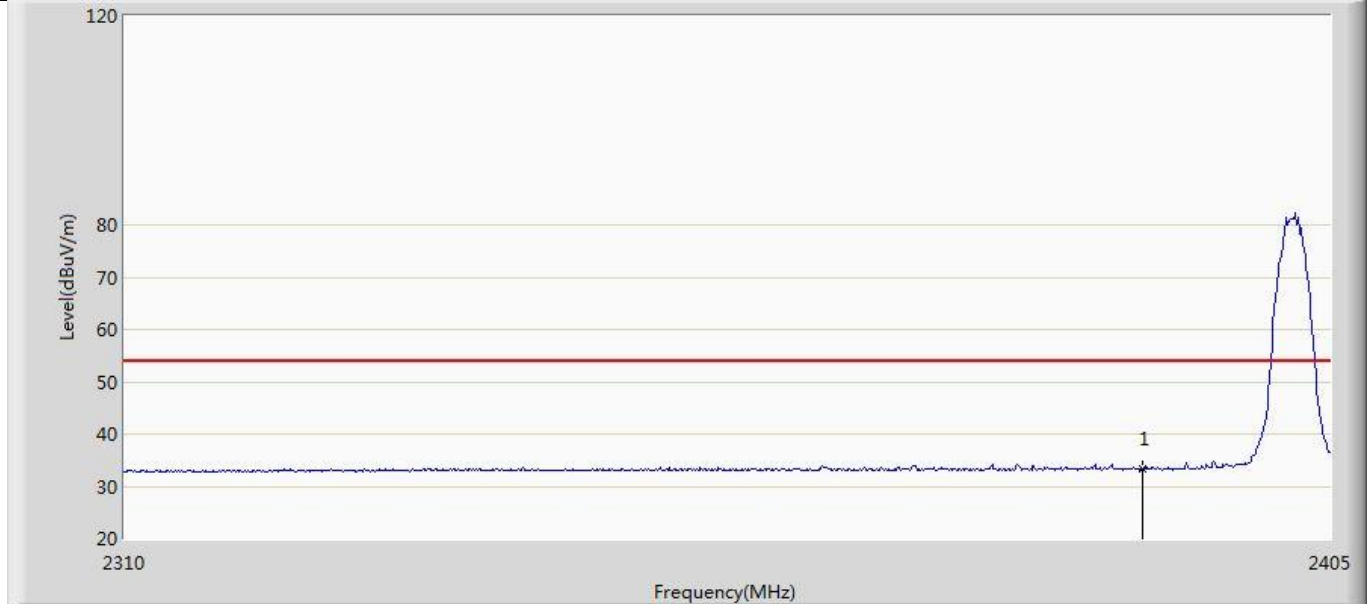

No	Mark	Frequency (MHz)	Measure Level (dBuV/m)	Reading Level (dBuV)	Over Limit (dB)	Limit (dBuV/m)	Factor (dB)	Type
1	*	2390.000	33.412	-0.672	-20.588	54.000	34.084	AV

Profile: 2340773R	Page No.: 19
Engineer: Yuliu	
Site: AC5	Time: 2023/05/17 - 00:30
Limit: FCC_Part15.209_RE(3m)	Margin: 0
Probe: Horn_3117_00167055(1-18GHz)	Polarity: Vertical
EUT: Barcode Scanner	Power: By Battery
Note: Mode 3 : Transmit at 2402MHz by 3DH5	

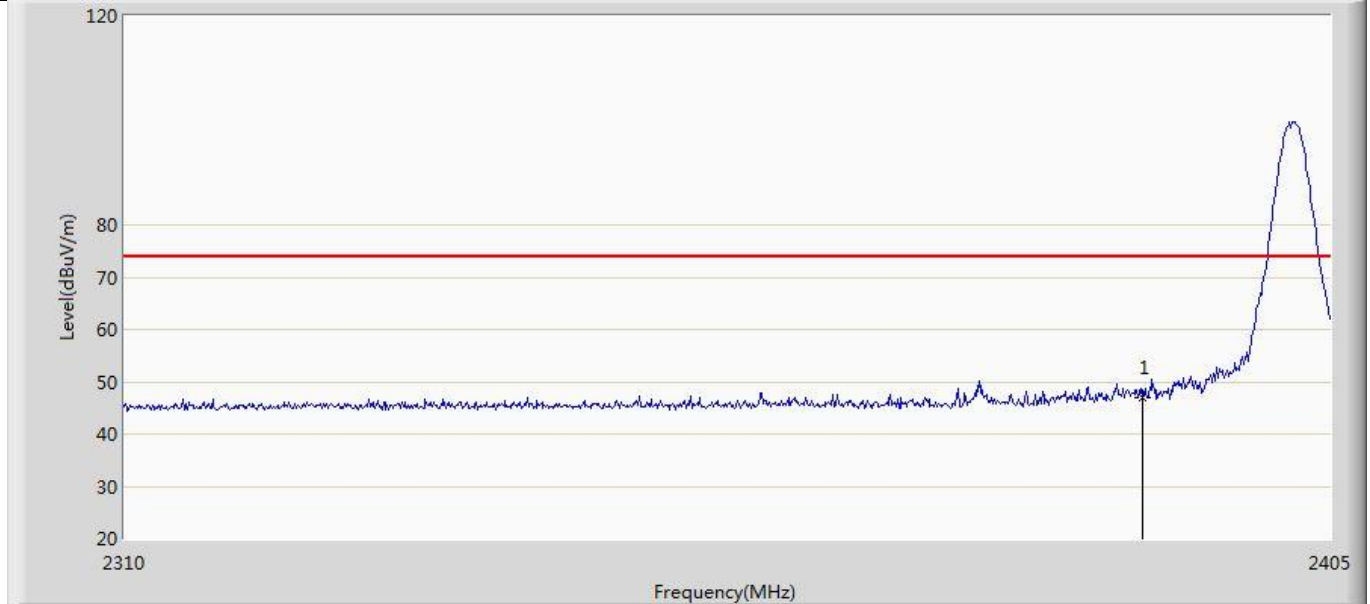

No	Mark	Frequency (MHz)	Measure Level (dBuV/m)	Reading Level (dBuV)	Over Limit (dB)	Limit (dBuV/m)	Factor (dB)	Type
1	*	2390.000	47.057	12.973	-26.943	74.000	34.084	PK

Profile: 2340773R	Page No.: 20
Engineer: Yuliu	
Site: AC5	Time: 2023/05/17 - 00:31
Limit: FCC_Part15.209_RE(3m)	Margin: 0
Probe: Horn_3117_00167055(1-18GHz)	Polarity: Vertical
EUT: Barcode Scanner	Power: By Battery
Note: Mode 3 : Transmit at 2402MHz by 3DH5	

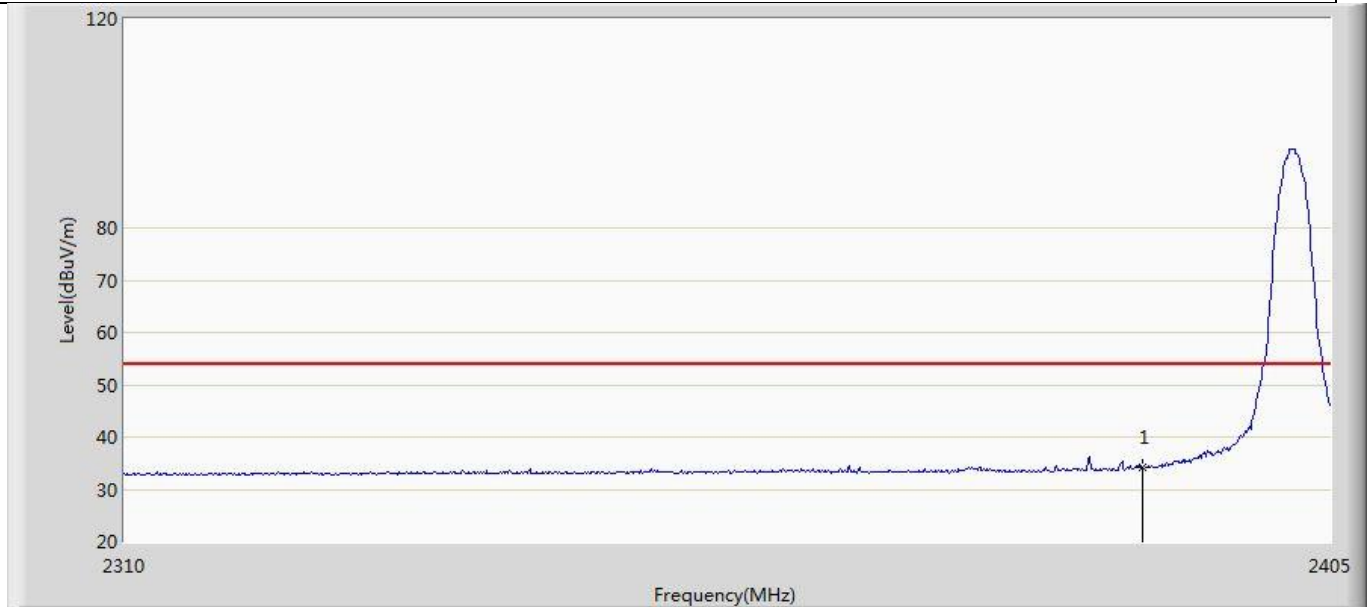

No	Mark	Frequency (MHz)	Measure Level (dBuV/m)	Reading Level (dBuV)	Over Limit (dB)	Limit (dBuV/m)	Factor (dB)	Type
1	*	2390.000	34.293	0.209	-19.707	54.000	34.084	AV

Profile: 2340773R	Page No.: 21
Engineer: Yuliu	
Site: AC5	Time: 2023/05/17 - 00:32
Limit: FCC_Part15.209_RE(3m)	Margin: 0
Probe: Horn_3117_00167055(1-18GHz)	Polarity: Horizontal
EUT: Barcode Scanner	Power: By Battery
Note: Mode 3 : Transmit at 2480MHz by 3DH5	

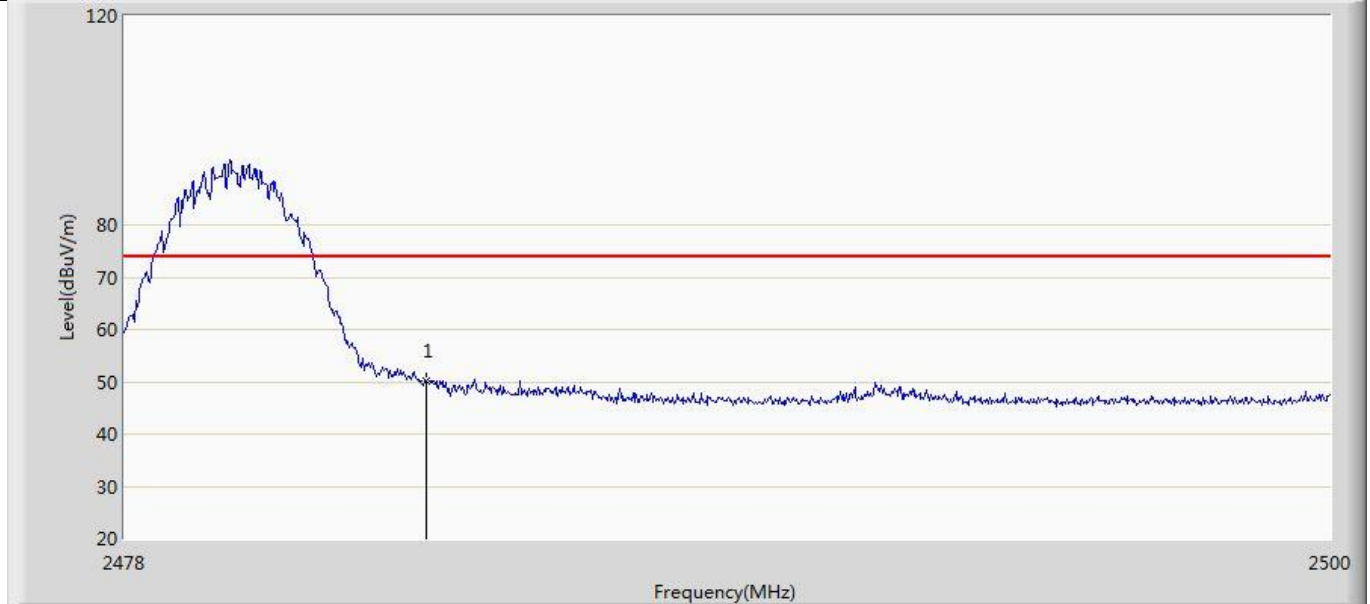

No	Mark	Frequency (MHz)	Measure Level (dBuV/m)	Reading Level (dBuV)	Over Limit (dB)	Limit (dBuV/m)	Factor (dB)	Type
1	*	2483.500	50.127	15.636	-23.873	74.000	34.491	PK

Profile: 2340773R	Page No.: 22
Engineer: Yuliu	
Site: AC5	Time: 2023/05/17 - 00:34
Limit: FCC_Part15.209_RE(3m)	Margin: 0
Probe: Horn_3117_00167055(1-18GHz)	Polarity: Horizontal
EUT: Barcode Scanner	Power: By Battery
Note: Mode 3 : Transmit at 2480MHz by 3DH5	

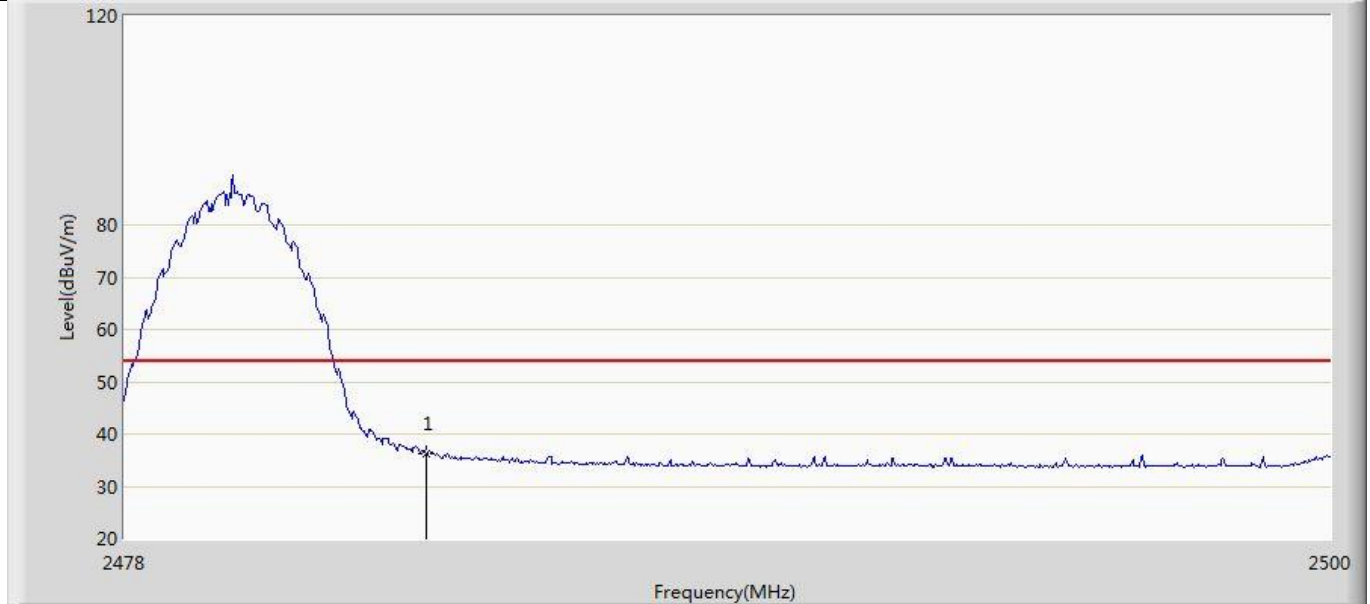

No	Mark	Frequency (MHz)	Measure Level (dBuV/m)	Reading Level (dBuV)	Over Limit (dB)	Limit (dBuV/m)	Factor (dB)	Type
1	*	2483.500	36.189	1.698	-17.811	54.000	34.491	AV

Profile: 2340773R	Page No.: 23
Engineer: Yuliu	
Site: AC5	Time: 2023/05/17 - 00:36
Limit: FCC_Part15.209_RE(3m)	Margin: 0
Probe: Horn_3117_00167055(1-18GHz)	Polarity: Vertical
EUT: Barcode Scanner	Power: By Battery
Note: Mode 3 : Transmit at 2480MHz by 3DH5	

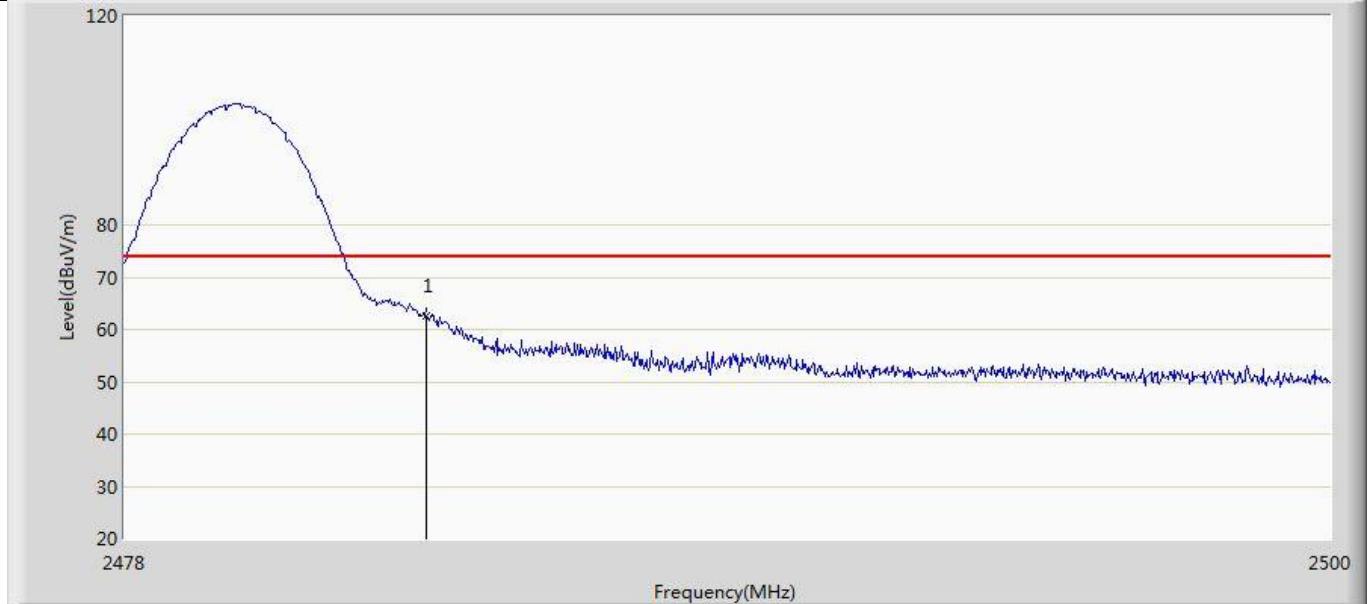

No	Mark	Frequency (MHz)	Measure Level (dBuV/m)	Reading Level (dBuV)	Over Limit (dB)	Limit (dBuV/m)	Factor (dB)	Type
1	*	2483.500	62.618	28.127	-11.382	74.000	34.491	PK

Profile: 2340773R	Page No.: 24
Engineer: Yuliu	
Site: AC5	Time: 2023/05/17 - 00:37
Limit: FCC_Part15.209_RE(3m)	Margin: 0
Probe: Horn_3117_00167055(1-18GHz)	Polarity: Vertical
EUT: Barcode Scanner	Power: By Battery
Note: Mode 3 : Transmit at 2480MHz by 3DH5	

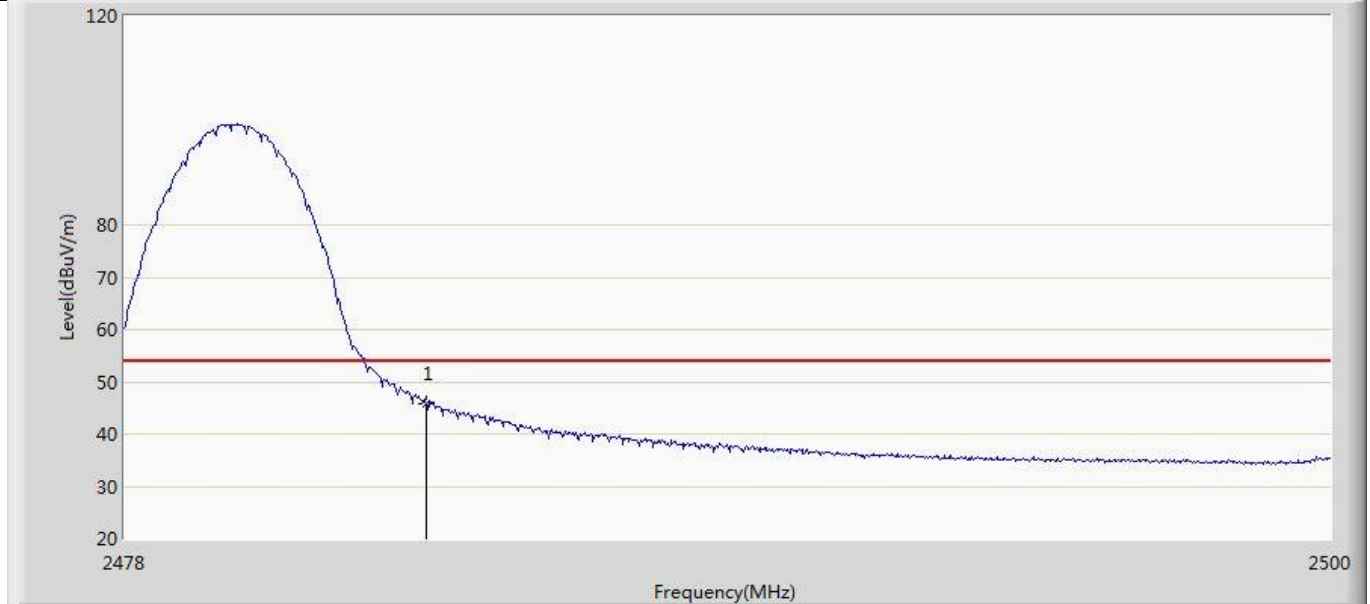

No	Mark	Frequency (MHz)	Measure Level (dBuV/m)	Reading Level (dBuV)	Over Limit (dB)	Limit (dBuV/m)	Factor (dB)	Type
1	*	2483.500	45.761	11.270	-8.239	54.000	34.491	AV

Appendix H: Conducted Spurious Emission

Test Result for Reference level :

TestMode	Freq(MHz)	Max.Point[MHz]	Result[dBm]
DH5	2402	2402.01	3.88
	2441	2441.18	4.56
	2480	2479.86	5.61
2DH5	2402	2402.18	4.16
	2441	2441.17	4.77
	2480	2480.04	4.95
3DH5	2402	2401.87	3.72
	2441	2441.18	4.72
	2480	2480.03	4.94

Test Result for Band edge :

TestMode	ChName	Frequency[MHz]	RefLevel [dBm]	Result [dBm]	Limit [dBm]	Verdict
DH5	Low	2402	3.88	-40.15	≤-26.12	PASS
	High	2480	5.61	-39.68	≤-24.39	PASS
	Low	Hop_2402	2.06	-40.72	≤-27.94	PASS
	High	Hop_2480	2.54	-39.93	≤-27.46	PASS
2DH5	Low	2402	4.16	-36.87	≤-25.84	PASS
	High	2480	4.95	-39.92	≤-25.05	PASS
	Low	Hop_2402	2.20	-40.54	≤-27.8	PASS
	High	Hop_2480	2.00	-38.98	≤-28	PASS
3DH5	Low	2402	3.72	-36.59	≤-26.28	PASS
	High	2480	4.94	-39.77	≤-25.06	PASS
	Low	Hop_2402	2.13	-40.02	≤-27.87	PASS
	High	Hop_2480	0.83	-40.1	≤-29.17	PASS

Test Result for Spurious Emission :

TestMode	Frequency[MHz]	FreqRange [MHz]	RefLevel [dBm]	Result [dBm]	Limit [dBm]	Verdict
DH5	2402	30~1000	3.88	-50.33	≤-26.12	PASS
		1000~3000	3.88	-48.36	≤-26.12	PASS
		3000~5000	3.88	-29.91	≤-26.12	PASS
		5000~7000	3.88	-47.15	≤-26.12	PASS
		7000~9000	3.88	-48.1	≤-26.12	PASS
		9000~11000	3.88	-48.03	≤-26.12	PASS
		11000~13000	3.88	-48.04	≤-26.12	PASS
		13000~15000	3.88	-43.74	≤-26.12	PASS
		15000~17000	3.88	-42.22	≤-26.12	PASS
		17000~19000	3.88	-41.69	≤-26.12	PASS
		19000~21000	3.88	-40.18	≤-26.12	PASS
		21000~23000	3.88	-39.3	≤-26.12	PASS
	23000~25000	3.88	-37.81	≤-26.12	PASS	
	2441	30~1000	4.56	-50.06	≤-25.44	PASS

		1000~3000	4.56	-48	≤-25.44	PASS
		3000~5000	4.56	-27.81	≤-25.44	PASS
		5000~7000	4.56	-47.68	≤-25.44	PASS
		7000~9000	4.56	-48.52	≤-25.44	PASS
		9000~11000	4.56	-47.9	≤-25.44	PASS
		11000~13000	4.56	-48.15	≤-25.44	PASS
		13000~15000	4.56	-44.07	≤-25.44	PASS
		15000~17000	4.56	-41.82	≤-25.44	PASS
		17000~19000	4.56	-41.53	≤-25.44	PASS
		19000~21000	4.56	-39.83	≤-25.44	PASS
		21000~23000	4.56	-40.15	≤-25.44	PASS
	23000~25000	4.56	-38.46	≤-25.44	PASS	
	2480	30~1000	5.61	-50.16	≤-24.39	PASS
		1000~3000	5.61	-48.47	≤-24.39	PASS
		3000~5000	5.61	-25.41	≤-24.39	PASS
		5000~7000	5.61	-47.85	≤-24.39	PASS
		7000~9000	5.61	-48.78	≤-24.39	PASS
		9000~11000	5.61	-48.15	≤-24.39	PASS
		11000~13000	5.61	-48.49	≤-24.39	PASS
		13000~15000	5.61	-43.13	≤-24.39	PASS
		15000~17000	5.61	-42.33	≤-24.39	PASS
		17000~19000	5.61	-41.43	≤-24.39	PASS
19000~21000		5.61	-40.48	≤-24.39	PASS	
21000~23000	5.61	-40.14	≤-24.39	PASS		
23000~25000	5.61	-38.68	≤-24.39	PASS		
2DH5	2402	30~1000	4.16	-50.05	≤-25.84	PASS
		1000~3000	4.16	-48.15	≤-25.84	PASS
		3000~5000	4.16	-32.73	≤-25.84	PASS
		5000~7000	4.16	-47.49	≤-25.84	PASS
		7000~9000	4.16	-49.27	≤-25.84	PASS
		9000~11000	4.16	-47.74	≤-25.84	PASS
		11000~13000	4.16	-48.66	≤-25.84	PASS
		13000~15000	4.16	-43.54	≤-25.84	PASS
		15000~17000	4.16	-41.52	≤-25.84	PASS
		17000~19000	4.16	-40.32	≤-25.84	PASS
		19000~21000	4.16	-40.21	≤-25.84	PASS
	21000~23000	4.16	-39.93	≤-25.84	PASS	
	23000~25000	4.16	-37.68	≤-25.84	PASS	
	2441	30~1000	4.77	-49.8	≤-25.23	PASS
		1000~3000	4.77	-48.33	≤-25.23	PASS
		3000~5000	4.77	-29.03	≤-25.23	PASS
		5000~7000	4.77	-47.74	≤-25.23	PASS
		7000~9000	4.77	-48.29	≤-25.23	PASS
		9000~11000	4.77	-48.26	≤-25.23	PASS
		11000~13000	4.77	-47.66	≤-25.23	PASS
		13000~15000	4.77	-43.56	≤-25.23	PASS
		15000~17000	4.77	-42.29	≤-25.23	PASS
17000~19000		4.77	-41.05	≤-25.23	PASS	
19000~21000		4.77	-39.57	≤-25.23	PASS	
21000~23000	4.77	-39.73	≤-25.23	PASS		
23000~25000	4.77	-38.29	≤-25.23	PASS		

	2480	30~1000	4.95	-50.82	≤-25.05	PASS
		1000~3000	4.95	-48.74	≤-25.05	PASS
		3000~5000	4.95	-28.85	≤-25.05	PASS
		5000~7000	4.95	-47.21	≤-25.05	PASS
		7000~9000	4.95	-48.96	≤-25.05	PASS
		9000~11000	4.95	-48.29	≤-25.05	PASS
		11000~13000	4.95	-48.83	≤-25.05	PASS
		13000~15000	4.95	-44.29	≤-25.05	PASS
		15000~17000	4.95	-42.66	≤-25.05	PASS
		17000~19000	4.95	-42.09	≤-25.05	PASS
		19000~21000	4.95	-40.21	≤-25.05	PASS
		21000~23000	4.95	-40.2	≤-25.05	PASS
3DH5	2402	30~1000	3.72	-50.8	≤-26.28	PASS
		1000~3000	3.72	-48.66	≤-26.28	PASS
		3000~5000	3.72	-31.53	≤-26.28	PASS
		5000~7000	3.72	-47.78	≤-26.28	PASS
		7000~9000	3.72	-48.06	≤-26.28	PASS
		9000~11000	3.72	-47.32	≤-26.28	PASS
		11000~13000	3.72	-47.22	≤-26.28	PASS
		13000~15000	3.72	-44.26	≤-26.28	PASS
		15000~17000	3.72	-42.48	≤-26.28	PASS
		17000~19000	3.72	-41.25	≤-26.28	PASS
		19000~21000	3.72	-40.47	≤-26.28	PASS
		21000~23000	3.72	-40.28	≤-26.28	PASS
	23000~25000	3.72	-38.26	≤-26.28	PASS	
	2441	30~1000	4.72	-50.47	≤-25.28	PASS
		1000~3000	4.72	-48.68	≤-25.28	PASS
		3000~5000	4.72	-27.87	≤-25.28	PASS
		5000~7000	4.72	-47.8	≤-25.28	PASS
		7000~9000	4.72	-48.82	≤-25.28	PASS
		9000~11000	4.72	-48.22	≤-25.28	PASS
		11000~13000	4.72	-48.51	≤-25.28	PASS
		13000~15000	4.72	-43.79	≤-25.28	PASS
		15000~17000	4.72	-42.2	≤-25.28	PASS
		17000~19000	4.72	-41.98	≤-25.28	PASS
		19000~21000	4.72	-39.61	≤-25.28	PASS
21000~23000		4.72	-39.46	≤-25.28	PASS	
23000~25000	4.72	-38.61	≤-25.28	PASS		
2480	30~1000	4.94	-50.27	≤-25.06	PASS	
	1000~3000	4.94	-48.62	≤-25.06	PASS	
	3000~5000	4.94	-25.96	≤-25.06	PASS	
	5000~7000	4.94	-48.23	≤-25.06	PASS	
	7000~9000	4.94	-48.85	≤-25.06	PASS	
	9000~11000	4.94	-48.32	≤-25.06	PASS	
	11000~13000	4.94	-48.77	≤-25.06	PASS	
	13000~15000	4.94	-44.19	≤-25.06	PASS	
	15000~17000	4.94	-42.41	≤-25.06	PASS	
	17000~19000	4.94	-42.08	≤-25.06	PASS	
	19000~21000	4.94	-40.1	≤-25.06	PASS	
	21000~23000	4.94	-39.39	≤-25.06	PASS	

		23000~25000	4.94	-38.36	≤-25.06	PASS
--	--	-------------	------	--------	---------	------

Test Graphs for Reference level :

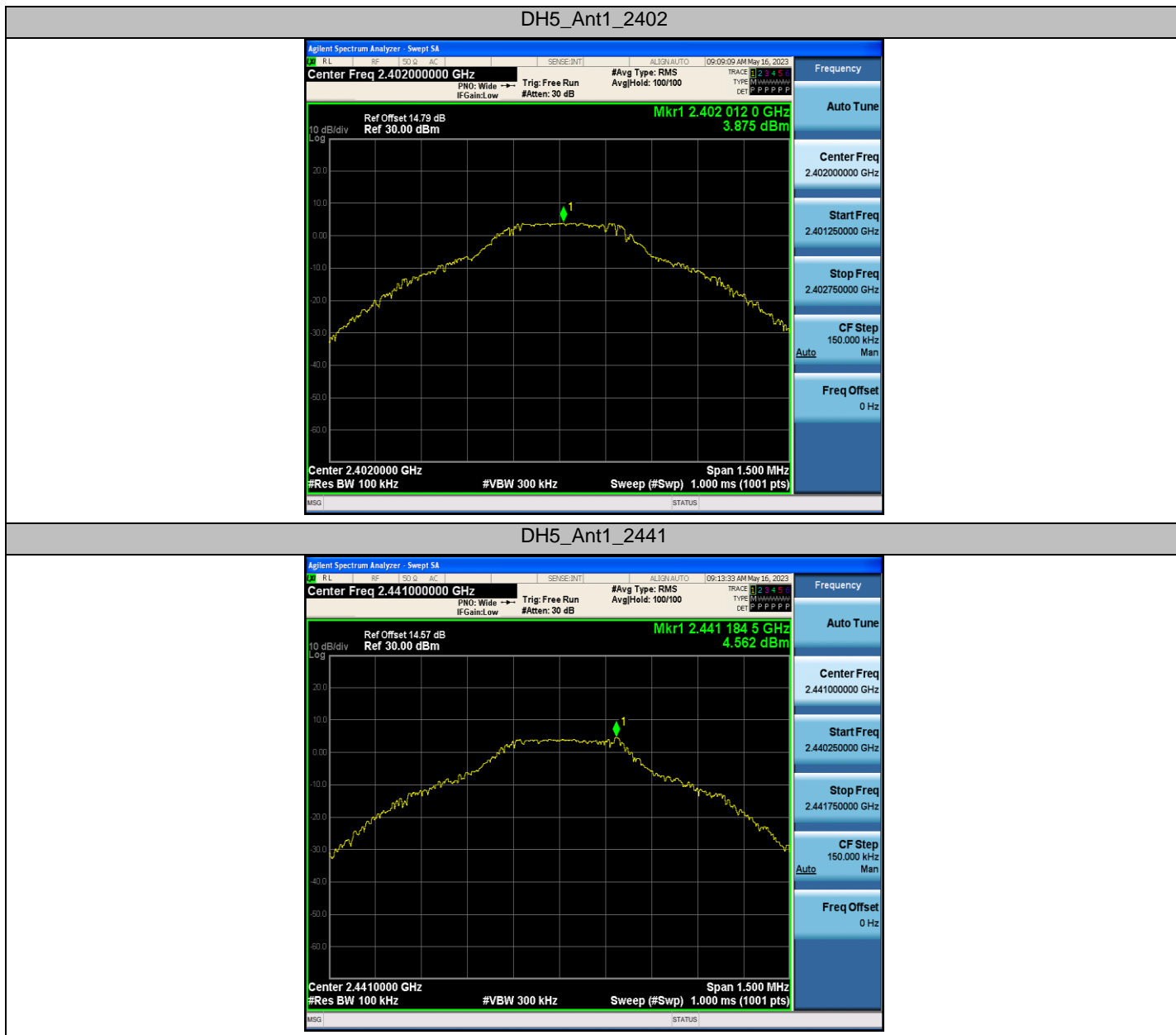

DH5_Ant1_2480



2DH5_Ant1_2402



2DH5_Ant1_2441



2DH5_Ant1_2480

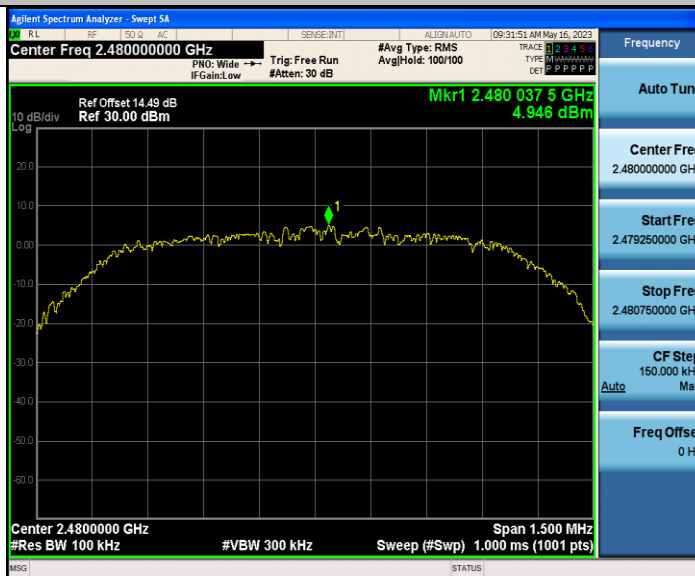

3DH5_Ant1_2402

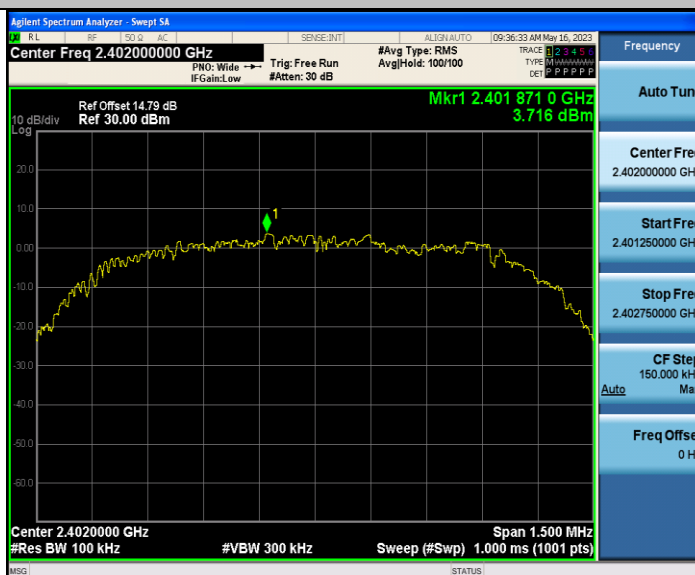

3DH5_Ant1_2441



3DH5_Ant1_2480



Test Graphs for Band edge :

DH5_Ant1_Low_2402

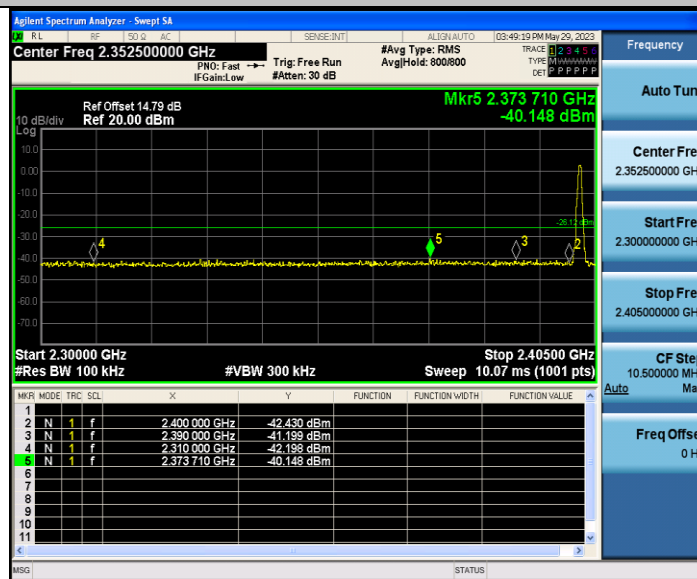

DH5_Ant1_High_2480

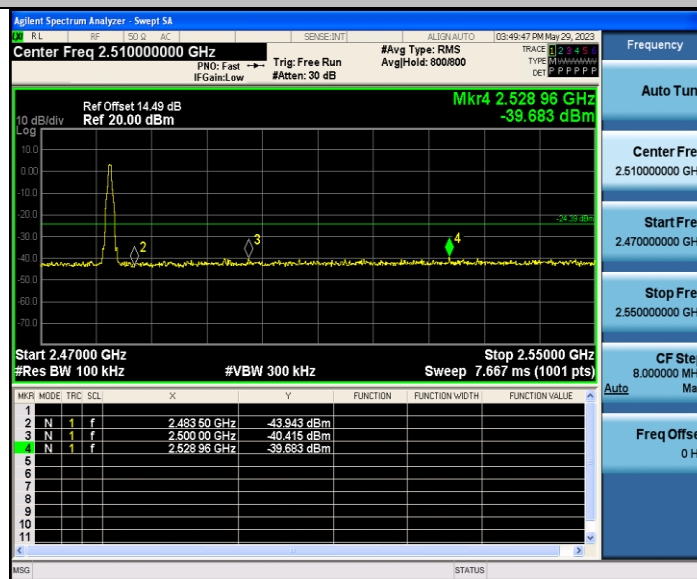

DH5_Ant1_Low_Hop_2402

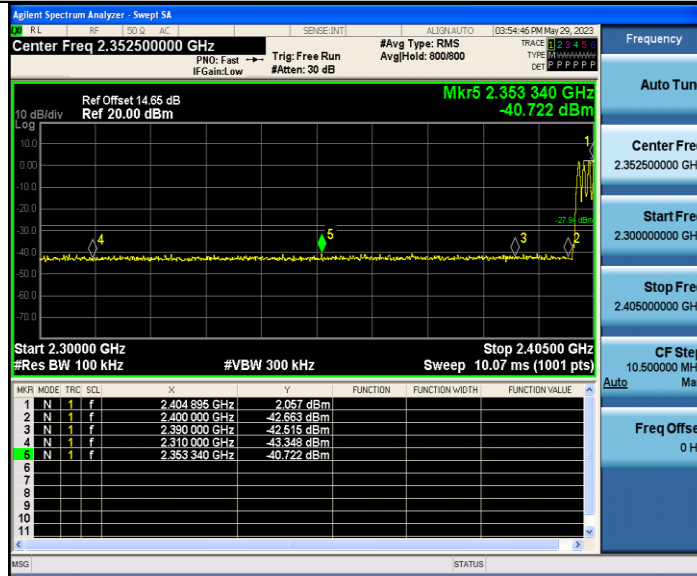

DH5_Ant1_High_Hop_2480

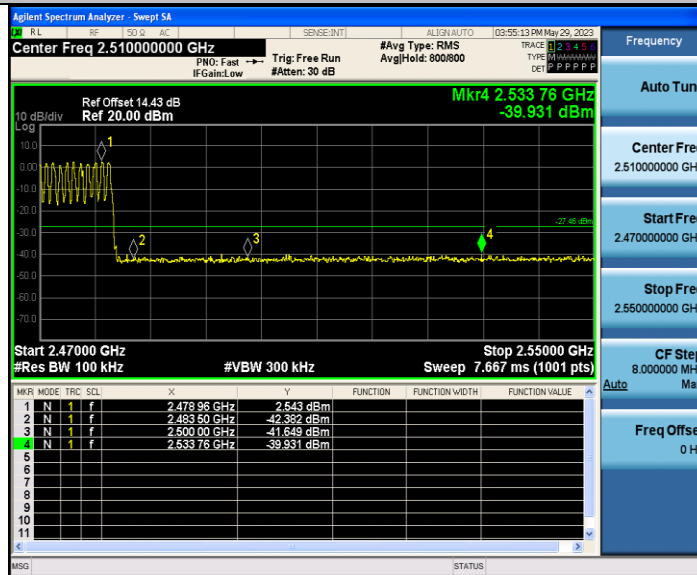

2DH5_Ant1_Low_2402

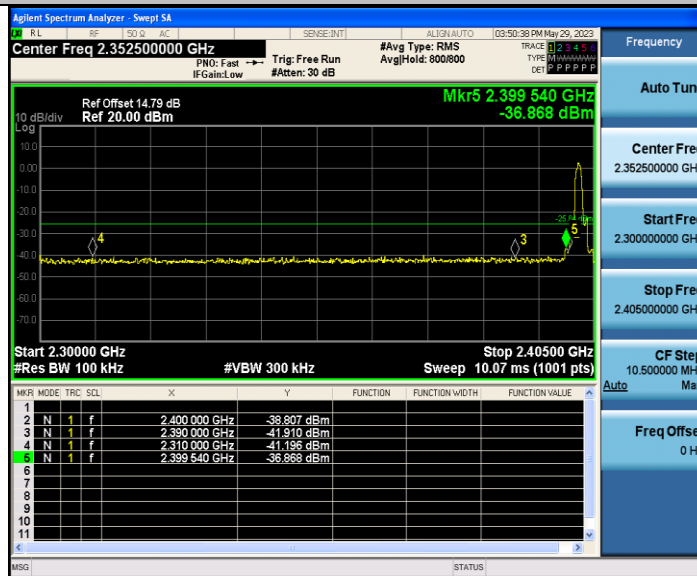

2DH5_Ant1_High_2480

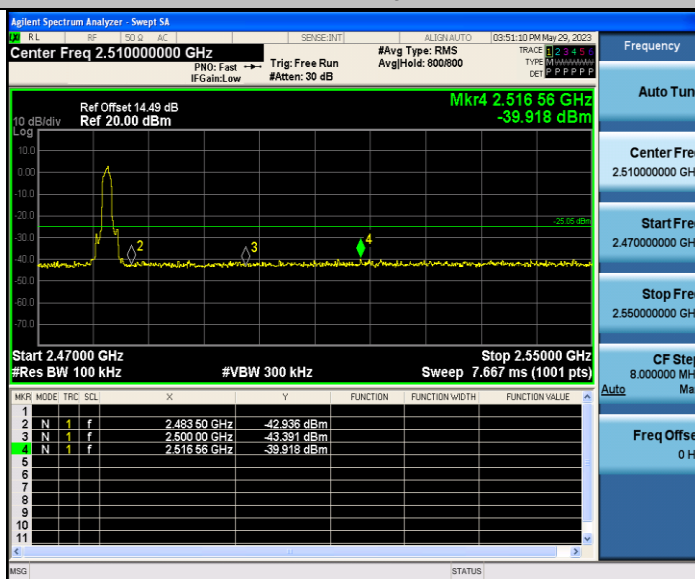

2DH5_Ant1_Low_Hop_2402

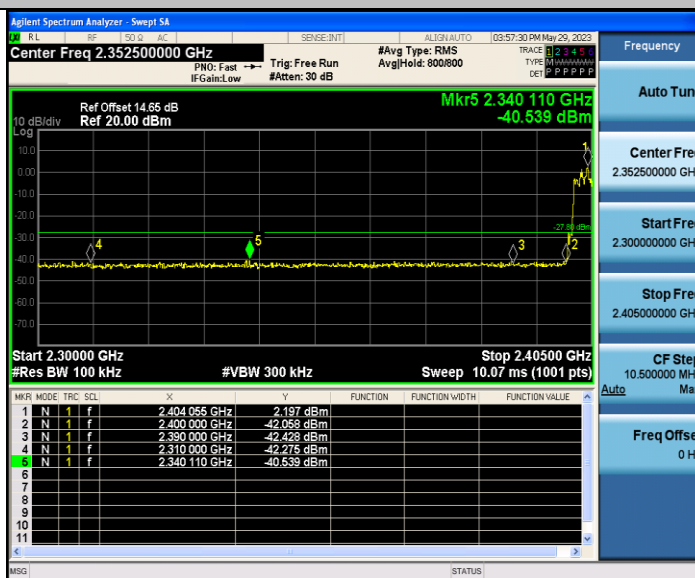

2DH5_Ant1_High_Hop_2480

