

Overview

The Intercom has up to a 1000' range and allows multiple simultaneous conversations, using a 900 MHz secure digital radio link. The intercoms form an exclusive network and respond only to other intercoms in the network.

Carton Inventory

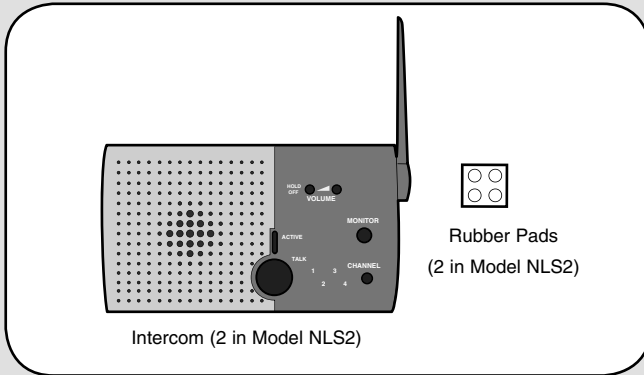

Operation & Features

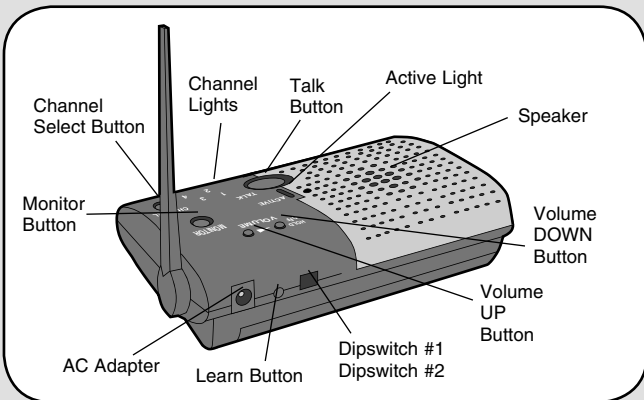

On/Off: To turn intercom ON, press Talk button. To turn intercom OFF, hold down the Volume DOWN button for 3 seconds.

Talk Button: To talk, hold down the Talk button. All intercoms in the network that are on the same channel will receive the signal. Release the Talk button when done talking and within 10-15 seconds press and hold the Talk button of a different intercom to make a secure channel between the two. Once the channel is made the other intercoms in the network cannot hear the conversation.

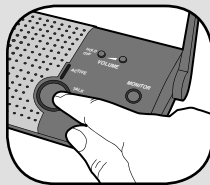

Volume: Pressing the Volume DOWN button will lower the volume and pressing the Volume UP button will increase the volume. The lowest volume setting will mute the intercom.

Channel Select Button: Press the Channel Select button to set intercom to one of four secure channels or the paging channel. The default channel for the intercom is the paging channel where all four channel lights are lit. An intercom on a channel can only hear an intercom on the same channel or on the paging channel.

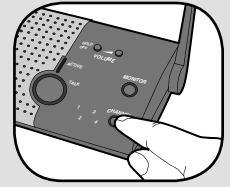

Battery: The AA Alkaline batteries (not provided) will last up to a year depending on use. When batteries are low intercom will emit two beeps every ten minutes. An AC Adapter (not provided) can also be used to power the intercom. In this case, both the power and channel lights will remain on.



Conference Mode: Conference Mode allows multiple intercoms to participate in a conversation compared to Normal Mode in which only two intercoms can communicate. All intercoms must be set to the same channel or the paging channel to be in Conference Mode. To put intercom in Conference Mode set Dipswitch #2 to UP position.



Monitor Mode: Monitor Mode is used to monitor the noise in a specific room. Place the intercom in the room that is to be monitored and press the Monitor button until a tone is heard. While in monitor mode the Active light will blink if no sound is heard and will be solid if sounds are heard. Any other networked intercom can listen to that room. If a specific channel is selected for Monitor Mode then only other intercoms on that channel or on the paging channel can listen. Press the Monitor button again to exit Monitor Mode. A tone will be heard indicating Monitor Mode is no longer active.

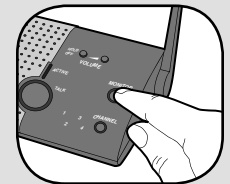

Voice Activation Mode (VOX): Voice Activation Mode (VOX) allows a call to be answered without pressing the Talk button. Once a call is heard on an intercom which has been set to VOX, a response can be given by speaking loudly into the intercom. There will be a slight delay when VOX is first activated by a voice, but will continue to transmit audio until the speaking stops. To put intercom into VOX, place Dipswitch #1 to the UP position. While in VOX mode, a call may be initiated by pressing the TALK button.



Assemble Intercom

Step 1

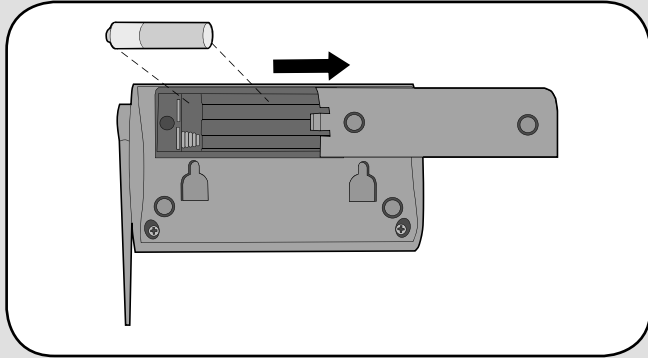

Install 4 AA Alkaline batteries (not provided).

Step 2

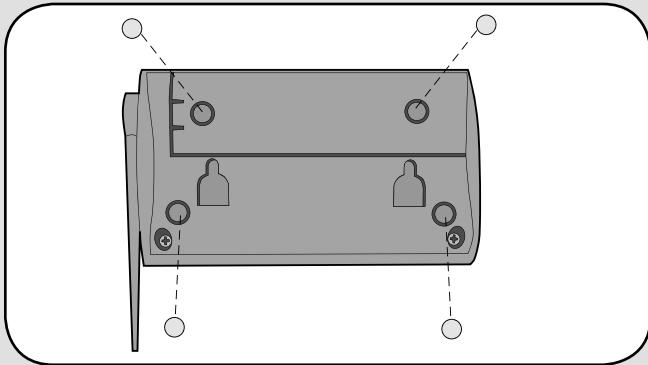

Adhere rubber pads to bottom.
Repeat Steps 1 and 2 for any additional intercoms.



Programming Intercom

The intercom must be programmed to at least one other intercom to become a network or it can be programmed into an existing network.

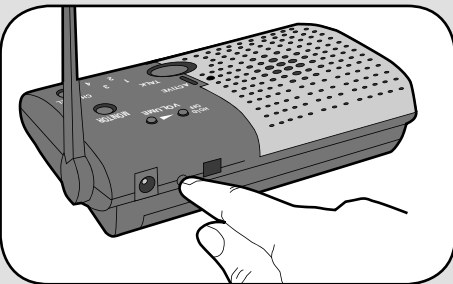
Create New Network

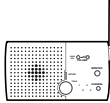

Press the Learn button on the new intercom until a beep is heard. Within 10 seconds put the second intercom into Learn Mode (refer to the following table).



INTERCOM	LEARN MODE
 OR 	Press the Learn button until a beep is heard.
	Press and hold both buttons for 5 seconds.

Each intercom will emit a tone when programmed into network. Repeat for any additional intercoms.

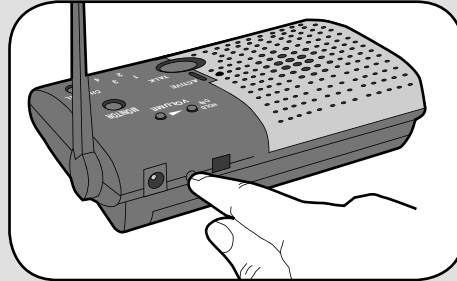
Add to an Existing Network

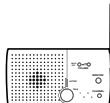

Press the Learn button on the new intercom until a beep is heard. Within 10 seconds put any networked intercom into Learn Mode (refer to table below).

INTERCOM	LEARN MODE
 OR 	Press the Learn button until a beep is heard.
	Press and hold both buttons for 5 seconds.

Each intercom will emit a tone when programmed into network. Repeat for any additional intercoms.

NOTE: Do not program new intercoms to each other before adding them to the network or they will form a separate network and the memory will need to be cleared.

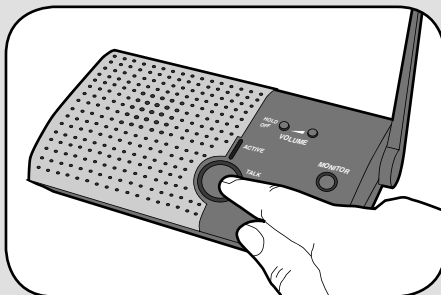

Press and release the Talk button to verify network is complete.

Troubleshooting

Intercom does not function.

Check batteries in intercom. If using an AC Adapter ensure that it is plugged in.

Ensure intercom is connected to a network.

See Programming Intercom.

Ensure that intercoms are on the same channel. See Operation & Features.

Intercom is not getting expected transmission range.

Keep antenna vertical. Keep intercom away from metal objects and electrical wiring. Cell phones, cordless phones, or other radio devices may also limit range.

Intercom beeps every ten minutes.

The battery is low in the intercom. Replace with AA Alkaline batteries or operate it with AC Adapter (not provided). A 12 volt, 300mA AC Adapter may be used (center positive polarity on the round plug).

Static and feedback is heard in intercom.

The intercoms are too close to each other. A cordless phone, cell phone, or other radio devices can also cause static.

Need to clear intercom's memory.

Press and hold Learn button, an initial beep will be heard. Continue to hold until a second beep is heard (about 15 seconds). Ensure other intercoms are not activated during this time. Intercoms in the network that are on will signal during the clearing process. Once memory is clear the intercom can be programmed to a new network.

Intercom is sending audio while no buttons are pressed.

The sending intercom is set to Monitoring Mode or Voice Activation Mode and will activate when sound is heard. It can be taken out of Monitoring Mode by pressing the Talk button. It can be taken out of Voice Activation Mode by setting Dipswitch #1 to DOWN position. See Operation & Features.

NOTE: *Manufacturer is not responsible for any radio or TV interference caused by unauthorized modifications to this equipment. Changes or modifications not expressly approved by the manufacturer could void the authority to operate the equipment.*

One Year Limited Warranty

The Chamberlain Group, Inc. warrants to the first retail purchaser of this product that it is free from defect in materials and/or workmanship for a period of 1 year from the date of purchase.

FOR TECHNICAL SUPPORT DIAL OUR TOLL FREE NUMBER:

1-800-528-9131

www.chamberlain-DIY.com

NOTICE: To comply with FCC and or Industry Canada rules (IC), adjustment or modifications of this receiver and/or transmitter are prohibited, except for changing the code setting or replacing the battery. THERE ARE NO OTHER USER SERVICEABLE PARTS.

Tested to Comply with FCC Standards FOR HOME OR OFFICE USE. Operation is subject to the following two conditions: (1) this device may not cause harmful interference, and (2) this device must accept any interference received, including interference that may cause undesired operation.