

# EMC EMISSION - TEST REPORT

## UNITED STATES STANDARD 47 CFR PART 15, SUBPART B

Test Report File No. : **9264-06**      Date of Issue: 08 June 1999

Model / Serial No. : RS321 / ----

Product Type : Handheld Transmitter

Applicant : RADIO SHACK

Manufacturer : RADIO SHACK

License holder : RADIO SHACK

Address : 100 Throckmorton Street, Suite 1300  
 : Fort Worth, TX 76102

Test Result :     **Positive**       **Negative**

Test Project Number Reference(s) : 9264-06

Total pages - Test Report : 11

NOTE: All test equipment used during testing is calibrated and traceable to NIST.

*TÜV Product Service reports apply only to the specific sample tested under stated test conditions. It is the manufacturer's responsibility to assure the continued compliance of production units of this model. TÜV Product Service, Inc. shall have no liability for any deductions, inferences or generalizations drawn by the client or others from TÜV Product Service, Inc. issued reports.*

*This report is the confidential property of the client. As a mutual protection to our clients, the public and ourselves, extracts from the test report shall not be reproduced except in full without our written approval. This report shall not be used by the client to claim product endorsement by NVLAP or any agency of the US government.*

*TÜV Product Service, Inc. and its professional staff hold government and professional organization certifications and are members of AAMI, ACIL, AEA, ANSI, IEEE, NVLAP, and VCCI*

**DIRECTORY - EMISSIONS  
Test Report**

	<b>Pages</b>
Test Report	1 - 11
Directory	2
Test Regulations	3
General Remarks and Summary	11
Equipment	
Conducted Emissions	5
Radiated Emissions                      30 - 1000 MHz	6
20 dB Bandwidth	7
Radiated Emissions                      300 - 1200 MHz	8
Duty Cycle	9

**Technical Documentation**

Test Data Sheets and Test Setup Drawing(s)	TD1
--	-----

**Appendices**

<b>Appendix A</b>	A1
Test Setups (Photographs)	
<b>Appendix B</b>	B1
Product Information Form(s)	
<b>Appendix C</b>	C1
Change History	
<b>Appendix D</b>	D1
Supplemental Information	

## EMISSIONS TEST REGULATIONS :

The emissions tests were performed according to the following regulations:

- EN 50081-1 / 1991
- EN 55011 / 1991
- EN 55013 / 1990
- EN 55014 / 1987
- EN 55014 / A2:1990
- EN 55014 / 1993
- EN 55015 / 1987
- EN 55015 / A1:1990
- EN 55015 / 1993
- EN 55022 / 1987
- EN 55022 / 1998
- BS
- VCCI
- 47 CFR Part 15, Subpart B
  - 207(a)
  - 209(a)
  - 231(b)(c)
  - Duty cycle
- AS/NZS 3548: 1995
- CISPR 11 (1990)
- CISPR 22 (1998)
- Group 1
- Group 2
- Class A
- Class B
- Household appliances and similar
- Portable tools
- Semiconductor devices
- Household appliances and similar
- Portable tools
- Semiconductor devices
- Class A
- Class B
- Class A ITE
- Class B ITE
- Class A
- Class B
- Class A
- Class B
- Class A
- Class B
- Class A
- Class B
- Class A
- Class B

**Environmental Conditions In The Laboratory:**

	<u>Actual</u>
Temperature:	: 23 °C
Relative Humidity:	: 50 %
Atmospheric Pressure:	: 100.0 kPa

**Power Supply Utilized:**

Power supply system : Battery

**Symbol Definitions:**

- - Applicable
- - Not Applicable

## Emissions Test Conditions: CONDUCTED EMISSIONS (Interference Voltage)

The **CONDUCTED EMISSIONS (INTERFERENCE VOLTAGE)** measurements were performed at the following test location:

■ - Test not performed - see remarks

- SR-2, Shielded Room, 12' x 24' x 10', Metal Chamber
- SR-3, Shielded Room, 12' x 20' x 8', Metal Chamber
- SR-4, Shielded Room, 10' x 17' x 8', Copper Screen Chamber
- SR-5, Shielded Room, 16' x 28' x 15', Metal, Semi-Anechoic Chamber
- CSR-1, Shielded Room, 10' x 7' x 7', Metal Chamber

### Test Equipment Used :

Model No.	Prop. No.	Description	Manufacturer	Serial No.	Cal Due Date
NM-7A, NM-17/27, NM-37/57, NM-67, CCA-7, & H/P 9836 HP-1B Computer	156, 162-166	Automated RFI Measurement System (ARMS), NO. 1	Eaton/Ailtech	(multiple)	
NM-17/27, NM-37/57, CA-7, and H/P 9826 Computer	168, 170, 177, 178	Automated RFI Measurement System (ARMS), NO. 2	Eaton/Ailtech	(multiple)	
H/P Spectrum Analyzer, Model 8568B; Display Section RF Analyzer Section; H/P 85650A, Quasi-Peak Adapter H/P Computer System, Model 310 with HP 85869A Software	187, 188	Automated RFI Measurement System (ARMS)	Various	(multiple)	
LISN-2, 25 A	413	Power Mains Network (LISN), 50 $\mu$ H/250 $\mu$ H/50 $\Omega$ /0.25 $\mu$ F	Fischer Custom Communications, Inc.	7	
LISN-2, 25 A	--	Power Mains Network (LISN), 50 $\mu$ H/250 $\mu$ H/50 $\Omega$ /0.25 $\mu$ F	Fischer Custom Communications, Inc.	7	
FCC-LISN-50-25-2	553	Power Mains Network (LISN), 50 $\mu$ H/250 $\mu$ H/50 $\Omega$ /0.25 $\mu$ F	Fischer Custom Communications, Inc.	112	
FCC-LISN-50-25-2	552	Power Mains Network (LISN), 50 $\mu$ H/250 $\mu$ H/50 $\Omega$ /0.25 $\mu$ F	Fischer Custom Communications, Inc.	113	
8012-50-R-12-BNC	266	LISN, 50 $\mu$ H/50 $\Omega$ /0.1 $\mu$ F	Solar Electronics Co.	--	
9252-50-R-24-BNC	458	LISN, 50 $\mu$ H /250 $\mu$ H/50 $\Omega$ / 0.25 $\mu$ F	Solar Electronics Co.	941719	
MDS-21	277	Absorbing Clamp	Rohde & Schwarz	821023	
ESHS 20	428	EMI Test Receiver	Rohde & Schwarz	837055/001	
ESHS 30	459	EMI Test Receiver	Rohde & Schwarz	832354/004	
CAT-20	598	20 dB Attenuator	Mini-Circuits	--	
CAT-20	615	20 dB Attenuator	Mini-Circuits	--	

Remarks: One year calibration cycle for all test equipment.

EUT battery operated.

### Emissions Test Conditions: RADIATED EMISSIONS (Electric Field)

The *RADIATED EMISSIONS (ELECTRIC FIELD)* measurements, in the frequency range of 30 MHz-1000 MHz, were tested in a horizontal and vertical polarization at the following test location :

■ - Test not performed - see remarks

- Roof (Small Open Area Test Site) (Calibration Due Date: 28 May 2000)
- Canyon #1 (10- and 30-Meter Open Area Test Site), Carroll Canyon, San Diego (Calibration Due Date: 21 July 1999)
- Canyon #2 (3- and 10-Meter Open Area Test Site), Carroll Canyon, San Diego (Calibration Due Date: 20 May 2000)

Testing was performed at a test distance of :

- 3 meters
- 10 meters
- 30 meters

#### Test Equipment Used :

Model No.	Prop. No.	Description	Manufacturer	Serial No.	Cal Date
NM-37/57A	420	OATS measurement set	Eaton/Ailtech	0561-09261	
CCA-7	373	(Roof)		0773-03117	
NM-37/57	171	OATS measurement set	Eaton/Ailtech	0709-82078	
CCA-7	172	(Canyon)		0187-0322	
HFH 2-Z2	208	Antenna, Loop	Rohde & Schwarz	880	
3110B	491	Antenna, Biconical	EMCO	9508-2	
CBL6111	460	Antenna, Bilog	Chase	1013	
CBL6111	461	Antenna, Bilog	Chase	1291	
3146	242	Antenna, Log Periodic Dipole	EMCO	1597	
3146	243	Antenna, Log Periodic Dipole	EMCO	106X	
3146	244	Antenna, Log Periodic Dipole	EMCO	1063	
7405	570	Loop Probes	EMCO	9104-1959	
8566B	404	Spectrum Analyzer	Hewlett Packard	2311A02209	
85662B	406	Spectrum Analyzer Display	Hewlett Packard	2309A04682	
ESVS 30	427	EMI Test Receiver	Rohde & Schwarz	830350/006	
ESVS 30	466	EMI Test Receiver	Rohde & Schwarz	833825/003	

Remarks: One year calibration cycle for all test equipment.

Pre-scan in shielded room detected no measurable emissions from 30 MHz - 1 GHz.

**Emissions Test Conditions: 20 dB Bandwidth**

The 20 dB Bandwidth measurements were tested at the following test location :

■ - Test not performed - see remarks

- - SR-2, Shielded Room, 12' x 24' x 10', Metal Chamber
- - SR-3, Shielded Room, 12' x 20' x 8', Metal Chamber
- - SR-4, Shielded Room, 10' x 17' x 8', Copper Screen Chamber

**Test Equipment Used :**

Model No.	Prop. No.	Description	Manufacturer	Serial No.	Cal Date
CBL6111	460	Antenna, Bilog	Chase	1013	N/A
8566B	744	Spectrum Analyzer	Hewlett Packard	2618A02913	02/00

Remarks: One year calibration cycle for all test equipment.

---

**Emissions Test Conditions: Duty Cycle**

The Duty Cycle measurements were tested at the following test location :

■ - Test not performed - see remarks

- - SR-2, Shielded Room, 12' x 24' x 10', Metal Chamber
- - SR-3, Shielded Room, 12' x 20' x 8', Metal Chamber
- - SR-4, Shielded Room, 10' x 17' x 8', Copper Screen Chamber

**Test Equipment Used :**

Model No.	Prop. No.	Description	Manufacturer	Serial No.	Cal Date
2440	415	Oscilloscope	Tektronix	B013020	05/00
8566B	744	Spectrum Analyzer	Hewlett Packard	2618A02913	02/00

Remarks: One year calibration cycle for all test equipment.

---



**Equipment Under Test (EUT) Test Operation Mode - Emissions Tests :**

**The equipment under test was operated under the following conditions during emissions testing:**

- Standby
- Test Program (H - Pattern)
- Test Program (Color Bar)
- Test Program (Customer Specified)
- Practice Operation
- Normal Operating Mode
- \_\_\_\_\_

**Configuration of the equipment under test:**

- See Constructional Data Form in Appendix B - Page B2
- See Product Information Form(s) in Appendix B - Page B2

**The following peripheral devices and interface cables were connected during the testing:**

- |   |                |
|---|----------------|
| <input type="checkbox"/> - _____                    | Type : _____   |
| <input type="checkbox"/> - _____                    | Type : _____   |
| <input type="checkbox"/> - _____                    | Type : _____   |
| <input type="checkbox"/> - _____                    | Type : _____   |
| <input type="checkbox"/> - _____                    | Type : _____   |
| <input type="checkbox"/> - _____                    | Type : _____   |
| <input type="checkbox"/> - _____                    | Type : _____   |
| <input type="checkbox"/> - _____                    | Type : _____   |
| <input type="checkbox"/> - unshielded power cable   |                |
| <input type="checkbox"/> - unshielded cables        |                |
| <input type="checkbox"/> - shielded cables          | MPS.No.: _____ |
| <input type="checkbox"/> - customer specific cables |                |
| <input type="checkbox"/> - _____                    |                |
| <input type="checkbox"/> - _____                    |                |

**Emissions Test Results:**

**Conducted Emissions, 10/150/450 kHz - 30 MHz**

- PASS       - FAIL       - NOT APPLICABLE

EUT battery operated. \_\_\_\_\_

**Radiated Emissions (Electric Field), 30 MHz - 1000 MHz**

- PASS       - FAIL       - NOT APPLICABLE

Remarks: Pre-scan in shielded room detected no measurable emissions from 30 MHz - 1 GHz.

**20 dB Bandwidth**

- PASS       - FAIL       - NOT APPLICABLE

Remarks: \_\_\_\_\_

**Duty Cycle**

- PASS       - FAIL       - NOT APPLICABLE

Remarks: \_\_\_\_\_

**GENERAL REMARKS:**

NOTE: All photographs are representative of setup for maximum emissions.

**SUMMARY:**

All tests according to the regulations cited on page 3 were

- Performed
- **Not** Performed

The Equipment Under Test

- **Fulfills** the general approval requirements cited on page 3.
- **Does not** fulfill the general approval requirements cited on page 3.

**Statement of Measurement Uncertainty**

The data and results referenced in this document are true and accurate. The measurement uncertainty is calculated to be  $\pm 2$  dB for conducted emissions and  $\pm 4$  dB for radiated emissions.

Equipment Received Date: 02 June 1999  
Testing Start Date: 02 June 1999  
Testing End Date: 02 June 1999

- TÜV PRODUCT SERVICE, INC. -

Responsible Engineer:



Dave Marshall  
(EMC Test Engineer)

Responsible Engineer:



Mary Washington  
(EMC Engineer)

## Technical Documentation

Test Data Sheets  
and  
Test Setup Drawing(s)

REPORT NO: 9264  
CLIENT: Radio Shack  
NOTE: 1.  $f_c = 390$  MHz  
2. EUT on its side.  
EUT: Handheld Transmitter, Model RS321  
SPECIFICATION: Part 15, Paragraph 15.209  
DATE: 02 June 1999  
TEST: Radiated Pre-scan

MKR 390.8 MHz  
70.10 dBµV

*HP*  
*10 dB/*  
*POS PK*

REF 97.0 dBµV ATTN 0 dB *very wideband*

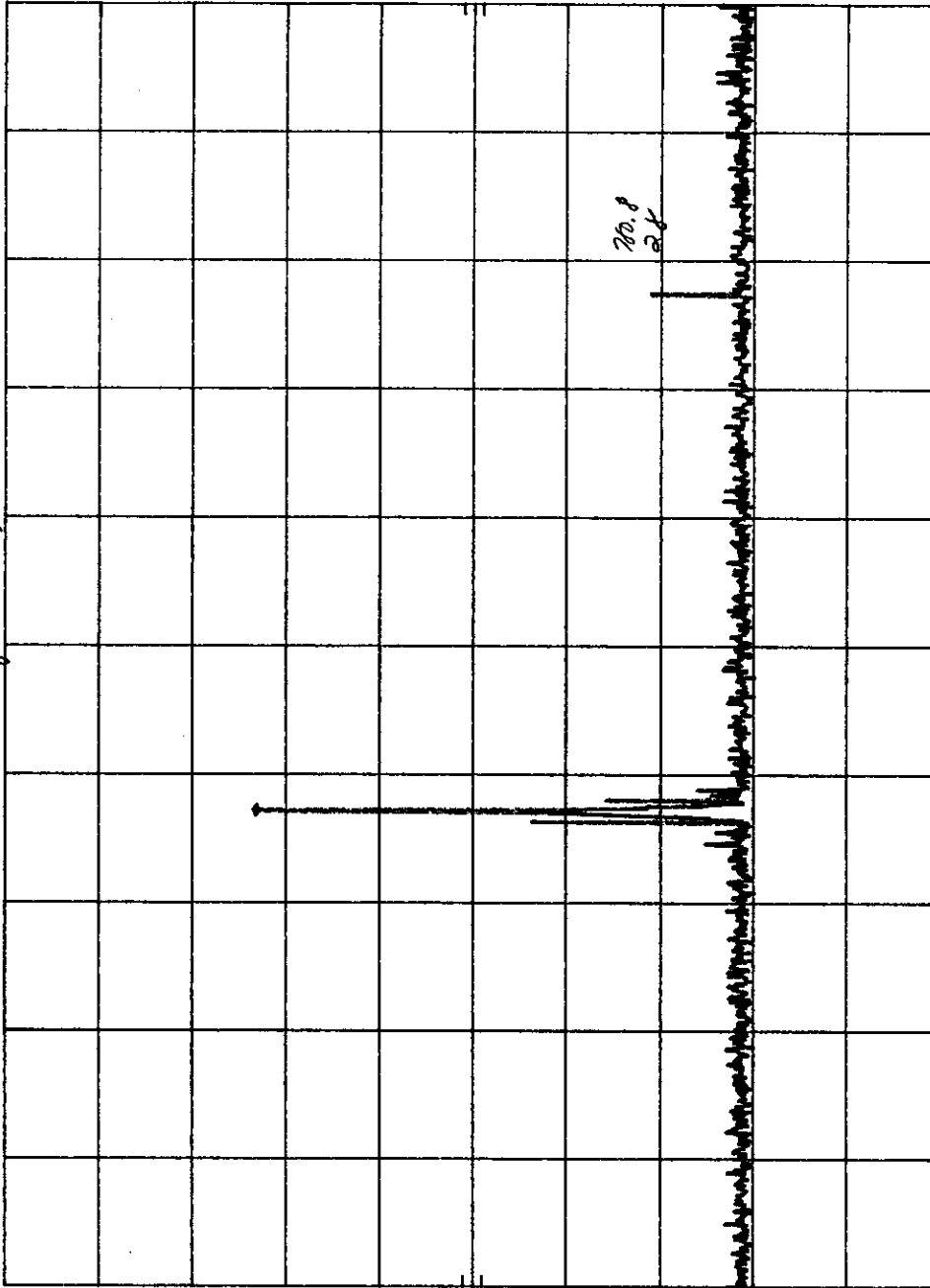

START 30 MHz  
RES BW 100 KHZ  
VBW 100 KHZ  
STOP 1.000 GHZ  
SWP 291 msec

REPORT NO: 9264  
 CLIENT: Radio Shack  
 NOTE: 1.  $f_c = 310$  MHz  
 2. EUT on its side.

EUT: Handheld Transmitter, Model RS321  
 SPECIFICATION: Part 15, Paragraph 15.209

DATE: 02 June 1999  
 TEST: Radiated Pre-scan

MKR 311.3 MHz  
 63.60 dB  $\mu$ V

*mary Washington*

hp REF 97.0 dB  $\mu$ V ATTEN 0 dB

*hp*

10 dB/

POS PK

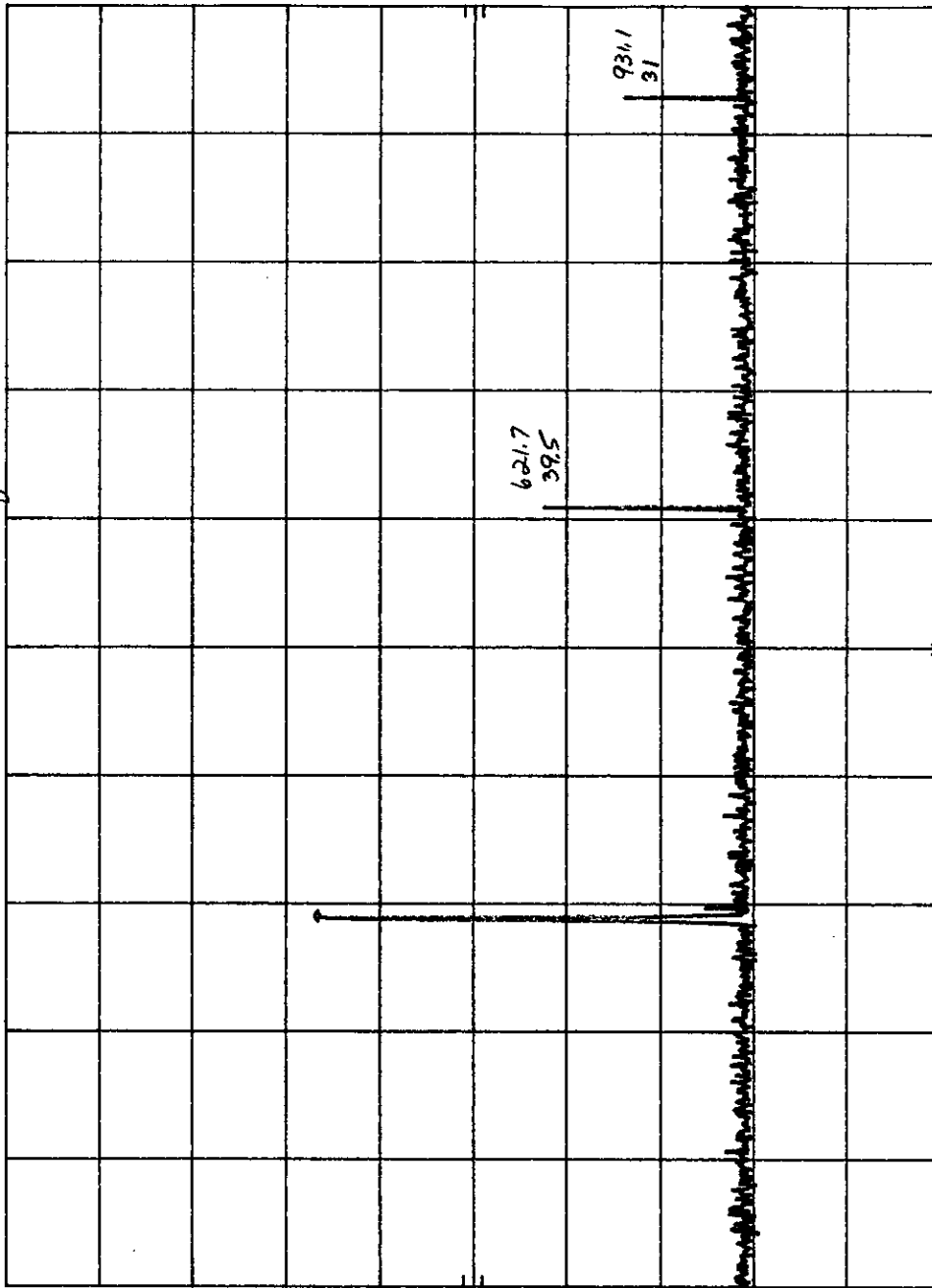

START 30 MHz RES BW 100 KHZ VBW 100 KHZ STOP 1.000 GHZ  
 SWP 291 msec

REPORT NO: 9264  
 CLIENT: Radio Shack  
 NOTE: 1. f<sub>c</sub> = 300 MHz  
 2. EUT on its side.

EUT: Handheld Transmitter, Model RS321  
 SPECIFICATION: Part 15, Paragraph 15.209

DATE: 02 June 1999  
 TEST: Radiated Pre-scan

MKR 300.6 MHz  
 66.80 dBμV

hp REF 97.0 dBμV ATTN 0 dB mag w/abortion

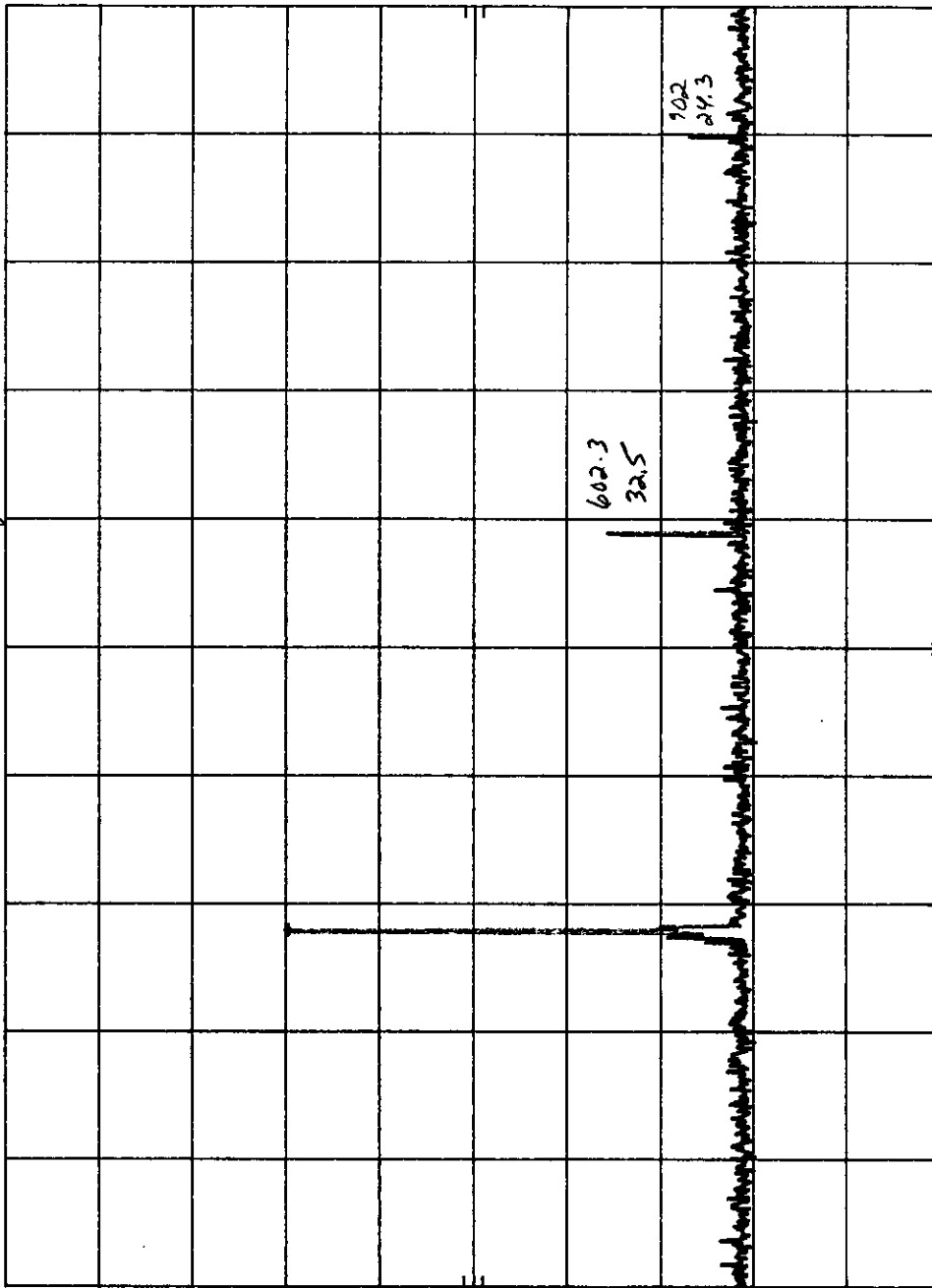

10 dB/  
 POS PK

START 30 MHz RES BW 100 KHZ VBW 100 KHZ STOP 1.000 GHZ  
 SWP 291 msec

REPORT NO: 9264  
CLIENT: Radio Shack  
EUT: Handheld Transmitter, Model RS321  
SPECIFICATION: Part 15, Paragraph 15.231(e)  
DATE: 02 June 1999  
TEST: 20 dB Bandwidth

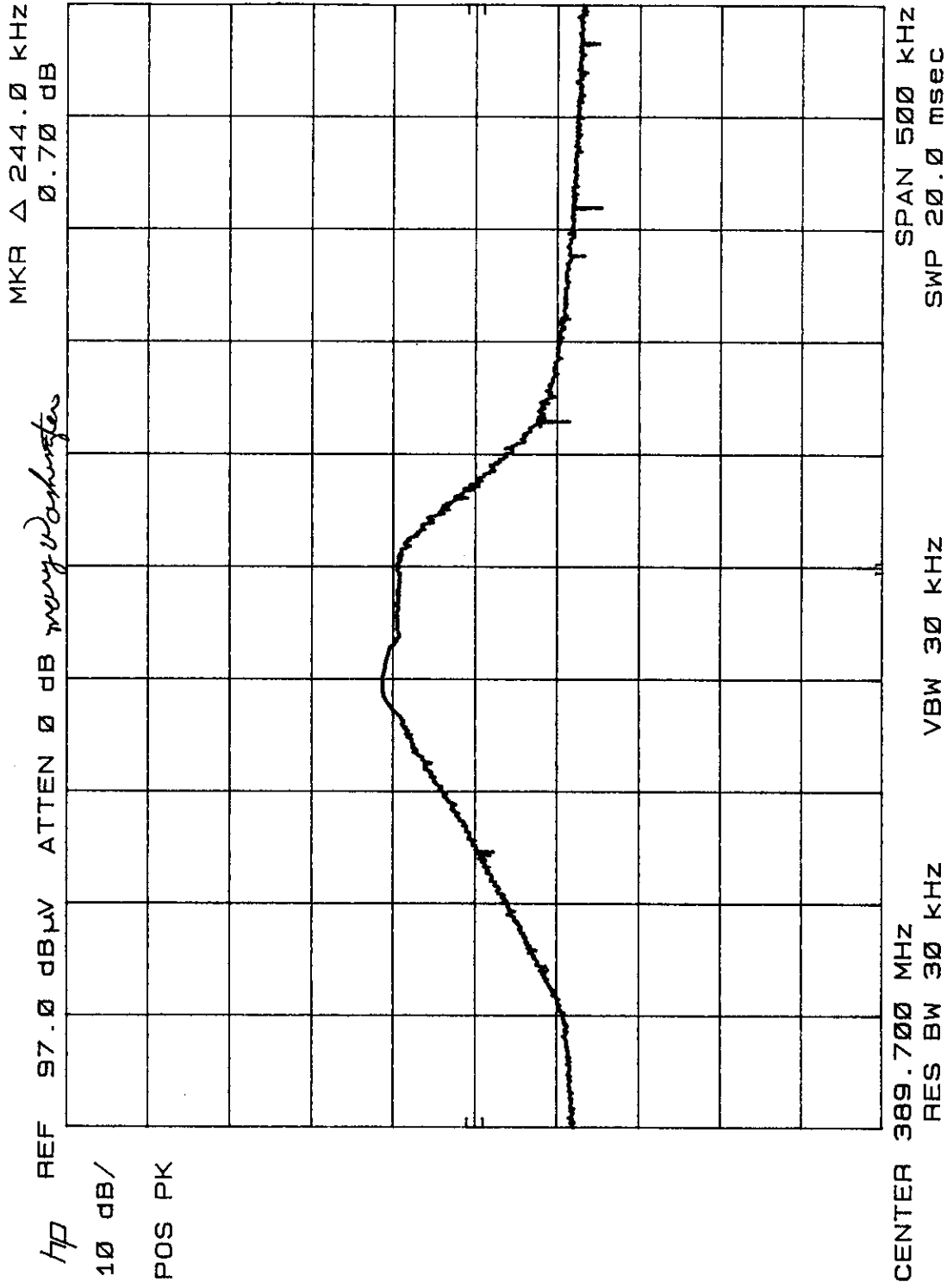



REPORT NO: 9264  
CLIENT: Radio Shack  
EUT: Handheld Transmitter, Model RS321  
SPECIFICATION: Part 15, Paragraph 15.231(c)  
DATE: 02 June 1999  
TEST: 20 dB Bandwidth

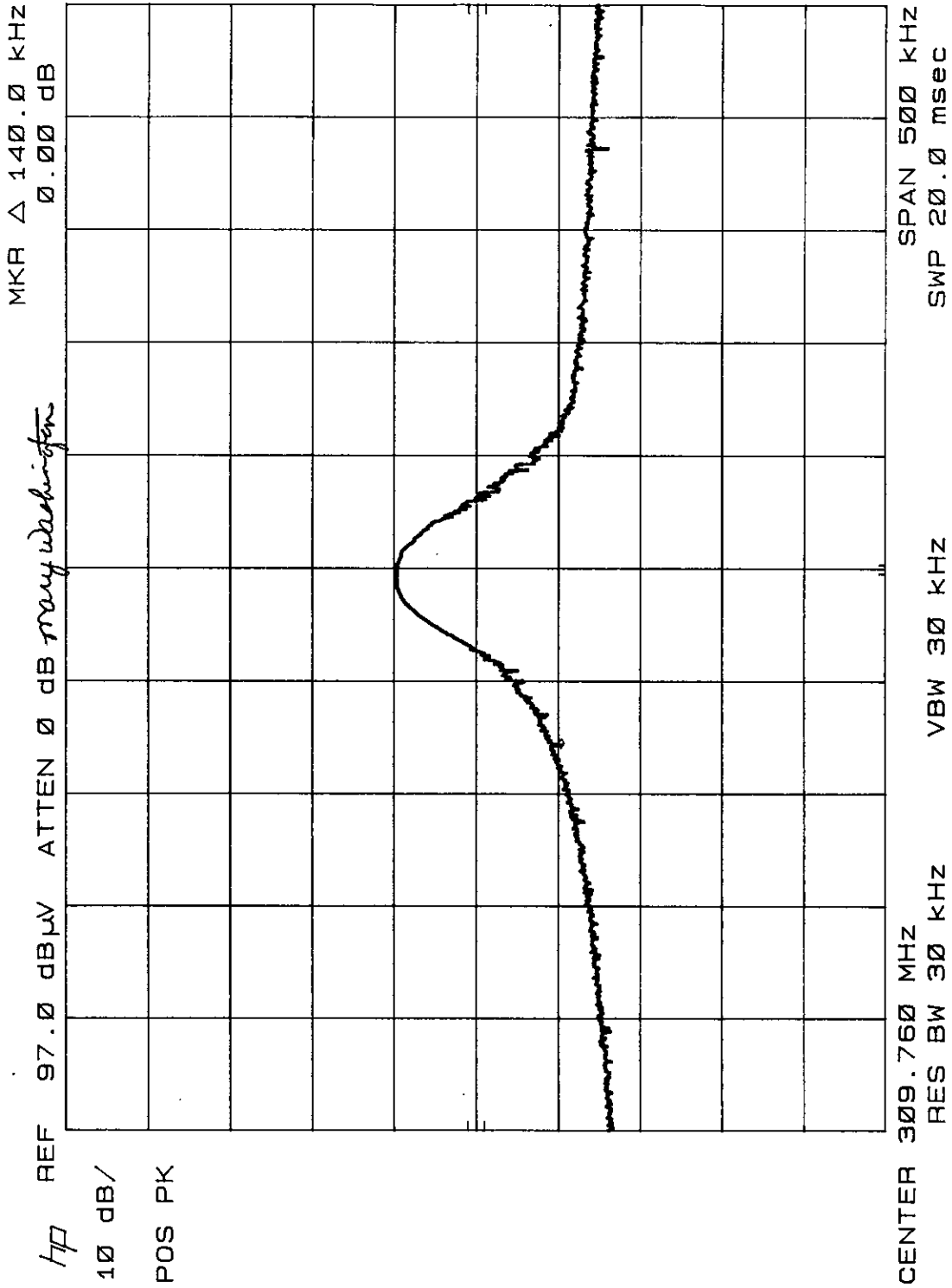

REPORT NO: 9264  
CLIENT: Radio Shack  
EUT: Handheld Transmitter, Model RS321  
SPECIFICATION: Part 15, Paragraph 15.231(c)  
DATE: 02 June 1999  
TEST: 20 dB Bandwidth

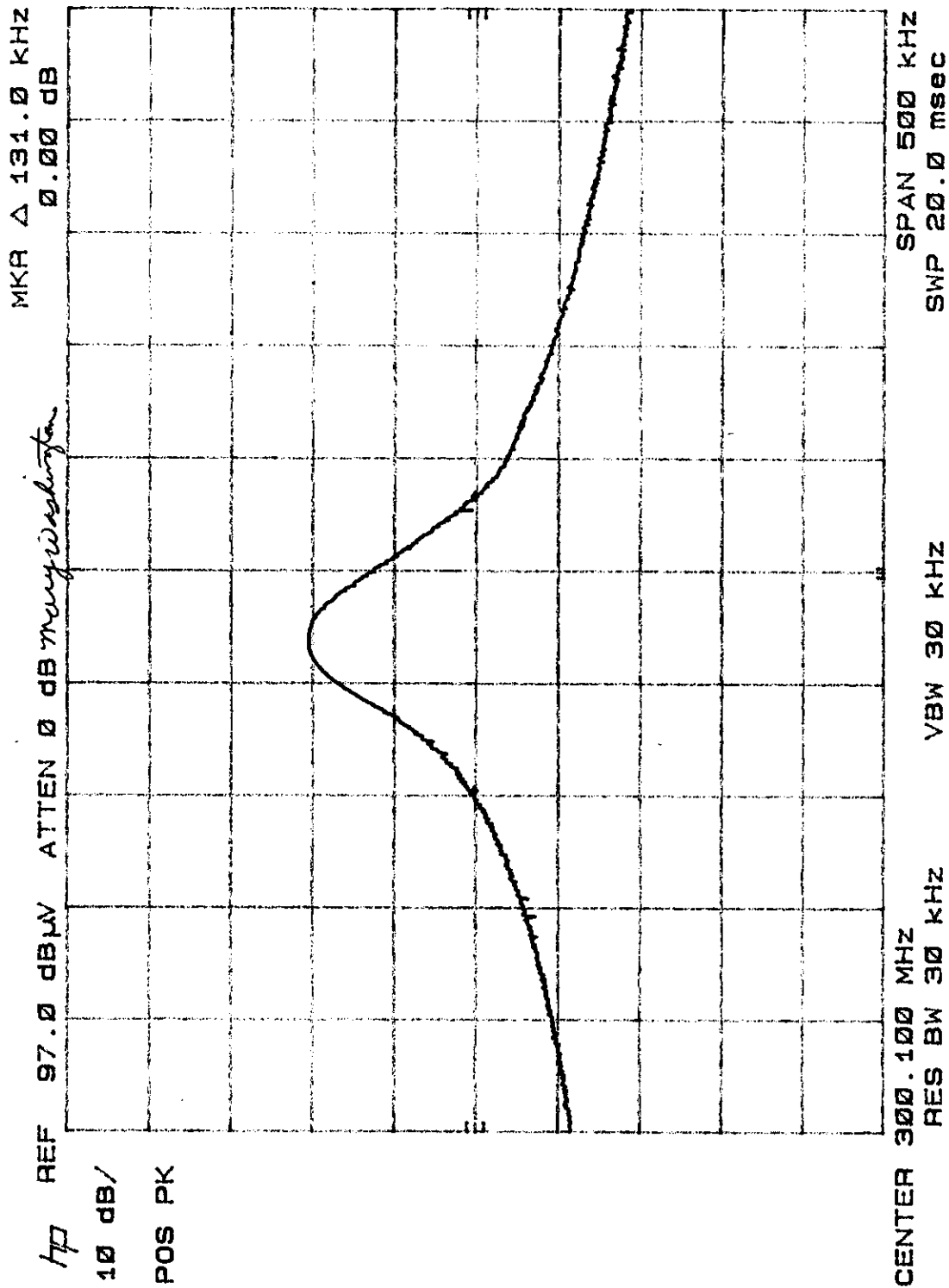

REPORT No: S9264 TESTED BY: mw  
*Mary Washington*  
 CUSTOMER: Clicker Corporation/Radio Shack TEST DIST: 3 Meters  
 E U T: Hand Held Transmitter, RS321 TEST SITE: 3  
 EUT MODE: Continous Transmit BICONICAL: N/A  
 DATE: 2-Jun-99 LOG: 244  
 NOTES: Duty Cycle= 30% OTHER: 453

RBW and VBW = 100 kHz below 1 GHz.  
 RBW and VBW = 1 MHz above 1 GHz.  
 No emissions detectable after 3rd harmonic.

v.beta

FREQ (MHz)	VERTICAL (dBuv)		HORIZONTAL (dBuv)		CORRECTION FACTOR (dB/m)	MAX LEVEL (dBuV/m)		SPEC LIMIT (dBuV/m)		MARGIN (dB)		EUT Rotatio	Antenna Height
	pk	av	pk	av		pk	av	pk	av	pk	av		
300	57.7	47.2	56.2	45.7	17.1	74.8	64.3	94.6	74.6	-19.8	-10	298	1.8
600	34.3	23.8	33.5	23	22.8	57.1	46.6	74.6	54.6	-17.5	-8	298	1
900	22.7	12.2	27.2	16.7	27.0	54.2	43.7	74.6	54.6	-20.4	-11	181	1
1200	24.2	13.7	25.5	15	27.9	53.4	42.9	74	54	-20.6	-11		

REPORT No: S9264 TESTED BY: mw SPEC: FCC Part 15, Para. 15.231(b)  
 CUSTOMER: Clicker Corporation/Radio Shack *Mary Whitehouse* TEST DIST: 3 Meters  
 E U T: Hand Held Transmitter, RS321 TEST SITE: 3  
 EUT MODE: Continous Transmit BICONICAL: N/A  
 DATE: 2-Jun-99 LOG: 244  
 NOTES: Duty Cycle= 19% OTHER: 453

RBW and VBW = 100 kHz below 1 GHz.  
 RBW and VBW = 1 MHz above 1 GHz.  
 No emissions detectable after 2nd harmonic.

v.beta

FREQ (MHz)	VERTICAL (dBuv)		HORIZONTAL (dBuv)		CORRECTION FACTOR (dB/m)	MAX LEVEL (dBuV/m)		SPEC LIMIT (dBuV/m)		MARGIN (dB)		EUT Relatio	Antenna Height
	pk	av	pk	av		pk	av	pk	av	pk	av		
310	58.3	43.9	54.1	39.7	17.1	75.4	61.0	95.3	75.3	-19.9	-14.3	268	1.5
620	35.1	20.7	32.8	18.4	22.9	58.0	43.6	75.3	55.3	-17.3	-11.7	268	1
1240	25	10.6	24.7	10.3	28.2	53.2	38.8	74	54	-20.8	-15.2		
1550	24.6	10.2	24.5	10.1	30.5	55.1	40.7	74	54	-18.9	-13.3		

REPORT No: S9264 TESTED BY: mw SPEC: FCC Part 15, Para. 15.231(b)  
 CUSTOMER: Clicker Corporation/Radio Shack *may* TEST DIST: 3 Meters  
 E U T: Hand Held Transmitter, RS321 TEST SITE: 3  
 EUT MODE: Continuous Transmit BICONICAL: N/A  
 DATE: 2-Jun-99 LOG: 244  
 NOTES: Duty Cycle= 16% OTHER: 453

RBW and VBW = 100 kHz below 1 GHz.  
 RBW and VBW = 1 MHz above GHz.  
 No emissions detectable after 7th harmonic.

FREQ (MHz)	VERTICAL (dBuV)		HORIZONTAL (dBuV)		CORRECTION FACTOR (dB/m)	MAX LEVEL (dBuV/m)		SPEC LIMIT (dBuV/m)		MARGIN (dB)		Rotatio	EUT Height	Antenna Height
	pk	av	pk	av		pk	av	pk	av	pk	av			
390	64.1	48.2	59.6	43.7	18.4	82.5	66.6	99.2	79.2	-16.7	-13	233	1.3	
780	31.9	16	40.7	24.8	25.5	66.2	50.3	79.2	59.2	-13	-8.9	158	1	
1170	37.4	21.5	32.2	16.3	27.6	65.0	49.1	74	54	-8.97	-4.9	265	1	
1560	29.7	13.8	22.9	6.98	30.5	60.2	44.3	74	54	-13.8	-9.7	266	1	
1950	27.4	11.5	26.1	10.2	32.7	60.1	44.2	79.2	59.2	-19.1	-15			
2340	18.7	2.78	21.3	5.38	34.2	55.5	39.6	74	54	-18.5	-14			

REPORT NO: 9264  
CLIENT: Radio Shack  
NOTE: 1.  $f_0 = 310 \text{ MHz}$   
2.  $16/83 = 19\%$

EUT: Handheld Transmitter, Model RS321  
TEST: Duty Cycle Measurement

DATE: 02 June 1999

CH1 200mV A 10ms 134mV VERT

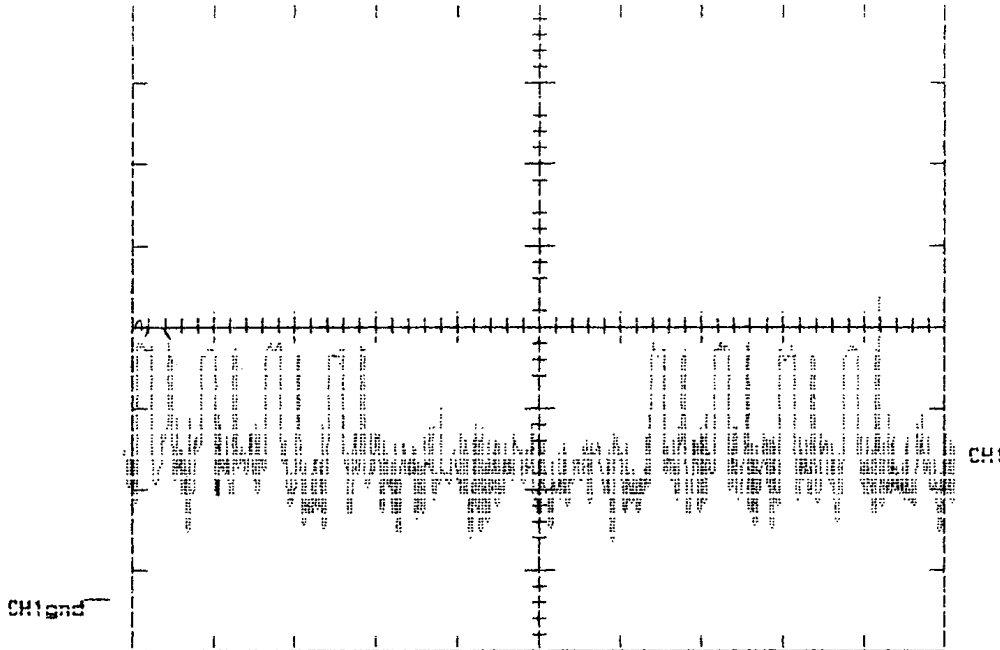

CH1 FREQ - 310.00 Hz

*Mary Washington*

REPORT NO: 9264  
CLIENT: Radio Shack  
NOTE: 1.  $f_0 = 390 \text{ MHz}$   
2.  $16/99 = 16\%$

EUT: Handheld Transmitter, Model RS321  
TEST: Duty Cycle Measurement

DATE: 02 June 1999

CH1 300mV A 10ms 134mV? UERT

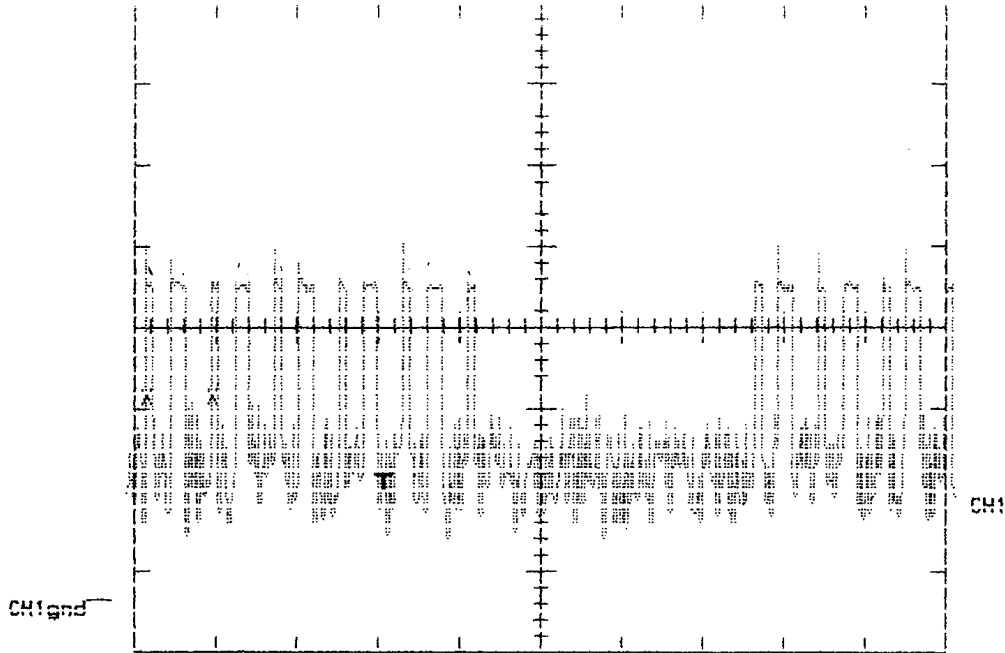

CH1 FREQ - 125 Hz

*Mary Washburn*

REPORT NO: 9264  
CLIENT: Radio Shack

EUT: Handheld Transmitter, Model RS321  
TEST: Duty Cycle Measurement

DATE: 02 June 1999

NOTE: 1.  $f_c = 300$  MHz  
2.  $25/84 = 30\%$

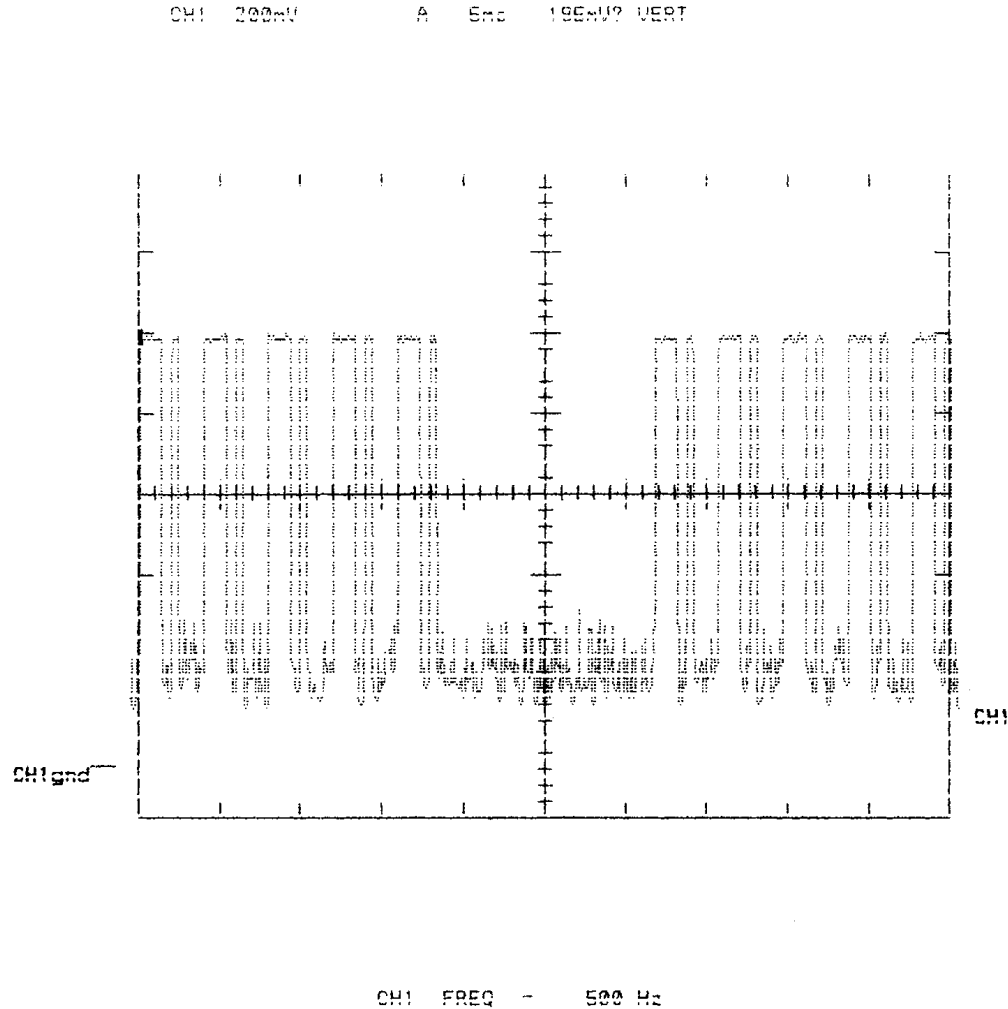

*Mary Washington*



Test Setup for 20 dB Bandwidth

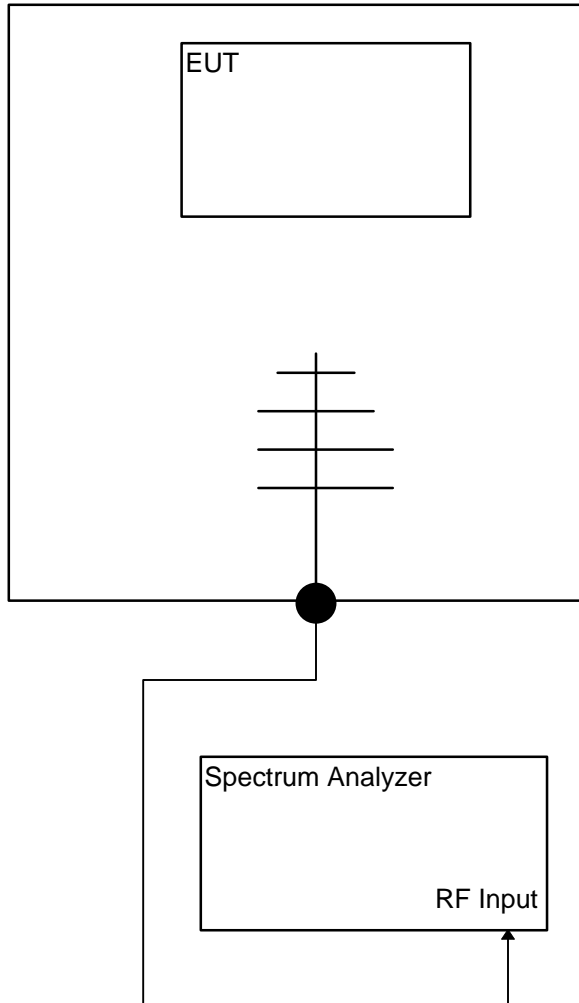

Test Setup for Duty Cycle

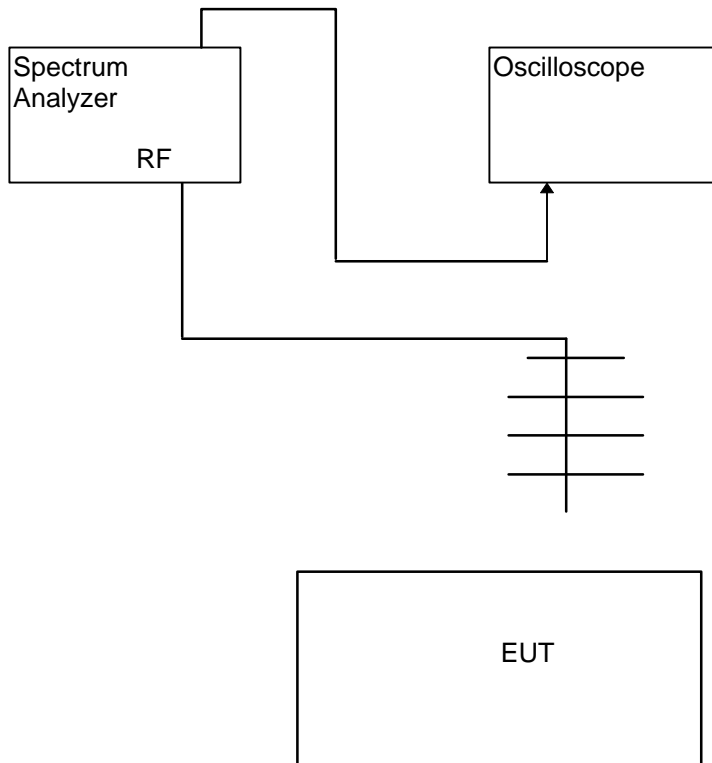

## Appendix A

### Test Setups (Photographs)

NOTE: All photographs are representative of setup for maximum emissions.

Photograph of Test Setup:  
Radiated Emissions 30 MHz - 1000 MHz



Photograph of Test Setup:  
Radiated Emissions 30 MHz - 1000 MHz



## Appendix B

Product Information Form(s)

CUSTOMER INFORMATION				
COMPANY NAME:		RADIO SHACK		
COMPANY ADDRESS:		100 Throckmorton Street, Suite 1300		
		Fort Worth, TX 76102		
PHONE NUMBER:		--		
FAX NUMBER/E-MAIL ADDRESS:		--		
CUSTOMER CONTACT:		--		
PRODUCT DESCRIPTION				
NAME, MODEL, SERIAL # OF EUT:		RS321, Model 321		
DESCRIPTION OF EUT:		--		
Components of EUT				
Description	Model Number	Serial Number	FCC ID Number	
Transmitter	321	N/A	AA06102115	
OPERATING MODE(S):		Transmit/off		
I/O CABLES				
CONNECTION	--			
SHIELD				
CONNECTORS				
TERMINATION TYPE				
LENGTH				
REMOVABLE				
POWER INTERFACE				
FREQUENCY/AC/DC VOLTAGE:		Battery		
PHASES/CURRENT:		--		
OSCILLATOR FREQUENCIES				
FREQUENCY	EUT LOCATION	DESCRIPTION OF USE		
4 MHz	--	Input to micro		
POWER SUPPLY				
DESCRIPTION	MANUFACTURER	MODEL #	SERIAL #	SWITCHING/LINEAR FREQ.
Disposable battery				
POWER LINE FILTERS				
MANUFACTURER	MODEL NO.	QTY.	LOCATION ON EUT	
N/A				
CRITICAL EMI COMPONENTS				
DESCRIPTION	MANUFACTURER	PART # OR VALUE	QTY.	LOCATION ON EUT
N/A				
DESCRIPTION OF ENCLOSURE:		Plastic		
INTERFACING AND/OR SIMULATORS PERIPHERAL EQUIPMENT:				
DESCRIPTION	MANUFACTURER	MODEL #	SERIAL #	FCC ID
--				
BLOCK DIAGRAM:		--		

## Appendix C

Change History

**Not Applicable**



## Appendix D

Supplemental Information

**Not Applicable**