

FCC PART 15 SUBPART C MEASUREMENT AND TEST REPORT

For

Shenzhen Fenda Technology Co., Ltd.

**Fenda Hi-Tech Park, Zhoushi Road, Shiyan Town, Baoan District, Shenzhen
City, China**

E.U.T.: Mono Bluetooth Speaker

Model Name: W17BT-BL, W17BT-GR, BWB15AV202, BWB15AV203

Brand Name:



FCC ID: HBOW17BTA

Report Number: NTC1505245F

Test Date(s): January 13, 2015 to June 03, 2015

Report Date(s): June 03, 2015

Prepared by

Dongguan Nore Testing Center Co., Ltd.

**Building D, Gaosheng Science & Technology Park, Zhouxi Longxi Road,
Nancheng District, Dongguan, Guangdong, China.**

Tel: +86-769-22022444

Fax: +86-769-22022799

Prepared By

Approved & Authorized Signer



Rose Hu / Engineer



Sunm Lv / Q.A. Director

Note: This test report is for the customer shown above and their specific product only. It may not be duplicated or used in part without prior written consent from Dongguan Nore Testing Center Co., Ltd. The test results referenced from this report are relevant only to the sample tested.

Table of Contents

1. GENERAL INFORMATION	4
1.1 PRODUCT DESCRIPTION FOR EQUIPMENT UNDER TEST	4
1.2 RELATED SUBMITTAL(S) / GRANT (S).....	5
1.3 TEST METHODOLOGY.....	5
1.4 EQUIPMENT MODIFICATIONS	5
1.5 TEST FACILITY AND LOCATION.....	5
1.6 SUMMARY OF TEST RESULTS	6
2. SYSTEM TEST CONFIGURATION.....	7
2.1 EUT CONFIGURATION	7
2.2 SPECIAL ACCESSORIES.....	7
2.3 DESCRIPTION OF TEST MODES	7
2.4 EUT EXERCISE.....	7
2.5 SUPPORT DEVICE	7
3. CONDUCTED EMISSIONS TEST	8
3.1 TEST SET-UP (BLOCK DIAGRAM OF CONFIGURATION).....	8
3.2 TEST CONDITION	8
3.3 MEASUREMENT RESULTS.....	8
4. RADIATED EMISSION TEST.....	11
4.1 TEST SET-UP (BLOCK DIAGRAM OF CONFIGURATION).....	11
4.2 MEASUREMENT PROCEDURE	12
4.3 LIMIT.....	12
4.4 MEASUREMENT RESULTS.....	14
5. CHANNEL SEPARATION TEST.....	17
5.1 MEASUREMENT PROCEDURE	17
5.2 TEST SET-UP (BLOCK DIAGRAM OF CONFIGURATION).....	17
5.3 MEASUREMENT RESULTS.....	17
6. 20DB BANDWIDTH.....	23
6.1 MEASUREMENT PROCEDURE	23
6.2 TEST SET-UP (BLOCK DIAGRAM OF CONFIGURATION).....	23
6.3 MEASUREMENT RESULTS.....	23
7. HOPPING CHANNEL NUMBER.....	29
7.1 MEASUREMENT PROCEDURE	29
7.2 TEST SET-UP (BLOCK DIAGRAM OF CONFIGURATION).....	29
7.3 MEASUREMENT RESULTS.....	29

8. TIME OF OCCUPANCY (DWELL TIME)	31
8.1 MEASUREMENT PROCEDURE	31
8.2 MEASUREMENT RESULTS.....	31
9. MAXIMUM PEAK OUTPUT POWER	37
9.1 MEASUREMENT PROCEDURE	37
9.2 MEASUREMENT RESULTS.....	37
10. BAND EDGE	43
10.1 MEASUREMENT PROCEDURE	43
10.2 LIMIT.....	43
10.3 MEASUREMENT RESULTS.....	44
11. ANTENNA APPLICATION	51
11.1 ANTENNA REQUIREMENT	51
11.2 MEASUREMENT RESULTS.....	51
12. CONDUCTED SPURIOUS EMISSIONS	52
12.1 MEASUREMENT PROCEDURE	52
12.2 MEASUREMENT RESULTS.....	52
13. TEST EQUIPMENT LIST	56

1. GENERAL INFORMATION

1.1 Product Description for Equipment under Test

This device is a BT speaker, it's powered by DC 3.7V Li-ion battery or DC 5V come from USB Port. For more details features, please refer to User's Manual.

Manufacturer	: Shenzhen Fenda Technology Co., Ltd.
Address	: Fenda Hi-Tech Park, Zhoushi Road, Shiyan Town, Baoan District, Shenzhen City, China
Power Supply	: DC 3.7V Li-ion battery; DC 5V(Adapter input)
Model name	: W17BT-BL, W17BT-GR, BWB15AV202, BWB15AV203
Model Difference Description	: All models have the same circuit schematic, construction and critical components except model number and the color.
Product HW version	: W17BT-01-A0D-T3
Product SW version	: N/A
Radio HW version	: FD-BT05L_V01
Radio SW version	: 3.0+EDR
Test SW version	: CSR Bluesuite_V3.0
RF Power setting in test SW	: For GFSK: 0, 63; For $\pi/4$ -DQPSK, 8DPSK: 0, 105
Frequency:	: 2402-2480MHz
Modulation	: GFSK, $\pi/4$ -DQPSK, 8DPSK
Number of Channel	: 79
Channel space	: 1MHz
Antenna Type	: PCB
Antenna Gain	: 2 dBi (declared by manufacturer)
Note	: Only one of the model W17BT-BL was test in this report.

1.2 Related Submittal(s) / Grant (s)

This submittal(s) (test report) is intended for FCC ID: HBOW17BTA filing to comply with Section 15.247 of the FCC Part 15 (2014), Subpart C Rule.

1.3 Test Methodology

Both AC mains line-conducted and radiated emission measurements were performed according to the procedures in ANSI C63.10 (2013) and DA 00-705. Radiated emission measurement was performed in semi-anechoic chamber and conducted emission measurement was performed in shield room. For radiated emission measurement, preliminary scans were performed in the semi-anechoic chamber only to determine the worst case modes. All radiated tests were performed at an antenna to EUT distance of 3 meters.

1.4 Equipment Modifications

Not available for this EUT intended for grant.

1.5 Test Facility and Location

Listed by FCC, August 02, 2011
The Certificate Registration Number is 665078.

Listed by Industry Canada, July 01, 2011
The Certificate Registration Number is 9743A-1.

Dongguan NTC Co., Ltd.

Building D, Gaosheng Science and Technology Park,
Hongtu Road, Nancheng District, Dongguan City,
Guangdong Province, China

1.6 Summary of Test Results

FCC Rules	Description Of Test	Result
§15.247(a)(1)	Channel Separation test	Compliant
§15.247(a)(1)	20dB Bandwidth	Compliant
§15.247(a)(1)(iii)	Hopping Channel Number	Compliant
§15.247(a)(1)(iii)	Time of Occupancy (Dwell Time)	Compliant
§15.247(b)	Max Peak output Power test	Compliant
§15.247(d)	Band edge test	Compliant
§15.207 (a)	AC Power Conducted Emission	Compliant
§15.247(d), §15.209, §15.205	Radiated Emission	Compliant
§15.203	Antenna Requirement	Compliant
§15.247(d)	Conducted Spurious Emission	Compliant

2. System Test Configuration

2.1 EUT Configuration

The EUT configuration for testing is installed on RF field strength measurement to meet the Commissions requirement and operating in a manner which intends to maximize its emission characteristics in a continuous normal application.

2.2 Special Accessories

Not available for this EUT intended for grant.

2.3 Description of test modes

The EUT has been tested under operating condition. Test program used to control the EUT for staying in continuous transmitting and normal mode is programmed. The Lowest, middle and highest channel were chosen for testing, and all packets DH1, DH3 and DH5 mode in all modulation type GFSK, $\pi/4$ -DQPSK, 8DPSK were tested.

2.4 EUT Exercise

The EUT was operated in the engineering mode to fix the Tx frequency that was for the purpose of the measurements.

2.5 Support Device

Adapter : Manufacturer: FUERTAI
M/N: F-050200US
Input: AC 100~240V 50/60Hz
Output: DC 5V 2000mA

3. Conducted Emissions Test

3.1 Test SET-UP (Block Diagram of Configuration)

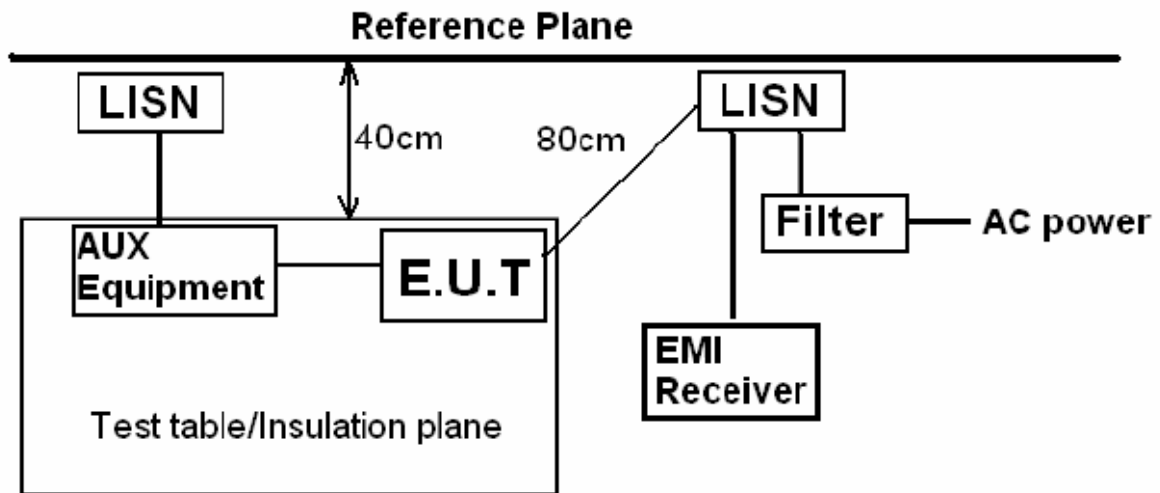

3.2 Test Condition

Test Requirement: FCC 15.207

Frequency Range: 150KHz ~ 30MHz

Detector: RBW 9KHz, VBW 30KHz

Operation Mode: Charging+TX

3.3 Measurement Results

Please refer to following plots.

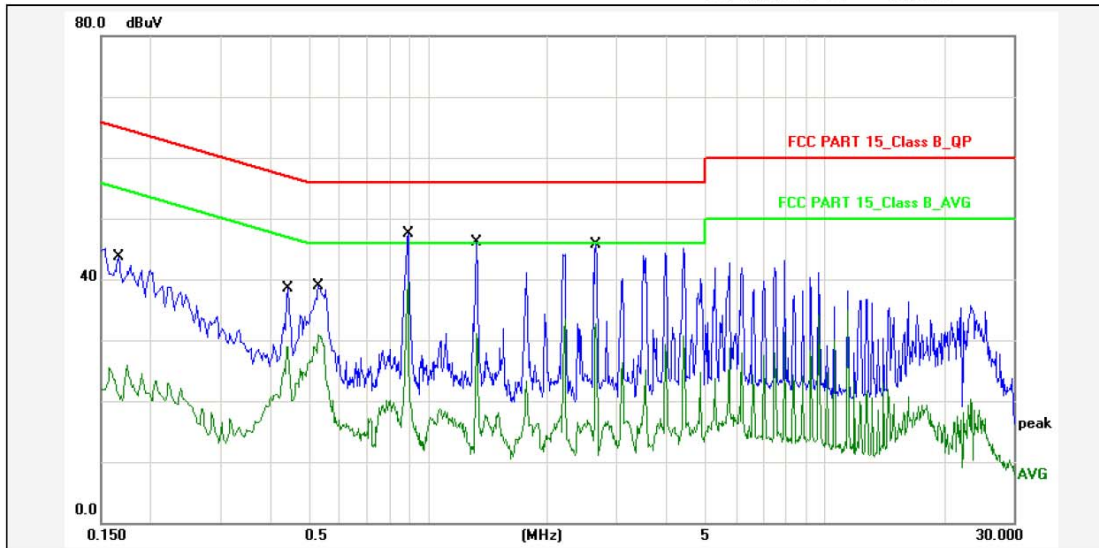

Report No.: W17BT-BL
 Test Standard: FCC PART 15_Class B_QP
 Test item: Conducted Emission
 Applicant: FENDA
 Product: Mono Bluetooth Speaker
 Model No.: W17BT-BL

Phase: L1
 Temp.()/Hum.(%): 24(C) / 58 %
 Power Rating: AC 120V/60Hz
 Test Engineer: Stan

Test Mode: Charging+TX
 Remark:

No.	Frequency (MHz)	Factor (dBuV)	Reading (dBuV)	Level (dBuV)	Limit (dBuV)	Margin (dB)	Detector	P/F	Remark
1	0.1658	10.80	30.90	41.70	65.16	-23.46	QP	P	
2	0.1658	10.80	13.10	23.90	55.16	-31.26	AVG	P	
3	0.4444	10.80	25.70	36.50	56.98	-20.48	QP	P	
4	0.4444	10.80	16.00	26.80	46.98	-20.18	AVG	P	
5	0.5292	10.80	26.10	36.90	56.00	-19.10	QP	P	
6	0.5292	10.80	18.00	28.80	46.00	-17.20	AVG	P	
7	0.8896	10.80	34.70	45.50	56.00	-10.50	QP	P	
8	0.8896	10.80	26.70	37.50	46.00	-8.50	AVG	P	
9	1.3237	10.80	33.40	44.20	56.00	-11.80	QP	P	
10	1.3237	10.80	18.40	29.20	46.00	-16.80	AVG	P	
11	2.6499	10.80	32.90	43.70	56.00	-12.30	QP	P	
12	2.6499	10.80	19.90	30.70	46.00	-15.30	AVG	P	

Note: Level=Reading+Factor.
 Margin=Limit-Level.

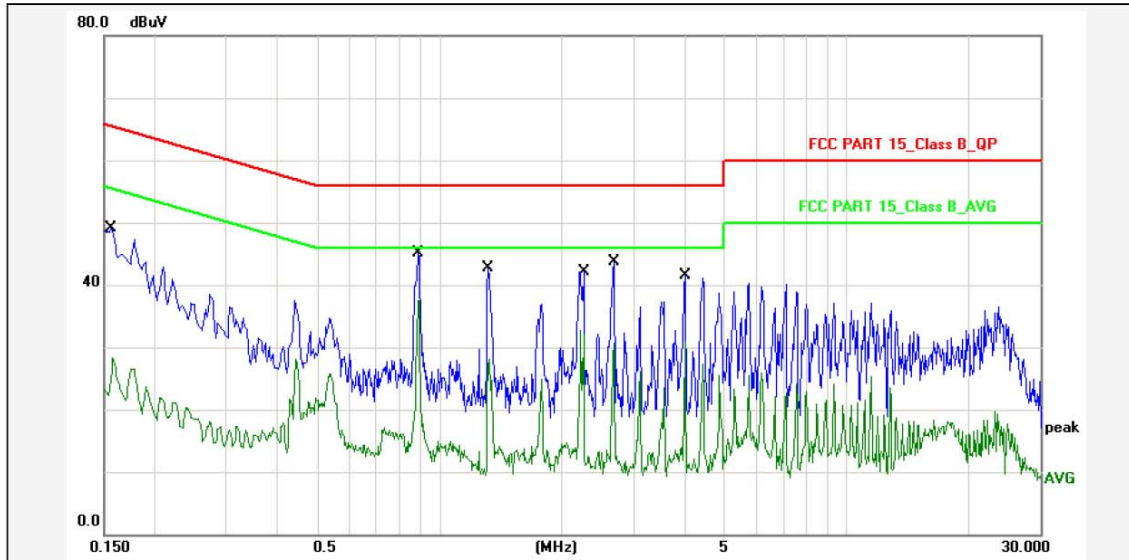

Report No.: W17BT-BL
 Test Standard: FCC PART 15_Class B_QP
 Test item: Conducted Emission Phase: N
 Applicant: FENDA Temp.()/Hum.(%): 24(C) / 58 %
 Product: Mono Bluetooth Speaker Power Rating: AC 120V/60Hz
 Model No.: W17BT-BL Test Engineer: Stan
 Test Mode: Charging+TX
 Remark:

No.	Frequency (MHz)	Factor (dBuV)	Reading (dBuV)	Level (dBuV)	Limit (dBuV)	Margin (dB)	Detector	P/F	Remark
1	0.1556	10.80	36.30	47.10	65.69	-18.59	QP	P	
2	0.1556	10.80	15.40	26.20	55.69	-29.49	AVG	P	
3	0.8849	10.80	32.30	43.10	56.00	-12.90	QP	P	
4	0.8849	10.80	24.70	35.50	46.00	-10.50	AVG	P	
5	1.3165	10.80	29.90	40.70	56.00	-15.30	QP	P	
6	1.3165	10.80	15.30	26.10	46.00	-19.90	AVG	P	
7	2.2604	10.80	29.40	40.20	56.00	-15.80	QP	P	
8	2.2604	10.80	19.90	30.70	46.00	-15.30	AVG	P	
9	2.6781	10.80	30.90	41.70	56.00	-14.30	QP	P	
10	2.6781	10.80	11.10	21.90	46.00	-24.10	AVG	P	
11	4.0060	10.80	28.70	39.50	56.00	-16.50	QP	P	
12	4.0060	10.80	18.00	28.80	46.00	-17.20	AVG	P	

Note: Level=Reading+Factor.
 Margin=Limit-Level.

4. Radiated Emission Test

4.1 Test SET-UP (Block Diagram of Configuration)

Radiated Emission Test Set-Up, Frequency Below 30MHz

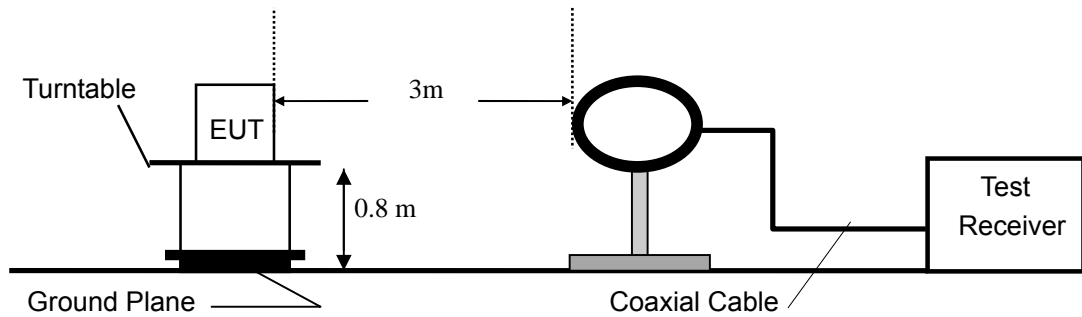

Radiated Emission Test Set-Up, Frequency Below 1GHz

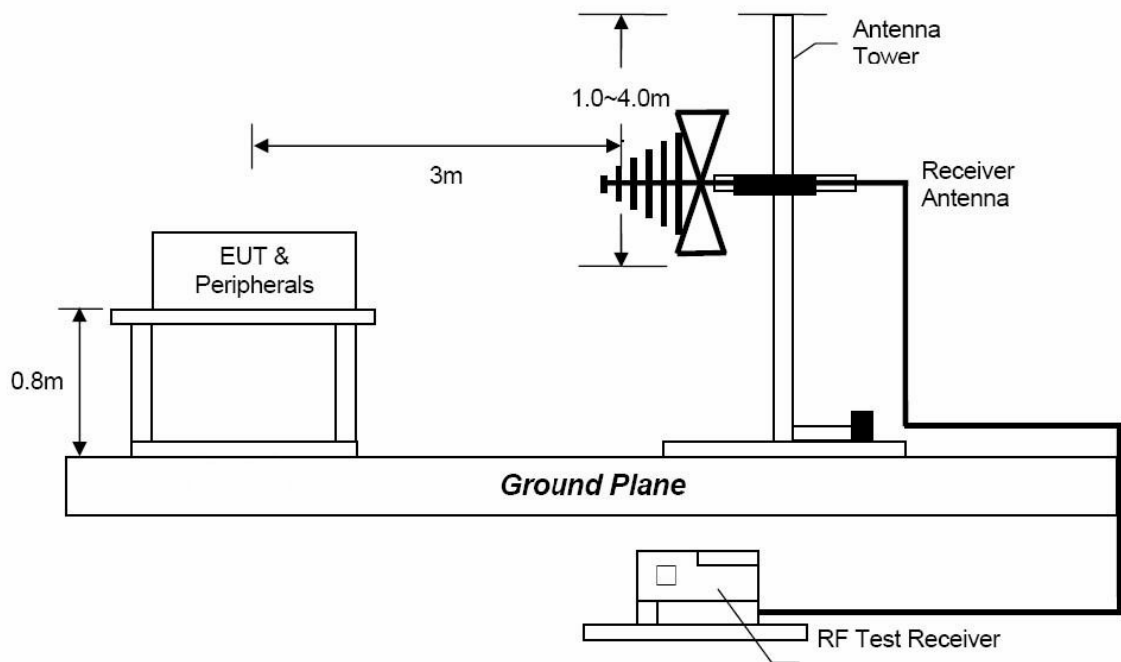

Radiated Emission Test Set-Up, Frequency above 1GHz

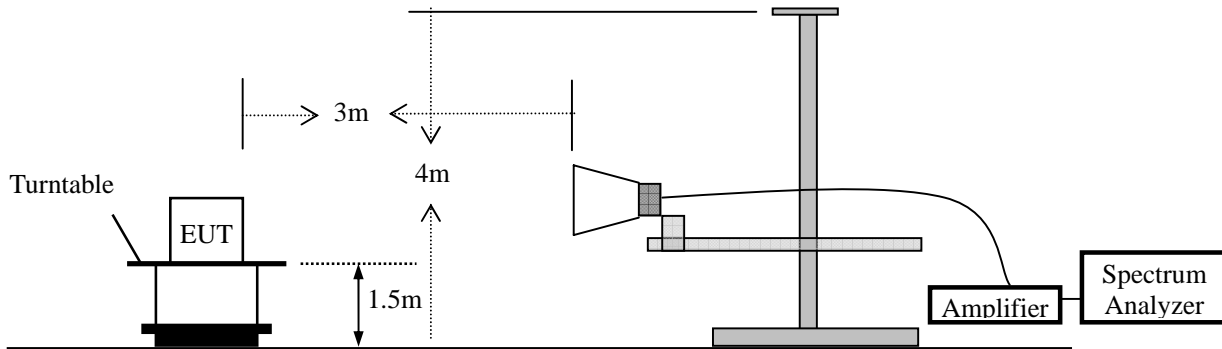

4.2 Measurement Procedure

- Below 1GHz, the EUT was placed on the top of a rotating table 0.8 meters above the ground at a 3 meter semi- anechoic chamber room. Above 1GHz, the EUT was placed on the top of a rotating table 1.5 meters above the ground at a 3 meter semi- anechoic chamber room. The table was rotated 360 degrees to determine the position of the highest radiation.
- The EUT was set 3 meters away from the interference-receiving antenna, which was mounted on the top of a variable-height antenna tower.
- The height of antenna is varied from one meter to four meters above the ground to determine the maximum value of the field strength. Both horizontal and vertical polarizations of the antenna are set to make the measurement.
- For each suspected emission, the EUT was arranged to its worst case and then the antenna was tuned to heights from 1 meter to 4 meters and the rotatable table was turned from 0 degrees to 360 degrees to find the maximum reading. The test-receiver system was set to peak detect function and specified bandwidth with maximum hold mode.
- A Quasi-peak measurement was then made for that frequency point for below 1GHz test. PK and AV for above 1GHz emission test.

For 30MHz to 1GHz:

Set the spectrum analyzer as: RBW=120kHz, VBW=300kHz, Detector=Quasi-Peak

For Above 1GHz:

Set the spectrum analyzer as: RBW=1MHz, VBW=3MHz, Detector=Peak.

Set the spectrum analyzer as: RBW=1MHz, VBW=10Hz, Detector=Peak.

During the radiated emission test, the spectrum analyzer was set with the following configurations:

Frequency Band (MHz)	Level	Resolution Bandwidth	Video Bandwidth
30 to 1000	QP	120 kHz	300 kHz
Above 1000	Peak	1 MHz	3 MHz
	Average	1 MHz	10 Hz

4.3 Limit

Frequency range MHz	Distance Meters	Field Strengths Limit
		$\mu\text{V/m}$
0.009 ~ 0.490	300	2400/F(kHz)
0.490 ~ 1.705	30	24000/F(kHz)
1.705 ~ 30	30	30
30 ~ 88	3	100
88 ~ 216	3	150
216 ~ 960	3	200
Above 960	3	500

- Remark :
- (1) Emission level (dB) μV = 20 log Emission level $\mu\text{V/m}$
 - (2) The smaller limit shall apply at the cross point between two frequency bands.
 - (3) For frequencies above 1000MHz, the field strength limits are based on average detector, however, the peak field strength of any emission shall not exceed the maximum permitted average limits, specified above by more than 20dB under any condition of modulation.
 - (4) The frequency range scanned is from the lowest radio frequency signal generated in the device which is greater than 9 kHz to the tenth harmonic of the highest fundamental frequency or 40 GHz, whichever is lower.

4.4 Measurement Results



Dongguan NTC Co., Ltd.
 Tel: +86-769-22022444 Fax: +86-769-22022799
 Web: <http://www.ntc-c.com>

Site: Radiation

Test Time: 2015-6-2 14:39:01



Report No.:	W17BT-BL	Test Distance:	
Test Standard:	FCC Part 15_Class B_3M	Ant. Polarization:	Vertical
Test item:	Radiation Emission	Temp.(C)/Hum.(%):	21(C) / 55 %
Applicant:	FENDA	Power Rating:	DC 3.7V
Product:	Mono Bluetooth Speaker	Test Engineer:	Sance
Model No.:	W17BT-BL		
Test Mode:	TX		
Remark:	GFSK (Low Channel)		

No.	Frequency (MHz)	Factor (dB/m)	Reading (dBuV)	Level (dBuV/m)	Limit (dBuV/m)	Margin (dB)	Detector	Height (cm)	Azimuth (deg.)	P/F	Remark
1	43.5800	-14.06	27.56	13.50	40.00	-26.50	QP			P	
2	320.0300	-11.93	36.23	24.30	46.00	-21.70	QP			P	
3	330.7000	-11.60	38.30	26.70	46.00	-19.30	QP			P	
4	354.9500	-11.13	38.78	27.65	46.00	-18.35	QP			P	
5	512.0900	-8.74	38.71	29.97	46.00	-16.03	QP			P	
6	544.1000	-8.61	39.84	31.23	46.00	-14.77	QP			P	

Note: Level=Reading+Factor.

Margin=Limit-Level.

Below 30MHz, the emissions are lower than 20dB below the allowable limit.

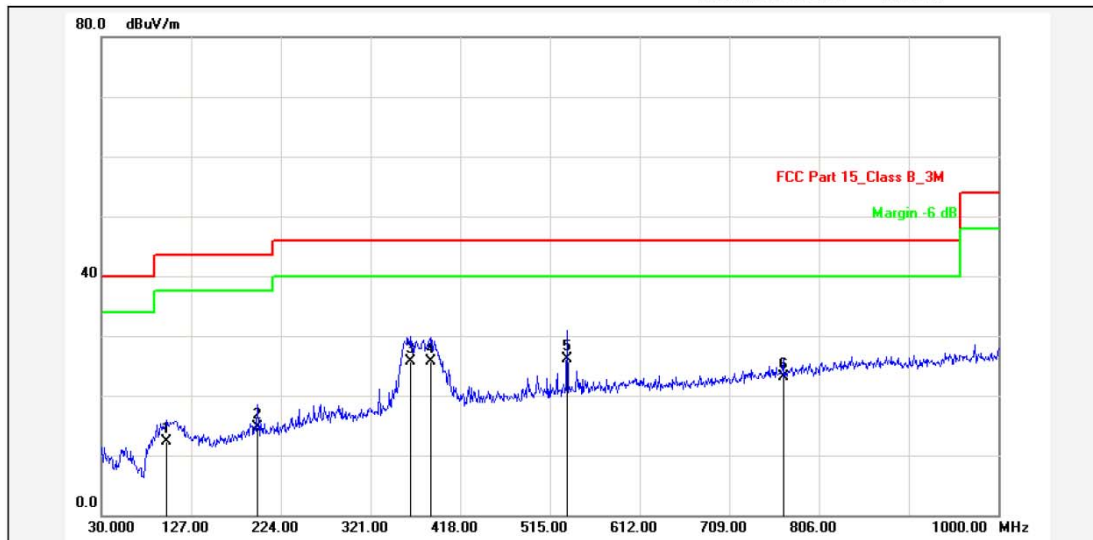

Report No.: W17BT-BL
 Test Standard: FCC Part 15_Class B_3M
 Test item: Radiation Emission
 Applicant: FENDA
 Product: Mono Bluetooth Speaker
 Model No.: W17BT-BL

Test Distance:
 Ant. Polarization: Horizontal
 Temp.(C)/Hum.(%): 21(C) / 55 %
 Power Rating: DC 3.7V
 Test Engineer: Sance

Test Mode: TX
 Remark: GFSK (Low Channel)

No.	Frequency (MHz)	Factor (dB/m)	Reading (dBuV)	Level (dBuV/m)	Limit (dBuV/m)	Margin (dB)	Detector	Height (cm)	Azimuth (deg.)	P/F	Remark
1	100.8100	-12.11	24.47	12.36	43.50	-31.14	QP			P	
2	198.7800	-13.42	28.11	14.69	43.50	-28.81	QP			P	
3	363.6800	-9.15	34.83	25.68	46.00	-20.32	QP			P	
4	385.9900	-9.17	34.87	25.70	46.00	-20.30	QP			P	
5	533.4300	-6.68	32.70	26.02	46.00	-19.98	QP			P	
6	767.2000	-2.36	25.49	23.13	46.00	-22.87	QP			P	

Note: Level=Reading+Factor.

Margin=Limit-Level.

Below 30MHz, the emissions are lower than 20dB below the allowable limit.

Modulation: GFSK (the worst case)
 Frequency Range: 1-25GHz Test Date : Jan. 15, 2015
 Test Result: PASS Temperature : 20 °C
 Measured Distance: 3m Humidity : 50 %
 Test By: Sance

Freq. (MHz)	Ant.Pol. (H/V)	Reading Level(dBuV)		Factor (dB/m)	Emission Level (dBuV)		Limit 3m (dBuV/m)		Margin (dB)	
		PK	AV		PK	AV	PK	AV	PK	AV
Operation Mode: TX Mode (Low)										
4804	V	43.94	26.89	14.63	58.57	41.52	74.00	54.00	-15.43	-12.48
7206	V	40.75	26.13	20.68	61.43	46.81	74.00	54.00	-12.57	-7.19

4804	H	43.33	26.75	14.63	57.96	41.38	74.00	54.00	-16.04	-12.62
7206	H	39.65	25.08	20.68	60.33	45.76	74.00	54.00	-13.67	-8.24

Operation Mode: TX Mode (Mid)										
4882	V	38.30	25.15	14.97	53.27	40.12	74.00	54.00	-20.73	-13.88
7323	V	40.85	25.08	20.91	61.76	45.99	74.00	54.00	-12.24	-8.01

4882	H	43.35	27.62	14.97	58.32	42.59	74.00	54.00	-15.68	-11.41
7323	H	39.41	24.97	20.91	60.32	45.88	74.00	54.00	-13.68	-8.12

Operation Mode: TX Mode (High)										
4960	V	39.99	24.82	15.30	55.29	40.12	74.00	54.00	-18.71	-13.88
7440	V	40.57	24.48	21.16	61.73	45.64	74.00	54.00	-12.27	-8.36

4960	H	39.09	25.00	15.30	54.39	40.30	74.00	54.00	-19.61	-13.70
7440	H	39.94	25.05	21.16	61.10	46.21	74.00	54.00	-12.90	-7.79

- Note:**
- (1) All Readings are Peak Value and AV.
 - (2) Emission Level= Reading Level + Factor
 - (3) Factor= Antenna Gain + Cable Loss – Amplifier Gain
 - (4) Data of measurement within this frequency range shown “ ---” in the table above means the reading of emissions are attenuated more than 10dB below the permissible limits.
 - (5) Measurement uncertainty : ±3.7dB.
 - (6) Horn antenna used for the emission over 1000MHz.

5. Channel Separation test

5.1 Measurement Procedure

Minimum Hopping Channel Carrier Frequency Separation, FCC Rule 15.247(a)(1):

Connect EUT antenna terminal to the spectrum analyzer with a low loss cable, and using the MARKER and Max-Hold function to record the separation of two adjacent channels.

5.2 Test SET-UP (Block Diagram of Configuration)

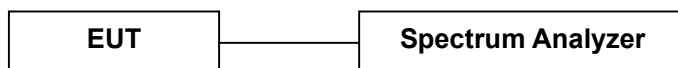

5.3 Measurement Results

Modulation:	GFSK, $\pi/4$ -DQPSK, 8DPSK		
RBW:	100KHz	VBW:	300KHz
Packet:	DH5	Spectrum Detector:	PK
Test By:	Sance	Test Date :	Jan. 13, 2015
Temperature :	22 °C	Humidity :	50 %
Test Result:	PASS		

Channel number	Channel frequency (MHz)	Separation Read Value (KHz)	Separation Limit (KHz)
GFSK			
Lowest	2402	1000	>827
Middle	2441	1000	>880
Highest	2480	1000	>875
$\pi/4$ -DQPSK			
Lowest	2402	1000	>840.0
Middle	2441	1000	>830.0
Highest	2480	1000	>826.7
8DPSK			
Lowest	2402	1000	>856.0
Middle	2441	1000	>846.0
Highest	2480	1000	>849.3

GFSK Lowest Channel

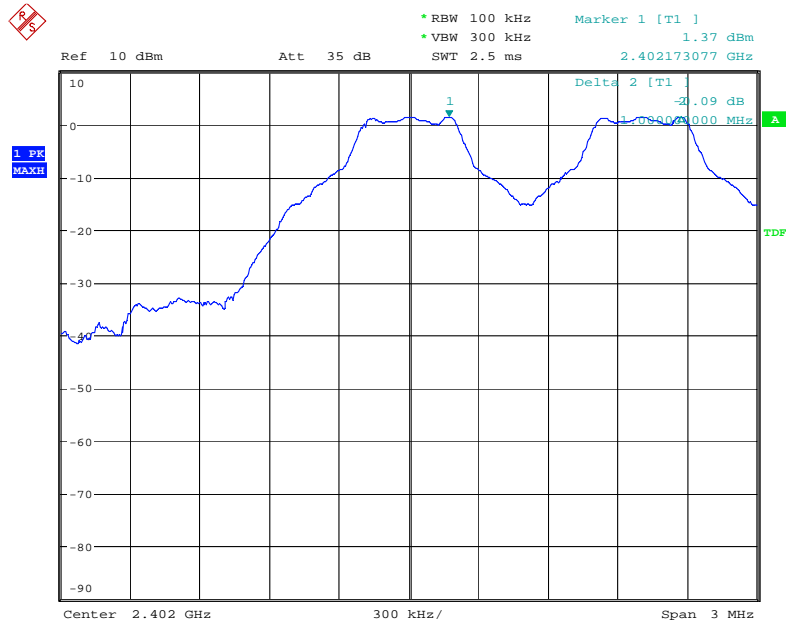

Date: 13.JAN.2015 11:18:39

GFSK Middle Channel

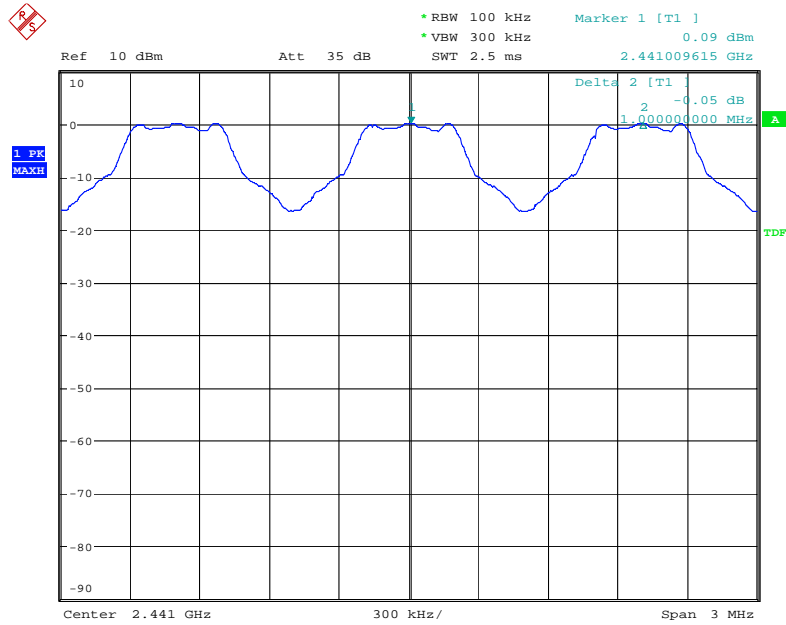

Date: 13.JAN.2015 11:20:25

GFSK Highest Channel

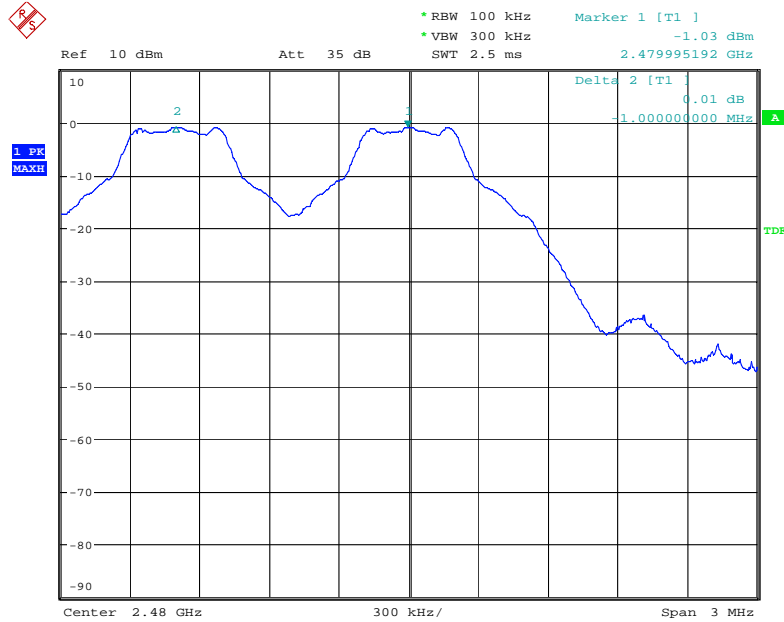

Date: 13.JAN.2015 11:21:30

$\pi/4$ -DQPSK Lowest Channel

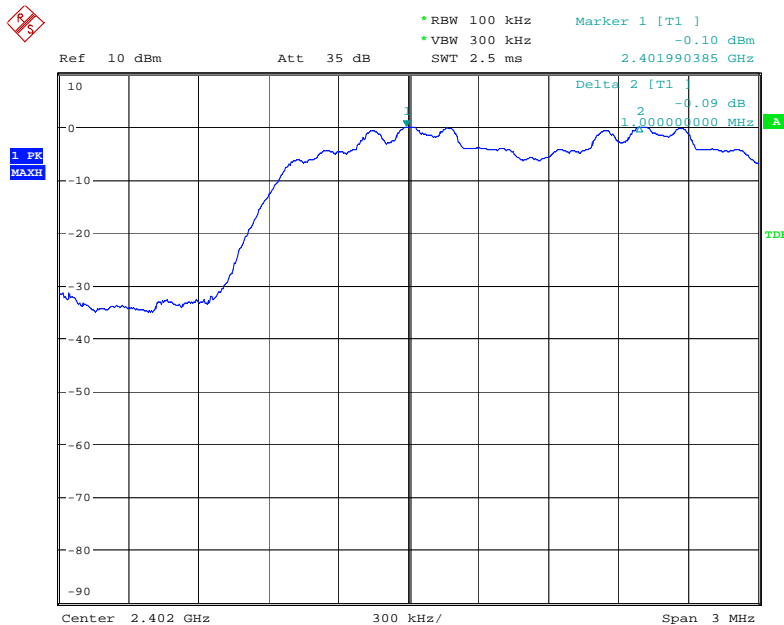

Date: 13.JAN.2015 11:43:17

$\pi/4$ -DQPSK Middle Channel

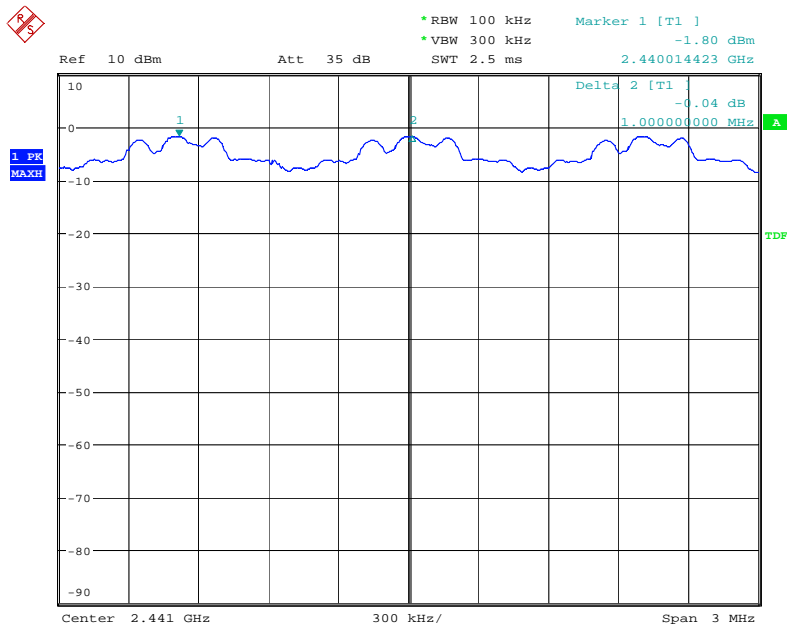

Date: 13.JAN.2015 11:46:13

$\pi/4$ -DQPSK Highest Channel

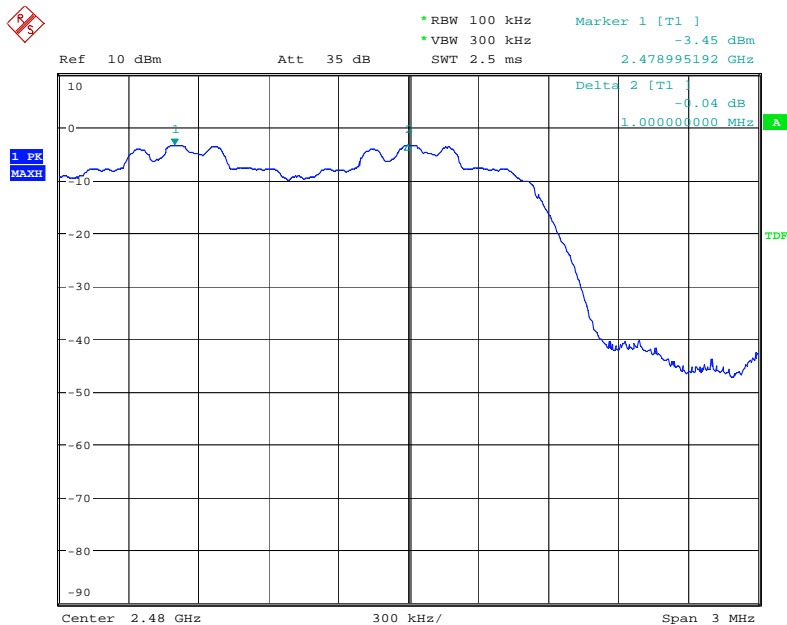

Date: 13.JAN.2015 11:47:52

8DPSK Lowest Channel

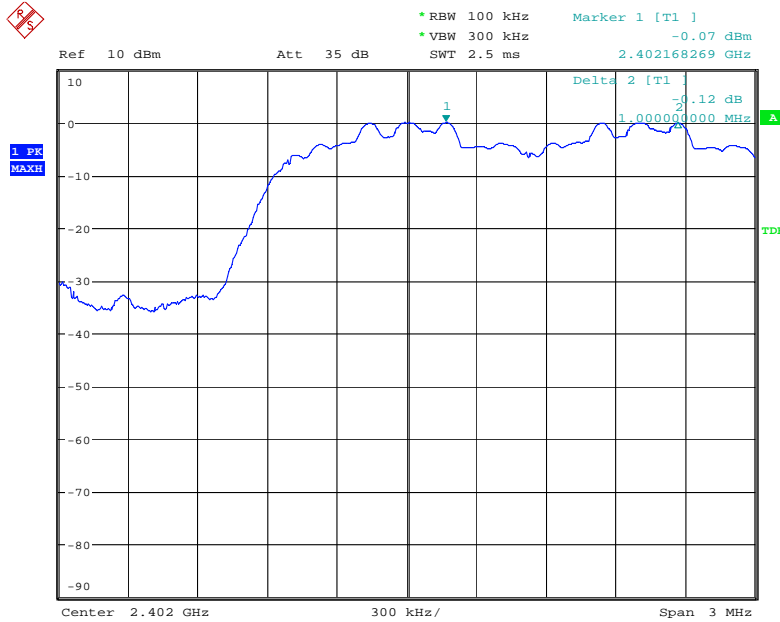

Date: 13.JAN.2015 11:49:42

8DPSK Middle Channel

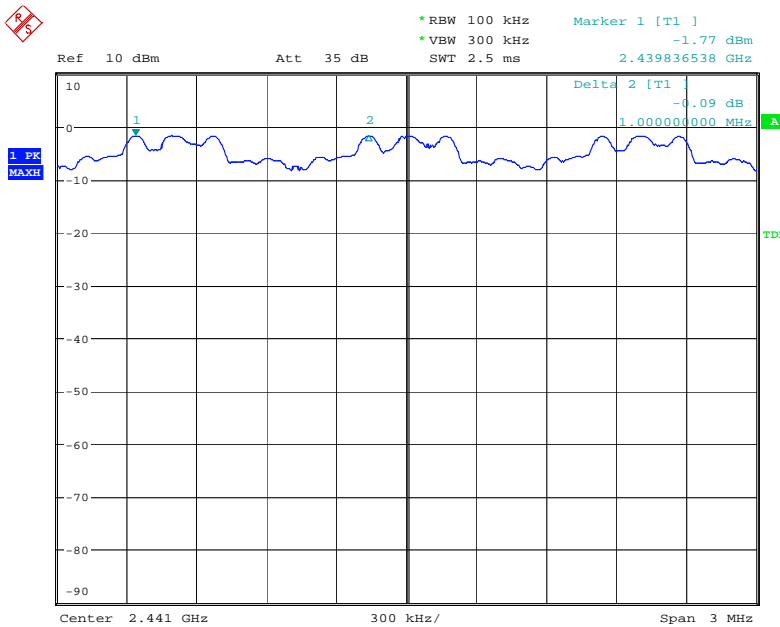

Date: 13.JAN.2015 11:51:25

8DPSK Highest Channel

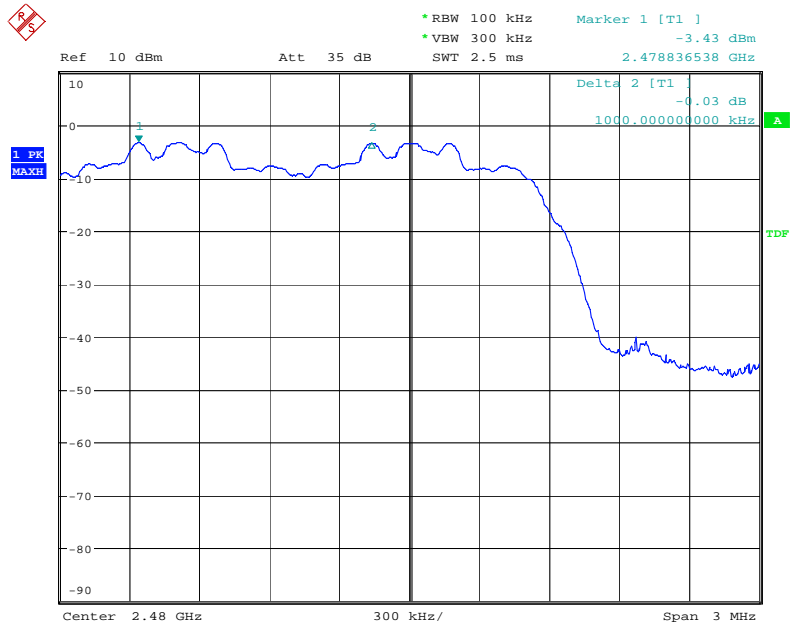

Date: 13.JAN.2015 11:52:56

6. 20dB Bandwidth

6.1 Measurement Procedure

Maximum 20dB RF Bandwidth, FCC Rule 15.247(a)(1):

The antenna port of the EUT was connected to the input of a spectrum analyzer. Analyzer RBW was chosen so that the display was a result of the hopping channel modulation. For each RF output channel investigated, the spectrum analyzer center frequency was set to the channel carrier. Use the spectrum 20dB down delta function to measure the bandwidth.

6.2 Test SET-UP (Block Diagram of Configuration)

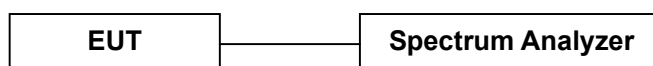

6.3 Measurement Results

Refer to attached data chart.

Modulation:	GFSK, $\pi/4$ -DQPSK, 8DPSK		
RBW:	30KHz	VBW:	100KHz
Packet:	DH5	Spectrum Detector:	PK
Test By:	Sance	Test Date :	Jan. 13, 2015
Temperature :	22 °C	Humidity :	50 %
Test Result:	PASS		

Channel frequency (MHz)	20dB Down BW (kHz)
GFSK	
2402	827
2441	880
2480	875
$\pi/4$ -DQPSK	
2402	1260
2441	1245
2480	1240
8DPSK	
2402	1284
2441	1269
2480	1274

GFSK Lowest Channel

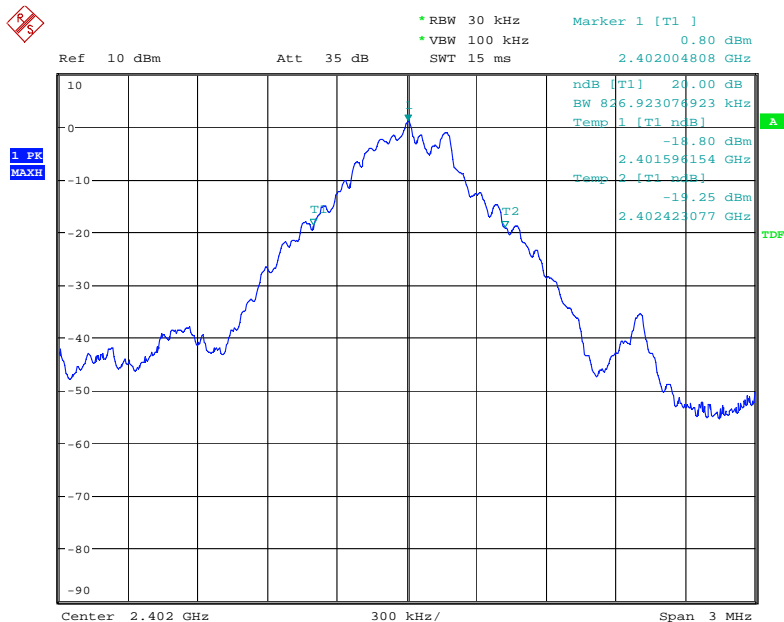

Date: 13.JAN.2015 10:49:39

GFSK Middle Channel

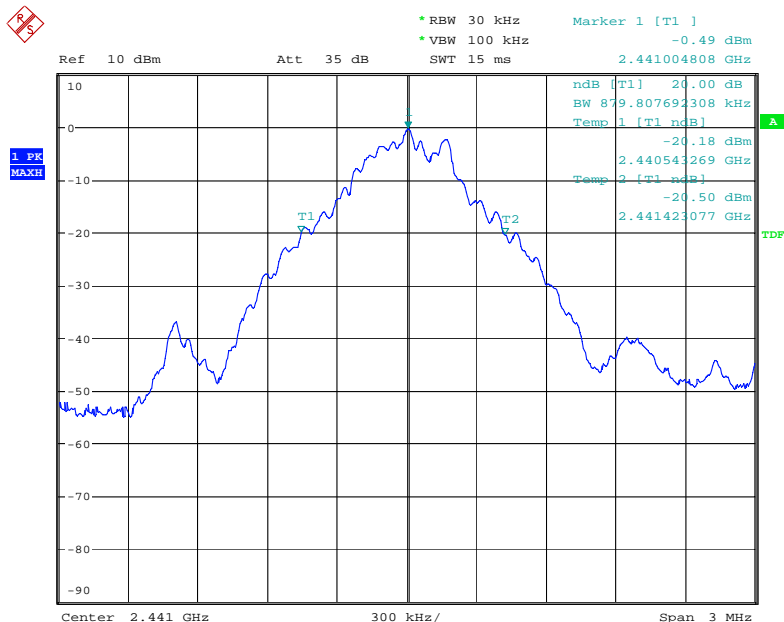

Date: 13.JAN.2015 10:52:27

GFSK Highest Channel

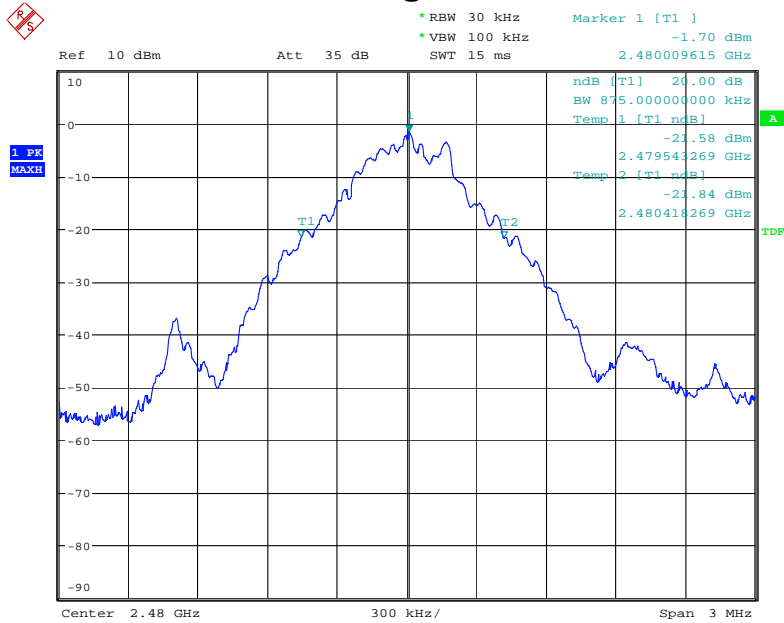

Date: 13.JAN.2015 10:52:56

$\pi/4$ -DQPSK Lowest Channel

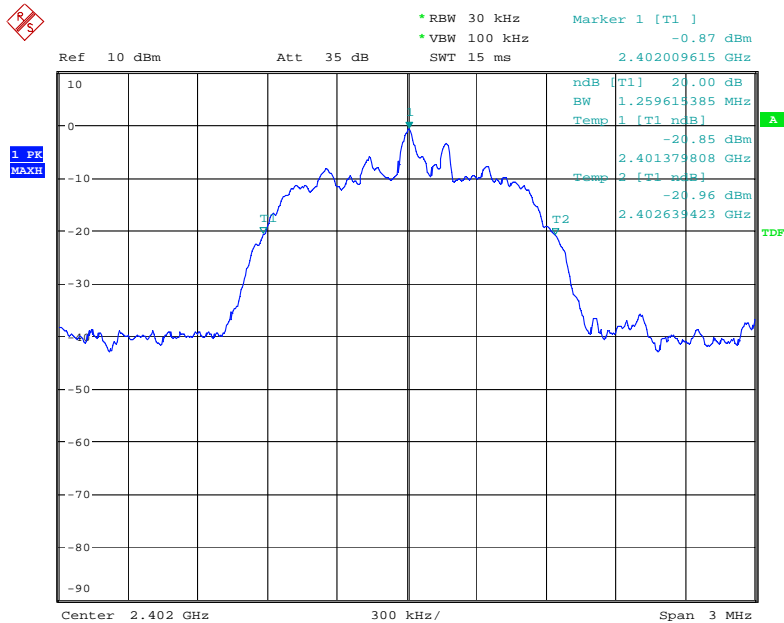

Date: 13.JAN.2015 10:53:44

$\pi/4$ -DQPSK Middle Channel

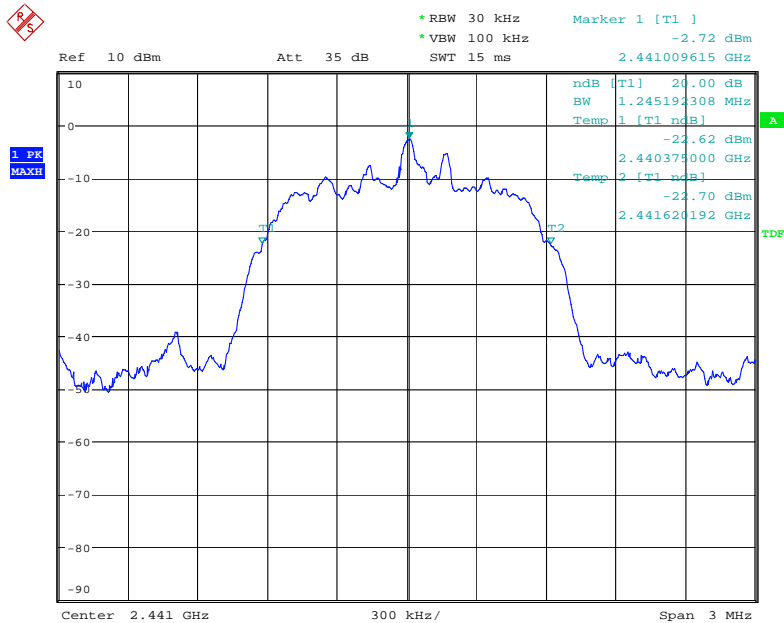

Date: 13.JAN.2015 10:54:17

$\pi/4$ -DQPSK Highest Channel

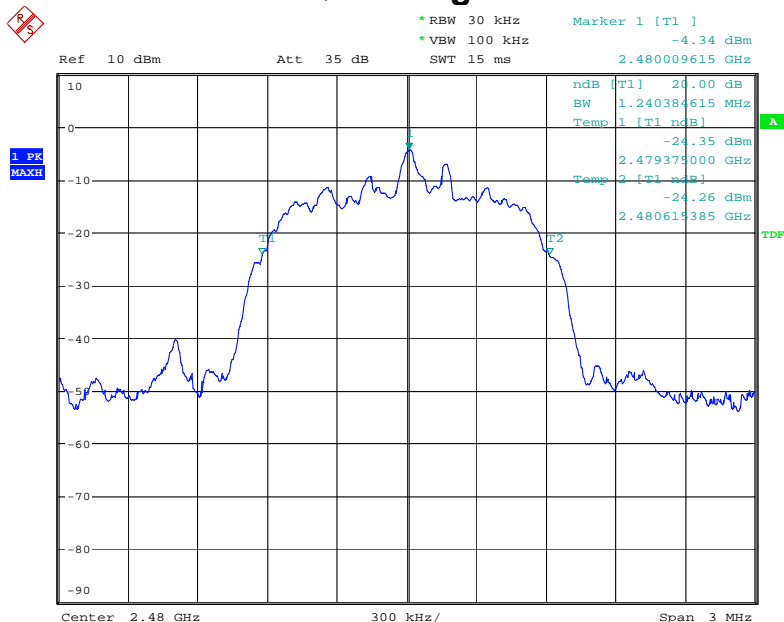

Date: 13.JAN.2015 10:54:51

8DPSK Lowest Channel

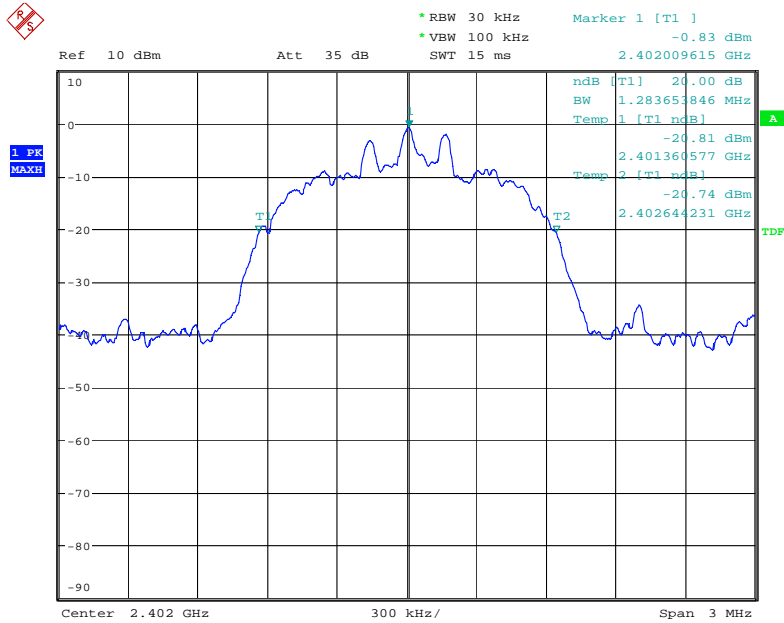

Date: 13.JAN.2015 10:55:53

8DPSK Middle Channel

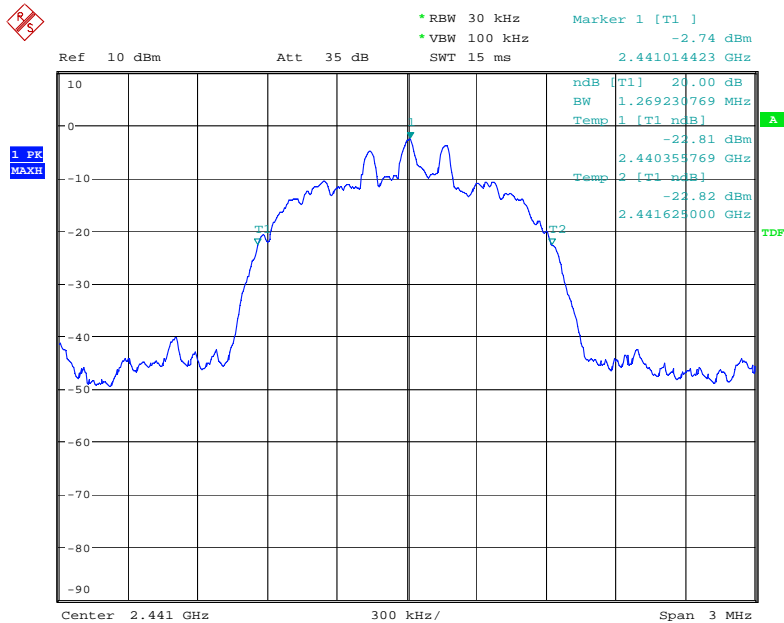

Date: 13.JAN.2015 10:56:29

8DPSK Highest Channel

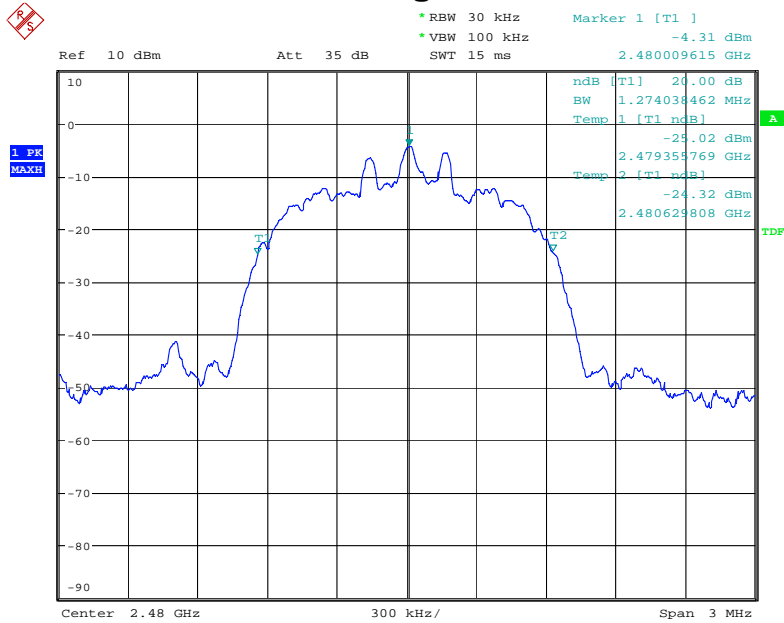

Date: 13.JAN.2015 10:58:28

7. Hopping Channel Number

7.1 Measurement Procedure

Minimum Number of Hopping Frequencies, FCC Rule 15.247(a)(1)(iii):

Remove the antenna from the EUT and then connect a low RF cable from the antenna port to the spectrum, and the spectrum analyzer set to MAX HOLD readings were taken for 3-5 minutes. The channel peaks so recorded were added together, and the total number compared to the minimum number of channels required in the regulation.

7.2 Test SET-UP (Block Diagram of Configuration)



7.3 Measurement Results

Refer to attached data chart.

Modulation	GFSK, $\pi/4$ -DQPSK, 8DPSK		
RBW:	100KHz	VBW:	300KHz
Packet:	DH5	Spectrum Detector:	PK
Test By:	Sance	Test Date :	Jan. 13, 2015
Temperature :	22 °C	Humidity :	50 %
Test Result:	PASS		

Hopping Channel Frequency Range	Number of Hopping Channels	Limit
2402-2480	79	≥ 15

The worst case: GFSK

GFSK

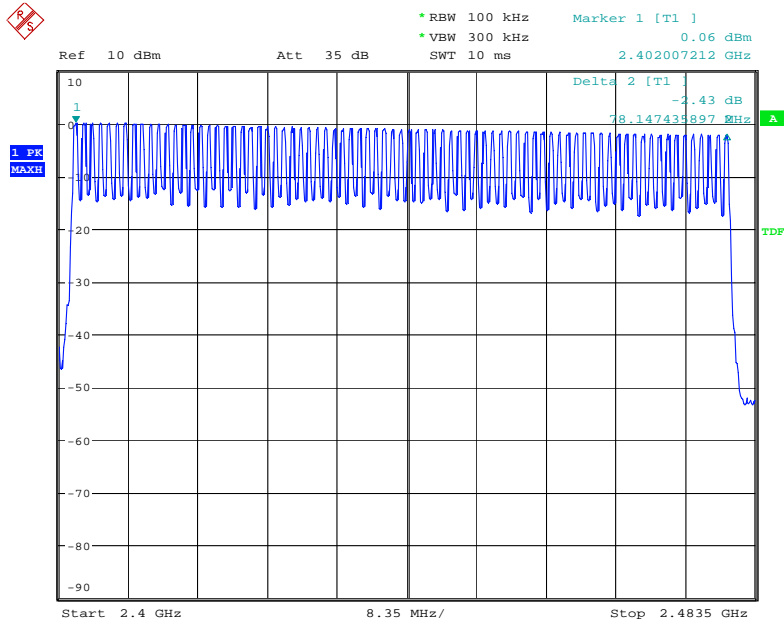

Date: 13.JAN.2015 12:17:52

8. Time of Occupancy (Dwell Time)

8.1 Measurement Procedure

Average Channel Occupancy Time, FCC Ref:15.247(a)(1)(iii):

Connect EUT antenna terminal to the spectrum analyzer with a low loss cable. The spectrum analyzer center frequency was set to one of the known hopping channels. The Sweep was set to 10 ms, the SPAN was set to Zero SPAN. The time duration of the transmissions so captured was measured with the Marker Delta function

8.2 Measurement Results

The maximum number of hopping channels in 31.6s (0.4s/Channel x 79 Channel)

Refer to attached data chart.

Modulation :	GFSK, $\pi/4$ -DQPSK, 8DPSK		
RBW :	1MHz	VBW :	3MHz
Spectrum Detector:	PK	Test By:	Sance
Test Date :	Jan. 13, 2015	Temperature :	22 °C
Test Result:	PASS	Humidity :	50 %

Packet	Frequency (MHz)	Result (msec)	Limit (msec)
GFSK			
DH1	2441	$0.425 \text{ (ms)} * (1600 / (2 * 79)) * 31.6 = 136.0$	400
DH3	2441	$1.683 \text{ (ms)} * (1600 / (4 * 79)) * 31.6 = 269.3$	400
DH5	2441	$2.933 \text{ (ms)} * (1600 / (6 * 79)) * 31.6 = 312.9$	400
$\pi/4$-DQPSK			
2-DH1	2441	$0.425 \text{ (ms)} * (1600 / (2 * 79)) * 31.6 = 136.0$	400
2-DH3	2441	$1.691 \text{ (ms)} * (1600 / (4 * 79)) * 31.6 = 270.6$	400
2-DH5	2441	$2.941 \text{ (ms)} * (1600 / (6 * 79)) * 31.6 = 313.7$	400
8DPSK			
3-DH1	2441	$0.429 \text{ (ms)} * (1600 / (2 * 79)) * 31.6 = 137.3$	400
3-DH3	2441	$1.695 \text{ (ms)} * (1600 / (4 * 79)) * 31.6 = 271.2$	400
3-DH5	2441	$2.945 \text{ (ms)} * (1600 / (6 * 79)) * 31.6 = 314.1$	400

GFSK DH1

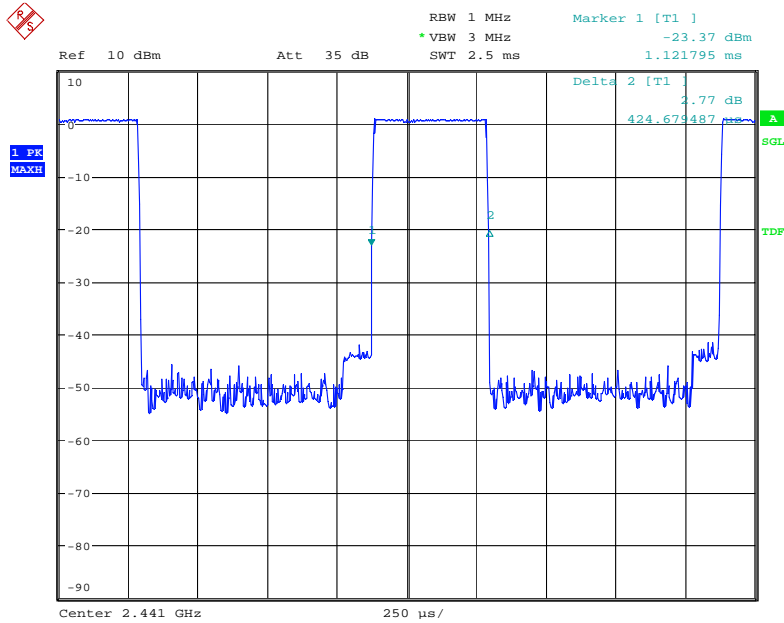

GFSK DH3

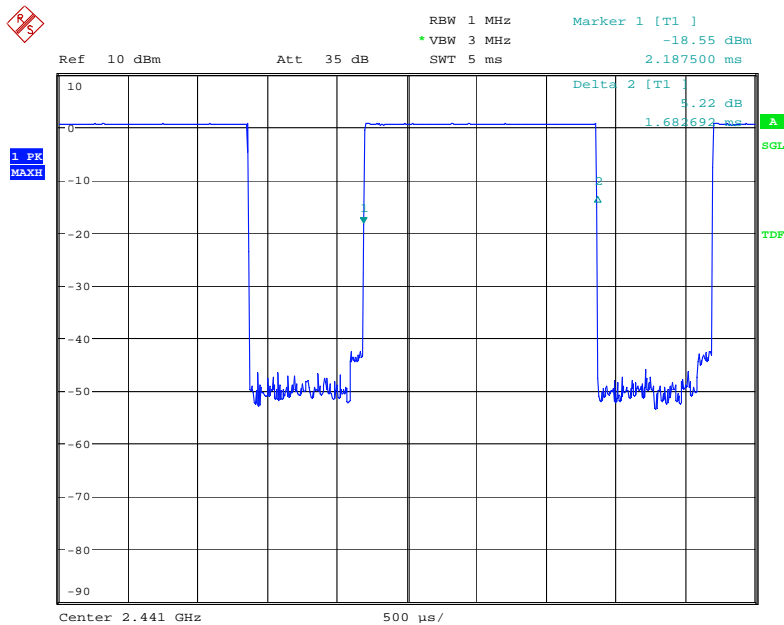

GFSK DH5

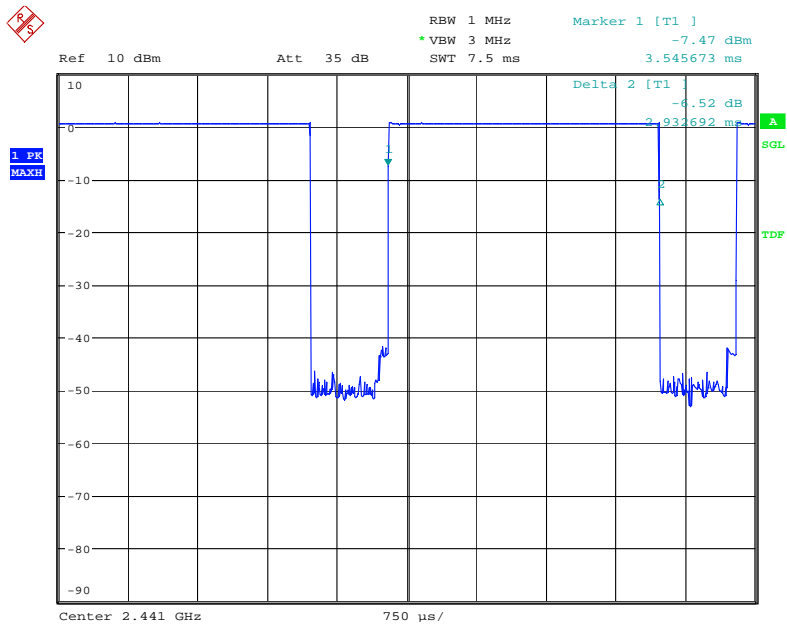

Date: 13.JAN.2015 13:07:16

$\pi/4$ -DQPSK 2-DH1

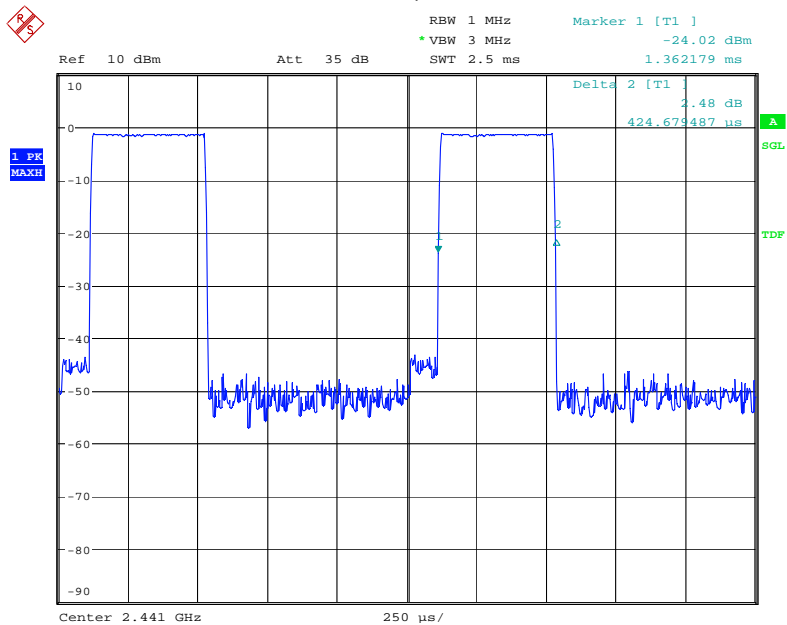

Date: 13.JAN.2015 13:08:03

$\pi/4$ -DQPSK 2-DH3

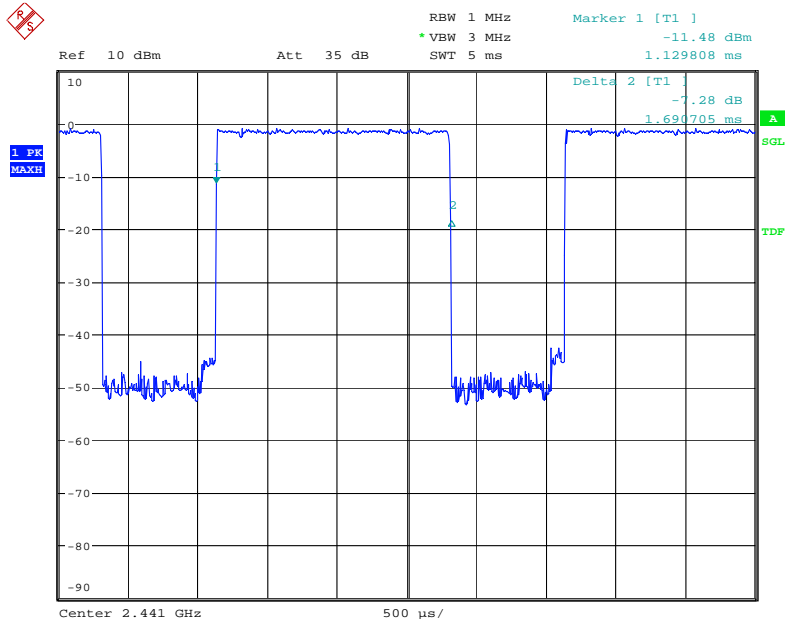

Date: 13.JAN.2015 13:08:27

$\pi/4$ -DQPSK 2-DH5

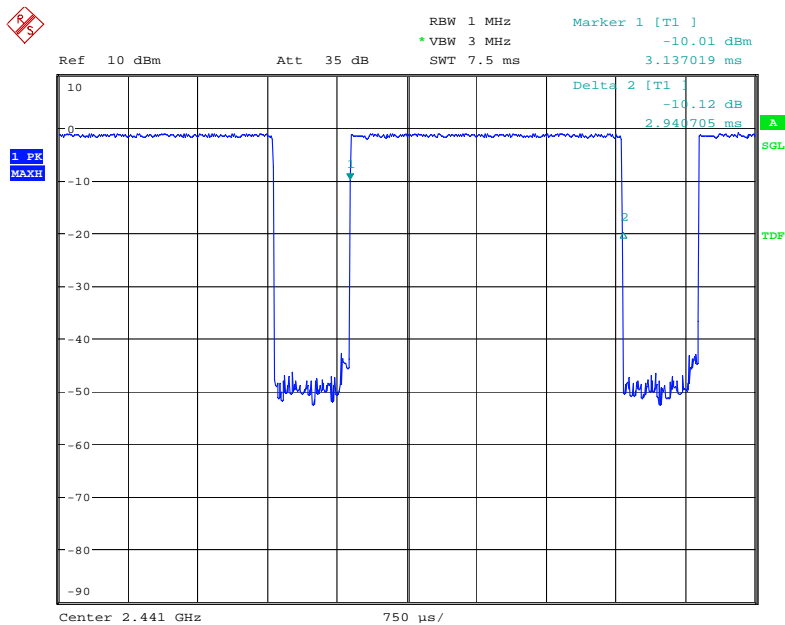

Date: 13.JAN.2015 13:08:50

8DPSK 3-DH1

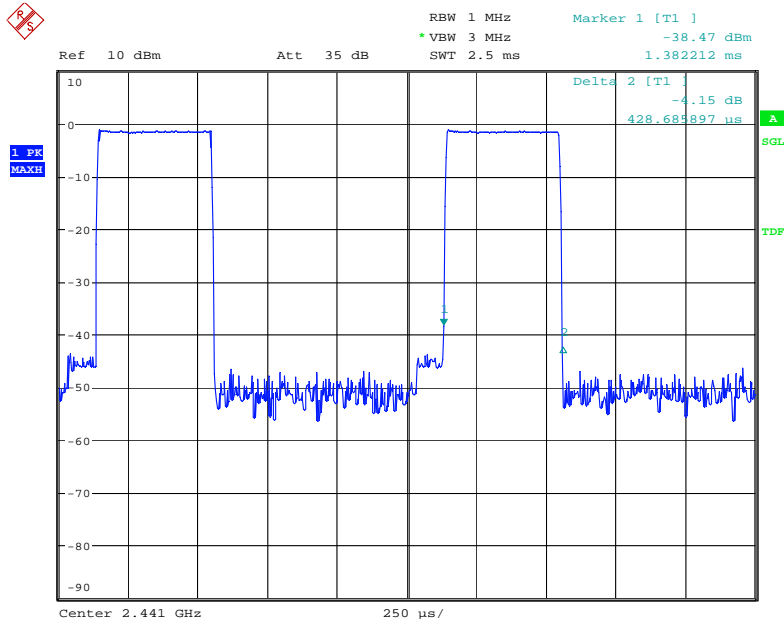

Date: 13.JAN.2015 13:09:19

8DPSK 3-DH3

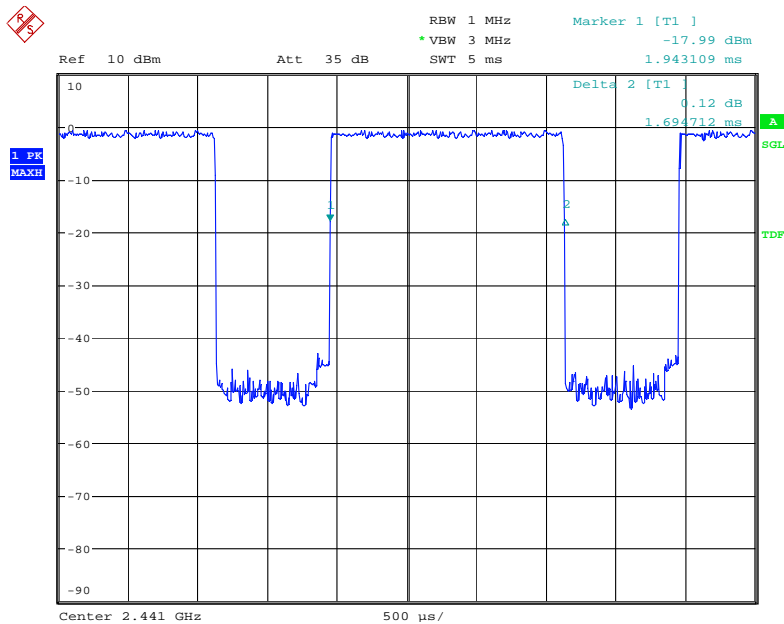

Date: 13.JAN.2015 13:09:45

8DPSK 3-DH5

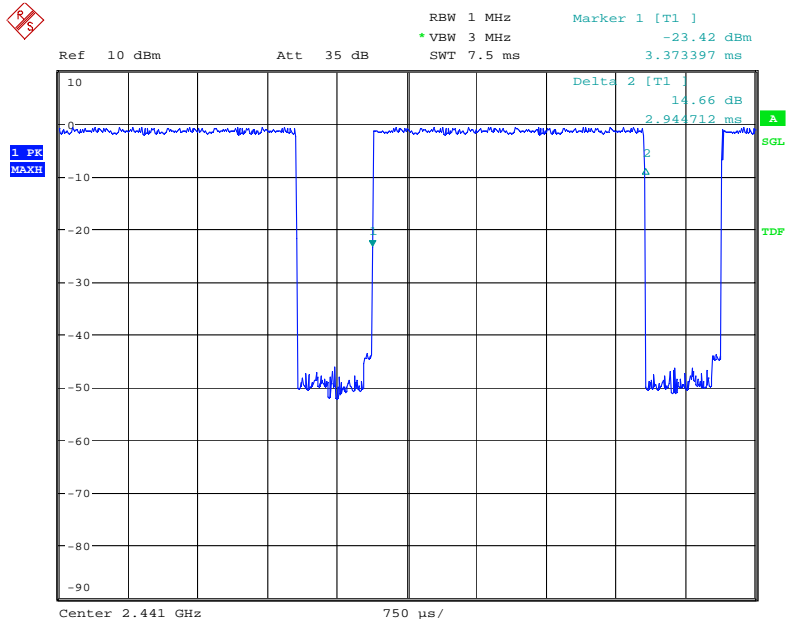

Date: 13.JAN.2015 13:10:12

9. MAXIMUM PEAK OUTPUT POWER

9.1 Measurement Procedure

Maximum Conducted Output Power at Antenna Terminals, FCC Rules 15.247(b)(1):

Remove the antenna from the EUT and then connect a low RF cable from the antenna port to the spectrum. The analyzer was set for RBW > 20dB bandwidth and power was read directly in dBm. Cable loss was considered during this measurement.

9.2 Measurement Results

Refer to attached data chart.

Modulation :	GFSK, $\pi/4$ -DQPSK, 8DPSK		
RBW :	3MHz	VBW :	3MHz
Spectrum Detector:	PK	Test Date :	Jan. 13, 2015
Test By:	Sance	Temperature :	22 °C
Test Result:	PASS	Humidity :	50 %

Channel Frequency (MHz)	Cable Loss dB	Peak Power output(mW)	Peak Power output(dBm)	Peak Power Limit(dBm)	Pass/Fail
GFSK					
2402.00	1.5	1.79	2.52	30	PASS
2441.00	1.5	1.33	1.23	30	PASS
2480.00	1.5	1.03	0.13	30	PASS
$\pi/4$-DQPSK					
2402.00	1.5	1.36	1.33	21	PASS
2441.00	1.5	0.96	-0.16	21	PASS
2480.00	1.5	0.68	-1.69	21	PASS
8DPSK					
2402.00	1.5	1.44	1.58	21	PASS
2441.00	1.5	1.03	0.14	21	PASS
2480.00	1.5	0.75	-1.26	21	PASS

GFSK Lowest Channel

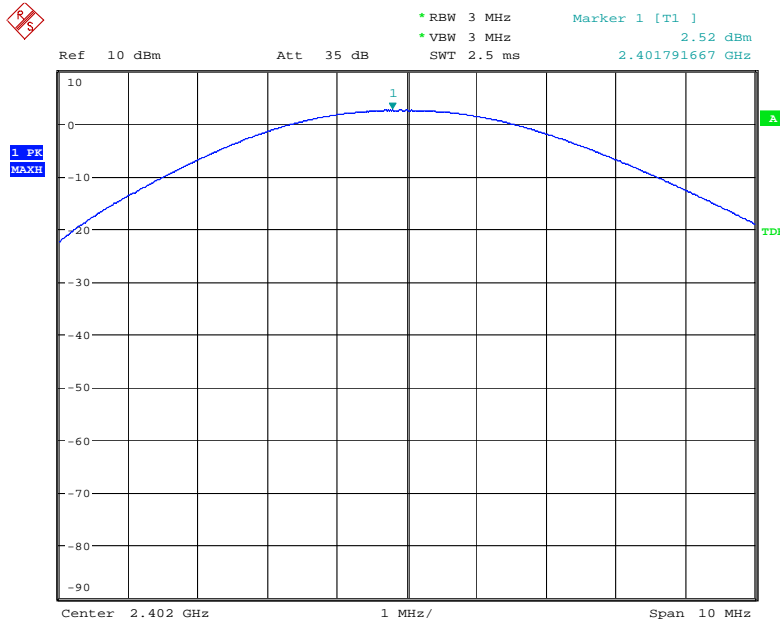

Date: 13.JAN.2015 13:11:12

GFSK Middle Channel

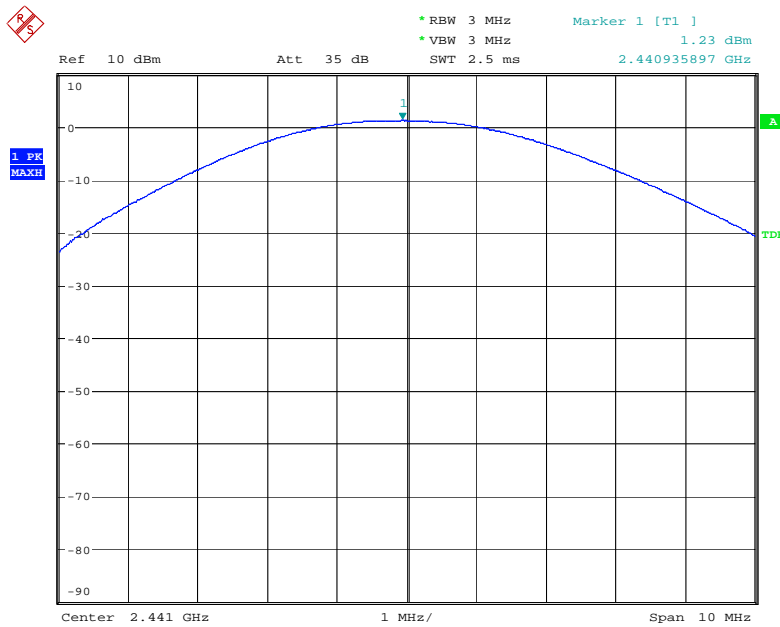

Date: 13.JAN.2015 13:11:24

GFSK Highest Channel

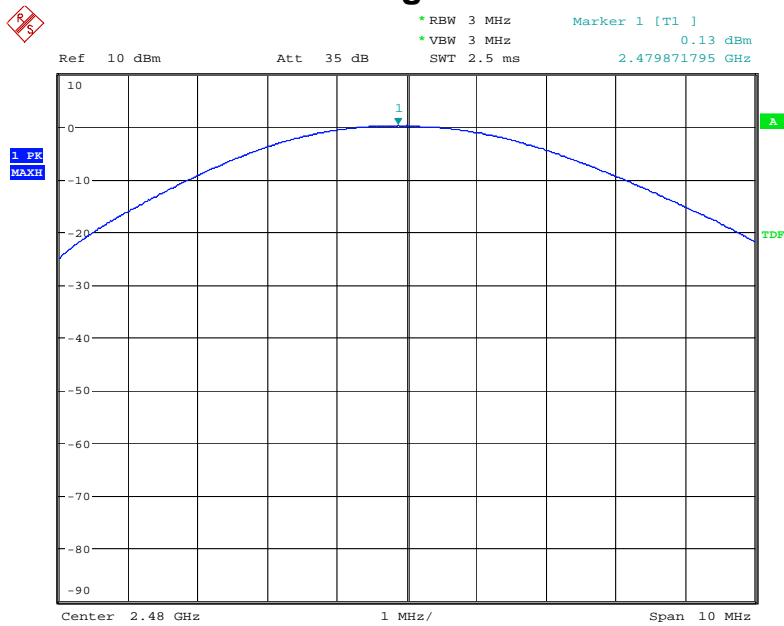

Date: 13.JAN.2015 13:11:35

$\pi/4$ -DQPSK Lowest Channel

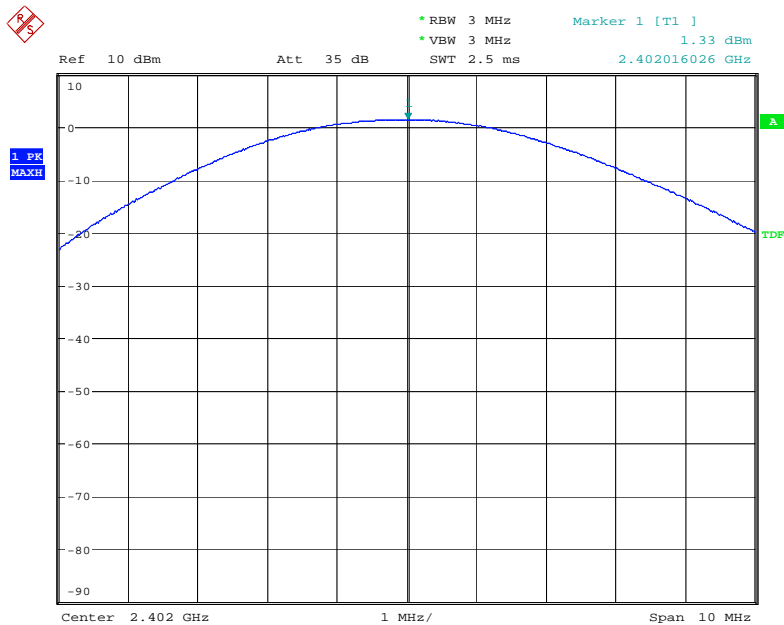

Date: 13.JAN.2015 13:12:11

$\pi/4$ -DQPSK Middle Channel

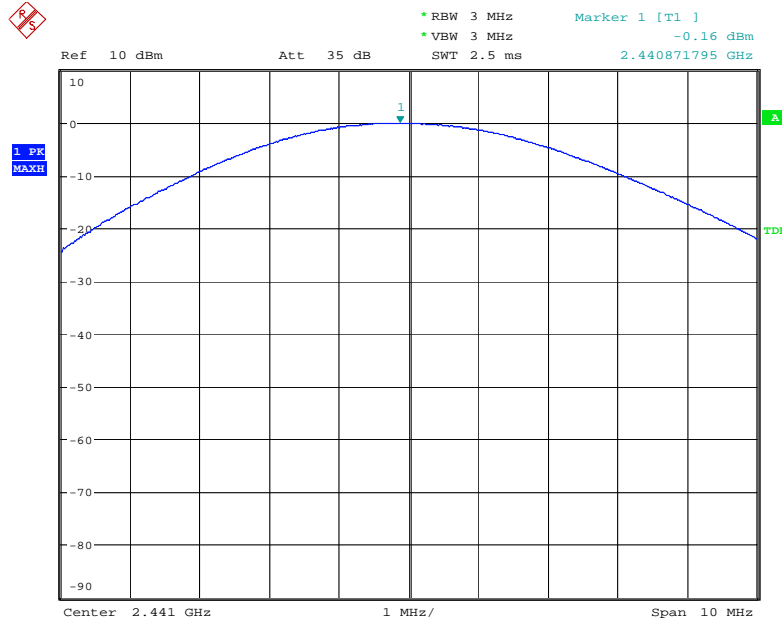

Date: 13.JAN.2015 13:12:30

$\pi/4$ -DQPSK Highest Channel

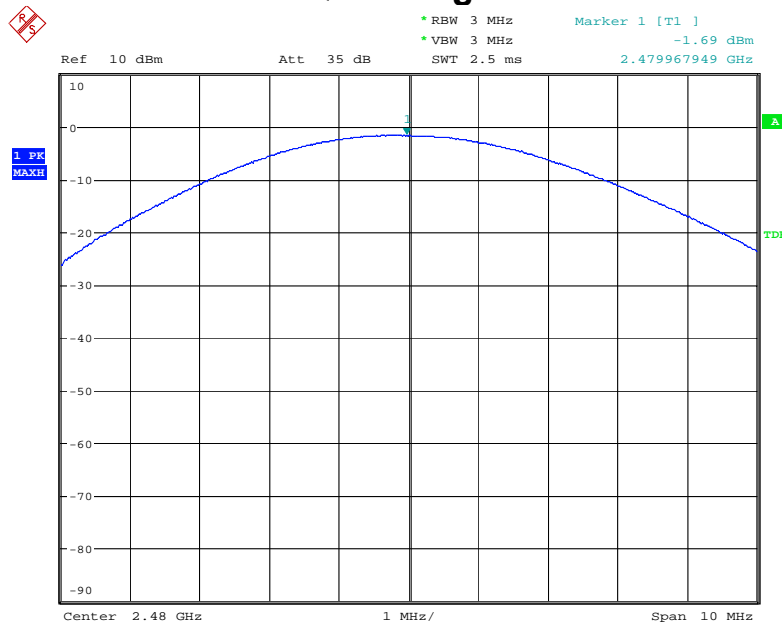

Date: 13.JAN.2015 13:12:55

8DPSK Lowest Channel

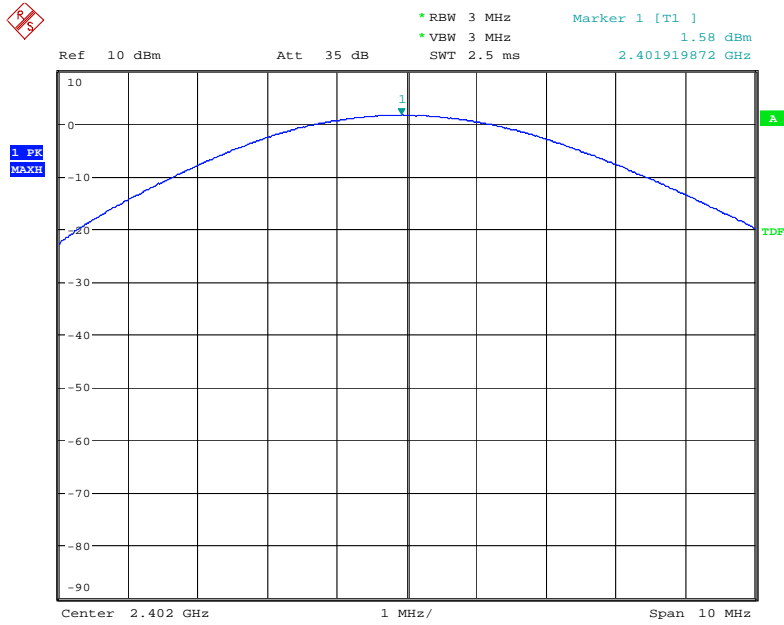

Date: 13.JAN.2015 13:13:26

8DPSK Middle Channel

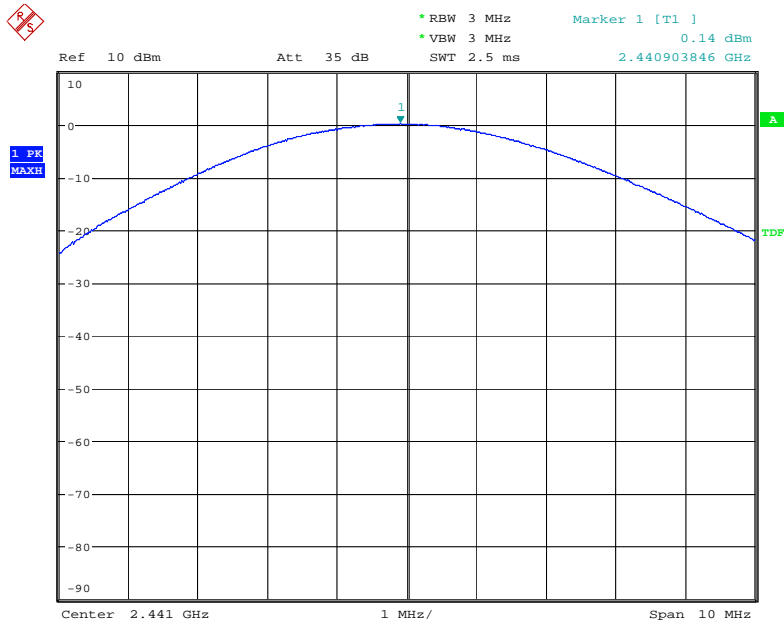

Date: 13.JAN.2015 13:13:40

8DPSK Highest Channel

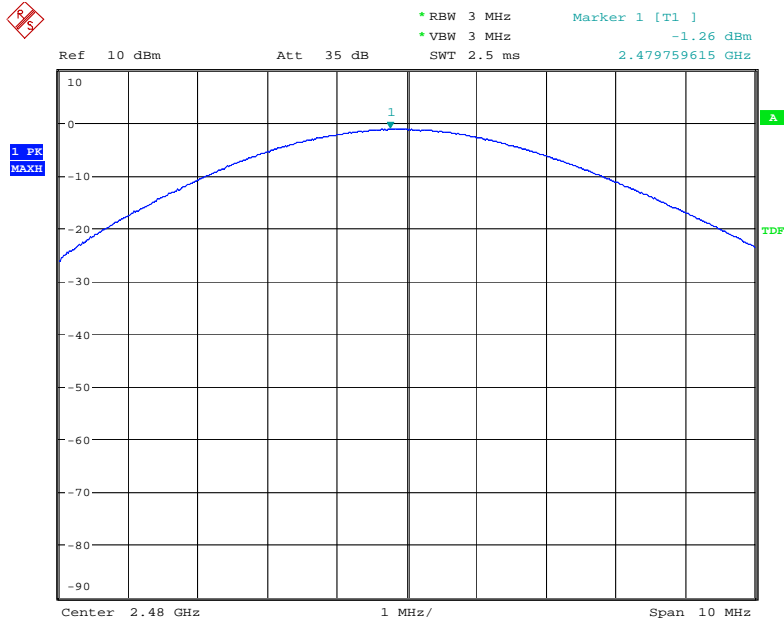

Date: 13.JAN.2015 13:13:56

10. Band Edge

10.1 Measurement Procedure

Out of Band Conducted Emissions, FCC Rule 15.247(d):

The transmitter output is connected to spectrum analyzer. The resolution bandwidth is set to 100KHz, and the video bandwidth set to 300KHz.

A Quasi-peak measurement was then made for that frequency point for below 1GHz test. PK and AV for above 1GHz emission test.

For 30MHz to 1GHz:

Set the spectrum analyzer as: RBW=120kHz, VBW=300kHz, Detector=Quasi-Peak

For Above 1GHz:

Set the spectrum analyzer as: RBW=1MHz, VBW=3MHz, Detector=Peak.

Set the spectrum analyzer as: RBW=1MHz, VBW=10Hz, Detector=Peak.

During the radiated emission test, the spectrum analyzer was set with the following configurations:

Frequency Band (MHz)	Level	Resolution Bandwidth	Video Bandwidth
30 to 1000	QP	120 kHz	300 kHz
Above 1000	Peak	1 MHz	3 MHz
	Average	1 MHz	10 Hz

10.2 Limit

In any 100KHz bandwidth outside the frequency band in which the spread spectrum or digitally modulated intentional radiator is operating, the radio frequency power that is produced by the intentional radiator shall be at least 20dB below that in the 100KHz bandwidth within the band that contains the highest level of the desired power, based on either an RF conducted or a radiated measurement.

10.3 Measurement Results

Please see below test table and plots.
 For Radiated Emission
 The worst case: GFSK

Freq. (MHz)	Ant. Pol.	Reading Level (dBuV)		Factor (dB/m)	Emission Level (dBuV)		Limit 3m (dBuV/m)		Margin (dB)	
		Peak	AV		Peak	AV	Peak	AV	Peak	AV
GFSK										
2397.960	H	38.25	25.43	8.09	46.34	33.52	74.00	54.00	-27.66	-20.48
2397.830	V	29.94	17.04	8.09	38.03	25.13	74.00	54.00	-35.97	-28.87
2485.570	H	29.45	17.35	8.38	37.83	25.73	74.00	54.00	-36.17	-28.27
2486.330	V	30.06	18.97	8.38	38.44	27.35	74.00	54.00	-35.56	-26.65

- Note:**
- (1) Emission Level= Reading Level + Factor
 - (2) Factor= Antenna Gain + Cable Loss – Amplifier Gain
 - (3) Horn antenna used for the emission over 1000MHz.

For RF Conducted

GFSK Lowest Channel

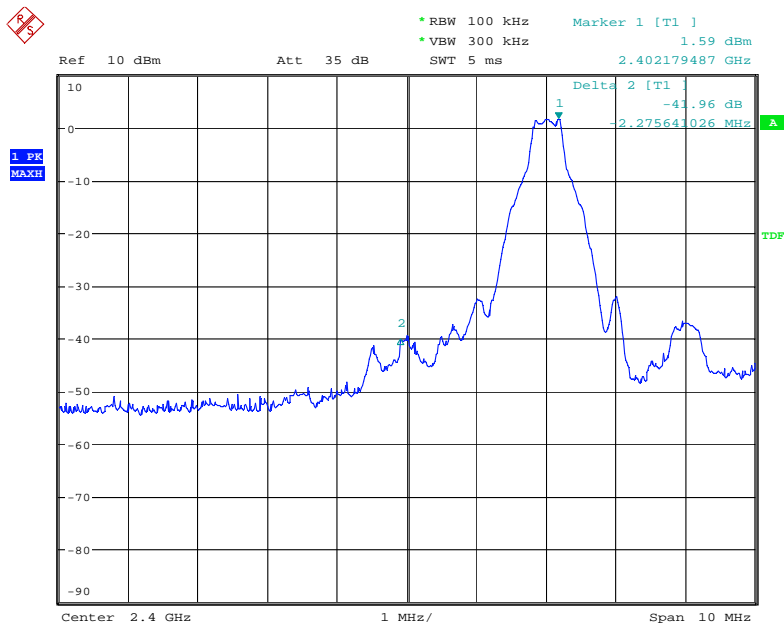

Date: 13.JAN.2015 13:18:13

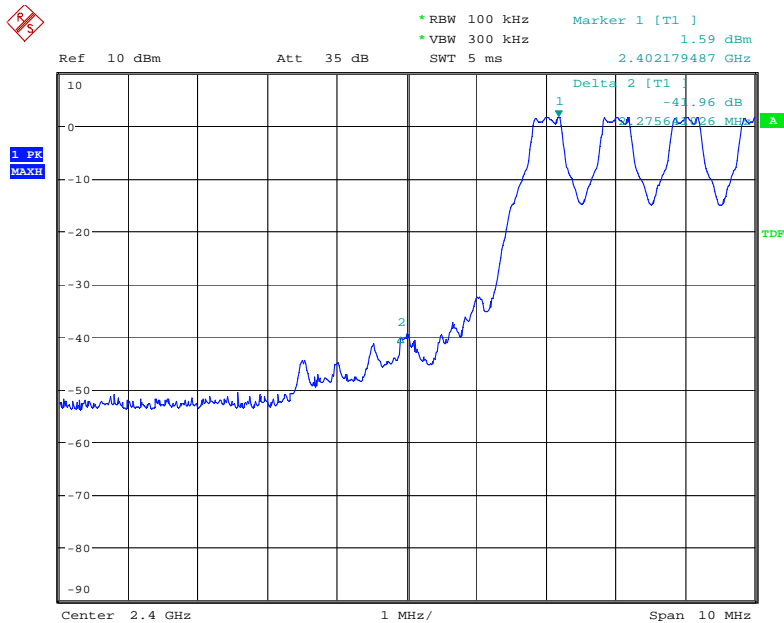

Date: 13.JAN.2015 13:19:02

GFSK Highest Channel

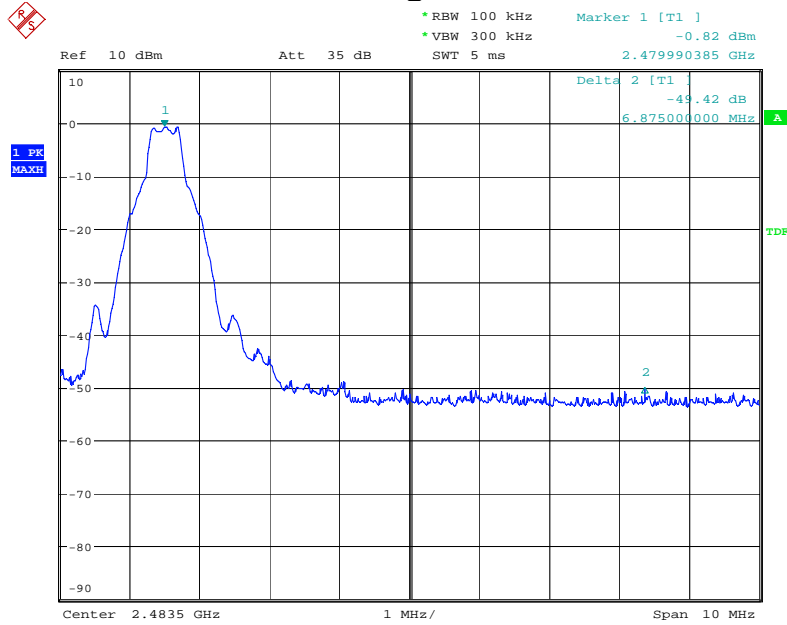

Date: 13.JAN.2015 13:20:14

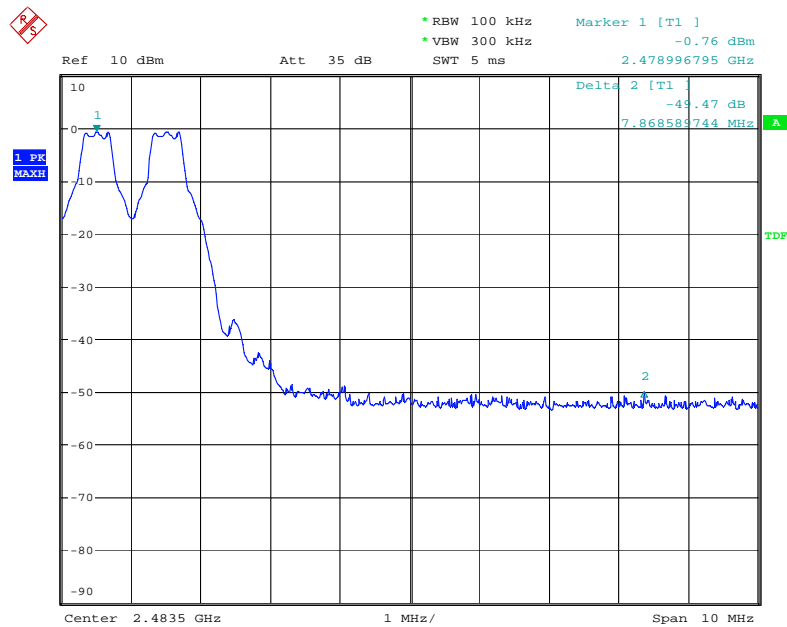

Date: 13.JAN.2015 13:20:47

$\pi/4$ -DQPSK Lowest Channel

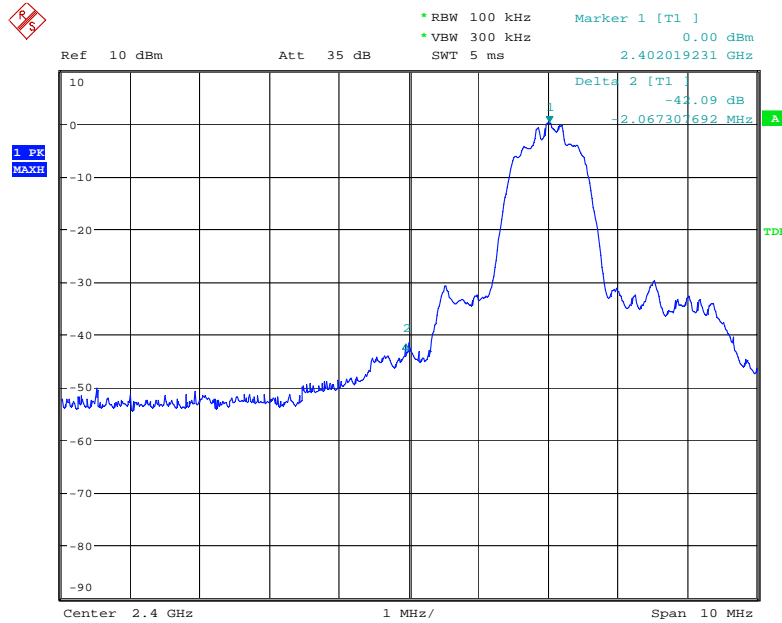

Date: 13.JAN.2015 13:21:53

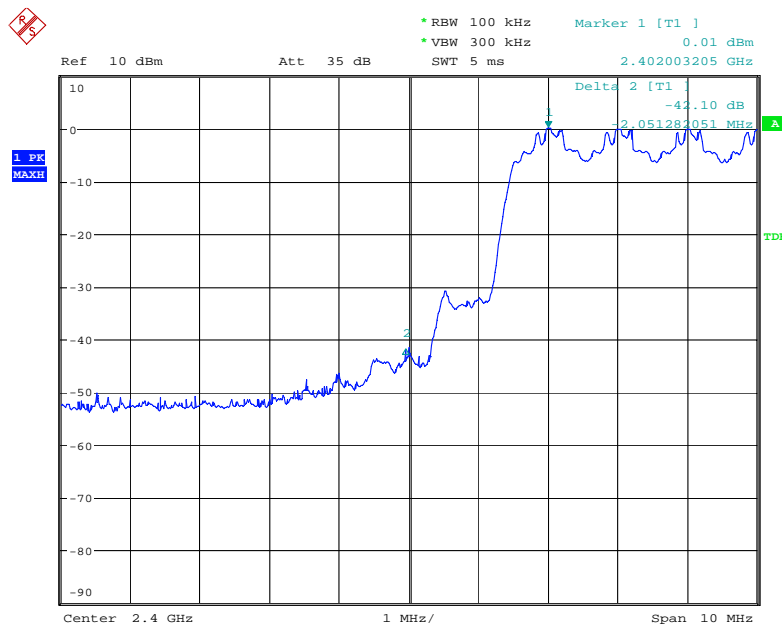

Date: 13.JAN.2015 13:23:20

$\pi/4$ -DQPSK Highest Channel

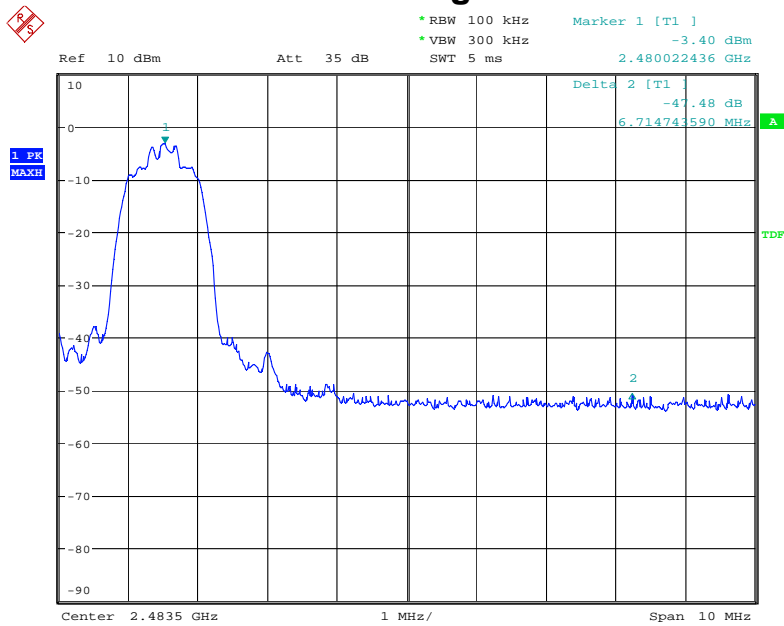

Date: 13.JAN.2015 13:24:30

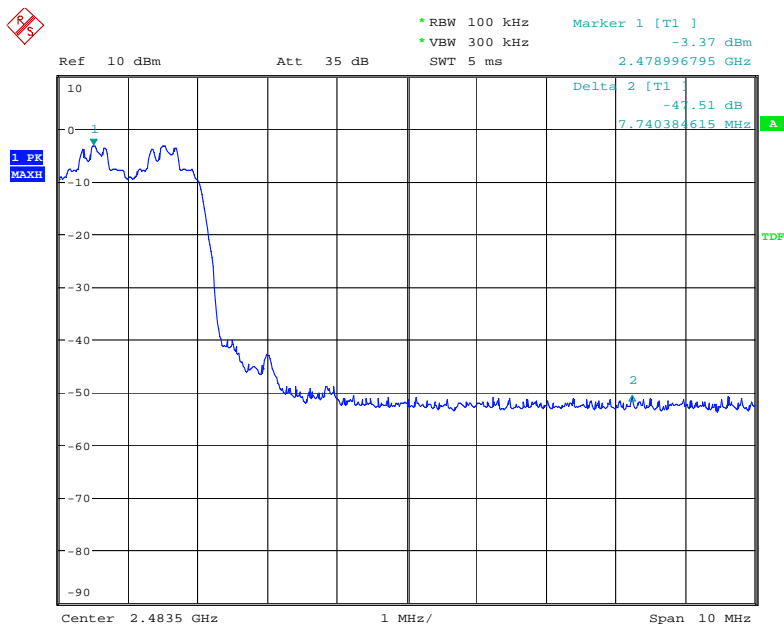

Date: 13.JAN.2015 13:24:52

8DPSK Lowest Channel

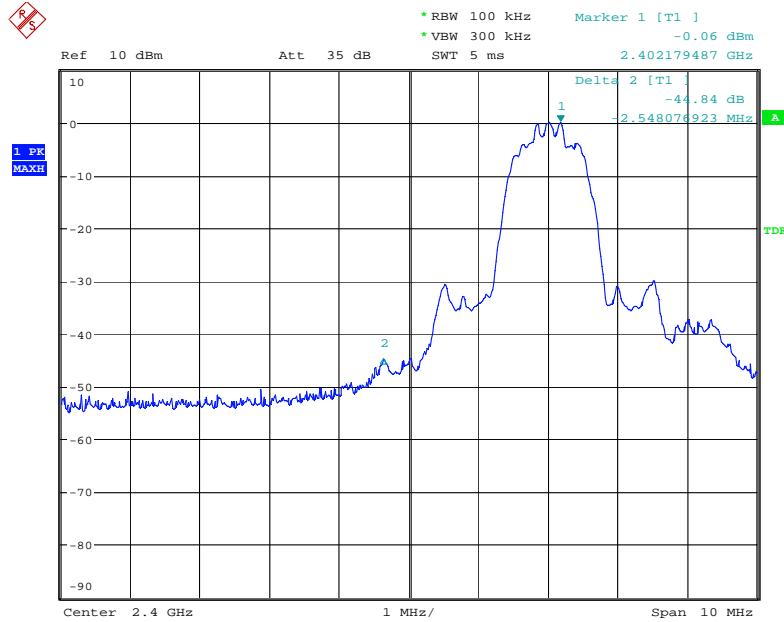

Date: 13.JAN.2015 13:25:36

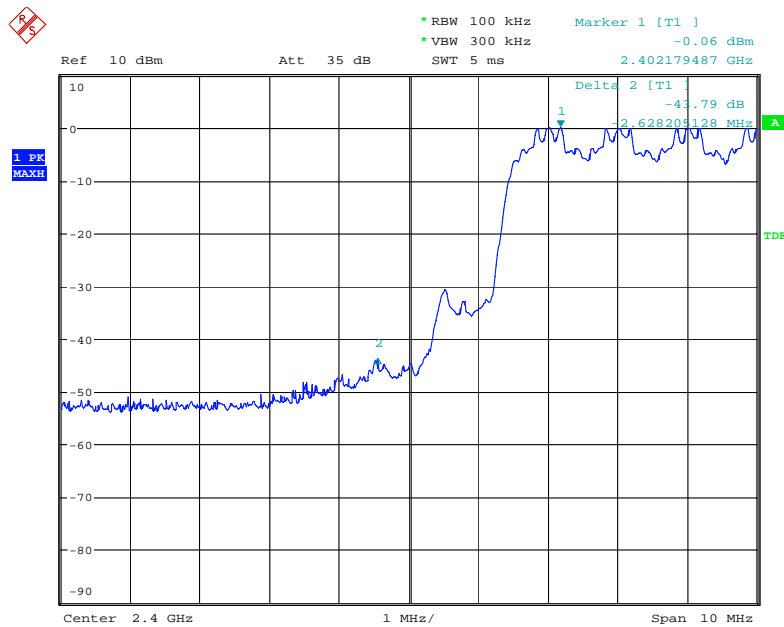

Date: 13.JAN.2015 13:26:45

8DPSK Highest Channel

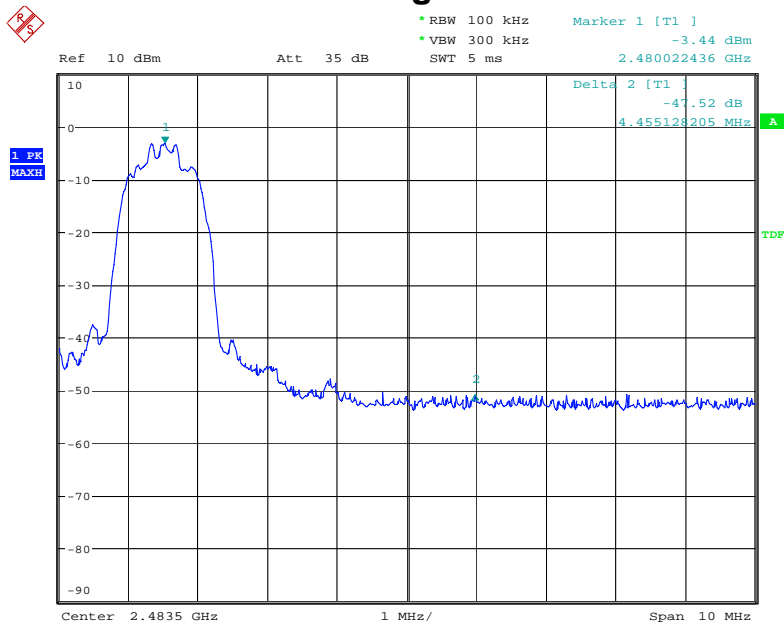

Date: 13.JAN.2015 13:28:54

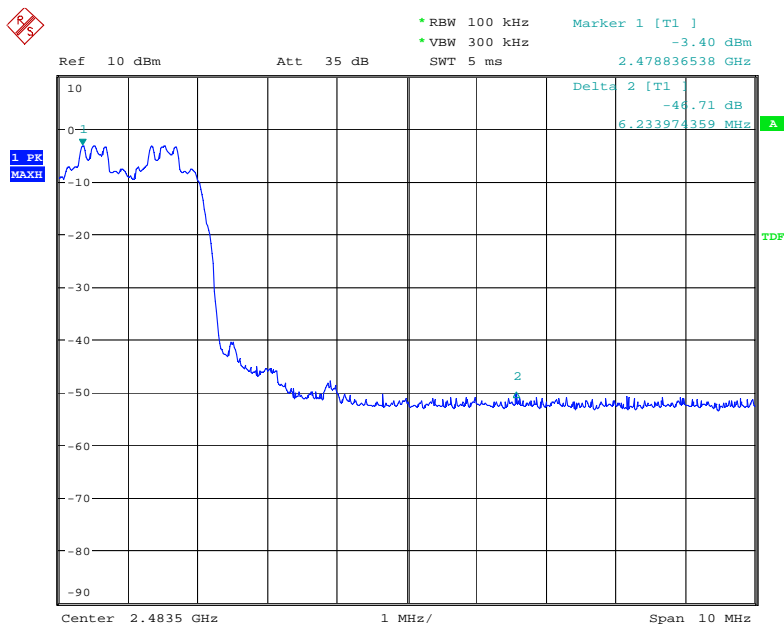

Date: 13.JAN.2015 13:29:40

11. Antenna Application

11.1 Antenna requirement

According to of FCC part 15C section 15.203 and 15.240:

An intentional radiator shall be designed to ensure that no antenna other than that furnished by the responsible party shall be used with the device. The use of a permanently attached antenna or of an antenna that uses a unique coupling to the intentional radiator, the manufacturer may design the unit so that a broken antenna can be replaced by the user, but the use of a standard antenna jack or electrical connector is prohibited.

Systems operating in the 2400-2483.5MHz band that are used exclusively for fixed, point-to-point operations may employ transmitting antennas with directional gain greater than 6dBi provided the maximum peak output power of the intentional radiator is reduced by 1dB for every 3dB that the directional gain of the antenna exceeds 6dBi.

11.2 Measurement Results

The antenna is integrated on the main PCB and no consideration of replacement, and the best case gain of the antenna is 2dBi. So, the antenna is considered meet the requirement.

12. Conducted Spurious Emissions

12.1 Measurement Procedure

Out of Band Conducted Spurious Emissions, FCC Rule 15.247(d):

The transmitter output is connected to spectrum analyzer. All spurious emission and up to the tenth harmonic was measured and they were found to be at least 20dB below the highest level of the desired power in the passband.

12.2 Measurement Results

Please refer to following plots, the worst case (GFSK) was shown.

Lowest Channel

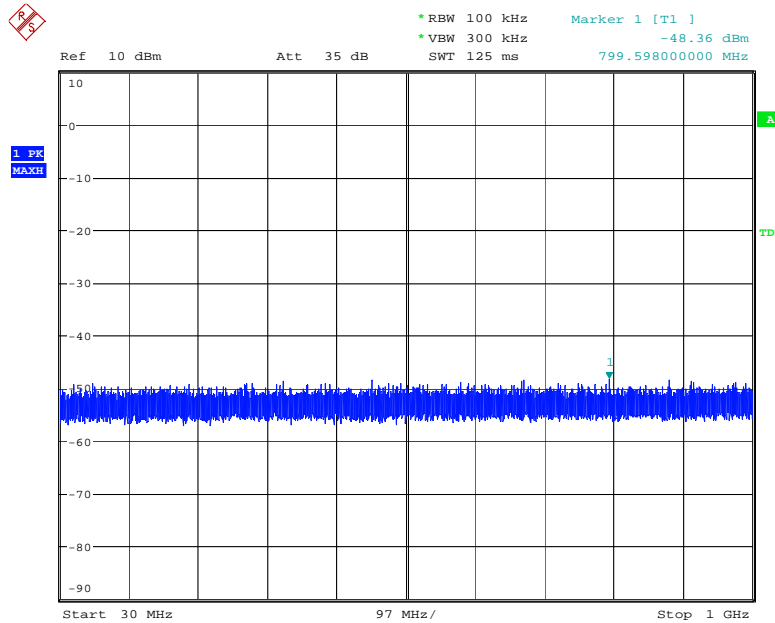

Date: 13.JAN.2015 15:44:47

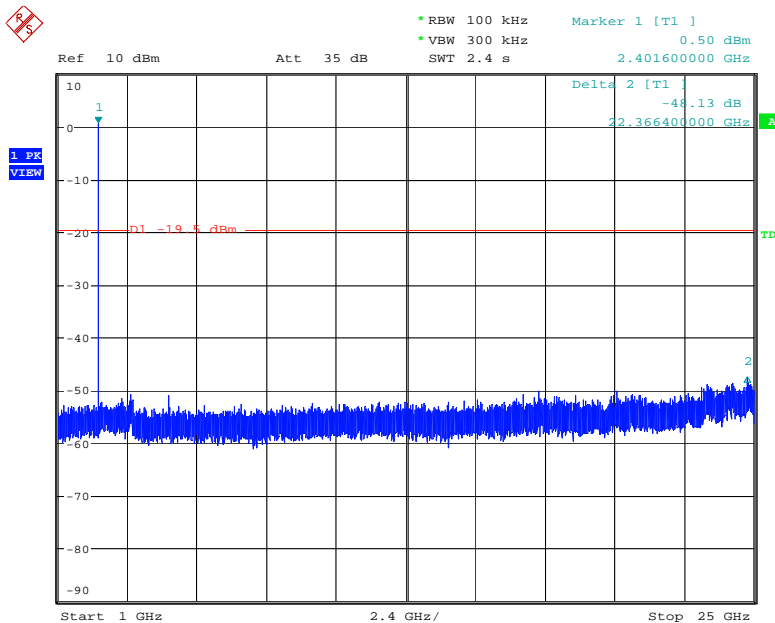

Date: 13.JAN.2015 13:15:31

Middle Channel

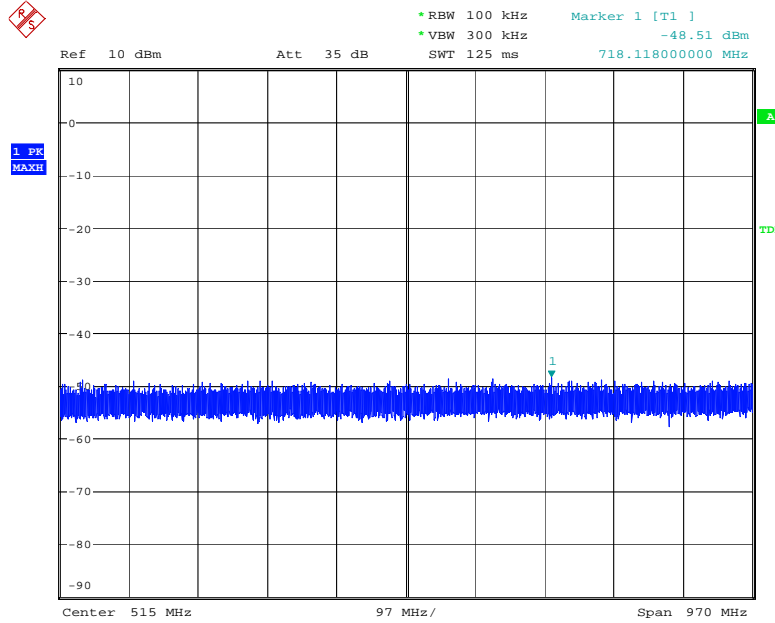

Date: 13.JAN.2015 15:45:12

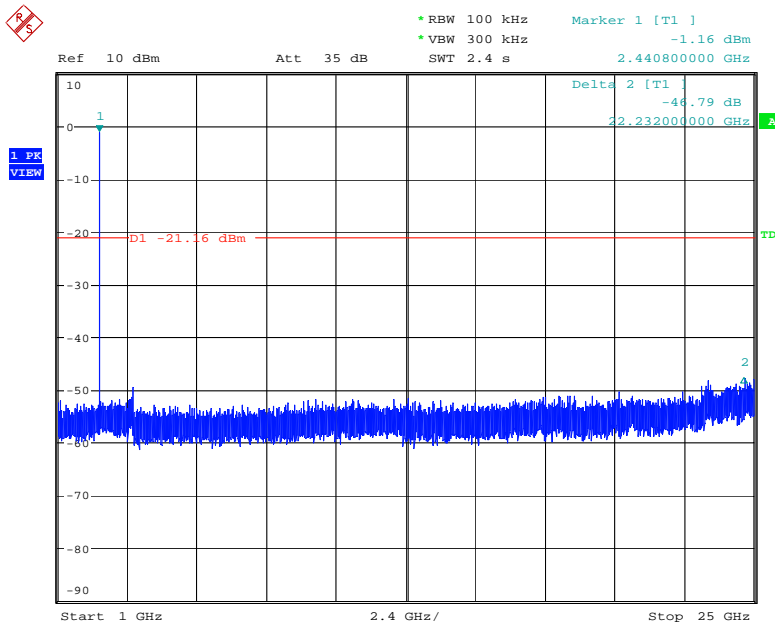

Date: 13.JAN.2015 13:16:13

Highest Channel

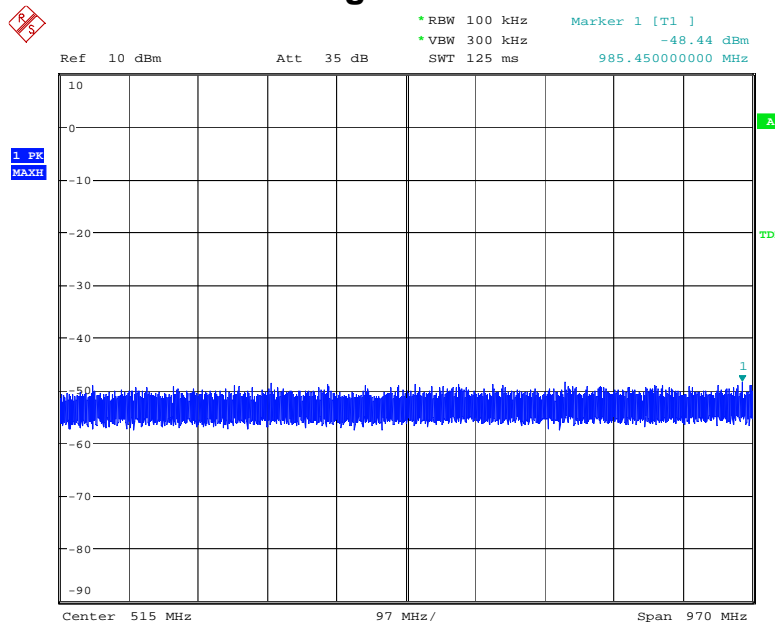

Date: 13.JAN.2015 15:45:30

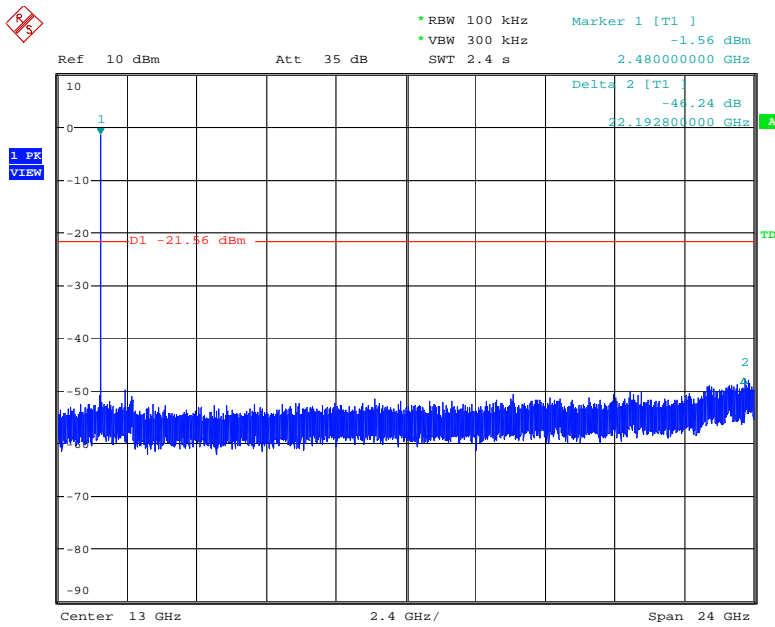

Date: 13.JAN.2015 13:16:44

13. Test Equipment List

Description	Manufacturer	Model Number	Serial Number	Characteristics	Calibration Date	Calibration Due Date
Test Receiver	Rohde & Schwarz	ESC17	100837	9KHz~7GHz	Nov. 24, 2014	Nov. 23, 2015
Antenna	Schwarzbeck	VULB9162	9162-010	30MHz~7GHz	Nov. 27, 2014	Nov. 26, 2015
Positioning Controller	UC	UC 3000	N/A	0~360° , 1-4m	N/A	N/A
Color Monitor	SUNSPO	SP-140A	N/A	N/A	N/A	N/A
Single Phase Power Line Filter	SAEMC	PF201A-32	110210	32A	N/A	N/A
3 Phase Power Line Filter	SAEMC	PF401A-200	110318	200A	N/A	N/A
DC Power Filter	SAEMC	PF301A-200	110245	200A	N/A	N/A
Cable	Huber+Suhner	CBL2-NN-1M	22390001	9KHz~7GHz	Nov. 08, 2014	Nov. 07, 2015
Cable	Huber+Suhner	CIL02	N/A	9KHz~7GHz	Nov. 08, 2014	Nov. 07, 2015
RF Cable	Huber+Suhner	SF-104	MY16559/4	9KHz~25GHz	Mar. 07, 2015	Mar. 06, 2016
Power Amplifier	HP	HP 8447D	1145A00203	100KHz~1.3GHz	Nov. 08, 2014	Nov. 07, 2015
Horn Antenna	Schwarzbeck	BBHA9170	9170-372	15GHz~26.5GHz	Oct.24, 2014	Oct.23, 2015
Horn Antenna	Com-Power	AH-118	071078	1GHz~18GHz	Nov. 06, 2014	Nov. 05, 2015
Loop antenna	Daze	ZA30900A	0708	9KHz~30MHz	Oct.11, 2014	Oct.10, 2015
Spectrum Analyzer	Rohde & Schwarz	FSU26	200409/026	20Hz~26.5GHz	Sep. 02, 2014	Sep. 01, 2015
Pre-Amplifier	Agilent	8449B	3008A02964	1GHz~26.5GHz	Nov. 04, 2014	Nov. 03, 2015
L.I.S.N.	Rohde & Schwarz	ENV 216	101317	9KHz~30MHz	Nov. 08, 2014	Nov. 07, 2015
Temporary antenna connector	TESCOM	SS402	N/A	1G-18GHz	N/A	N/A

---End---