

FCC PART 15 SUBPART C MEASUREMENT AND TEST REPORT

For

Shenzhen Fenda Technology Co., Ltd.

**Fenda Hi-Tech Park, Zhoushi Road, Shiyao Town, Baoan District, Shenzhen
City, Guangdong, China**

E.U.T.: BLUETOOTH SPEAKER

Model Name: W10, W11, W12, W13, W15, W16, W17, W19

Brand Name: F&D, OMAKER

FCC ID: HBOW12

Report Number: NTC1605113F

Test Date(s): May 18, 2016 to June 24, 2016

Report Date(s): June 24, 2016

Prepared by

Dongguan Nore Testing Center Co., Ltd.

**Building D, Gaosheng Science and Technology Park, Hongtu Road,
Nancheng District, Dongguan City, Guangdong, China**

Tel: +86-769-22022444

Fax: +86-769-22022799

Prepared By

Approved & Authorized Signer

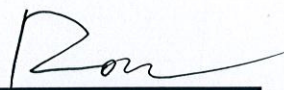

Rose Hu / Engineer



Sunm Lv / Q.A. Director

Note: This test report is for the customer shown above and their specific product only. It may not be duplicated or used in part without prior written consent from Dongguan Nore Testing Center Co., Ltd. The test results referenced from this report are relevant only to the sample tested.



Table of Contents

| | |
|--|-----------|
| 1. GENERAL INFORMATION | 5 |
| 1.1 PRODUCT DESCRIPTION FOR EQUIPMENT UNDER TEST | 5 |
| 1.2 RELATED SUBMITTAL(S) / GRANT (S)..... | 5 |
| 1.3 TEST METHODOLOGY | 7 |
| 1.4 EQUIPMENT MODIFICATIONS | 7 |
| 1.5 SUPPORT DEVICE | 7 |
| 1.6 TEST FACILITY AND LOCATION..... | 8 |
| 1.7 SUMMARY OF TEST RESULTS | 8 |
| 2. SYSTEM TEST CONFIGURATION..... | 10 |
| 2.1 EUT CONFIGURATION | 10 |
| 2.2 SPECIAL ACCESSORIES..... | 10 |
| 2.3 DESCRIPTION OF TEST MODES | 10 |
| 2.4 EUT EXERCISE | 10 |
| 3. CONDUCTED EMISSIONS TEST | 11 |
| 3.1 TEST SET-UP (BLOCK DIAGRAM OF CONFIGURATION)..... | 11 |
| 3.2 TEST CONDITION | 11 |
| 3.3 MEASUREMENT RESULTS..... | 11 |
| 4. RADIATED EMISSION TEST..... | 14 |
| 4.1 TEST SET-UP (BLOCK DIAGRAM OF CONFIGURATION)..... | 14 |
| 4.2 MEASUREMENT PROCEDURE | 15 |
| 4.3 LIMIT..... | 15 |
| 4.4 MEASUREMENT RESULTS | 16 |
| 5. CHANNEL SEPARATION TEST..... | 20 |
| 5.1 MEASUREMENT PROCEDURE | 20 |
| 5.2 TEST SET-UP (BLOCK DIAGRAM OF CONFIGURATION)..... | 20 |
| 5.3 MEASUREMENT RESULTS..... | 20 |
| 6. 20DB BANDWIDTH..... | 24 |
| 6.1 MEASUREMENT PROCEDURE | 24 |
| 6.2 TEST SET-UP (BLOCK DIAGRAM OF CONFIGURATION)..... | 24 |
| 6.3 MEASUREMENT RESULTS..... | 24 |
| 7. HOPPING CHANNEL NUMBER | 28 |
| 7.1 MEASUREMENT PROCEDURE | 28 |
| 7.2 TEST SET-UP (BLOCK DIAGRAM OF CONFIGURATION)..... | 28 |
| 7.3 MEASUREMENT RESULTS..... | 28 |



| | |
|--|-----------|
| 8. TIME OF OCCUPANCY (DWELL TIME) | 30 |
| 8.1 MEASUREMENT PROCEDURE | 30 |
| 8.2 MEASUREMENT RESULTS..... | 30 |
| 9. MAXIMUM PEAK OUTPUT POWER | 30 |
| 9.1 MEASUREMENT PROCEDURE | 34 |
| 9.2 MEASUREMENT RESULTS..... | 34 |
| 10. BAND EDGE | 34 |
| 10.1 MEASUREMENT PROCEDURE | 38 |
| 10.2 LIMIT..... | 38 |
| 10.3 MEASUREMENT RESULTS..... | 38 |
| 11. ANTENNA APPLICATION | 38 |
| 11.1 ANTENNA REQUIREMENT | 43 |
| 11.2 MEASUREMENT RESULTS..... | 43 |
| 12. CONDUCTED SPURIOUS EMISSIONS | 44 |
| 12.1 MEASUREMENT PROCEDURE | 44 |
| 12.2. MEASUREMENT RESULTS..... | 44 |
| 13. TEST EQUIPMENT LIST | 47 |

1. GENERAL INFORMATION

1.1 Product Description for Equipment under Test

This device is a BT speaker, it's powered by DC 5V come from USB Port or DC 3.7V li-ion Battery. For more details features, please refer to User's Manual.

| | |
|------------------------|--|
| Manufacturer & Factory | : Same as the applicant. |
| Power Supply | : DC 5V come from USB Port, DC 3.7V li-ion battery. |
| Adapter | : None |
| Test voltage | : AC 120V 60Hz (Adapter input), DC 3.7V Li-ion battery (Only the worst case was recorded in the report.) |
| Model name | : W10, W11, W12, W13, W15, W16, W17, W19 (All tests were carried on model W12.) |
| Model difference | : These models have the same circuitry, electrical mechanical, PCB layout and physical construction. Their differences in model name for trading purpose. |
| Hardware version | : 1.0 |
| Software version | : 1.0 |
| Serial number | : N/A |

For BT function

| Item | BT2.1+EDR |
|---|----------------------------------|
| Frequency | 2402-2480MHz |
| Modulation | GFSK, $\pi/4$ -DQPSK |
| Number of Channel | 79 |
| Channel space | 1MHz |
| Antenna Type | PCB antenna |
| Antenna Gain | 0 dBi (declared by manufacturer) |
| Note: The product has no modulation by 8DPSK, it is setting through software before the product delivery. | |



BT 2.1+EDR Channel List

| Channel | Frequency MHz | Channel | Frequency MHz | Channel | Frequency MHz | Channel | Frequency MHz |
|---------|---------------|---------|---------------|---------|---------------|---------|---------------|
| 1 | 2402 | 21 | 2422 | 41 | 2442 | 61 | 2462 |
| 2 | 2403 | 22 | 2423 | 42 | 2443 | 62 | 2463 |
| 3 | 2404 | 23 | 2424 | 43 | 2444 | 63 | 2464 |
| 4 | 2405 | 24 | 2425 | 44 | 2445 | 64 | 2465 |
| 5 | 2406 | 25 | 2426 | 45 | 2446 | 65 | 2466 |
| 6 | 2407 | 26 | 2427 | 46 | 2447 | 66 | 2467 |
| 7 | 2408 | 27 | 2428 | 47 | 2448 | 67 | 2468 |
| 8 | 2409 | 28 | 2429 | 48 | 2449 | 68 | 2469 |
| 9 | 2410 | 29 | 2430 | 49 | 2450 | 69 | 2470 |
| 10 | 2411 | 30 | 2431 | 50 | 2451 | 70 | 2471 |
| 11 | 2412 | 31 | 2432 | 51 | 2452 | 71 | 2472 |
| 12 | 2413 | 32 | 2433 | 52 | 2453 | 72 | 2473 |
| 13 | 2414 | 33 | 2434 | 53 | 2454 | 73 | 2474 |
| 14 | 2415 | 34 | 2435 | 54 | 2455 | 74 | 2475 |
| 15 | 2416 | 35 | 2436 | 55 | 2456 | 75 | 2476 |
| 16 | 2417 | 36 | 2437 | 56 | 2457 | 76 | 2477 |
| 17 | 2418 | 37 | 2438 | 57 | 2458 | 77 | 2478 |
| 18 | 2419 | 38 | 2439 | 58 | 2459 | 78 | 2479 |
| 19 | 2420 | 39 | 2440 | 59 | 2460 | 79 | 2480 |
| 20 | 2421 | 40 | 2441 | 60 | 2461 | | |

Note: According to section 15.31(m), regards to the operating frequency range over 10MHz, the Lowest, middle, and the Highest frequency of channel were selected to perform the test. The selected frequency and test software see below:

| Channel | Frequency MHz |
|---------|---------------|
| 1 | 2402 |
| 40 | 2441 |
| 79 | 2480 |

| | |
|------------------------|---------------|
| Test SW version | FCCAssist_1.4 |
|------------------------|---------------|

1.2 Related Submittal(s) / Grant (s)

This submittal(s) (test report) is intended for FCC ID: HBOW12 filing to comply with Section 15.247 of the FCC Part 15 (2016), Subpart C Rule.

1.3 Test Methodology

Both AC mains line-conducted and radiated emission measurements were performed according to the procedures in ANSI C63.10 (2013). Radiated emission measurement was performed in semi-anechoic chamber and conducted emission measurement was performed in shield room. For radiated emission measurement, preliminary scans were performed in the semi-anechoic chamber only to determine the worst case modes. All radiated tests were performed at an antenna to EUT distance of 3 meters.

1.4 Equipment Modifications

Not available for this EUT intended for grant.

1.5 Support Device

Adapter : Model: BSYC050200UW
Input: AC100-240V 50/60Hz 0.5A
Output: DC 5.0V 2000mA

1.6 Test Facility and Location

Listed by FCC, July 03, 2014
The Certificate Registration Number is 665078.
Listed by Industry Canada, June 18, 2014
The Certificate Registration Number is 9743A.

Dongguan NTC Co., Ltd.
(Full Name: Dongguan Nore Testing Center Co., Ltd.)

Building D, Gaosheng Science and Technology Park, Hongtu Road,
Nancheng District, Dongguan City, Guangdong, China
(Full Name: Building D, Gaosheng Science & Technology Park,
Zhouxi Longxi Road, Nancheng District, Dongguan, Guangdong, China.)

1.7 Summary of Test Results

| FCC Rules | Description Of Test | Result |
|------------------------------|--------------------------------|-----------|
| §15.247(a)(1) | Channel Separation test | Compliant |
| §15.247(a)(1) | 20dB Bandwidth | Compliant |
| §15.247(a)(1)(iii) | Hopping Channel Number | Compliant |
| §15.247(a)(1)(iii) | Time of Occupancy (Dwell Time) | Compliant |
| §15.247(b) | Max Peak output Power test | Compliant |
| §15.247(d) | Band edge test | Compliant |
| §15.207 (a) | AC Power Conducted Emission | Compliant |
| §15.247(d), §15.209, §15.205 | Radiated Emission | Compliant |
| §15.203 | Antenna Requirement | Compliant |
| §15.247(d) | Conducted Spurious Emission | Compliant |

Note: 1. The EUT has been tested as an independent unit. And Continual transmitting in maximum power (the fully-charged battery is used during the measurement)

2. The EUT powered by battery and operating multiple positions, so the EUT shall be performed three orthogonal planes. The worst plane is Z.

Example:

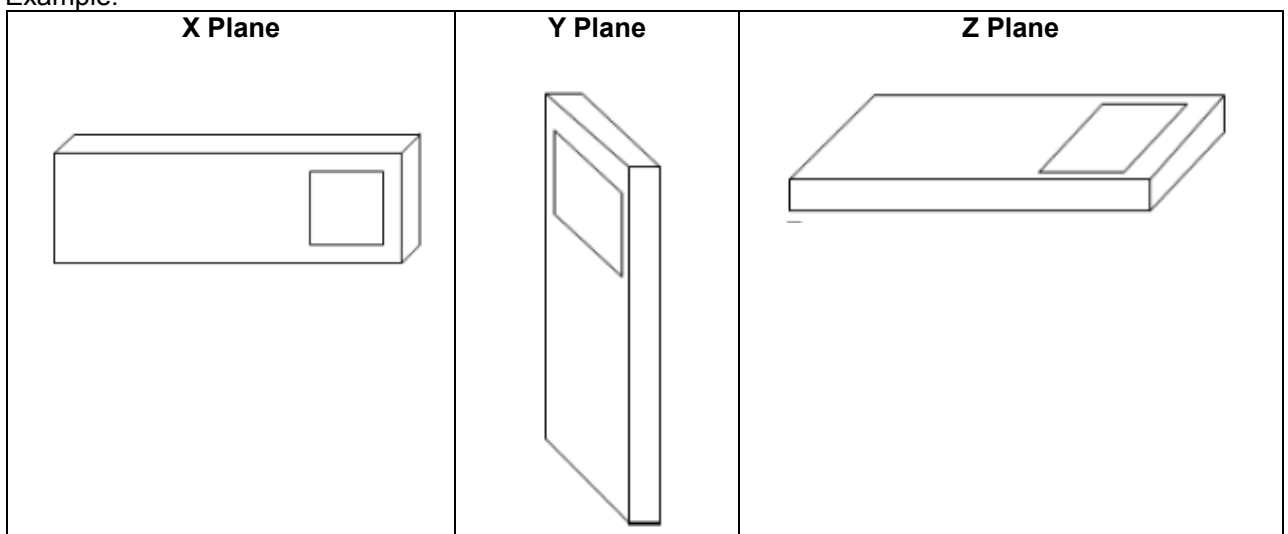

2. System Test Configuration

2.1 EUT Configuration

The EUT configuration for testing is installed on RF field strength measurement to meet the Commissions requirement and operating in a manner which intends to maximize its emission characteristics in a continuous normal application.

2.2 Special Accessories

Not available for this EUT intended for grant.

2.3 Description of test modes

The EUT has been tested under operating condition. Test program used to control the EUT for staying in continuous transmitting and normal mode is programmed. The Lowest, middle and highest channel were chosen for testing, and all packets DH1, DH3 and DH5 mode in all modulation type GFSK, $\pi/4$ -DQPSK were tested.

2.4 EUT Exercise

The EUT was operated in the engineering mode to fix the Tx frequency that was for the purpose of the measurements.

3. Conducted Emissions Test

3.1 Test SET-UP (Block Diagram of Configuration)

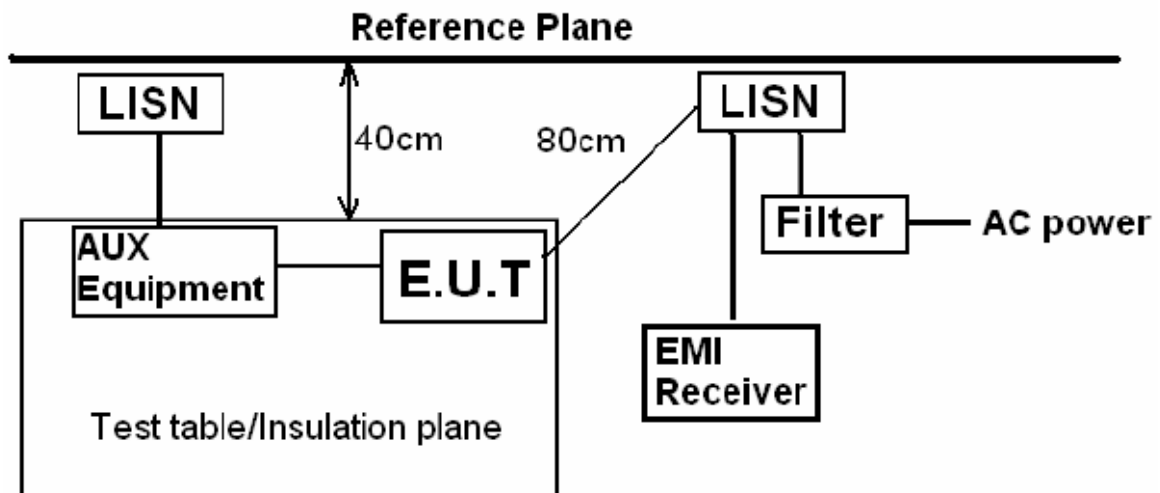

3.2 Test Condition

Test Requirement: FCC Part 15.207

Frequency Range: 150KHz ~ 30MHz

Detector: RBW 9KHz, VBW 30KHz

Operation Mode: Charging+BT Mode

3.3 Measurement Results

Please refer to following plots of the worst case: $\pi/4$ -DQPSK (Highest channel).

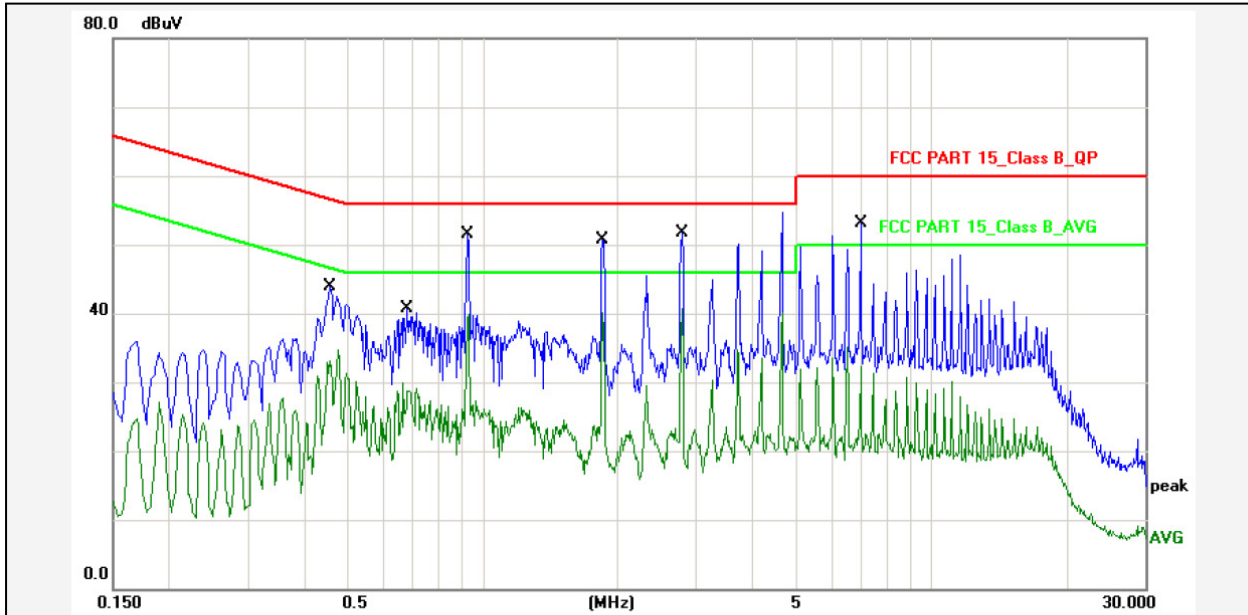

Report No.: W12
 Test Standard: FCC PART 15_Class B_QP
 Test item: Conducted Emission
 Applicant: FENDA
 Product: BULETOOTH SPEAKER
 Model No.: W12
 Phase: L1
 Temp.()/Hum.(%): 22(C) / 55 %
 Power Rating: AC120V 60Hz
 Test Engineer: chilaw
 Test Mode: Charging + BT Mode
 Remark:

| No. | Frequency (MHz) | Factor (dBuV) | Reading (dBuV) | Level (dBuV) | Limit (dBuV) | Margin (dB) | Detector | P/F | Remark |
|-----|-----------------|---------------|----------------|--------------|--------------|-------------|----------|-----|--------|
| 1 | 0.4580 | 10.80 | 30.10 | 40.90 | 56.73 | -15.83 | QP | P | |
| 2 | 0.4580 | 10.80 | 21.90 | 32.70 | 46.73 | -14.03 | AVG | P | |
| 3 | 0.6820 | 10.80 | 26.80 | 37.60 | 56.00 | -18.40 | QP | P | |
| 4 | 0.6820 | 10.80 | 17.00 | 27.80 | 46.00 | -18.20 | AVG | P | |
| 5 | 0.9260 | 10.80 | 37.70 | 48.50 | 56.00 | -7.50 | QP | P | |
| 6 | 0.9260 | 10.80 | 27.00 | 37.80 | 46.00 | -8.20 | AVG | P | |
| 7 | 1.8580 | 10.80 | 37.00 | 47.80 | 56.00 | -8.20 | QP | P | |
| 8 | 1.8580 | 10.80 | 27.40 | 38.20 | 46.00 | -7.80 | AVG | P | |
| 9 | 2.7860 | 10.80 | 37.90 | 48.70 | 56.00 | -7.30 | QP | P | |
| 10 | 2.7860 | 10.80 | 27.90 | 38.70 | 46.00 | -7.30 | AVG | P | |
| 11 | 6.9739 | 10.80 | 39.40 | 50.20 | 60.00 | -9.80 | QP | P | |
| 12 | 6.9739 | 10.80 | 19.40 | 30.20 | 50.00 | -19.80 | AVG | P | |

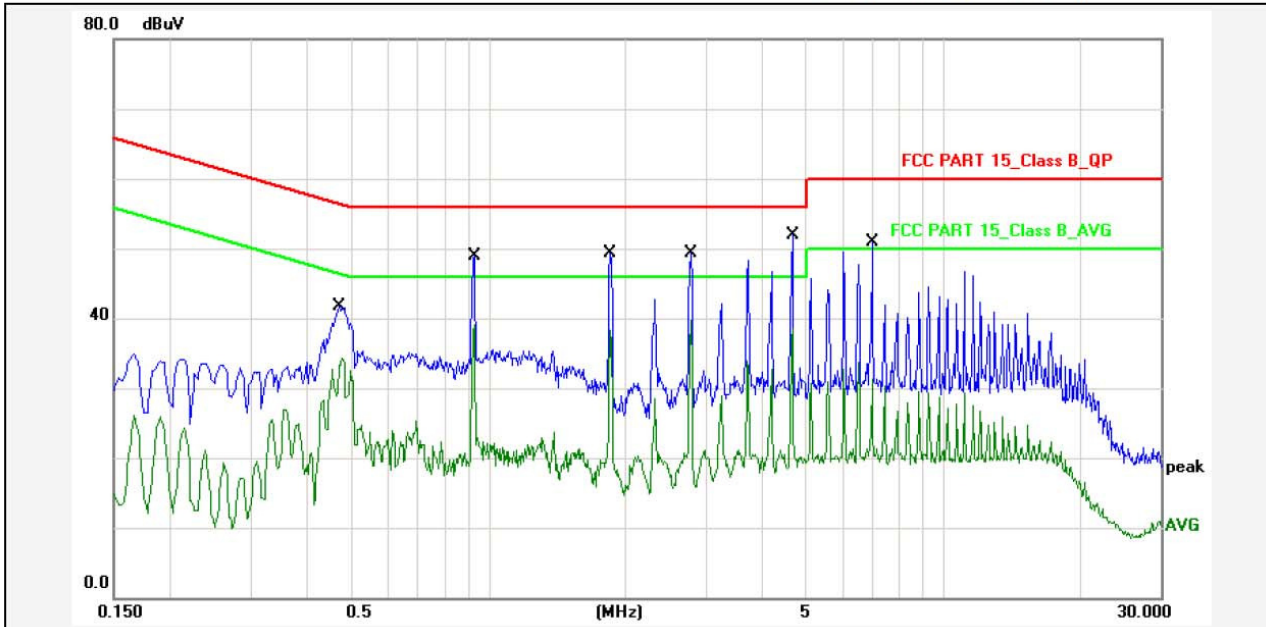

Report No.: W12
 Test Standard: FCC PART 15_Class B_QP
 Test item: Conducted Emission
 Applicant: FENDA
 Product: BULETOOTH SPEAKER
 Model No.: W12
 Phase: N
 Temp.()/Hum.(%): 22(C) / 55 %
 Power Rating: AC120V 60Hz
 Test Engineer: chilaw
 Test Mode: Charging + BT Mode
 Remark:

| No. | Frequency (MHz) | Factor (dBuV) | Reading (dBuV) | Level (dBuV) | Limit (dBuV) | Margin (dB) | Detector | P/F | Remark |
|-----|-----------------|---------------|----------------|--------------|--------------|-------------|----------|-----|--------|
| 1 | 0.4700 | 10.80 | 27.90 | 38.70 | 56.51 | -17.81 | QP | P | |
| 2 | 0.4700 | 10.80 | 21.40 | 32.20 | 46.51 | -14.31 | AVG | P | |
| 3 | 0.9300 | 10.80 | 35.10 | 45.90 | 56.00 | -10.10 | QP | P | |
| 4 | 0.9300 | 10.80 | 26.50 | 37.30 | 46.00 | -8.70 | AVG | P | |
| 5 | 1.8540 | 10.80 | 35.40 | 46.20 | 56.00 | -9.80 | QP | P | |
| 6 | 1.8540 | 10.80 | 25.50 | 36.30 | 46.00 | -9.70 | AVG | P | |
| 7 | 2.7900 | 10.80 | 35.60 | 46.40 | 56.00 | -9.60 | QP | P | |
| 8 | 2.7900 | 10.80 | 26.90 | 37.70 | 46.00 | -8.30 | AVG | P | |
| 9 | 4.6499 | 10.80 | 38.00 | 48.80 | 56.00 | -7.20 | QP | P | |
| 10 | 4.6499 | 10.80 | 25.70 | 36.50 | 46.00 | -9.50 | AVG | P | |
| 11 | 6.9778 | 10.80 | 36.70 | 47.50 | 60.00 | -12.50 | QP | P | |
| 12 | 6.9778 | 10.80 | 20.90 | 31.70 | 50.00 | -18.30 | AVG | P | |

4. Radiated Emission Test

4.1 Test SET-UP (Block Diagram of Configuration)

4.1.1 Radiated Emission Test Set-Up, Frequency Below 30MHz

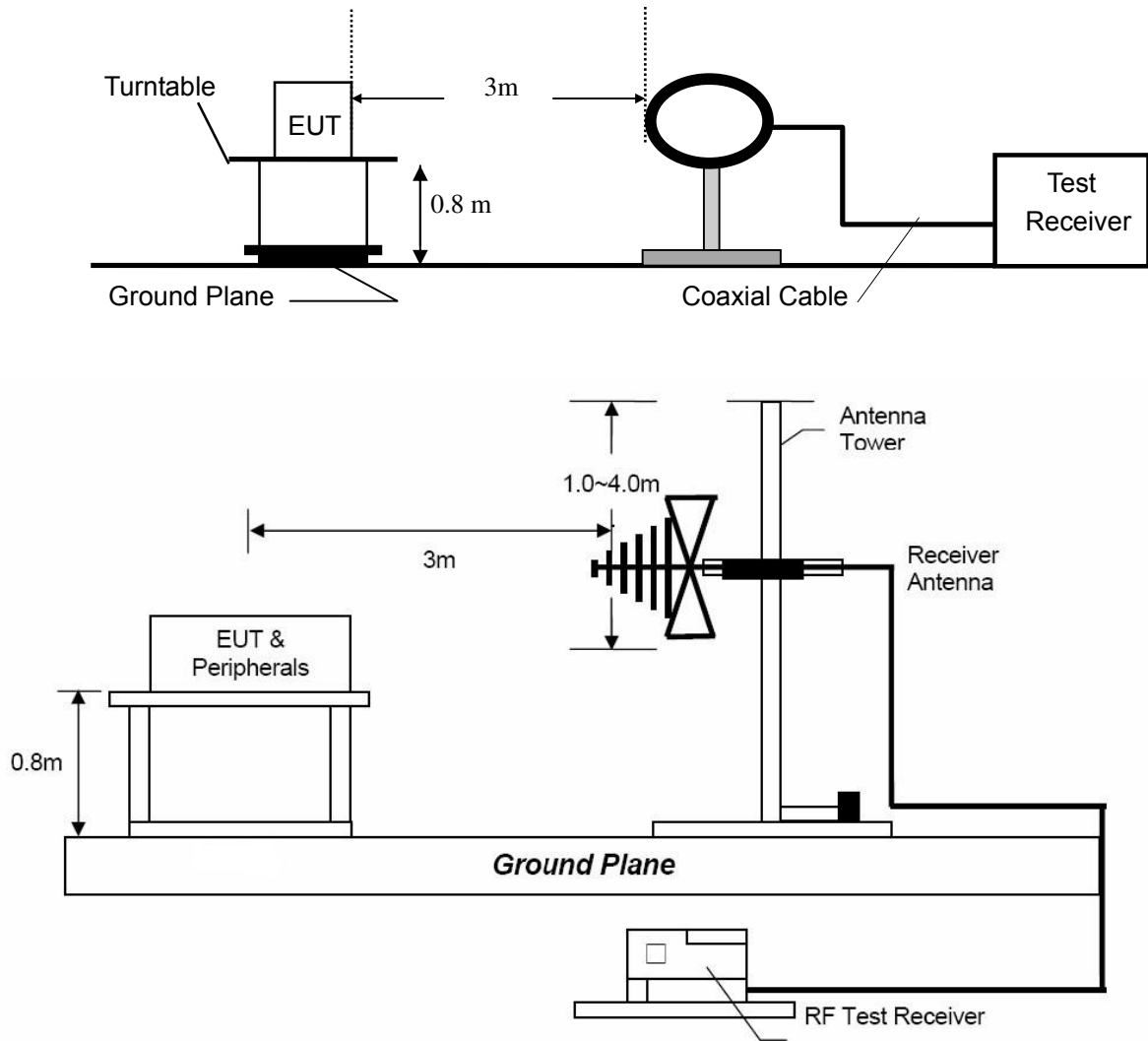

4.1.2 Radiated Emission Test Set-Up, Frequency above 1GHz

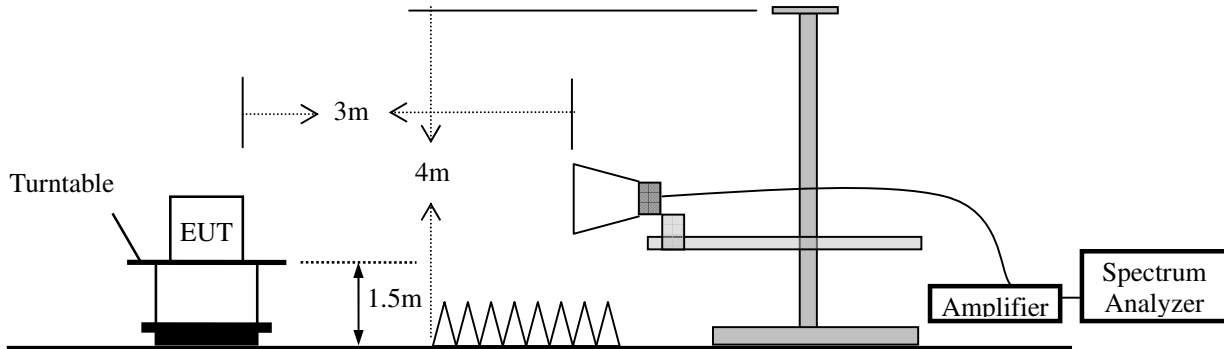

4.2 Measurement Procedure

- Blow 1GHz, the EUT was placed on the top of a rotating table 0.8 meters above the ground at a 3 meter semi- anechoic chamber room.
- For the radiated emission test above 1GHz:
The EUT was placed on the top of a rotating table 1.5 meters above the ground at a 3 meter full anechoic chamber room. The table was rotated 360 degrees to determine the position of the highest radiation. Place the measurement antenna away from each area of the EUT determined to be a source of emissions at the specified measurement distance, while keeping the measurement antenna aimed at the source of emissions at each frequency of significant emissions, with polarization oriented for maximum response. The measurement antenna may have to be higher or lower than the EUT, depending on the radiation pattern of the emission and staying aimed at the emission source for receiving the maximum signal. The final measurement antenna elevation shall be that which maximizes the emissions. The measurement antenna elevation for maximum emissions shall be restricted to a range of heights of from 1 m to 4 m above the ground or reference ground plane.
- The EUT was set 3 meters away from the interference-receiving antenna, which was mounted on the top of a variable-height antenna tower.
- The height of antenna is varied from one meter to four meters above the ground to determine the maximum value of the field strength. Both horizontal and vertical polarizations of the antenna are set to make the measurement.
- For each suspected emission, the EUT was arranged to its worst case and then the antenna was tuned to heights from 1 meter to 4 meters and the rotatable table was turned from 0 degrees to 360 degrees to find the maximum reading. The test-receiver system was set to peak detect function and specified bandwidth with maximum hold mode.
- A Quasi-peak measurement was then made for that frequency point for below 1GHz test. PK and AV for above 1GHz emission test.

During the radiated emission test, the spectrum analyzer was set with the following configurations:

| Frequency Band (MHz) | Level | Resolution Bandwidth | Video Bandwidth |
|----------------------|---------|----------------------|-----------------|
| 30 to 1000 | QP | 120 kHz | 300 kHz |
| Above 1000 | Peak | 1 MHz | 3 MHz |
| | Average | 1 MHz | 10 Hz |

4.3 Limit

| Frequency range MHz | Distance Meters | Field Strengths Limit (15.209) |
|---------------------|-----------------|--------------------------------|
| | | $\mu\text{V/m}$ |
| 0.009 ~ 0.490 | 300 | $2400/F(\text{kHz})$ |
| 0.490 ~ 1.705 | 30 | $24000/F(\text{kHz})$ |
| 1.705 ~ 30 | 30 | 30 |
| 30 ~ 88 | 3 | 100 |
| 88 ~ 216 | 3 | 150 |
| 216 ~ 960 | 3 | 200 |
| Above 960 | 3 | 500 |

- Remark :
- (1) Emission level (dB) μV = 20 log Emission level $\mu\text{V/m}$
 - (2) The smaller limit shall apply at the cross point between two frequency bands.
 - (3) As shown in 15.35(b), for frequencies above 1000MHz, the field strength limits are based on average detector, however, the peak field strength of any emission shall not exceed the maximum permitted average limits, specified above by more than 20dB under any condition of modulation.
 - (4) The frequency range scanned is from the lowest radio frequency signal generated in the device which is greater than 9 kHz to the tenth harmonic of the highest fundamental frequency or 40 GHz, whichever is lower.

4.4 Measurement Results

Please refer to following plots of the worst case: $\pi/4$ -DQPSK (Highest channel).

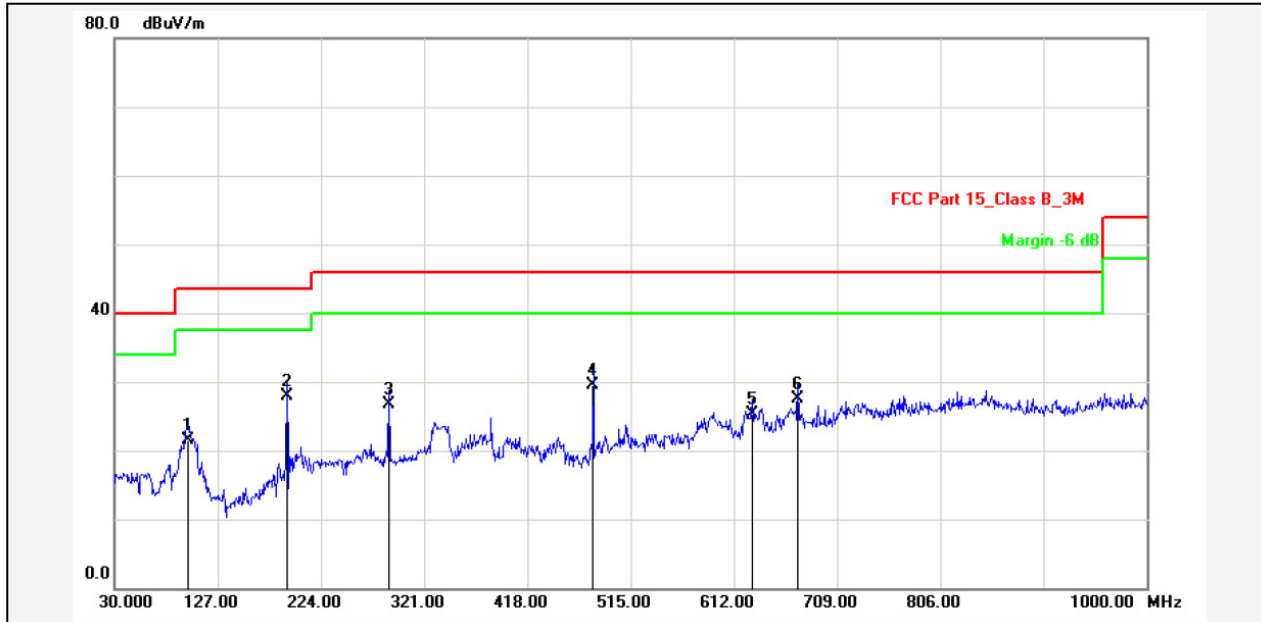

| | | | | | |
|-------------|--------------------|-------------------------------|------------------------|-------------------|--------------|
| Report No.: | W12 | Test Standard: | FCC Part 15_Class B_3M | Test Distance: | 3m |
| Test item: | Radiation Emission | Ant. Polarization: | Horizontal | Temp.(C)/Hum.(%): | 22(C) / 54 % |
| Applicant: | FENDA | Power Rating: | AC 120V 60Hz | Test Engineer: | Anson |
| Product: | BLUETOOTH SPEAKER | Test Mode: Charging + BT Mode | | | |
| Model No.: | W12 | Remark: | | | |

| No. | Frequency (MHz) | Factor (dB/m) | Reading (dBuV) | Level (dBuV/m) | Limit (dBuV/m) | Margin (dB) | Detector | Height (cm) | Azimuth (deg.) | P/F | Remark |
|-----|-----------------|---------------|----------------|----------------|----------------|-------------|----------|-------------|----------------|-----|--------|
| 1 | 98.8700 | -12.28 | 33.88 | 21.60 | 43.50 | -21.90 | QP | | | P | |
| 2 | 191.9900 | -13.51 | 41.51 | 28.00 | 43.50 | -15.50 | QP | | | P | |
| 3 | 288.0199 | -10.79 | 37.49 | 26.70 | 46.00 | -19.30 | QP | | | P | |
| 4 | 480.0799 | -7.21 | 36.81 | 29.60 | 46.00 | -16.40 | QP | | | P | |
| 5 | 629.4600 | -5.10 | 30.50 | 25.40 | 46.00 | -20.60 | QP | | | P | |
| 6 | 672.1399 | -4.57 | 32.17 | 27.60 | 46.00 | -18.40 | QP | | | P | |

Note: Below 30MHz, the emissions are lower than 20dB below the allowable limit.



Dongguan NTC Co., Ltd.
 Tel: +86-769-22022444 Fax: +86-769-22022799
 Web: [Http://www.ntc-c.com](http://www.ntc-c.com)

Site: Radiation

Test Time: 2016-5-19 13:32:10

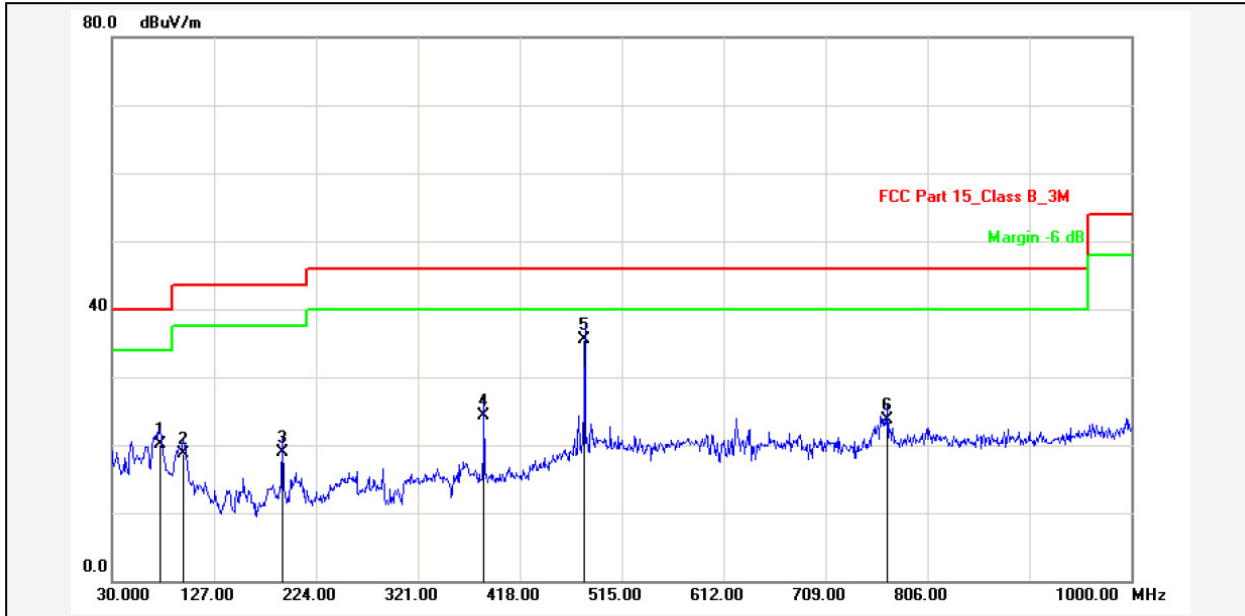

Report No.: W12
 Test Standard: FCC Part 15_Class B_3M
 Test item: Radiation Emission
 Applicant: FENDA
 Product: BLUETOOTH SPEAKER
 Model No.: W12

Test Distance: 3m
 Ant. Polarization: Vertical
 Temp.(C)/Hum.(%): 22(C) / 54 %
 Power Rating: AC120V 60Hz
 Test Engineer: Anson

Test Mode: Charging + BT Mode
 Remark:

| No. | Frequency (MHz) | Factor (dB/m) | Reading (dBuV) | Level (dBuV/m) | Limit (dBuV/m) | Margin (dB) | Detector | Height (cm) | Azimuth (deg.) | P/F | Remark |
|-----|-----------------|---------------|----------------|----------------|----------------|-------------|----------|-------------|----------------|-----|--------|
| 1 | 75.5899 | -19.03 | 39.23 | 20.20 | 40.00 | -19.80 | QP | | | P | |
| 2 | 97.9000 | -15.98 | 34.68 | 18.70 | 43.50 | -24.80 | QP | | | P | |
| 3 | 191.9900 | -16.51 | 35.51 | 19.00 | 43.50 | -24.50 | QP | | | P | |
| 4 | 384.0500 | -11.19 | 35.49 | 24.30 | 46.00 | -21.70 | QP | | | P | |
| 5 | 480.0799 | -9.21 | 44.81 | 35.60 | 46.00 | -10.40 | QP | | | P | |
| 6 | 768.1698 | -2.35 | 26.15 | 23.80 | 46.00 | -22.20 | QP | | | P | |

Note: Below 30MHz, the emissions are lower than 20dB below the allowable limit.



Modulation: $\pi/4$ -DQPSK (the worst case)
 Frequency Range: 1-25GHz Test Date : May 19, 2016
 Test Result: PASS Temperature : 22 °C
 Measured Distance: 3m Humidity : 54 %
 Test By: Sance

| Freq. (MHz) | Ant.Pol. (H/V) | Reading Level(dBuV) | | Factor (dB/m) | Emission Level (dBuV) | | Limit 3m (dBuV/m) | | Margin (dB) | |
|---------------------------------------|----------------|---------------------|-------|---------------|-----------------------|-------|-------------------|-------|-------------|-------|
| | | PK | AV | | PK | AV | PK | AV | PK | AV |
| Operation Mode: TX Mode (Low) | | | | | | | | | | |
| 4804 | V | 41.72 | 31.10 | 14.63 | 56.35 | 45.73 | 74.00 | 54.00 | -17.65 | -8.27 |
| 7206 | V | 38.84 | 27.93 | 20.68 | 59.52 | 48.61 | 74.00 | 54.00 | -14.48 | -5.39 |
| --- | | | | | | | | | | |
| 4804 | H | 41.79 | 29.58 | 14.63 | 56.42 | 44.21 | 74.00 | 54.00 | -17.58 | -9.79 |
| 7206 | H | 35.70 | 24.46 | 20.68 | 56.38 | 45.14 | 74.00 | 54.00 | -17.62 | -8.86 |
| --- | | | | | | | | | | |
| Operation Mode: TX Mode (Mid) | | | | | | | | | | |
| 4882 | V | 41.41 | 30.45 | 14.97 | 56.38 | 45.42 | 74.00 | 54.00 | -17.62 | -8.58 |
| 7323 | V | 37.50 | 25.45 | 20.91 | 58.41 | 46.36 | 74.00 | 54.00 | -15.59 | -7.64 |
| --- | | | | | | | | | | |
| 4882 | H | 41.42 | 29.45 | 14.97 | 56.39 | 44.42 | 74.00 | 54.00 | -17.61 | -9.58 |
| 7323 | H | 36.55 | 25.81 | 20.91 | 57.46 | 46.72 | 74.00 | 54.00 | -16.54 | -7.28 |
| --- | | | | | | | | | | |
| Operation Mode: TX Mode (High) | | | | | | | | | | |
| 4960 | V | 42.19 | 29.82 | 15.30 | 57.49 | 45.12 | 74.00 | 54.00 | -16.51 | -8.88 |
| 7440 | V | 36.20 | 25.06 | 21.16 | 57.36 | 46.22 | 74.00 | 54.00 | -16.64 | -7.78 |
| --- | | | | | | | | | | |
| 4960 | H | 43.16 | 31.09 | 15.30 | 58.46 | 46.39 | 74.00 | 54.00 | -15.54 | -7.61 |
| 7440 | H | 36.22 | 25.01 | 21.16 | 57.38 | 46.17 | 74.00 | 54.00 | -16.62 | -7.83 |
| --- | | | | | | | | | | |

- Note:**
- (1) All Readings are Peak Value and AV.
 - (2) Emission Level= Reading Level + Factor
 - (3) Factor= Antenna Gain + Cable Loss – Amplifier Gain
 - (4) Data of measurement within this frequency range shown “ --- ” in the table above means the reading of emissions are attenuated more than 10dB below the permissible limits.
 - (5) Measurement uncertainty : ± 3.7 dB.
 - (6) Horn antenna used for the emission over 1000MHz.

5. Channel Separation test

5.1 Measurement Procedure

Minimum Hopping Channel Carrier Frequency Separation, FCC Rule 15.247(a)(1):

Connect EUT antenna terminal to the spectrum analyzer with a low loss cable, and using the MARKER and Max-Hold function to record the separation of two adjacent channels.

5.2 Test SET-UP (Block Diagram of Configuration)

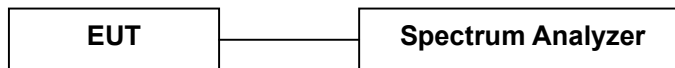

5.3 Measurement Results

| | | | |
|---------------|----------------------|--------------------|---------------|
| Modulation: | GFSK, $\pi/4$ -DQPSK | | |
| RBW: | 100KHz | VBW: | 300KHz |
| Packet: | DH5 | Spectrum Detector: | PK |
| Test By: | Sance | Test Date : | June 03, 2016 |
| Temperature : | 24 °C | Humidity : | 50 % |
| Test Result: | PASS | | |

| Channel number | Channel frequency (MHz) | Separation Read Value (KHz) | Separation Limit (KHz) |
|----------------|-------------------------|-----------------------------|------------------------|
| GFSK | | | |
| Lowest | 2402 | 1000 | >734.0 |
| Middle | 2441 | 1010 | >737.3 |
| Highest | 2480 | 1000 | >740.7 |
| $\pi/4$ -DQPSK | | | |
| Lowest | 2402 | 1000 | >920.0 |
| Middle | 2441 | 1000 | >916.7 |
| Highest | 2480 | 1000 | >916.7 |

GFSK Lowest Channel

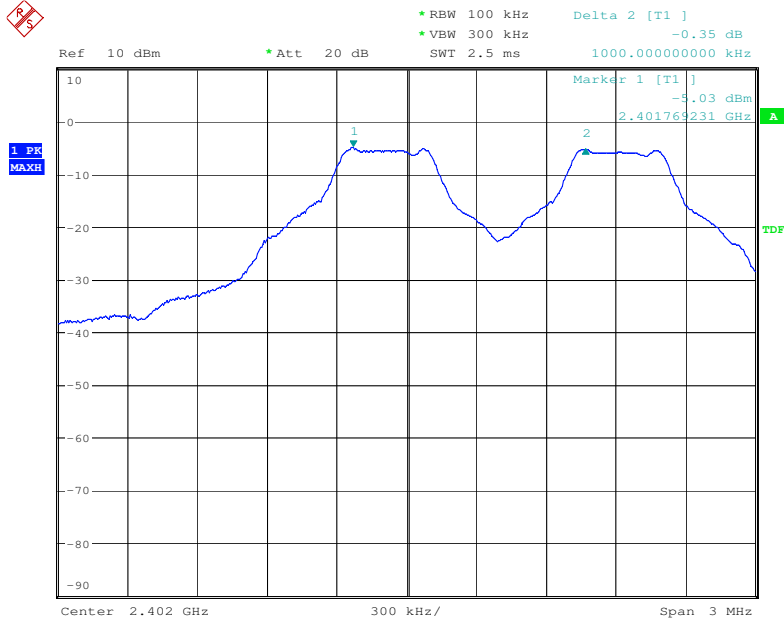

Date: 3.JUN.2016 13:43:35

GFSK Middle Channel

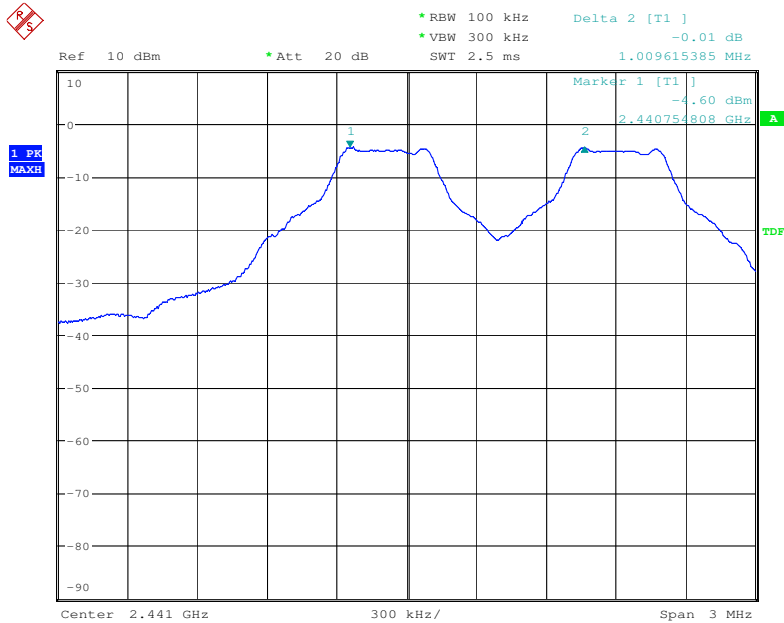

Date: 3.JUN.2016 13:45:56

GFSK Highest Channel

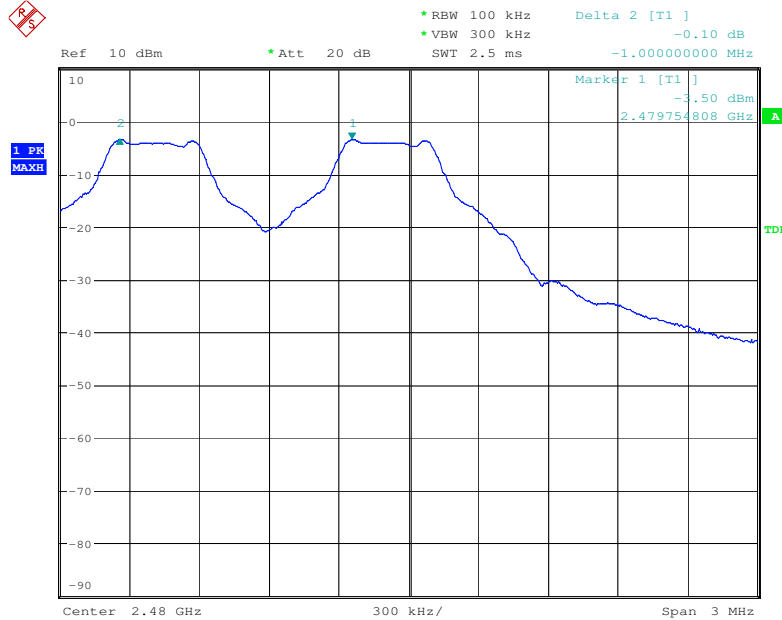

Date: 3.JUN.2016 13:49:28

$\pi/4$ -DQPSK Lowest Channel

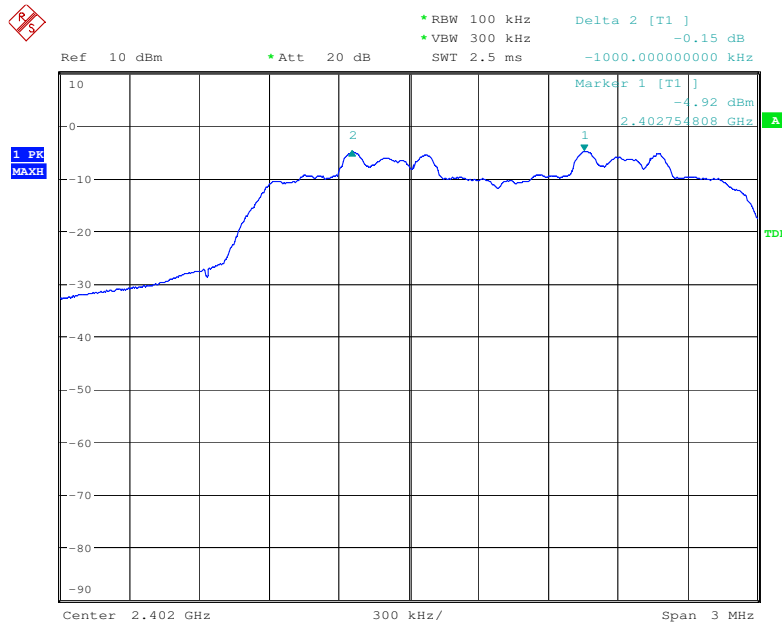

Date: 3.JUN.2016 13:54:12

$\pi/4$ -DQPSK Middle Channel

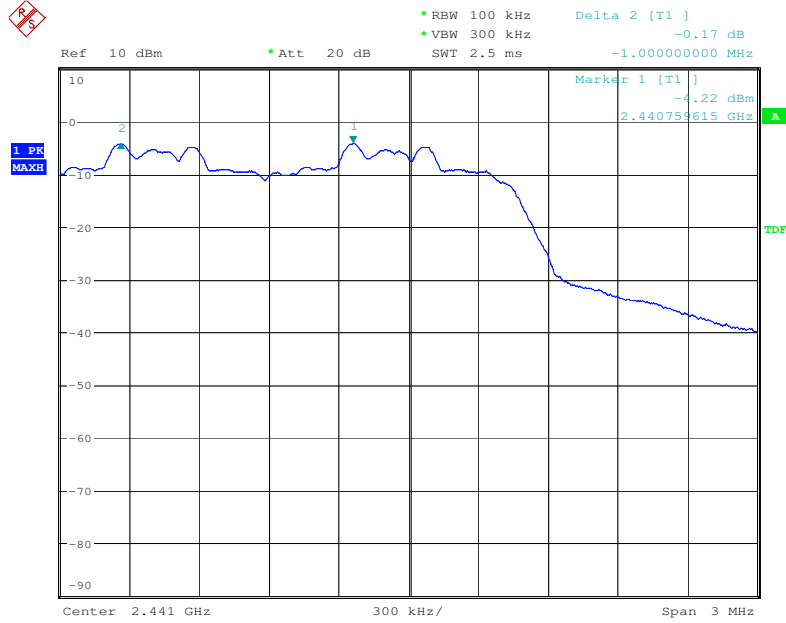

Date: 3.JUN.2016 13:59:15

$\pi/4$ -DQPSK Highest Channel

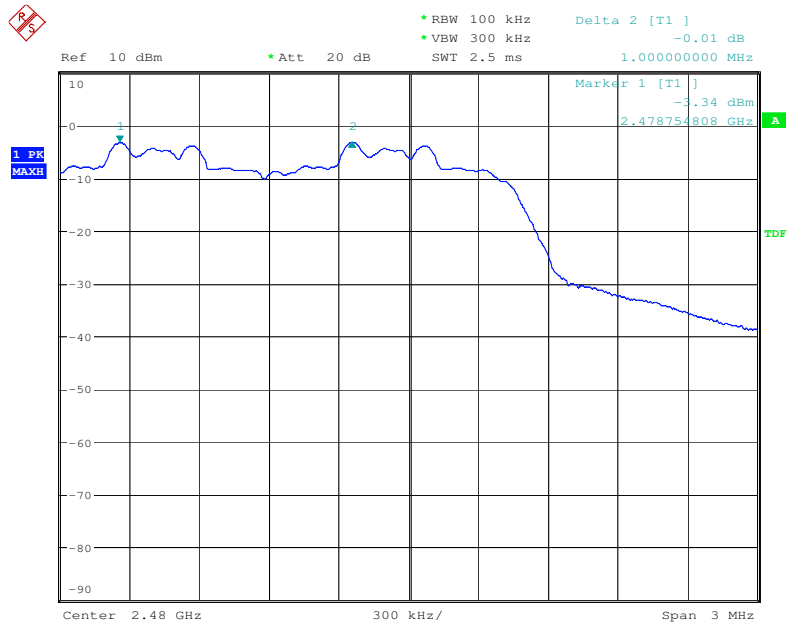

Date: 3.JUN.2016 14:02:46

6. 20dB Bandwidth

6.1 Measurement Procedure

Maximum 20dB RF Bandwidth, FCC Rule 15.247(a)(1):

The antenna port of the EUT was connected to the input of a spectrum analyzer. Analyzer RBW was chosen so that the display was a result of the hopping channel modulation. For each RF output channel investigated, the spectrum analyzer center frequency was set to the channel carrier. Use the spectrum 20dB down delta function to measure the bandwidth.

6.2 Test SET-UP (Block Diagram of Configuration)

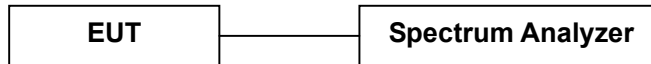

6.3 Measurement Results

Refer to attached data chart.

| | | | |
|---------------|----------------------|--------------------|---------------|
| Modulation: | GFSK, $\pi/4$ -DQPSK | | |
| RBW: | 100KHz | VBW: | 300KHz |
| Packet: | DH5 | Spectrum Detector: | PK |
| Test By: | Sance | Test Date : | June 03, 2016 |
| Temperature : | 24 °C | Humidity : | 50 % |
| Test Result: | PASS | | |

| Channel frequency (MHz) | 20dB Down BW(kHz) |
|-------------------------|-------------------|
| GFSK | |
| 2402 | 1101 |
| 2441 | 1106 |
| 2480 | 1111 |
| $\pi/4$ -DQPSK | |
| 2402 | 1380 |
| 2441 | 1375 |
| 2480 | 1375 |

GFSK Lowest Channel

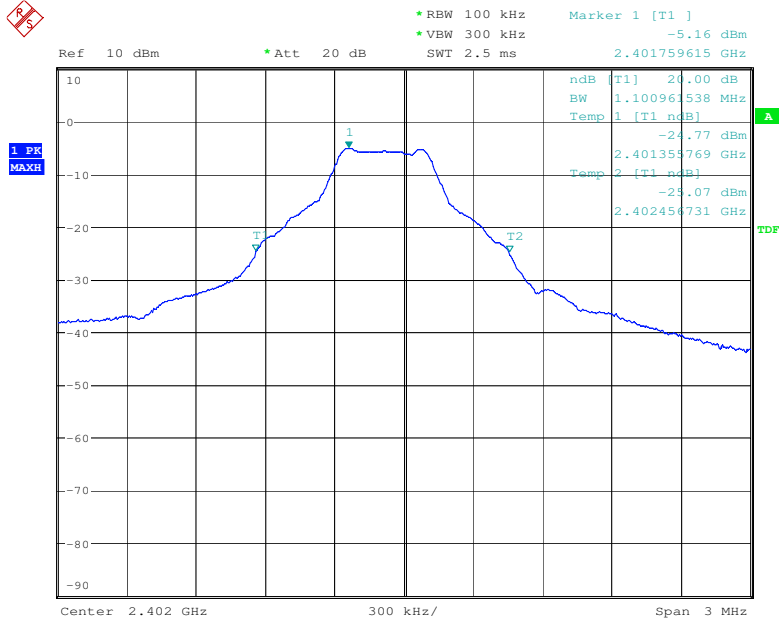

Date: 3.JUN.2016 11:39:07

GFSK Middle Channel

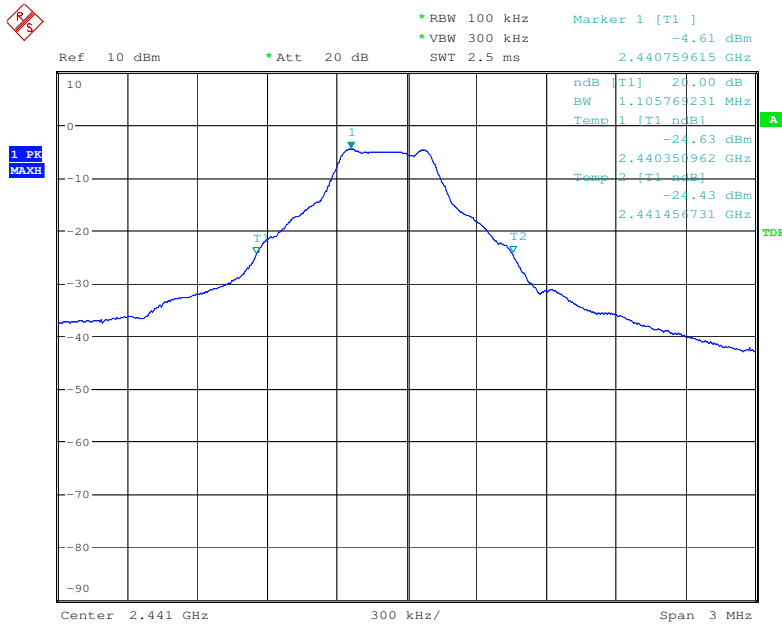

Date: 3.JUN.2016 11:42:00

GFSK Highest Channel

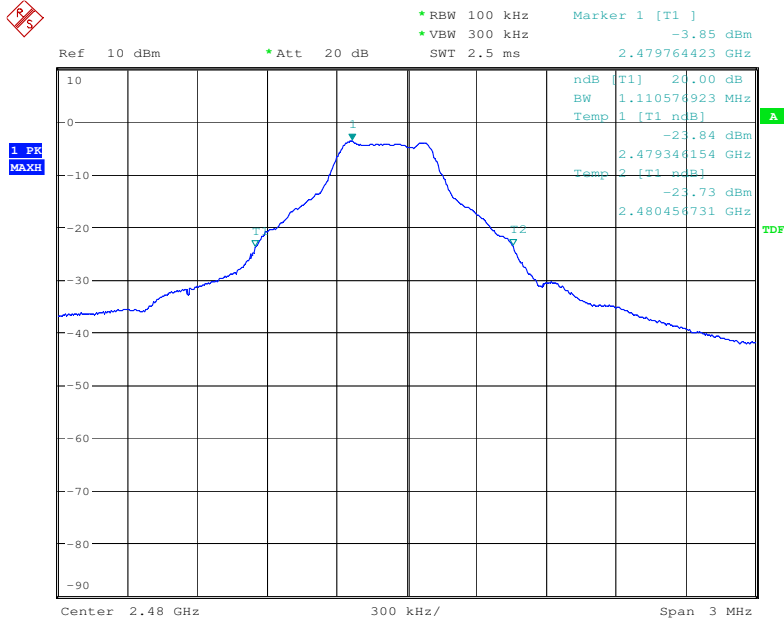

Date: 3.JUN.2016 11:43:55

$\pi/4$ -DQPSK Lowest Channel

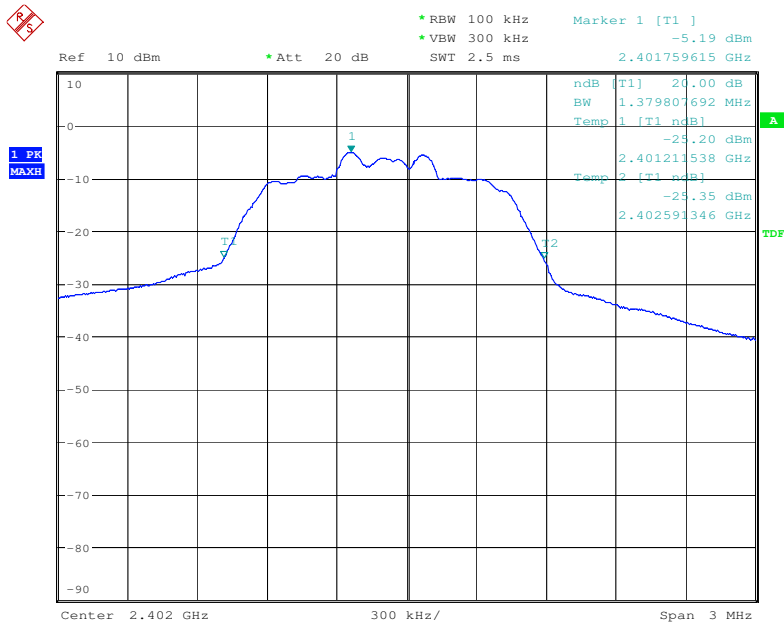

Date: 3.JUN.2016 11:47:12

$\pi/4$ -DQPSK Middle Channel

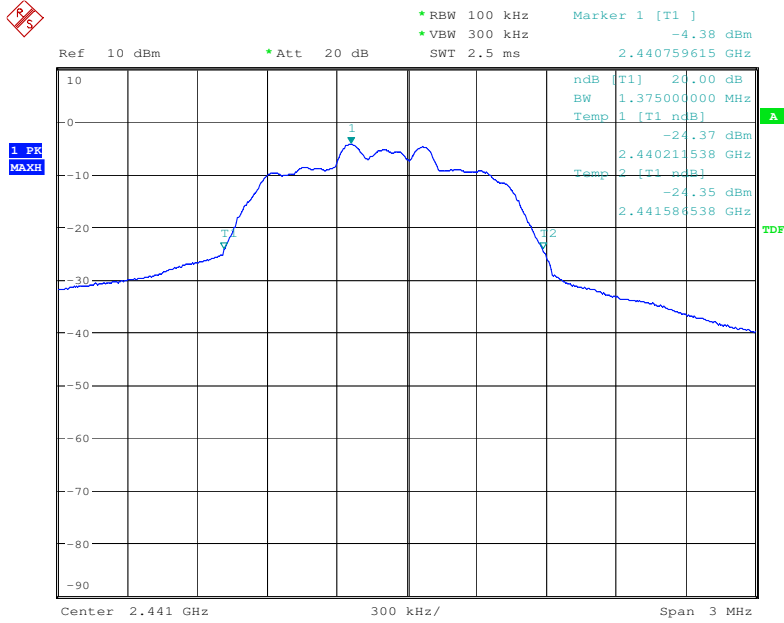

Date: 3.JUN.2016 13:35:40

$\pi/4$ -DQPSK Highest Channel

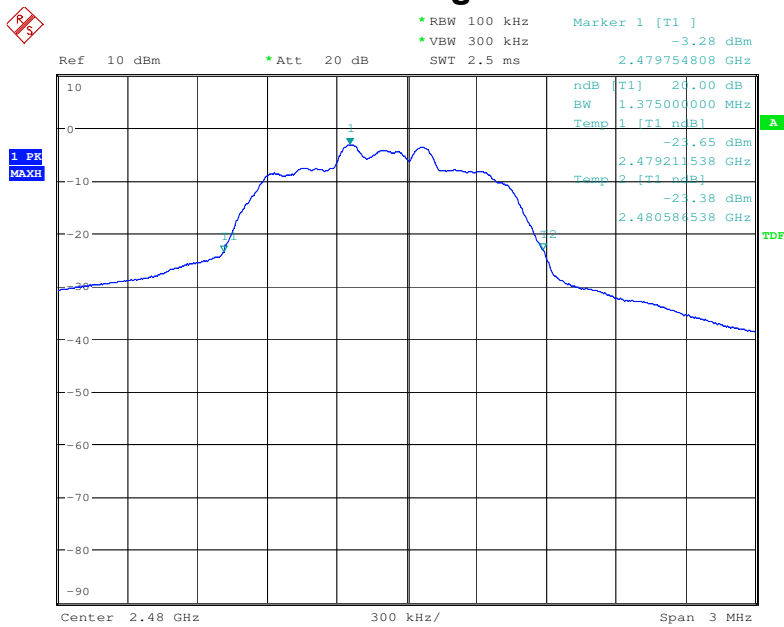

Date: 3.JUN.2016 13:38:54

7. Hopping Channel Number

7.1 Measurement Procedure

Minimum Number of Hopping Frequencies, FCC Rule 15.247(a)(1)(iii):

Remove the antenna from the EUT and then connect a low RF cable from the antenna port to the spectrum, and the spectrum analyzer set to MAX HOLD readings were taken for 3-5 minutes. The channel peaks so recorded were added together, and the total number compared to the minimum number of channels required in the regulation.

7.2 Test SET-UP (Block Diagram of Configuration)



7.3 Measurement Results

| | | | |
|---------------|----------------------|--------------------|---------------|
| Modulation | GFSK, $\pi/4$ -DQPSK | | |
| RBW: | 100KHz | VBW: | 300KHz |
| Packet: | DH5 | Spectrum Detector: | PK |
| Test By: | Sance | Test Date : | June 03, 2016 |
| Temperature : | 24 °C | Humidity : | 50 % |
| Test Result: | PASS | | |

| Hopping Channel Frequency Range | Number of Hopping Channels | Limit |
|---------------------------------|----------------------------|-----------|
| 2402-2480 | 79 | ≥ 15 |

The worst case: $\pi/4$ -DQPSK

$\pi/4$ -DQPSK

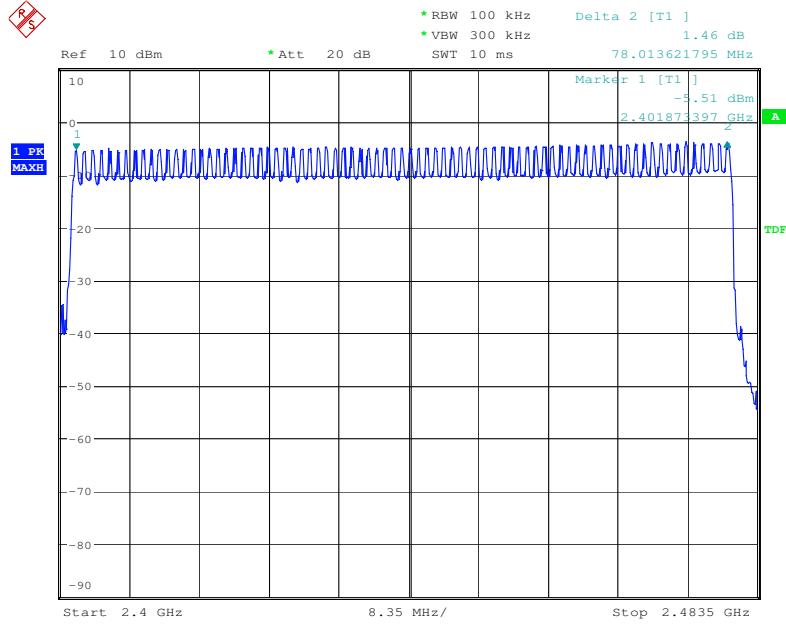

Date: 3.JUN.2016 15:19:34

8. Time of Occupancy (Dwell Time)

8.1 Measurement Procedure

Average Channel Occupancy Time, FCC Ref:15.247(a)(1)(iii):

Connect EUT antenna terminal to the spectrum analyzer with a low loss cable. The spectrum analyzer center frequency was set to one of the known hopping channels. The Sweep was set to 10 ms, the SPAN was set to Zero SPAN. The time duration of the transmissions so captured was measured with the Marker Delta function

8.2 Measurement Results

The maximum number of hopping channels in 31.6s (0.4s/Channel x 79 Channel)

Refer to attached data chart.

| | | | |
|--------------------|----------------------|---------------|-------|
| Modulation : | GFSK, $\pi/4$ -DQPSK | VBW : | 3MHz |
| RBW : | 1MHz | Test By: | Sance |
| Spectrum Detector: | PK | Temperature : | 24°C |
| Test Date : | June 03, 2016 | Humidity : | 50 % |
| Test Result: | PASS | | |

| Packet | Frequency (MHz) | Result (msec) | | Limit (msec) |
|----------------|-----------------|---------------|---|--------------|
| GFSK | | | | |
| DH1 | 2441 | 0.369 | $(ms) * (1600 / (2 * 79)) * 31.6 = 118.1$ | 400 |
| DH3 | 2441 | 1.627 | $(ms) * (1600 / (4 * 79)) * 31.6 = 260.3$ | 400 |
| DH5 | 2441 | 2.873 | $(ms) * (1600 / (6 * 79)) * 31.6 = 306.5$ | 400 |
| $\pi/4$ -DQPSK | | | | |
| 2-DH1 | 2441 | 0.381 | $(ms) * (1600 / (2 * 79)) * 31.6 = 121.9$ | 400 |
| 2-DH3 | 2441 | 1.627 | $(ms) * (1600 / (4 * 79)) * 31.6 = 260.3$ | 400 |
| 2-DH5 | 2441 | 2.885 | $(ms) * (1600 / (6 * 79)) * 31.6 = 307.7$ | 400 |

GFSK DH1

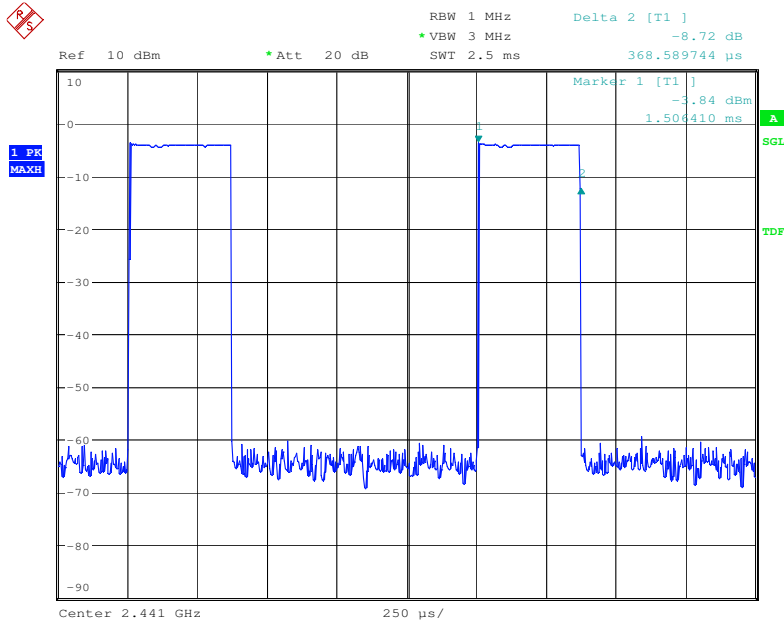

Date: 3.JUN.2016 14:15:14

GFSK DH3

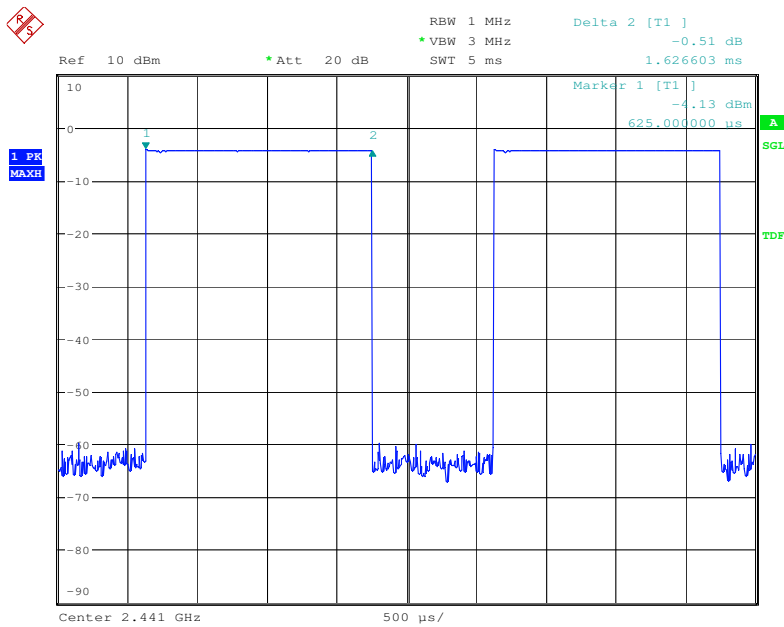

Date: 3.JUN.2016 14:17:21

GFSK DH5

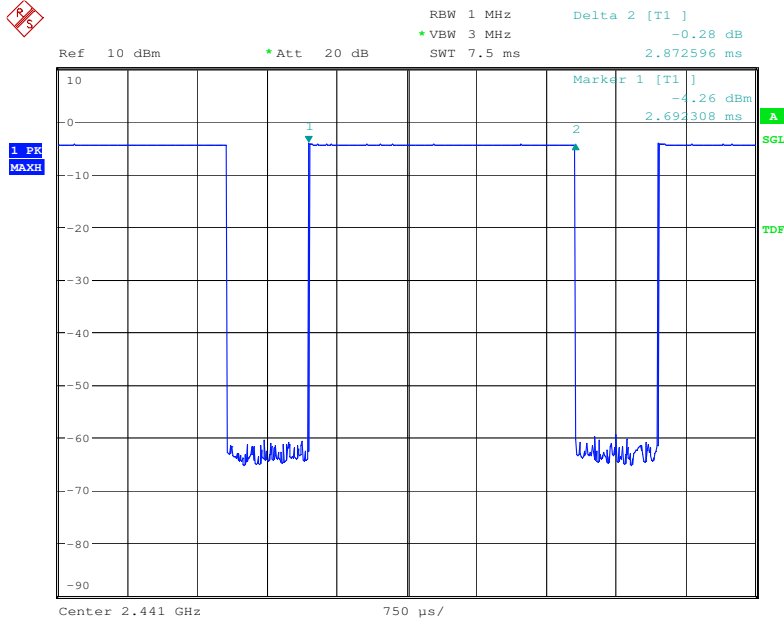

Date: 3.JUN.2016 14:18:24

$\pi/4$ -DQPSK 2-DH1

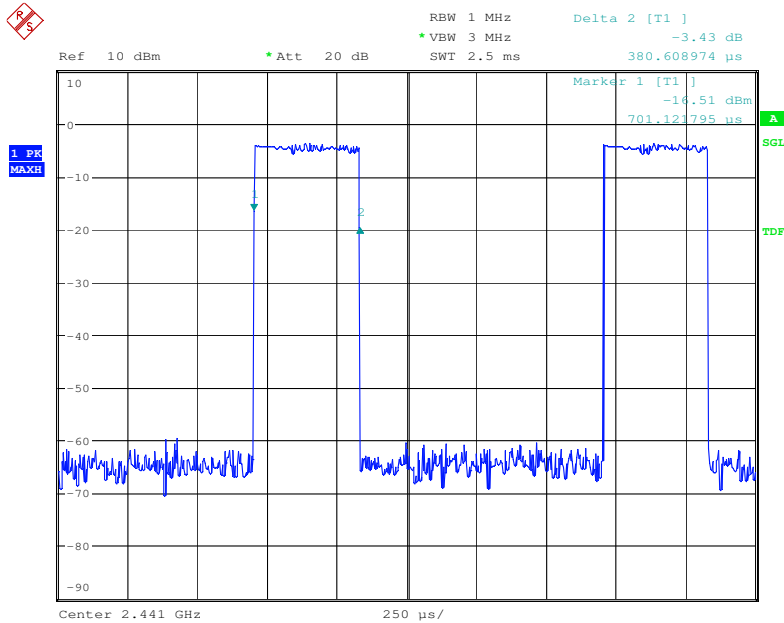

Date: 3.JUN.2016 14:19:26

$\pi/4$ -DQPSK 2-DH3

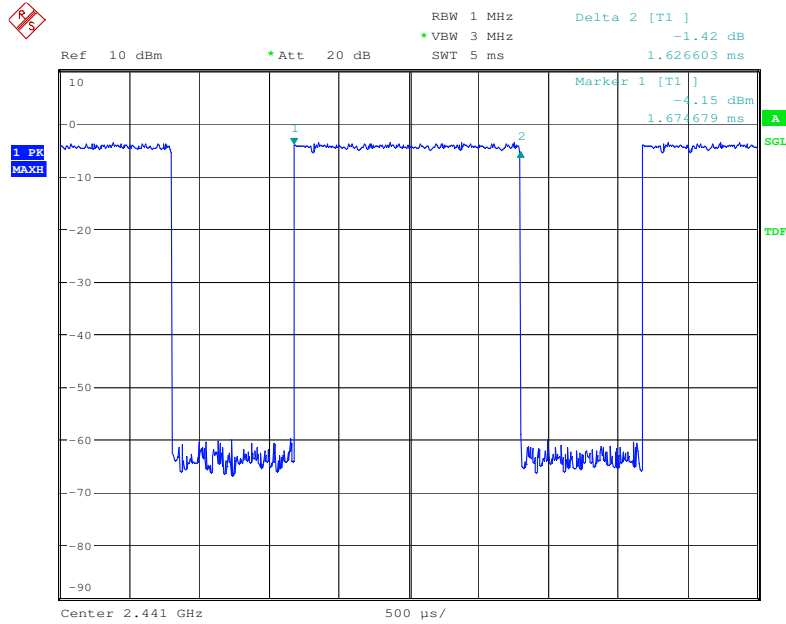

Date: 3.JUN.2016 14:20:18

$\pi/4$ -DQPSK 2-DH5

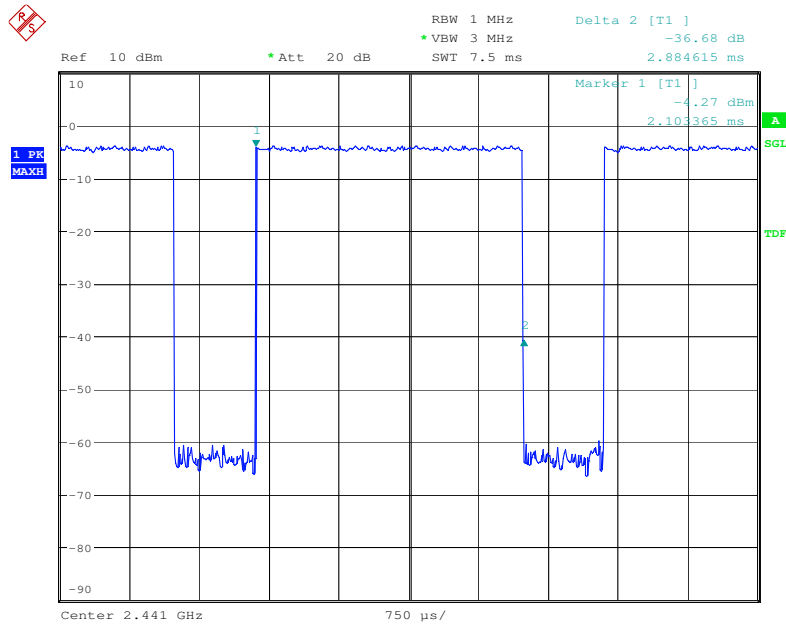

Date: 3.JUN.2016 14:21:32

9. MAXIMUM PEAK OUTPUT POWER

9.1 Measurement Procedure

Maximum Conducted Output Power at Antenna Terminals, FCC Rules 15.247(b)(1):

Remove the antenna from the EUT and then connect a low RF cable from the antenna port to the spectrum. The analyzer was set for RBW > 20dB bandwidth and power was read directly in dBm. Cable loss was considered during this measurement.

9.2 Measurement Results

Refer to attached data chart.

| | | | |
|--------------------|----------------------|---------------|---------------|
| Modulation : | GFSK, $\pi/4$ -DQPSK | | |
| RBW : | 3MHz | VBW : | 3MHz |
| Spectrum Detector: | PK | Test Date : | June 03, 2016 |
| Test By: | Sance | Temperature : | 24 °C |
| Test Result: | PASS | Humidity : | 50 % |

| Channel Frequency (MHz) | Cable Loss dB | Peak Power output(dBm) | Peak Power output(mW) | Peak Power Limit(dBm) | Pass/Fail |
|-------------------------|---------------|------------------------|-----------------------|-----------------------|-----------|
| GFSK | | | | | |
| 2402.00 | 1.5 | -4.64 | 0.34 | 21 | PASS |
| 2441.00 | 1.5 | -4.32 | 0.37 | 21 | PASS |
| 2480.00 | 1.5 | -3.32 | 0.47 | 21 | PASS |
| $\pi/4$ -DQPSK | | | | | |
| 2402.00 | 1.5 | -4.11 | 0.39 | 21 | PASS |
| 2441.00 | 1.5 | -3.67 | 0.43 | 21 | PASS |
| 2480.00 | 1.5 | -2.40 | 0.58 | 21 | PASS |

GFSK Lowest Channel

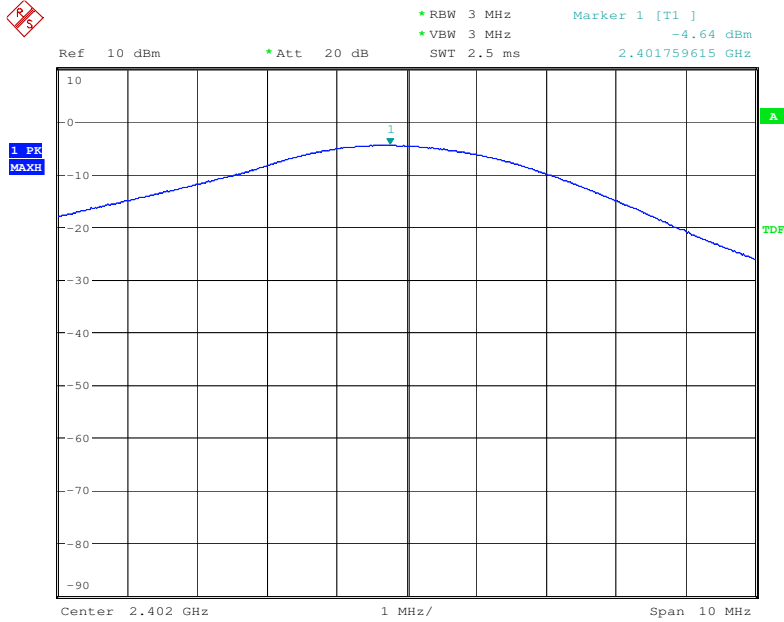

Date: 3.JUN.2016 10:59:49

GFSK Middle Channel

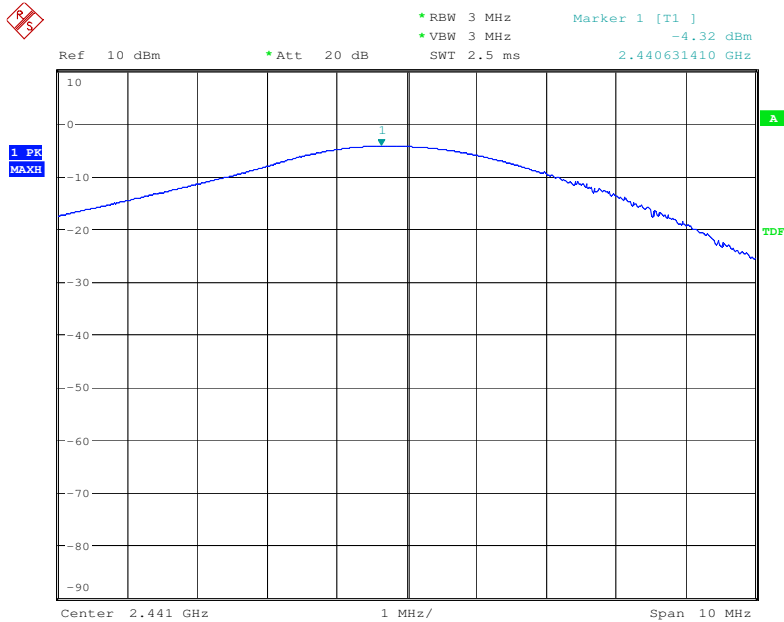

Date: 3.JUN.2016 11:06:24

GFSK Highest Channel

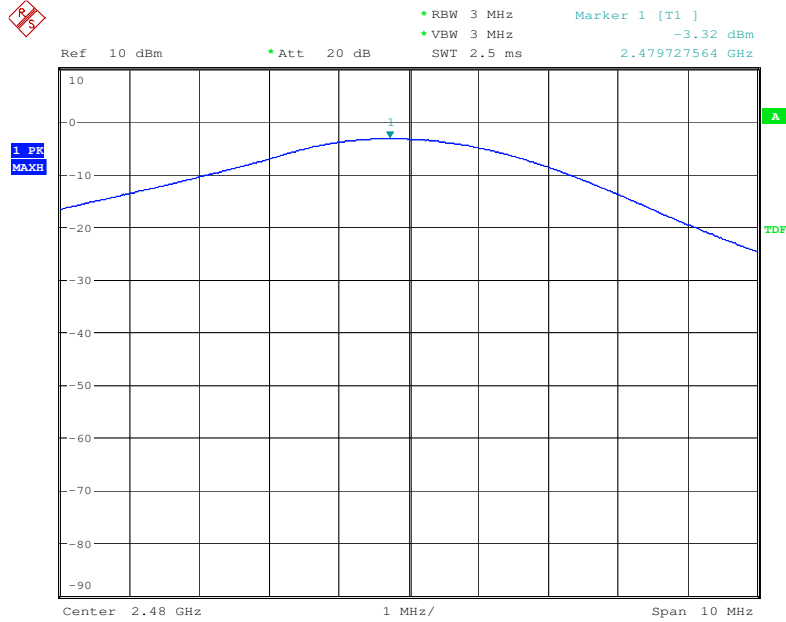

Date: 3.JUN.2016 11:09:35

$\pi/4$ -DQPSK Lowest Channel

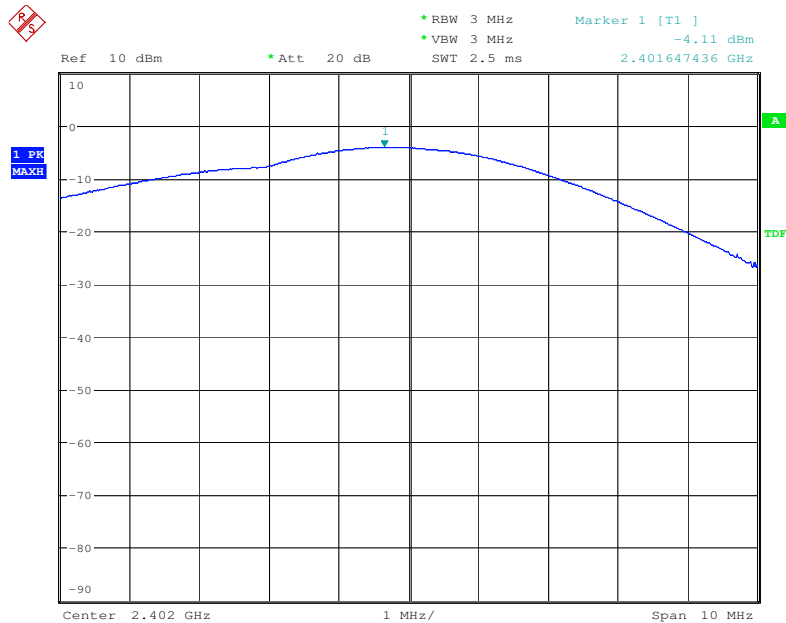

Date: 3.JUN.2016 11:18:57

$\pi/4$ -DQPSK Middle Channel

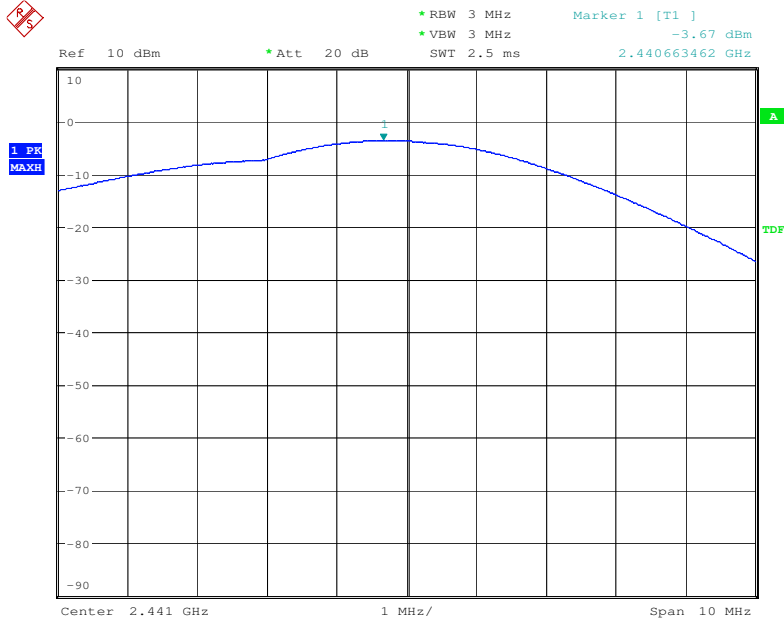

Date: 3.JUN.2016 11:22:13

$\pi/4$ -DQPSK Highest Channel

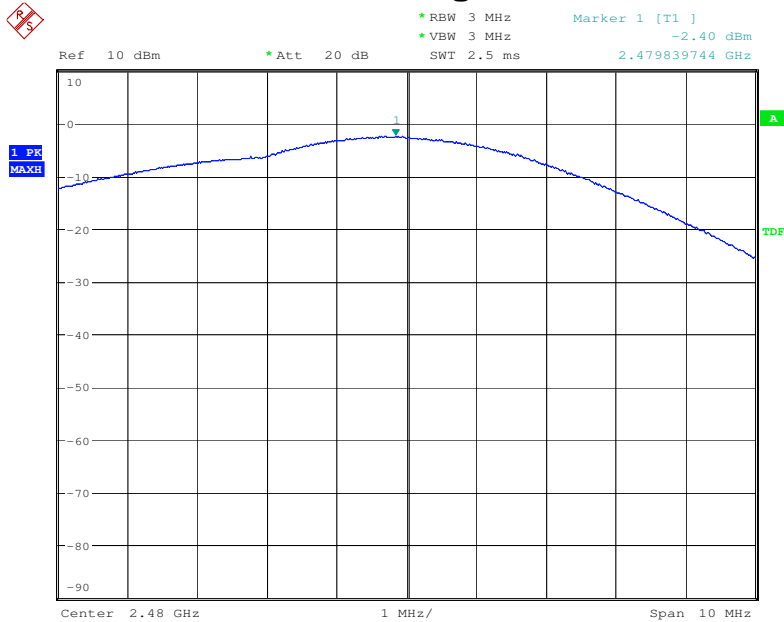

Date: 3.JUN.2016 11:25:33



10. Band Edge

10.1 Measurement Procedure

Out of Band Conducted Emissions, FCC Rule 15.247(d):

The transmitter output is connected to spectrum analyzer. The resolution bandwidth is set to 100KHz, and the video bandwidth set to 300KHz.

10.2 Limit

15.247(d) In any 100KHz bandwidth outside the frequency band in which the spread spectrum or digitally modulated intentional radiator is operating, the radio frequency power that is produced by the intentional radiator shall be at least 20dB below that in the 100KHz bandwidth within the band that contains the highest level of the desired power, based on either an RF conducted or a radiated measurement.

10.3 Measurement Results

Please see below test table and plots.
 For Radiated Emission
 The worst case: $\pi/4$ -DQPSK

Hopping-on mode

| Freq. (MHz) | Ant. Pol. (H/V) | Reading Level (dBuV) | | Factor (dB/m) | Emission Level (dBuV) | | Limit 3m (dBuV/m) | | Margin (dB) | |
|-------------|-----------------|----------------------|-------|---------------|-----------------------|-------|-------------------|-------|-------------|--------|
| | | PK | AV | | PK | AV | PK | AV | PK | AV |
| 2390.000 | H | 39.57 | 28.65 | 8.06 | 47.63 | 36.71 | 74.00 | 54.00 | -26.37 | -17.29 |
| 2390.000 | V | 40.23 | 28.29 | 8.06 | 48.29 | 36.35 | 74.00 | 54.00 | -25.71 | -17.65 |
| 2483.500 | H | 46.82 | 37.06 | 8.36 | 55.18 | 45.42 | 74.00 | 54.00 | -18.82 | -8.58 |
| 2483.500 | V | 44.16 | 35.15 | 8.36 | 52.52 | 43.51 | 74.00 | 54.00 | -21.48 | -10.49 |

- Note:**
- (1) Emission Level = Reading Level + Factor
 - (2) Factor = Antenna Gain + Cable Loss – Amplifier Gain
 - (3) Horn antenna used for the emission over 1000MHz.

For RF Conducted

GFSK Lowest Channel

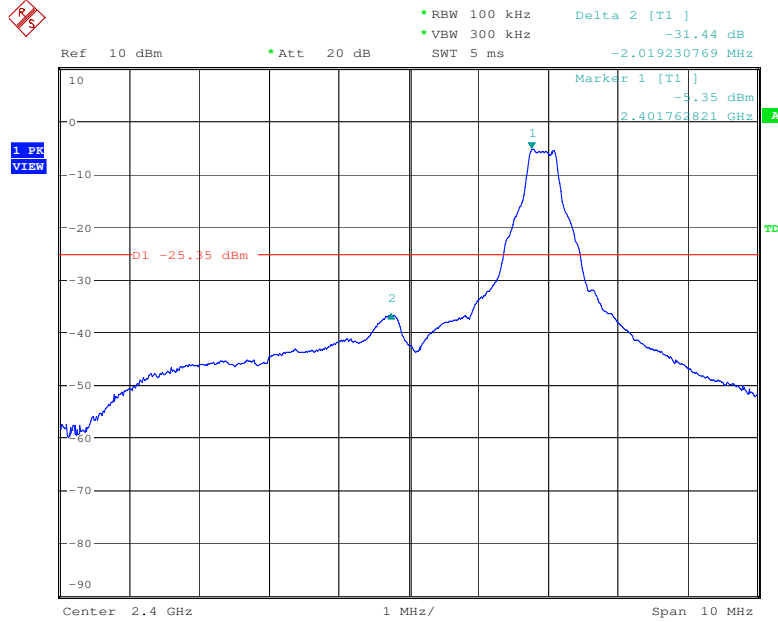

Date: 3.JUN.2016 14:26:33

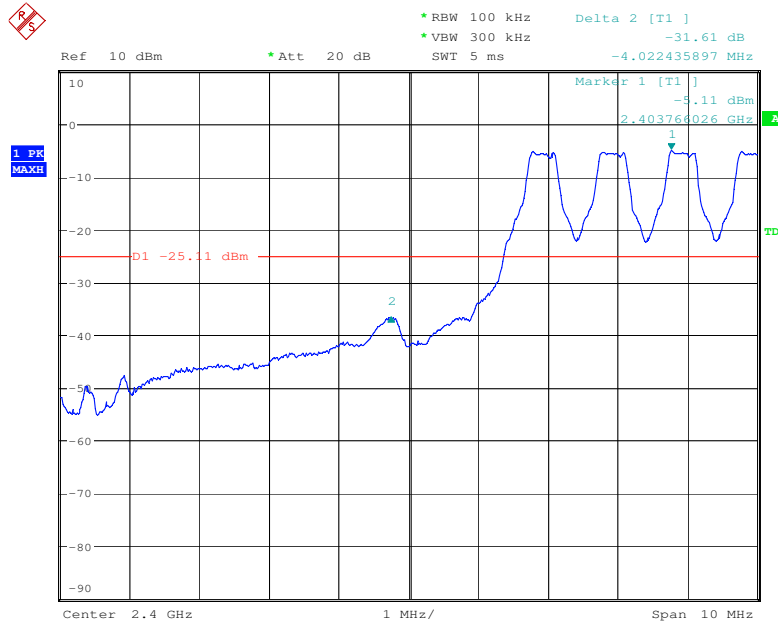

Date: 3.JUN.2016 14:30:00

GFSK Highest Channel

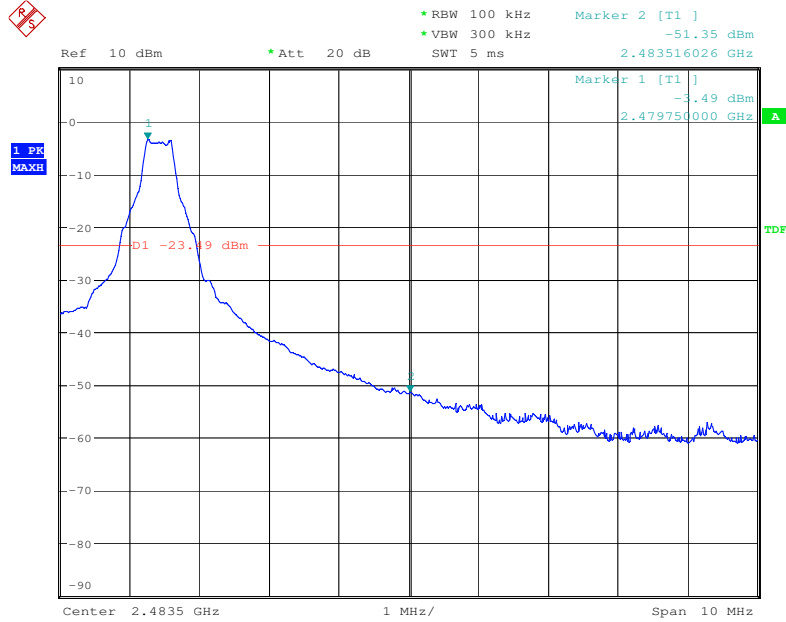

Date: 3.JUN.2016 14:34:01

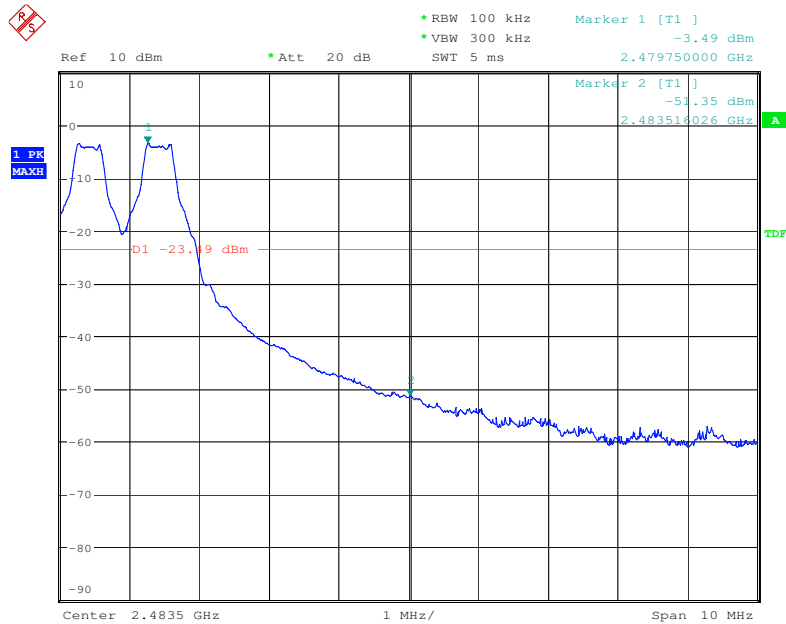

Date: 3.JUN.2016 14:35:00

$\pi/4$ -DQPSK Lowest Channel

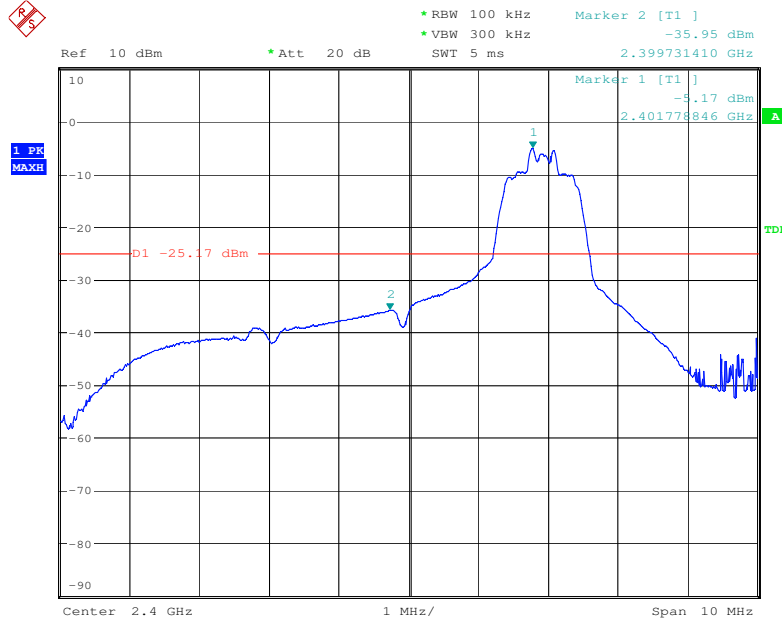

Date: 3.JUN.2016 14:41:16

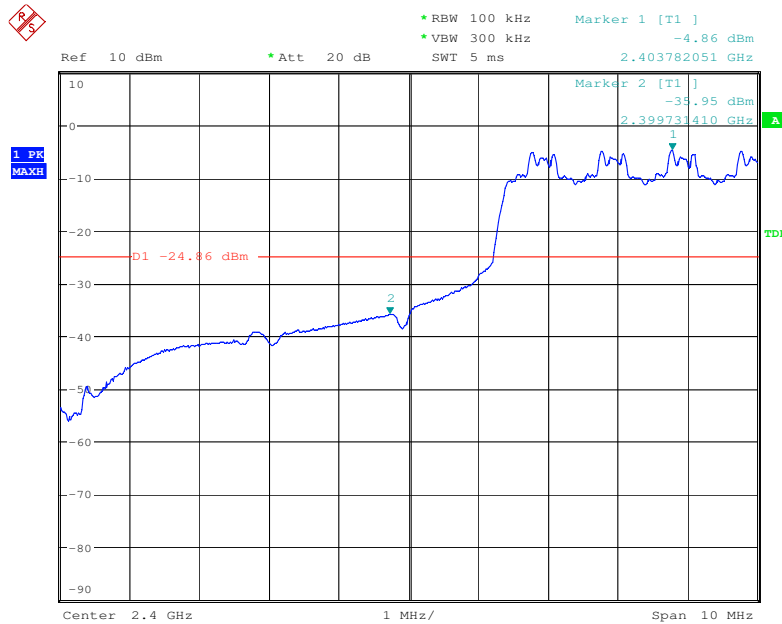

Date: 3.JUN.2016 14:43:32

$\pi/4$ -DQPSK Highest Channel

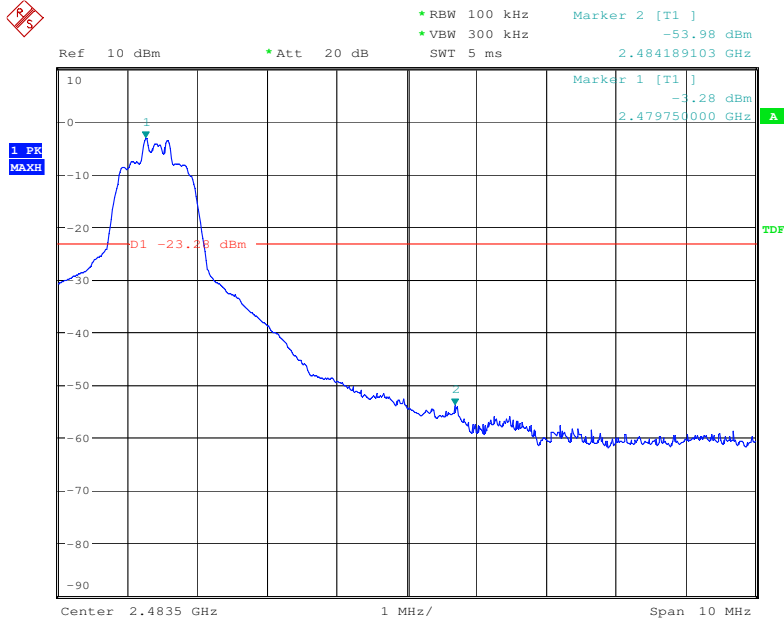

Date: 3.JUN.2016 14:46:31

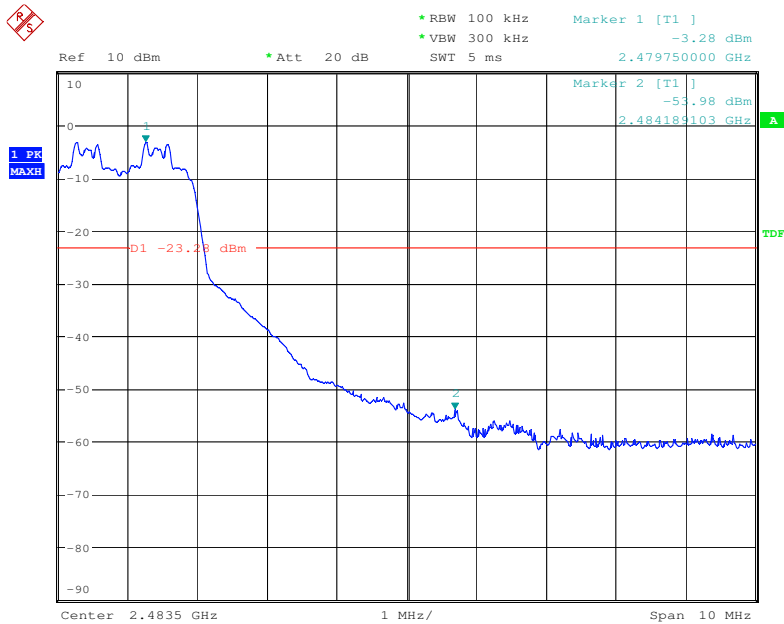

Date: 3.JUN.2016 14:47:43

11. Antenna Application

11.1 Antenna requirement

According to of FCC part 15C section 15.203 and 15.240:

An intentional radiator shall be designed to ensure that no antenna other than that furnished by the responsible party shall be used with the device. The use of a permanently attached antenna or of an antenna that uses a unique coupling to the intentional radiator, the manufacturer may design the unit so that a broken antenna can be replaced by the user, but the use of a standard antenna jack or electrical connector is prohibited.

Systems operating in the 2400-2483.5MHz band that are used exclusively for fixed, point-to-point operations may employ transmitting antennas with directional gain greater than 6dBi provided the maximum peak output power of the intentional radiator is reduced by 1dB for every 3dB that the directional gain of the antenna exceeds 6dBi.

11.2 Measurement Results

The antenna is PCB antenna and no consideration of replacement, and the best case gain of the antenna is 0dBi. So, the antenna is consider meet the requirement.

12. Conducted Spurious Emissions

12.1 Measurement Procedure

Out of Band Conducted Spurious Emissions, FCC Rule 15.247(d):

The transmitter output is connected to spectrum analyzer. All spurious emission and up to the tenth harmonic was measured and they were found to be at least 20dB below the highest level of the desired power in the passband.

12.2. Measurement Results

Please refer to following plots, the worst case ($\pi/4$ -DQPSK) was shown.

Lowest Channel

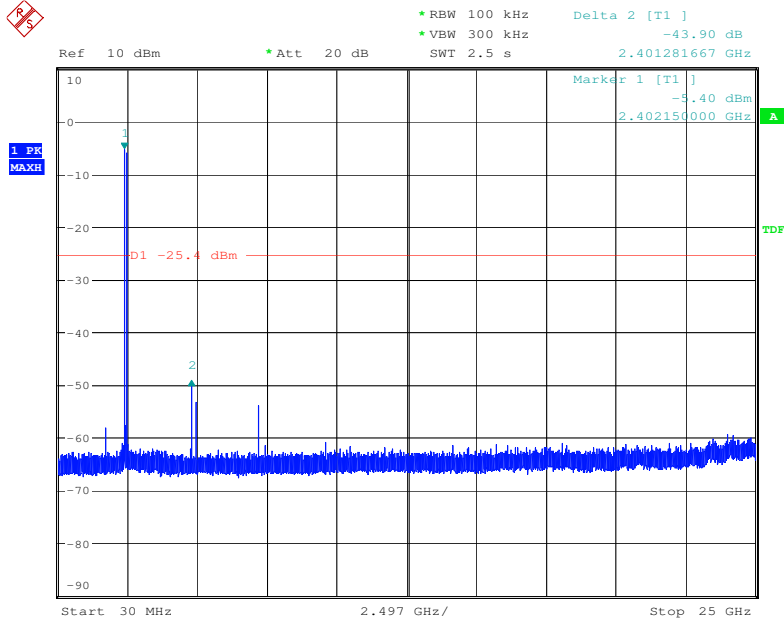

Date: 3.JUN.2016 14:52:44

Middle Channel

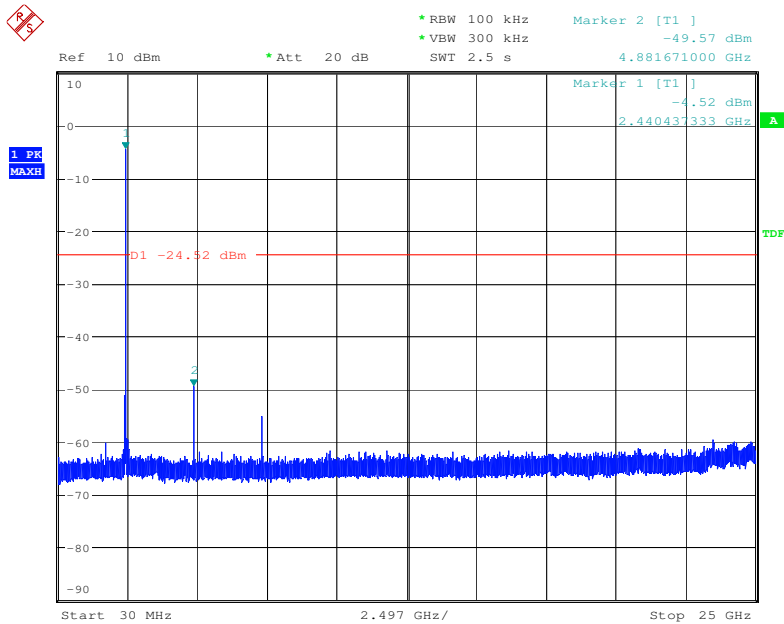

Date: 3.JUN.2016 14:55:10

Highest Channel

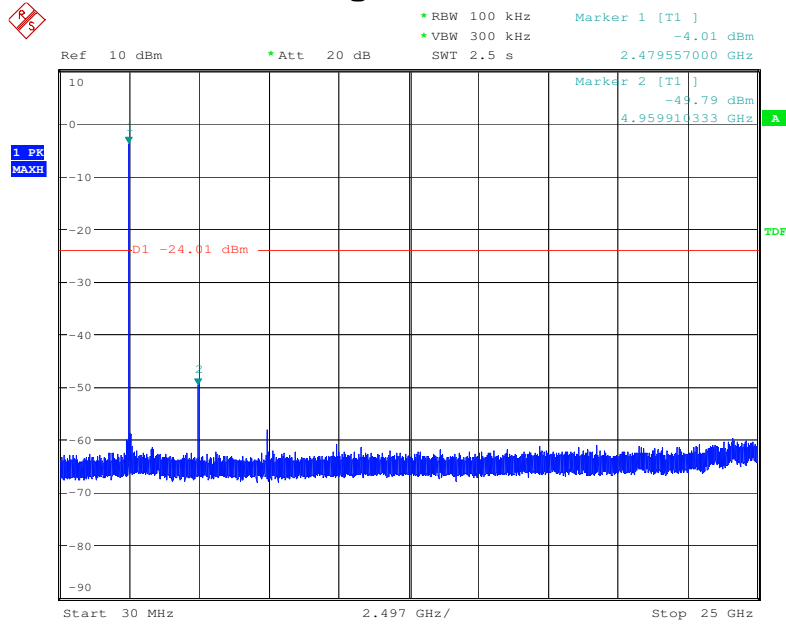

Date: 3.JUN.2016 15:01:13

Note: Sweep points=30001pts

13. Test Equipment List

| Description | Manufacturer | Model Number | Serial Number | Characteristics | Calibration Date | Calibration Due Date |
|--------------------------------|-----------------|--------------|---------------|-----------------|------------------|----------------------|
| Test Receiver | Rohde & Schwarz | ESCI7 | 100837 | 9KHz~7GHz | Nov. 23, 2015 | Nov. 22, 2016 |
| Antenna | Schwarzbeck | VULB9162 | 9162-010 | 30MHz~7GHz | Nov. 26, 2015 | Nov. 25, 2016 |
| Positioning Controller | UC | UC 3000 | N/A | 0~360° , 1-4m | N/A | N/A |
| Color Monitor | SUNSP0 | SP-140A | N/A | N/A | N/A | N/A |
| Single Phase Power Line Filter | SAEMC | PF201A-32 | 110210 | 32A | N/A | N/A |
| 3 Phase Power Line Filter | SAEMC | PF401A-200 | 110318 | 200A | N/A | N/A |
| DC Power Filter | SAEMC | PF301A-200 | 110245 | 200A | N/A | N/A |
| Cable | Huber+Suhner | CBL2-NN-1M | 22390001 | 9KHz~7GHz | Nov. 07, 2015 | Nov. 06, 2016 |
| Cable | Huber+Suhner | CIL02 | N/A | 9KHz~7GHz | Nov. 07, 2015 | Nov. 06, 2016 |
| RF Cable | Huber+Suhner | SF-104 | MY16559/4 | 9KHz~25GHz | Mar. 06, 2016 | Mar. 05, 2017 |
| Power Amplifier | HP | HP 8447D | 1145A00203 | 100KHz~1.3GHz | Nov. 07, 2015 | Nov. 06, 2016 |
| Horn Antenna | Schwarzbeck | BBHA9170 | 9170-372 | 15GHz~26.5GHz | Oct.23, 2015 | Oct.22, 2016 |
| Horn Antenna | Com-Power | AH-118 | 071078 | 1GHz~18GHz | Nov. 05, 2015 | Nov. 04, 2016 |
| Loop antenna | Daze | ZA30900A | 0708 | 9KHz~30MHz | Oct.10, 2015 | Oct.09, 2016 |
| Spectrum Analyzer | Rohde & Schwarz | FSU26 | 200409/026 | 20Hz~26.5GHz | Sep. 01, 2015 | Aug. 31, 2016 |
| Pre-Amplifier | Agilent | 8449B | 3008A02964 | 1GHz~26.5GHz | Nov. 03, 2015 | Nov. 02, 2016 |
| L.I.S.N. | Rohde & Schwarz | ENV 216 | 101317 | 9KHz~30MHz | Nov. 07, 2015 | Nov. 06, 2016 |
| Temporary antenna connector | TESCOM | SS402 | N/A | 9KHz-25GHz | N/A | N/A |

Note: The temporary antenna connector is soldered on the PCB board in order to perform conducted tests and this temporary antenna connector is listed in the equipment list.

---End---