



# **FCC RADIO TEST REPORT-BT**

## **FCC ID:HBOUB450**

**Product** : Bluetooth Stereo Headset

**Trade Name** : hotncold

**Model Name** : UB450

**Serial Model** : N/A

**Report No.** : NTEK-2015DC1027001F2

### **Prepared for**

SHENZHEN FENDA TECHNOLOGY CO., LTD.

Fenda Hi-Tech Park, Zhoushi Road, Shiyan Town, Baoan District,  
Shenzhen City,Guangdong,China

### **Prepared by**

Shenzhen NTEK Testing Technology Co., Ltd.

1/F, Building E, Fenda Science Park, Sanwei Community,Xixiang Street  
Bao'an District, Shenzhen P.R. China

Tel.: +86-0755-61156588 Fax.: +86-0755-61156599

Website:www.ntek.org.cn

## TEST RESULT CERTIFICATION

**Applicant's name** ..... : SHENZHEN FENDA TECHNOLOGY CO., LTD.  
Address ..... : Fenda Hi-Tech Park, Zhoushi Road, Shiyao Town, Baoan District,  
Shenzhen City,Guangdong,China  
**Manufacturer's Name**..... : SHENZHEN FENDA TECHNOLOGY CO., LTD.  
Address ..... : Fenda Hi-Tech Park, Zhoushi Road, Shiyao Town, Baoan District,  
Shenzhen City,Guangdong,China

**Product description**

Product name ..... : Bluetooth Stereo Headset  
Model and/or type reference : UB450  
Serial Model : N/A

**Standards** ..... : FCC Part15.247: 01 Oct. 2015

Test procedure ..... ANSI C63.10-2013

This device described above has been tested by NTEK, and the test results show that the equipment under test (EUT) is in compliance with the FCC requirements. And it is applicable only to the tested sample identified in the report.

This report shall not be reproduced except in full, without the written approval of NTEK, this document may be altered or revised by NTEK, personnel only, and shall be noted in the revision of the document.

**Date of Test** .....

Date (s) of performance of tests ..... : 27 Oct. 2015 ~30 Oct. 2015

Date of Issue..... : 30 Oct. 2015

Test Result..... : **Pass**

Testing Engineer :



(Susan Su)

Technical Manager :

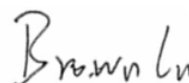

(Brown Lu)

Authorized Signatory :

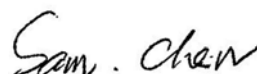

(Sam Chen)

**Table of Contents**

	<b>Page</b>
<b>1 . SUMMARY OF TEST RESULTS</b>	<b>5</b>
1.1 TEST FACILITY	6
1.2 MEASUREMENT UNCERTAINTY	6
<b>2 . GENERAL INFORMATION</b>	<b>7</b>
2.1 GENERAL DESCRIPTION OF EUT	7
2.2 DESCRIPTION OF TEST MODES	9
2.3 TABLE OF PARAMETERS OF TEXT SOFTWARE SETTING	9
2.4 BLOCK DIGRAM SHOWING THE CONFIGURATION OF SYSTEM TESTED	10
2.5 DESCRIPTION OF SUPPORT UNITS(CONDUCTED MODE)	11
2.6 EQUIPMENTS LIST FOR ALL TEST ITEMS	12
<b>3 . EMC EMISSION TEST</b>	<b>13</b>
3.1 CONDUCTED EMISSION MEASUREMENT	13
3.1.1 POWER LINE CONDUCTED EMISSION LIMITS	13
3.1.2 TEST PROCEDURE	14
3.1.3 DEVIATION FROM TEST STANDARD	14
3.1.4 TEST SETUP	14
3.1.5 EUT OPERATING CONDITIONS	14
3.1.6 TEST RESULTS	15
3.2 RADIATED EMISSION MEASUREMENT	23
3.2.1 RADIATED EMISSION LIMITS	23
3.2.2 TEST PROCEDURE	24
3.2.3 DEVIATION FROM TEST STANDARD	24
3.2.4 TEST SETUP	25
3.2.5 EUT OPERATING CONDITIONS	26
3.2.6 TEST RESULTS (BELOW 30 MHZ)	27
3.2.7 TEST RESULTS (BETWEEN 30M – 1000 MHZ)	28
3.2.8 TEST RESULTS (ABOVE 1000 MHZ)	30
<b>4 . NUMBER OF HOPPING CHANNEL</b>	<b>31</b>
4.1 APPLIED PROCEDURES / LIMIT	31
4.1.1 TEST PROCEDURE	31
4.1.2 DEVIATION FROM STANDARD	31
4.1.3 TEST SETUP	31
4.1.4 EUT OPERATION CONDITIONS	31
4.1.5 TEST RESULTS	32
<b>5 . AVERAGE TIME OF OCCUPANCY</b>	<b>33</b>
5.1 APPLIED PROCEDURES / LIMIT	33

**Table of Contents**

	<b>Page</b>
5.1.1 TEST PROCEDURE	33
5.1.2 DEVIATION FROM STANDARD	33
5.1.3 TEST SETUP	34
5.1.4 EUT OPERATION CONDITIONS	34
5.1.5 TEST RESULTS	35
<b>6 . HOPPING CHANNEL SEPARATION MEASUREMENT</b>	<b>41</b>
6.1 APPLIED PROCEDURES / LIMIT	41
6.1.1 TEST PROCEDURE	41
6.1.2 DEVIATION FROM STANDARD	41
6.1.3 TEST SETUP	41
6.1.4 EUT OPERATION CONDITIONS	41
6.1.5 TEST RESULTS	42
<b>7 . BANDWIDTH TEST</b>	<b>48</b>
7.1 APPLIED PROCEDURES / LIMIT	48
7.1.1 TEST PROCEDURE	48
7.1.2 DEVIATION FROM STANDARD	48
7.1.3 TEST SETUP	48
7.1.4 EUT OPERATION CONDITIONS	48
7.1.5 TEST RESULTS	49
<b>8 . PEAK OUTPUT POWER TEST</b>	<b>55</b>
8.1 APPLIED PROCEDURES / LIMIT	55
8.1.1 TEST PROCEDURE	55
8.1.2 DEVIATION FROM STANDARD	55
8.1.3 TEST SETUP	55
8.1.4 EUT OPERATION CONDITIONS	55
8.1.5 TEST RESULTS	56
<b>9 . 100 KHZ BANDWIDTH OF FREQUENCY BAND EDGE</b>	<b>62</b>
9.1 DEVIATION FROM STANDARD	62
9.2 TEST SETUP	62
9.3 EUT OPERATION CONDITIONS	62
9.4 TEST RESULTS	63
<b>10 . ANTENNA REQUIREMENT</b>	<b>71</b>
10.1 STANDARD REQUIREMENT	71
10.2 EUT ANTENNA	71
<b>11 . EUT TEST PHOTO</b>	<b>72</b>
<b>APPENDIX-PHOTOGRAPHS OF EUT CONSTRUCTIONAL DETAILS</b>	

### 1. SUMMARY OF TEST RESULTS

Test procedures according to the technical standards:

<b>FCC Part15 (15.247) , Subpart C</b>			
Standard Section	Test Item	Judgment	Remark
15.207	Conducted Emission	PASS	
15.247(a)(1)	Hopping Channel Separation	PASS	
15.247(b)(1)	Peak Output Power	PASS	
15.247(c)	Radiated Spurious Emission	PASS	
15.247(a)(iii)	Number of Hopping Frequency	PASS	
15.247(a)(iii)	Dwell Time	PASS	
15.247(a)(1)	Bandwidth	PASS	
15.205	Band Edge Emission	PASS	
15.203	Antenna Requirement	PASS	

**NOTE:**

(1) "N/A" denotes test is not applicable in this Test Report

**1.1 TEST FACILITY**

NTEK Testing Technology Co., Ltd

Add. : 1/F, Building E, Fenda Science Park, Sanwei Community, Xixiang Street, Bao'an District, Shenzhen P.R. China.

FCC Registration No.:238937; IC Registration No.:9270A-1

CNAS Registration No.:L5516

**1.2 MEASUREMENT UNCERTAINTY**

The reported uncertainty of measurement  $y \pm U$ , where expanded uncertainty  $U$  is based on a standard uncertainty multiplied by a coverage factor of  $k=2$ , providing a level of confidence of approximately **95 %**.

No.	Item	Uncertainty
1	Conducted Emission Test	$\pm 1.38\text{dB}$
2	RF power,conducted	$\pm 0.16\text{dB}$
3	Spurious emissions,conducted	$\pm 0.21\text{dB}$
4	All emissions,radiated(<1G)	$\pm 4.68\text{dB}$
5	All emissions,radiated(>1G)	$\pm 4.89\text{dB}$
6	Temperature	$\pm 0.5^\circ\text{C}$
7	Humidity	$\pm 2\%$

## 2. GENERAL INFORMATION

### 2.1 GENERAL DESCRIPTION OF EUT

Equipment	Bluetooth Stereo Headset	
Trade Name	hotncold	
Model Name	UB450	
Serial Model	N/A	
Model Difference	N/A	
Product Description	The EUT is a Bluetooth Stereo Headset	
	Operation Frequency:	2402~2480 MHz
	Modulation Type:	BT(1Mbps): GFSK BT EDR(2Mbps): $\pi/4$ -DQPSK BT EDR(3Mbps): 8-DPSK
	Bit Rate of Transmitter	1Mbps/2Mbps/3Mbps
	Number Of Channel	79 CH
	Antenna Designation:	Please see Note 3.
	Based on the application, features, or specification exhibited in User's Manual, the EUT is considered as an ITE/Computing Device. More details of EUT technical specification, please refer to the User's Manual.	
Channel List	Please refer to the Note 2.	
Adapter	N/A	
Battery	DC 3.7V,125mAh	
Connecting I/O Port(s)	Please refer to the User's Manual	
Hardware Version	HUB450_V1.0	
Software Version	SUB450_V1.0	

Note:

1. For a more detailed features description, please refer to the manufacturer's specifications or the User's Manual.

2.

Channel List					
Channel	Frequency (MHz)	Channel	Frequency (MHz)	Channel	Frequency (MHz)
00	2402	27	2429	54	2456
01	2403	28	2430	55	2457
02	2404	29	2431	56	2458
03	2405	30	2432	57	2459
04	2406	31	2433	58	2460
05	2407	32	2434	59	2461
06	2408	33	2435	60	2462
07	2409	34	2436	61	2463
08	2410	35	2437	62	2464
09	2411	36	2438	63	2465
10	2412	37	2439	64	2466
11	2413	38	2440	65	2467
12	2414	39	2441	66	2468
13	2415	40	2442	67	2469
14	2416	41	2443	68	2470
15	2417	42	2444	69	2471
16	2418	43	2445	70	2472
17	2419	44	2446	71	2473
18	2420	45	2447	72	2474
19	2421	46	2448	73	2475
20	2422	47	2449	74	2476
21	2423	48	2450	75	2477
22	2424	49	2451	76	2478
23	2425	50	2452	77	2479
24	2426	51	2453	78	2480
25	2427	52	2454		
26	2428	53	2455		

3.

Table for Filed Antenna

Ant	Brand	Model Name	Antenna Type	Connector	Gain (dBi)	NOTE
1	N/A	N/A	PCB Antenna	N/A	1.0	BT Antenna



## 2.2 DESCRIPTION OF TEST MODES

To investigate the maximum EMI emission characteristics generates from EUT, the test system was pre-scanning tested base on the consideration of following EUT operation mode or test configuration mode which possible have effect on EMI emission level. Each of these EUT operation mode(s) or test configuration mode(s) mentioned above was evaluated respectively.

Pretest Mode	Description
Mode 1	CH00
Mode 2	CH39
Mode 3	CH78
Mode 4	normal link

For Conducted Emission	
Final Test Mode	Description
Mode 4	normal link

For Radiated Emission	
Final Test Mode	Description
Mode 1	CH00
Mode 2	CH39
Mode 3	CH78

Note:

- (1) The measurements are performed at the highest, middle, lowest available channels.
- (2) The EUT use new battery.
- (3)The data rate was set in 1Mbps for radiated emission due to the highest RF output power.

## 2.3 TABLE OF PARAMETERS OF TEXT SOFTWARE SETTING

During testing channel & power controlling software provided by the customer was used to control the operating channel as well as the output power level. The RF output power selection is for the setting of RF output power expected by the customer and is going to be fixed on the firmware of the final end product power parameters of FHSS

Test software Version	Test program: Broadcom		
Frequency	2402 MHz	2441 MHz	2480 MHz
Parameters(1/2/3Mbps)	DEF	DEF	DEF

### 2.4 BLOCK DIGRAM SHOWING THE CONFIGURATION OF SYSTEM TESTED

Radiated Spurious Emission Test

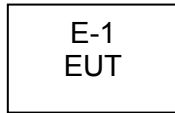

Conducted Emission Test

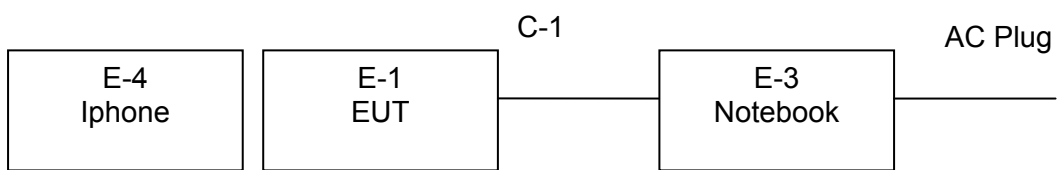
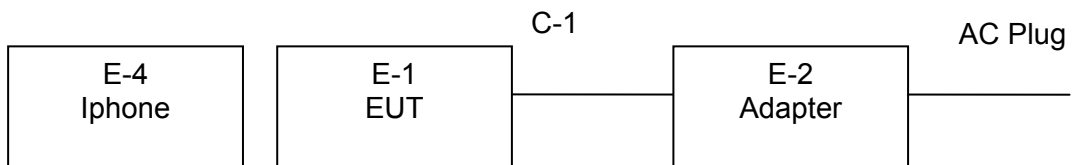

**2.5 DESCRIPTION OF SUPPORT UNITS(CONDUCTED MODE)**

The EUT has been tested as an independent unit together with other necessary accessories or support units. The following support units or accessories were used to form a representative test configuration during the tests.

Item	Equipment	Mfr/Brand	Model/Type No.	Series No.	Note
E-1	Bluetooth Stereo Headset	hotncold	UB450	N/A	EUT
E-2	Adapter	N/A	AD1	N/A	
E-3	Notebook	Lenove	Thinkpad Edge E430	N/A	
E-4	iphone	Apple	A1387	N/A	

Item	Shielded Type	Ferrite Core	Length	Note
C-1	NO	NO	1.0m	

**Note:**

- (1) The support equipment was authorized by Declaration of Confirmation.
- (2) For detachable type I/O cable should be specified the length in cm in 『Length』 column.
- (3) “YES” is means “shielded” “with core”; “NO” is means “unshielded” “without core”.

## 2.6 EQUIPMENTS LIST FOR ALL TEST ITEMS

### Radiation Test equipment

Item	Kind of Equipment	Manufacturer	Type No.	Serial No.	Last calibration	Calibrated until	Calibration period
1	Spectrum Analyzer	Agilent	E4407B	MY45108040	2015.07.06	2016.07.05	1 year
2	Test Receiver	R&S	ESPI	101318	2015.06.07	2016.06.06	1 year
3	Bilog Antenna	TESEQ	CBL6111D	31216	2015.07.06	2016.07.05	1 year
4	50Ω Coaxial Switch	Anritsu	MP59B	6200264416	2015.06.07	2016.06.06	1 year
5	Spectrum Analyzer	ADVANTEST	R3132	150900201	2015.06.07	2016.06.06	1 year
6	Horn Antenna	EM	EM-AH-10180	2011071402	2015.07.06	2016.07.05	1 year
7	Horn Ant	Schwarzbeck	BBHA 9170	9170-181	2015.07.06	2016.07.05	1 year
8	Amplifier	EM	EM-30180	060538	2014.12.22	2015.12.21	1 year
9	Loop Antenna	ARA	PLA-1030/B	1029	2015.06.08	2016.06.07	1 year
10	Power Meter	R&S	NRVS	100696	2015.07.06	2016.07.05	1 year
11	Power Sensor	R&S	URV5-Z4	0395.1619.05	2015.07.06	2016.07.05	1 year
12	Test Cable	N/A	R-01	N/A	2015.07.06	2016.07.05	1 year
13	Test Cable	N/A	R-02	N/A	2015.07.06	2016.07.05	1 year

### Conduction Test equipment

Item	Kind of Equipment	Manufacturer	Type No.	Serial No.	Last calibration	Calibrated until	Calibration period
1	Test Receiver	R&S	ESCI	101160	2015.06.06	2016.06.05	1 year
2	LISN	R&S	ENV216	101313	2015.08.24	2016.08.23	1 year
3	LISN	EMCO	3816/2	00042990	2015.08.24	2016.08.23	1 year
4	50Ω Coaxial Switch	Anritsu	MP59B	6200264417	2015.06.07	2016.06.06	1 year
5	Passive Voltage Probe	R&S	ESH2-Z3	100196	2015.06.07	2016.06.06	1 year
6	Absorbing clamp	R&S	MOS-21	100423	2015.06.08	2016.06.07	1 year
7	Test Cable	N/A	C01	N/A	2015.06.08	2016.06.07	1 year
8	Test Cable	N/A	C02	N/A	2015.06.08	2016.06.07	1 year
9	Test Cable	N/A	C03	N/A	2015.06.08	2016.06.07	1 year

1	Attenuation	MCE	24-10-34	BN9258	2015.06.08	2016.06.07	1 year
---	-------------	-----	----------	--------	------------	------------	--------

### 3. EMC EMISSION TEST

#### 3.1 CONDUCTED EMISSION MEASUREMENT

##### 3.1.1 POWER LINE CONDUCTED EMISSION Limits (Frequency Range 150KHz-30MHz)

FREQUENCY (MHz)	Class A (dBuV)		Class B (dBuV)		Standard
	Quasi-peak	Average	Quasi-peak	Average	
0.15 -0.5	79.00	66.00	66 - 56 *	56 - 46 *	CISPR
0.50 -5.0	73.00	60.00	56.00	46.00	CISPR
5.0 -30.0	73.00	60.00	60.00	50.00	CISPR

0.15 -0.5	79.00	66.00	66 - 56 *	56 - 46 *	FCC
0.50 -5.0	73.00	60.00	56.00	46.00	FCC
5.0 -30.0	73.00	60.00	60.00	50.00	FCC

Note:

- (1) The tighter limit applies at the band edges.
- (2) The limit of " \* " marked band means the limitation decreases linearly with the logarithm of the frequency in the range.

The following table is the setting of the receiver

Receiver Parameters	Setting
Attenuation	10 dB
Start Frequency	0.15 MHz
Stop Frequency	30 MHz
IF Bandwidth	9 kHz

**3.1.2 TEST PROCEDURE**

- a. The EUT was placed 0.8 meters from the horizontal ground plane with EUT being connected to the power mains through a line impedance stabilization network (LISN). All other support equipments powered from additional LISN(s). The LISN provide 50 Ohm/ 50uH of coupling impedance for the measuring instrument.
- b. Interconnecting cables that hang closer than 40 cm to the ground plane shall be folded back and forth in the center forming a bundle 30 to 40 cm long.
- c. I/O cables that are not connected to a peripheral shall be bundled in the center. The end of the cable may be terminated, if required, using the correct terminating impedance. The overall length shall not exceed 1 m.
- d. LISN at least 80 cm from nearest part of EUT chassis.
- e. For the actual test configuration, please refer to the related Item –EUT Test Photos.

**3.1.3 DEVIATION FROM TEST STANDARD**

No deviation

**3.1.4 TEST SETUP**

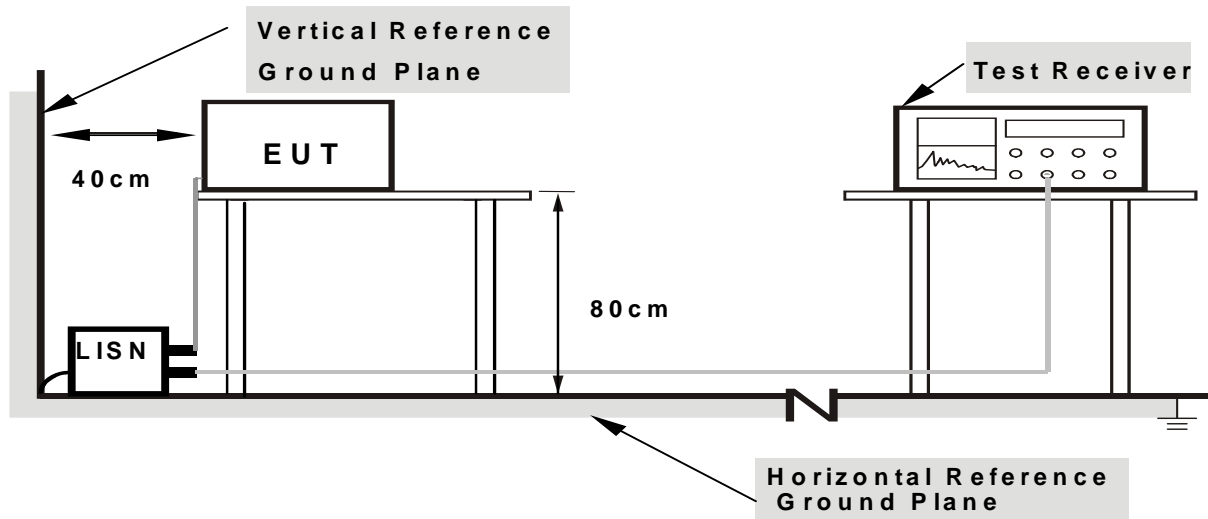

- Note:**
- 1.Support units were connected to second LISN.
  - 2.Both of LISNs (AMN) are 80 cm from EUT and at least 80 from other units and other metal planes

**3.1.5 EUT OPERATING CONDITIONS**

The EUT was configured for testing in a typical fashion (as a customer would normally use it). The EUT has been programmed to continuously transmit during test. This operating condition was tested and used to collect the included data.

### 3.1.6 TEST RESULTS

EUT :	Bluetooth Stereo Headset	Model Name :	UB450
Temperature :	26 °C	Relative Humidity :	54%
Pressure :	1010hPa	Phase :	L
Test Voltage :	DC 5.0V from adapter AC 120V/60Hz	Test Mode :	Mode 4

Frequency (MHz)	Reading Level (dBμV)	Correct Factor (dB)	Measure-ment (dBμV)	Limits (dBμV)	Margin (dB)	Remark
0.1985	38.54	9.46	48.00	63.67	-15.67	QP
0.1985	17.80	9.46	27.26	53.67	-26.41	AVG
0.3462	35.76	9.44	45.20	59.05	-13.85	QP
0.3462	16.27	9.44	25.71	49.05	-23.34	AVG
0.5581	32.55	9.45	42.00	56.00	-14.00	QP
0.5581	14.08	9.45	23.53	46.00	-22.47	AVG
0.6500	31.86	9.44	41.30	56.00	-14.70	QP
0.6500	13.98	9.44	23.42	46.00	-22.58	AVG
1.9217	21.39	9.46	30.85	56.00	-25.15	QP
1.9217	5.10	9.46	14.56	46.00	-31.44	AVG
5.1577	18.96	9.49	28.45	60.00	-31.55	QP
5.1577	6.18	9.49	15.67	50.00	-34.33	AVG

Remark:

1. All readings are Quasi-Peak and Average values.
2. Factor = Insertion Loss + Cable Loss.

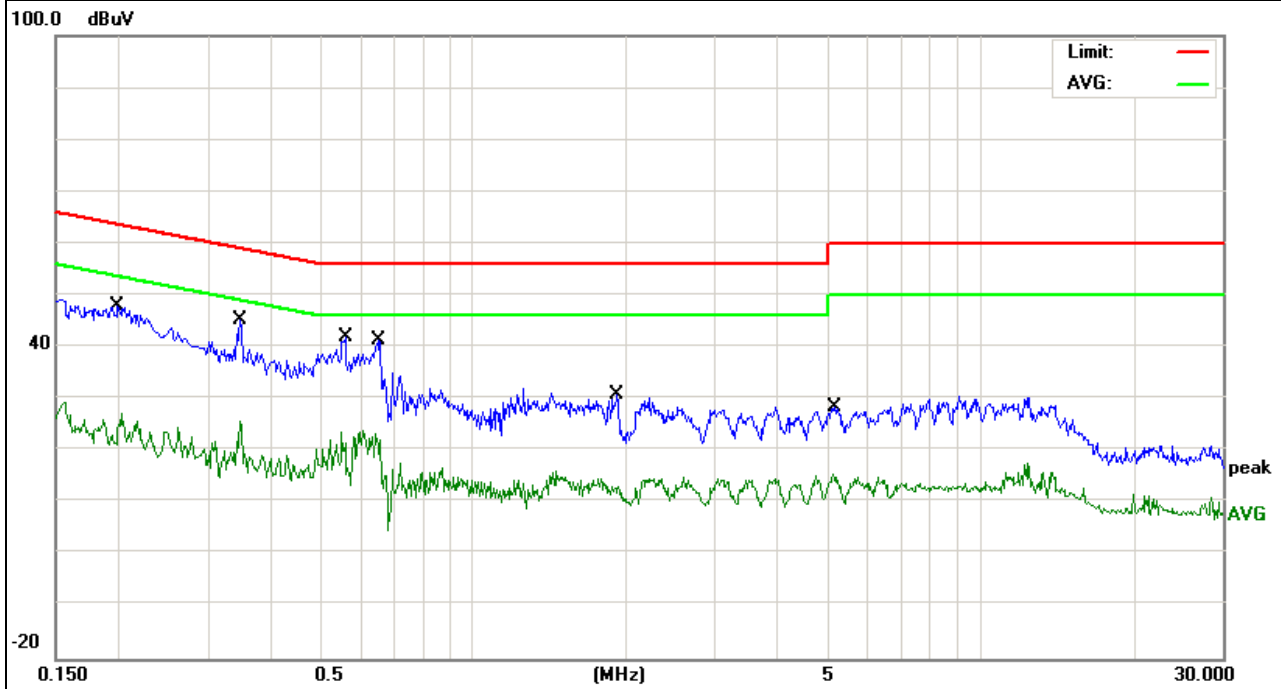

EUT :	Bluetooth Stereo Headset	Model Name :	UB450
Temperature :	26 °C	Relative Humidity :	54%
Pressure :	1010hPa	Phase :	N
Test Voltage :	DC 5.0V from adapter AC 120V/60Hz	Test Mode :	Mode 4

Frequency (MHz)	Reading Level (dBμV)	Correct Factor (dB)	Measure-ment (dBμV)	Limits (dBμV)	Margin (dB)	Remark
0.1700	44.24	9.46	53.70	64.96	-11.26	QP
0.1700	20.89	9.46	30.35	54.96	-24.61	AVG
0.2519	39.15	9.45	48.60	61.69	-13.09	QP
0.2519	17.84	9.45	27.29	51.69	-24.40	AVG
0.4178	33.06	9.44	42.50	57.49	-14.99	QP
0.4178	14.81	9.44	24.25	47.49	-23.24	AVG
0.6460	31.16	9.44	40.60	56.00	-15.40	QP
0.6460	13.68	9.44	23.12	46.00	-22.88	AVG
1.3340	22.50	9.45	31.95	56.00	-24.05	QP
1.3340	5.79	9.45	15.24	46.00	-30.76	AVG
12.1936	25.88	9.72	35.60	60.00	-24.40	QP
12.1936	12.36	9.72	22.08	50.00	-27.92	AVG

Remark:

1. All readings are Quasi-Peak and Average values.
2. Factor = Insertion Loss + Cable Loss.

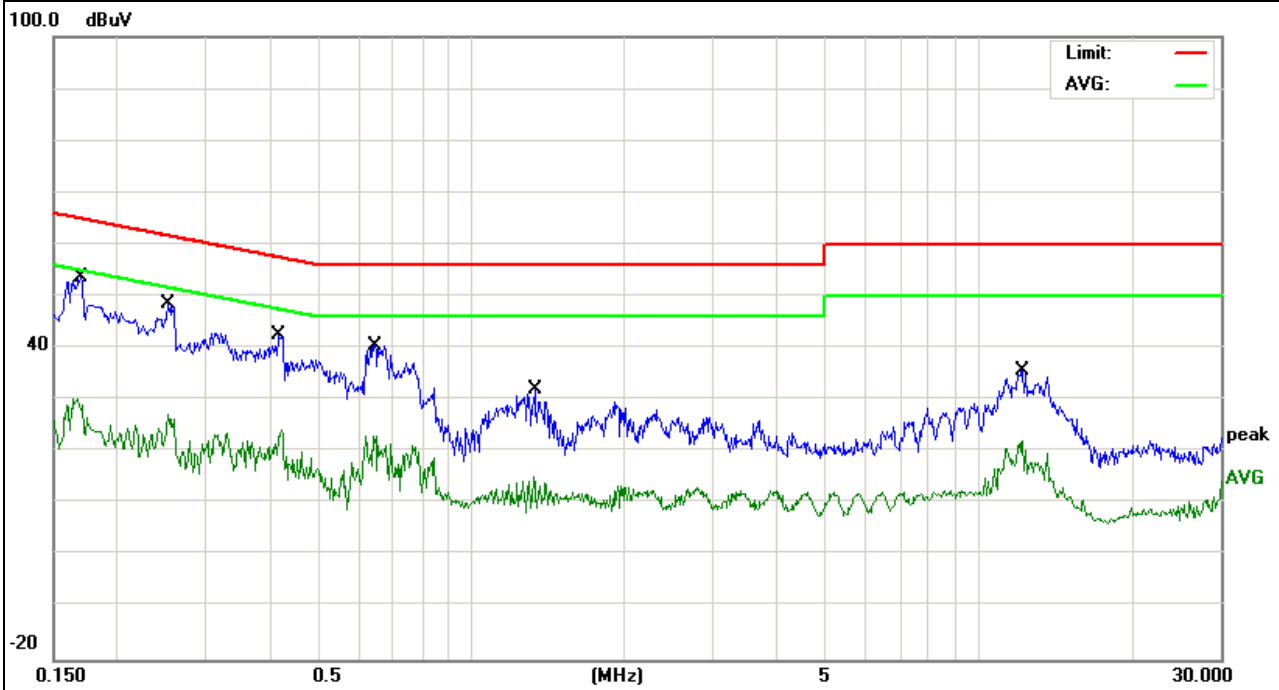



EUT :	Bluetooth Stereo Headset	Model Name :	UB450
Temperature :	26 °C	Relative Humidity :	54%
Pressure :	1010hPa	Phase :	L
Test Voltage :	DC 5.0V from adapter AC 240V/60Hz	Test Mode :	Mode 4

Frequency (MHz)	Reading Level (dBμV)	Correct Factor (dB)	Measure-ment (dBμV)	Limits (dBμV)	Margin (dB)	Remark
0.1796	41.64	9.46	51.10	64.50	-13.40	QP
0.1796	20.73	9.46	30.19	54.50	-24.31	AVG
0.2983	31.06	9.44	40.50	60.29	-19.79	QP
0.2983	11.46	9.44	20.90	50.29	-29.39	AVG
0.5060	29.32	9.46	38.78	56.00	-17.22	QP
0.5060	12.64	9.46	22.10	46.00	-23.90	AVG
0.6660	31.77	9.43	41.20	56.00	-14.80	QP
0.6660	13.15	9.43	22.58	46.00	-23.42	AVG
1.2620	22.64	9.45	32.09	56.00	-23.91	QP
1.2620	5.04	9.45	14.49	46.00	-31.51	AVG
1.9616	22.84	9.46	32.30	56.00	-23.70	QP
1.9616	11.30	9.46	20.76	46.00	-25.24	AVG

Remark:

1. All readings are Quasi-Peak and Average values.
2. Factor = Insertion Loss + Cable Loss.

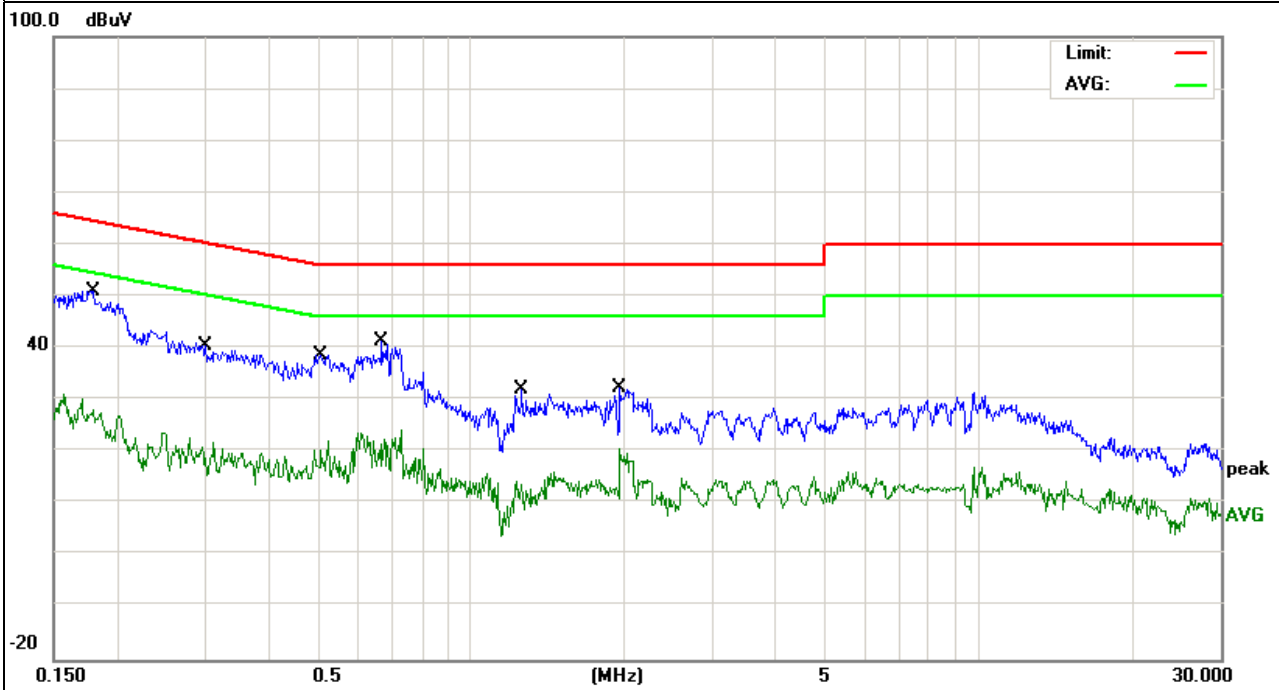

EUT :	Bluetooth Stereo Headset	Model Name :	UB450
Temperature :	26 °C	Relative Humidity :	54%
Pressure :	1010hPa	Phase :	N
Test Voltage :	DC 5.0V from adapter AC 240V/60Hz	Test Mode :	Mode 4

Frequency (MHz)	Reading Level (dBμV)	Correct Factor (dB)	Measure-ment (dBμV)	Limits (dBμV)	Margin (dB)	Remark
0.1597	43.44	9.46	52.90	65.47	-12.57	QP
0.1597	19.57	9.46	29.03	55.47	-26.44	AVG
0.2630	35.55	9.45	45.00	61.33	-16.33	QP
0.2630	15.58	9.45	25.03	51.33	-26.30	AVG
0.3064	33.46	9.44	42.90	60.07	-17.17	QP
0.3064	14.26	9.44	23.70	50.07	-26.37	AVG
0.6740	30.97	9.43	40.40	56.00	-15.60	QP
0.6740	12.04	9.43	21.47	46.00	-24.53	AVG
1.2338	21.42	9.44	30.86	56.00	-25.14	QP
1.2338	4.52	9.44	13.96	46.00	-32.04	AVG
13.6577	24.65	9.75	34.40	60.00	-25.60	QP
13.6577	9.87	9.75	19.62	50.00	-30.38	AVG

Remark:

1. All readings are Quasi-Peak and Average values.
2. Factor = Insertion Loss + Cable Loss.

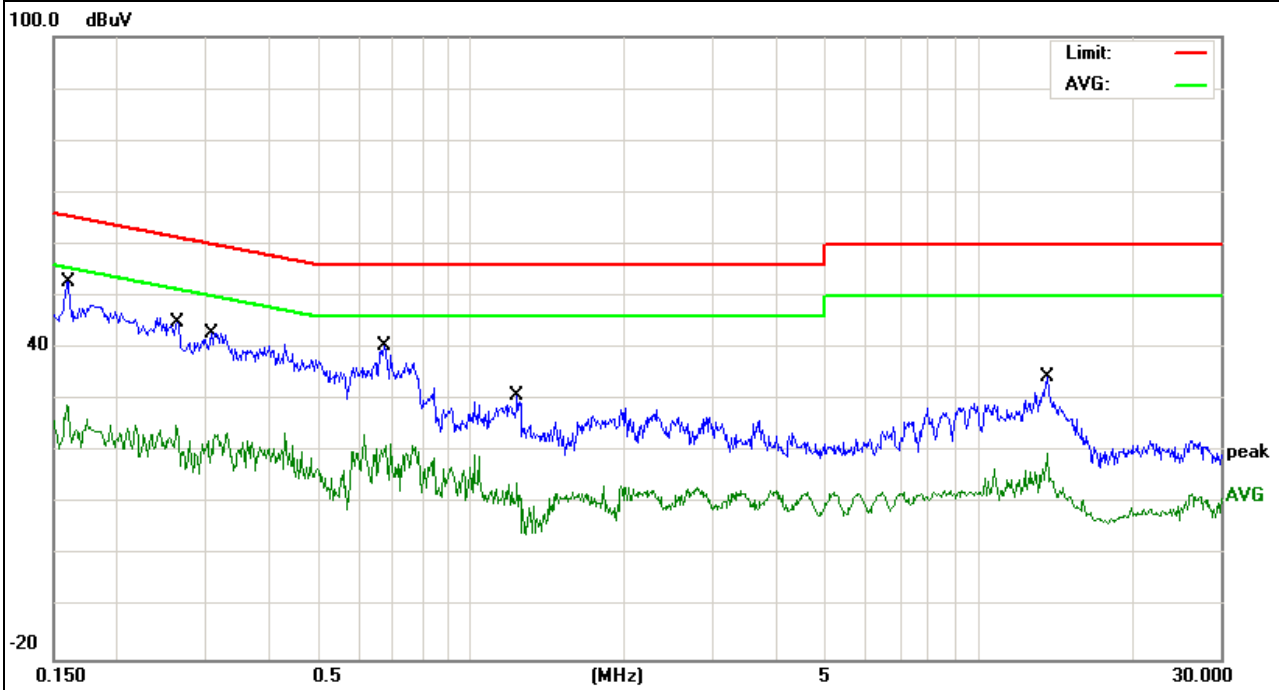

EUT :	Bluetooth Stereo Headset	Model Name :	UB450
Temperature :	26 °C	Relative Humidity :	54%
Pressure :	1010hPa	Phase :	L
Test Voltage :	DC 5.0V from PC AC 120V/60Hz	Test Mode :	Mode 4

Frequency (MHz)	Reading Level (dBμV)	Correct Factor (dB)	Measure-ment (dBμV)	Limits (dBμV)	Margin (dB)	Remark
0.2379	35.08	9.61	44.69	62.17	-17.48	QP
0.2379	22.04	9.61	31.65	52.17	-20.52	AVG
0.3420	33.11	9.62	42.73	59.15	-16.42	QP
0.3420	20.01	9.62	29.63	49.15	-19.52	AVG
0.5299	40.17	9.68	49.85	56.00	-6.15	QP
0.5299	19.87	9.68	29.55	46.00	-16.45	AVG
0.6939	37.24	9.64	46.88	56.00	-9.12	QP
0.6939	18.66	9.64	28.30	46.00	-17.70	AVG
1.0140	34.76	9.61	44.37	56.00	-11.63	QP
1.0140	17.04	9.61	26.65	46.00	-19.35	AVG
4.1539	30.86	9.51	40.37	56.00	-15.63	QP
4.1539	22.01	9.51	31.52	46.00	-14.48	AVG

Remark:

1. All readings are Quasi-Peak and Average values.
2. Factor = Insertion Loss + Cable Loss.

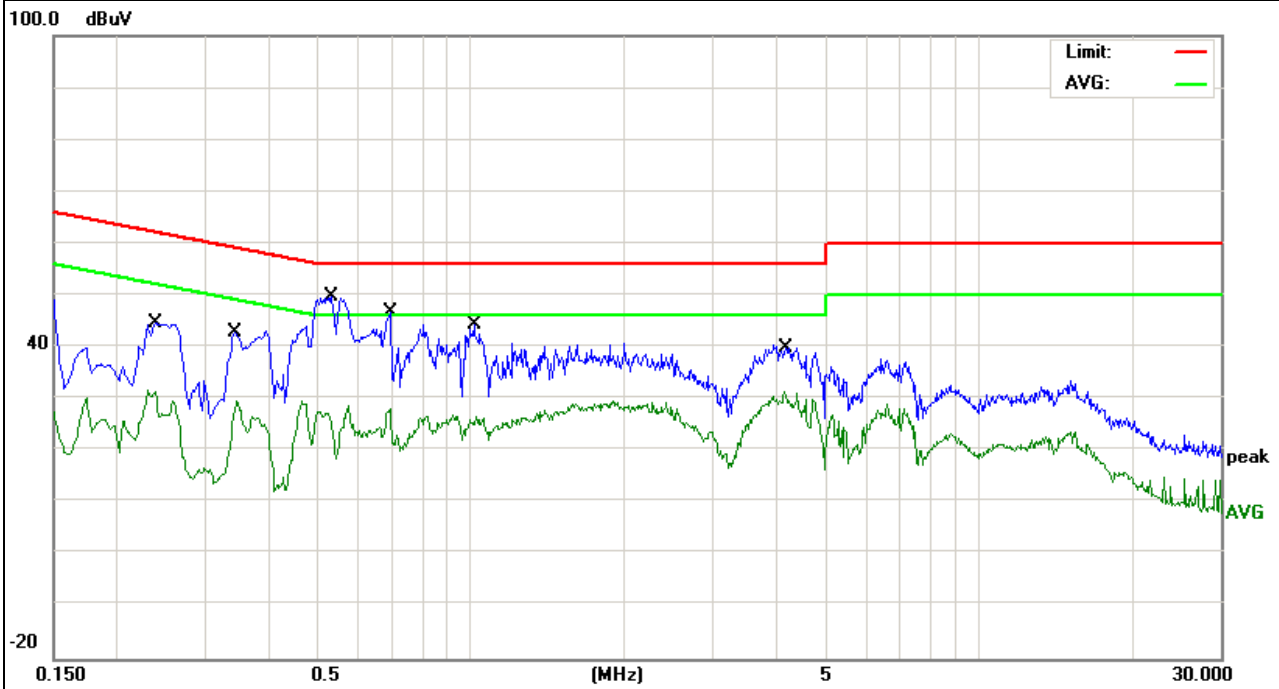

EUT :	Bluetooth Stereo Headset	Model Name :	UB450
Temperature :	26 °C	Relative Humidity :	54%
Pressure :	1010hPa	Phase :	N
Test Voltage :	DC 5.0V from PC AC 120V/60Hz	Test Mode :	Mode 4

Frequency (MHz)	Reading Level (dBμV)	Correct Factor (dB)	Measure-ment (dBμV)	Limits (dBμV)	Margin (dB)	Remark
0.2260	33.26	9.61	42.87	62.59	-19.72	QP
0.2260	21.21	9.61	30.82	52.59	-21.77	AVG
0.3459	32.40	9.63	42.03	59.06	-17.03	QP
0.3459	19.87	9.63	29.50	49.06	-19.56	AVG
0.5180	38.10	9.68	47.78	56.00	-8.22	QP
0.5180	19.44	9.68	29.12	46.00	-16.88	AVG
0.6899	36.16	9.64	45.80	56.00	-10.20	QP
0.6899	20.20	9.64	29.84	46.00	-16.16	AVG
0.9819	34.59	9.61	44.20	56.00	-11.80	QP
0.9819	18.16	9.61	27.77	46.00	-18.23	AVG
4.4419	32.64	9.51	42.15	56.00	-13.85	QP
4.4419	22.91	9.51	32.42	46.00	-13.58	AVG

Remark:

1. All readings are Quasi-Peak and Average values.
2. Factor = Insertion Loss + Cable Loss.

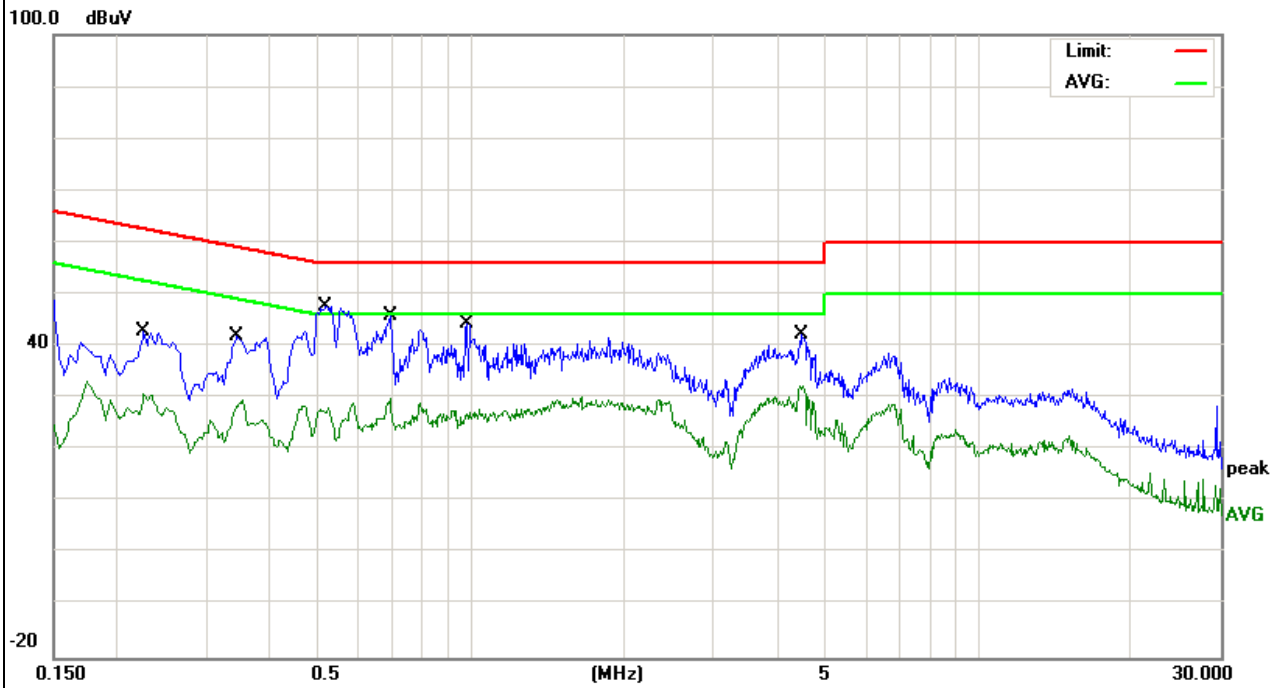

EUT :	Bluetooth Stereo Headset	Model Name :	UB450
Temperature :	26 °C	Relative Humidity :	54%
Pressure :	1010hPa	Phase :	L
Test Voltage :	DC 5.0V from PC AC 240V/60Hz	Test Mode :	Mode 4

Frequency (MHz)	Reading Level (dBμV)	Correct Factor (dB)	Measure-ment (dBμV)	Limits (dBμV)	Margin (dB)	Remark
0.1500	51.46	9.60	61.06	65.99	-4.93	QP
0.1500	30.63	9.60	40.23	55.99	-15.76	AVG
0.2260	34.83	9.61	44.44	62.59	-18.15	QP
0.2260	20.40	9.61	30.01	52.59	-22.58	AVG
0.4699	32.56	9.66	42.22	56.52	-14.30	QP
0.4699	17.95	9.66	27.61	46.52	-18.91	AVG
0.6060	33.21	9.65	42.86	56.00	-13.14	QP
0.6060	18.10	9.65	27.75	46.00	-18.25	AVG
1.0740	32.18	9.60	41.78	56.00	-14.22	QP
1.0740	18.19	9.60	27.79	46.00	-18.21	AVG
4.1538	31.29	9.51	40.80	56.00	-15.20	QP
4.1539	22.57	9.51	32.08	46.00	-13.92	AVG

Remark:

1. All readings are Quasi-Peak and Average values.
2. Factor = Insertion Loss + Cable Loss.

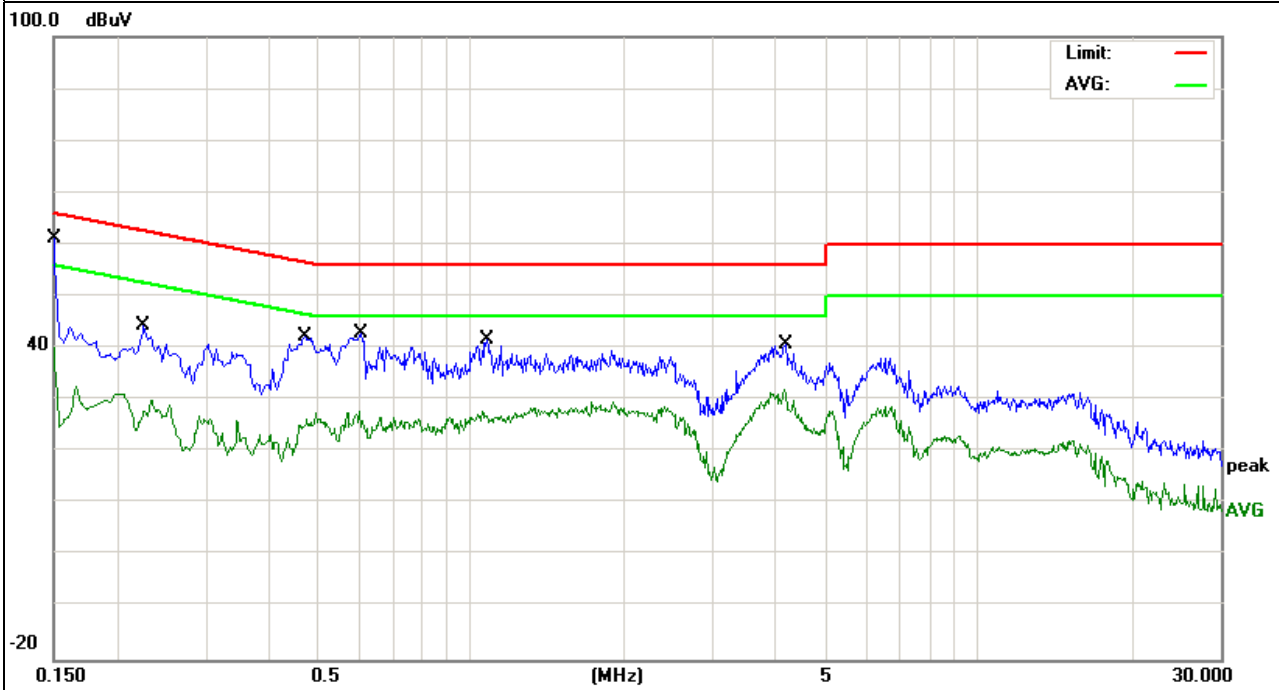

EUT :	Bluetooth Stereo Headset	Model Name :	UB450
Temperature :	26 °C	Relative Humidity :	54%
Pressure :	1010hPa	Phase :	N
Test Voltage :	DC 5.0V from PC AC 240V/60Hz	Test Mode :	Mode 4

Frequency (MHz)	Reading Level (dBμV)	Correct Factor (dB)	Measure-ment (dBμV)	Limits (dBμV)	Margin (dB)	Remark
0.1620	36.30	9.60	45.90	65.36	-19.46	QP
0.1620	23.32	9.60	32.92	55.36	-22.44	AVG
0.2300	35.80	9.61	45.41	62.45	-17.04	QP
0.2300	22.18	9.61	31.79	52.45	-20.66	AVG
0.4900	34.73	9.68	44.41	56.17	-11.76	QP
0.4900	20.75	9.68	30.43	46.17	-15.74	AVG
0.6099	34.49	9.65	44.14	56.00	-11.86	QP
0.6099	17.99	9.65	27.64	46.00	-18.36	AVG
1.2419	31.19	9.59	40.78	56.00	-15.22	QP
1.2419	16.83	9.59	26.42	46.00	-19.58	AVG
4.2618	31.10	9.51	40.61	56.00	-15.39	QP
4.2618	21.77	9.51	31.28	46.00	-14.72	AVG

Remark:

1. All readings are Quasi-Peak and Average values.
2. Factor = Insertion Loss + Cable Loss.

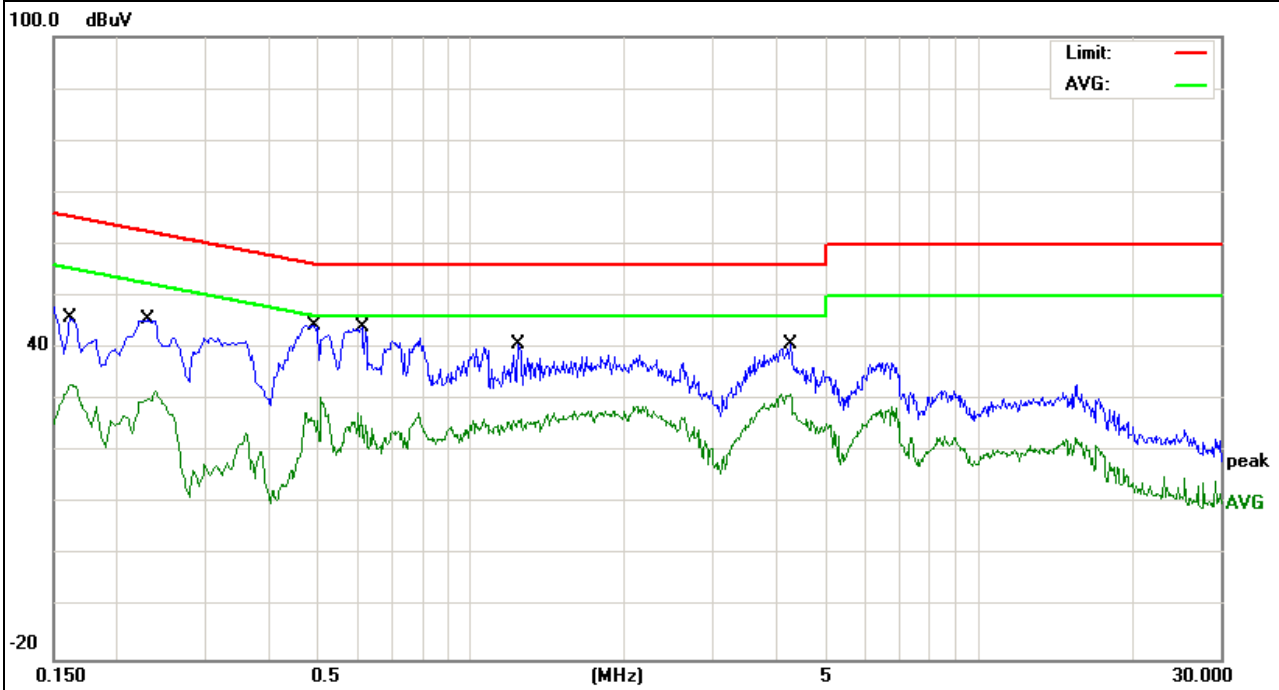

### 3.2 RADIATED EMISSION MEASUREMENT

#### 3.2.1 RADIATED EMISSION LIMITS (Frequency Range 9kHz-1000MHz)

20dBc in any 100 kHz bandwidth outside the operating frequency band. In case the emission fall within the restricted band specified on 15.205(a), then the 15.209(a) limit in the table below has to be followed.

Frequencies (MHz)	Field Strength (micorvolts/meter)	Measurement Distance (meters)
0.009~0.490	2400/F(KHz)	300
0.490~1.705	24000/F(KHz)	30
1.705~30.0	30	30
30~88	100	3
88~216	150	3
216~960	200	3
Above 960	500	3

#### LIMITS OF RADIATED EMISSION MEASUREMENT (Above 1000MHz)

FREQUENCY (MHz)	Class B (dBuV/m) (at 3M)	
	PEAK	AVERAGE
Above 1000	74	54

Notes:

- (1) The limit for radiated test was performed according to FCC PART 15C.
- (2) The tighter limit applies at the band edges.
- (3) Emission level (dBuV/m)=20log Emission level (uV/m).

#### FREQUENCY RANGE OF RADIATED MEASUREMENT (For unintentional radiators)

Highest frequency generated or Upper frequency of measurement used in the device or on which the device operates or tunes (MHz)	Range (MHz)
Below 1.705	30
1.705 – 108	1000
108 – 500	2000
500 – 1000	5000
Above 1000	5 <sup>th</sup> harmonic of the highest frequency or 40 GHz, whichever is lower

Spectrum Parameter	Setting
Attenuation	Auto
Start Frequency	1000 MHz
Stop Frequency	10th carrier harmonic
RB / VB (emission in restricted band)	1 MHz / 1 MHz for Peak, 1 MHz / 10Hz for Average

Receiver Parameter	Setting
Attenuation	Auto
Start ~ Stop Frequency	9kHz~150kHz / RB 200Hz for QP
Start ~ Stop Frequency	150kHz~30MHz / RB 9kHz for QP
Start ~ Stop Frequency	30MHz~1000MHz / RB 120kHz for QP

**3.2.2 TEST PROCEDURE**

- a. The measuring distance of at 3 m shall be used for measurements at frequency up to 1GHz. For frequencies above 1GHz, any suitable measuring distance may be used.
- b. The EUT was placed on the top of a rotating table 0.8 m for below 1GHz and 1.5m for above 1GHz the ground at a 3 meter open area test site. The table was rotated 360 degrees to determine the position of the highest radiation.
- c. The height of the equipment or of the substitution antenna shall be 0.8 m for below 1GHz and 1.5m for above 1GHz; the height of the test antenna shall vary between 1 m to 4 m. Both horizontal and vertical polarizations of the antenna are set to make the measurement.
- d. The initial step in collecting conducted emission data is a spectrum analyzer peak detector mode pre-scanning the measurement frequency range. Significant peaks are then marked and then Quasi Peak detector mode re-measured.
- e. If the Peak Mode measured value compliance with and lower than Quasi Peak Mode Limit, the EUT shall be deemed to meet QP Limits and then no additional QP Mode measurement performed.
- f. For the actual test configuration, please refer to the related Item –EUT Test Photos.

Note:

Both horizontal and vertical antenna polarities were tested and performed pretest to three orthogonal axis. The worst case emissions were reported

During the radiated emission test, the Spectrum Analyzer was set with the following configurations:

Frequency Band (MHz)	Function	Resolution bandwidth	Video Bandwidth
30 to 1000	QP	120 kHz	300 kHz
Above 1000	Peak	1 MHz	1 MHz
	Avg	1 MHz	10 Hz

**3.2.3 DEVIATION FROM TEST STANDARD**

No deviation



### 3.2.4 TEST SETUP

(A) Radiated Emission Test-Up Frequency Below 30MHz

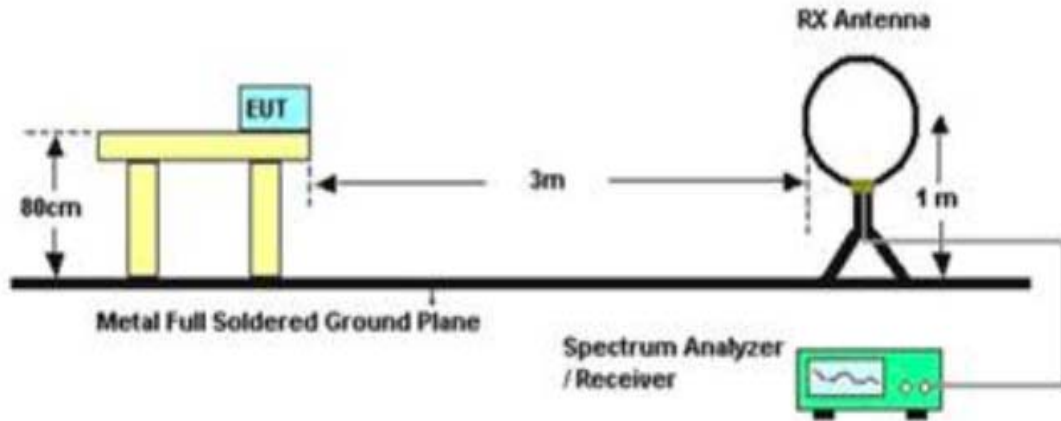

(B) Radiated Emission Test-Up Frequency 30MHz~1GHz

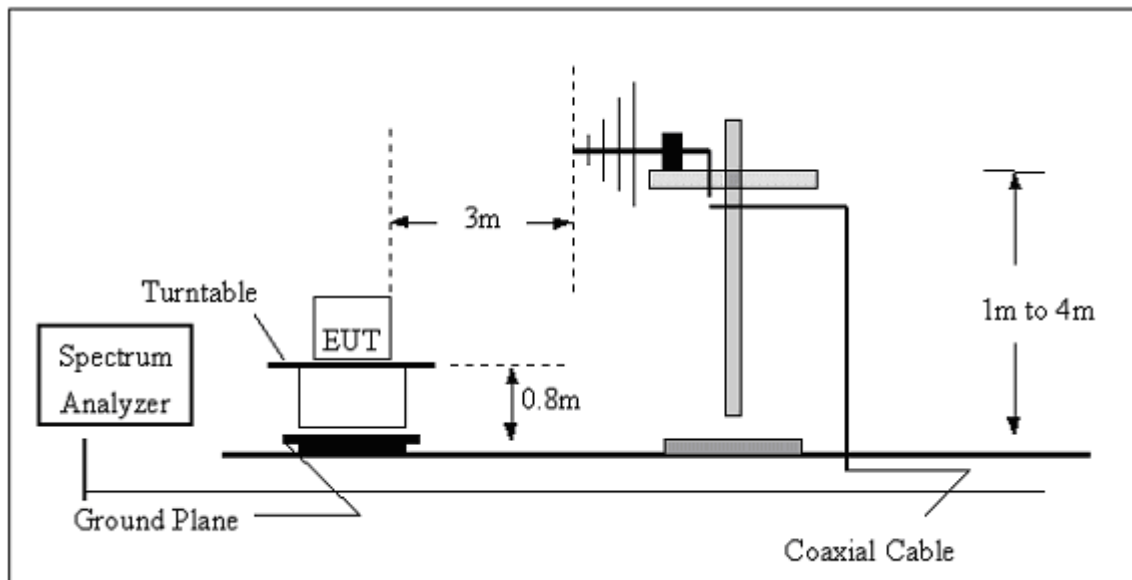

(C) Radiated Emission Test-Up Frequency Above 1GHz

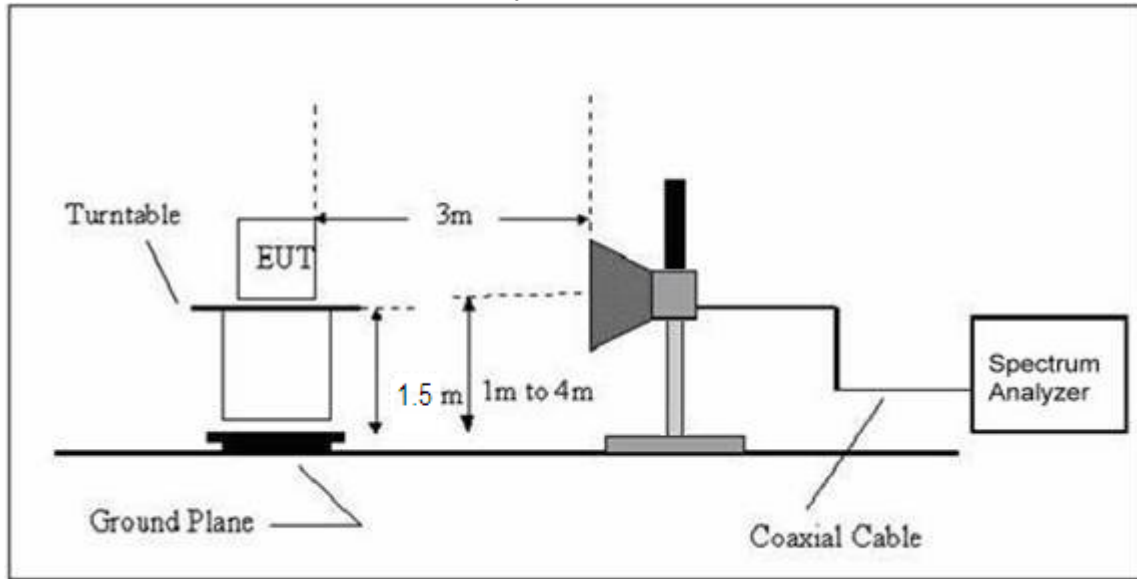

**3.2.5 EUT OPERATING CONDITIONS**

The EUT tested system was configured as the statements of 2.4 Unless otherwise a special operating condition is specified in the follows during the testing.

**3.2.6 TEST RESULTS (BELOW 30 MHZ)**

EUT :	Bluetooth Stereo Headset	Model Name :	UB450
Temperature :	20 °C	Relative Humidity :	48%
Pressure :	1010 hPa	Test Voltage :	DC 3.7V
Test Mode :	TX	Polarization :	---

Freq.	Reading	Limit	Margin	State
(MHz)	(dBuV/m)	(dBuV/m)	(dB)	P/F
--	--	--	--	P
--	--	--	--	P

**NOTE:**

The amplitude of spurious emissions which are attenuated by more than 20dB below the permissible value has no need to be reported.

Distance extrapolation factor =  $20 \log (\text{specific distance}/\text{test distance})$ (dB);

Limit line = specific limits(dBuV) + distance extrapolation factor.

### 3.2.7 TEST RESULTS (BETWEEN 30M – 1000 MHZ)

EUT :	Bluetooth Stereo Headset	Model Name :	UB450
Temperature :	20 °C	Relative Humidity :	48%
Pressure :	1010hPa	Test Mode :	TX-
Test Voltage :	DC 3.7V		

Polar (H/V)	Frequency	Meter Reading	Factor	Emission Level	Limits	Margin	Remark
	(MHz)	(dBuV)	(dB)	(dBuV/m)	(dBuV/m)	(dB)	
V	30.9618	9.18	19.22	28.40	40.00	-11.60	QP
V	36.8952	9.59	16.41	26.00	40.00	-14.00	QP
V	50.7637	14.98	9.32	24.30	40.00	-15.70	QP
V	59.0251	14.19	6.16	20.35	40.00	-19.65	QP
V	140.8351	15.15	11.05	26.20	43.50	-17.30	QP
V	180.0165	19.49	11.91	31.40	43.50	-12.10	QP

**Remark:**

Absolute Level= ReadingLevel+ Factor, Margin= Absolute Level - Limit

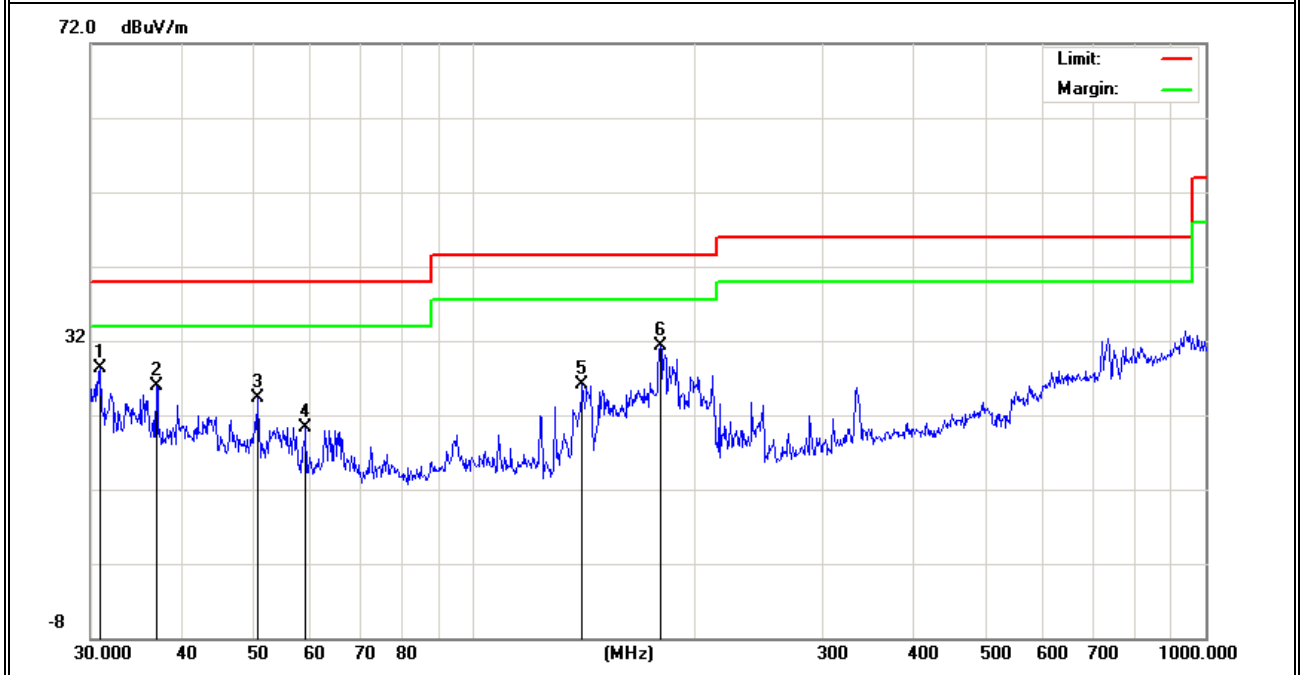

Polar (H/V)	Frequency	Meter Reading	Factor	Emission Level	Limits	Margin	Remark
	(MHz)	(dBuV)	(dB)	(dBuV/m)	(dBuV/m)	(dB)	
H	31.6202	7.20	18.99	26.19	40.00	-13.81	peak
H	47.4917	13.51	10.06	23.57	40.00	-16.43	peak
H	78.4133	18.31	9.39	27.70	40.00	-12.30	peak
H	139.3610	22.18	11.01	33.19	43.50	-10.31	peak
H	183.8437	26.94	11.84	38.78	43.50	-4.72	peak
H	322.1886	23.62	13.31	36.93	46.00	-9.07	peak

**Remark:**

Absolute Level= ReadingLevel+ Factor, Margin= Absolute Level - Limit

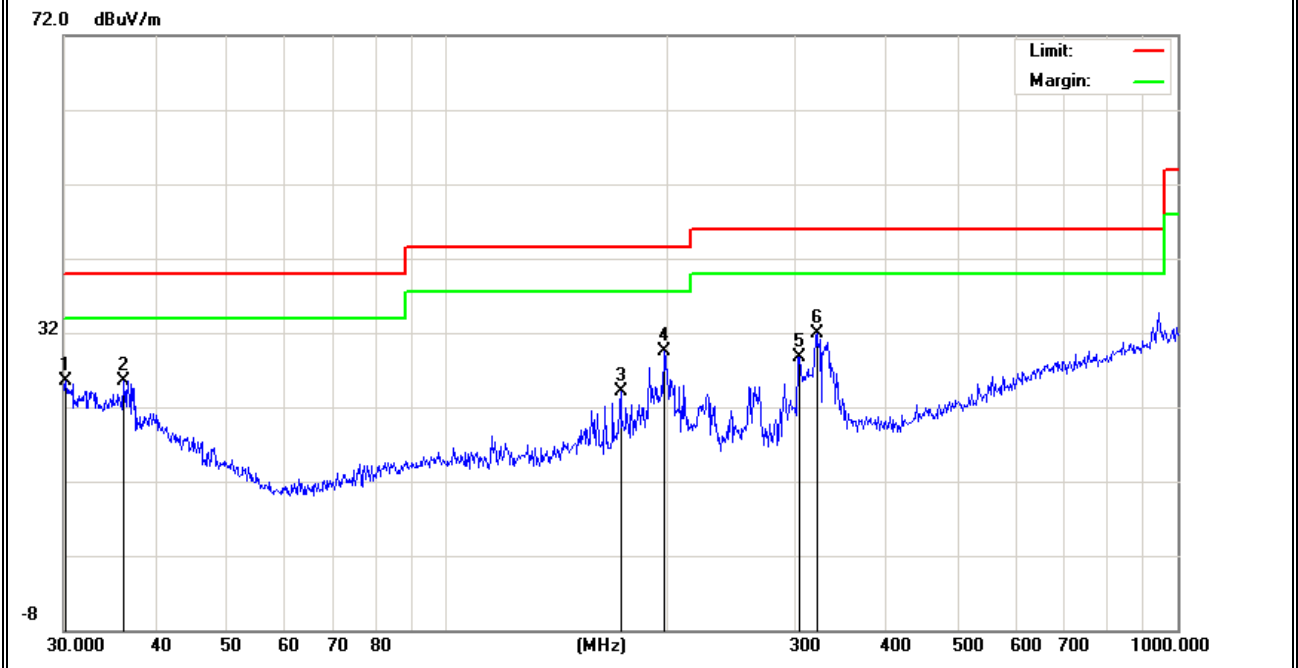

Note: Mode 1Mbps(High CH) is the worst mode.

### 3.2.8 TEST RESULTS (ABOVE 1000 MHZ)

EUT :	Bluetooth Stereo Headset	Model Name :	UB450
Temperature :	20 °C	Relative Humidity :	48%
Pressure :	1010hPa	Test Mode :	TX
Test Mode :	DC 3.7V		

Frequency (MHz)	Meter Reading (dBµV)	Factor (dB)	Emission Level (dBµV/m)	Limits (dBµV/m)	Margin (dB)	Remark	Comment
Low Channel (2402 MHz)-Above 1G							
4805.135	60.25	-3.64	56.02	74.00	-17.98	Pk	Vertical
4805.135	42.51	-3.64	39.11	54.00	-14.89	AV	Vertical
7205.321	53.42	-0.95	51.69	74.00	-22.31	Pk	Vertical
7205.321	38.46	-0.95	37.02	54.00	-16.98	AV	Vertical
4805.265	60.62	-3.64	55.58	74.00	-18.42	Pk	Horizontal
4805.265	42.46	-3.64	37.25	54.00	-16.75	AV	Horizontal
7206.524	55.11	-0.95	54.36	74.00	-19.64	Pk	Horizontal
7206.524	38.38	-0.95	38.02	54.00	-15.98	AV	Horizontal
Mid Channel (2441 MHz)-Above 1G							
4881.125	61.23	-3.68	56.12	74.00	-17.88	Pk	Vertical
4881.125	41.74	-3.68	38.25	54.00	-15.75	AV	Vertical
7230.552	57.76	-0.82	57.02	74.00	-16.98	Pk	Vertical
7230.552	42.51	-0.82	43.11	54.00	-10.89	AV	Vertical
4883.251	60.23	-3.68	56.45	74.00	-17.55	Pk	Horizontal
4883.251	41.41	-3.68	36.58	54.00	-17.42	AV	Horizontal
7233.521	57.61	-0.82	57.22	74.00	-16.78	Pk	Horizontal
7233.521	41.81	-0.82	39.15	54.00	-14.85	AV	Horizontal
High Channel (2480 MHz)- Above 1G							
4961.023	60.54	-3.59	57.11	74.00	-16.89	Pk	Vertical
4961.023	43.59	-3.59	41.02	54.00	-12.98	AV	Vertical
7441.577	54.92	-0.68	55.12	74.00	-18.88	Pk	Vertical
7441.577	39.14	-0.68	39.11	54.00	-14.89	AV	Vertical
4966.328	59.26	-3.59	54.69	74.00	-19.31	Pk	Horizontal
4966.328	41.48	-3.59	36.47	54.00	-17.53	AV	Horizontal
7443.581	54.87	-0.68	55.25	74.00	-18.75	Pk	Horizontal
7443.581	38.95	-0.68	37.02	54.00	-16.98	AV	Horizontal

Note: Mode 1Mbps is the worst mode.

**4. NUMBER OF HOPPING CHANNEL**

**4.1 APPLIED PROCEDURES / LIMIT**

FCC Part15 (15.247) , Subpart C				
Section	Test Item	Limit	Frequency Range (MHz)	Result
15.247 (a)(1)(iii)	Number of Hopping Channel	≥15	2400-2483.5	PASS

Spectrum Parameters	Setting
Attenuation	Auto
Span Frequency	= the frequency band of operation
RB	RBW=100kHz
VB	VBW ≥ RBW
Detector	Peak
Trace	Max Hold
Sweep Time	Auto

**4.1.1 TEST PROCEDURE**

- a. The EUT was directly connected to the spectrum analyzer and antenna output port as show in the block diagram below,
- b. Spectrum Setting : RBW= 100kHz, VBW=100kHz, Sweep time = Auto.

**4.1.2 DEVIATION FROM STANDARD**

No deviation.

**4.1.3 TEST SETUP**



**4.1.4 EUT OPERATION CONDITIONS**

The EUT tested system was configured as the statements of 2.4 Unless otherwise a special operating condition is specified in the follows during the testing.

### 4.1.5 TEST RESULTS

EUT :	Bluetooth Stereo Headset	Model Name :	UB450
Temperature :	25 °C	Relative Humidity :	60%
Pressure :	1015 hPa	Test Voltage :	DC 3.7V
Test Mode :	Hopping Mode-GFSK		

Number of Hopping Channel	79
---------------------------	----

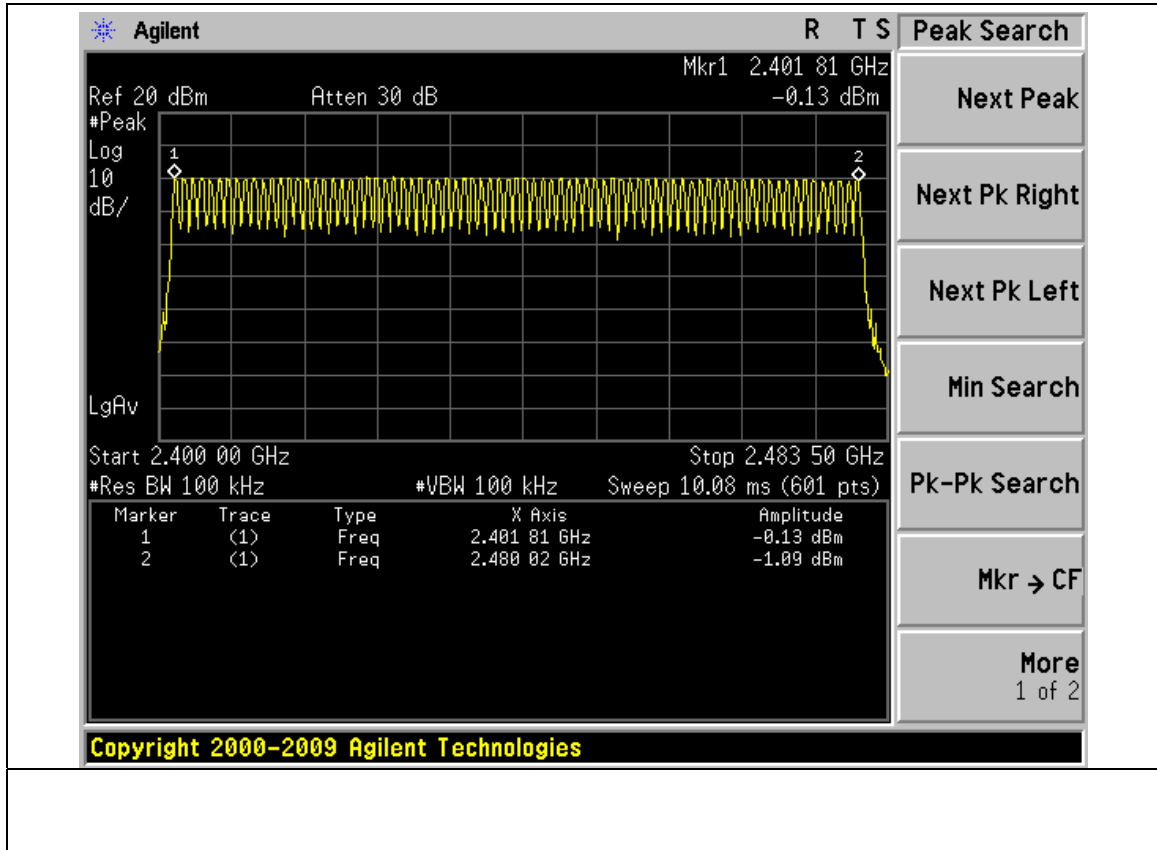



## 5. AVERAGE TIME OF OCCUPANCY

### 5.1 APPLIED PROCEDURES / LIMIT

FCC Part15 (15.247) , Subpart C				
Section	Test Item	Limit	Frequency Range (MHz)	Result
15.247 (a)(1)(iii)	Average Time of Occupancy	0.4sec	2400-2483.5	PASS

#### 5.1.1 TEST PROCEDURE

- a. The transmitter output (antenna port) was connected to the spectrum analyzer
- b. Set RBW of spectrum analyzer to 1MHz and VBW to 1MHz.
- c. Use a video trigger with the trigger level set to enable triggering only on full pulses.
- d. Sweep Time is more than once pulse time.
- e. Set the center frequency on any frequency would be measure and set the frequency span to zero span.
- f. Measure the maximum time duration of one single pulse.
- g. Set the EUT for DH5, DH3 and DH1 packet transmitting.
- h. Measure the maximum time duration of one single pulse.
- i. A Period Time = (channel number)\*0.4
  - DH1 Time Slot: Reading \* (1600/2)\*31.6/(channel number)
  - DH3 Time Slot: Reading \* (1600/4)\*31.6/(channel number)
  - DH5 Time Slot: Reading \* (1600/6)\*31.6/(channel number)

#### 5.1.2 DEVIATION FROM STANDARD

No deviation.

### 5.1.3 TEST SETUP

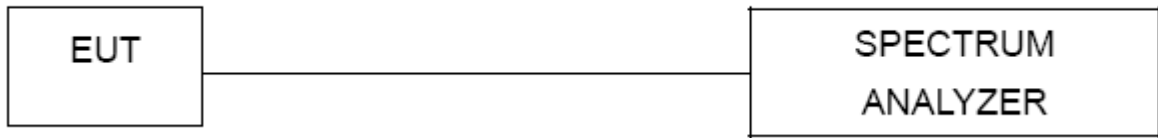

### 5.1.4 EUT OPERATION CONDITIONS

The EUT tested system was configured as the statements of 2.4 Unless otherwise a special operating condition is specified in the follows during the testing.

### 5.1.5 TEST RESULTS

EUT :	Bluetooth Stereo Headset	Model Name :	UB450
Temperature :	25 °C	Relative Humidity :	60%
Pressure :	1012 hPa	Test Voltage :	DC 3.7V
Test Mode :	CH39-DH5 ,2DH5,3DH5		

Data Packet	Frequency	Pulse Duration	Dwell Time	Limits
		(ms)	(s)	(s)
DH5	2441 MHz	3.01	0.32	0.4
2DH5	2441 MHz	3.01	0.32	0.4
3DH5	2441 MHz	2.97	0.32	0.4

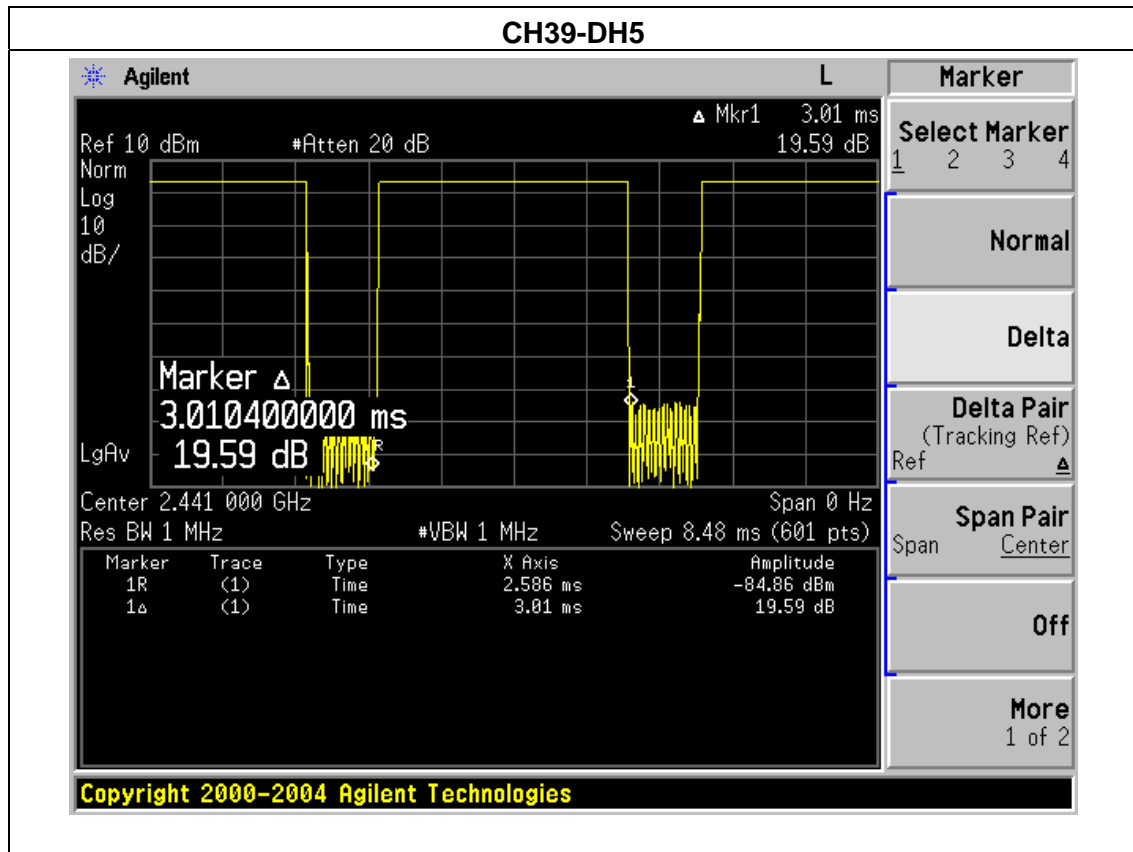

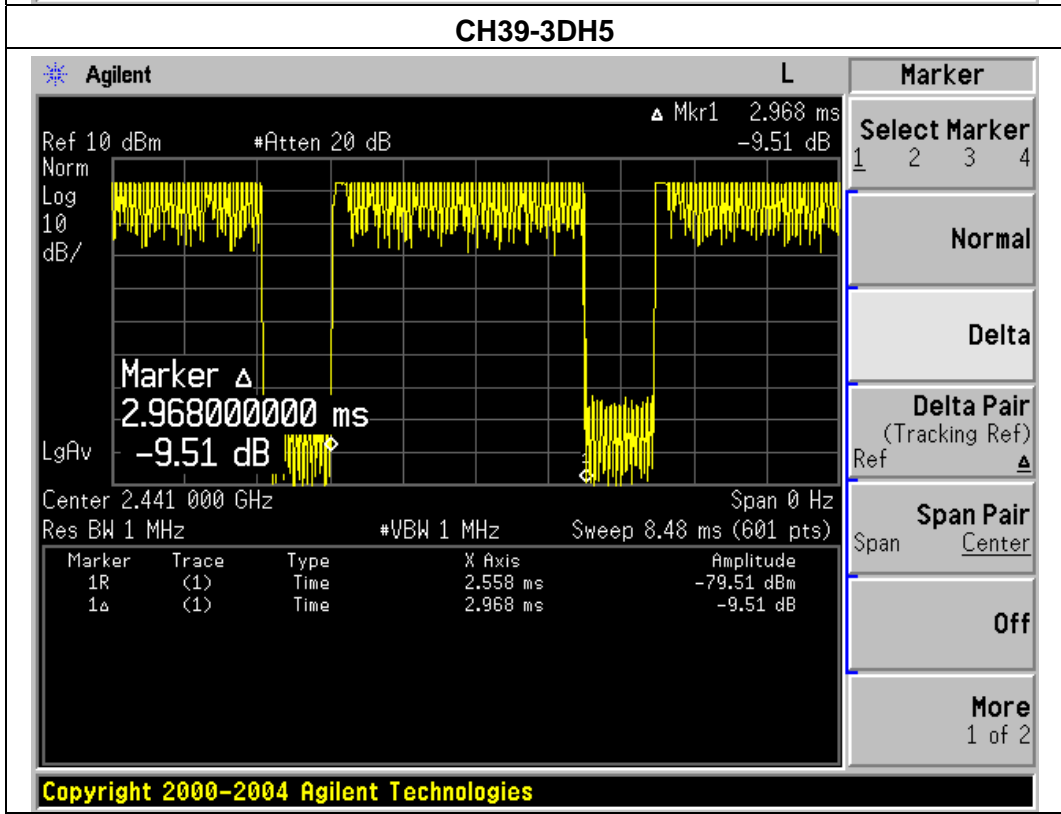
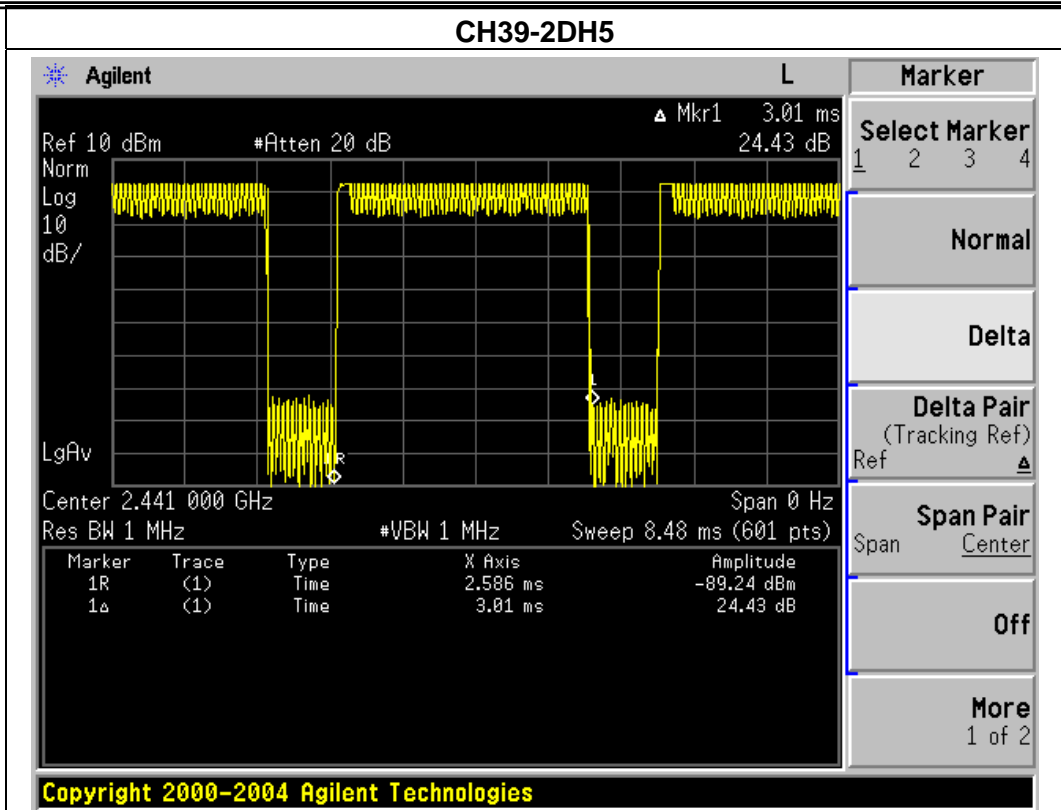

EUT :	Bluetooth Stereo Headset	Model Name :	UB450
Temperature :	25 °C	Relative Humidity :	60%
Pressure :	1012 hPa	Test Voltage :	DC 3.7V
Test Mode :	CH39-DH3,2DH3,3DH3		

Data Packet	Frequency	Pulse Duration	Dwell Time	Limits
		(ms)	(s)	(s)
DH3	2441 MHz	1.72	0.28	0.4
2DH3	2441 MHz	1.75	0.28	0.4
3DH3	2441 MHz	1.75	0.28	0.4

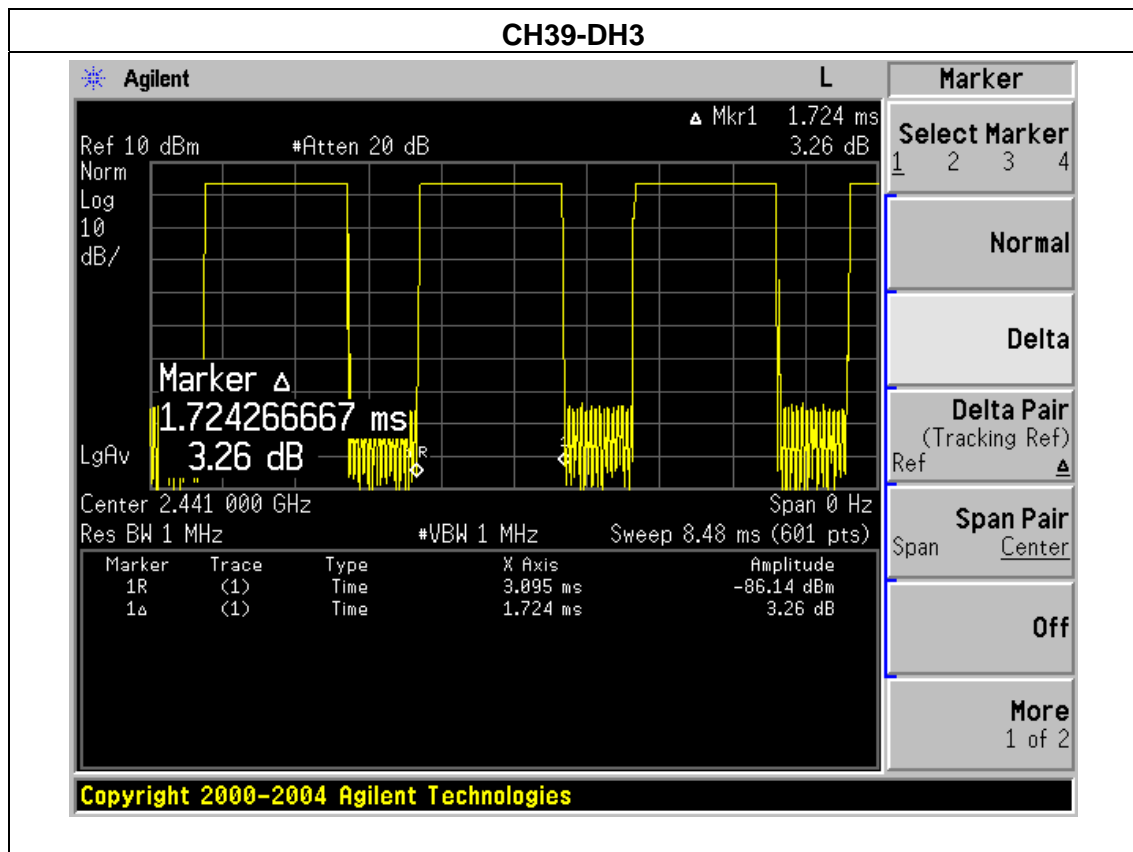

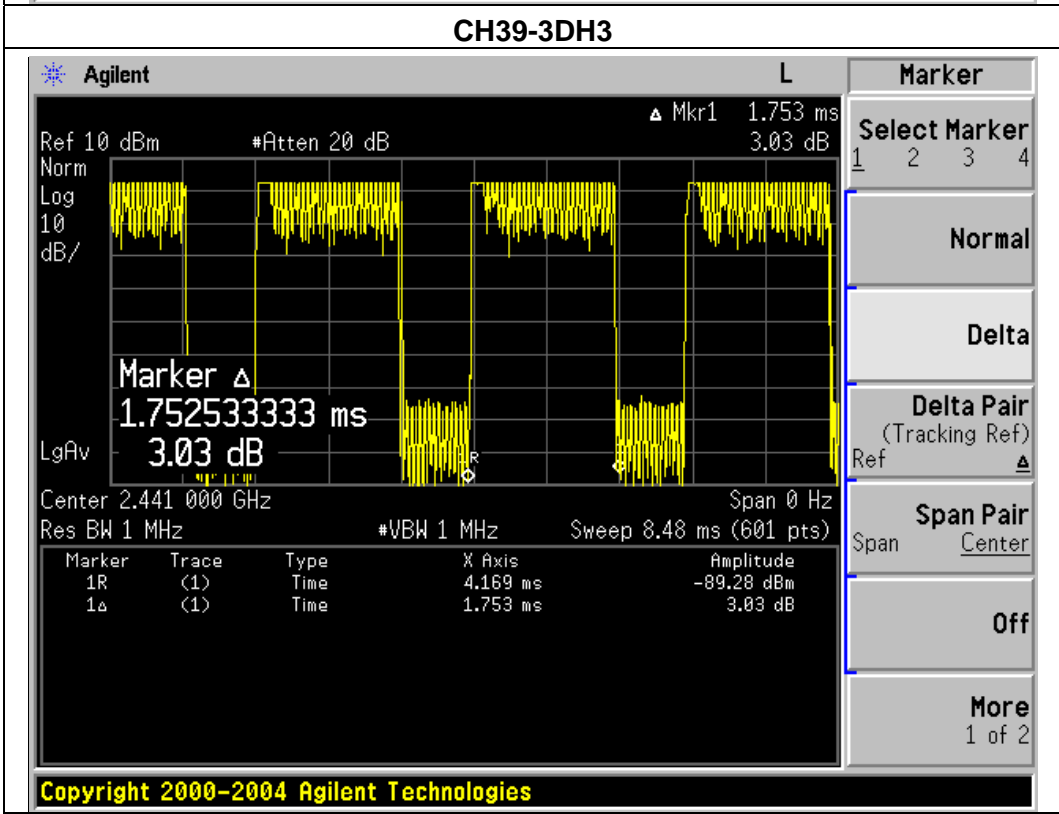
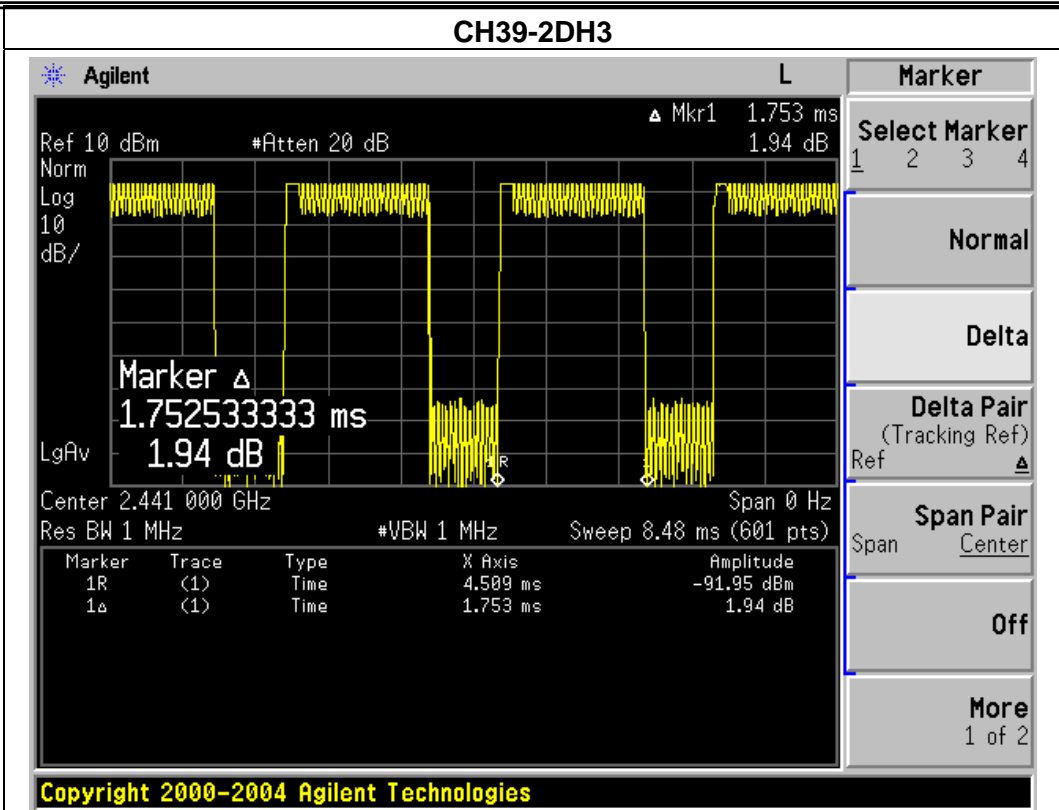

EUT :	Bluetooth Stereo Headset	Model Name :	UB450
Temperature :	25 °C	Relative Humidity :	60%
Pressure :	1012 hPa	Test Voltage :	DC 3.7V
Test Mode :	CH39-DH1,2DH1,3DH1		

Data Packet	Frequency	Pulse Duration	Dwell Time	Limits
		(ms)	(s)	(s)
DH1	2441 MHz	0.45	0.14	0.4
2DH1	2441 MHz	0.47	0.15	0.4
3DH1	2441 MHz	0.47	0.15	0.4

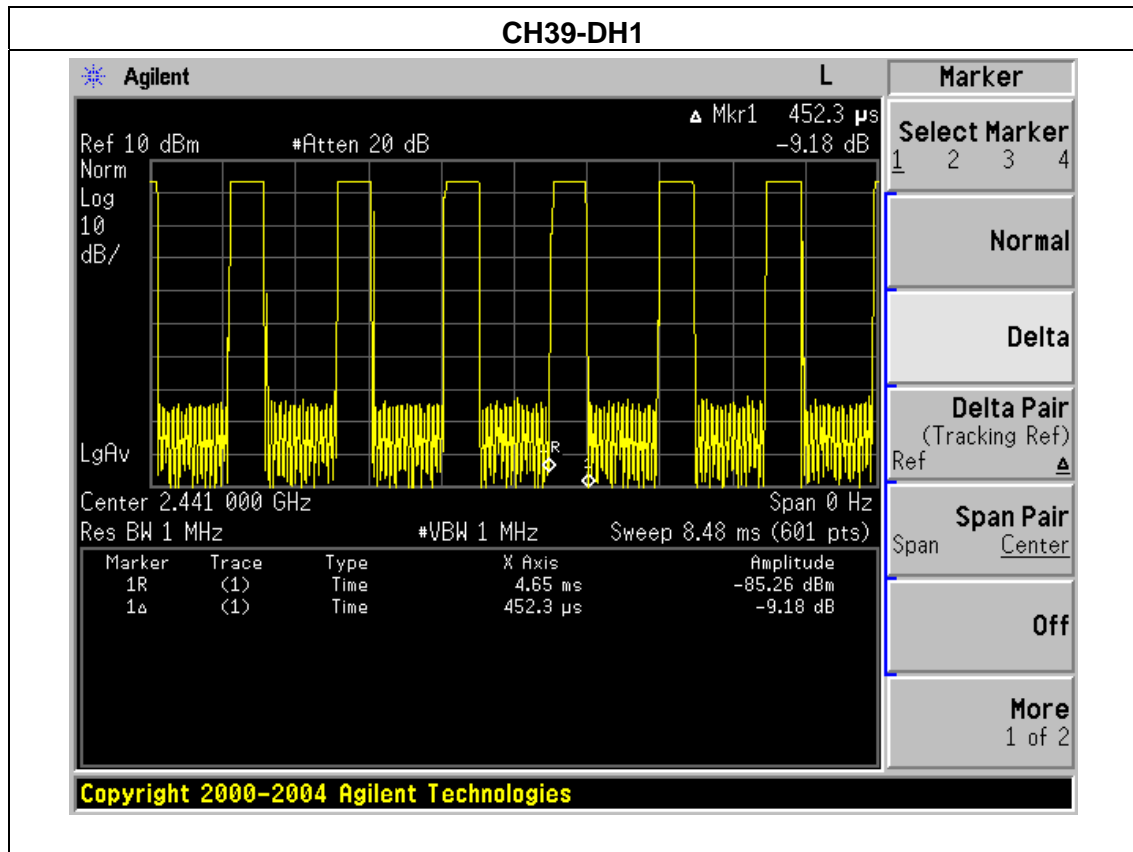

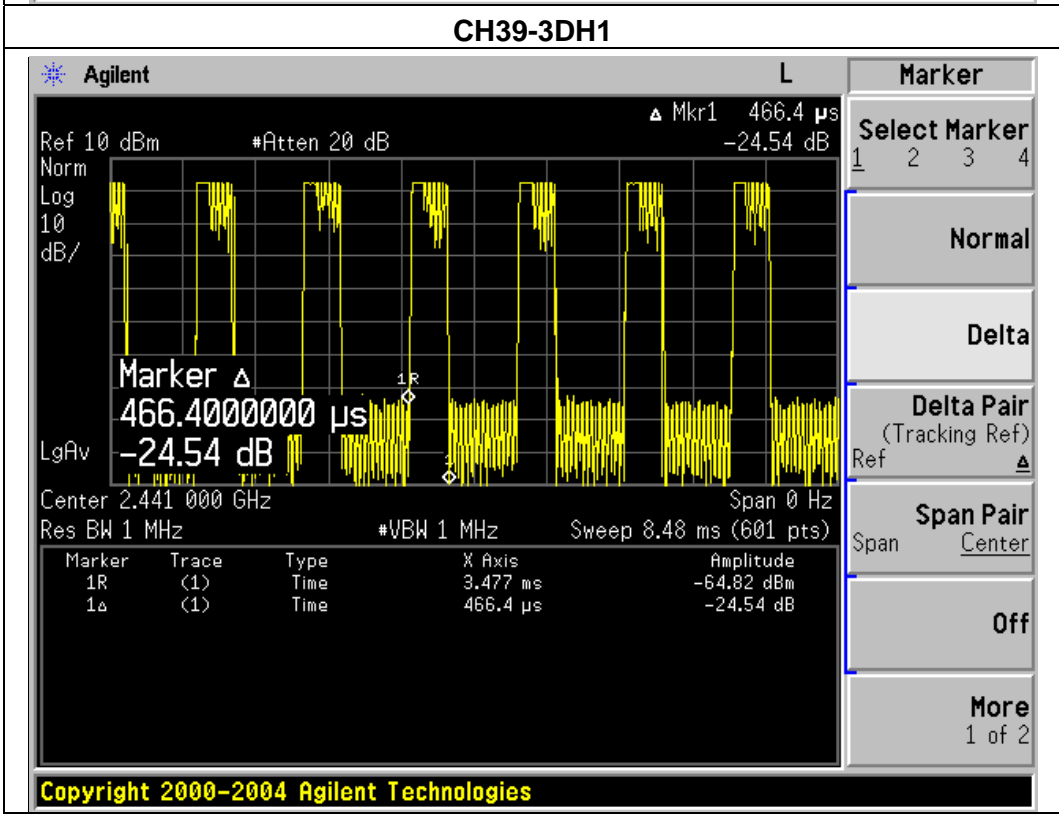
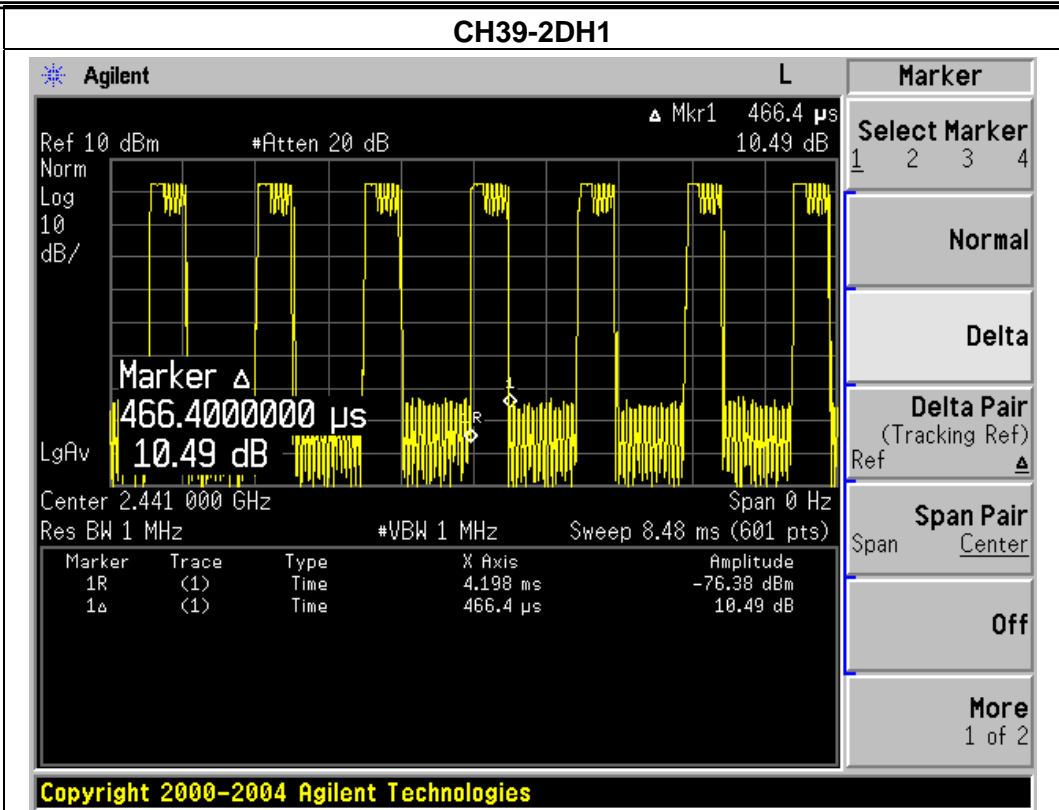



## 6. HOPPING CHANNEL SEPARATION MEASUREMENT

### 6.1 APPLIED PROCEDURES / LIMIT

Frequency hopping systems operating in the 2400-2483.5 MHz band may have hopping channel carrier frequencies that are separated by 25 kHz or two-thirds of the 20 dB bandwidth of the hopping channel, whichever is greater.

Spectrum Parameter	Setting
Attenuation	Auto
Span Frequency	> Measurement Bandwidth or Channel Separation
RB	30 kHz (Channel Separation)
VB	100 kHz (Channel Separation)
Detector	Peak
Trace	Max Hold
Sweep Time	Auto

#### 6.1.1 TEST PROCEDURE

- a. The transmitter output (antenna port) was connected to the spectrum analyser in peak hold mode.
- b. The resolution bandwidth of 30 kHz and the video bandwidth of 100 kHz were utilised for channel separation measurement.

#### 6.1.2 DEVIATION FROM STANDARD

No deviation.

#### 6.1.3 TEST SETUP

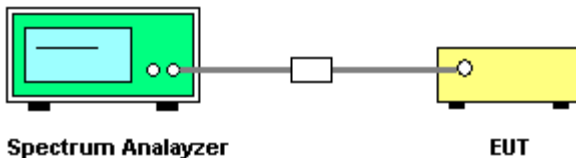

#### 6.1.4 EUT OPERATION CONDITIONS

The EUT was programmed to be in continuously transmitting mode.

### 6.1.5 TEST RESULTS

EUT :	Bluetooth Stereo Headset	Model Name :	UB450
Temperature :	25 °C	Relative Humidity :	60%
Pressure :	1012 hPa	Test Voltage :	DC 3.7V
Test Mode :	CH00 / CH39 /CH78 (1Mbps Mode)		

Frequency	Ch. Separation (MHz)	Result
2402 MHz	1.000	Complies
2441 MHz	1.000	Complies
2480 MHz	1.000	Complies

Ch. Separation Limits: > 20dB bandwidth

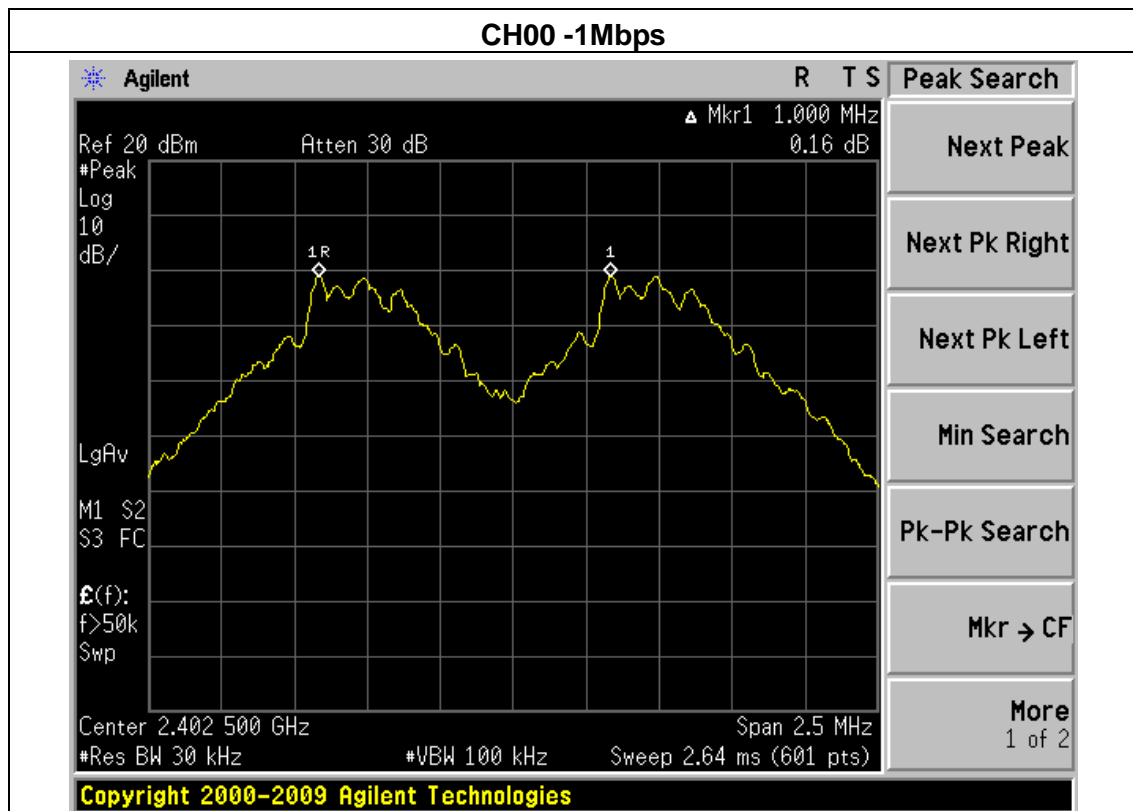

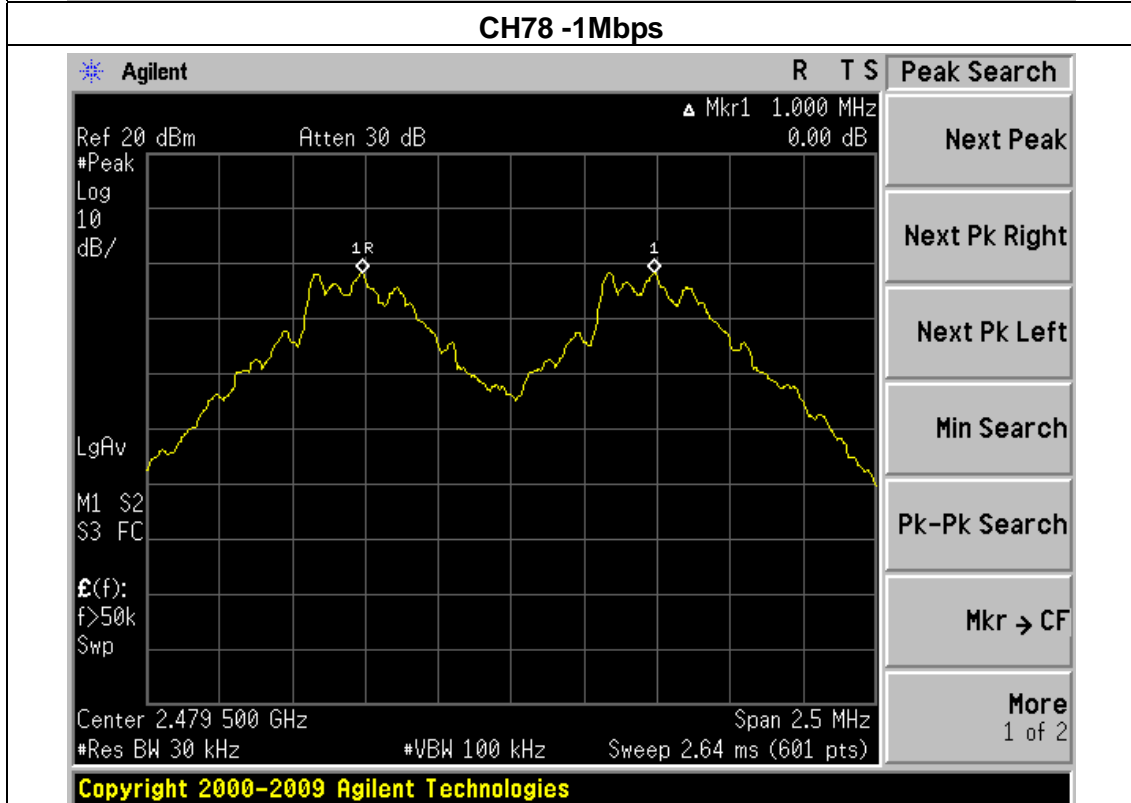
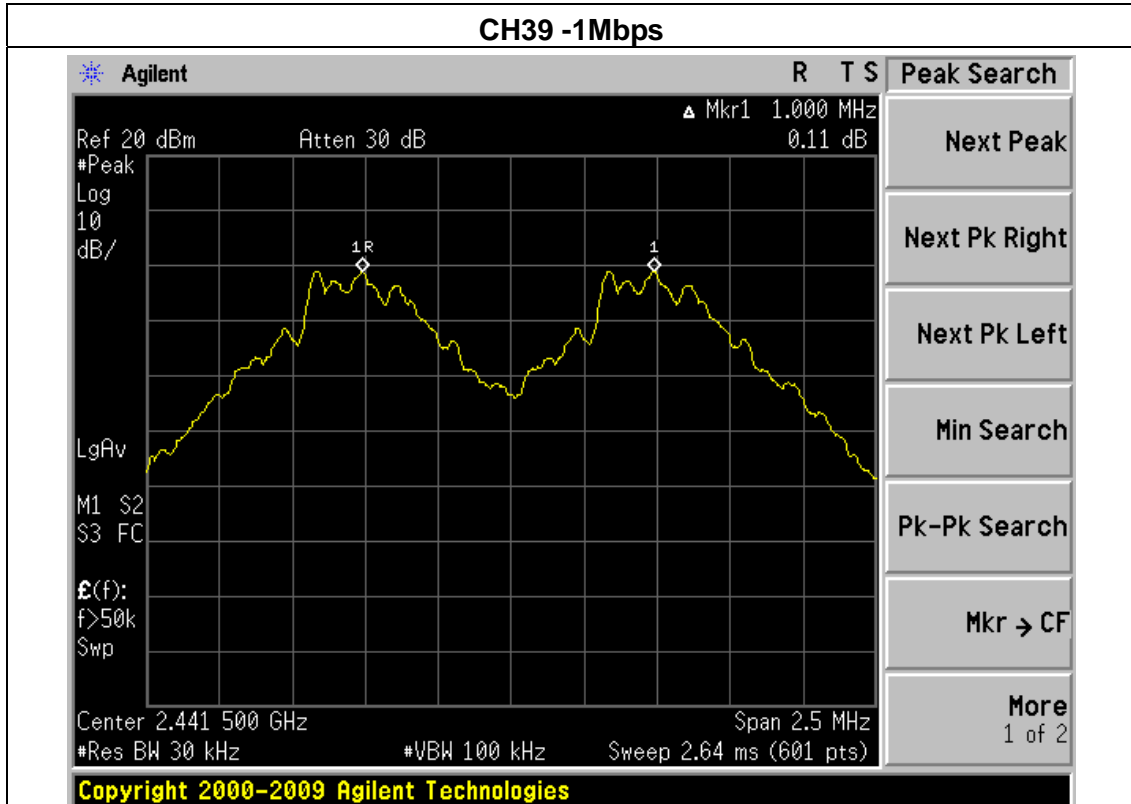

EUT :	Bluetooth Stereo Headset	Model Name :	UB450
Temperature :	25 °C	Relative Humidity :	60%
Pressure :	1012 hPa	Test Voltage :	DC 3.7V
Test Mode :	CH00 / CH39 /CH78 (2Mbps Mode)		

Frequency	Ch. Separation (MHz)	Result
2402 MHz	1.004	<b>Complies</b>
2441 MHz	1.000	<b>Complies</b>
2480 MHz	1.000	<b>Complies</b>

**Ch. Separation Limits: >2/3 of 20dB bandwidth**

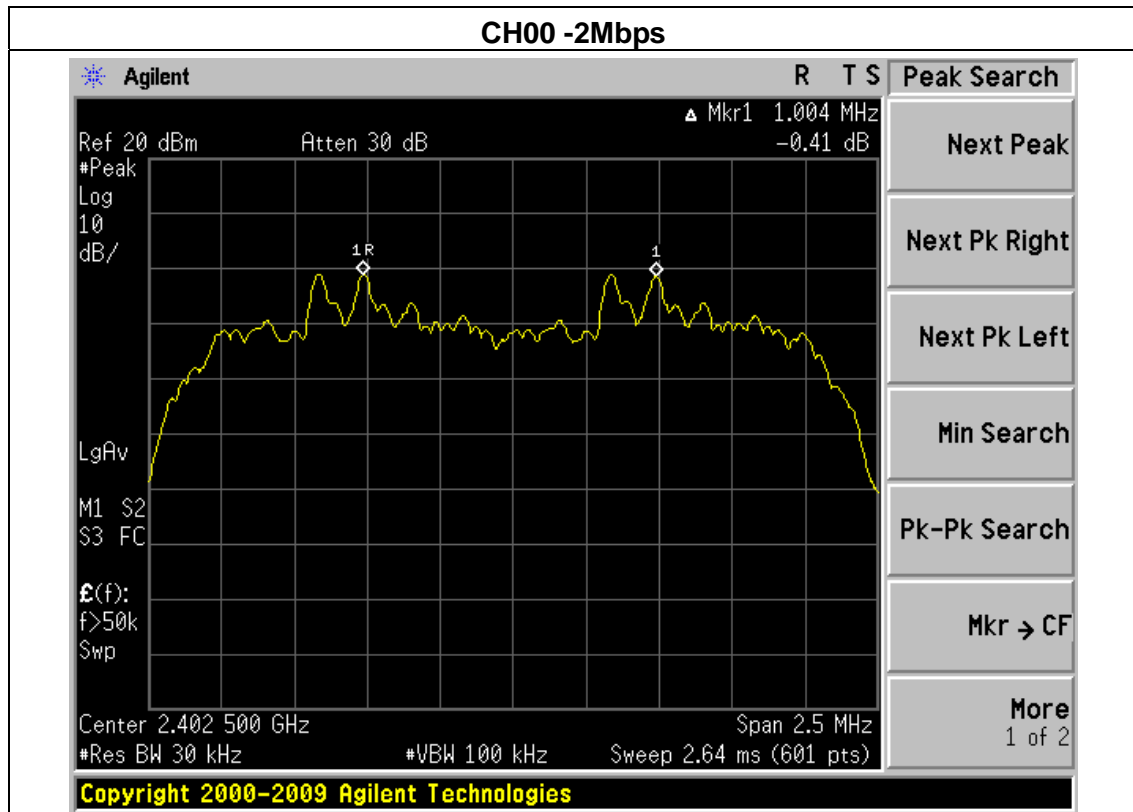

### CH39 -2Mbps

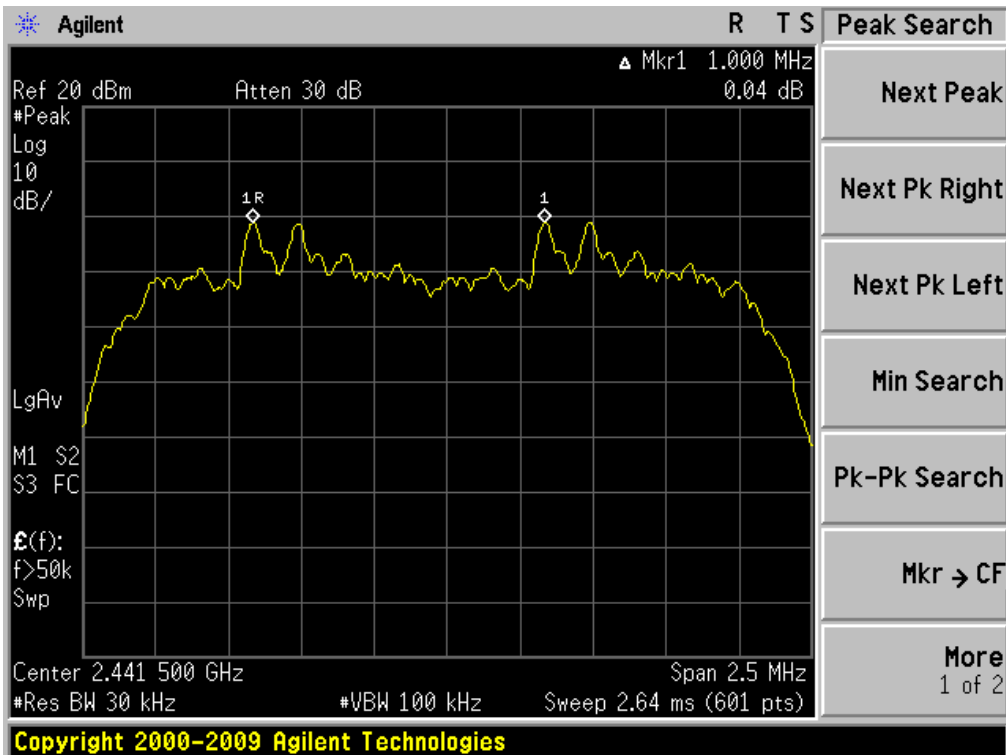

### CH78 -2Mbps

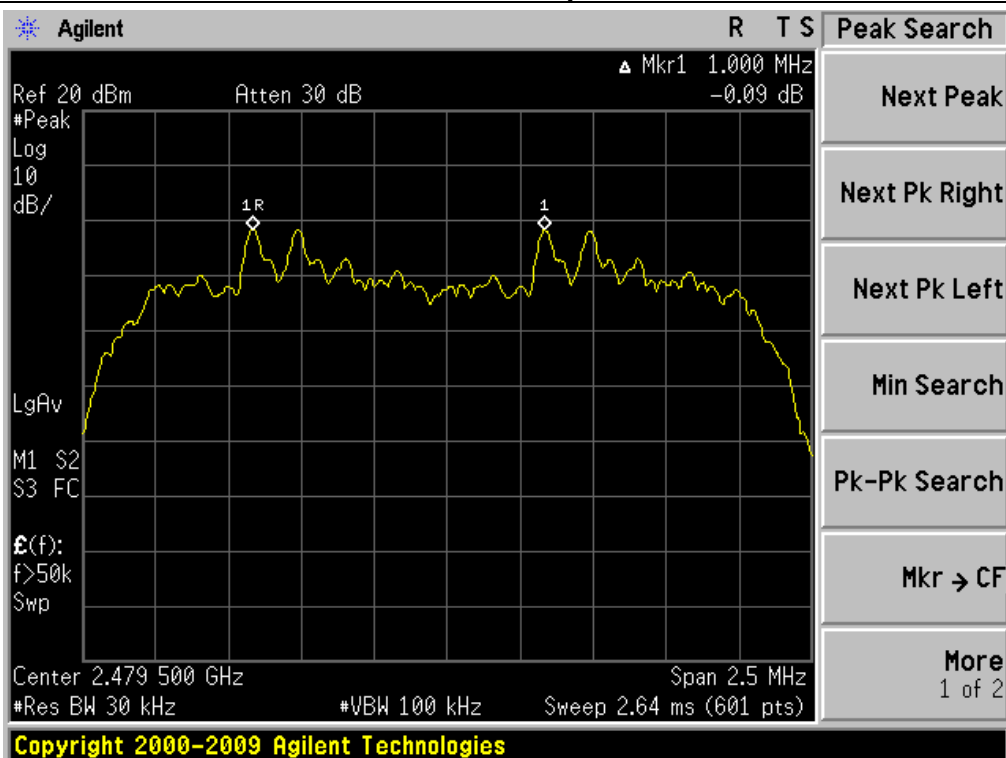

EUT :	Bluetooth Stereo Headset	Model Name :	UB450
Temperature :	25 °C	Relative Humidity :	60%
Pressure :	1012 hPa	Test Voltage :	DC 3.7V
Test Mode :	CH00 / CH39 /CH78 (3Mbps Mode)		

Frequency	Ch. Separation (MHz)	Result
2402 MHz	1.000	<b>Complies</b>
2441 MHz	1.004	<b>Complies</b>
2480 MHz	1.004	<b>Complies</b>

**Ch. Separation Limits: >2/3 of 20dB bandwidth**

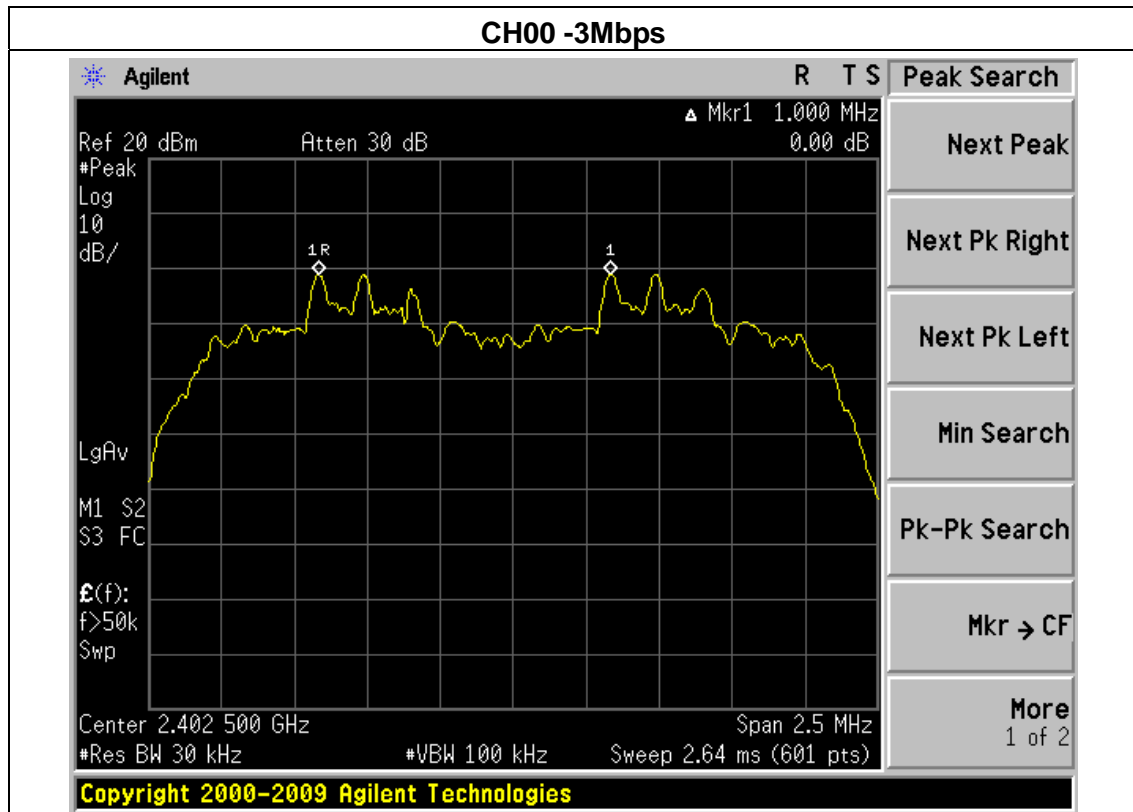

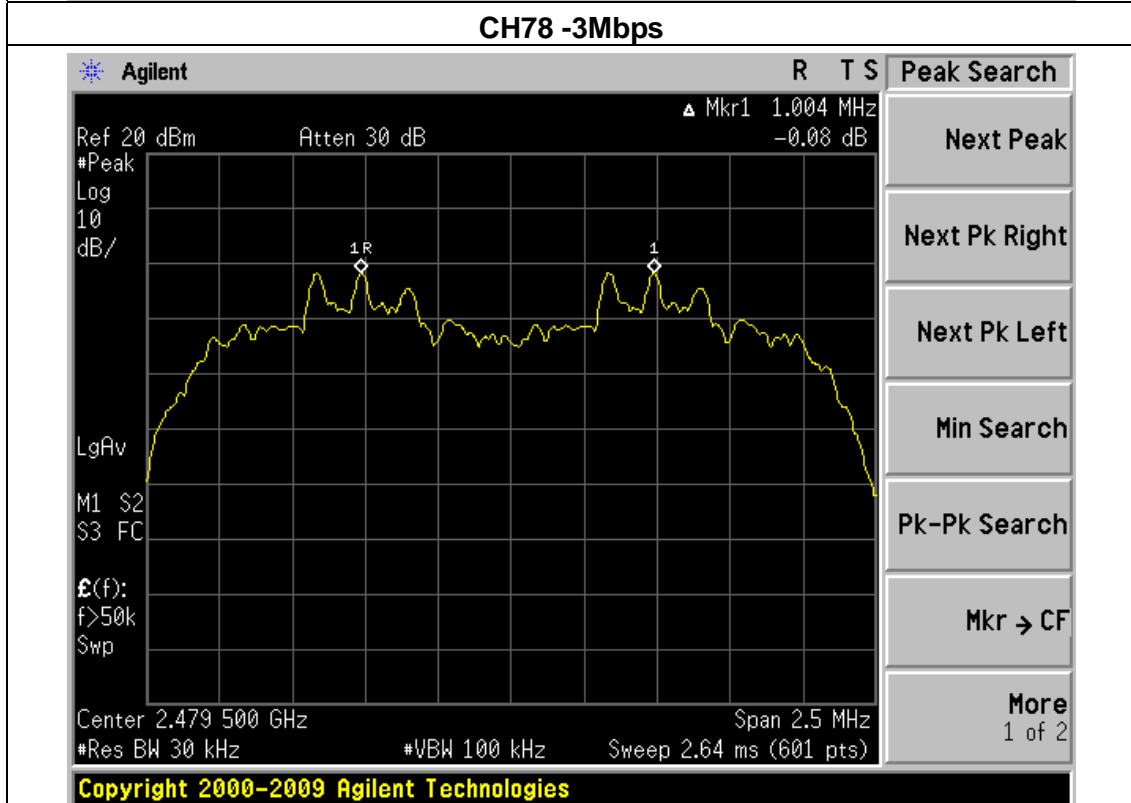
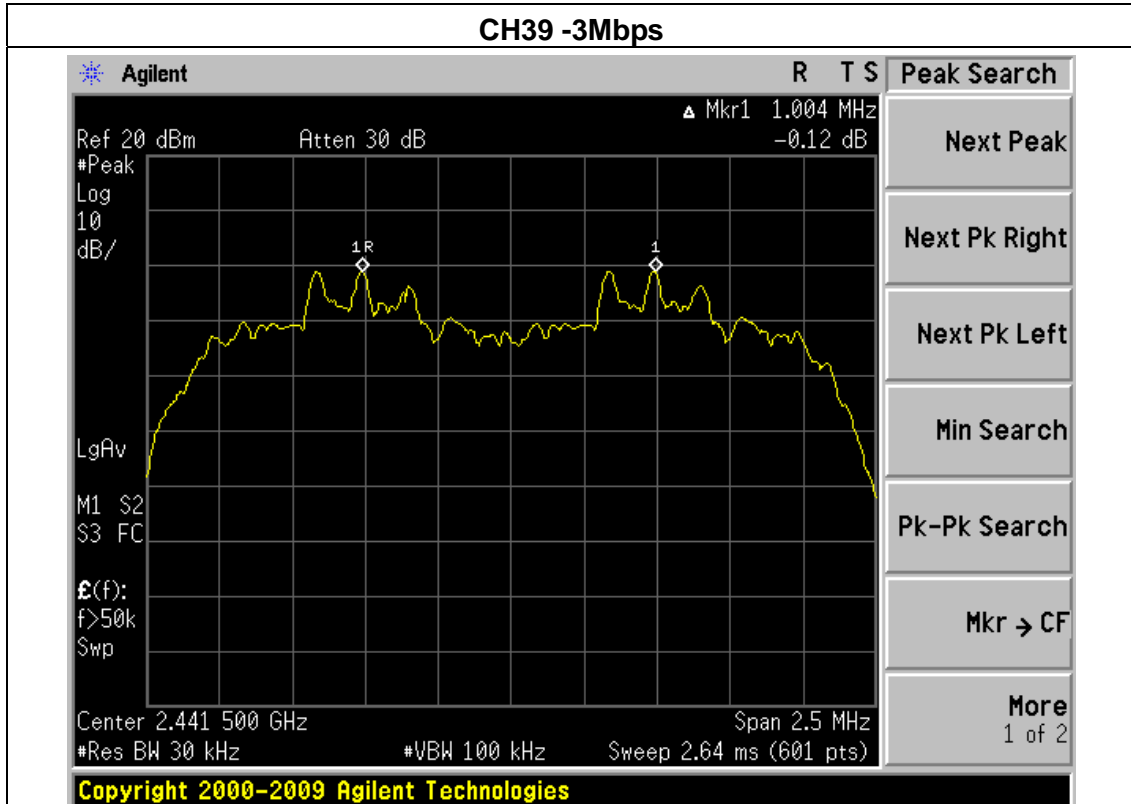

## 7. BANDWIDTH TEST

### 7.1 APPLIED PROCEDURES / LIMIT

FCC Part15 (15.247) , Subpart C				
Section	Test Item	Limit	Frequency Range (MHz)	Result
15.247 (a)(1)	Bandwidth	(20dB bandwidth)	2400-2483.5	PASS

Spectrum Parameter	Setting
Attenuation	Auto
Span Frequency	> Measurement Bandwidth or Channel Separation
RB	30 kHz
VB	100 kHz
Detector	Peak
Trace	Max Hold
Sweep Time	Auto

#### 7.1.1 TEST PROCEDURE

- a. The EUT was directly connected to the spectrum analyzer and antenna output port as show in the block diagram below,
- b. Spectrum Setting : RBW= 30KHz, VBW=100KHz, Sweep time = Auto.

#### 7.1.2 DEVIATION FROM STANDARD

No deviation.

#### 7.1.3 TEST SETUP

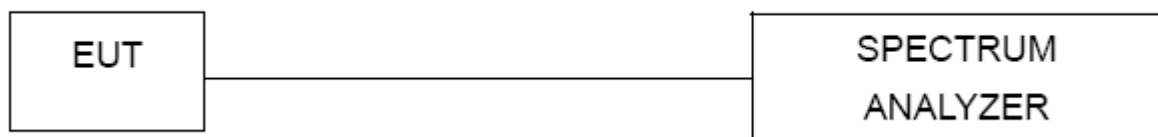

#### 7.1.4 EUT OPERATION CONDITIONS

The EUT tested system was configured as the statements of 2.4 Unless otherwise a special operating condition is specified in the follows during the testing.



### 7.1.5 TEST RESULTS

EUT :	Bluetooth Stereo Headset	Model Name :	UB450
Temperature :	25 °C	Relative Humidity :	60%
Pressure :	1012 hPa	Test Voltage :	DC 3.7V
Test Mode :	CH00 / CH39 /C78(1Mbps)		

Frequency	20dB Bandwidth (kHz)	Result
2402 MHz	877.170	<b>PASS</b>
2441 MHz	872.117	<b>PASS</b>
2480 MHz	883.567	<b>PASS</b>

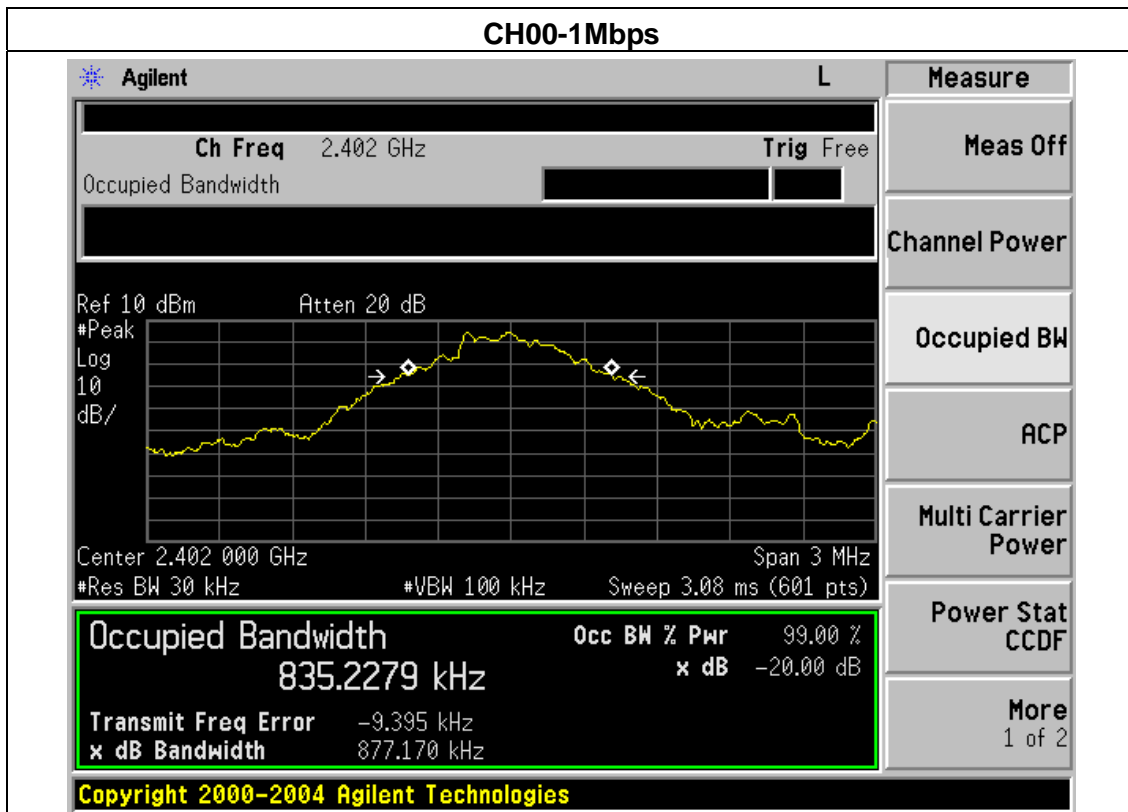

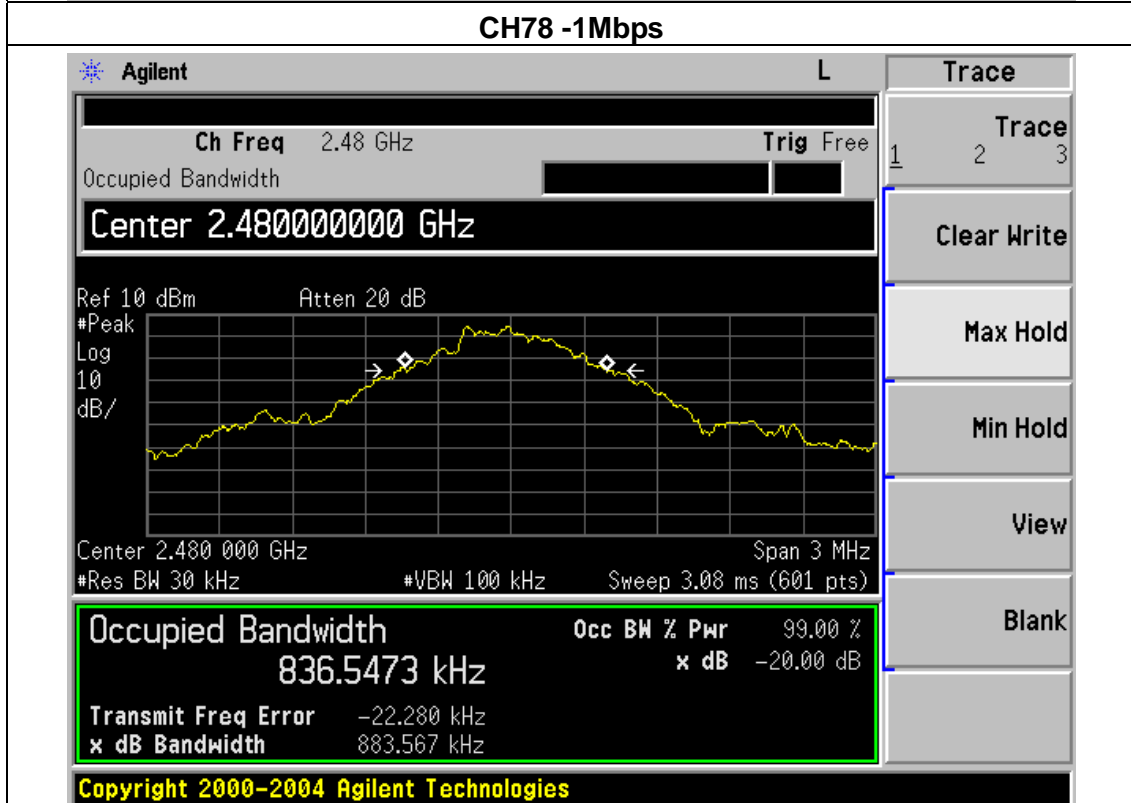
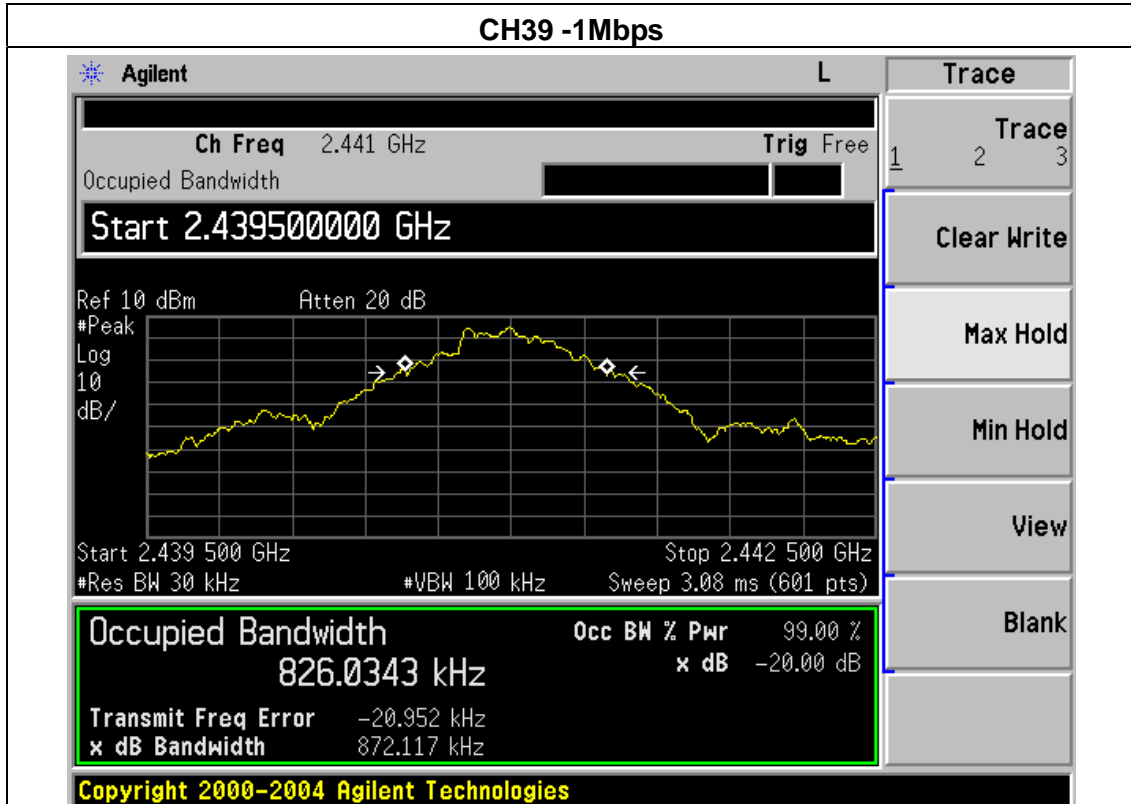

EUT :	Bluetooth Stereo Headset	Model Name :	UB450
Temperature :	25 °C	Relative Humidity :	60%
Pressure :	1012 hPa	Test Voltage :	DC 3.7V
Test Mode :	CH00 / CH39 /C78(2Mbps)		

Frequency	20dB Bandwidth (MHz)	Result
2402 MHz	1.205	<b>PASS</b>
2441 MHz	1.222	<b>PASS</b>
2480 MHz	1.230	<b>PASS</b>

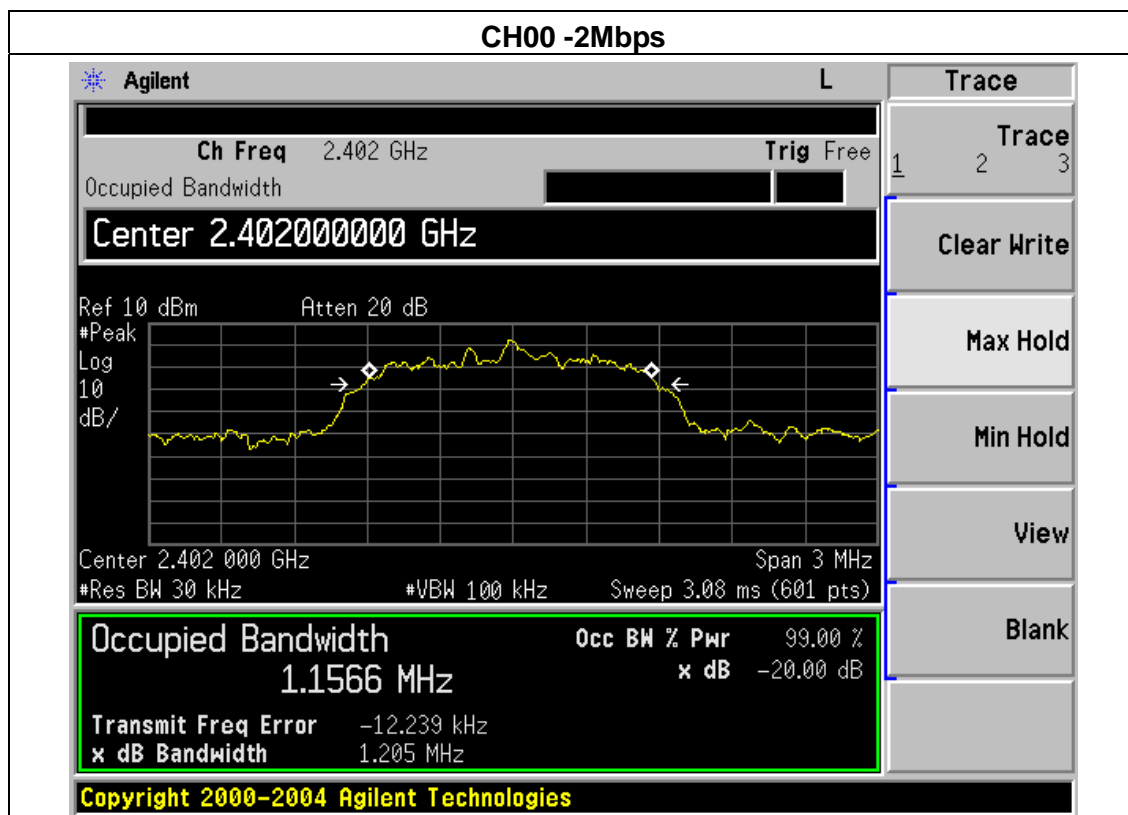

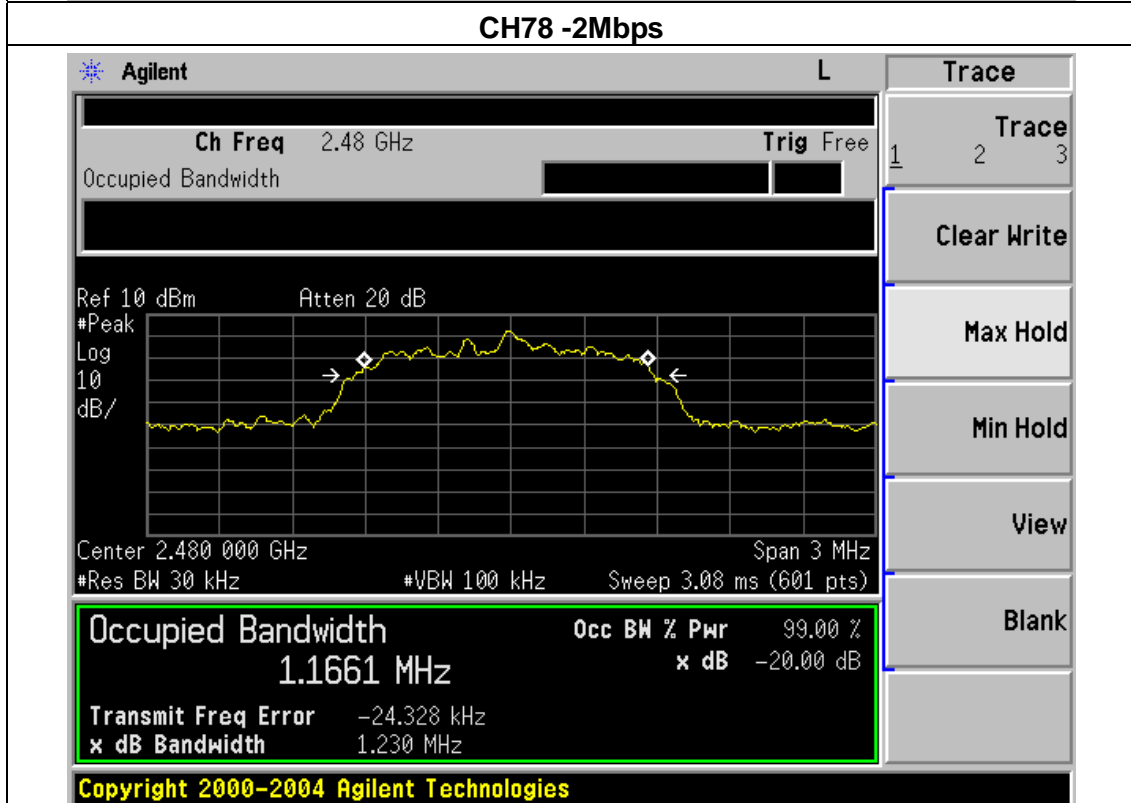
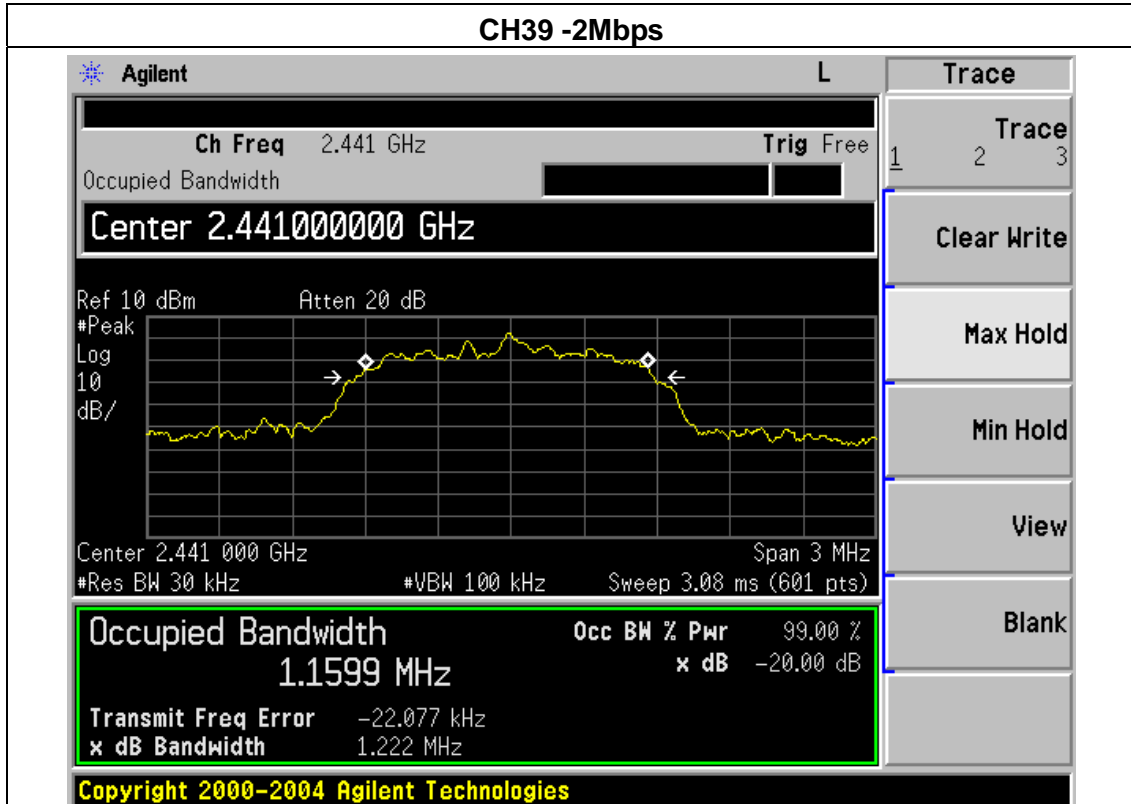

EUT :	Bluetooth Stereo Headset	Model Name :	UB450
Temperature :	25 °C	Relative Humidity :	60%
Pressure :	1012 hPa	Test Voltage :	DC 3.7V
Test Mode :	CH00 / CH39 /C78(3Mbps)		

Frequency	20dB Bandwidth (MHz)	Result
2402 MHz	1.212	<b>PASS</b>
2441 MHz	1.206	<b>PASS</b>
2480 MHz	1.212	<b>PASS</b>

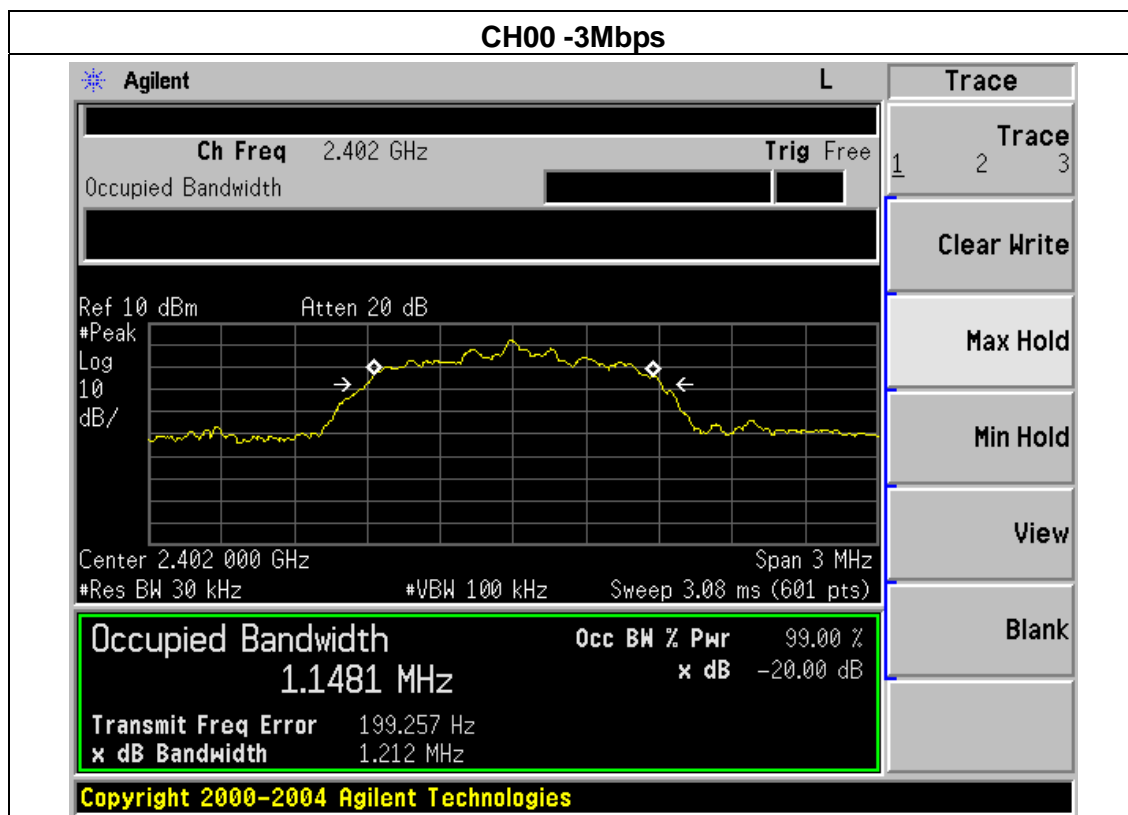

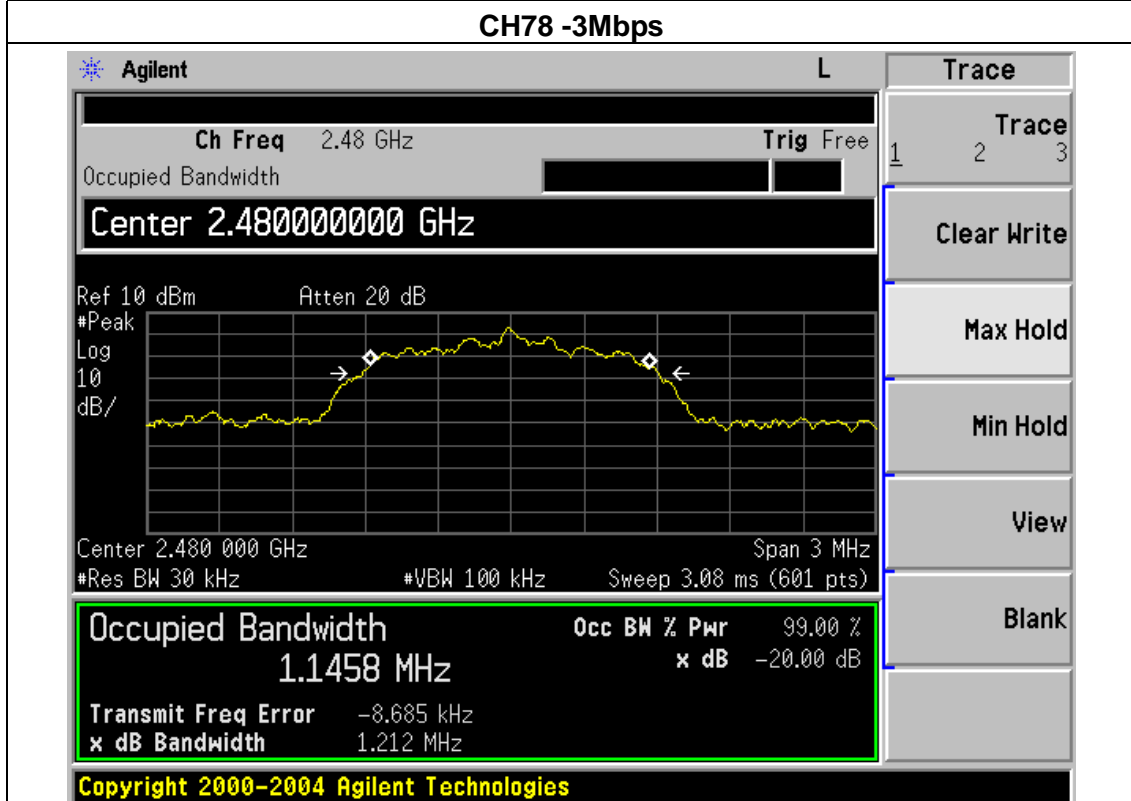
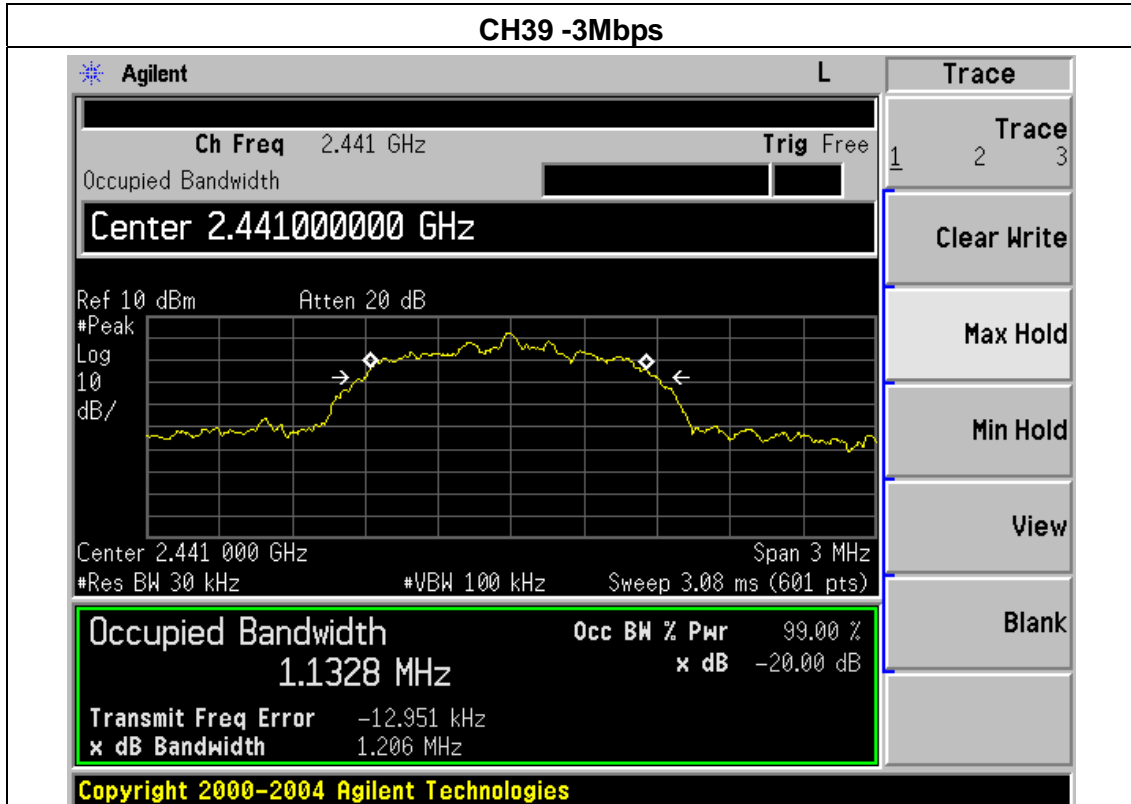

## 8. PEAK OUTPUT POWER TEST

### 8.1 APPLIED PROCEDURES / LIMIT

FCC Part15 (15.247) , Subpart C				
Section	Test Item	Limit	Frequency Range (MHz)	Result
15.247 (b)(i)	Peak Output Power	0.125 w or 20.96dBm	2400-2483.5	PASS

#### 8.1.1 TEST PROCEDURE

- a. The EUT was directly connected to the spectrum analyzer and antenna output port as show in the block diagram below,
- b. Spectrum Setting : RBW > the 20 dB bandwidth of the emission being measured
  - Span = approximately 5 times the 20 dB bandwidth, centered on a hopping channel
  - VBW ≥ RBW
  - Sweep = auto
  - Detector function = peak
  - Trace = max hold

#### 8.1.2 DEVIATION FROM STANDARD

No deviation.

#### 8.1.3 TEST SETUP

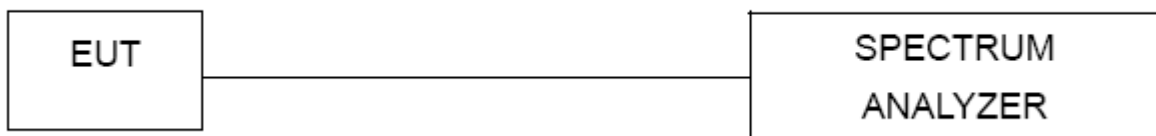

#### 8.1.4 EUT OPERATION CONDITIONS

The EUT tested system was configured as the statements of 2.4 Unless otherwise a special operating condition is specified in the follows during the testing.

### 8.1.5 TEST RESULTS

EUT :	Bluetooth Stereo Headset	Model Name :	UB450
Temperature :	25 °C	Relative Humidity :	60%
Pressure :	1012 hPa	Test Voltage :	DC 3.7V
Test Mode :	CH00/ CH39 /CH78 (1M/2M/3Mbps Mode)		

1Mbps			
Test Channel	Frequency (MHz)	Peak Output Power (dBm)	LIMIT (dBm)
CH00	2402	-0.33	30
CH39	2441	1.02	30
CH78	2480	1.43	30
2Mbps			
CH00	2402	-1.21	20.96
CH39	2441	0.28	20.96
CH78	2480	0.86	20.96
3Mbps			
CH00	2402	-1.21	20.96
CH39	2441	0.29	20.96
CH78	2480	0.86	20.96

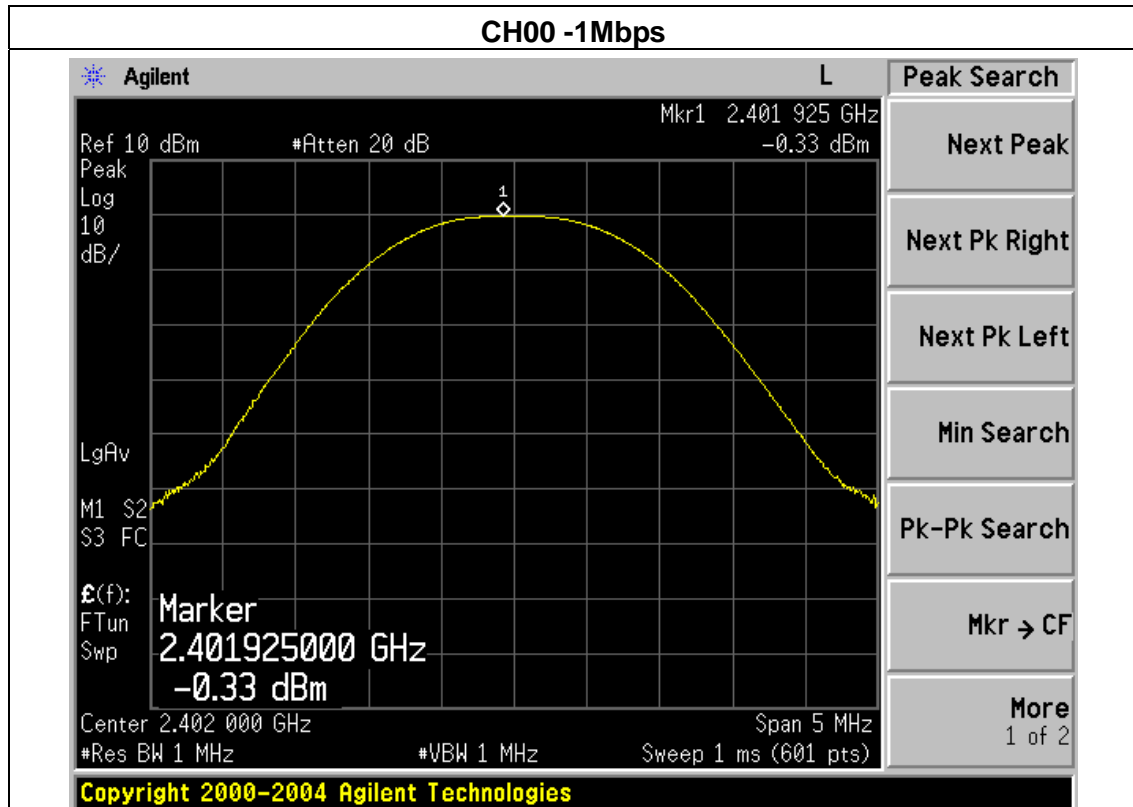



### CH39 -1Mbps

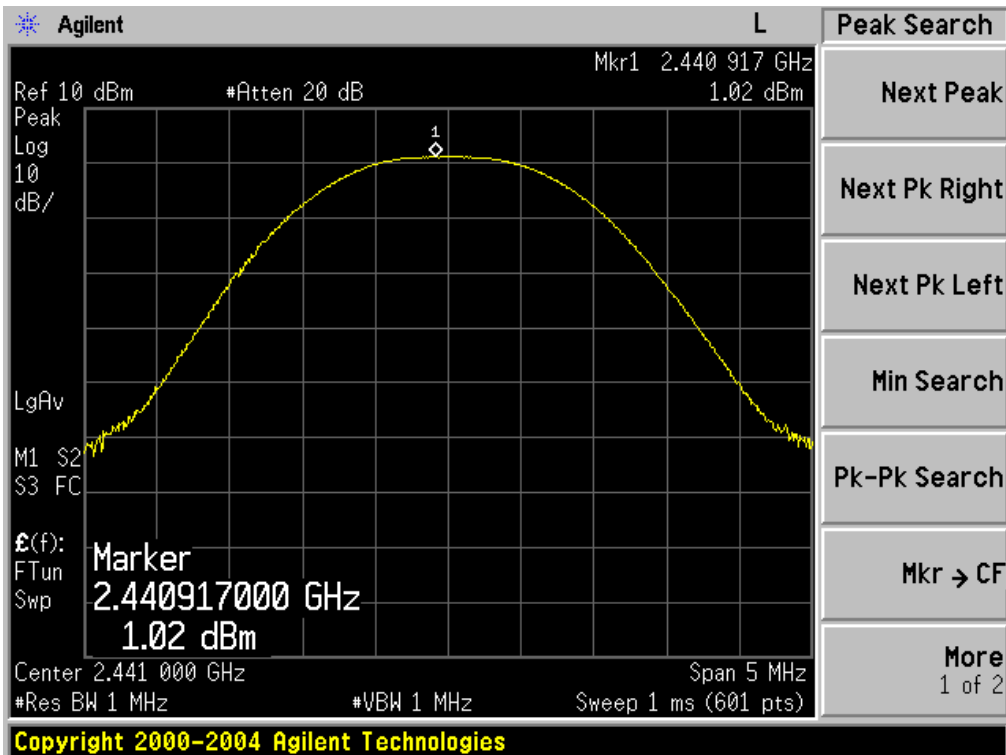

### CH78 -1Mbps

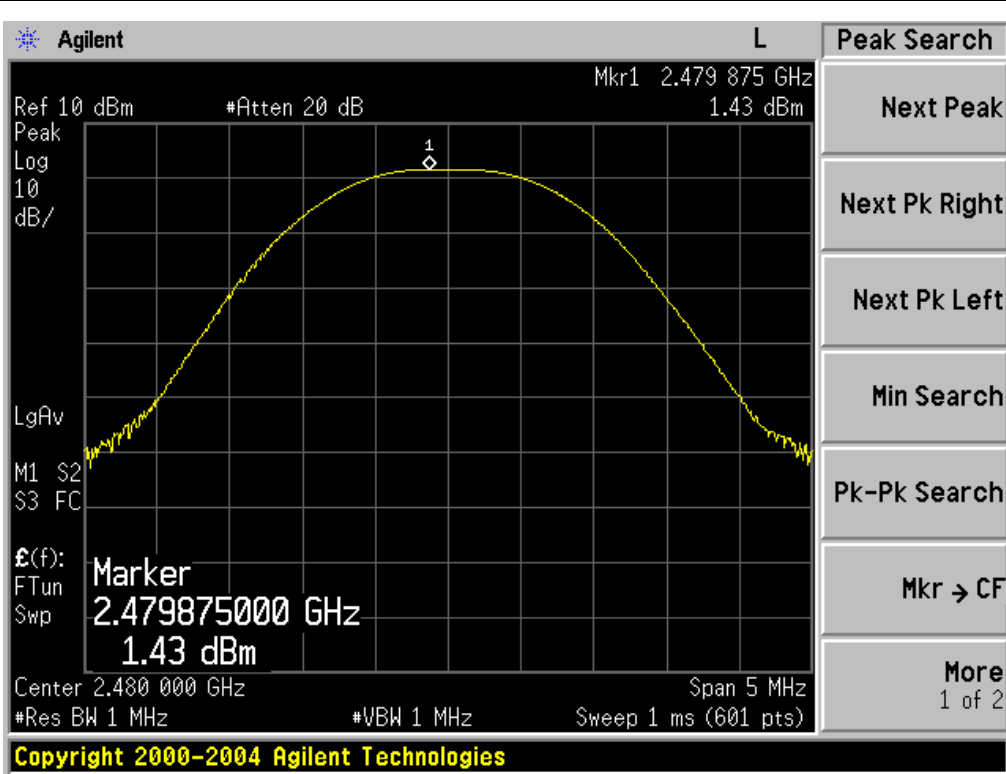

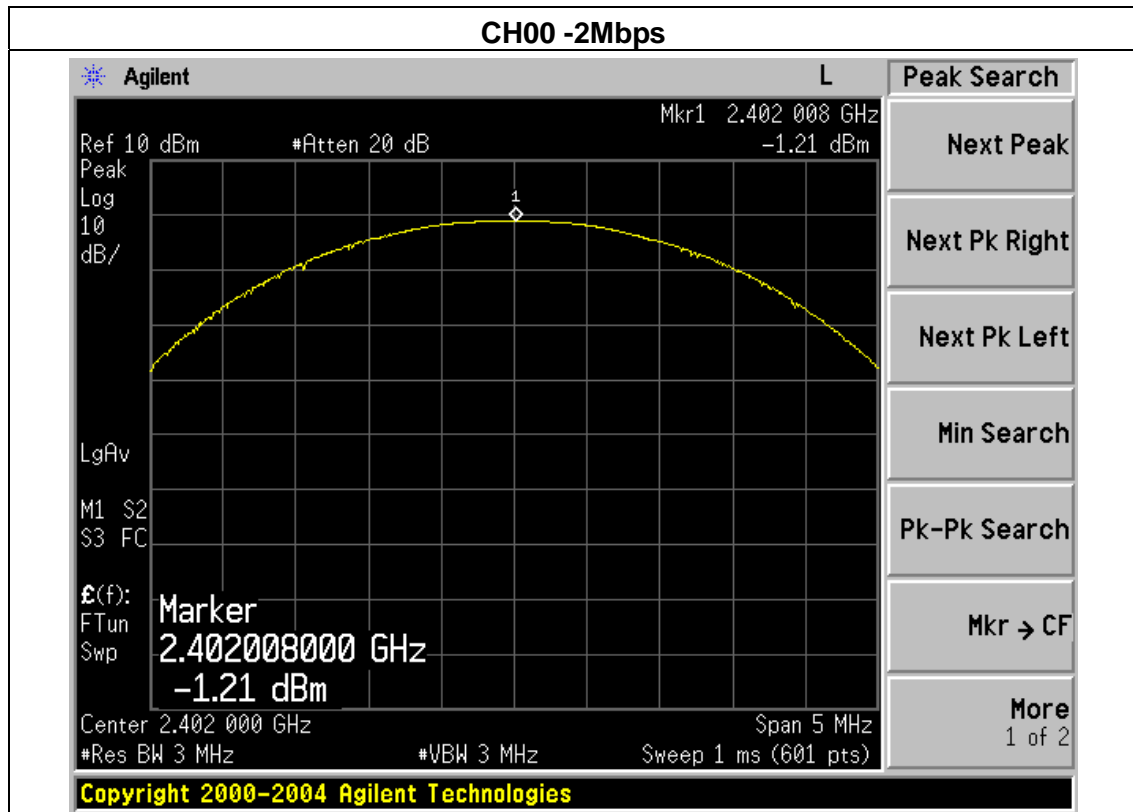

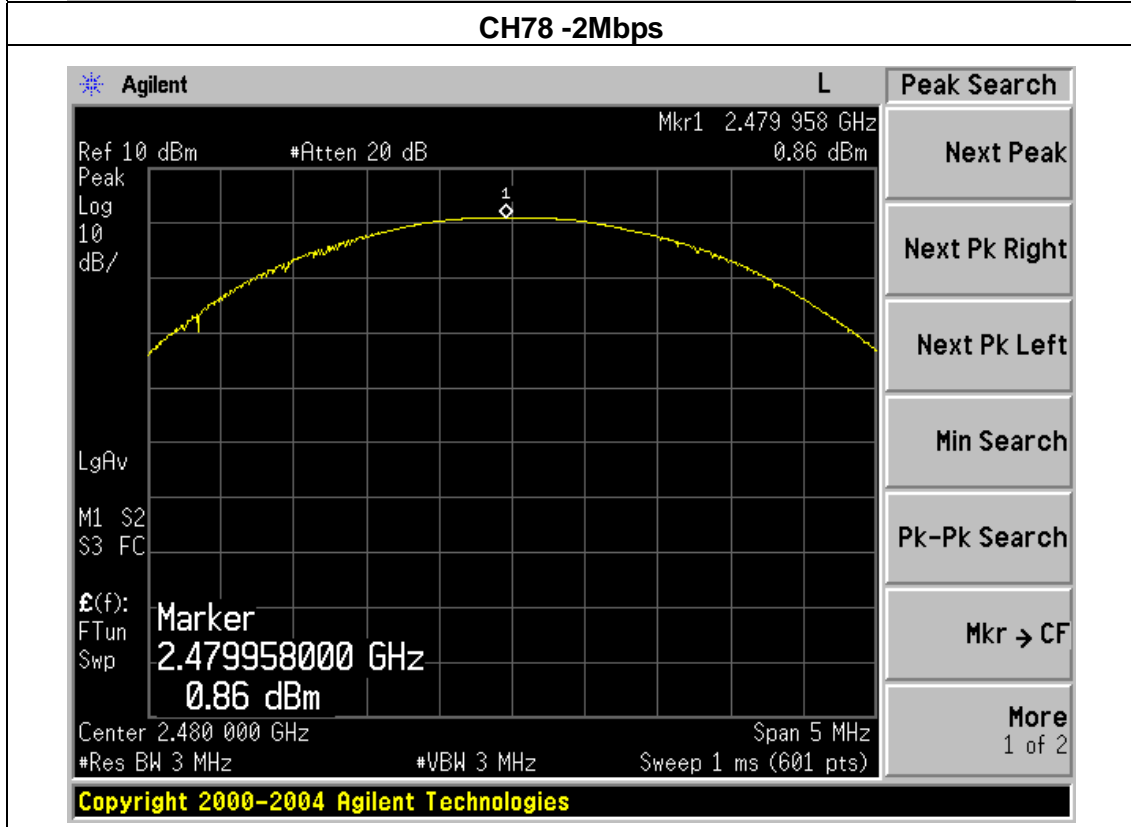
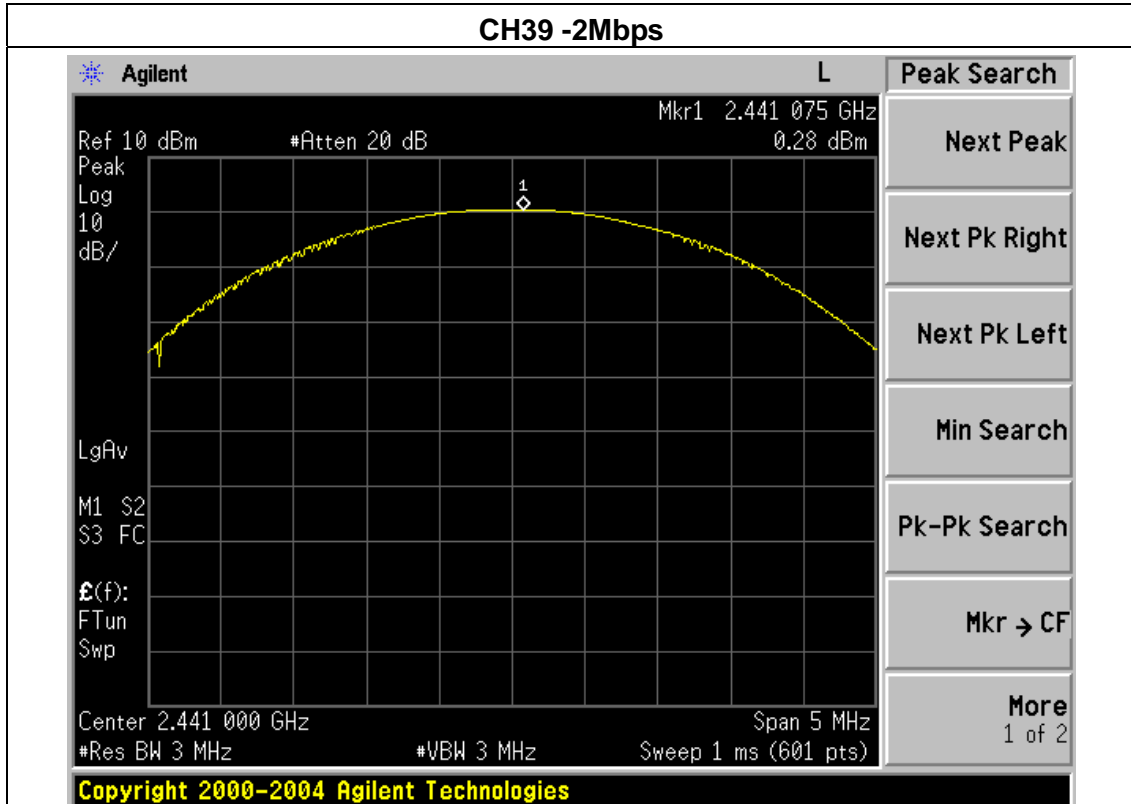

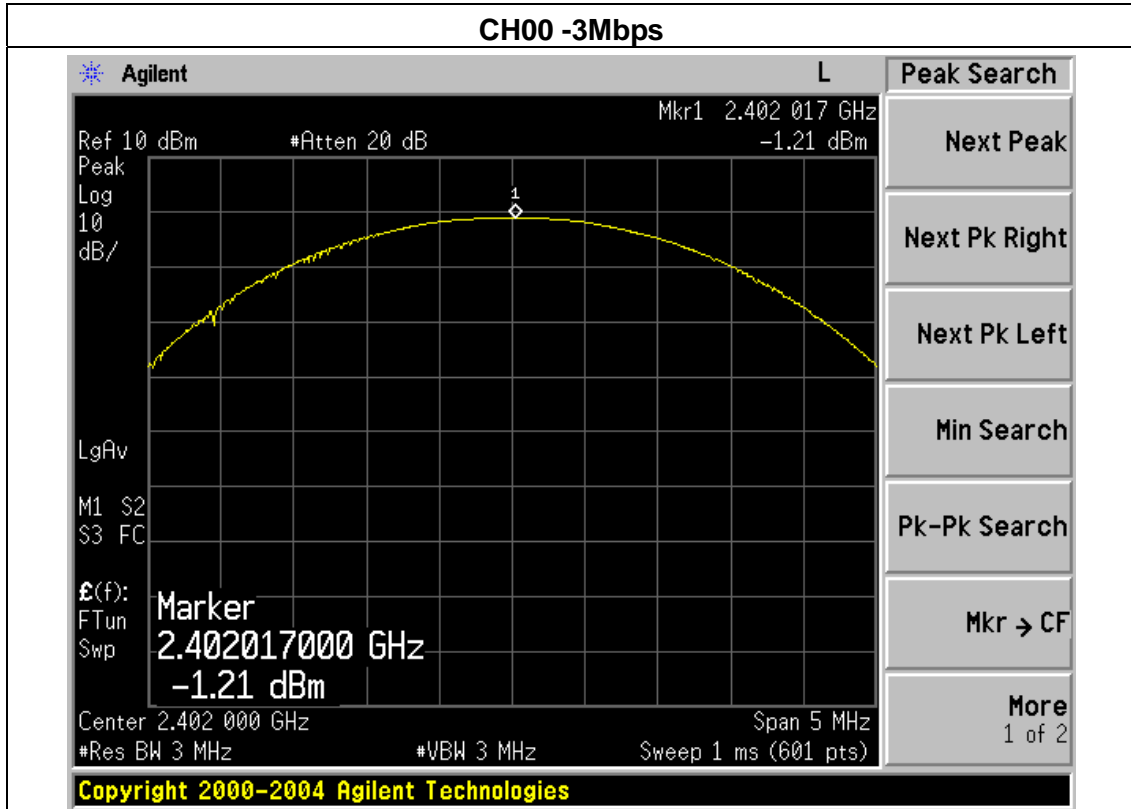

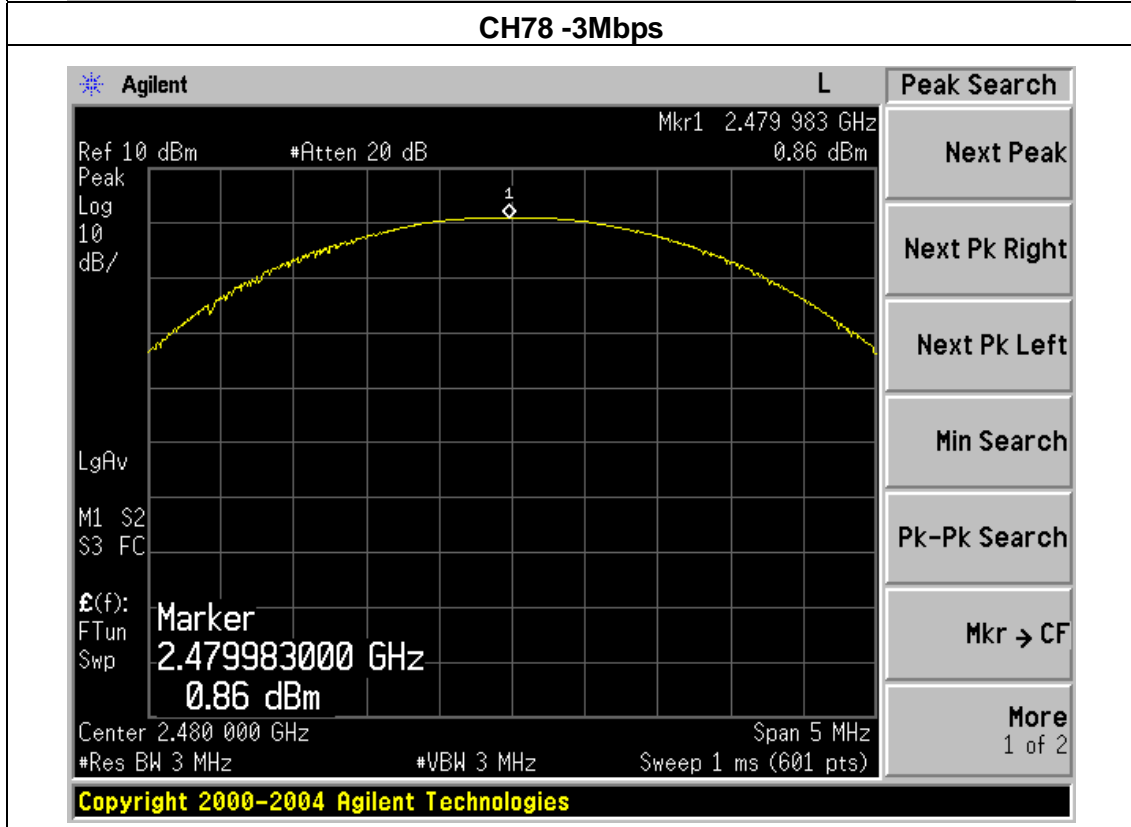
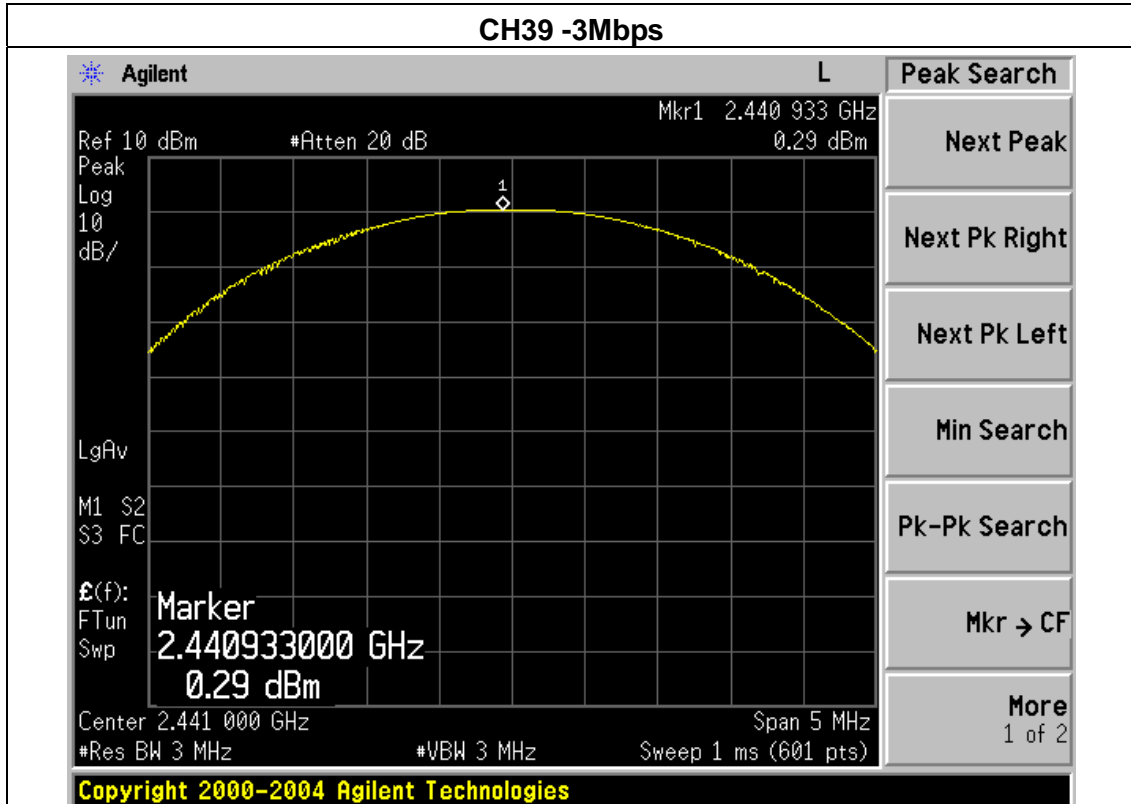

**9. 100 KHZ BANDWIDTH OF FREQUENCY BAND EDGE**

**APPLICABLE STANDARD**

In any 100 kHz bandwidth outside the frequency band in which the spread spectrum or digitally modulated intentional radiator is operating, the radio frequency power that is produced by the intentional radiator shall be at least 20 dB below that in the 100 kHz bandwidth within the band that contains the highest level of the desired power, based on either an RF conducted or a radiated measurement, provided the transmitter demonstrates compliance with the peak conducted power limits. If the transmitter complies with the conducted power limits based on the use of RMS averaging over a time interval, as permitted under paragraph (b)(3) of this section, the attenuation required under this paragraph shall be 30 dB instead of 20 dB. Attenuation below the general limits specified in §15.209(a) is not required. In addition, radiated emissions which fall in the restricted bands, as defined in §15.205(a), must also comply with the radiated emission limits specified in §15.209(a) (see §15.205(c)).

**TEST PROCEDURE**

- a) Check the calibration of the measuring instrument using either an internal calibrator or a known signal from an external generator.
- b) Position the EUT without connection to measurement instrument. Turn on the EUT and connect its antenna terminal to measurement instrument via a low loss cable. Then set it to any one measured frequency within its operating range, and make sure the instrument is operated in its linear range.
- c) Set RBW to 100 kHz and VBW of spectrum analyzer to 300 kHz with a convenient frequency span including 100 kHz bandwidth from band edge.
- d) Measure the highest amplitude appearing on spectral display and set it as a reference level. Plot the graph with marking the highest point and edge frequency.
- e) Repeat above procedures until all measured frequencies were complete.

**9.1 DEVIATION FROM STANDARD**

No deviation.

**9.2 TEST SETUP**



**9.3 EUT OPERATION CONDITIONS**

The EUT tested system was configured as the statements of 2.4 Unless otherwise a special operating condition is specified in the follows during the testing.

### 9.4 TEST RESULTS

EUT :	Bluetooth Stereo Headset	Model Name :	UB450
Temperature :	25 °C	Relative Humidity :	60%
Pressure :	1012 hPa	Test Voltage :	DC 3.7V
Test Mode :	CH00/ CH78 (1M/2M/3Mbps Mode)		

Frequency Band	Delta Peak to band emission (dBc)	> Limit (dBc)	Result
1Mbps Non-hopping			
2400	52.81	20	Pass
2483.5	61.31	20	Pass
2Mbps Non-hopping			
2400	52.89	20	Pass
2483.5	52.71	20	Pass
3Mbps Non-hopping			
2400	51.44	20	Pass
2483.5	55.08	20	Pass
1Mbps hopping			
2400	47.81	20	Pass
2483.5	60.64	20	Pass
2Mbps hopping			
2400	48.95	20	Pass
2483.5	55.38	20	Pass
3Mbps hopping			
2400	51.65	20	Pass
2483.5	54.74	20	Pass

**Radiated band edge:**

Frequency (MHz)	Meter Reading (dBμV)	Factor (dB)	Emission Level (dBμV/m)	Limits (dBμV/m)	Margin (dB)	Detector Type	Comment
<b>1Mbps Non-hopping</b>							
2390	56.62	-13.06	43.56	74.00	-30.44	peak	Vertical
2390	57.71	-13.06	44.65	74.00	-29.35	peak	Horizontal
2483.5	56.46	-12.78	43.68	74.00	-30.32	peak	Vertical
2483.5	58.77	-12.78	45.99	74.00	-28.01	peak	Horizontal
<b>1Mbps hopping</b>							
2390	59.37	-13.06	46.31	74.00	-27.69	peak	Vertical
2390	60.35	-13.06	47.29	74.00	-26.71	peak	Horizontal
2483.5	58.25	-12.78	45.47	74.00	-28.53	peak	Vertical
2483.5	60.56	-12.78	47.78	74.00	-26.22	peak	Horizontal
<b>2Mbps Non-hopping</b>							
2390	58.08	-13.06	45.02	74.00	-28.98	peak	Vertical
2390	56.41	-13.06	43.35	74.00	-30.65	peak	Horizontal
2483.5	59.01	-12.78	46.23	74.00	-27.77	peak	Vertical
2483.5	58.25	-12.78	45.47	74.00	-28.53	peak	Horizontal
<b>2Mbps hopping</b>							
2390	58.26	-13.06	45.20	74.00	-28.80	peak	Vertical
2390	59.65	-13.06	46.59	74.00	-27.41	peak	Horizontal
2483.5	60.12	-12.78	47.34	74.00	-26.66	peak	Vertical
2483.5	58.44	-12.78	45.66	74.00	-28.34	peak	Horizontal
<b>3Mbps Non-hopping</b>							
2390	57.92	-13.06	44.86	74.00	-29.14	peak	Vertical
2390	57.07	-13.06	44.01	74.00	-29.99	peak	Horizontal
2483.5	56.86	-12.78	44.08	74.00	-29.92	peak	Vertical
2483.5	57.74	-12.78	44.96	74.00	-29.04	peak	Horizontal
<b>3Mbps hopping</b>							
2390	58.72	-13.06	45.66	74.00	-28.34	peak	Vertical
2390	58.86	-13.06	45.80	74.00	-28.20	peak	Horizontal
2483.5	57.67	-12.78	44.89	74.00	-29.11	peak	Vertical
2483.5	60.56	-12.78	47.78	74.00	-26.22	peak	Horizontal

Note: Refer to chapter 3.2 test method, When PK value is lower than the Average value limit, average didn't record.



BDR mode (GFSK): Band Edge-Left Side

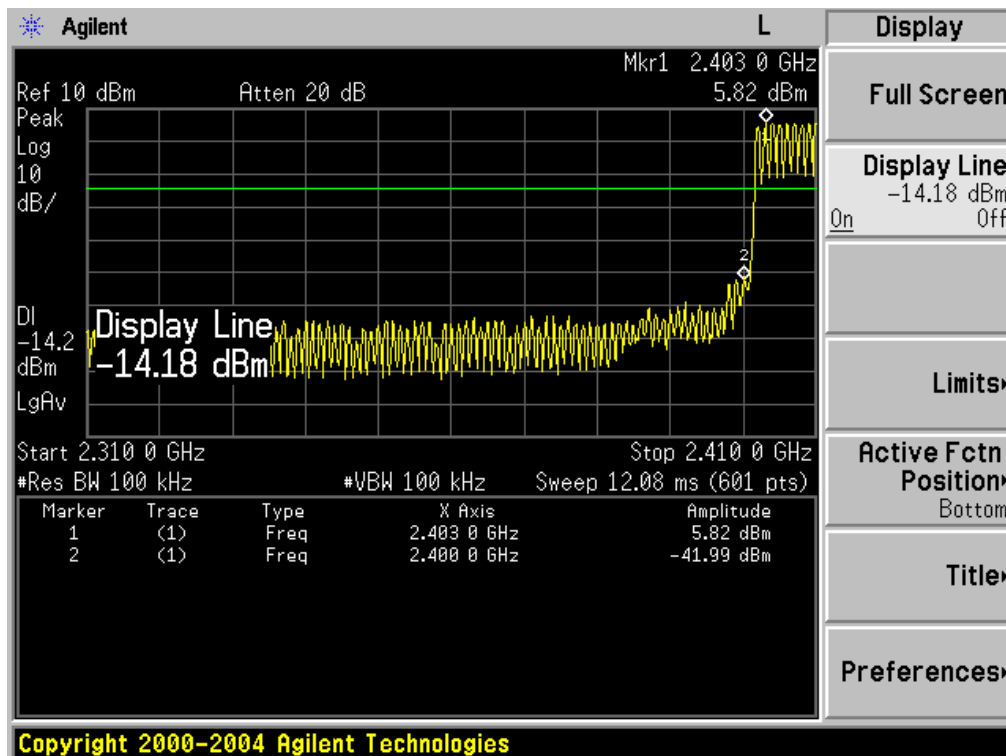
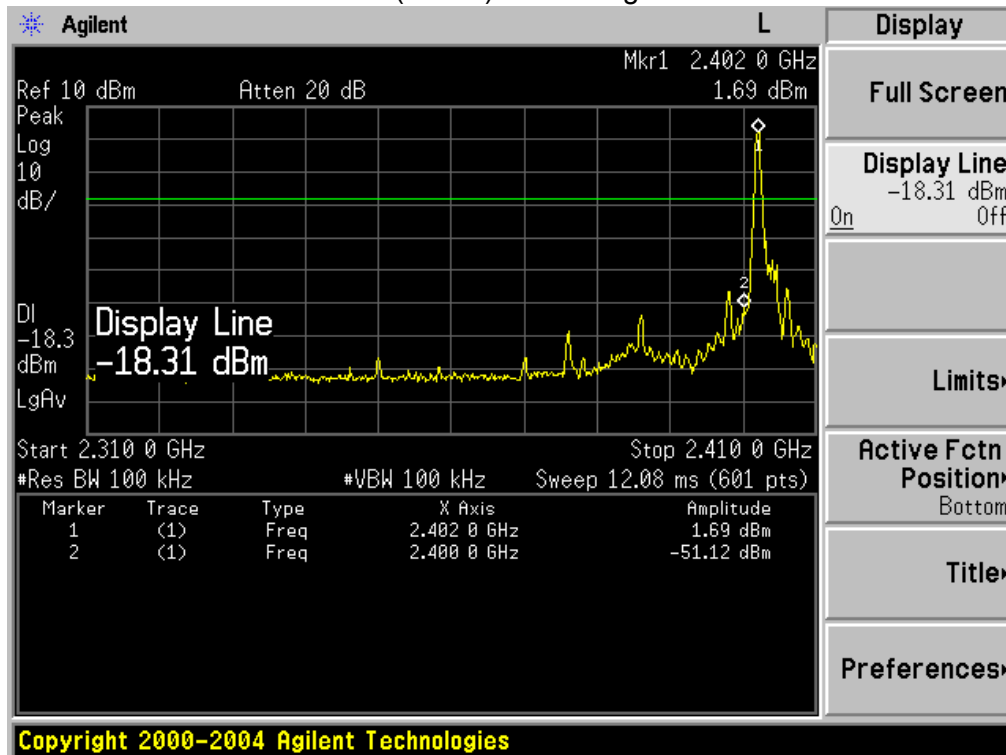

BDR mode (GFSK): Band Edge-Right Side

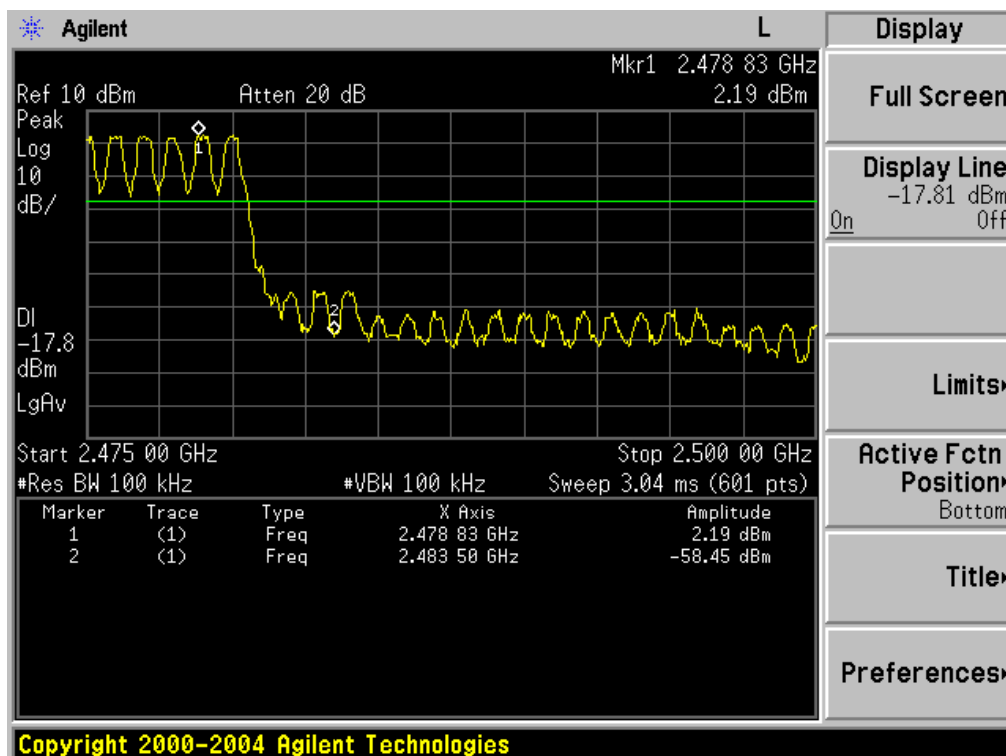
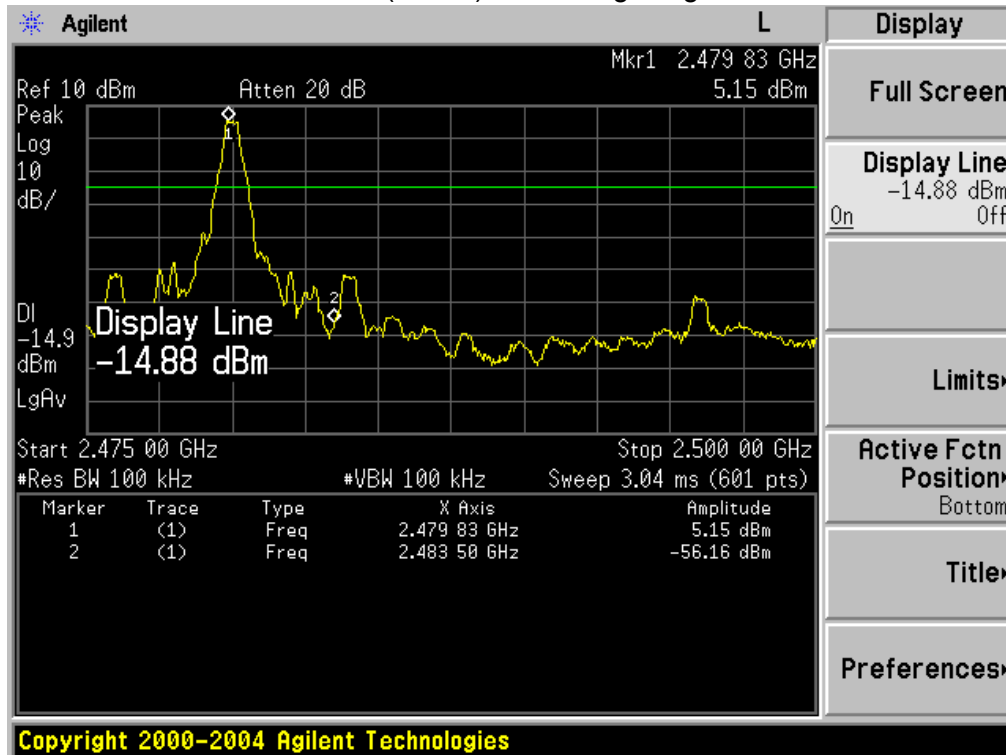

EDR mode ( $\pi/4$ -DQPSK): Band Edge-Left Side

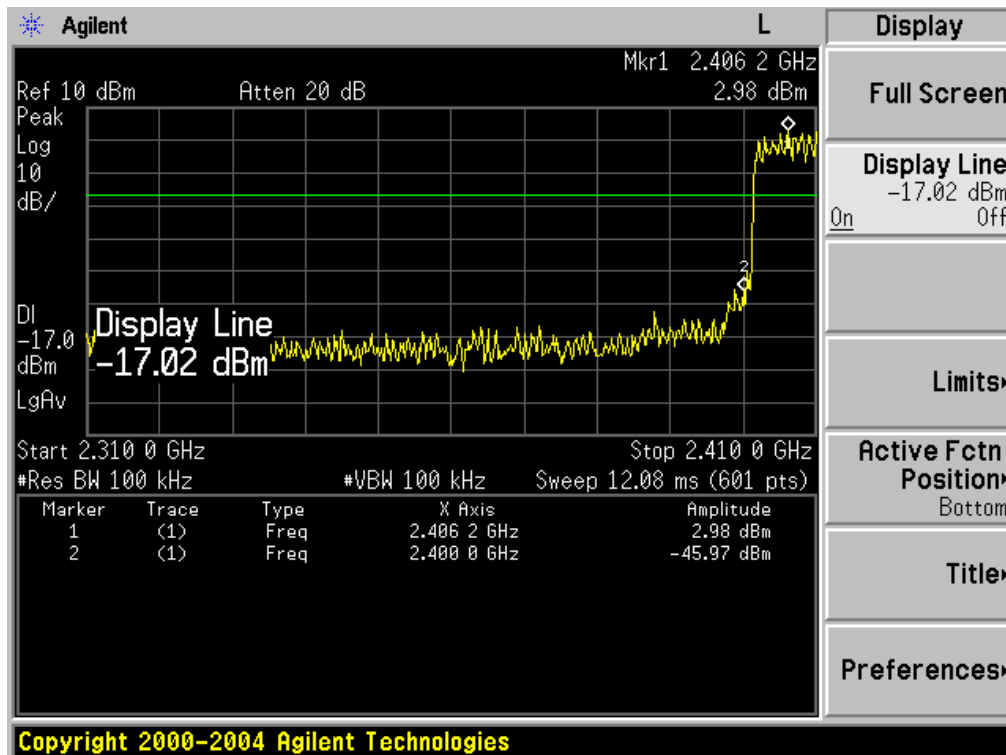
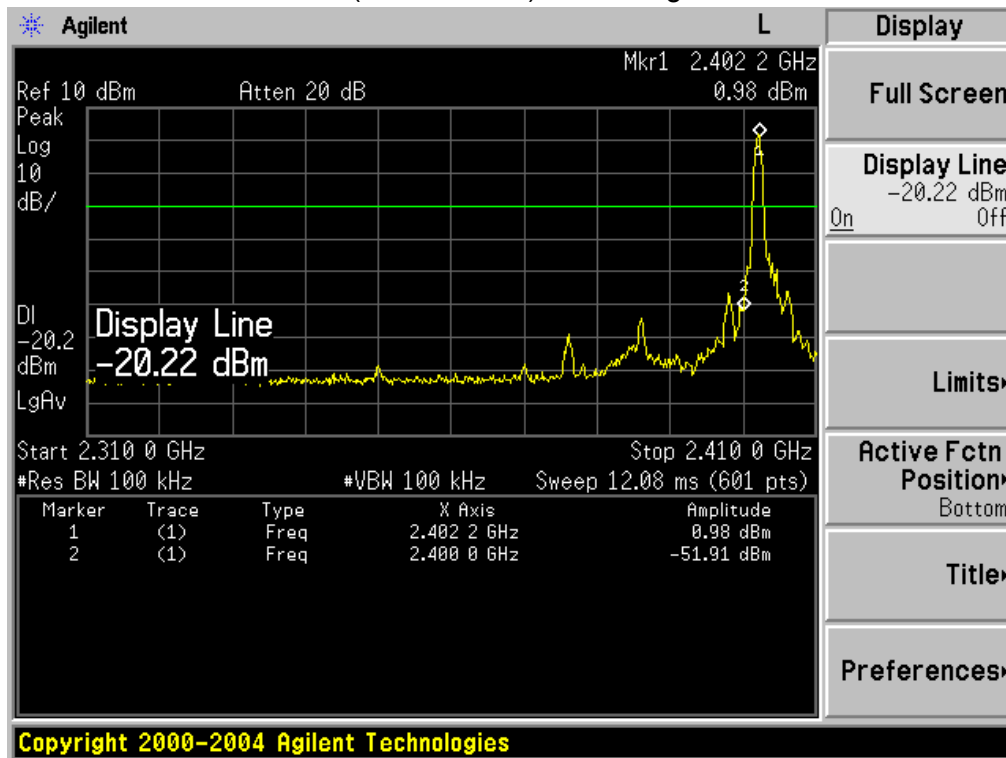

EDR mode ( $\pi/4$ -DQPSK): Band Edge- Right Side

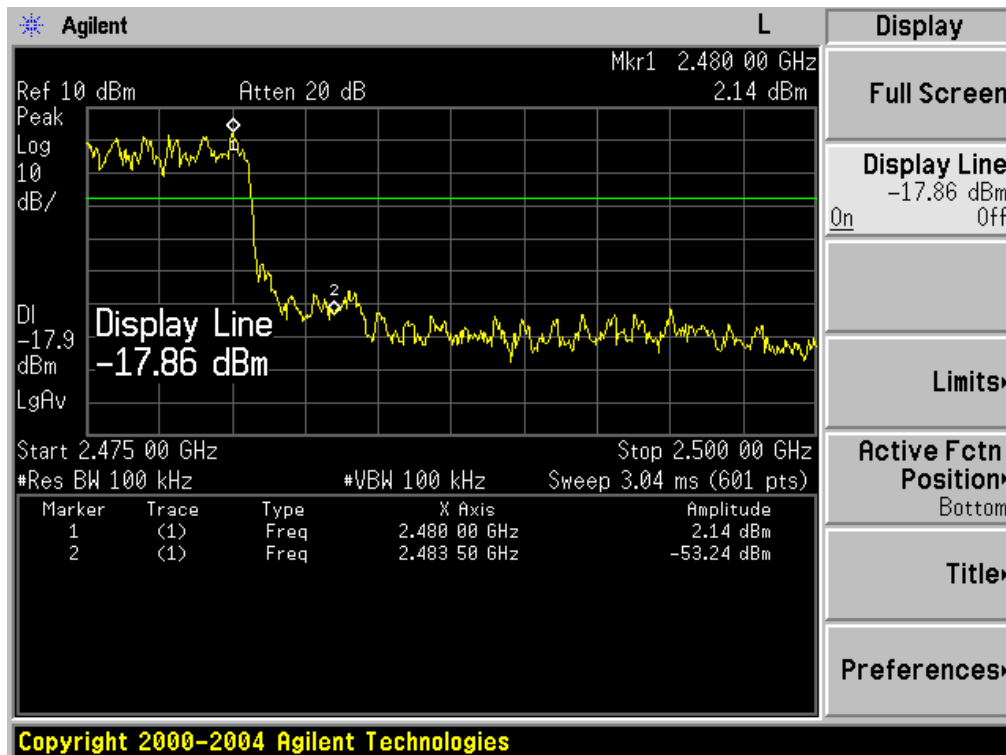
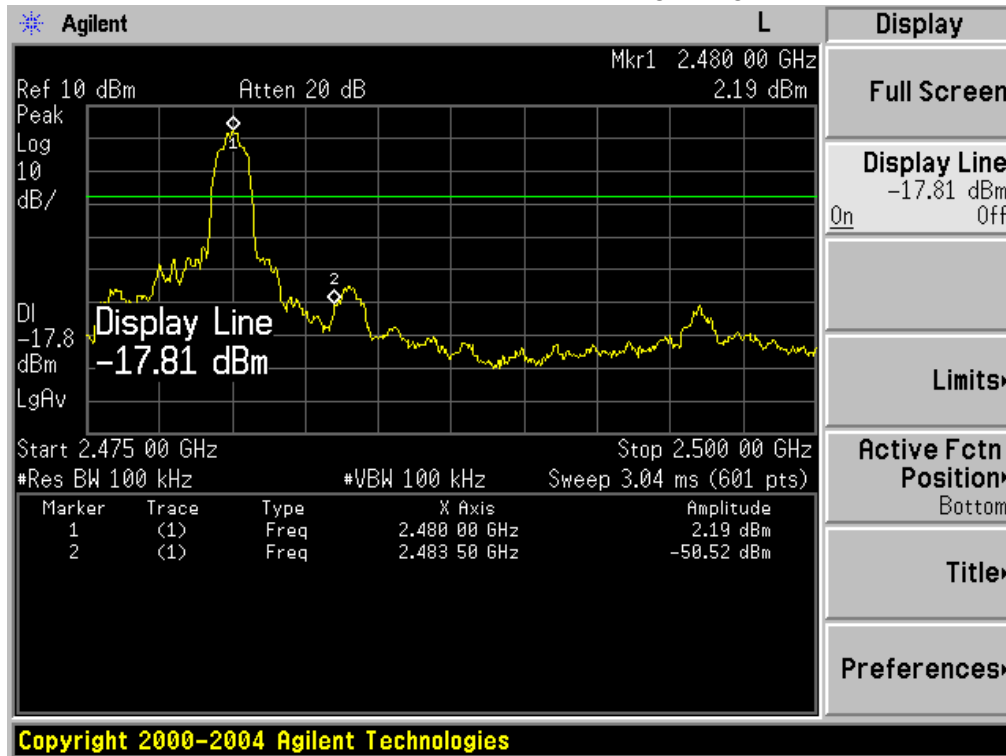

EDR mode(8DPSK): Band Edge-Left Side

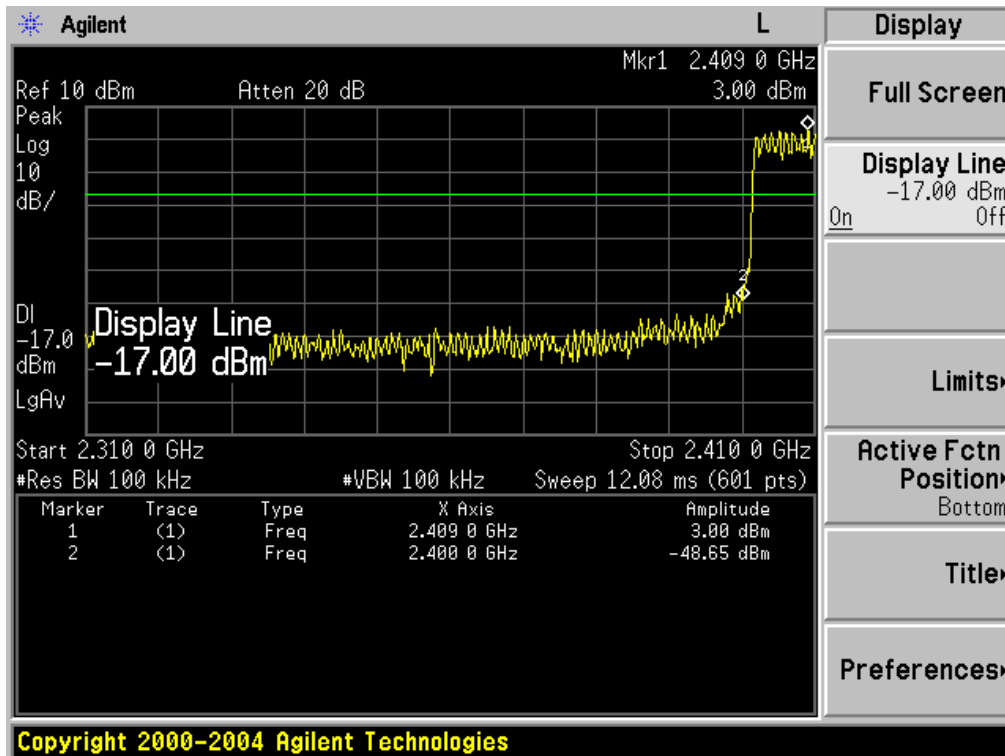
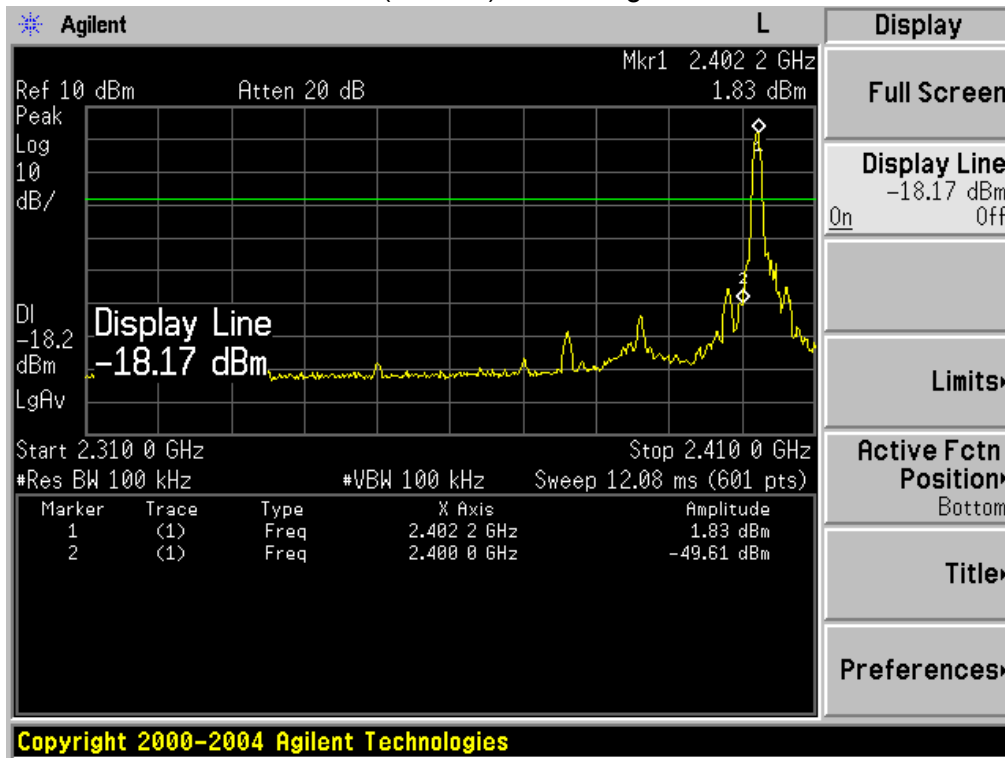

EDR mode(8DPSK): Band Edge-Right Side

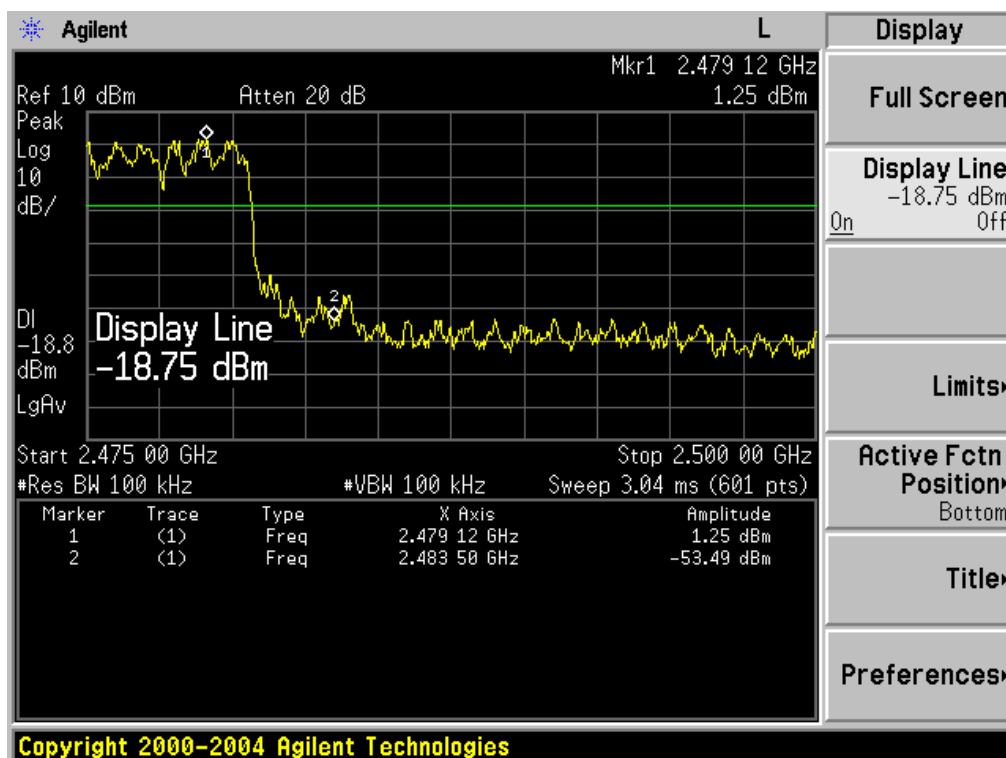
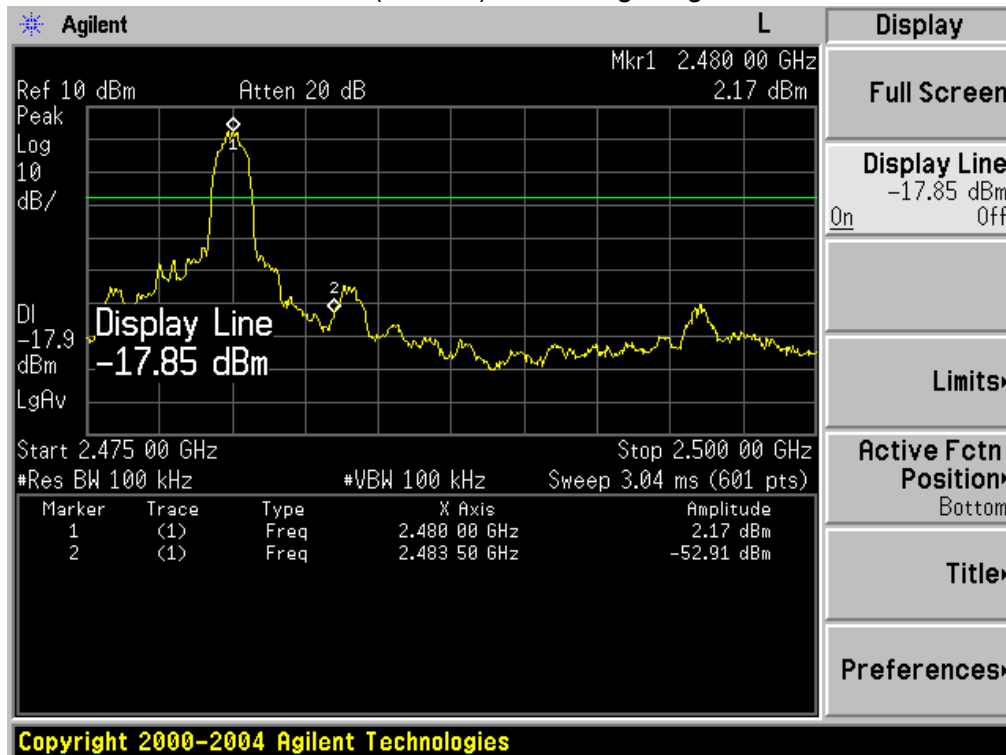

NOTE: Hopping enabled and disabled have evaluated, and the worst data was reported

## **10. ANTENNA REQUIREMENT**

### **10.1 STANDARD REQUIREMENT**

15.203 requirement: For intentional device, according to 15.203: an intentional radiator shall be designed to ensure that no antenna other than that furnished by the responsible party shall be used with the device.

### **10.2 EUT ANTENNA**

The EUT antenna is permanent attached antenna. It comply with the standard requirement.

### 11. EUT TEST PHOTO

#### Radiated Measurement Photos





**CONDUCTED EMISSION Photos**

