

FCC 47 CFR PART 15 SUBPART C
CERTIFICATION TEST REPORT

For

Sonic Portable Speaker

Model No.: NS-SONIC20

FCC ID: HBONSSONIC20

Trade Mark: INSIGNIA

Report No.: ES190513015W

Issue Date: June 17, 2019

Prepared for

SHENZHEN FENDA TECHNOLOGY CO.,LTD.

Fenda Hi-Tech Park, Zhoushi Road, Shiyan Town, Baoan District, Shenzhen
City, Guangdong, China

Prepared by

EMTEK (SHENZHEN) CO., LTD.

Bldg 69, Majialong Industry Zone, Nanshan District, Shenzhen,
Guangdong, China

TEL: 86-755-26954280

FAX: 86-755-26954282

Table of Contents

1 TEST RESULT CERTIFICATION.....	3
2 EUT TECHNICAL DESCRIPTION.....	5
3 SUMMARY OF TEST RESULT.....	6
4 TEST METHODOLOGY.....	7
4.1 GENERAL DESCRIPTION OF APPLIED STANDARDS.....	7
4.2 MEASUREMENT EQUIPMENT USED.....	7
4.3 DESCRIPTION OF TEST MODES.....	8
5 FACILITIES AND ACCREDITATIONS.....	9
5.1 FACILITIES.....	9
5.2 LABORATORY ACCREDITATIONS AND LISTINGS.....	9
6 TEST SYSTEM UNCERTAINTY.....	10
7 SETUP OF EQUIPMENT UNDER TEST.....	11
7.1 RADIO FREQUENCY TEST SETUP 1.....	11
7.2 RADIO FREQUENCY TEST SETUP 2.....	11
7.3 CONDUCTED EMISSION TEST SETUP.....	13
7.4 BLOCK DIAGRAM CONFIGURATION OF TEST SYSTEM.....	14
7.5 SUPPORT EQUIPMENT.....	14
8 FREQUENCY HOPPING SYSTEM REQUIREMENTS.....	15
8.1 STANDARD APPLICABLE.....	15
8.2 EUT PSEUDORANDOM FREQUENCY HOPPING SEQUENCE.....	15
8.3 EQUAL HOPPING FREQUENCY USE.....	16
8.4 FREQUENCY HOPPING SYSTEM.....	16
9 TEST REQUIREMENTS.....	17
9.1 20DB BANDWIDTH.....	17
9.2 CARRIER FREQUENCY SEPARATION.....	23
9.3 NUMBER OF HOPPING FREQUENCIES.....	29
9.4 AVERAGE TIME OF OCCUPANCY (DWELL TIME).....	32
9.5 MAXIMUM PEAK CONDUCTED OUTPUT POWER.....	39
9.6 CONDUCTED SUPRIOUS EMISSION.....	45
9.7 RADIATED SPURIOUS EMISSION.....	64
9.8 CONDUCTED EMISSION TEST.....	98
9.9 ANTENNA APPLICATION.....	101

1 TEST RESULT CERTIFICATION

Applicant : SHENZHEN FENDA TECHNOLOGY CO.,LTD.
 Address : Fenda Hi-Tech Park, Zhoushi Road, Shiyan Town, Baoan District, Shenzhen City, Guangdong, China
 Manufacture : SHENZHEN FENDA TECHNOLOGY CO.,LTD.
 Address : Fenda Hi-Tech Park, Zhoushi Road, Shiyan Town, Baoan District, Shenzhen City, Guangdong, China
 EUT : Sonic Portable Speaker
 Model : NS-SONIC20
 Trademark : INSIGNIA

Measurement Procedure Used:

APPLICABLE STANDARDS	
STANDARD	TEST RESULT
FCC 47 CFR Part 2, Subpart J FCC 47 CFR Part 15, Subpart C	PASS

The above equipment was tested by EMTEK (SHENZHEN) CO., LTD. The test data, data evaluation, test procedures, and equipment configurations shown in this report were made in accordance with the procedures given in ANSI C63.10 (2013) and the energy emitted by the sample EUT tested as described in this report is in compliance with the requirements of FCC Rules Part 2 and Part 15.247

The test results of this report relate only to the tested sample identified in this report

Date of Test : May 24, 2019 to June 12, 2019

Prepared by : *Stephen liang*

tephen liang/Editor

Reviewer : *Yaping Shen*

Yaping Shen/Supervisor

Approve & Authorized Signer : *Lisa Wang*

Lisa Wang/Manager



Modified History

Version	Report No.	Revision Date	Summary
V1.0	ES190513015W	June 17, 2019	Original Report

2 EUT TECHNICAL DESCRIPTION

Characteristics	Description
Product	Sonic Portable Speaker
Model Number	NS-SONIC20
Device Type	Bluetooth V5.0
Data Rate	1Mbps for BT V5.0 GFSK modulation 2Mbps for BT V5.0 π /4DQPSK modulation 3Mbps for BT V5.0 8DPSK modulation
Modulation:	GFSK modulation for BT V5.0 (1Mbps) π /4DQPSK modulation for BT V5.0 (2Mbps) 8DPSK modulation for BT V5.0 (3Mbps)
Operating Frequency Range(s):	2402-2480MHz
Number of Channels:	79 channels
Test Software:	FCCAssist V2.4
Test Power Grade:	3
Transmit Power Max:	2.246 dBm
Antenna Type	PCB Antenna
Antenna Gain	2 dBi
Power supply	<input checked="" type="checkbox"/> Battery 3.7V, 5200mAh <input checked="" type="checkbox"/> DC 5V by USB Port
Test Voltage	AC 120V/60Hz
Temperature Range:	-10°C~ +45°C

Note: for more details, please refer to the User's manual of the EUT.

3 SUMMARY OF TEST RESULT

FCC Part Clause	Test Parameter	Verdict	Remark
15.247(a)(1)	20 dB Bandwidth	PASS	
15.247(a)(1)	Carrier Frequency Separation	PASS	
15.247(a)(1)	Number of Hopping Frequencies	PASS	
15.247(a)(1)	Average Time of Occupancy (Dwell Time)	PASS	
15.247(b)(1)	Maximum Peak Conducted Output Power	PASS	
15.247(c)	Conducted Spurious Emissions	PASS	
15.247(d) 15.209	Radiated Spurious Emissions	PASS	
15.207	Conducted Emission	PASS	
15.203	Antenna Application	PASS	
NOTE1: N/A (Not Applicable)			

RELATED SUBMITTAL(S) / GRANT(S):

This submittal(s) (test report) is intended for FCC ID: HBONSSONIC20 filing to comply with Section 15.247 of the FCC Part 15, Subpart C Rules.

4 TEST METHODOLOGY

4.1 GENERAL DESCRIPTION OF APPLIED STANDARDS

According to its specifications, the EUT must comply with the requirements of the following standards:

FCC 47 CFR Part 2, Subpart J

FCC 47 CFR Part 15, Subpart C

FCC KDB 558074 D01 15.247 Meas Guidance v05r02

4.2 MEASUREMENT EQUIPMENT USED

4.2.1 Conducted Emission Test Equipment

EQUIPMENT TYPE	MFR	MODEL NUMBER	SERIAL NUMBER	LAST CAL.	DUE CAL.
Test Receiver	Rohde & Schwarz	ESCS30	828985/018	May 19, 2019	May 18, 2020
L.I.S.N.	Schwarzbeck	NNLK8129	8129203	May 19, 2019	May 18, 2020
50Ω Coaxial Switch	Anritsu	MP59B	M20531	May 19, 2019	May 18, 2020
Pulse Limiter	Rohde & Schwarz	ESH3-Z2	100006	May 19, 2019	May 18, 2020
Voltage Probe	Rohde & Schwarz	TK9416	N/A	May 19, 2019	May 18, 2020
I.S.N	Rohde & Schwarz	ENY22	1109.9508.02	May 19, 2019	May 18, 2020

4.2.2 Radiated Emission Test Equipment

EQUIPMENT TYPE	MFR	MODEL NUMBER	SERIAL NUMBER	LAST CAL.	DUE CAL.
EMI Test Receiver	Rohde & Schwarz	ESU	1302.6005.26	May 19, 2019	May 18, 2020
Pre-Amplifier	HP	8447D	2944A07999	May 19, 2019	May 18, 2020
Bilog Antenna	Schwarzbeck	VULB9163	142	May 19, 2019	May 18, 2020
Loop Antenna	ARA	PLA-1030/B	1029	May 19, 2019	May 18, 2020
Horn Antenna	Schwarzbeck	BBHA 9170	BBHA9170399	May 19, 2019	May 18, 2020
Horn Antenna	Schwarzbeck	BBHA 9120	D143	May 19, 2019	May 18, 2020
Cable	Schwarzbeck	AK9513	ACRX1	May 19, 2019	May 18, 2020
Cable	Rosenberger	N/A	FP2RX2	May 19, 2019	May 18, 2020
Cable	Schwarzbeck	AK9513	CRPX1	May 19, 2019	May 18, 2020
Cable	Schwarzbeck	AK9513	CRRX2	May 19, 2019	May 18, 2020

4.2.3 Radio Frequency Test Equipment

EQUIPMENT TYPE	MFR	MODEL NUMBER	SERIAL NUMBER	LAST CAL.	DUE CAL.
Spectrum Analyzer	Agilent	E4407B	88156318	May 19, 2019	May 18, 2020
Signal Analyzer	Agilent	N9010A	My53470879	May 19, 2019	May 18, 2020
Power meter	Anritsu	ML2495A	0824006	May 19, 2019	May 18, 2020
Power sensor	Anritsu	MA2411B	0738172	May 19, 2019	May 18, 2020
Spectrum Analyzer	Rohde & Schwarz	FSV40	100967	May 19, 2019	May 18, 2020

Remark: Each piece of equipment is scheduled for calibration once a year.

4.3 DESCRIPTION OF TEST MODES

The EUT has been tested under its typical operating condition.

The EUT configuration for testing is installed on RF field strength measurement to meet the Commissions requirement and operating in a manner which intends to maximize its emission characteristics in a continuous normal application.

The Transmitter was operated in the normal operating mode. The TX frequency was fixed which was for the purpose of the measurements.

Test of channel included the lowest and middle and highest frequency to perform the test, then record on this report.

Those data rates (1Mbps for GFSK modulation, 2Mbps for $\pi/4$ -DQPSK modulation, 3Mbps for 8DPSK modulation) were used for all test.

Pre-defined engineering program for regulatory testing used to control the EUT for staying in continuous transmitting and receiving mode is programmed.

Frequency and Channel list:

Channel	Frequency (MHz)	Channel	Frequency (MHz)	Channel	Frequency (MHz)
0	2402	39	2441
1	2403	40	2442	76	2478
2	2404	41	2443	77	2479
...	78	2480
Note: $f_c = 2402\text{MHz} + (k-1) \times 1\text{MHz}$ k=1 to 79					

Test Frequency and channel:

Lowest Frequency		Middle Frequency		Highest Frequency	
Channel	Frequency (MHz)	Channel	Frequency (MHz)	Channel	Frequency (MHz)
0	2402	39	2441	78	2480

5 FACILITIES AND ACCREDITATIONS

5.1 FACILITIES

All measurement facilities used to collect the measurement data are located at

Bldg 69, Majialong Industry Zone District, Nanshan District, Shenzhen, China

The sites are constructed in conformance with the requirements of ANSI C63.7, ANSI C63.10 and CISPR Publication 22.

5.2 LABORATORY ACCREDITATIONS AND LISTINGS

Site Description

EMC Lab.

: Accredited by CNAS, 2018.11.30
The certificate is valid until 2022.10.28
The Laboratory has been assessed and proved to be in compliance with
CNAS-CL01:2006 (identical to ISO/IEC 17025:2017)
The Certificate Registration Number is L2291

Accredited by TUV Rheinland Shenzhen 2018.3.30
The Laboratory has been assessed according to the requirements
ISO/IEC 17025

Accredited by FCC, August 09, 2018
Designation Number: CN1204
Test Firm Registration Number: 882943
Accredited by A2LA, August 08, 2018
The Certificate Registration Number is 4321.01

Accredited by Industry Canada, November 09, 2018
The Certificate Registration Number is CN0008

Name of Firm : EMTEK (SHENZHEN) CO., LTD.

Site Location : Bldg 69, Majialong Industry Zone,
Nanshan District, Shenzhen, Guangdong, China

6 TEST SYSTEM UNCERTAINTY

The following measurement uncertainty levels have been estimated for tests performed on the apparatus:

Parameter	Uncertainty
Radio Frequency	$\pm 1 \times 10^{-5}$
Maximum Peak Output Power Test	$\pm 1.0\text{dB}$
Conducted Emissions Test	$\pm 2.0\text{dB}$
Radiated Emission Test	$\pm 2.0\text{dB}$
Occupied Bandwidth Test	$\pm 1.0\text{dB}$
Band Edge Test	$\pm 3\text{dB}$
All emission, radiated	$\pm 3\text{dB}$
Antenna Port Emission	$\pm 3\text{dB}$
Temperature	$\pm 0.5^{\circ}\text{C}$
Humidity	$\pm 3\%$

Measurement Uncertainty for a level of Confidence of 95%

7 SETUP OF EQUIPMENT UNDER TEST

7.1 RADIO FREQUENCY TEST SETUP 1

The component's antenna ports(s) of the EUT are connected to the measurement instrument per an appropriate attenuator. The EUT is controlled by PC/software to emit the specified signals for the purpose of measurements.

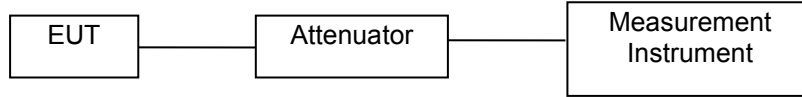

7.2 RADIO FREQUENCY TEST SETUP 2

The test site semi-anechoic chamber has met the requirement of NSA tolerance 4 dB according to the standards: ANSI C63.10. The test distance is 3m. The setup is according to the requirements in Section 13.1.4.1 of ANSI C63.10-2013 and CAN/CSA-CEI/IEC CISPR 22.

Below 30MHz:

The EUT is placed on a turntable 0.8meters above the ground in the chamber, 3 meter away from the antenna (loop antenna). The Antenna should be positioned with its plane vertical at the specified distance from the EUT and rotated about its vertical axis for maximum response at each azimuth about the EUT. The center of the loop shall be 1 m above the ground. For certain applications, the loop antenna plane may also need to be positioned horizontally at the specified distance from the EUT.

Above 30MHz:

The EUT is placed on a turntable 0.8meters above the ground in the chamber, 3 meter away from the antenna. The maximal emission value is acquired by adjusting the antenna height, polarisation and turntable azimuth. Normally, the height range of antenna is 1 m to 4 m, the azimuth range of turntable is 0° to 360°, and the receive antenna has two polarizations Vertical (V) and Horizontal (H).

Above 1GHz:

(Note: the FCC's permission to use 1.5m as an alternative per TCBC Conf call of Dec. 2, 2014.)

The EUT is placed on a turntable 1.5 meters above the ground in the chamber, 3 meter away from the antenna. The maximal emission value is acquired by adjusting the antenna height, polarisation and turntable azimuth. Normally, the height range of antenna is 1 m to 4 m, the azimuth range of turntable is 0° to 360°, and the receive antenna has two polarizations Vertical (V) and Horizontal (H).

(a) Radiated Emission Test Set-Up, Frequency Below 30MHz

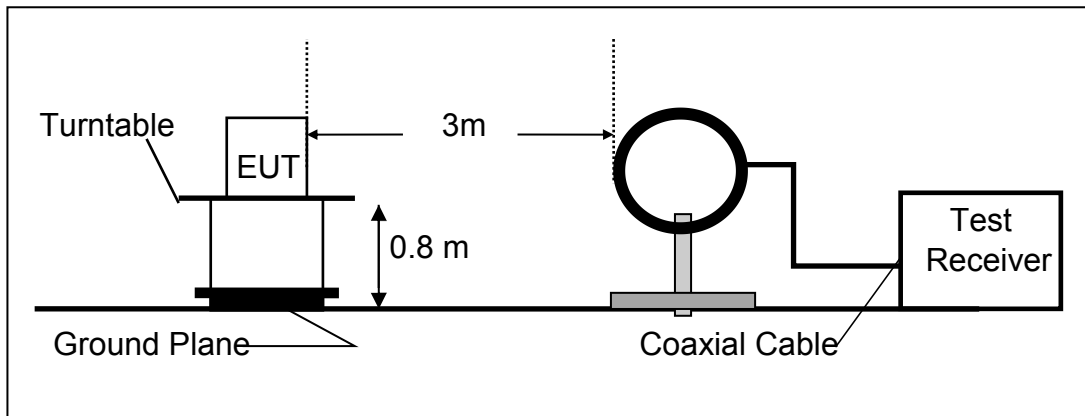

(b) Radiated Emission Test Set-Up, Frequency Below 1000MHz

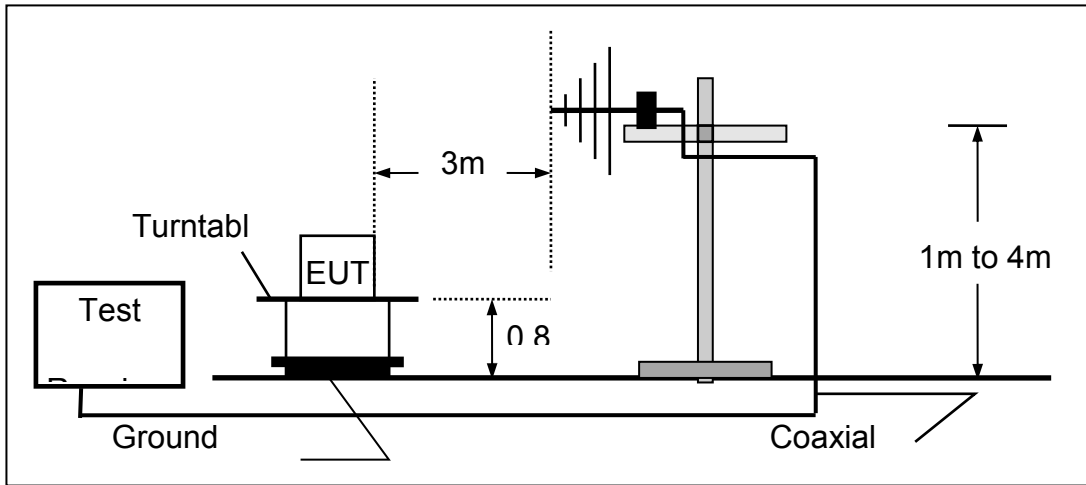

(c) Radiated Emission Test Set-Up, Frequency above 1000MHz

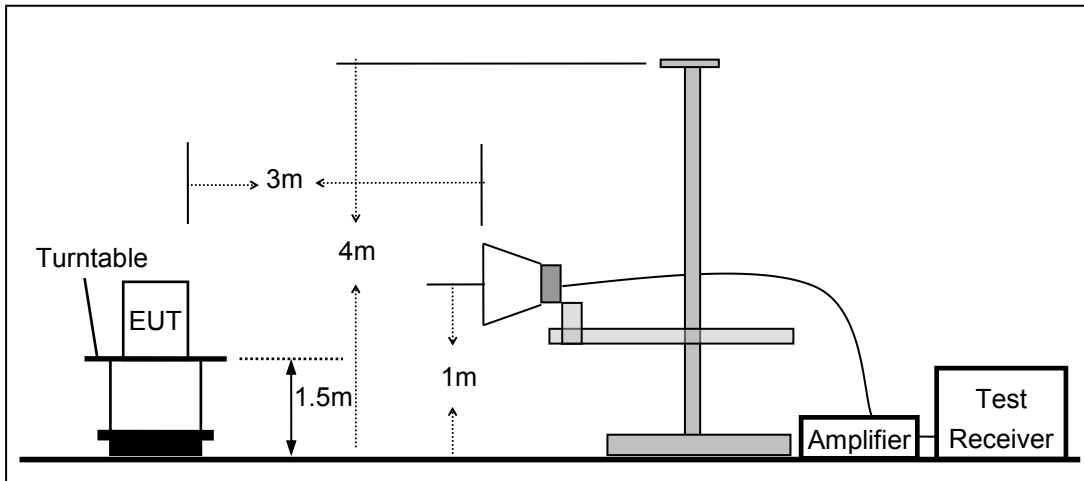

7.3 CONDUCTED EMISSION TEST SETUP

The mains cable of the EUT (Perfect Share Mini) must be connected to LISN. The LISN shall be placed 0.8m from the boundary of EUT and bonded to a ground reference plane for LISN mounted on top of the ground reference plane. This distance is between the closest points of the LISN and the EUT. All other units of the EUT and associated equipment shall be at least 0.8m from the LISN.

Ground connections, where required for safety purposes, shall be connected to the reference ground point of the LISN and, where not otherwise provided or specified by the manufacturer, shall be of same length as the mains cable and run parallel to the mains connection at a separation distance of not more than 0.8m.

According to the requirements in Section 13.1.4.1 of ANSI C63.10-2013 Conducted emissions from the EUT measured in the frequency range between 0.15 MHz and 30 MHz using CISPR Quasi-Peak and average detector mode.

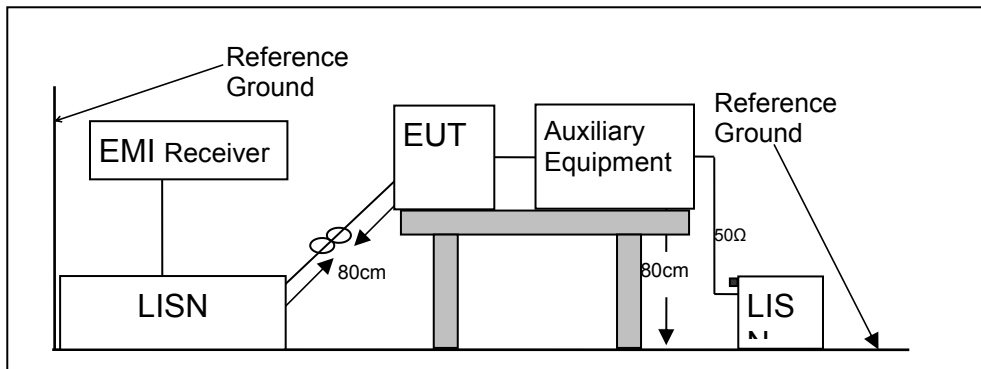

7.4 BLOCK DIAGRAM CONFIGURATION OF TEST SYSTEM

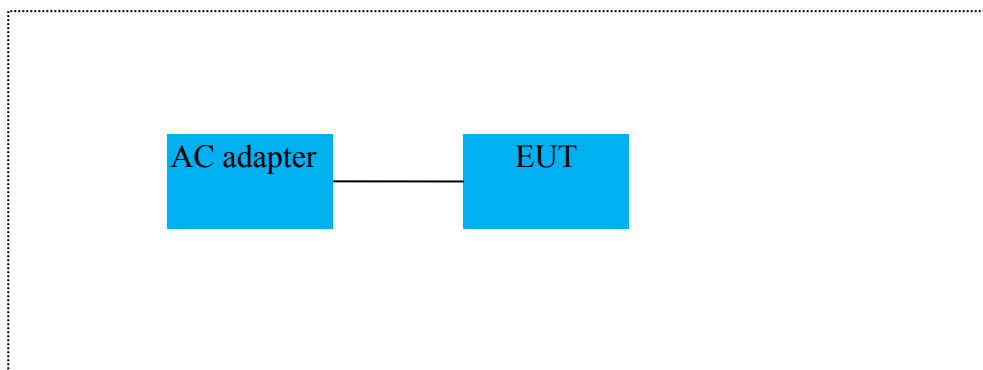

7.5 SUPPORT EQUIPMENT

EUT Cable List and Details					
Cable Description	Length (m)	Shielded /Unshielded	With / Without Ferrite	Supplied by	Certification
USB cable	0.8	Unshielded	Without Ferrite	Client	/

Auxiliary Cable List and Details					
Cable Description	Length (m)	Shielded /Unshielded	With / Without Ferrite	Supplied by	Certification
/	/	/	/	/	/

Auxiliary Equipment List and Details					
Description	Manufacturer	Model	Serial Number	Supplied by	Certification
Adapter	XIAOMI	MDY-08-EZ	2C41803T800050A	EMTEK	FCC

Notes:

1. All the equipment/cables were placed in the worst-case configuration to maximize the emission during the test.
2. Grounding was established in accordance with the manufacturer's requirements and conditions for the intended use.

8 FREQUENCY HOPPING SYSTEM REQUIREMENTS

8.1 Standard Applicable

According to FCC Part 15.247(a)(1), The system shall hop to channel frequencies that are selected at the system hopping rate from a pseudo randomly ordered list of hopping frequencies. Each frequency must be used equally on the average by each transmitter. The system receivers shall have input bandwidths that match the hopping channel bandwidths of their corresponding transmitters and shall shift frequencies in synchronization with the transmitted signals.

(g) Frequency hopping spread spectrum systems are not required to employ all available hopping channels during each transmission. However, the system, consisting of both the transmitter and the receiver, must be designed to comply with all of the regulations in this section should the transmitter be presented with a continuous data (or information) stream. In addition, a system employing short transmission bursts must comply with the definition of a frequency hopping system and must distribute its transmissions over the minimum number of hopping channels specified in this section.

(h) The incorporation of intelligence within a frequency hopping spread spectrum system that permits the system to recognize other users within the spectrum band so that it individually and independently chooses and adapts its hopsets to avoid hopping on occupied channels is permitted. The coordination of frequency hopping systems in any other manner for the express purpose of avoiding the simultaneous occupancy of individual hopping frequencies by multiple transmitters is not permitted.

8.2 EUT Pseudorandom Frequency Hopping Sequence

The channel is represented by a pseudo-random hopping sequence hopping through the 79 RF channels. The hopping sequence is unique for the piconet and is determined by the Bluetooth device address of the master; the phase in the hopping sequence is determined by the Bluetooth clock of the master. The channel is divide into time slots where each slot corresponds to an RF hop frequency. Consecutive hops correspond to different RF hop frequencies. The normal hop is 1 600 hops/s.

The pseudorandom sequence may be generated in a nine-stage shift register whose 5th and 9th stage outputs are added in a modulo-two addition stage, and the result is fed back to the input of the first stage. The sequence begins with the first ONE of 9 consecutive ONES; i.e. the shift register is initialized with nine ones. Number of shift register stages: 9
Length of pseudo-random sequence: $2^9 - 1 = 511$ bits
Longest sequence of zeros: 8 (non-inverted signal)

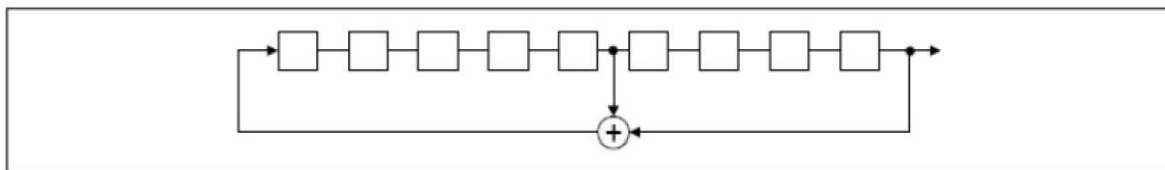

Linear Feedback Shift Register for Generation of the PRBS sequence

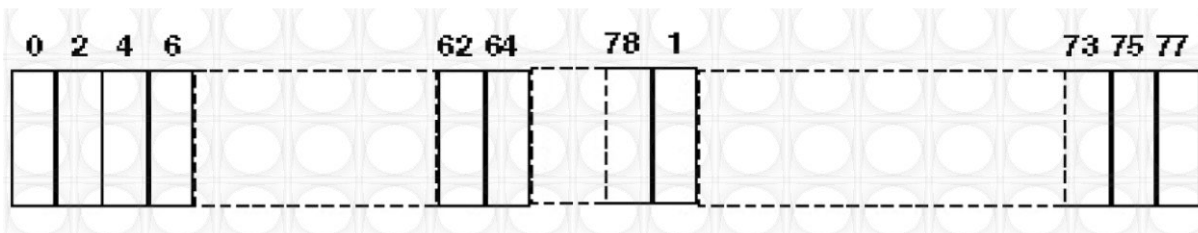

Each frequency used equally on the average by each transmitter.
The system receiver have input bandwidths that match the hopping channel bandwidths of their corresponding transmitters and shift frequencies in synchronization with the transmitted signals.

8.3 Equal Hopping Frequency Use

All Bluetooth units participating in the piconet are time and hop-synchronized to the channel.

Example of a 79 hopping sequence in data mode:

35, 27, 6, 44, 14, 61, 74, 32, 1, 11, 23, 2, 55, 65, 29, 3, 9, 52, 78, 58, 40, 25, 0, 7, 18, 26, 76, 60, 47, 50, 2, 5, 16, 37, 70, 63, 66, 54, 20, 13, 4, 8, 15, 21, 26, 10, 73, 77, 67, 69, 43, 24, 57, 39, 46, 72, 48, 33, 17, 31, 75, 19, 41, 62, 68, 28, 51, 66, 30, 56, 34, 59, 71, 22, 49, 64, 38, 45, 36, 42, 53

Each Frequency used equally on the average by each transmitter

8.4 Frequency Hopping System

This transmitter device is frequency hopping device, and complies with FCC part 15.247 rule.

This device uses Bluetooth radio which operates in 2400-2483.5 MHz band. Bluetooth uses a radio technology called frequency-hopping spread spectrum, which chops up the data being sent and transmits chunks of it on up to 79 bands (1 MHz each; centred from 2402 to 2480 MHz) in the range 2,400-2,483.5 MHz. The transmitter switches hop frequencies 1,600 times per second to assure a high degree of data security. All Bluetooth devices participating in a given piconet are synchronized to the frequency-hopping channel for the piconet. The frequency hopping sequence is determined by the master's device address and the phase of the hopping sequence (the frequency to hop at a specific time) is determined by the master's internal clock. Therefore, all slaves in a piconet must know the master's device address and must synchronize their clocks with the master's clock.

Adaptive Frequency Hopping (AFH) was introduced in the Bluetooth specification to provide an effective way for a Bluetooth radio to counteract normal interference. AFH identifies "bad" channels, where either other wireless devices are interfering with the Bluetooth signal or the Bluetooth signal is interfering with another device. The AFH-enabled Bluetooth device will then communicate with other devices within its piconet to share details of any identified bad channels. The devices will then switch to alternative available "good" channels, away from the areas of interference, thus having no impact on the bandwidth used.

9 TEST REQUIREMENTS

9.1 20DB BANDWIDTH

9.1.1 Applicable Standard

According to FCC Part 15.247(a)(1) and KDB 558074 D01 15.247 MEAS GUIDANCE v05r02

9.1.2 Conformance Limit

No limit requirement.

9.1.3 Test Configuration

Test according to clause 7.1 radio frequency test setup 1

9.1.4 Test Procedure

The EUT was operating in Bluetooth mode and controlled its channel. Printed out the test result from the spectrum by hard copy function.

The RF output of EUT was connected to the spectrum analyzer by RF cable and attenuator. The path loss was compensated to the results for each measurement.

Set to the maximum power setting and enable the EUT transmit continuously

Set RBW = 30 kHz.

Set the video bandwidth (VBW) =100 kHz.

Set Span= approximately 2 to 3 times the 20 dB bandwidth

Set Detector = Peak.

Set Trace mode = max hold.

Set Sweep = auto couple.

The EUT should be transmitting at its maximum data rate. Allow the trace to stabilize. Use the marker-to-peak function to set the marker to the peak of the emission. Use the marker-delta function to measure 20 dB down one side of the emission. Reset the markerdelta function, and move the marker to the other side of the emission, until it is (as close as possible to) even with the reference marker level. The marker-delta reading at this point is the 20 dB bandwidth of the emission.

If this value varies with different modes of operation (e.g., data rate, modulation format, etc.), repeat this test for each variation.

Measure and record the results in the test report.

Test Results

Temperature:	26°C
Relative Humidity:	54%
ATM Pressure:	1011 mbar

Modulation Mode	Channel Number	Channel Frequency (MHz)	20dB Measurement Bandwidth(MHz)	99% Bandwidth (MHz)	Verdict
GFSK	00	2402	0.846	0.840	PASS
	39	2441	0.845	0.838	PASS
	78	2480	0.845	0.838	PASS
$\pi/4$ DQPSK	00	2402	1.283	1.185	PASS
	39	2441	1.283	1.185	PASS
	78	2480	1.283	1.185	PASS
8DPSK	00	2402	1.252	1.184	PASS
	39	2441	1.253	1.184	PASS
	78	2480	1.254	1.184	PASS

Note: N/A (Not Applicable)

Test Model 20dB Bandwidth
Channel 0: 2402MHz GFSK Modulation

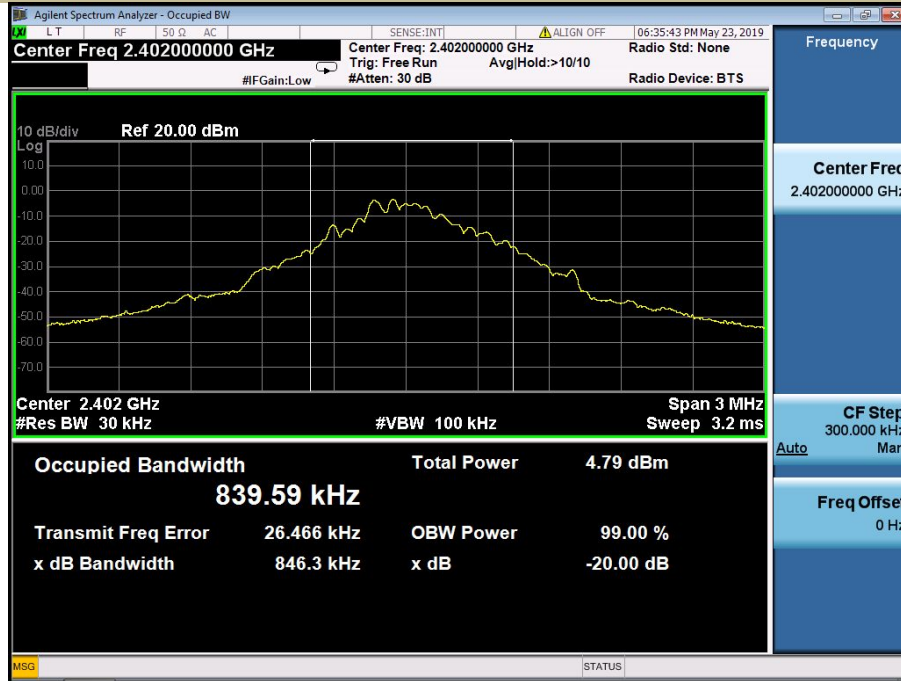

Test Model 20dB Bandwidth
Channel 39: 2441MHz GFSK Modulation

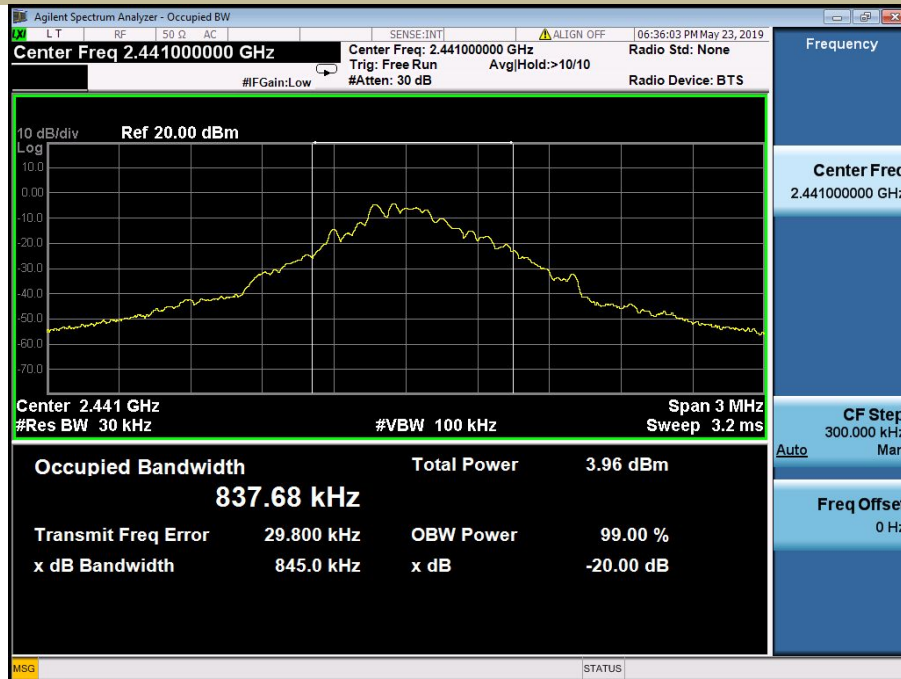

Test Model 20dB Bandwidth
Channel 78: 2480MHz GFSK Modulation

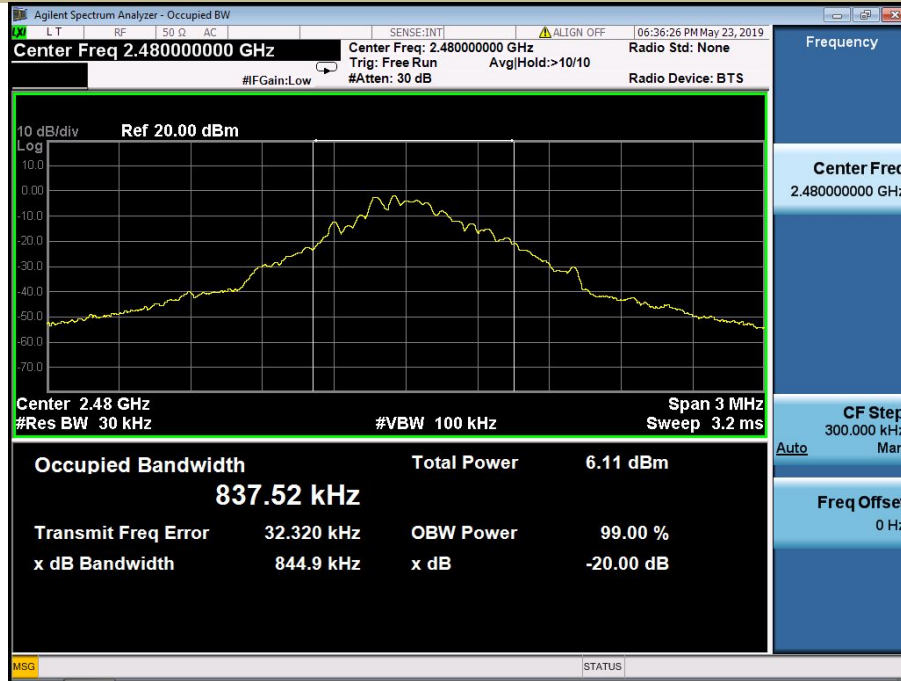

Test Model 20dB Bandwidth
Channel 0: 2402MHz $\pi/4$ -DQPSK Modulation

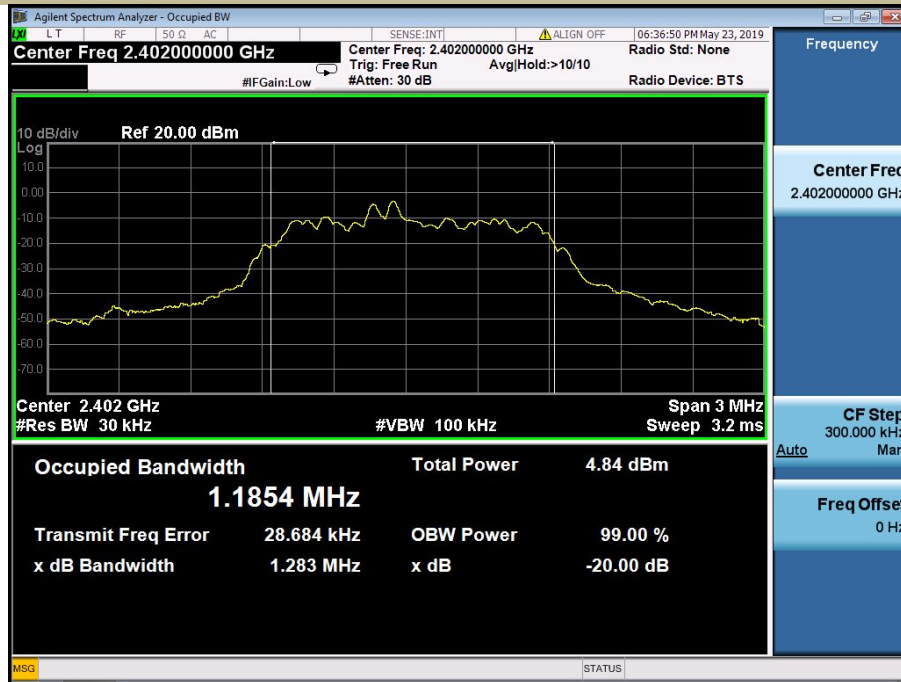

Test Model 20dB Bandwidth
Channel 39: 2441MHz π /4-DQPSK Modulation

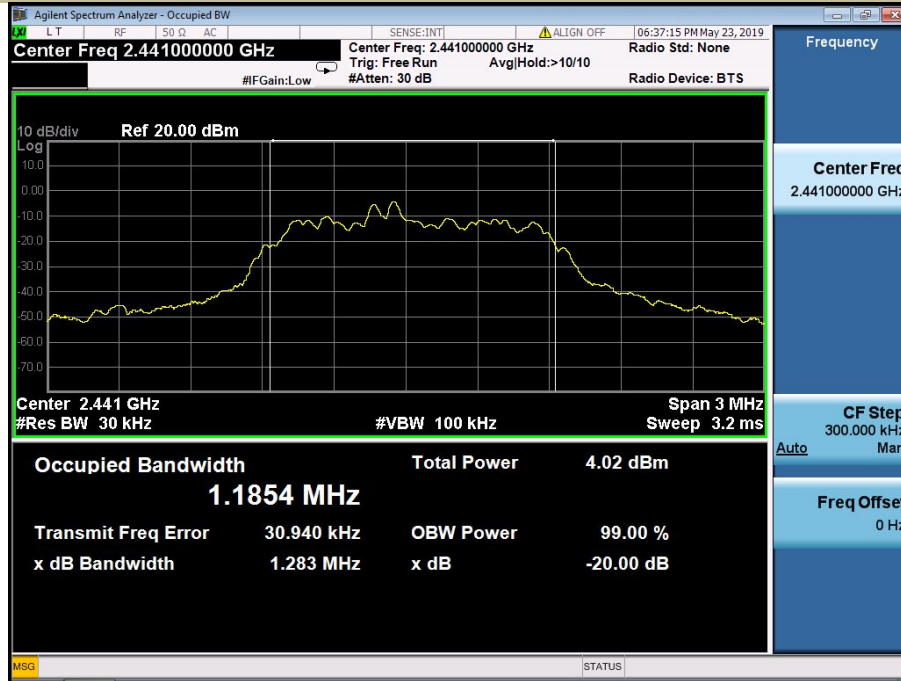

Test Model 20dB Bandwidth
Channel 78: 2480MHz π /4-DQPSK Modulation

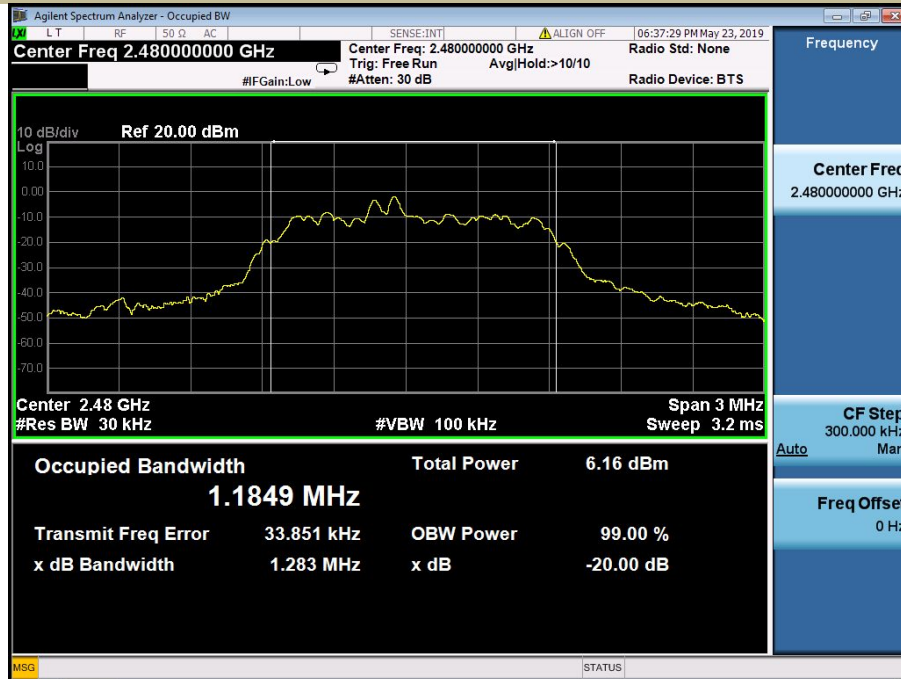

Test Model

20dB Bandwidth

Channel 0: 2402MHz

8DPSK Modulation

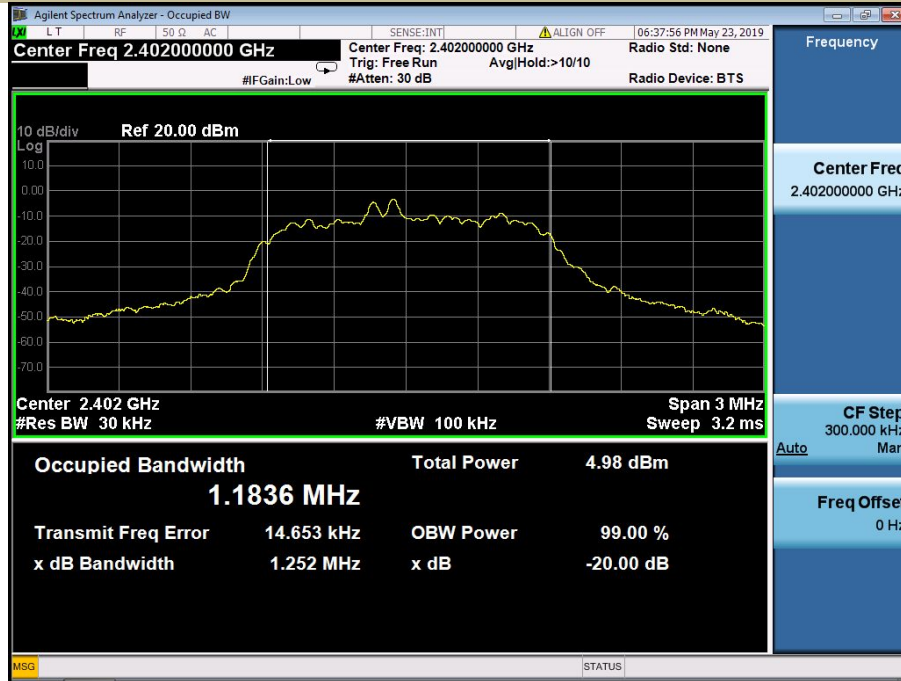

Test Model

20dB Bandwidth

Channel 39: 2441MHz

8DPSK Modulation

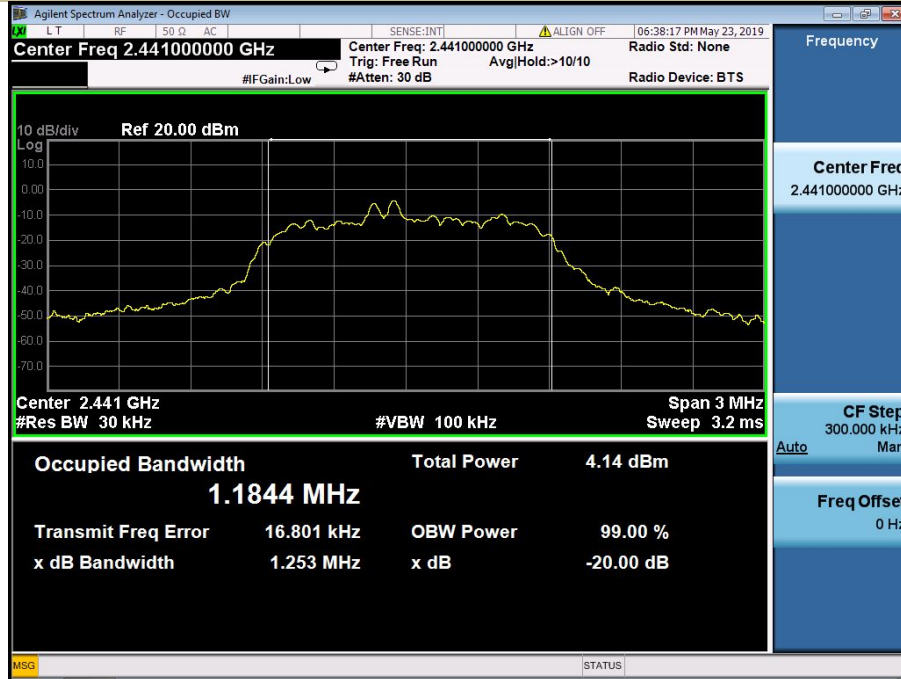

Test Model 20dB Bandwidth
Channel 78: 2480MHz 8DPSK Modulation

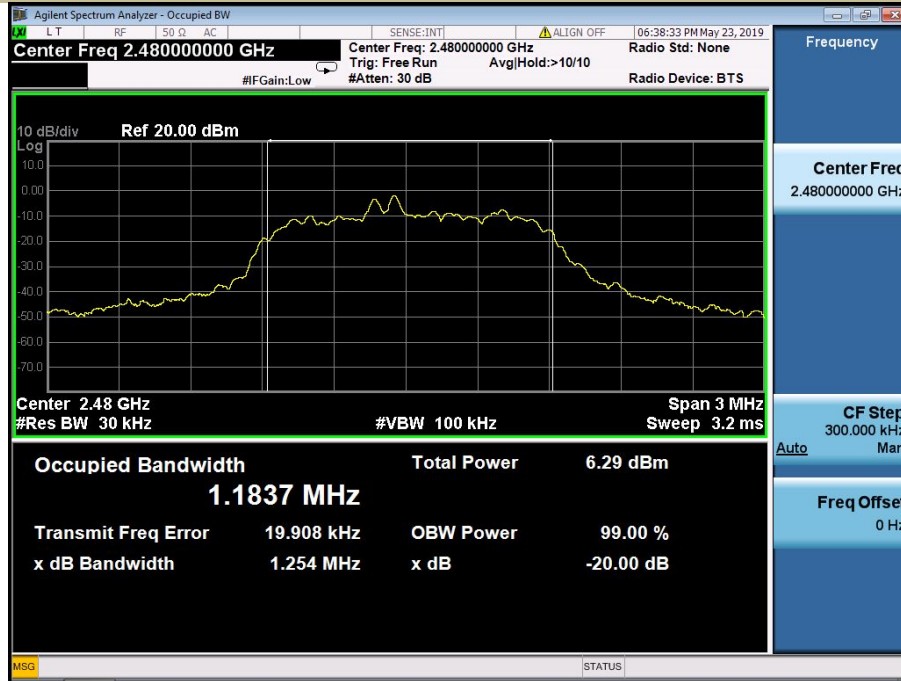

9.2 CARRIER FREQUENCY SEPARATION

9.2.1 Applicable Standard

According to FCC Part 15.247(a)(1) and KDB 558074 D01 15.247 MEAS GUIDANCE v05r02

9.2.2 Conformance Limit

Frequency hopping systems operating in the 2400-2483.5MHz band shall have hopping channel carrier frequencies separated by a minimum of 25kHz or the 20dB bandwidth of the hopping channel, whichever is greater.

In case of an output power less than 125mW, the frequency hopping system may have channels separated by a minimum of 25kHz or two-thirds of the 20dB bandwidth of the hopping channel, whichever is greater.

9.2.3 Test Configuration

Test according to clause 7.1 radio frequency test setup 1

9.2.4 Test Procedure

- According to FCC Part 15.247(a)(1)
The EUT must have its hopping function enabled. Use the following spectrum analyzer settings:
Set the RBW =100kHz. Set VBW =300kHz.
Set the span = wide enough to capture the peaks of two adjacent channels
Set Sweep time = auto couple.
Set Detector = peak. Set Trace mode = max hold.
Allow the trace to stabilize. Use the marker-delta function to determine the separation between the peaks of the adjacent channels. The limit is specified in one of the subparagraphs of this Section. Submit this plot.

Test Results

Temperature:	26°C
Relative Humidity:	54%
ATM Pressure:	1011 mbar

Modulation Mode	Channel Number	Channel Frequency (MHz)	Measurement Bandwidth (kHz)	Limit (kHz)	Verdict
GFSK	0	2402	999	>564	PASS
	39	2441	1002	>563	PASS
	78	2480	1005	>563	PASS
π /4DQPSK	0	2402	999	>855	PASS
	39	2441	1002	>855	PASS
	78	2480	1002	>855	PASS
8DPSK	0	2402	999	>835	PASS
	39	2441	1002	>835	PASS
	78	2480	999	>846	PASS

Note: Limit > 20dB bandwidth * 2/3

Test Model

Carrier Frequency Separation

Channel 0: 2402MHz

GFSK Modulation



Test Model

Carrier Frequency Separation

Channel 39: 2441MHz

GFSK Modulation

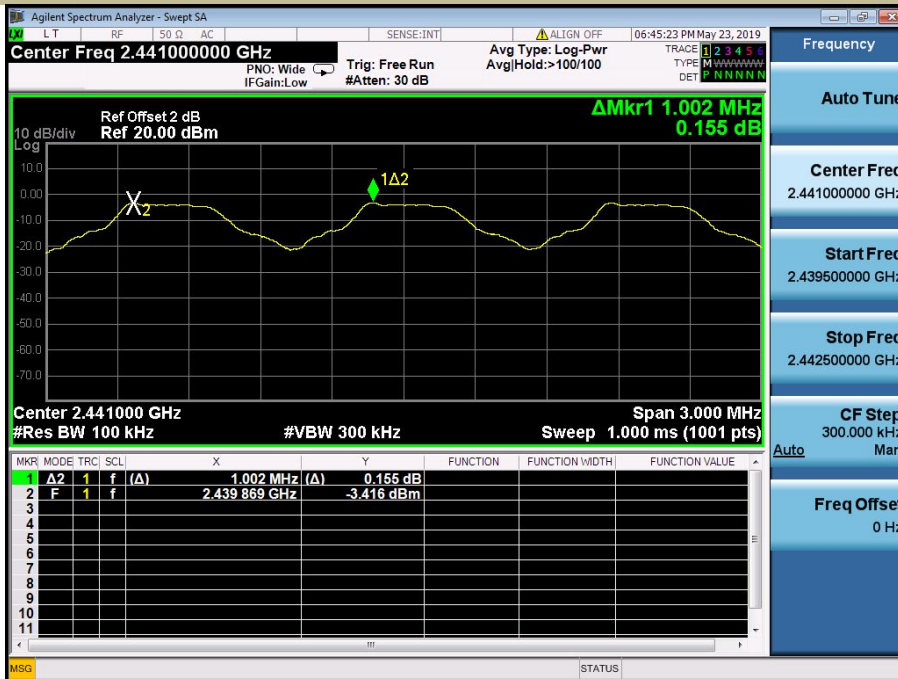

Test Model

Carrier Frequency Separation

Channel 78: 2480MHz

GFSK Modulation

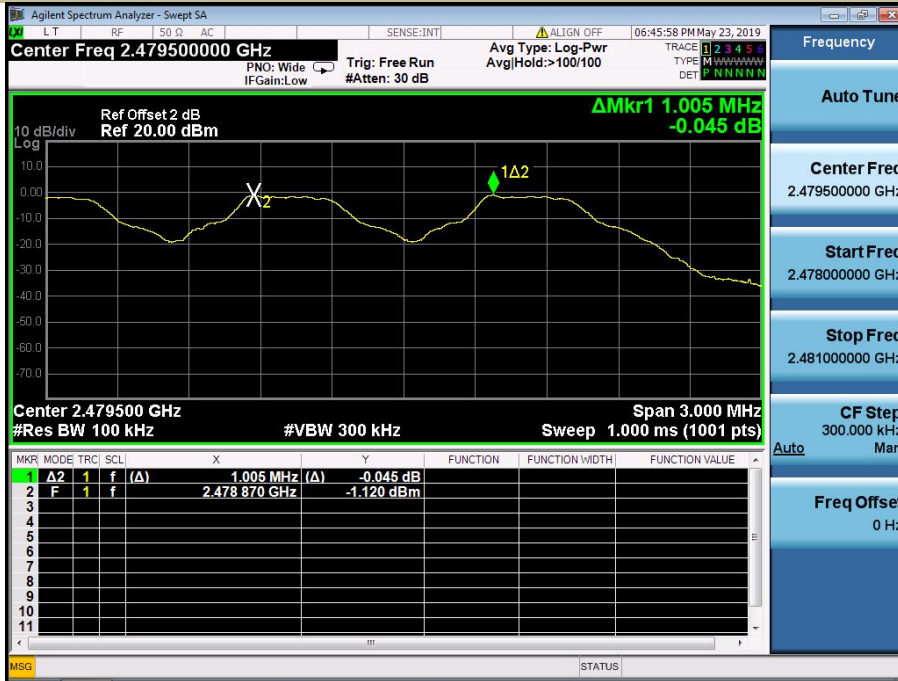

Test Model

Carrier Frequency Separation

Channel 0: 2402MHz

$\pi/4$ -DQPSK Modulation

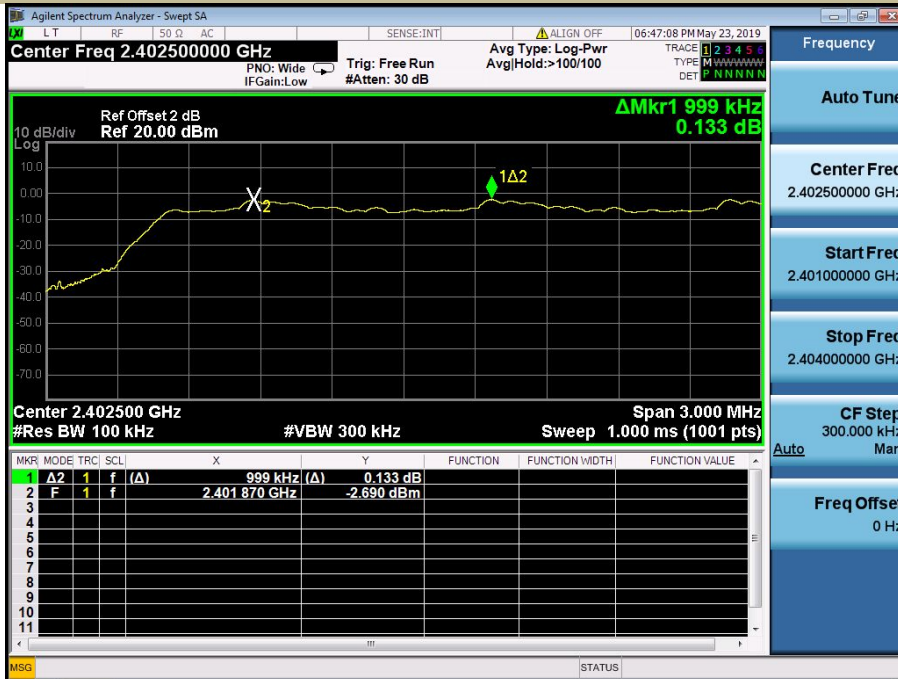

Carrier Frequency Separation
Test Model Channel 39: 2441MHz $\pi/4$ -DQPSK Modulation

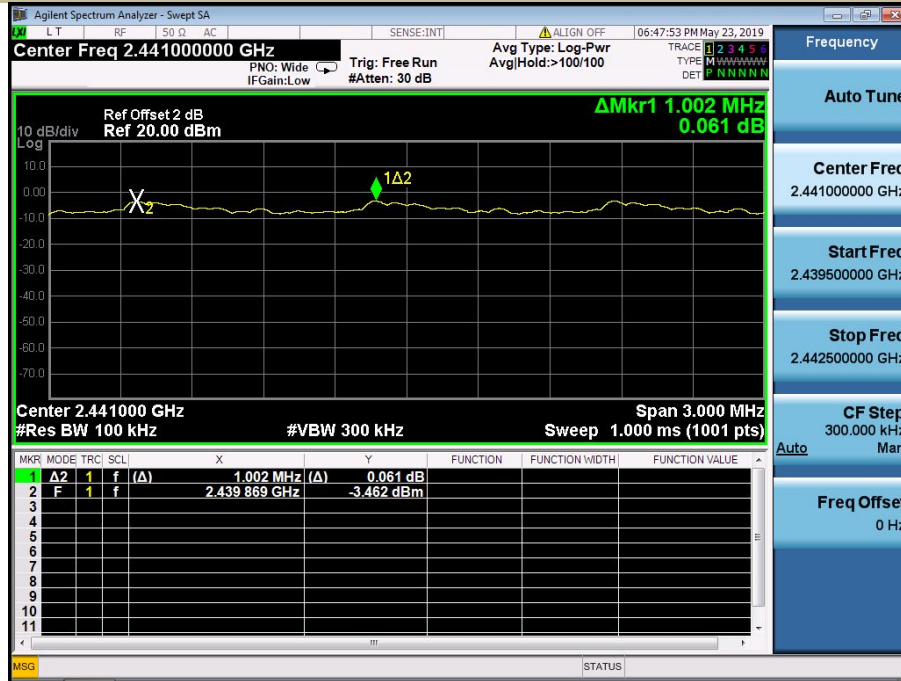

Carrier Frequency Separation
Test Model Channel 78: 2480MHz $\pi/4$ -DQPSK Modulation

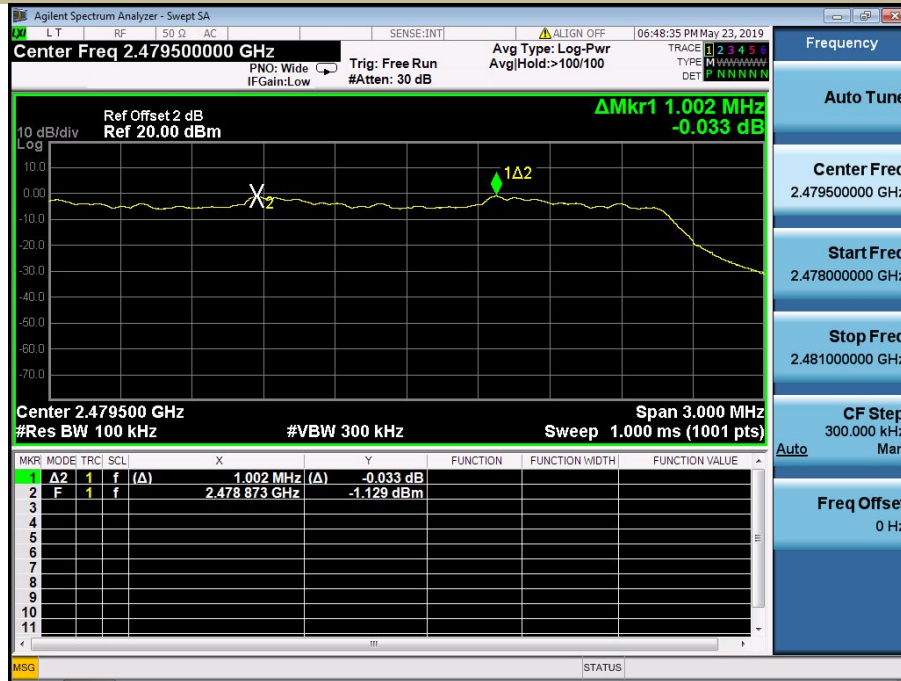

Carrier Frequency Separation
Test Model
Channel 0: 2402MHz 8DPSK Modulation

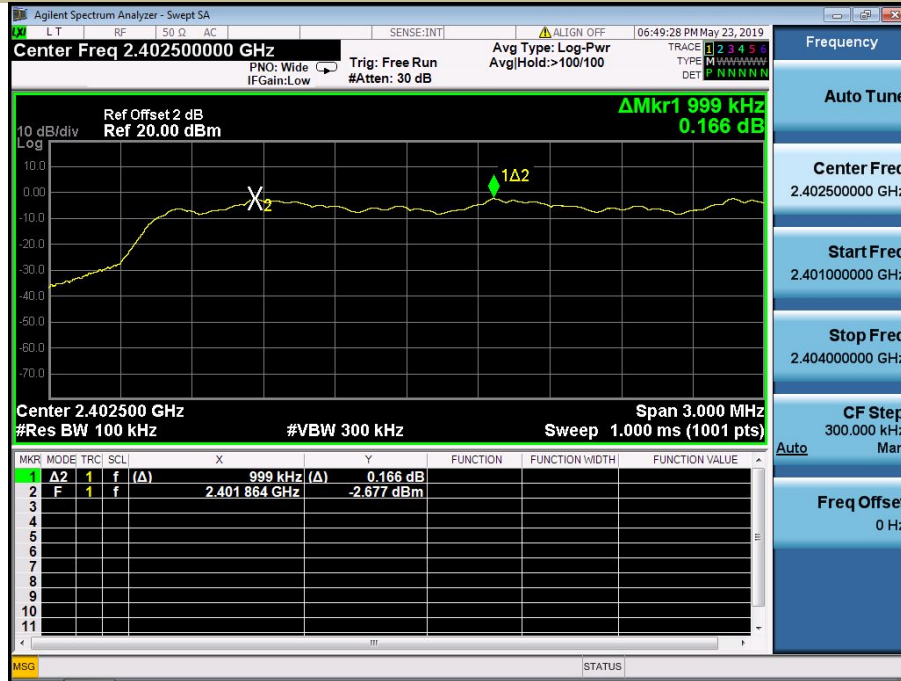

Carrier Frequency Separation
Test Model
Channel 39: 2441MHz 8DPSK Modulation

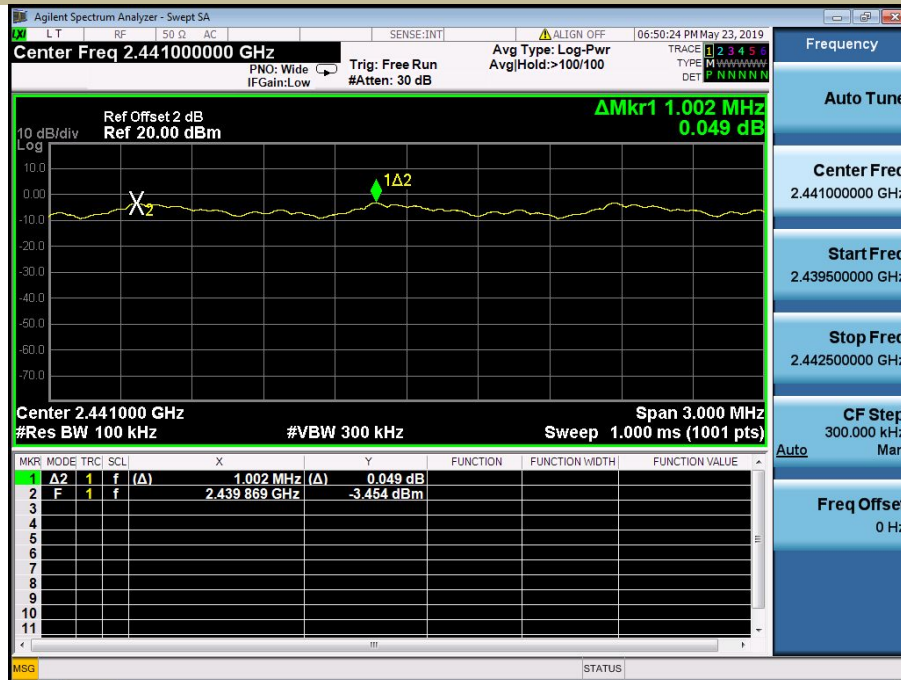

Test Model

Carrier Frequency Separation

Channel 78: 2480MHz

8DPSK Modulation

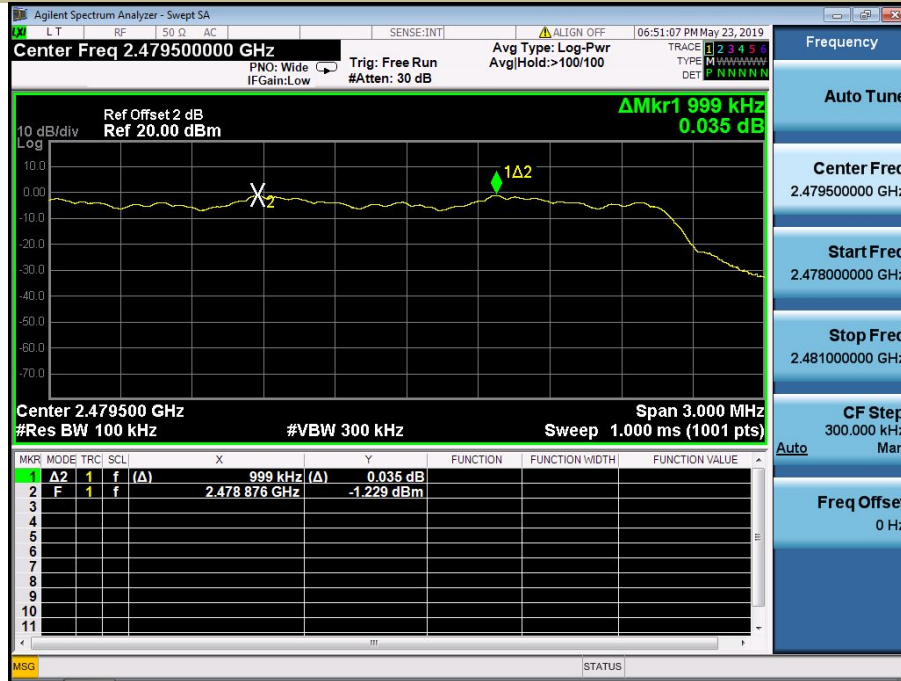

9.3 NUMBER OF HOPPING FREQUENCIES

9.3.1 Applicable Standard

According to FCC Part 15.247(a)(1) (iii) and KDB 558074 D01 15.247 MEAS GUIDANCE v05r02

9.3.2 Conformance Limit

Frequency hopping systems operating in the 2400-2483.5MHz band shall use at least 15 channels.

9.3.3 Test Configuration

Test according to clause 7.1 radio frequency test setup 1

9.3.4 Test Procedure

- According to FCC Part 15.247(a)(1)(iii)

The EUT must have its hopping function enabled. Use the following spectrum analyzer settings:

Span = the frequency band of operation (2400-2483.5MHz)

RBW \geq 100KHz

VBW \geq RBW

Sweep = auto

Detector function = peak

Trace = max hold

Allow the trace to stabilize. It may prove necessary to break the span up to sections, in order to clearly show all of the hopping frequencies.

Test Results

Temperature:	26°C
Relative Humidity:	54%
ATM Pressure:	1011 mbar

Modulation Mode	Hopping Channel Frequency Range	Quantity of Hopping Channel	Quantity of Hopping Channel limit
GFSK	2402-2480	79	> 15
π /4DQPSK	2402-2480	79	> 15
8DPSK	2402-2480	79	> 15

Test Model

Number Of Hopping Frequencies

Span: 2400-2483.5MHz

GFSK Modulation

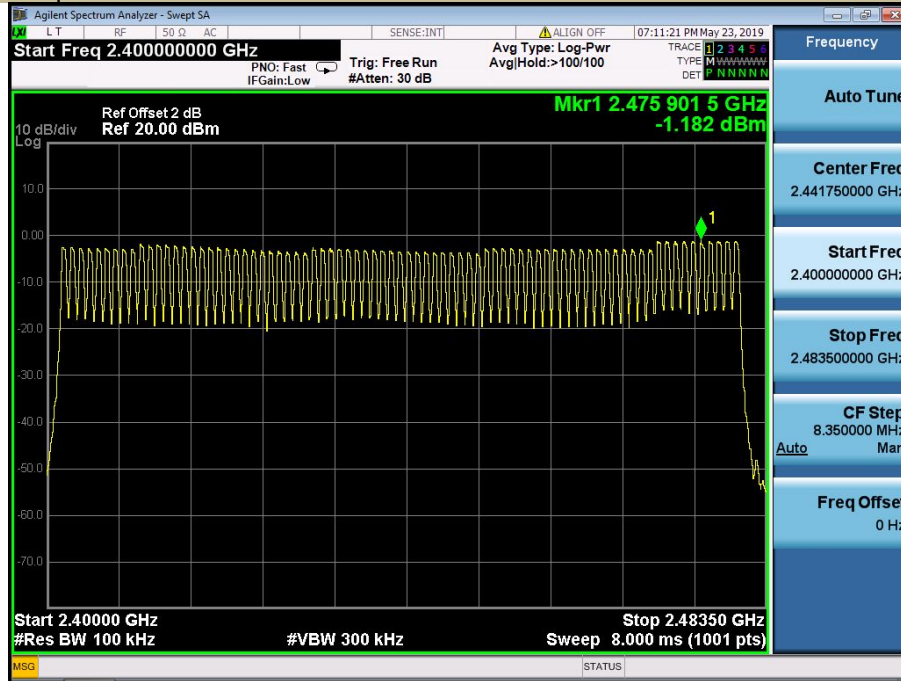

Test Model

Number Of Hopping Frequencies

Span: 2400-2483.5MHz

$\pi/4$ DQPSK Modulation

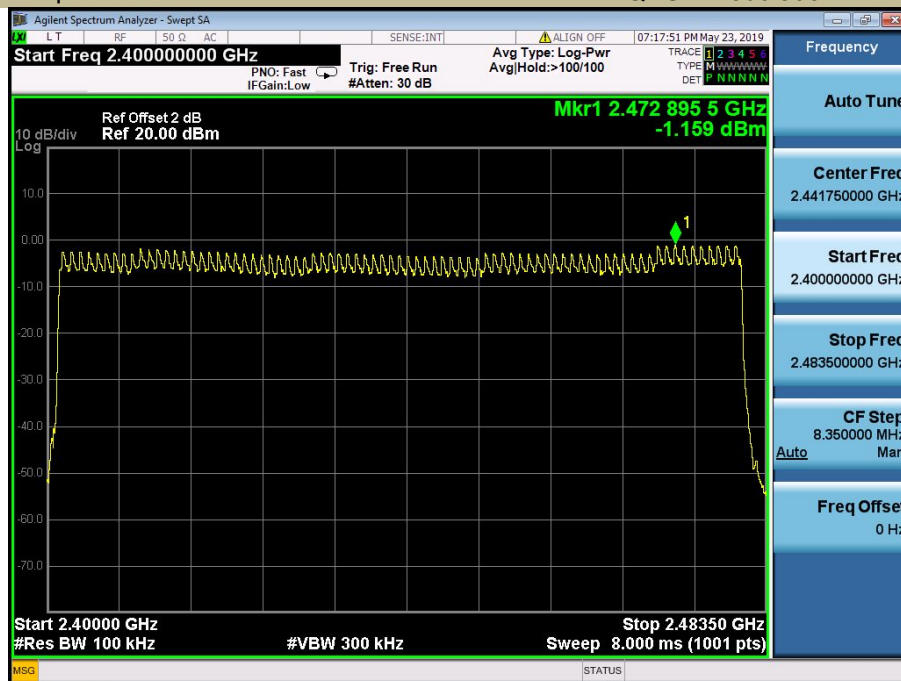

Test Model

Number Of Hopping Frequencies

Span: 2400-2483.5MHz

8DPSK Modulation

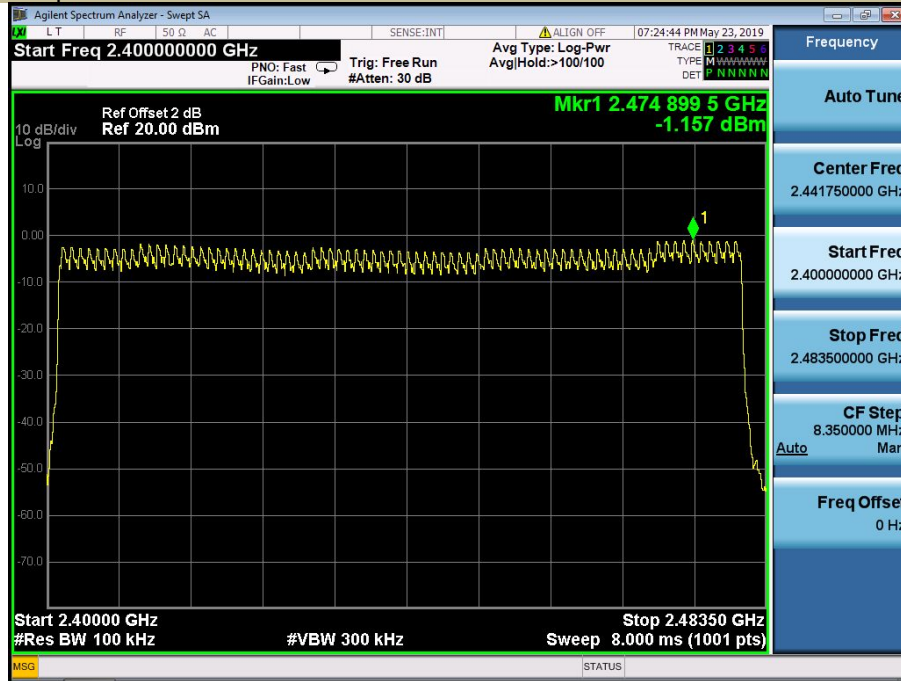

9.4 AVERAGE TIME OF OCCUPANCY (DWELL TIME)

9.4.1 Applicable Standard

According to FCC Part 15.247(a)(1)(iii) and KDB 558074 D01 15.247 MEAS GUIDANCE v05r02

9.4.2 Conformance Limit

For frequency hopping systems operating in the 2400-2483.5MHz band, the average time of occupancy on any channel shall not be greater than 0.4s within a period of 0.4s multiplied by the number of hopping channels employed.

9.4.3 Test Configuration

Test according to clause 7.1 radio frequency test setup 1

9.4.4 Test Procedure

- According to FCC Part 15.247(a)(1)(iii)

The EUT must have its hopping function enabled. Use the following spectrum analyzer settings:

Span = zero span, centered on a hopping channel

RBW = 1 MHz

VBW ≥ RBW

Sweep = as necessary to capture the entire dwell time per hopping channel

Detector function = peak

Trace = max hold

If possible, use the marker-delta function to determine the dwell time. If this value

varies with different modes of operation (e.g., data rate, modulation format, etc.),

repeat this test for each variation. The limit is specified in one of the subparagraphs of this Section.

9.4.5 Test Results

Temperature:	26° C
Relative Humidity:	54%
ATM Pressure:	1011 mbar

Modulation Mode	Channel Number	Packet type	Pulse width (ms)	Dwell Time (ms)	Limit (ms)	Verdict
GFSK	0	DH1	0.407	130.24	<400	PASS
	0	DH3	1.667	266.72	<400	PASS
	0	DH5	2.919	311.36	<400	PASS
Note: Dwell Time(DH1)=PW*(1600/2/79)*31.6 Dwell Time(DH3)=PW*(1600/4/79)*31.6 Dwell Time(DH5)=PW*(1600/6/79)*31.6						

Modulation Mode	Channel Number	Packet type	Pulse width (ms)	Dwell Time (ms)	Limit (ms)	Verdict
π/4DQPSK	0	2DH1	0.401	128.32	<400	PASS
	0	2DH3	1.655	264.8	<400	PASS
	0	2DH5	2.912	310.61	<400	PASS
Note: Dwell Time(2DH1)=PW*(1600/2/79)*31.6 Dwell Time(2DH3)=PW*(1600/4/79)*31.6 Dwell Time(2DH5)=PW*(1600/6/79)*31.6						

Modulation Mode	Channel Number	Packet type	Pluse width (ms)	Dwell Time (ms)	Limit (ms)	Verdict
8DPSK	0	3DH1	0.401	128.32	<400	PASS
	0	3DH3	1.650	264	<400	PASS
	0	3DH5	2.904	309.76	<400	PASS
Note: Dwell Time(3DH1)=PW*(1600/2/79)*31.6 Dwell Time(3DH3)=PW*(1600/4/79)*31.6 Dwell Time(3DH5)=PW*(1600/6/79)*31.6						

Test Model

Average Time Of Occupancy (Dwell Time)

CH 0: 2402MHz

GFSK DH1

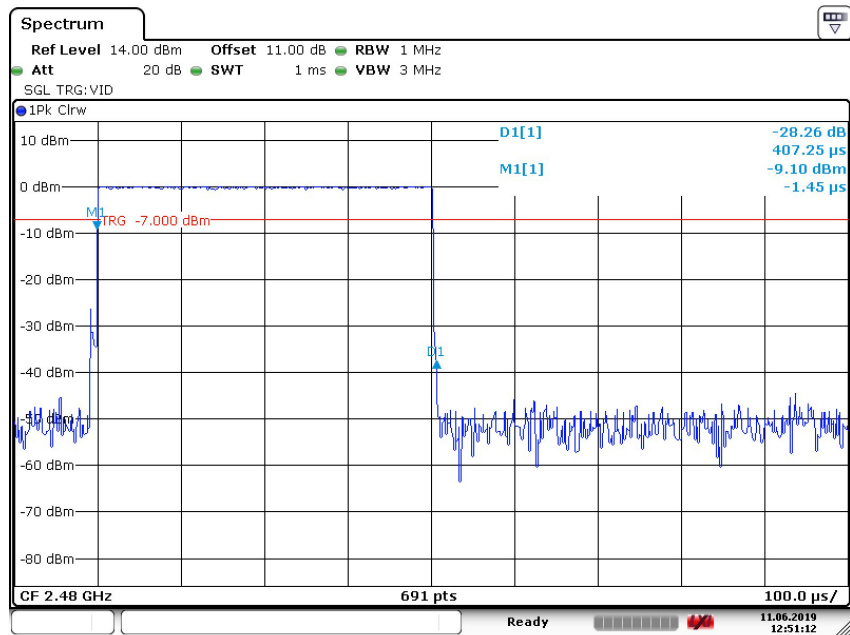

Date: 11.JUN.2019 12:51:12

Test Model

Average Time Of Occupancy (Dwell Time)

CH 0: 2402MHz

GFSK DH3

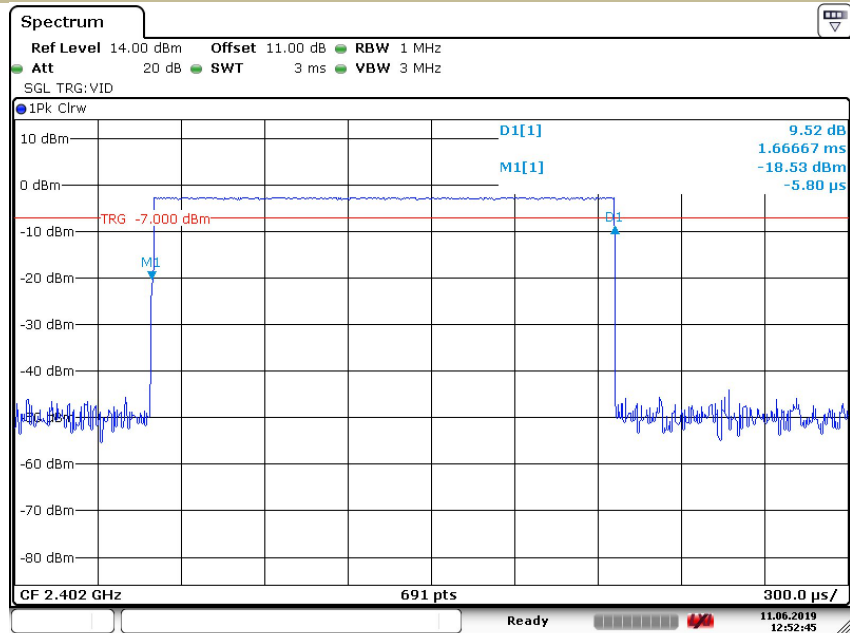

Date: 11.JUN.2019 12:52:46

Test Model

Average Time Of Occupancy (Dwell Time)

CH 0: 2402MHz

GFSK DH5

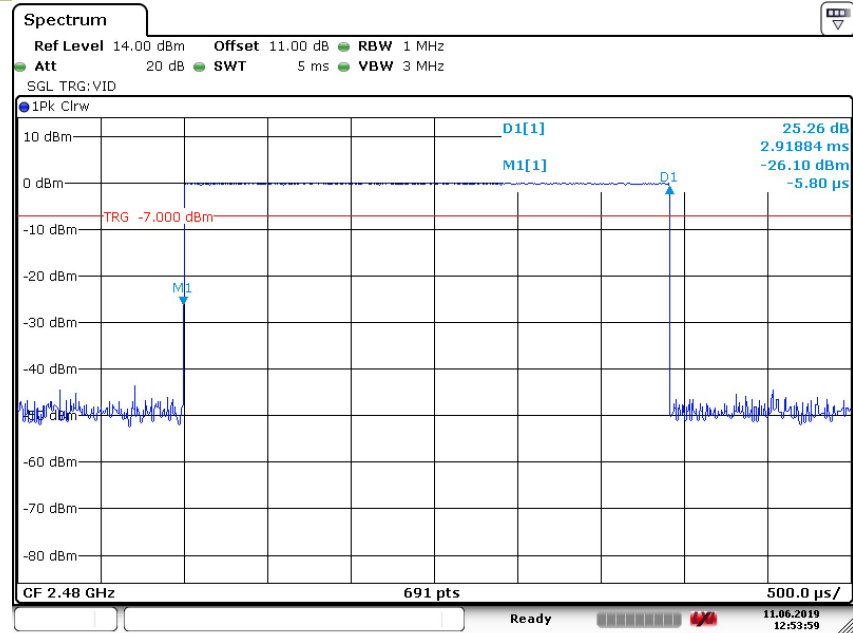

Date: 11.JUN.2019 12:53:59

Test Model

Average Time Of Occupancy (Dwell Time)

CH 0: 2402MHz

π /4QPSK 2DH1

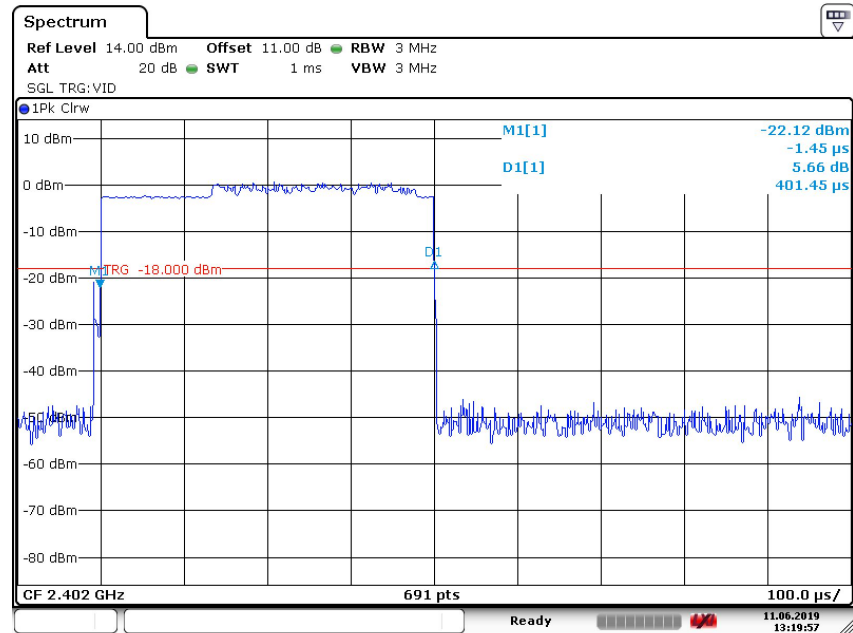

Date: 11.JUN.2019 13:19:57

Test Model

Average Time Of Occupancy (Dwell Time)

CH 0: 2402MHz π /4QPSK 2DH3

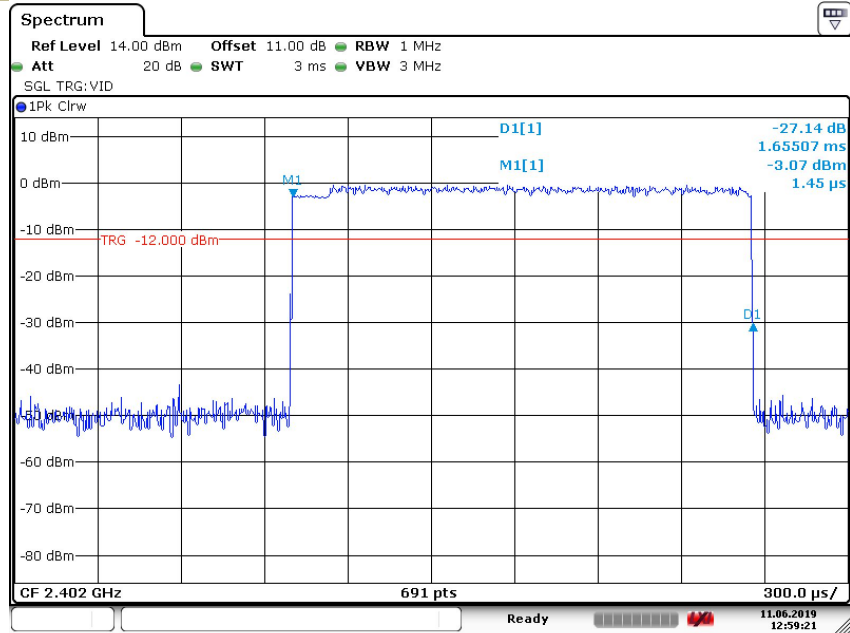

Date: 11.JUN.2019 12:59:21

Test Model

Average Time Of Occupancy (Dwell Time)

CH 0: 2402MHz π /4QPSK 2DH5

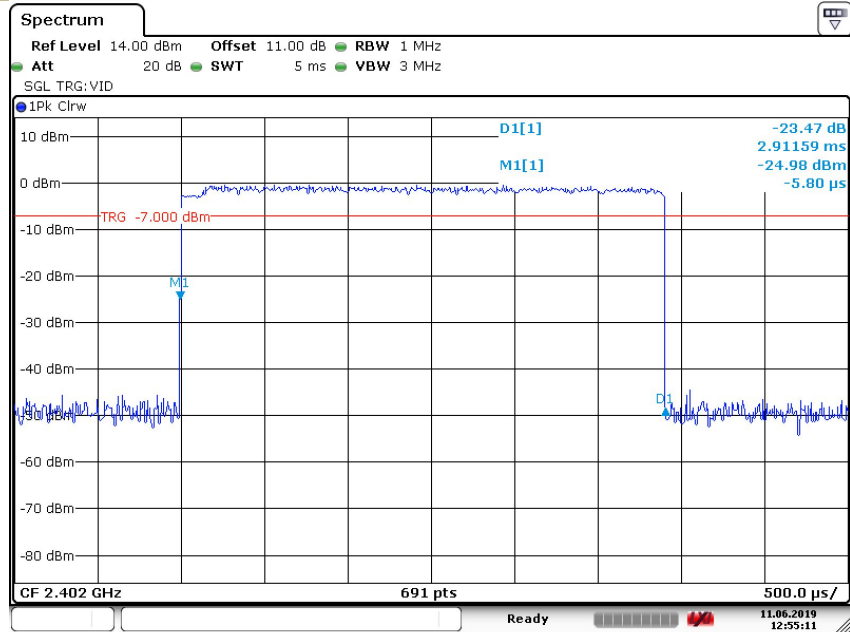

Date: 11.JUN.2019 12:55:11

Test Model

Average Time Of Occupancy (Dwell Time)

CH 0: 2402MHz

8DPSK 3DH1

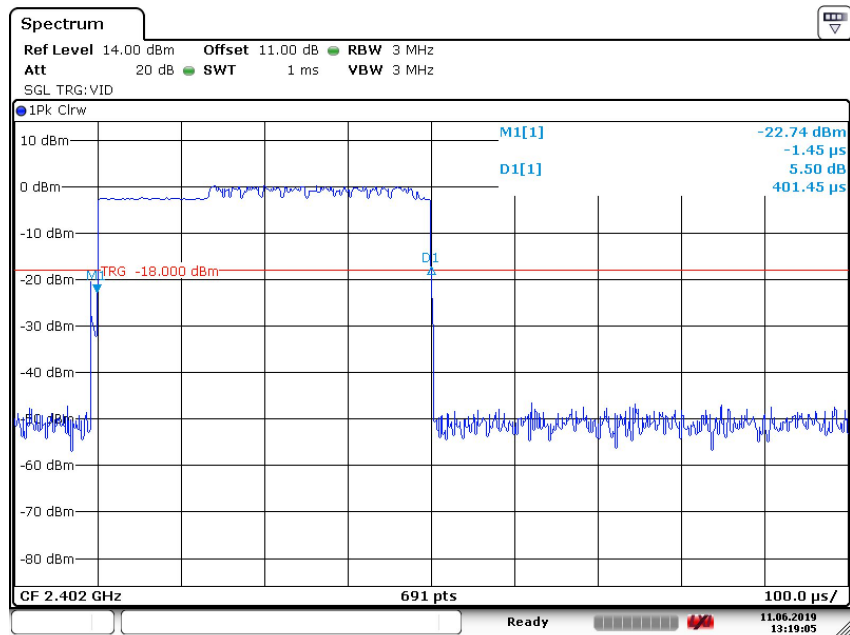

Date: 11.JUN.2019 13:19:05

Test Model

Average Time Of Occupancy (Dwell Time)

CH 0: 2402MHz

8DPSK 3DH3

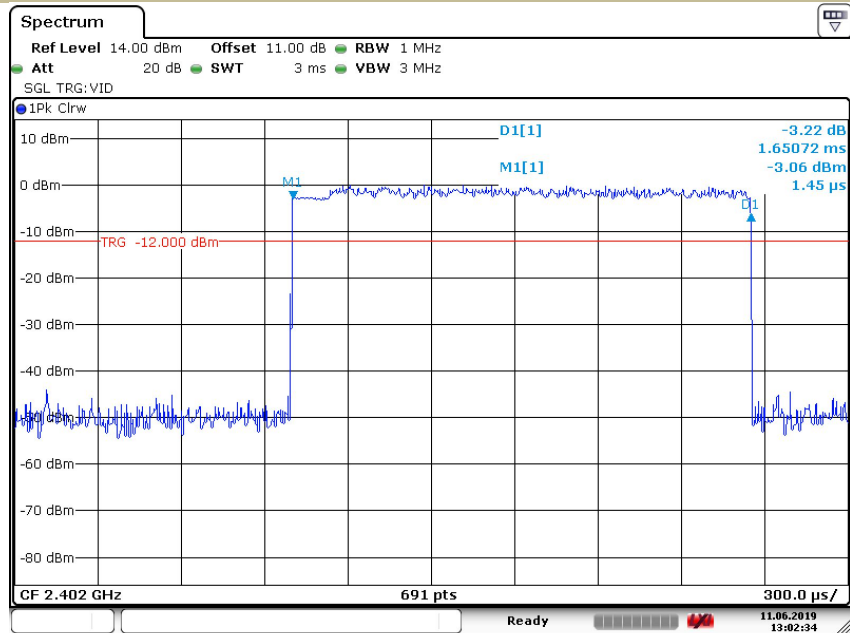

Date: 11.JUN.2019 13:02:35

Test Model

Average Time Of Occupancy (Dwell Time)

CH 0: 2402MHz

8DPSK 3DH5

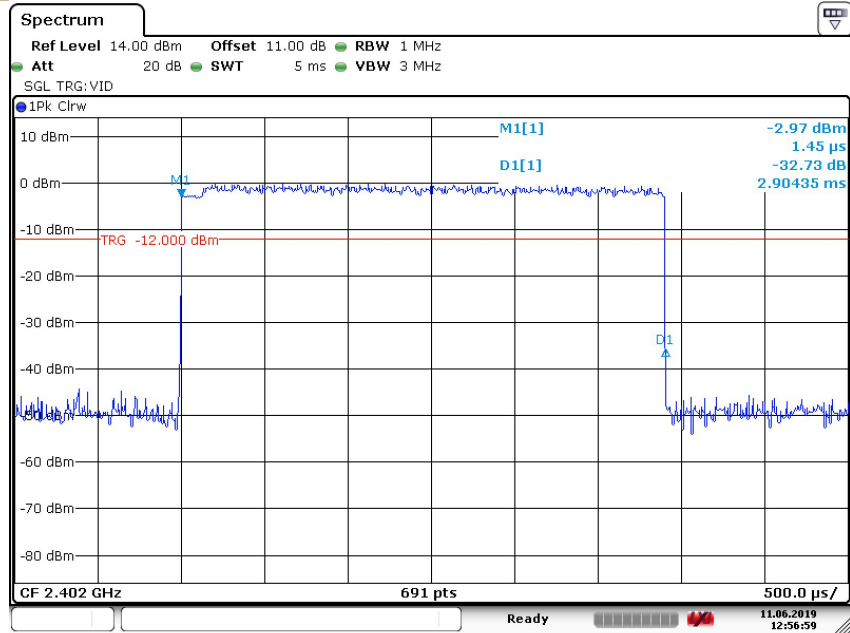

Date: 11.JUN.2019 12:57:00

9.5 MAXIMUM PEAK CONDUCTED OUTPUT POWER

9.5.1 Applicable Standard

According to FCC Part 15.247(b)(1) and KDB 558074 D01 15.247 MEAS GUIDANCE v05r02

9.5.2 Conformance Limit

The max For frequency hopping systems operating in the 2400-2483.5 MHz band employing at least 75 non-overlapping hopping channels: 1 watt. For all other frequency hopping systems in the 2400-2483.5 MHz band: 0.125 watts.

9.5.3 Test Configuration

Test according to clause 7.1 radio frequency test setup 1

9.5.4 Test Procedure

■ According to FCC Part15.247(b)(1)

As an alternative to a peak power measurement, compliance with the limit can be based on a measurement of the maximum conducted output power.

Use the following spectrum analyzer settings:

Set Span = approximately 5 times the 20 dB bandwidth, centered on a hopping channel (about 10MHz)

Set RBW > the 20 dB bandwidth of the emission being measured (about 3MHz)

Set VBW ≥ RBW

Set Sweep = auto

Set Detector function = peak

Set Trace = max hold

Allow the trace to stabilize. Use the marker-to-peak function to set the marker to the peak of the emission to determine the peak amplitude level.

Test Results

Temperature:	26° C
Relative Humidity:	54%
ATM Pressure:	1011 mbar

Operation Mode	Channel Number	Channel Frequency (MHz)	Measurement Level (dBm)	Limit (dBm)	Verdict
GFSK	0	2402	-2.190	30	PASS
	39	2441	-3.089	30	PASS
	78	2480	-0.968	30	PASS
pi/4-DQPSK	0	2402	0.747	30	PASS
	39	2441	-0.032	30	PASS
	78	2480	2.103	30	PASS
8DPSK	0	2402	0.969	30	PASS
	39	2441	0.203	30	PASS
	78	2480	2.246	30	PASS
Note:					

Test Model Maximum Peak Conducted Output Power
Channel 0: 2402MHz GFSK

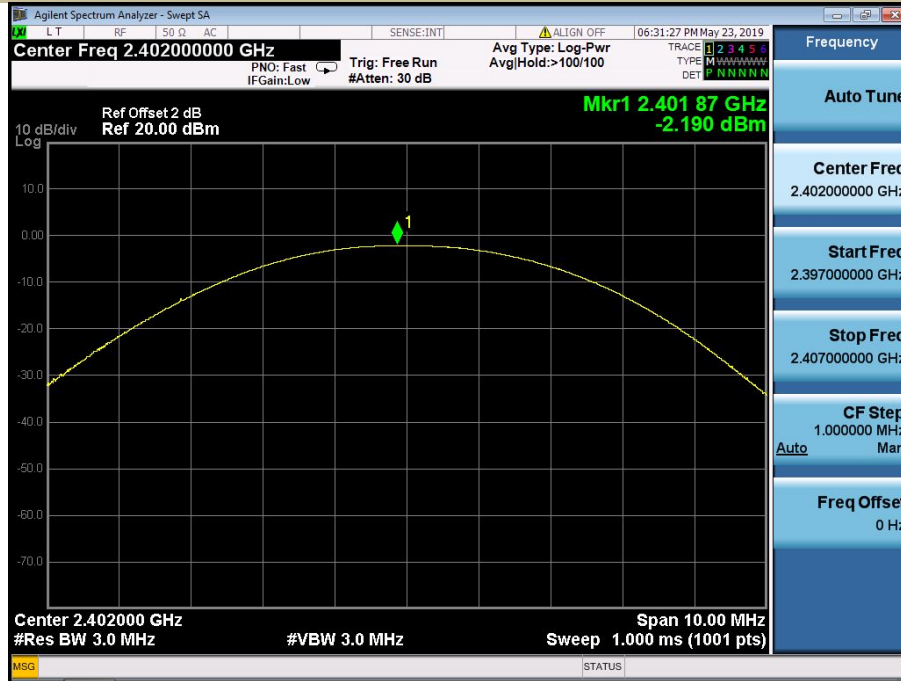

Test Model Maximum Peak Conducted Output Power
Channel 39: 2441MHz GFSK

