



Shenzhen CTL Testing Technology Co., Ltd.  
Tel: +86-755-89486194 E-mail: ctl@ctl-lab.com

# TEST REPORT

## FCC PART 15 SUBPART C 15.247 & RSS-247

**Report Reference No.:** CTL2210275011-WF

Compiled by: Happy Guo  
( position+printed name+signature) (File administrators)

*Happy Guo*

Tested by: Gary Gao  
( position+printed name+signature) (Test Engineer)

*Gary Gao*

Approved by: Ivan Xie  
( position+printed name+signature) (Manager)

*Ivan Xie*

**Product Name** ..... : Portable FM Boombox

**Model/Type reference** ..... : 100097809

**List Model(s)**..... : N/A

**Trade Mark**..... : onn.

**FCC ID**..... : HBOBS2326

**Applicant's name** ..... : SHENZHEN FENDA TECHNOLOGY CO., LTD.

**Address of applicant** ..... : Fenda Hi-Tech Park, Zhoushi Road, Shiyuan Street, Baoan District, Shenzhen, China

**Test Firm**..... : Shenzhen CTL Testing Technology Co., Ltd.

**Address of Test Firm** ..... : Floor 1-A, Baisha Technology Park, No.3011, Shahexi Road, Nanshan District, Shenzhen, China 518055

**Test specification** ..... :

**Standard** ..... : 47 CFR FCC Part 15 Subpart C 15.247  
RSS-247 Issue 2, February 2017

**TRF Originator** ..... : Shenzhen CTL Testing Technology Co., Ltd.

**Master TRF**..... : Dated 2011-01

**Date of receipt of test item** ..... : Oct. 27, 2022

**Date of sampling**..... : Oct. 27, 2022

**Date of Test Date**..... : Oct. 27, 2022 - Nov. 29, 2022

**Date of Issue** ..... : Nov. 30, 2022

**Result**..... : Pass

**Shenzhen CTL Testing Technology Co., Ltd. All rights reserved.**

This publication may be reproduced in whole or in part for non-commercial purposes as long as the Shenzhen CTL Testing Technology Co., Ltd. is acknowledged as copyright owner and source of the material. Shenzhen CTL Testing Technology Co., Ltd. takes no responsibility for and will not assume liability for damages resulting from the reader's interpretation of the reproduced material due to its placement and context.

# TEST REPORT

<b>Test Report No. :</b> CTL2210275011-WF	Nov. 30, 2022
	Date of issue

Equipment under Test : Portable FM Boombox

Sample No. : CTL221027501-1-S001(Normal sample)  
CTL221027501-1-S002(Engineer sample)

Model /Type : 100097809

Listed Models : N/A

**Applicant** : **SHENZHEN FENDA TECHNOLOGY CO., LTD.**

Address : Fenda Hi-Tech Park, Zhoushi Road, Shiyuan Street,  
Baoan District, Shenzhen, China

**Manufacturer** : **SHENZHEN FENDA TECHNOLOGY CO., LTD.**

Address : Fenda Hi-Tech Park, Zhoushi Road, Shiyuan Street,  
Baoan District, Shenzhen, China

<b>Test result</b>	<b>Pass *</b>
--------------------	---------------

\*In the configuration tested, the EUT complied with the standards specified page 5.

The test results presented in this report relate only to the object tested.

This report shall not be reproduced, except in full, without the written approval of the issuing testing laboratory.



## Table of Content

Page

<b>1. SUMMARY .....</b>	<b>5</b>
1.1. TEST STANDARDS .....	5
1.2. TEST DESCRIPTION .....	5
1.3. TEST FACILITY .....	6
1.4. STATEMENT OF THE MEASUREMENT UNCERTAINTY .....	6
<b>2. GENERAL INFORMATION .....</b>	<b>8</b>
2.1. ENVIRONMENTAL CONDITIONS .....	8
2.2. GENERAL DESCRIPTION OF EUT .....	8
2.3. DESCRIPTION OF TEST MODES AND TEST FREQUENCY .....	8
2.4. EQUIPMENTS USED DURING THE TEST .....	9
2.5. RELATED SUBMITTAL(S) / GRANT (S) .....	10
2.6. MODIFICATIONS .....	10
<b>3. TEST CONDITIONS AND RESULTS .....</b>	<b>11</b>
3.1. CONDUCTED EMISSIONS TEST .....	11
3.2. RADIATED EMISSIONS AND BAND EDGE .....	14
3.3. MAXIMUM PEAK OUTPUT POWER .....	24
3.4. 20dB BANDWIDTH .....	25
3.5. OCCUPIED BANDWIDTH .....	26
3.6. FREQUENCY SEPARATION .....	27
3.7. NUMBER OF HOPPING FREQUENCY .....	28
3.8. TIME OF OCCUPANCY (DWELL TIME) .....	29
3.9. OUT-OF-BAND EMISSIONS .....	30
3.10. PSEUDORANDOM FREQUENCY HOPPING SEQUENCE .....	31
3.11. ANTENNA REQUIREMENT .....	32
<b>4. TEST SETUP PHOTOS OF THE EUT .....</b>	<b>33</b>
<b>5. PHOTOS OF THE EUT .....</b>	<b>34</b>

# 1. SUMMARY

## 1.1. TEST STANDARDS

The tests were performed according to following standards:

[FCC Rules Part 15.247](#): Frequency Hopping, Direct Spread Spectrum and Hybrid Systems that are in operation within the bands of 902-928 MHz, 2400-2483.5 MHz, and 5725-5850 MHz

[ANSI C63.10: 2013](#): American National Standard for Testing Unlicensed Wireless Devices

[KDB558074 D01 15.247 Meas Guidance v05r02](#): Guidance for Performing Compliance Measurements on Digital Transmission Systems (DTS) Operating Under §15.247

[RSS-247-Issue 2](#): Digital Transmission Systems (DTSs), Frequency Hopping Systems (FHSs) and Licence-Exempt Local Area Network (LE-LAN) Devices.

[RSS-Gen Issue 5](#): General Requirements for Compliance of Radio Apparatus

## 1.2. Test Description

FCC PART 15.247 & RSS-247		
FCC Part 15.207 RSS-Gen 8.8	AC Power Conducted Emission	PASS
FCC Part 15.247(a)(1)(i) RSS-247 5.1 (1)	20dB Bandwidth	PASS
RSS-Gen 6.7	Occupied bandwidth	PASS
FCC Part 15.247(d) RSS-247 5.5	Spurious RF Conducted Emission	PASS
FCC Part 15.247(b) RSS-247 5.4 (2)	Maximum Peak Output Power	PASS
RSS-247 section 5.4(b)	EIRP Power	PASS
FCC Part 15.247(b) RSS-247 5.1 (1)	Pseudorandom Frequency Hopping Sequence	PASS
FCC Part 15.247(a)(1)(iii) RSS-247 5.1 (4)	Number of hopping frequency & Time of Occupancy	PASS
FCC Part 15.247(a)(1) RSS-247 5.1 (2)	Frequency Separation	PASS
FCC Part 15.205/15.209 RSS-Gen 8.9	Radiated Emissions	PASS
FCC Part 15.247(d) RSS-Gen 8.10	Band Edge Compliance of RF Emission	PASS
FCC Part 15.203/15.247 (b) RSS-Gen 6.8	Antenna Requirement	PASS

### 1.3. Test Facility

#### 1.3.1 Address of the test laboratory

Shenzhen CTL Testing Technology Co., Ltd.

Floor 1-A, Baisha Technology Park, No. 3011, Shahexi Road, Nanshan, Shenzhen 518055 China

There is one 3m semi-anechoic chamber and two line conducted labs for final test. The Test Sites meet the requirements in documents ANSI C63.10 and CISPR 32/EN 55032 requirements.

#### 1.3.2 Laboratory accreditation

The test facility is recognized, certified, or accredited by the following organizations:

##### **CNAS-Lab Code: L7497**

Shenzhen CTL Testing Technology Co., Ltd. has been assessed and proved to be in compliance with CNAS-CL01 Accreditation Criteria for Testing and Calibration Laboratories (identical to ISO/IEC 17025: 2005 General Requirements) for the Competence of Testing and Calibration Laboratories.

##### **A2LA-Lab Cert. No. 4343.01**

Shenzhen CTL Testing Technology Co., Ltd, EMC Laboratory has been accredited by A2LA for technical competence in the field of electrical testing, and proved to be in compliance with ISO/IEC 17025: 2005 General Requirements for the Competence of Testing and Calibration Laboratories and any additional program requirements in the identified field of testing.

##### **IC Registration No.: 9618B**

##### **CAB identifier: CN0041**

The 3m alternate test site of Shenzhen CTL Testing Technology Co., Ltd. EMC Laboratory has been registered by Innovation, Science and Economic Development Canada to test to Canadian radio equipment requirements with Registration No.: 9618B on Jan. 22, 2019.

##### **FCC-Registration No.: 399832**

##### **Designation No.: CN1216**

Shenzhen CTL Testing Technology Co., Ltd. EMC Laboratory has been registered and fully described in a report filed with the (FCC) Federal Communications Commission. The acceptance letter from the FCC is maintained in our files. Registration 399832, December 08, 2017.

### 1.4. Statement of the measurement uncertainty

The data and results referenced in this document are true and accurate. The reader is cautioned that there may be errors within the calibration limits of the equipment and facilities. The measurement uncertainty was calculated for all measurements listed in this test report acc. to CISPR 16 - 4 "Specification for radio disturbance and immunity measuring apparatus and methods – Part 4: Uncertainty in EMC Measurements" and is documented in the Shenzhen CTL Testing Technology Co., Ltd. quality system acc. to DIN EN ISO/IEC 17025. Furthermore, component and process variability of devices similar to that tested may result in additional deviation. The manufacturer has the sole responsibility of continued compliance of the device.

Hereafter the best measurement capability for CTL laboratory is reported:

Test	Measurement Uncertainty	Notes
Transmitter power conducted	$\pm 0.57$ dB	(1)
Transmitter power Radiated	$\pm 2.20$ dB	(1)
Conducted spurious emission 9KHz-40 GHz	$\pm 2.20$ dB	(1)
Occupied Bandwidth	$\pm 0.01$ ppm	(1)

Radiated Emission 9KHz~30MHz	$\pm 3.50\text{dB}$	(1)
Radiated Emission 30~1000MHz	$\pm 4.10\text{dB}$	(1)
Radiated Emission Above 1GHz	$\pm 4.32\text{dB}$	(1)
Conducted Disturbance 0.15~30MHz	$\pm 3.20\text{dB}$	(1)

(1) This uncertainty represents an expanded uncertainty expressed at approximately the 95% confidence level using a coverage factor of  $k=2$ .

## 2. GENERAL INFORMATION

### 2.1. Environmental conditions

During the measurement the environmental conditions were within the listed ranges:

Normal Temperature:	25°C
Relative Humidity:	55 %
Air Pressure:	101 kPa

### 2.2. General Description of EUT

Product Name:	Portable FM Boombox
Model/Type reference:	100097809
S/N	N/A
Power supply:	DC 7.4V from battery
Hardware version:	BS2326-MD
Software version:	V1.42
Adapter information:	Model: HW-100225C00 Input: AC 100-240V 50/60Hz 0.75A Max Output: 5V---2A or 9V---2A or 10V---2.25A MAX
<b>Bluetooth :</b>	
Supported type:	Bluetooth BR/EDR
Modulation:	GFSK, $\pi/4$ DQPSK, 8DPSK
Operation frequency:	2402MHz~2480MHz
Channel number:	79
Channel separation:	1MHz
Antenna type:	PCB Antenna
Antenna gain:	1.43dBi

Note: For more details, please refer to the user's manual of the EUT.

### 2.3. Description of Test Modes and Test Frequency

The Applicant provides communication tools software to control the EUT for staying in continuous transmitting (Duty Cycle more than 98%) and receiving mode for testing. There are 79 channels provided to the EUT and Channel 00/39/78 were selected to test.

#### Operation Frequency :

Channel	Frequency (MHz)
00	2402
01	2403
⋮	⋮
38	2440
39	2441
40	2442
⋮	⋮
77	2479
78	2480



Preliminary tests were performed in each mode and packet length of BT, and found worst case as bellow, finally test were conducted at those mode and recorded in this report.

Test Items	Worst case
Conducted Emissions	DH5 Middle channel
Radiated Emissions and Band Edge	DH5
Maximum Conducted Output Power	DH5/2DH5/3DH5
20dB Bandwidth	DH5/2DH5/3DH5
Frequency Separation	DH5/2DH5/3DH5 Middle channel
Number of hopping frequency	DH5/2DH5/3DH5
Time of Occupancy (Dwell Time)	DH1/DH3/DH5 Middle channel 2DH1/2DH3/2DH5 Middle channel 3DH1/3DH3/3DH5 Middle channel
Out-of-band Emissions	DH5/2DH5/3DH5

### Power setting during the test:

During testing, Channel & Power Controlling Software provided by the customer was used to control the operating channel as well as the output power level. The RF output power selection is for the setting of RF output power expected by the customer and is going to be fixed on the firmware of the final end product.

Power Parameters:

Test Software Version	BT FCC Tool V2.24		
Frequency	2402MHz	2441MHz	2480MHz
GFSK	4	4	4
$\pi/4$ DQPSK	4	4	4
8DPSK	4	4	4

## 2.4. Equipments Used during the Test

Test Equipment	Manufacturer	Model No.	Serial No.	Calibration Date	Calibration Due Date
LISN	R&S	ESH2-Z5	860014/010	2022/05/07	2023/05/06
Double cone logarithmic antenna	Schwarzbeck	VULB 9168	824	2020/04/07	2023/04/06
Horn Antenna	Ocean Microwave	OBH100400	26999002	2021/12/22	2024/12/21
EMI Test Receiver	R&S	ESCI	1166.5950.03	2022/05/07	2023/05/06
Spectrum Analyzer	Agilent	E4407B	MY41440676	2022/05/07	2023/05/06
Spectrum Analyzer	Agilent	N9020A	US46220290	2022/05/07	2023/05/06
Spectrum Analyzer	Keysight	N9020A	MY53420874	2022/05/07	2023/05/06
Horn Antenna	Sunol Sciences Corp.	DRH-118	A062013	2021/12/23	2024/12/22
Active Loop Antenna	Da Ze	ZN30900A	/	2021/05/13	2024/05/12
Amplifier	Agilent	8449B	3008A02306	2022/05/07	2023/05/06
Amplifier	Agilent	8447D	2944A10176	2022/05/06	2023/05/05

Amplifier	Brief&Smart	LNA-4018	2104197	2022/05/07	2023/05/06
Temperature/Humidity Meter	Ji Yu	MC501	/	2022/05/07	2023/05/06
Power Sensor	Agilent	U2021XA	MY55130004	2022/05/07	2023/05/06
Power Sensor	Agilent	U2021XA	MY55130006	2022/05/07	2023/05/06
Power Sensor	Agilent	U2021XA	MY54510008	2022/05/07	2023/05/06
Power Sensor	Agilent	U2021XA	MY55060003	2022/05/07	2023/05/06
Spectrum Analyzer	RS	FSP	1164.4391.38	2022/05/07	2023/05/06
RF Cable	Megalon	RF-A303	N/A	2022/06/15	2023/06/14
RF Control Unit	Tonsecnd	JS0806-2	20J8060323	2022/05/07	2023/05/06
Test Software					
Name of Software			Version		
JS1120-3			2.6.880341		
EZ_EMG(Below 1GHz)			V1.1.4.2		
EZ_EMG((Above 1GHz)			V1.1.4.2		

The calibration interval was one year

## 2.5. Related Submittal(s) / Grant (s)

This submittal(s) (test report) is intended to comply with FCC Part 15.247 Rules.

## 2.6. Modifications

No modifications were implemented to meet testing criteria.

### 3. TEST CONDITIONS AND RESULTS

#### 3.1. Conducted Emissions Test

##### LIMIT

According to FCC CFR Title 47 Part 15 Subpart C Section 15.207 and RSS Gen 8.8, AC Power Line Conducted Emissions Limits for Licence-Exempt Radio Apparatus as below:

Frequency range (MHz)	Limit (dBuV)	
	Quasi-peak	Average
0.15-0.5	66 to 56*	56 to 46*
0.5-5	56	46
5-30	60	50

\* Decreases with the logarithm of the frequency.

##### TEST CONFIGURATION

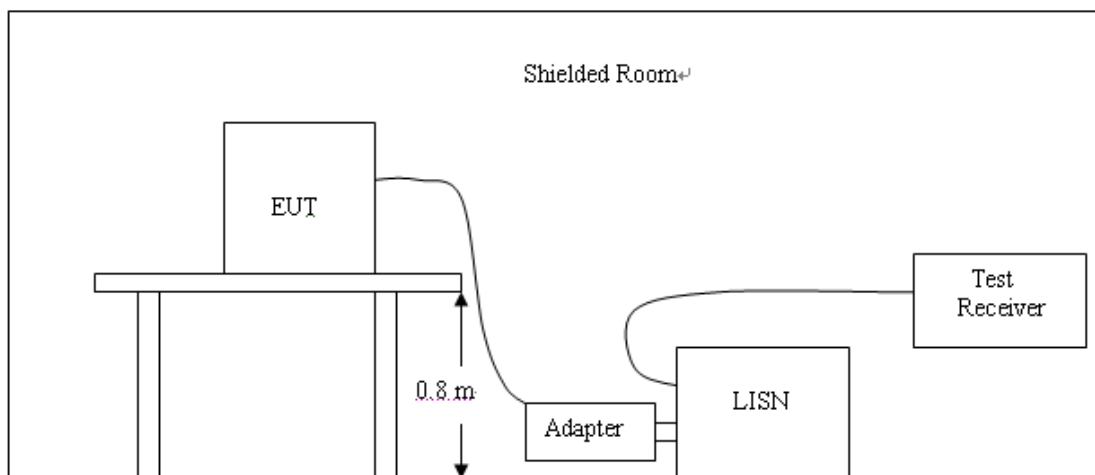

##### TEST PROCEDURE

1. The equipment was set up as per the test configuration to simulate typical actual usage per the user's manual. The EUT is a tabletop system; a wooden table with a height of 0.8 meters is used and is placed on the ground plane as per ANSI C63.10:2013.
2. Support equipment, if needed, was placed as per ANSI C63.10:2013.
3. All I/O cables were positioned to simulate typical actual usage as per ANSI C63.10:2013.
4. The adapter received AC120V/60Hz power through a Line Impedance Stabilization Network (LISN) which supplied power source and was grounded to the ground plane.
5. All support equipments received AC power from a second LISN, if any.
6. The EUT test program was started. Emissions were measured on each current carrying line of the EUT using a spectrum Analyzer / Receiver connected to the LISN powering the EUT. The LISN has two monitoring points: Line 1 (Hot Side) and Line 2 (Neutral Side). Two scans were taken: one with Line 1 connected to Analyzer / Receiver and Line 2 connected to a 50 ohm load; the second scan had Line 1 connected to a 50 ohm load and Line 2 connected to the Analyzer / Receiver.
7. Analyzer / Receiver scanned from 150 KHz to 30MHz for emissions in each of the test modes.
8. During the above scans, the emissions were maximized by cable manipulation.

**TEST RESULTS**

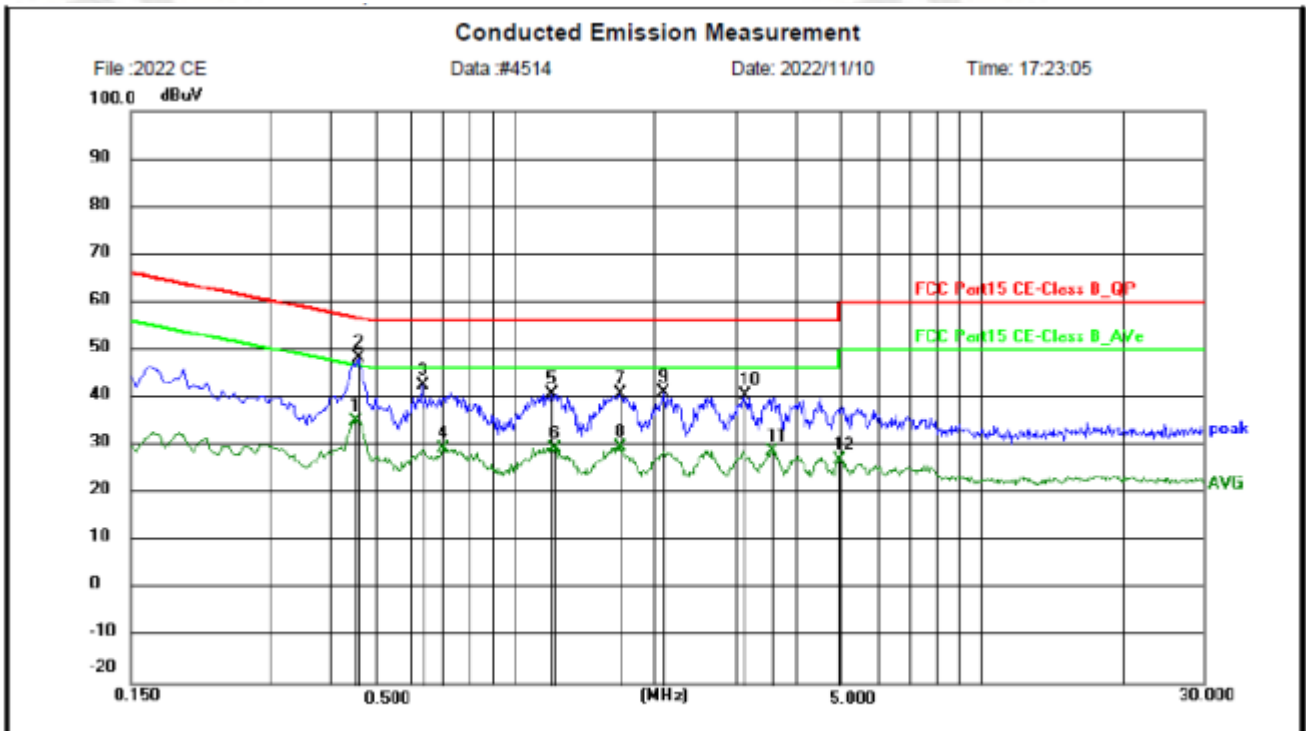

Site LAB  
 Limit: FCC Part15 CE-Class B\_QP  
 EUT: Portable FM Boombox  
 M/N: 100097809  
 Mode: WORKING  
 Note:  
 Company name: SHENZHEN FENDA TECHNOLOGY CO.,LTD

Phase: L1  
 Power:  
 Temperature: 24(C)  
 Humidity: 50 %RH

No.	Frequency (MHz)	Reading (dBuV)	Factor (dB)	Level (dBuV)	Limit (dBuV)	Margin (dB)	Detector	P/F	Remark
1	0.4560	17.25	17.91	35.16	46.77	11.61	AVG	P	
2	0.4605	30.27	17.91	48.18	56.68	8.50	peak	P	
3	0.6315	24.55	17.91	42.46	56.00	13.54	peak	P	
4	0.7035	11.55	17.91	29.46	46.00	16.54	AVG	P	
5	1.1985	22.79	17.91	40.70	56.00	15.30	peak	P	
6	1.2164	11.50	17.91	29.41	46.00	16.59	AVG	P	
7	1.6755	22.71	17.92	40.63	56.00	15.37	peak	P	
8	1.6935	11.85	17.92	29.77	46.00	16.23	AVG	P	
9	2.0805	23.10	17.92	41.02	56.00	14.98	peak	P	
10	3.1199	22.38	17.94	40.32	56.00	15.68	peak	P	
11	3.5745	10.95	17.94	28.89	46.00	17.11	AVG	P	
12	4.9740	8.88	17.94	26.82	46.00	19.18	AVG	P	

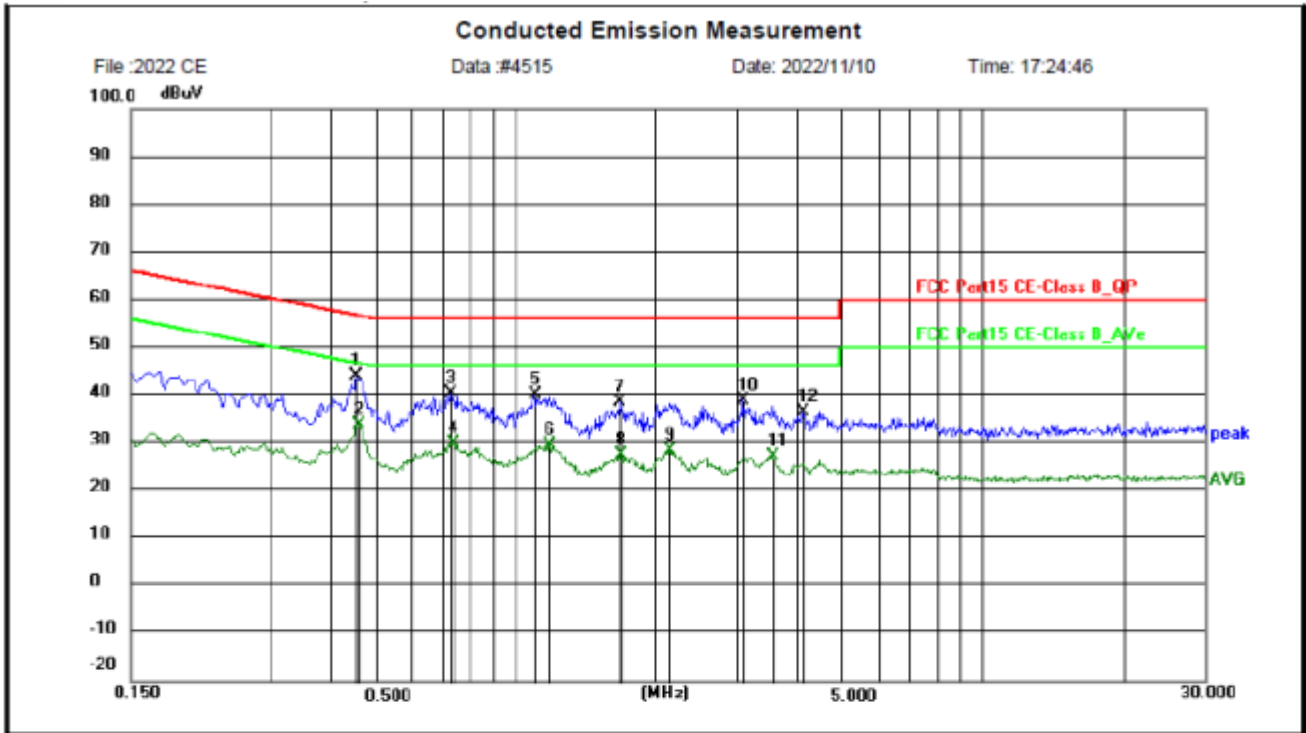

Site LAB      Phase: **N**      Temperature: 24(C)  
 Limit: FCC Part15 CE-Class B\_QP      Power:      Humidity: 50 %RH  
 EUT: Portable FM Boombox  
 M/N: 100097809  
 Mode: WORKING  
 Note:  
 Company name: SHENZHEN FENDA TECHNOLOGY CO.,LTD

No.	Frequency (MHz)	Reading (dBuV)	Factor (dB)	Level (dBuV)	Limit (dBuV)	Margin (dB)	Detector	P/F	Remark
1	0.4560	26.13	17.90	44.03	56.77	12.74	peak	P	
2	0.4605	15.82	17.90	33.72	46.68	12.96	AVG	P	
3	0.7304	22.51	17.90	40.41	56.00	15.59	peak	P	
4	0.7350	12.09	17.90	29.99	46.00	16.01	AVG	P	
5	1.0995	22.33	17.91	40.24	56.00	15.76	peak	P	
6	1.1849	11.73	17.91	29.64	46.00	16.36	AVG	P	
7	1.6800	20.84	17.92	38.76	56.00	17.24	peak	P	
8	1.6890	9.62	17.92	27.54	46.00	18.46	AVG	P	
9	2.1480	10.64	17.92	28.56	46.00	17.44	AVG	P	
10	3.0660	21.17	17.93	39.10	56.00	16.90	peak	P	
11	3.5475	9.28	17.93	27.21	46.00	18.79	AVG	P	
12	4.1145	18.60	17.94	36.54	56.00	19.46	peak	P	

## 3.2. Radiated Emissions and Band Edge

### Limit

For intentional device, according to § 15.209(a), the general requirement of field strength of radiated emission out of authorized band shall not exceed the following table at a 3 meters measurement distance.

In addition, radiated emissions which fall in the restricted bands, as defined in §15.205(a), must also comply with the radiated emission limits specified in §15.209(a)

For intentional device, according to RSS-Gen section 8.9, the general requirement of field strength of radiated emission out of authorized band shall not exceed the following table at a 3 meters measurement distance.

In addition, radiated emissions which fall in the restricted bands, as defined in RSS-Gen section 8.10, must also comply with the radiated emission limits specified in RSS-Gen section 8.9

### Radiated emission limits

Frequency (MHz)	Distance (Meters)	Radiated (dB $\mu$ V/m)	Radiated ( $\mu$ V/m)
0.009-0.49	3	$20\log(2400/F(\text{KHz}))+40\log(300/3)$	$2400/F(\text{KHz})$
0.49-1.705	3	$20\log(24000/F(\text{KHz}))+40\log(30/3)$	$24000/F(\text{KHz})$
1.705-30	3	$20\log(30)+40\log(30/3)$	30
30-88	3	40.0	100
88-216	3	43.5	150
216-960	3	46.0	200
Above 960	3	54.0	500

### TEST CONFIGURATION

(A) Radiated Emission Test Set-Up, Frequency Below 30MHz

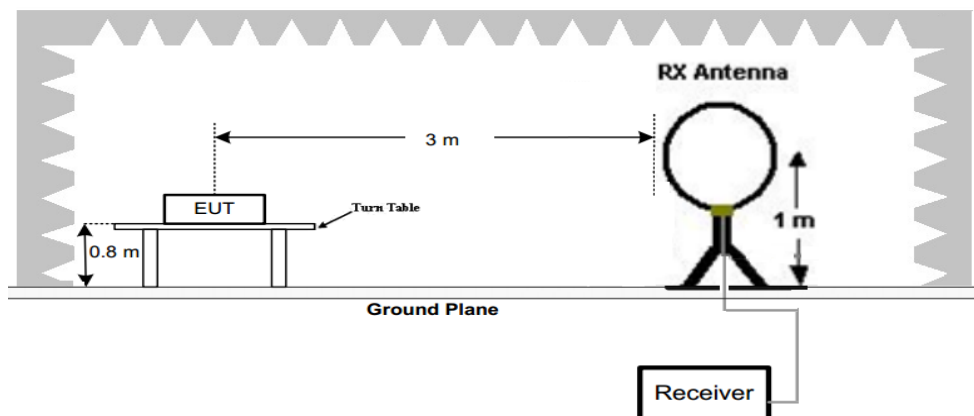

(B) Radiated Emission Test Set-Up, Frequency below 1000MHz

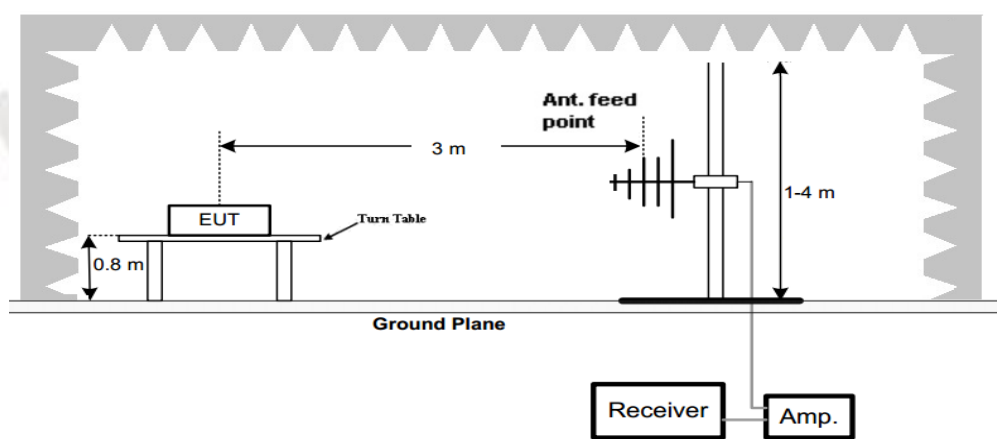

## (C) Radiated Emission Test Set-Up, Frequency above 1000MHz

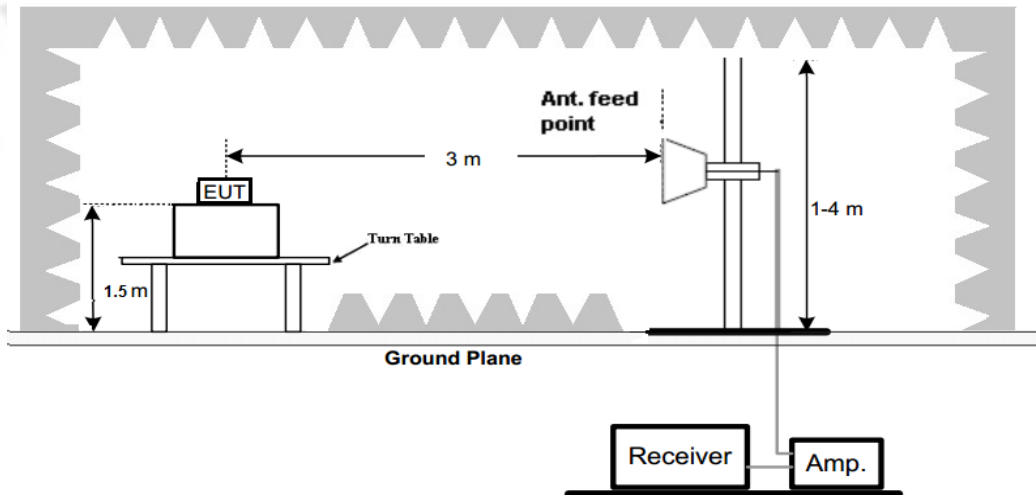
**Test Procedure**

- Below 1GHz measurement the EUT is placed on a turntable which is 0.8m above ground plane, and above 1GHz measurement EUT was placed on a low permittivity and low loss tangent turn table which is 1.5m above ground plane.
- Maximum procedure was performed by raising the receiving antenna from 1m to 4m and rotating the turn table from 0° to 360° to acquire the highest emissions from EUT
- And also, each emission was to be maximized by changing the polarization of receiving antenna both horizontal and vertical.
- Repeat above procedures until all frequency measurements have been completed.
- Radiated emission test frequency band from 9KHz to 25GHz.
- The distance between test antenna and EUT as following table states:

Test Frequency range	Test Antenna Type	Test Distance
9KHz-30MHz	Active Loop Antenna	3
30MHz-1GHz	Bilog Antenna	3
1GHz-18GHz	Horn Antenna	3
18GHz-25GHz	Horn Antenna	1

- Setting test receiver/spectrum as following table states:

Test Frequency range	Test Receiver/Spectrum Setting	Detector
9KHz-150KHz	RBW=200Hz/VBW=3KHz, Sweep time=Auto	QP
150KHz-30MHz	RBW=9KHz/VBW=100KHz, Sweep time=Auto	QP
30MHz-1GHz	RBW=120KHz/VBW=1000KHz, Sweep time=Auto	QP
1GHz-40GHz	Peak Value: RBW=1MHz/VBW=3MHz, Sweep time=Auto Average Value: RBW=1MHz/VBW=10Hz, Sweep time=Auto	Peak

**TEST RESULTS**

Remark:

- Pre-Scan has been conducted to determine the worst-case mode from all possible combinations between available modulations, data rates, XYZ axis. The worst-case was found at Z axis, GFSK DH5 mode.
- For below 1GHz testing recorded worst at GFSK DH5 low channel.
- Radiated emission test from 9 KHz to 10th harmonic of fundamental was verified, and the emission levels from 9kHz to 30MHz are attenuated 20dB below the limit and not recorded in report.

For 30MHz-1GHz

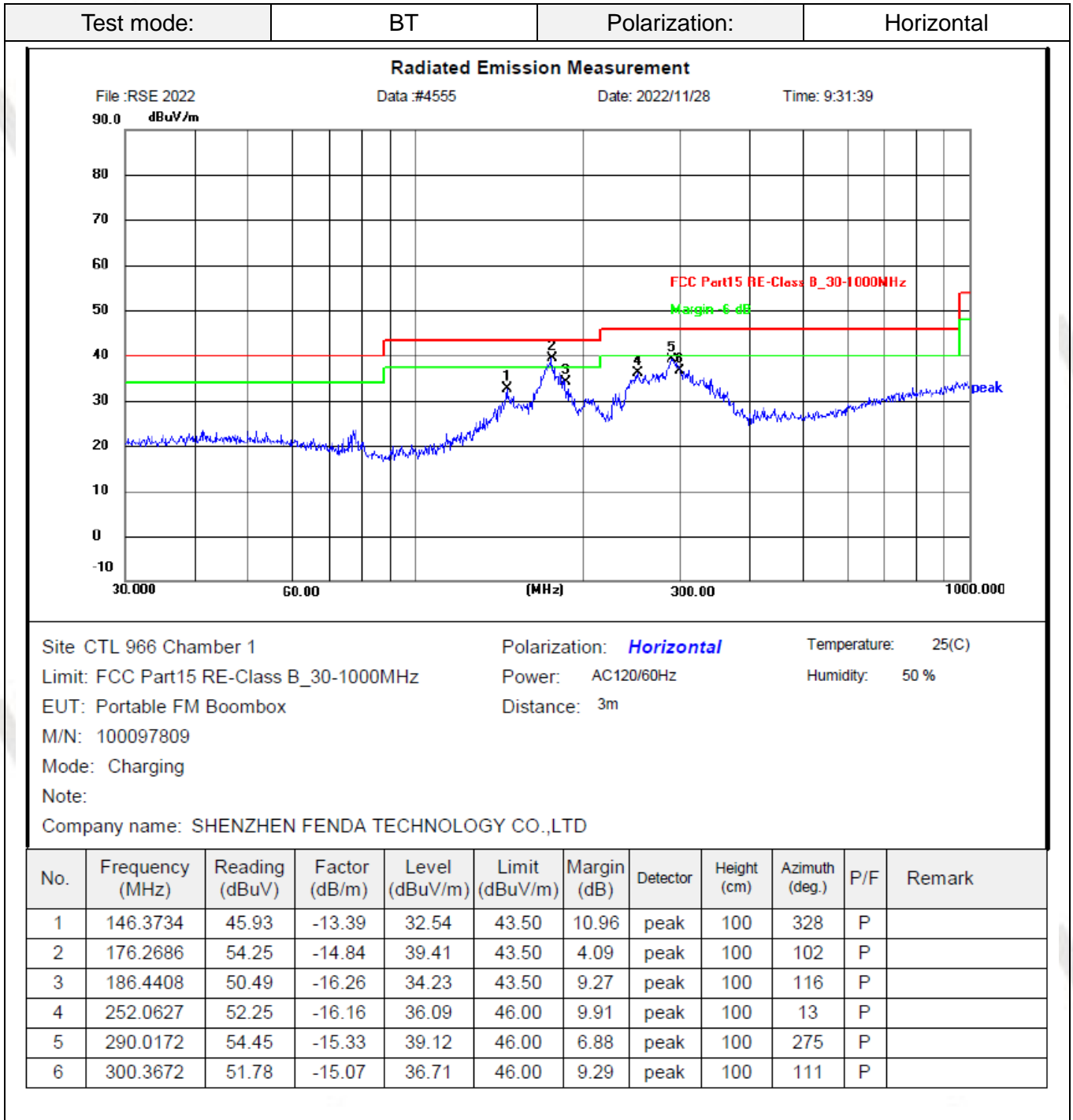



Test mode:	BT	Polarization:	Vertical
------------	----	---------------	----------

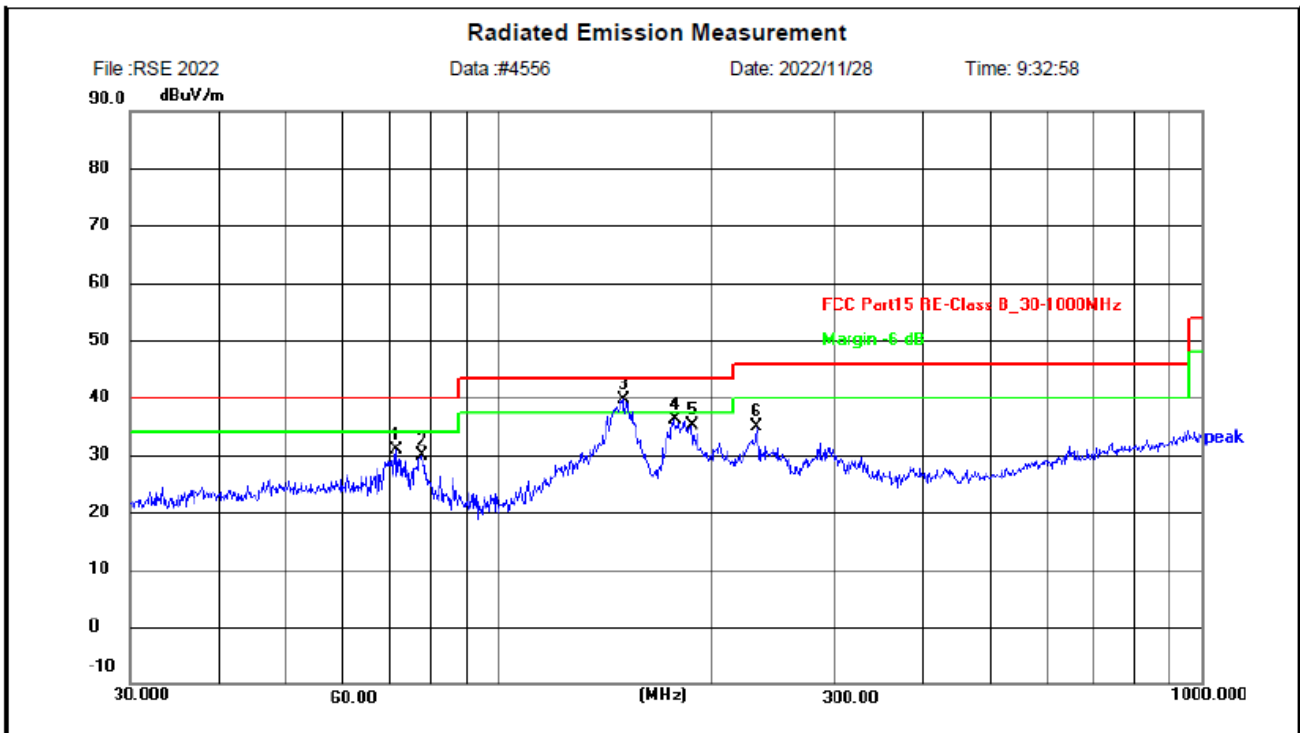

File :RSE 2022      Data :#4556      Date: 2022/11/28      Time: 9:32:58  
 Site CTL 966 Chamber 1      Polarization: **Vertical**      Temperature: 25(C)  
 Limit: FCC Part15 RE-Class B\_30-1000MHz      Power: AC120/60Hz      Humidity: 50 %  
 EUT: Portable FM Boombox      Distance: 3m  
 M/N: 100097809  
 Mode: Charging  
 Note:  
 Company name: SHENZHEN FENDA TECHNOLOGY CO.,LTD

No.	Frequency (MHz)	Reading (dBuV)	Factor (dB/m)	Level (dBuV/m)	Limit (dBuV/m)	Margin (dB)	Detector	Height (cm)	Azimuth (deg.)	P/F	Remark
1	71.8320	48.91	-18.04	30.87	40.00	9.13	peak	100	81	P	
2	77.5928	48.70	-18.80	29.90	40.00	10.10	peak	100	234	P	
3	150.5378	52.76	-13.08	39.68	43.50	3.82	peak	100	36	P	
4	177.5092	51.21	-15.03	36.18	43.50	7.32	peak	100	94	P	
5	187.7530	51.67	-16.44	35.23	43.50	8.27	peak	100	49	P	
6	232.5318	51.23	-16.31	34.92	46.00	11.08	peak	100	9	P	

Remark: Level(dBuV/m)=Reading(dBuV)+Factor(dB/m)  
 Margin= Limit(dBuV/m)- Level(dBuV/m)

**For 1GHz to 25GHz**

Note: GFSK, Pi/4 DQPSK and 8DPSK all have been tested, only worse case GFSK is reported.

**GFSK (above 1GHz)**

Frequency(MHz):			2402		Polarity:		HORIZONTAL		
Frequency (MHz)	Emission Level (dBuV/m)		Limit (dBuV/m)	Margin (dB)	Raw Value (dBuV)	Antenna Factor (dB/m)	Cable Factor (dB)	Pre-amplifier (dB)	Correction Factor (dB/m)
4804.00	39.84	PK	74	34.16	52.26	33.84	7.00	53.26	-12.42
4804.00	--	AV	54	--	--	--	--	--	--
7206.00	45.29	PK	74	28.71	51.57	37.64	9.28	53.20	-6.28
7206.00	--	AV	54	--	--	--	--	--	--
9608.00	46.61	PK	74	27.39	48.30	38.10	13.02	52.81	-1.69
9608.00	--	AV	54	--	--	--	--	--	--

Frequency(MHz):			2402		Polarity:		VERTICAL		
Frequency (MHz)	Emission Level (dBuV/m)		Limit (dBuV/m)	Margin (dB)	Raw Value (dBuV)	Antenna Factor (dB/m)	Cable Factor (dB)	Pre-amplifier (dB)	Correction Factor (dB/m)
4804.00	39.29	PK	74	34.71	52.28	33.49	6.91	53.39	-12.99
4804.00	--	AV	54	--	--	--	--	--	--
7206.00	43.68	PK	74	30.32	50.73	36.95	9.18	53.18	-7.05
7206.00	--	AV	54	--	--	--	--	--	--
9608.00	46.56	PK	74	27.44	48.25	38.10	13.02	52.81	-1.69
9608.00	--	AV	54	--	--	--	--	--	--

Frequency(MHz):			2441		Polarity:		HORIZONTAL		
Frequency (MHz)	Emission Level (dBuV/m)		Limit (dBuV/m)	Margin (dB)	Raw Value (dBuV)	Antenna Factor (dB/m)	Cable Factor (dB)	Pre-amplifier (dB)	Correction Factor (dB/m)
4882.00	40.21	PK	74	33.79	52.99	33.60	6.95	53.33	-12.78
4882.00	--	AV	54	--	--	--	--	--	--
7323.00	46.40	PK	74	27.60	52.90	37.46	9.23	53.19	-6.50
7323.00	--	AV	54	--	--	--	--	--	--
9764.00	46.70	PK	74	27.30	50.61	38.50	10.25	52.66	-3.91
9764.00	--	AV	54	--	--	--	--	--	--

Frequency(MHz):			2441		Polarity:		VERTICAL		
Frequency (MHz)	Emission Level (dBuV/m)		Limit (dBuV/m)	Margin (dB)	Raw Value (dBuV)	Antenna Factor (dB/m)	Cable Factor (dB)	Pre-amplifier (dB)	Correction Factor (dB/m)
4882.00	38.99	PK	74	35.01	51.77	33.60	6.95	53.33	-12.78
4882.00	--	AV	54	--	--	--	--	--	--
7323.00	45.91	PK	74	28.09	52.41	37.46	9.23	53.19	-6.50
7323.00	--	AV	54	--	--	--	--	--	--
9764.00	47.65	PK	74	26.35	51.56	38.50	10.25	52.66	-3.91
9764.00	--	AV	54	--	--	--	--	--	--

Frequency(MHz):			2480		Polarity:		HORIZONTAL		
Frequency (MHz)	Emission Level (dBuV/m)		Limit (dBuV/m)	Margin (dB)	Raw Value (dBuV)	Antenna Factor (dB/m)	Cable Factor (dB)	Pre-amplifier (dB)	Correction Factor (dB/m)
4960.00	39.30	PK	74	34.70	51.72	33.84	7.00	53.26	-12.42
4960.00	--	AV	54	--	--	--	--	--	--
7440.00	46.34	PK	74	27.66	52.62	37.64	9.28	53.20	-6.28
7440.00	--	AV	54	--	--	--	--	--	--
9920.00	48.37	PK	74	25.63	48.90	38.80	12.82	52.15	-0.53
9920.00	--	AV	54	--	--	--	--	--	--

Frequency(MHz):			2480		Polarity:		VERTICAL		
Frequency (MHz)	Emission Level (dBuV/m)		Limit (dBuV/m)	Margin (dB)	Raw Value (dBuV)	Antenna Factor (dB/m)	Cable Factor (dB)	Pre-amplifier (dB)	Correction Factor (dB/m)
4960.00	39.49	PK	74	34.51	51.91	33.84	7.00	53.26	-12.42
4960.00	--	AV	54	--	--	--	--	--	--
7440.00	46.77	PK	74	27.23	53.05	37.64	9.28	53.20	-6.28
7440.00	--	AV	54	--	--	--	--	--	--
9920.00	48.40	PK	74	25.60	48.93	38.80	12.82	52.15	-0.53
9920.00	--	AV	54	--	--	--	--	--	--

## REMARKS:

1. Emission level (dBuV/m) =Raw Value (dBuV)+Correction Factor (dB/m)
2. Correction Factor (dB/m) = Antenna Factor (dB/m)+Cable Factor (dB)-Pre-amplifier Factor
3. Margin value = Limit value- Emission level.
4. -- Mean the PK detector measured value is below average limit.
5. Other emission levels are attenuated 20dB below the limit and not recorded in report.
6. RBW1MHz VBW3MHz Peak detector is for PK value; RBW 1MHz VBW10Hz Peak detector is for AV value.

**Results of Band Edges Test (Radiated)**

Note: GFSK, Pi/4 DQPSK and 8DPSK all have been tested, only worse case GFSK is reported.

Test frequency:	2402MHz	Polarization:	Horizontal
-----------------	---------	---------------	------------

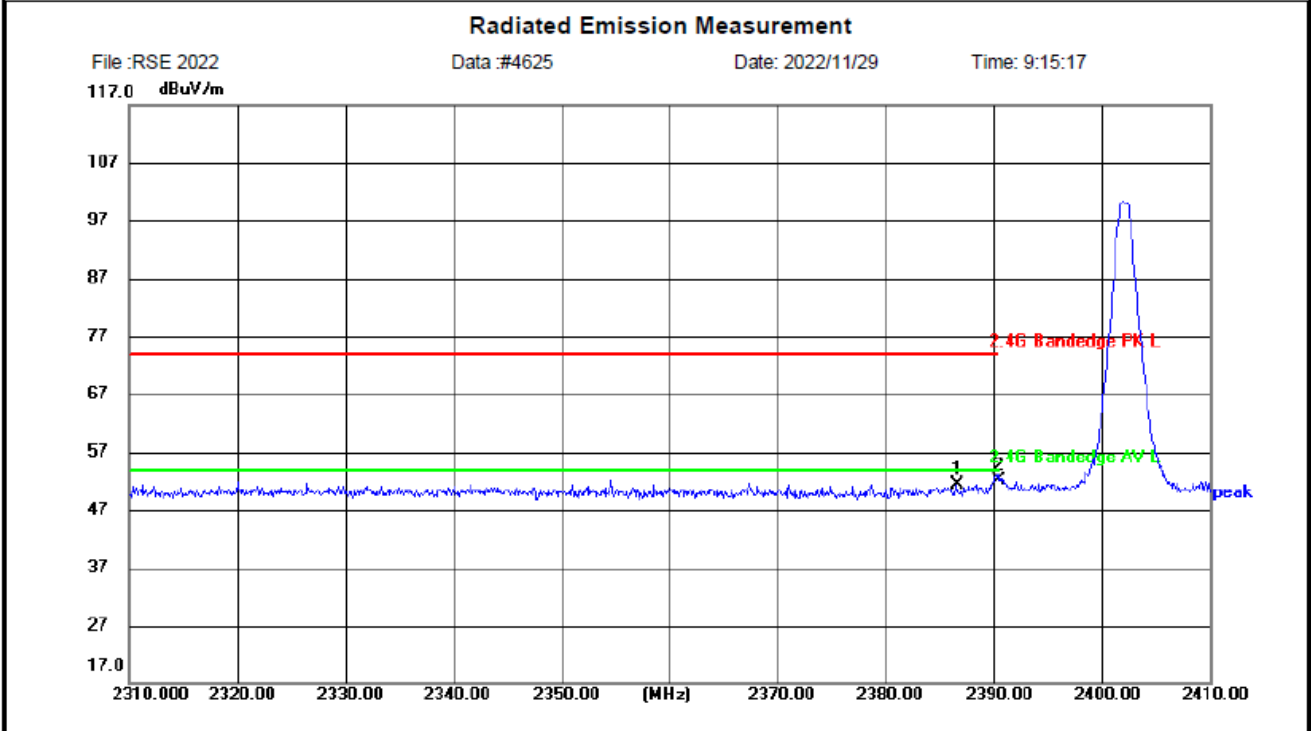

File :RSE 2022                      Data :#4625                      Date: 2022/11/29                      Time: 9:15:17  
 117.0 dBuV/m  
 Site CTL 966 Chamber 1                      Polarization: **Horizontal**                      Temperature: 25(C)  
 Limit: 2.4G Bandedge PK L                      Power: AC120/60Hz                      Humidity: 50 %  
 EUT: Portable FM Boombox                      Distance: 3m  
 M/N: 100097809  
 Mode: WORKING  
 Note: 2402  
 Company name: SHENZHEN FENDA TECHNOLOGY CO.,LTD

No.	Frequency (MHz)	Reading (dBuV)	Factor (dB/m)	Level (dBuV/m)	Limit (dBuV/m)	Margin (dB)	Detector	Height (cm)	Azimuth (deg.)	P/F	Remark
1	2386.118	56.20	-4.70	51.50	74.00	22.50	peak	149	0	P	
2	2390.000	56.84	-4.69	52.15	74.00	21.85	peak	149	0	P	

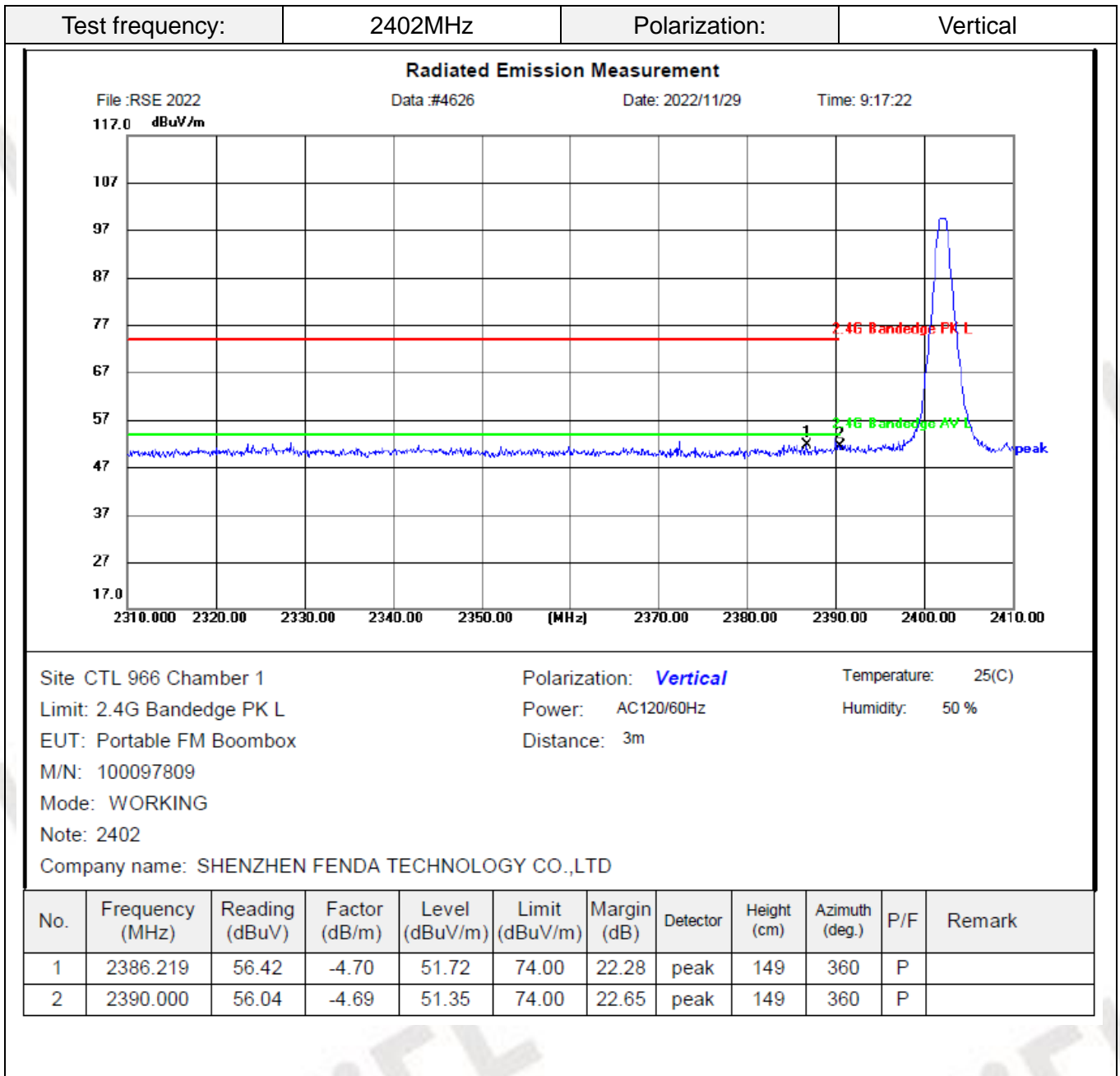

Test frequency:

2480MHz

Polarization:

Horizontal

**Radiated Emission Measurement**

File :RSE 2022

Data :#4627

Date: 2022/11/29

Time: 9:22:09

117.0 dBuV/m

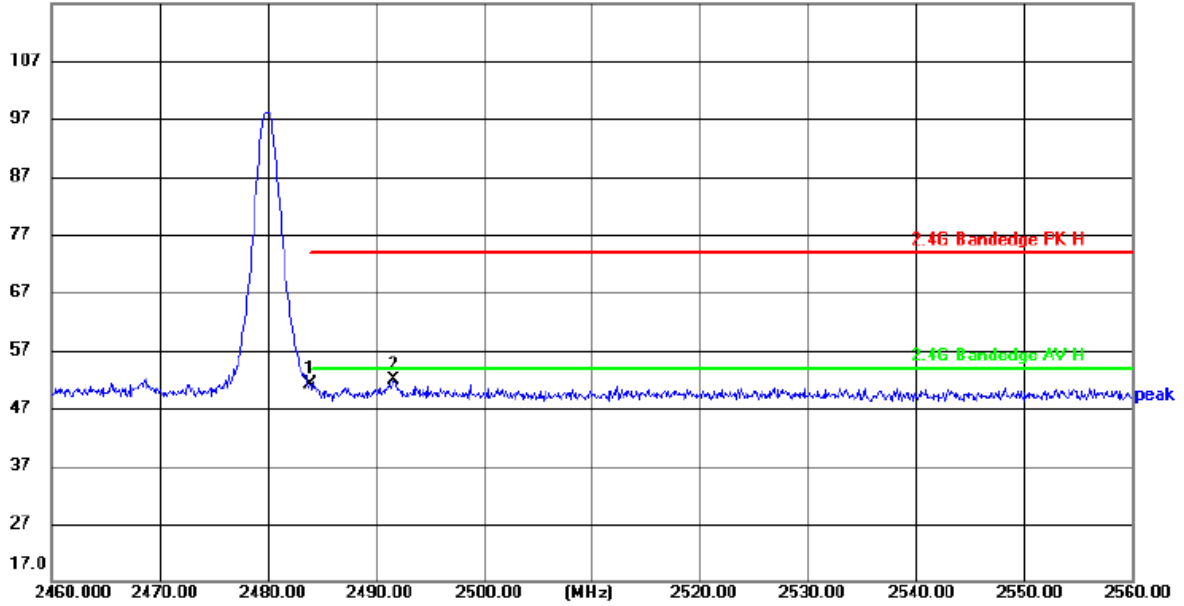

Site CTL 966 Chamber 1

Polarization: **Horizontal**

Temperature: 25(C)

Limit: 2.4G Bandedge PK H

Power: AC120/60Hz

Humidity: 50 %

EUT: Portable FM Boombox

Distance: 3m

M/N: 100097809

Mode: WORKING

Note: 2480

Company name: SHENZHEN FENDA TECHNOLOGY CO.,LTD

No.	Frequency (MHz)	Reading (dBuV)	Factor (dB/m)	Level (dBuV/m)	Limit (dBuV/m)	Margin (dB)	Detector	Height (cm)	Azimuth (deg.)	P/F	Remark
1	2483.500	55.49	-4.45	51.04	74.00	22.96	peak	149	0	P	
2	2491.170	56.43	-4.44	51.99	74.00	22.01	peak	149	0	P	

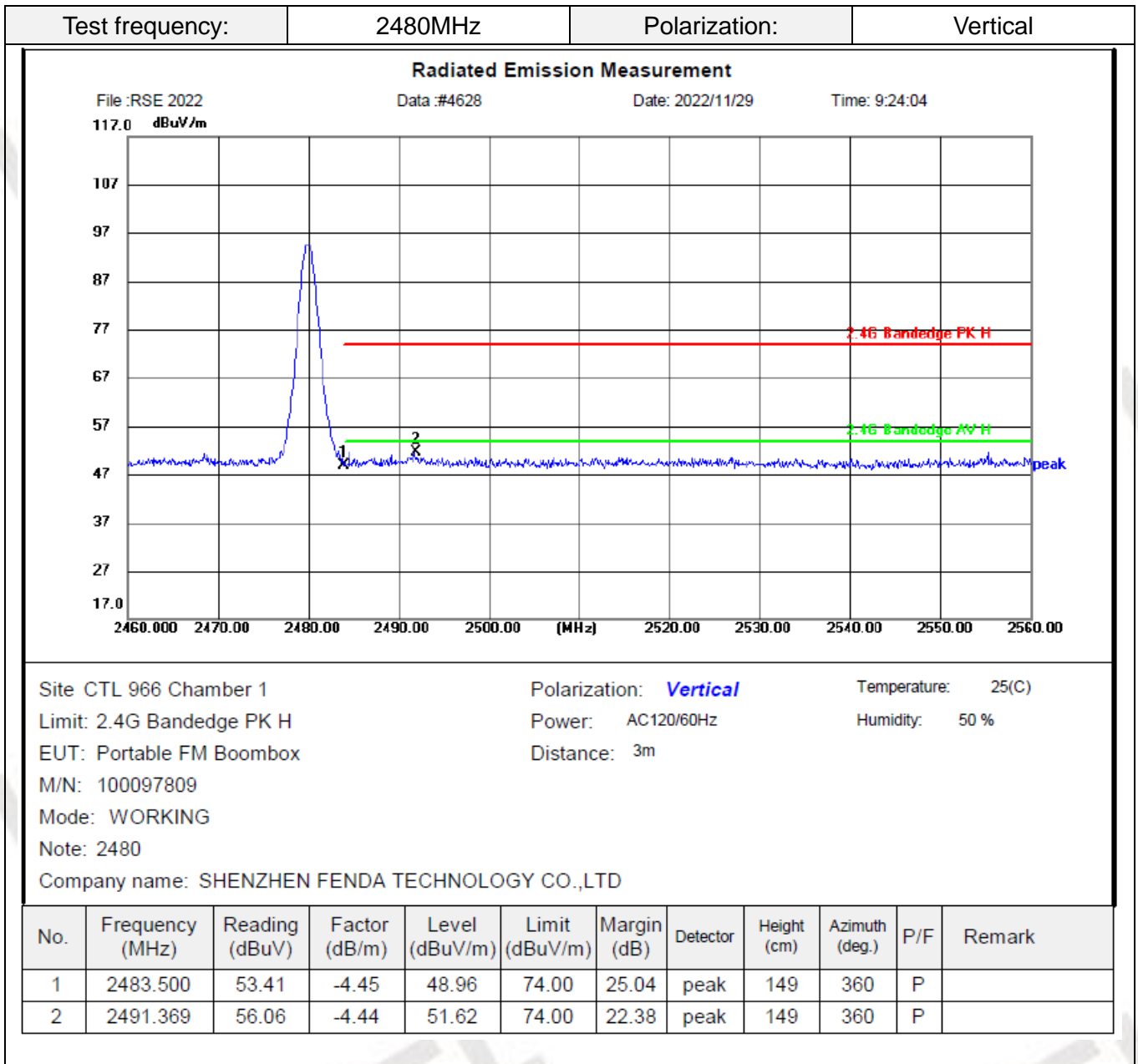

REMARKS:

1. Level (dBuV/m) =Reading (dBuV)+ Factor (dB/m)
2. Factor (dB/m) = Antenna Factor (dB/m)+Cable Factor (dB)-Pre-amplifier Factor
3. Margin value = Limit value-Level value.
4. Other emission levels are attenuated 20dB below the limit and not recorded in report.
5. RBW1MHz VBW3MHz Peak detector is for PK value; RBW 1MHz VBW10Hz Peak detector is for AV value.

### 3.3. Maximum Peak Output Power

#### Limit

For frequency hopping systems operating in the 2400-2483.5 MHz band employing at least 75 non-overlapping hopping channels: 1 watt.

For all other frequency hopping systems in the 2400-2483.5 MHz band: 0.125 watts.

#### Test Procedure

Remove the antenna from the EUT and then connect a low loss RF cable from the antenna port to the spectrum.

#### Test Configuration



#### Test Results

Raw data reference to Annex for FCC Bluetooth BR&EDR Appendix C.



### 3.4. 20dB Bandwidth

#### Limit

For frequency hopping systems operating in the 2400MHz-2483.5MHz no limit for 20dB bandwidth.

#### Test Procedure

The transmitter output was connected to the spectrum analyzer through an attenuator. The bandwidth of the fundamental frequency was measured by spectrum analyzer with 30 KHz RBW and 100 KHz VBW.

The 20dB bandwidth is defined as the total spectrum the power of which is higher than peak power minus 20dB.

#### Test Configuration



#### Test Results

Raw data reference to Annex for FCC Bluetooth BR&EDR Appendix A.

### 3.5. Occupied Bandwidth

#### Limit

N/A

#### Test Procedure

The occupied bandwidth is the frequency bandwidth such that, below its lower and above its upper frequency limits, the mean powers are each equal to 0.5% of the total mean power of the given emission. The following procedure shall be used for measuring 99% power bandwidth:

RBW=1% to 5% of the OBW

VBW=approximately 3 X RBW

Detector=Peak

Trace Mode: Max Hold

Use the 99% power bandwidth function of the instrument to measure the Occupied Bandwidth and recorded.

#### Test Configuration

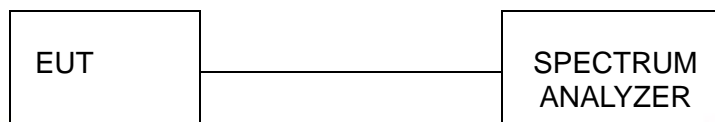

#### Test Results

Raw data reference to Annex for FCC Bluetooth BR&EDR Appendix B.

### 3.6. Frequency Separation

#### LIMIT

According to 15.247(a)(1), frequency hopping systems shall have hopping channel carrier frequencies separated by minimum of 25KHz or the  $2/3 \times 20\text{dB}$  bandwidth of the hopping channel, whichever is greater.

#### TEST PROCEDURE

The transmitter output was connected to the spectrum analyzer through an attenuator. The bandwidth of the fundamental frequency was measured by spectrum analyzer with 100 KHz RBW and 300 KHz VBW.

#### TEST CONFIGURATION

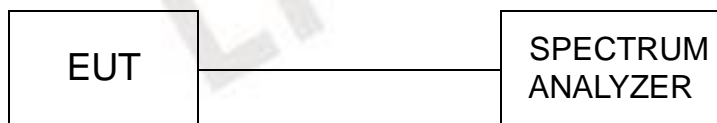

#### TEST RESULTS

Raw data reference to Annex for FCC Bluetooth BR&EDR Appendix D.

### 3.7. Number of hopping frequency

#### Limit

Frequency hopping systems in the 2400–2483.5 MHz band shall use at least 15 channels.

#### Test Procedure

The transmitter output was connected to the spectrum analyzer through an attenuator. Set spectrum analyzer start 2400MHz to 2483.5MHz with 100 KHz RBW and 300 KHz VBW.

#### Test Configuration



#### Test Results

Raw data reference to Annex for FCC Bluetooth BR&EDR Appendix F.

### 3.8. Time of Occupancy (Dwell Time)

#### Limit

The average time of occupancy on any channel shall not be greater than 0.4 seconds within a period of 0.4 seconds multiplied by the number of hopping channels employed.

#### Test Procedure

The transmitter output was connected to the spectrum analyzer through an attenuator. Set center frequency of spectrum analyzer=operating frequency with 1MHz RBW and 1MHz VBW, Span 0Hz.

#### Test Configuration



#### Test Results

Raw data reference to Annex for FCC Bluetooth BR&EDR Appendix E.

### 3.9. Out-of-band Emissions

#### Limit

In any 100 kHz bandwidth outside the frequency band in which the spread spectrum or digitally modulated intentional radiator is operating, the radio frequency power that is produced by the intentional radiator shall be at least 20 dB below that in the 100 kHz bandwidth within the band that contains the highest level of the desired power, based on either an RF conducted or a radiated measurement, provided the transmitter demonstrates compliance with the peak conducted power limits. If the transmitter complies with the conducted power limits based on the use of RMS averaging over a time interval, as permitted under paragraph (b)(3) of this section, the attenuation required under this paragraph shall be 30 dB instead of 20 dB. Attenuation below the general limits specified in §15.209(a) is not required.

#### Test Procedure

Connect the transmitter output to spectrum analyzer using a low loss RF cable, and set the spectrum analyzer to RBW=100 kHz, VBW= 300 kHz, peak detector, and max hold. Measurements utilizing these settings are made of the in-band reference level, band edge and out-of-band emissions.

#### Test Configuration

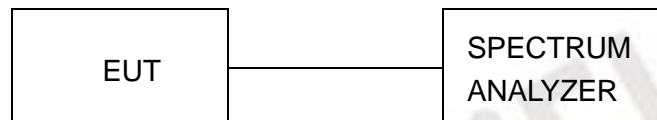

#### Test Results

Raw data reference to Annex for FCC Bluetooth BR&EDR Appendix G and Appendix H.

### 3.10. Pseudorandom Frequency Hopping Sequence

**TEST APPLICABLE**

**For 47 CFR Part 15C section 15.247 (a) (1) requirement:**

Frequency hopping systems shall have hopping channel carrier frequencies separated by a minimum of 25 kHz or the 20 dB bandwidth of the hop-ping channel, whichever is greater. Alternatively, frequency hopping systems operating in the 2400–2483.5 MHz band may have hopping channel carrier frequencies that are separated by 25 kHz or two-thirds of the 20 dB bandwidth of the hopping channel, whichever is greater, provided the systems operate with an output power no greater than 125 mW. The system shall hop to channel frequencies that are selected at the system hopping rate from a pseudo randomly ordered list of hopping frequencies. Each frequency must be used equally on the average by each transmitter. The system receivers shall have input bandwidths that match the hop-ping channel bandwidths of their corresponding transmitters and shall shift frequencies in synchronization with the transmitted signals.

**EUT Pseudorandom Frequency Hopping Sequence Requirement**

The pseudorandom frequency hopping sequence may be generated in a nine-stage shift register whose 5<sup>th</sup> and 9<sup>th</sup> stage outputs are added in a modulo-two addition stage. And the result is fed back to the input of the first stage. The sequence begins with the first one of 9 consecutive ones, for example: the shift register is initialized with nine ones.

- Number of shift register stages:9
- Length of pseudo-random sequence:29-1=511 bits
- Longest sequence of zeros:8(non-inverted signal)

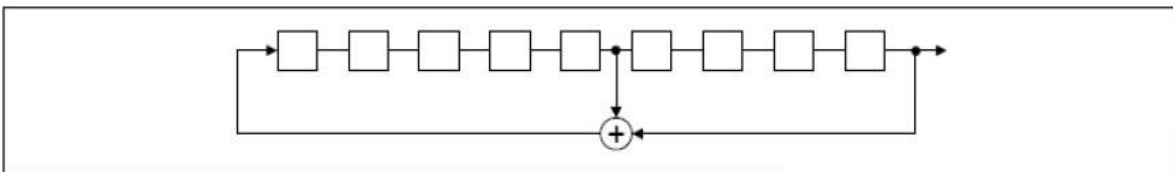

*Linear Feedback Shift Register for Generation of the PRBS sequence*

An example of pseudorandom frequency hopping sequence as follows:

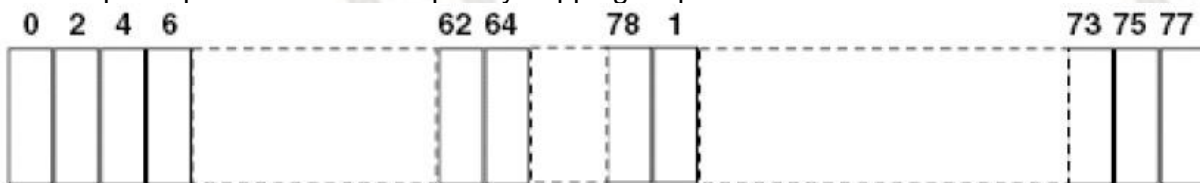

Each frequency used equally one the average by each transmitter.

The system receiver have input bandwidths that match the hopping channel bandwidths of their corresponding transmitter and shift frequencies in synchronization with the transmitted signals.

### 3.11. Antenna Requirement

#### Standard Applicable

**For intentional device, according to FCC 47 CFR Section 15.203:**

An intentional radiator shall be designed to ensure that no antenna other than that furnished by the responsible party shall be used with the device. The use of a permanently attached antenna or of an antenna that uses a unique coupling to the intentional radiator, the manufacturer may design the unit so that a broken antenna can be replaced by the user, but the use of a standard antenna jack or electrical connector is prohibited

**FCC CFR Title 47 Part 15 Subpart C Section 15.247(c)(1)(i):**

(i) Systems operating in the 2400-2483.5 MHz band that is used exclusively for fixed. Point-to-point operations may employ transmitting antennas with directional gain greater than 6dBi provided the maximum conducted output power of the intentional radiator is reduced by 1 dB for every 3 dB that the directional gain of the antenna exceeds 6dBi.

#### Antenna Connected Construction

The maximum gain of antenna was 1.43dBi.



### 4. Test Setup Photos of the EUT



## 5. Photos of the EUT

### External Photos of EUT

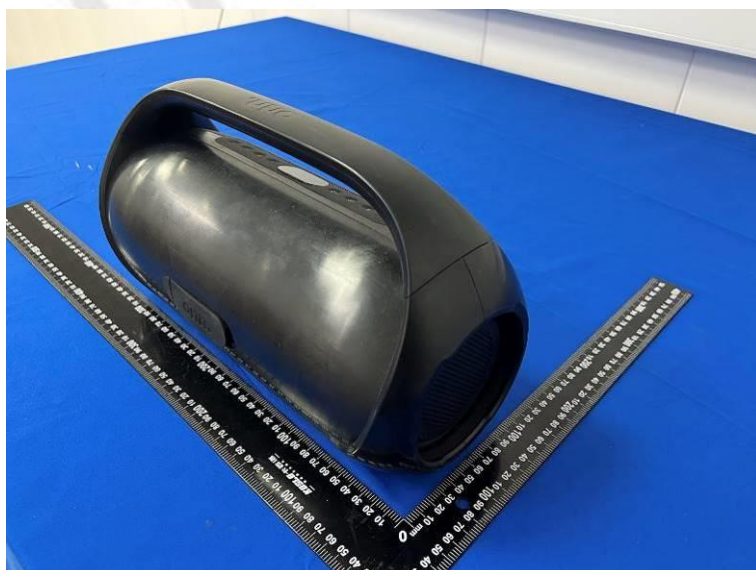



**Internal Photos of EUT**

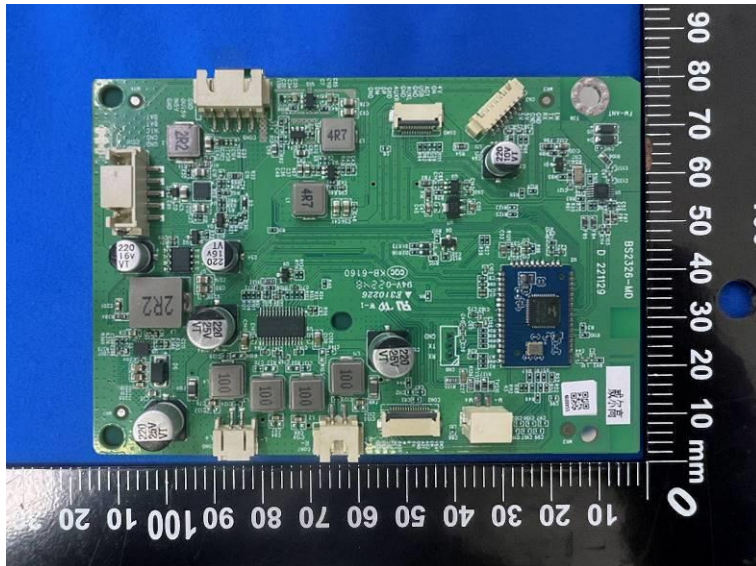
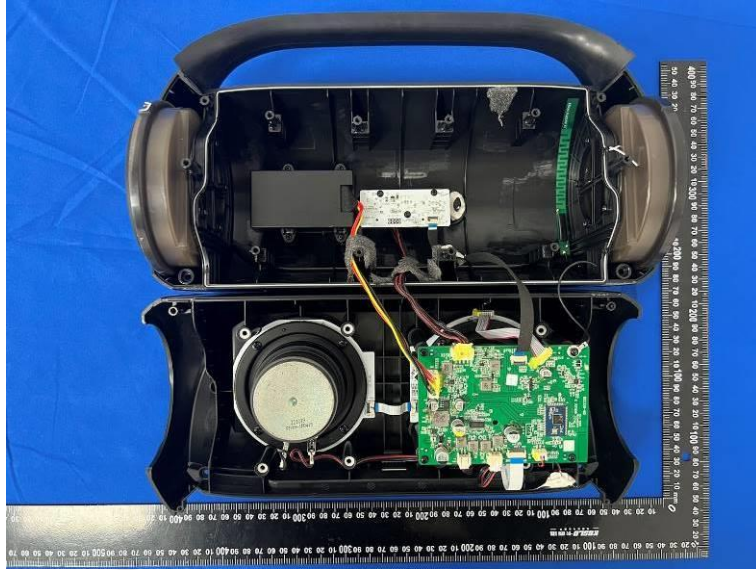

BT Antenna

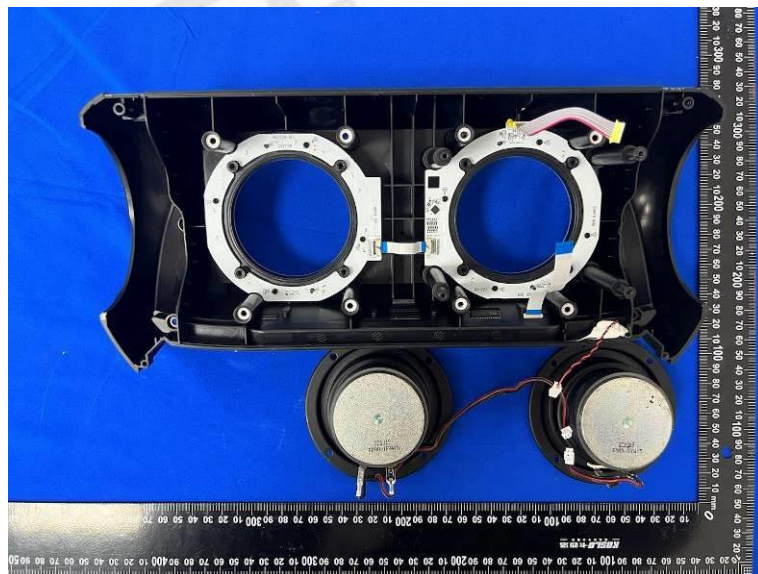
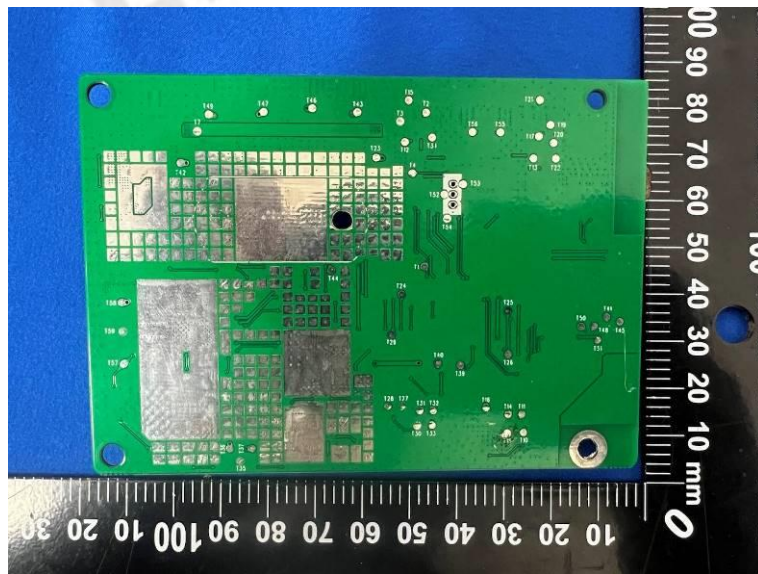
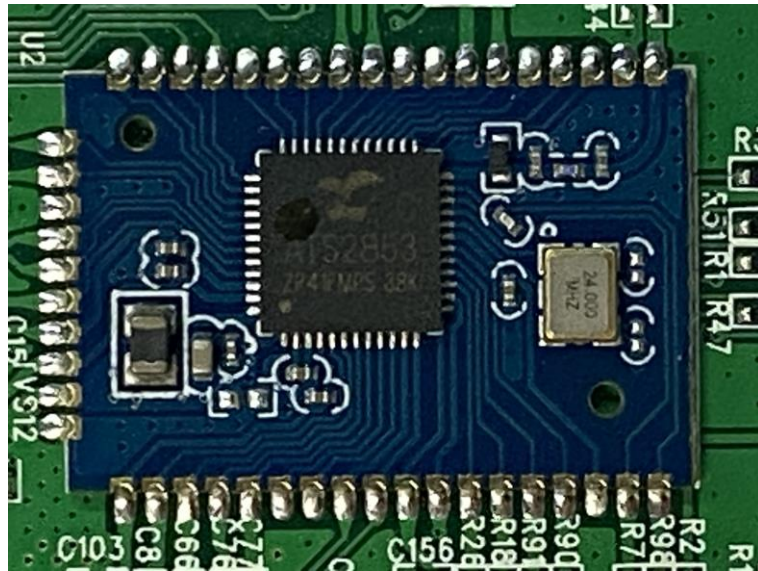

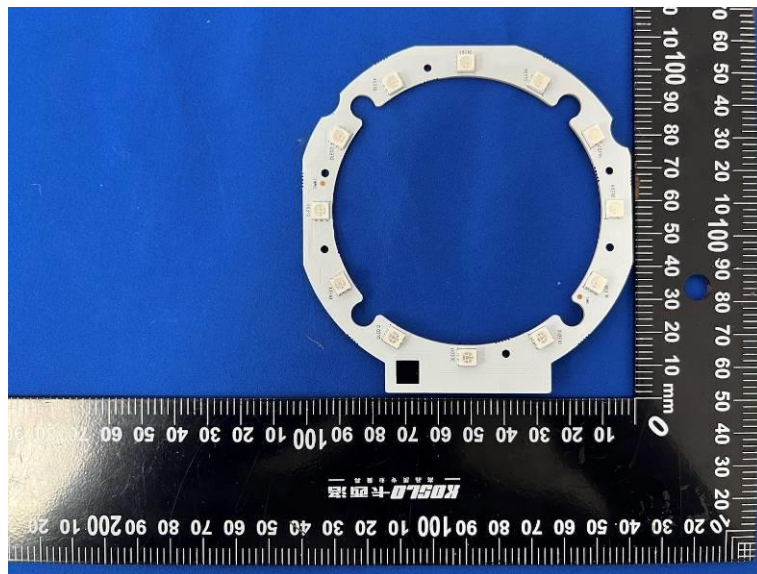
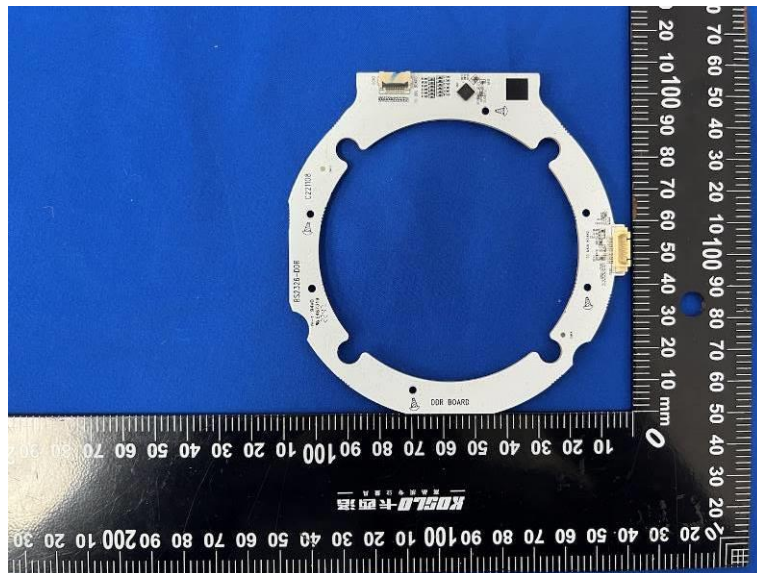

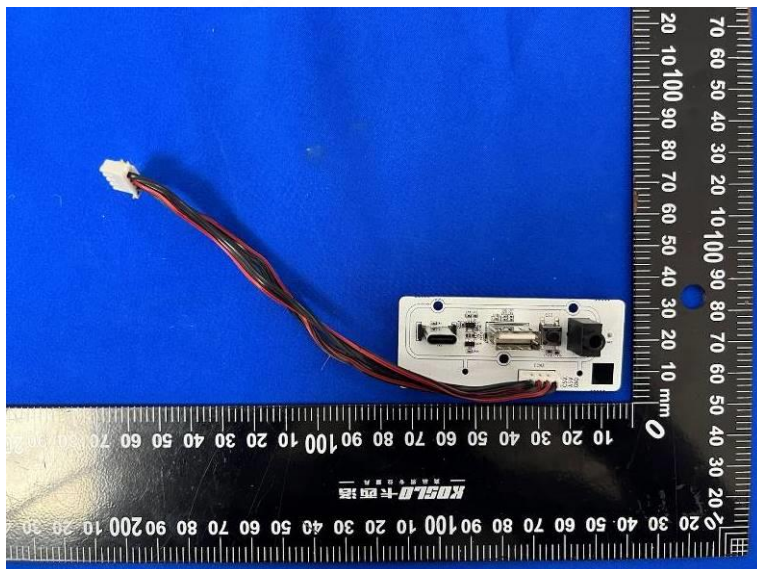
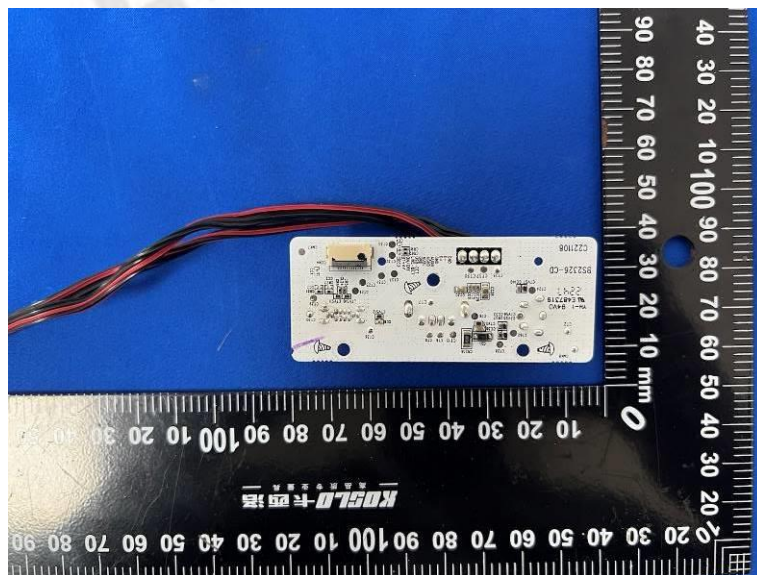

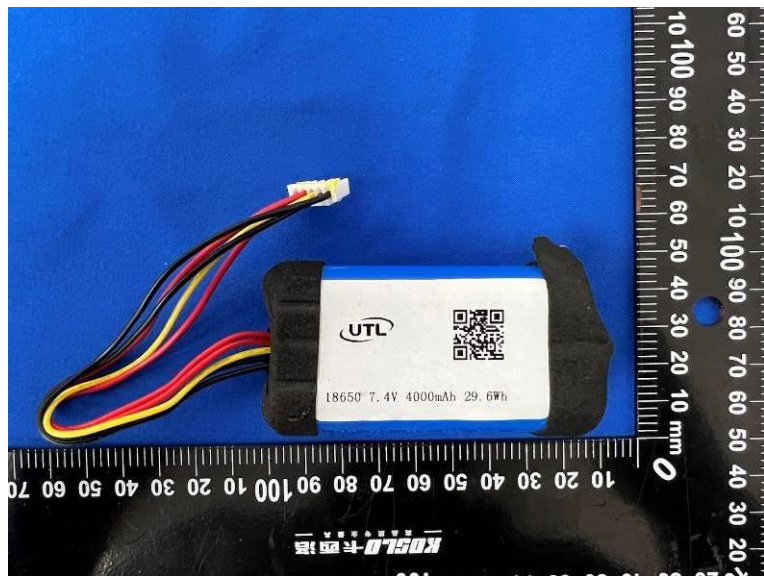

\*\*\*\*\* End of Report \*\*\*\*\*