

TEST REPORT
DYNAMIC FREQUENCY SELECTION REQUIREMENTS
OF

FCC Part 15 Subpart E (UNII)

Symbol Technologies
Model(s): MC9090

FCC ID: H9P2121160

MANUFACTURER: Symbol Technologies
One Symbol Plaza
Holtsville, New York 11742

TEST SITE: Elliott Laboratories, Inc.
684 W. Maude Ave
Sunnyvale, CA 94086

REPORT DATE: March 30, 2007

FINAL TEST DATE: March 30, 2007

AUTHORIZED SIGNATORY: _____

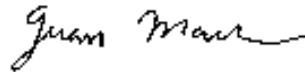

Juan Martinez
Sr. EMC Engineer



2016-01

Elliott Laboratories, Inc. is accredited by the A2LA, certificate number 2016-01, to perform the test(s) listed in this report. This report shall not be reproduced, except in its entirety, without the written approval of Elliott Laboratories, Inc.

TABLE OF CONTENTS

COVER PAGE.....	1
TABLE OF CONTENTS	2
LIST OF FIGURES AND TABLES	3
SCOPE.....	4
OBJECTIVE.....	4
STATEMENT OF COMPLIANCE.....	4
DEVIATIONS FROM THE STANDARD	4
EQUIPMENT UNDER TEST (EUT) DETAILS	5
GENERAL.....	5
ENCLOSURE	5
MODIFICATIONS.....	5
SUPPORT EQUIPMENT.....	6
EUT INTERFACE PORTS	6
EUT OPERATION	6
TEST RESULTS	7
TEST RESULTS SUMMARY – FCC PART 15, CLIENT DEVICE.....	7
MEASUREMENT UNCERTAINTIES	7
DFS TEST METHODS	8
RADIATED TEST METHOD	8
CONDUCTED TEST METHOD.....	10
DFS MEASUREMENT INSTRUMENTATION.....	11
RADAR GENERATION SYSTEM	11
CHANNEL MONITORING SYSTEM	12
DFS MEASUREMENT METHODS	13
DFS – CHANNEL CLOSING TRANSMISSION TIME AND CHANNEL MOVE TIME.....	13
SAMPLE CALCULATIONS	14
DETECTION PROBABILITY / SUCCESS RATE.....	14
THRESHOLD LEVEL.....	14
APPENDIX A TEST EQUIPMENT CALIBRATION DATA.....	15
APPENDIX B TEST DATA TABLES FOR RADAR DETECTION PROBABILITY.....	16
APPENDIX C TEST DATA TABLES AND PLOTS FOR CHANNEL CLOSING.....	17
FCC PART 15 SUBPART E DATA.....	17
APPENDIX D TEST DATA – CHANNEL AVAILABILITY CHECK.....	20
APPENDIX E TEST DATA – UNIFORM LOADING.....	21
APPENDIX F ANTENNA SPECIFICATION SHEET	22
APPENDIX G TEST CONFIGURATION PHOTOGRAPHS.....	23

LIST OF FIGURES AND TABLES

Table 1 FCC Part 15 Subpart E Client Device Test Result Summary 7
Table 2 FCC Part 15 Subpart E Channel Closing Test Results..... 17

Figure 1 Test Configuration for Radiated Measurement Method..... 8
Figure 2 Test Configuration for Conducted Measurement Method..... 10

SCOPE

The Federal Communications Commission regarding ElectroMagnetic Compatibility and Radio spectrum Matters for radio-communications devices. Tests have been performed on the Symbol Technologies model MC9090 in accordance with the following standard.

- FCC Part 15 Subpart E Unlicensed National Information Infrastructure (U-NII) Devices

Tests were performed in accordance with the standard together with the current published versions of the basic standards referenced therein as outlined in Elliott Laboratories test procedures.

The test results recorded herein are based on a single type test of the Symbol Technologies model MC9090 and therefore apply only to the tested sample. The sample was selected and prepared by David Anderson of Motorola.

Testing performed on the MC9090 was considered representative of the following models: MC3090BT, MC7090, MC7094, MC9094, MC9097, RF1224 , VC5090 and 2122160,

OBJECTIVE

The objective of the manufacturer is to comply with the standards identified in the previous section. In order to demonstrate compliance, the manufacturer or a contracted laboratory makes measurements and takes the necessary steps to ensure that the equipment complies with the appropriate technical standards. Compliance with some DFS features is covered through a manufacturer statement or through observation of the device.

STATEMENT OF COMPLIANCE

The tested sample of Symbol Technologies model MC9090 complied with the DFS requirements of:

FCC Part 15.407(h)

Maintenance of compliance is the responsibility of the manufacturer. Any modifications to the product should be assessed to determine their potential impact on the compliance status of the device with respect to the standards detailed in this test report.

DEVIATIONS FROM THE STANDARD

No deviations were made from the test methods and requirements covered by the scope of this report.

EQUIPMENT UNDER TEST (EUT) DETAILS**GENERAL**

The Symbol Technologies model MC9090 is a

The sample was received on March 30, 2007 and tested on March 30, 2007. The EUT consisted of the following component(s):

Manufacturer	Model	Description	Serial Number	FCC ID
Symbol Technologies	MC9090	Mini Radio Card	N/A	H9P2121160

The manufacturer declared values for the EUT operational characteristics that affect DFS are as follows:

Operating Modes

- Master Device
 Client Device with no radar detection
 Client Device with In-Service Monitoring

Antenna Gains / EIRP

	5250 – 5350 MHz
Lowest Antenna Gain (dBi)	4.9 dBi
Highest Antenna Gain (dBi)	4.9 dBi
Output Power (dBm)	19.2

- Power can exceed 200mW eirp

Channel Protocol

- IP Based
 Frame Based
 OTHER _____

ENCLOSURE

The EUT has no enclosure. It is designed to be installed within the enclosure of a host computer.

MODIFICATIONS

The EUT did not require modifications during testing in order to comply with the requirements of the standard(s) referenced in this test report.

SUPPORT EQUIPMENT

The following equipment was used as local support equipment for testing:

Manufacturer	Model	Description	Serial Number	FCC ID
Acer	ZB2	Laptop	LXTCJ061136370 1907725	DoC
MiLAN	Mil- S501ST	Hub	N/A	N/A
Motorola	MC9090	Handheld PDA	N/A	DoC
<i>Cisco</i>	<i>AIR- AP1131A G-A-K9</i>	<i>Access Point</i>	<i>FTX1040T17J</i>	<i>LDK102054E</i>

The italicized device was the master device.

EUT INTERFACE PORTS

The I/O cabling configuration during testing was as follows:

Port	Connected To	Cable(s)		
		Description	Shielded or Unshielded	Length(m)
Laptop Ethernet	Hub	Cat 5	Unshielded	0.5
Hub Ethernet	Master AP	Cat 5	Unshielded	5

EUT OPERATION

The EUT was operating with the following software.

Client Device: 2.5.1.0.061R

During the in-service monitoring detection probability and channel moving tests the system was configured with a streaming video file from the master device (sourced by the PC connected to the master device via an Ethernet interface) to the client device.

The streamed Wave file was the FCC test file "5_GHz_Audio_Test_file.wav" and the client device was using Windows Media Player Classic as accepted by FCC Part 15 Subpart E

TEST RESULTS**TEST RESULTS SUMMARY – FCC Part 15, CLIENT DEVICE**

Description	Radar Type	Radar Frequency	Measured Value	Requirement	Test Data	Status
Channel closing transmission time	Type 1	5320 MHz	0ms	60ms	Appendix C	Pass
Channel move time	Type 1	5320 MHz	0s	10s	Appendix C	Pass

Table 1 FCC Part 15 Subpart E Client Device Test Result Summary

Notes:

1) Channel availability check, detection threshold and non-occupancy period are not applicable to client devices.

MEASUREMENT UNCERTAINTIES

ISO/IEC 17025 requires that an estimate of the measurement uncertainties associated with the emissions test results be included in the report. The measurement uncertainties given below are based on a 95% confidence level, with a coverage factor (k=2) and were calculated in accordance with UKAS document LAB 34.

Measurement	Measurement Unit	Expanded Uncertainty
Timing (Channel move time, aggregate transmission time)	ms	Timing resolution +/- 0.24%
Timing (non occupancy period)	seconds	5 seconds
DFS Threshold (radiated)	dBm	1.6
DFS Threshold (conducted)	dBm	1.2

DFS TEST METHODS

RADIATED TEST METHOD

The combination of master and slave devices is located in an anechoic chamber. The simulated radar waveform is transmitted from a directional horn antenna (typically an EMCO 3115) toward the unit performing the radar detection (radar detection device, RDD). Every effort is made to ensure that the main beam of the EUT's antenna is aligned with the radar generating antenna.

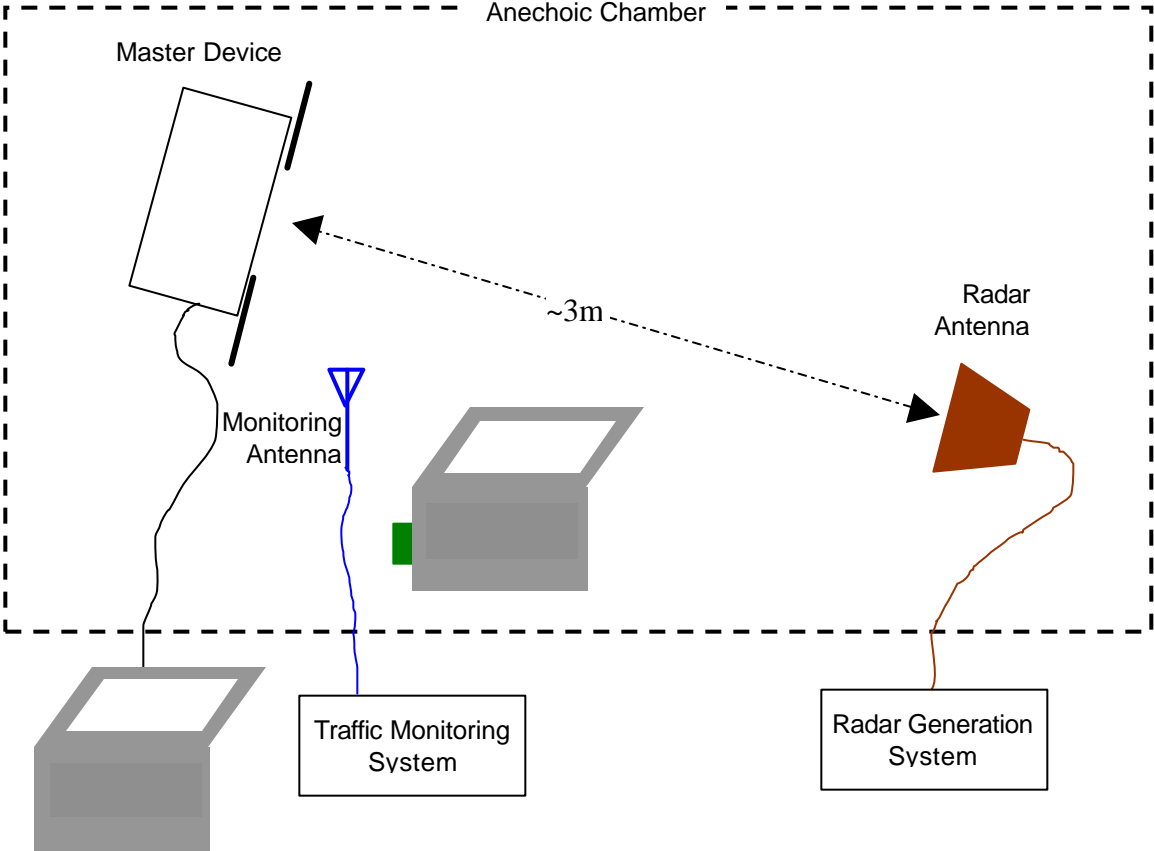

Figure 1 Test Configuration for Radiated Measurement Method

The signal level of the simulated waveform is set to a reference level equal to the threshold level (plus 1dB if testing against FCC requirements). Lower levels may also be applied on request of the manufacturer. The level reported is the level at the RDD antenna and so it is not corrected for the RDD's antenna gain. The RDD is configured with the lowest gain antenna assembly intended for use with the device.

The signal level is verified by measuring the CW signal level from the radar generation system using a reference antenna of gain G (dBi). The radar signal level is calculated from the measured level, R (dBm), and any cable loss, L (dB), between the reference antenna and the measuring instrument:

$$\text{Applied level (dBm)} = R - G_{REF} + L$$

If both master and client devices have radar detection capability then the device not under test is positioned with absorbing material between its antenna and the radar generating antenna, and the radar level at the non RDD is verified to be at least 20dB below the threshold level to ensure that any responses are due to the RDD detecting radar.

The antenna connected to the channel monitoring subsystem is positioned to allow both master and client transmissions to be observed, with the level of the EUT's transmissions between 6 and 10dB higher than those from the other device.

CONDUCTED TEST METHOD

The combination of master and slave devices is located in an anechoic chamber. The simulated radar waveform is coupled into the unit performing the radar detection (radar detection device, RDD) via couplers and attenuators.

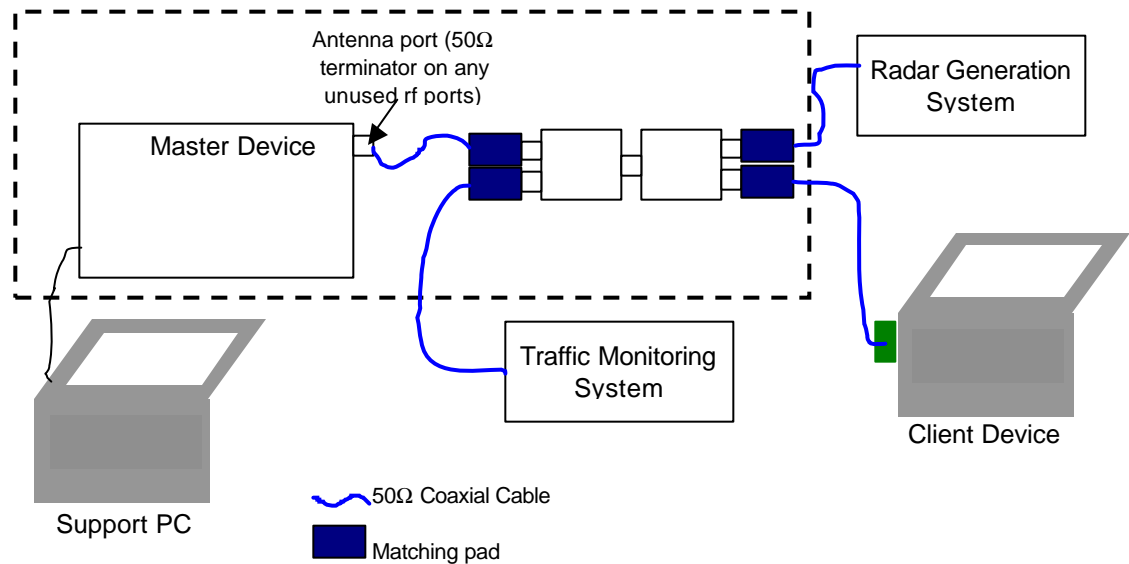

Figure 2 Test Configuration for Conducted Measurement Method

The signal level of the simulated waveform is set to a reference level equal to the threshold level (plus 1dB if testing against FCC requirements). Lower levels may also be applied on request of the manufacturer.

The signal level is verified by measuring the CW signal level at the coupling point to the RDD antenna port. The radar signal level is calculated from the measured level, R (dBm) and the lowest gain antenna assembly intended for use with the RDD, GRDD (dBi):

$$\text{Applied level (dBm)} = R - \text{GRDD}$$

If both master and client devices have radar detection capability then the radar level at the non RDD is verified to be at least 20dB below the threshold level to ensure that any responses are due to the RDD detecting radar.

The antenna connected to the channel monitoring subsystem is positioned to allow both master and client transmissions to be observed, with the level of the EUT's transmissions between 6 and 10dB higher than those from the other device.

DFS MEASUREMENT INSTRUMENTATION

RADAR GENERATION SYSTEM

An Agilent PSG is used as the radar generating source. The integral arbitrary waveform generators are programmed using Agilent's "Pulse Building" software and Elliott custom software to produce the required waveforms, with the capability to produce both un-modulated and modulated (FM Chirp) pulses. Where there are multiple values for a specific radar parameter then the software selects a value at random and, for FCC tests, the software verifies that the resulting waveform is truly unique.

With the exception of the hopping waveforms required by the FCC's rules (see below), the radar generator is set to a single frequency within the radar detection bandwidth of the EUT.

Frequency hopping radar waveforms are simulated using a time domain model. A randomly hopping sequence algorithm (which uses each channel in the hopping radar's range once in a hopping sequence) generates a hop sequence. A segment of the first 100 elements of the hop sequence are then examined to determine if it contains one or more frequencies within the radar detection bandwidth of the EUT. If it does not then the first element of the segment is discarded and the next frequency in the sequence is added. The process repeats until a valid segment is produced. The radar system is then programmed to produce bursts at time slots coincident with the frequencies within the segment that fall in the detection bandwidth. The frequency of the generator is stepped in 1 MHz increments across the EUT's detection range.

The radar signal level is verified during testing using a CW signal with the AGC function switched on. Correction factors to account for the fact that pulses are generated with the AGC functions switched off are measured annually and an offset is used to account for this in the software.

The generator output is connected to the coupling port of the conducted set-up or to the radar generating antenna.

CHANNEL MONITORING SYSTEM

Channel monitoring is achieved using a spectrum analyzer and digital storage oscilloscope. The analyzer is configured in a zero-span mode, center frequency set to the radar waveform's frequency or the center frequency of the EUT's operating channel. The IF output of the analyzer is connected to one input of the oscilloscope.

A signal generator output is set to send either the modulating signal directly or a pulse gate with an output pulse co-incident with each radar pulse. This output is connected to a second input on the oscilloscope and the oscilloscope displays both the channel traffic (via the if input) and the radar pulses on its display.

For in service monitoring tests the analyzer sweep time is set to > 20 seconds and the oscilloscope is configured with a data record length of 10 seconds for the short duration and frequency hopping waveforms, 20 seconds for the long duration waveforms. Both instruments are set for a single acquisition sequence. The analyzer is triggered 500ms before the start of the waveform and the oscilloscope is triggered directly by the modulating pulse train. Timing measurements for aggregate channel transmission time and channel move time are made from the oscilloscope data, with the end of the waveform clearly identified by the pulse train on one trace. The analyzer trace data is used to confirm that the last transmission occurred within the 10 second record of the oscilloscope. If necessary the record length of the oscilloscope is expanded to capture the last transmission on the channel prior to the channel move.

Channel availability check time timing plots are made using the analyzer. The analyzer is triggered at start of the EUT's channel availability check and used to verify that the EUT does not transmit when radar is applied during the check time.

The analyzer detector and oscilloscope sampling mode is set to peak detect for all plots.

DFS MEASUREMENT METHODS

DFS – CHANNEL CLOSING TRANSMISSION TIME AND CHANNEL MOVE TIME

Channel clearing and closing times are measured by applying a radar burst with the device configured to change channel and by observing the channel for transmissions. The time between the end of the applied radar waveform and the final transmission on the channel is the channel move time.

The aggregate transmission closing time is measured in two ways:

FCC – the total time of all individual transmissions from the EUT that are observed starting 200ms at the end of the last radar pulse in the waveform. This value is required to be less than 60ms.

SAMPLE CALCULATIONS

DETECTION PROBABILITY / SUCCESS RATE

The detection probability, or success rate, for any one radar waveform equals the number of successful trials divided by the total number of trials for that waveform.

In the case of the FCC requirements, for radar waveform types 1 through 4 an additional calculation is made to determine the average detection probability over all four radar waveform types. This calculation is the arithmetic mean of the four individual probabilities.

THRESHOLD LEVEL

The threshold level is the level of the simulated radar waveform at the EUT's antenna. If the test is performed in a conducted fashion then the level at the rf input equals the level at the antenna plus the gain of the antenna assembly, in dBi. The gain of the antenna assembly equals the gain of the antenna minus the loss of the cabling between the rf input and the antenna. The lowest gain value for all antenna assemblies intended for use with the device is used when making this calculation.

If the test is performed using the radiated method then the threshold level is the level at the antenna.

Appendix A Test Equipment Calibration Data

<u>Manufacturer</u>	<u>Description</u>	<u>Model #</u>	<u>Asset #</u>	<u>Cal Due</u>
Hewlett Packard	EMC Spectrum Analyzer, 9 kHz - 6.5 GHz	8595EM	780	05-Sep-07
Tektronix	1 GHz Oscilloscope	TDS5104	1435	10-Apr-07
EMCO	Antenna, Horn, 1-18 GHz	3117	1662	07-Apr-07
Agilent	Vector Signal Generator (250kHz - 20GHz)	E8267C	1877	23-Nov-07

Appendix B Test Data Tables for Radar Detection Probability

Not applicable device is a client with no radar detection

Appendix C Test Data Tables and Plots for Channel Closing**FCC PART 15 SUBPART E DATA**

Waveform Type	Channel Closing Transmission Time ¹		Channel Move Time		Result
	Measured	Limit	Measured	Limit	
Radar Type 1	0ms	60 ms	0s	10 s	Pass

Table 2 FCC Part 15 Subpart E Channel Closing Test Results

After the final channel closing test the channel was monitored for a further 30 minutes. No transmissions occurred on the channel.

¹ Channel closing time for FCC measurements is the aggregate transmission time starting from 200ms after the end of the radar signal to the completion of the channel move.

Elliott Timing Plots - Channel Closing

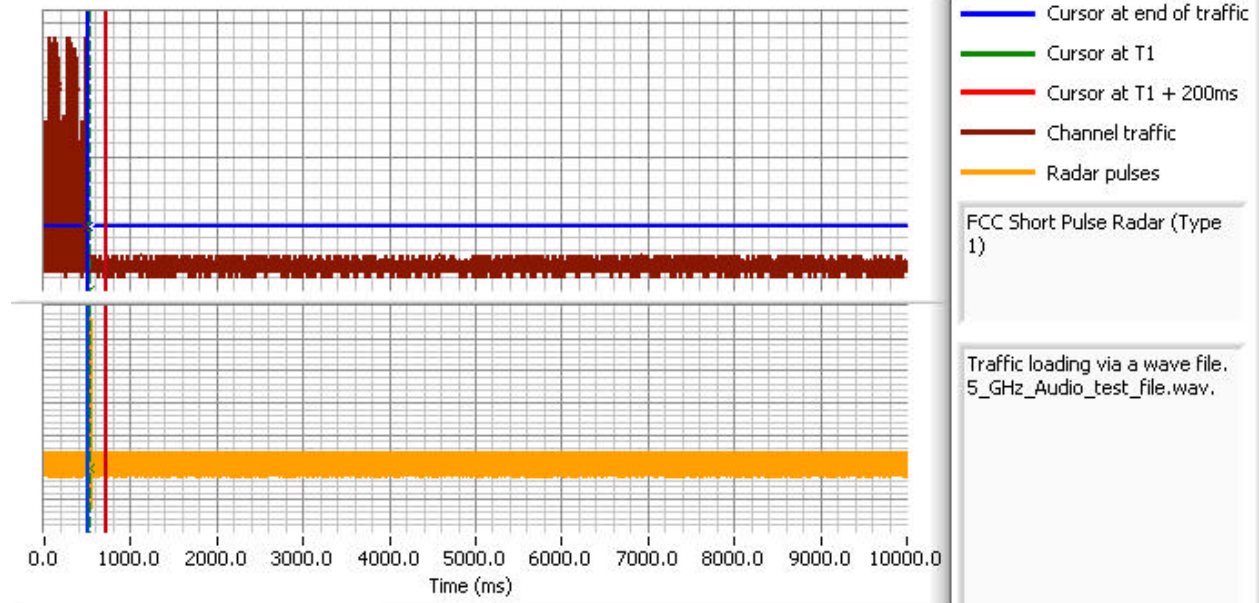

Channel closing transmission time (ms) 0.00 Measured from T1 + 200ms (FCC)

Channel move time (ms) -11 Hi-Res Plot Resolution (ms) 0.020

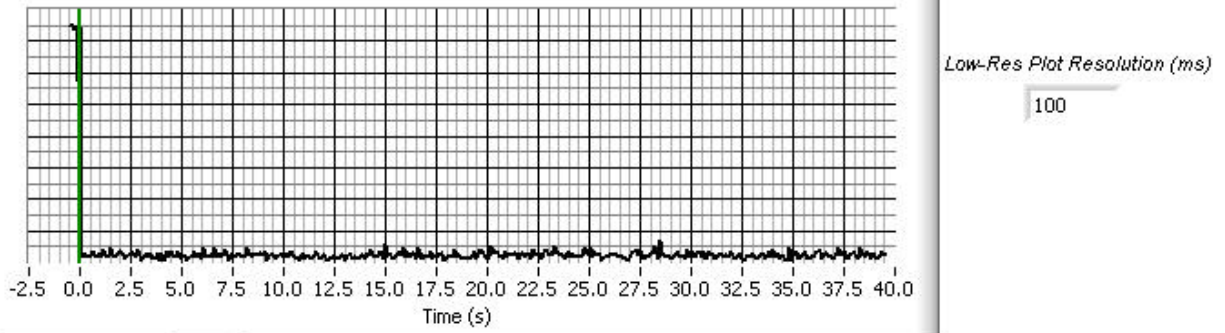

Channel Traffic Low Resolution Analyzer Plot to Verify Channel Move

Elliott Timing Plots - Channel Closing

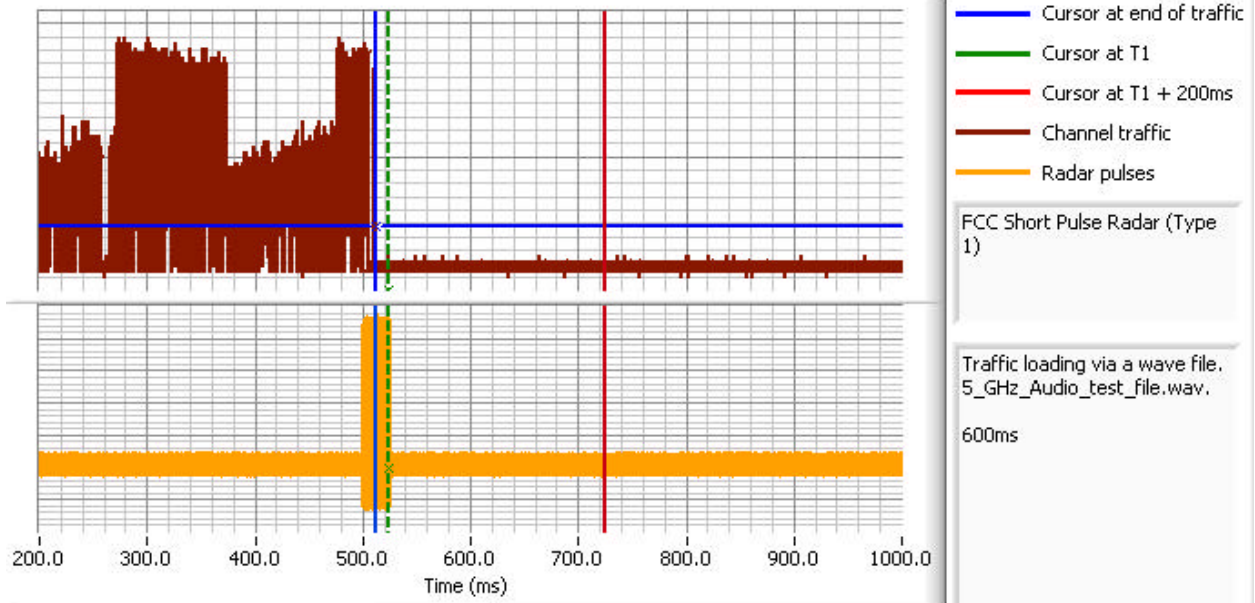

Channel closing transmission time (ms) 0.00 Measured from T1 + 200ms (FCC)

Channel move time (ms) -11 Hi-Res Plot Resolution (ms) 0.020

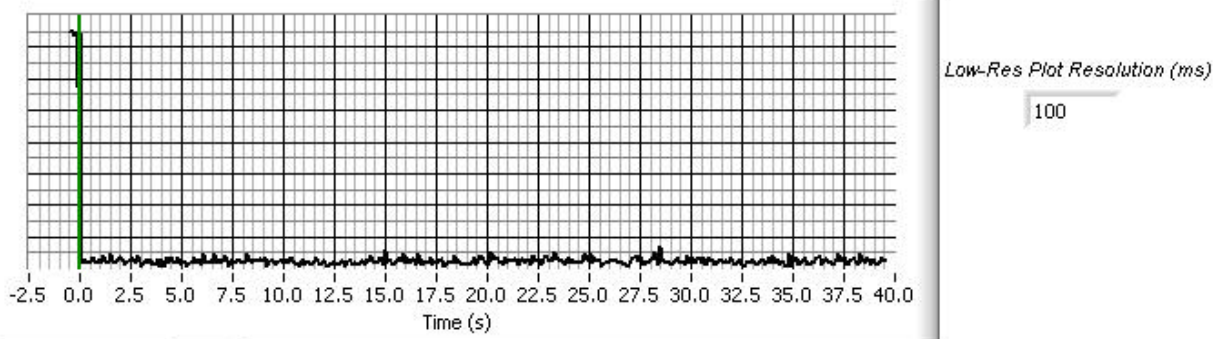

Channel Traffic Low Resolution Analyzer Plot to Verify Channel Move

Appendix D Test Data – Channel Availability Check

Not applicable device is a client with no radar detection

Appendix E Test Data – Uniform Loading

Not applicable device is a client with no radar detection

Appendix F Antenna Specification Sheet

Data Sheet attached

Appendix G Test Configuration Photographs



