



SPORTON International Inc.

No. 52, Hwa Ya 1st Rd., Kwei-Shan Hsiang, TaoYuan Hsien, Taiwan, R.O.C.
Ph: 886-3-327-3456 / FAX: 886-3-327-0973 / www.sporton.com.tw

FCC RADIO TEST REPORT

Applicant's company	SYMBOL Technologies, INC.
Applicant Address	One Symbol Plaza Holtsville, New York, 11742-1300 U.S.A
FCC ID	H9PWT4090
Manufacturer's company	Universal Scientific Industrial CO., LTD.
Manufacturer Address	141, Lane 351, Taiping Road, Sec. 1, Tsao Tuen, Nan-Tou, Taiwan

Product Name	Mobile computer
Brand Name	Symbol
Model Name	WT4090
Test Rule	47 CFR FCC Part 15 Subpart C § 15.247
Test Freq. Band	5725~5850MHz
Received Date	Jul. 24, 2006
Final Test Date	Sep. 08, 2006
Submission Type	Original Equipment



Statement

Test result included is only for the 802.11a part of the product.

The test result in this report refers exclusively to the presented test model / sample.

Without written approval of SPORTON International Inc., the test report shall not be reproduced except in full.

The measurements and test results shown in this test report were made in accordance with the procedures and found in compliance with the limit given in **ANSI C63.4-2003** and **47 CFR FCC Part 15 Subpart C**.

The test equipment used to perform the test is calibrated and traceable to NML/ROC.

NVLAQ®

Lab Code: 200079-0



Table of Contents

1. CERTIFICATE OF COMPLIANCE	1
2. SUMMARY OF THE TEST RESULT	2
3. GENERAL INFORMATION	3
3.1. Product Details.....	3
3.2. Accessories.....	3
3.3. Table for Filed Antenna.....	3
3.4. Table for Carrier Frequencies	3
3.5. Table for Test Modes	4
3.6. Table for Testing Locations.....	4
3.7. Table for Supporting Units	5
3.8. Table for Parameters of Test Software Setting	5
3.9. Test Configurations	6
4. TEST RESULT	11
4.1. AC Power Line Conducted Emissions Measurement.....	11
4.2. Maximum Peak Output Power Measurement	15
4.3. Power Spectral Density Measurement	17
4.4. 6dB Spectrum Bandwidth Measurement	20
4.5. Radiated Emissions Measurement	23
4.6. Band Edge Emissions Measurement	43
4.7. Antenna Requirements	46
5. LIST OF MEASURING EQUIPMENTS	47
6. TEST LOCATION.....	48
7. NVLAP CERTIFICATE OF ACCREDITATION	49
APPENDIX A. PHOTOGRAPHS OF EUT.....	A1 ~ A48
APPENDIX B. TEST PHOTOS.....	B1 ~ B10
APPENDIX C. MAXIMUM PERMISSIBLE EXPOSURE.....	C1 ~ C3

1. CERTIFICATE OF COMPLIANCE

Product Name : Mobile computer
Brand Name : Symbol
Model Name : WT4090
Applicant : SYMBOL Technologies, INC.
Test Rule Part(s) : 47 CFR FCC Part 15 Subpart C § 15.247

Sporton International as requested by the applicant to evaluate the EMC performance of the product sample received on Jul. 24, 2006 would like to declare that the tested sample has been evaluated and found to be in compliance with the tested rule parts. The data recorded as well as the test configuration specified is true and accurate for showing the sample's EMC nature.

Prepared By:
Jean Huang / Specialist

Tested By:
Carl Lee / Engineer

Reviewed By:
Roger Sheng / Manager

2. SUMMARY OF THE TEST RESULT

Applied Standard: 47 CFR FCC Part 15 Subpart C				
Part	Rule Section	Description of Test	Result	Under Limit
4.1	15.207	AC Power Line Conducted Emissions	Complies	11.50 dB
4.2	15.247(b)(3)	Maximum Peak Conducted Output Power	Complies	12.29 dB
4.3	15.247(e)	Power Spectral Density	Complies	20.53 dB
4.4	15.247(a)(2)	6dB Spectrum Bandwidth	Complies	-
4.5	15.247(d)	Radiated Emissions	Complies	5.66 dB
4.6	15.247(d)	Band Edge Emissions	Complies	3.65 dB
4.7	15.203	Antenna Requirements	Complies	-

Test Items	Uncertainty	Remark
AC Power Line Conducted Emissions	±2.26dB	Confidence levels of 95%
Maximum Peak Conducted Output Power	±0.5dB	Confidence levels of 95%
Power Spectral Density	±0.71dB	Confidence levels of 95%
6dB Spectrum Bandwidth	±6.25×10 ⁻⁷	Confidence levels of 95%
Radiated Emissions/ Band Edge Emissions	±3.72dB	Confidence levels of 95%

3. GENERAL INFORMATION

3.1. Product Details

EUT is a Mobile computer with IEEE 802.11 a/b/g, Bluetooth radio functions. Only the radio detail of WLAN is shown in the table below. For more detailed features description, please refer to the manufacturer's specifications or user's manual.

Items	Description
Power Type	12V DC from adapter; 3.7V DC from battery
Modulation	OFDM for IEEE 802.11a
Data Modulation	OFDM (BPSK / QPSK / 16QAM / 64QAM)
Data Rate (Mbps)	OFDM (6/9/12/18/24/36/48/54)
Frequency Band	5725 ~ 5850MHz
Channel Number	3
Channel Band Width (99%)	16.36 MHz
Conducted Output Power	17.71 dBm

3.2. Accessories

Power	Brand	Model	Rating
Adapter	HIPRO	HP-O2040D43	INPUT: 100 ~ 240V AC OUTPUT: 12V DC
Battery	Symbol	-	3.7V DC
Others			
Cradle, scanner RS-409, scanner RS-309, Headset (MIC + Earphone)			

3.3. Table for Filed Antenna

Ant.	Antenna Type	Brand	Model	Connector	Gain (dBi)	Remark
1	PIFA Antenna	Laird	NG Wearable	UFL	4.42	WLAN

3.4. Table for Carrier Frequencies

Frequency Band	Channel No.	Frequency
5725 ~ 5850 MHz (USA/Canada/Taiwan)	149	5745 MHz
	157	5785 MHz
	165	5825 MHz

3.5. Table for Test Modes

Preliminary tests were performed in different data rate to find the worst radiated emission. The data rate shown in the table below is the worst-case rate with respect to the specific test item. Investigation has been done on all the possible configurations for searching the worst cases. The following table is a list of the test modes shown in this test report.

Test Items	Mode	Data Rate	Channel
AC Power Line Conducted Emissions	Charging+USB Link+WLAN Link+Audio+Video Mode	11 Mbps	-
Max. Peak Conducted Output Power Power Spectral Density 6dB Spectrum Bandwidth	11a/BPSK	6 Mbps	149/157/165
Radiated Emissions Below 1GHz	11a/BPSK	6 Mbps	-
Radiated Emissions Above 1GHz Band Edge Emissions	11a/BPSK	6 Mbps	149/157/165

Note:

There are five test modes shown in the Radiated Emissions below 1GHz:

Mode 1: Scanner RS-309 with long cable

Mode 2: Scanner RS-309 with short cable

Mode 3: Scanner RS-409 with long cable

Mode 4: Scanner RS-409 with short cable

Mode 5: Charging Mode

3.6. Table for Testing Locations

Test Site No.	Site Category	Location	FCC Reg. No.	IC File No.	VCCI Reg. No
03CH03-HY	SAC	Hwa Ya	101377	IC 4088	-
CO04-HY	Conduction	Hwa Ya	101377	IC 4088	-
TH01-HY	OVEN Room	Hwa Ya	-	-	-

Open Area Test Site (OATS); Semi Anechoic Chamber (SAC); Fully Anechoic Chamber (FAC).

Please refer section 6 for Test Site Address.

3.7. Table for Supporting Units

Support Unit	Brand	Model	FCC ID
Bar code	-	-	Provide by Customer
Headset (MIC + Earphone)	-	-	
AP (Remote workstation)	VSI	AP-B-AG-01	
PDA (Remote workstation)	SYMBOL	MC3090BT	
Scanner RS-309 with long cable	-	-	
Scanner RS-309 with short cable	-	-	
Scanner RS-409 with long cable	-	-	
Scanner RS-409 with short cable	-	-	
Notebook	DELL	D400	DoC
Mouse	Microsoft	1004	DoC
Modem	ACEEX	DM-1414	IFAXDM1414

3.8. Table for Parameters of Test Software Setting

During testing, Channel & Power Controlling Software provided by the customer was used to control the operating channel as well as the output power level. The RF output power selection is for the setting of RF output power expected by the customer and is going to be fixed on the firmware of the final end product.

Power Parameters of IEEE 802.11a

Test Software Version	CECTRX		
Frequency	5745 MHz	5785 MHz	5825 MHz
IEEE 802.11a	15.75	15.50	15.50

3.9. Test Configurations

3.9.1. Radiation Emissions Test Configuration

9kHz ~ 1GHz

Scanner RS-309 with long cable

Scanner RS-309 with short cable

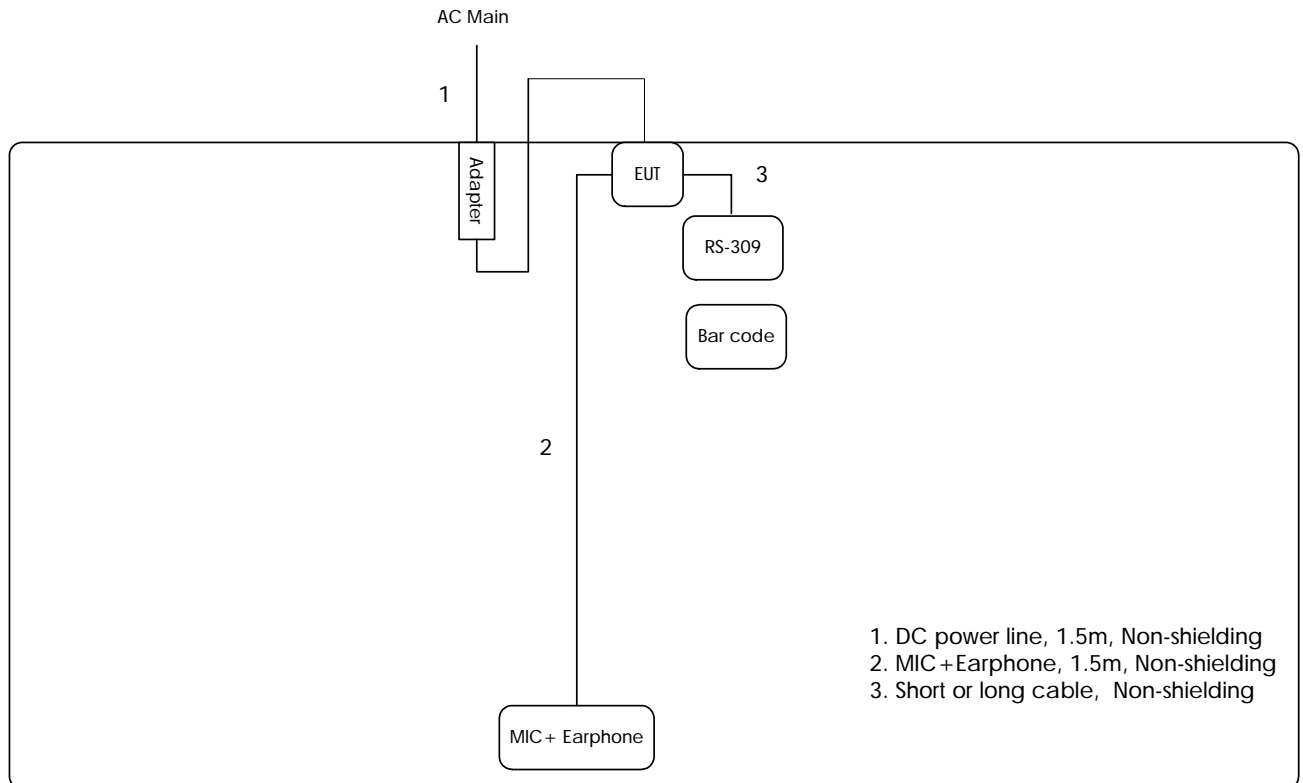

Scanner RS-409 with long cable

Scanner RS-409 with short cable

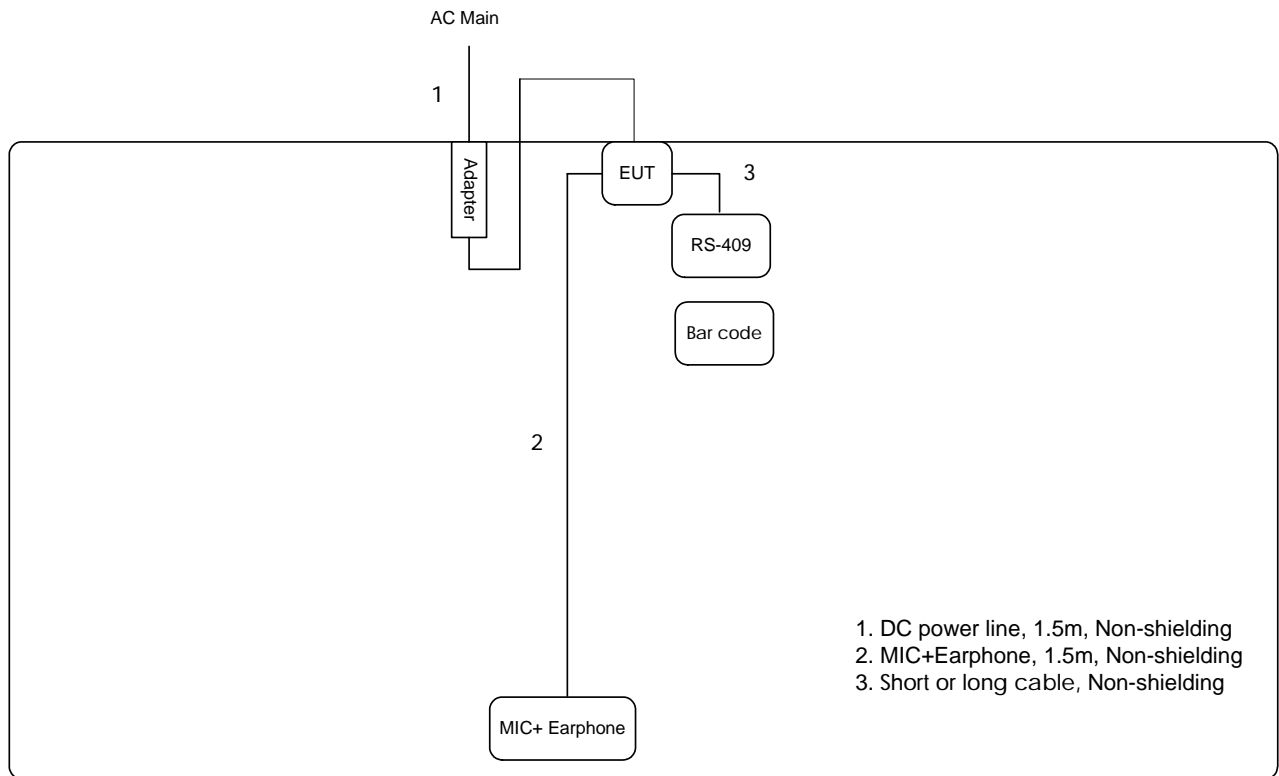

Charging Mode

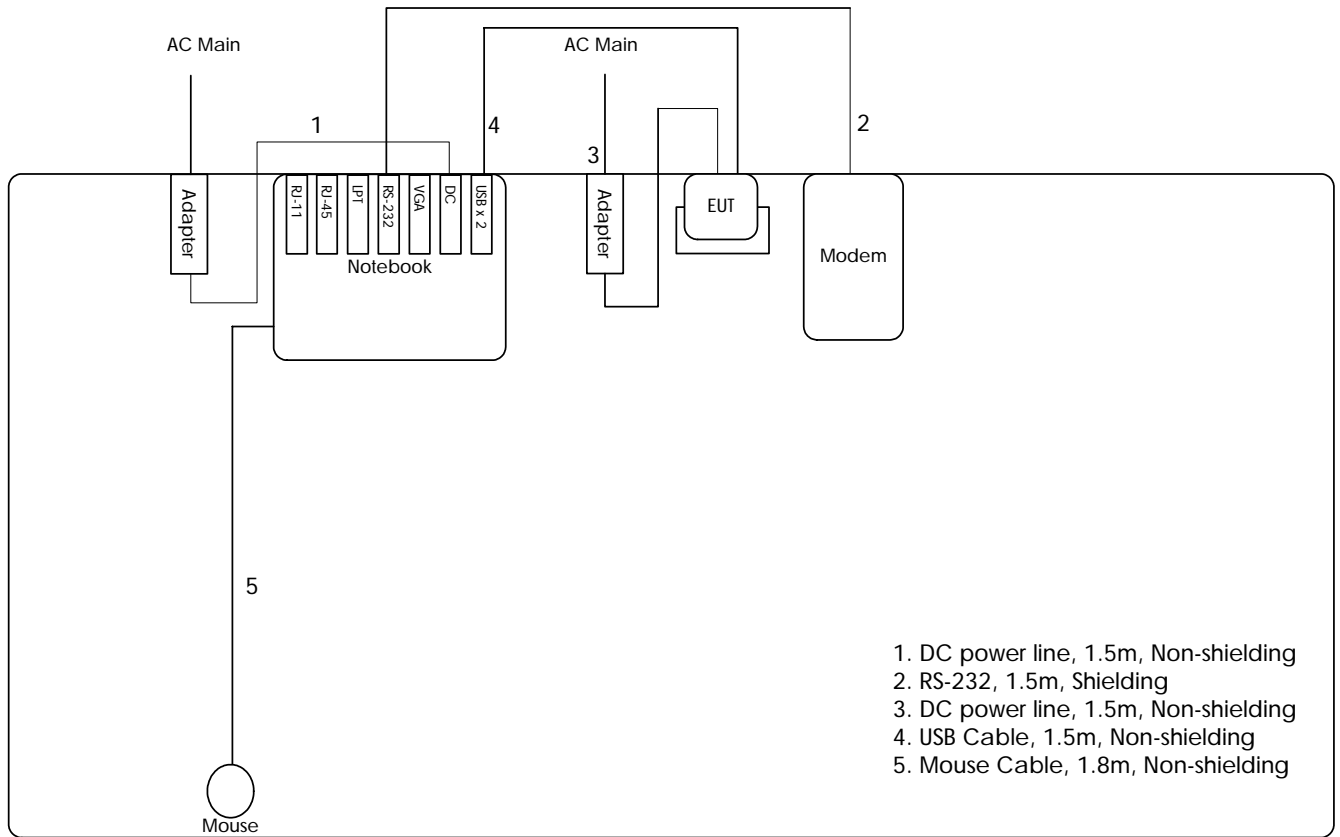

Above 1GHz

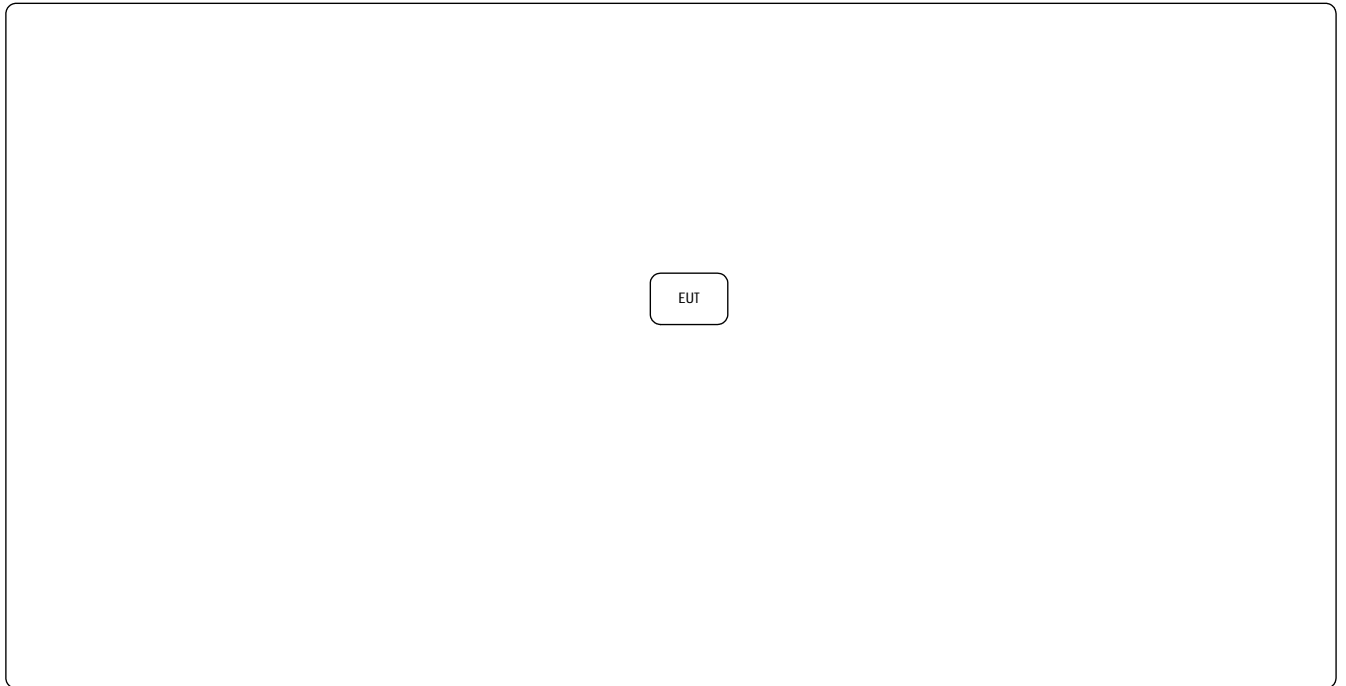

3.9.2. AC Power Line Conduction Emissions Test Configuration

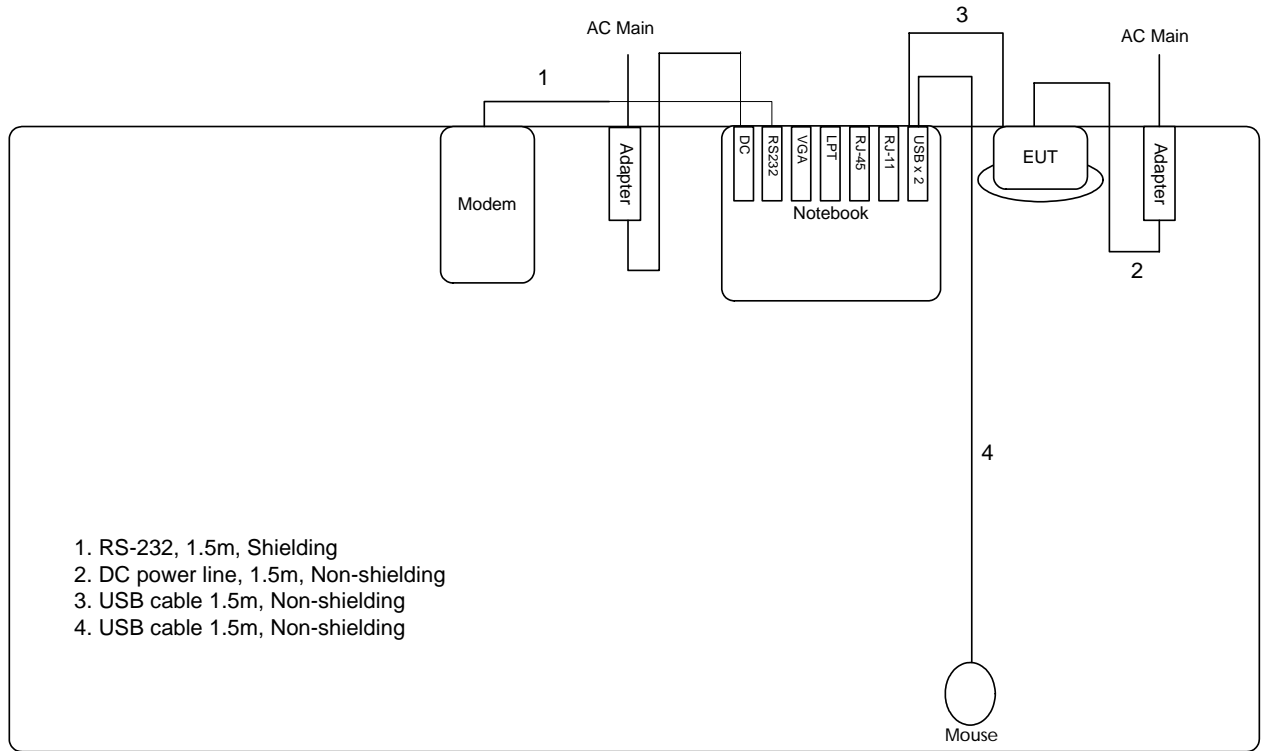

4. TEST RESULT

4.1. AC Power Line Conducted Emissions Measurement

4.1.1. Limit

For this product which is designed to be connected to the AC power line, the radio frequency voltage that is conducted back onto the AC power line on any frequency or frequencies within the band 150 kHz to 30 MHz shall not exceed below limits table.

Frequency (MHz)	QP Limit (dBuV)	AV Limit (dBuV)
0.15~0.5	66~56	56~46
0.5~5	56	46
5~30	60	50

4.1.2. Measuring Instruments and Setting

Please refer to section 5 of equipments list in this report. The following table is the setting of the receiver.

Receiver Parameters	Setting
Attenuation	10 dB
Start Frequency	0.15 MHz
Stop Frequency	30 MHz
IF Bandwidth	9 KHz

4.1.3. Test Procedures

1. Configure the EUT according to ANSI C63.4. The EUT or host of EUT has to be placed 0.4 meter far from the conducting wall of the shielding room and at least 80 centimeters from any other grounded conducting surface.
2. Connect EUT or host of EUT to the power mains through a line impedance stabilization network (LISN).
3. All the support units are connected to the other LISNs. The LISN should provide 50uH/50ohms coupling impedance.
4. The frequency range from 150 KHz to 30 MHz was searched.
5. Set the test-receiver system to Peak Detect Function and Specified Bandwidth with Maximum Hold Mode.
6. The measurement has to be done between each power line and ground at the power terminal.

4.1.4. Test Setup Layout

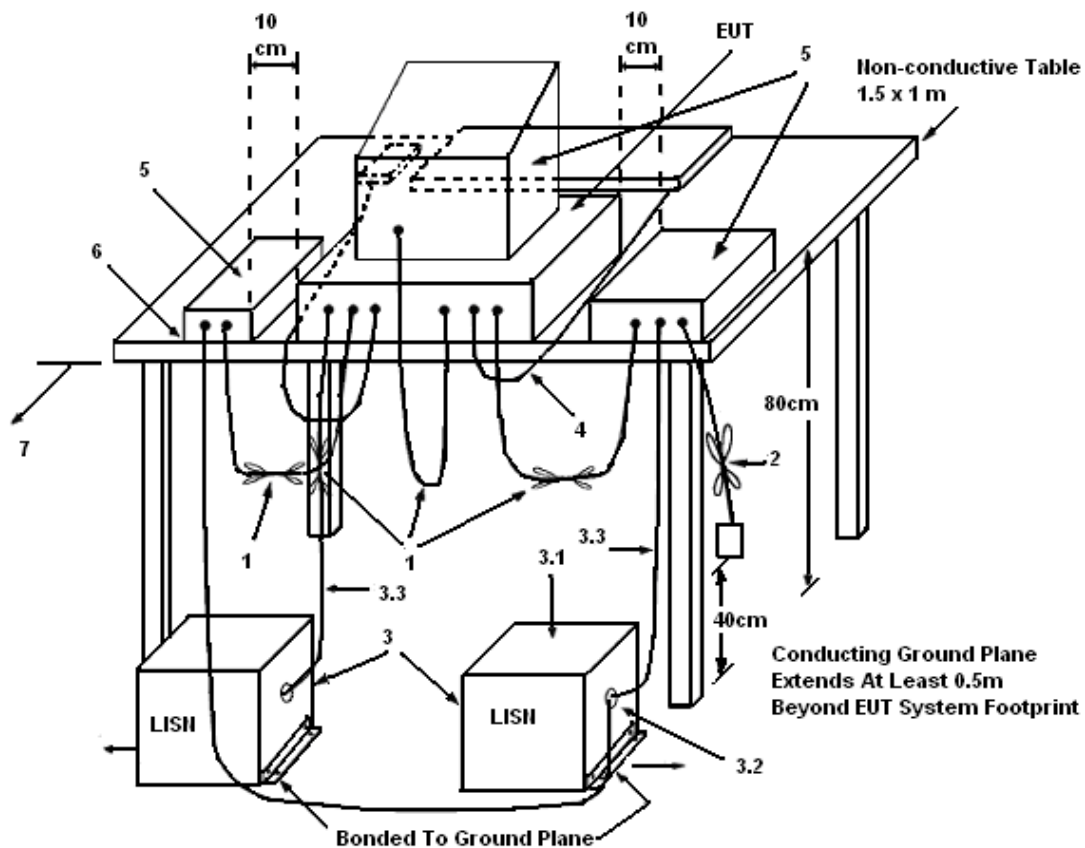

LEGEND:

- (1) Interconnecting cables that hang closer than 40 cm to the ground plane shall be folded back and forth in the center forming a bundle 30 to 40 cm long.
- (2) I/O cables that are not connected to a peripheral shall be bundled in the center. The end of the cable may be terminated, if required, using the correct terminating impedance. The overall length shall not exceed 1 m.
- (3) EUT connected to one LISN. Unused LISN measuring port connectors shall be terminated in 50 Ω. LISN can be placed on top of, or immediately beneath, reference ground plane.
 - (3.1) All other equipment powered from additional LISN(s).
 - (3.2) Multiple outlet strip can be used for multiple power cords of non-EUT equipment.
 - (3.3) LISN at least 80 cm from nearest part of EUT chassis.
- (4) Cables of hand-operated devices, such as keyboards, mice, etc., shall be placed as for normal use.
- (5) Non-EUT components of EUT system being tested.
- (6) Rear of EUT, including peripherals, shall all be aligned and flush with rear of tabletop.
- (7) Rear of tabletop shall be 40 cm removed from a vertical conducting plane that is bonded to the ground plane.

4.1.5. Test Deviation

There is no deviation with the original standard.

4.1.6. EUT Operation during Test

The EUT was placed on the test table and programmed in normal function.

4.1.7. Results of AC Power Line Conducted Emissions Measurement

Temperature	20	Humidity	70%
Test Engineer	Carl Lee	Phase	Line
Configuration	Charging+USB Link+WLAN Link+Audio+Video Mode		

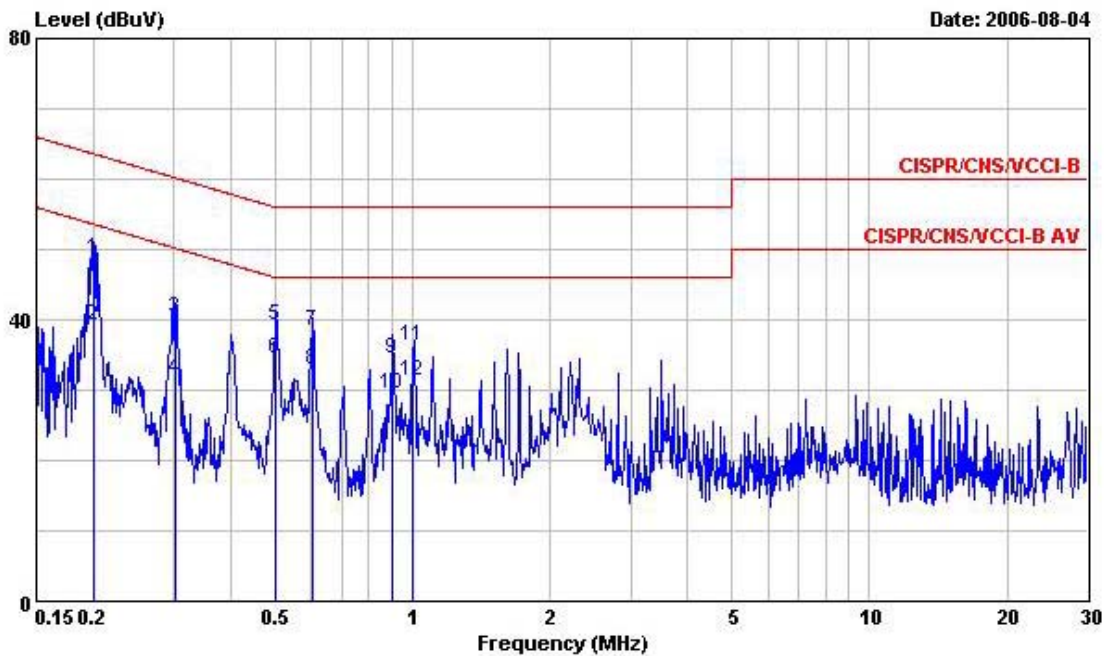

	Freq	Level	Over Limit	Limit Line	Read Level	LISN Factor	Cable Loss	Remark
	MHz	dBuV	dB	dBuV	dBuV	dB	dB	
1	0.1996860	48.61	-15.01	63.62	48.61	0.00	0.00	QP
2	0.1996860	39.10	-14.52	53.62	39.10	0.00	0.00	Average
3	0.3012930	40.27	-19.94	60.21	40.27	0.00	0.00	QP
4	0.3012930	31.63	-18.58	50.21	31.63	0.00	0.00	Average
5	0.5020260	39.13	-16.87	56.00	39.13	0.00	0.00	QP
6	0.5020260	34.50	-11.50	46.00	34.50	0.00	0.00	Average
7	0.6011200	38.30	-17.70	56.00	38.30	0.00	0.00	QP
8	0.6011200	32.90	-13.10	46.00	32.90	0.00	0.00	Average
9	0.9039420	34.55	-21.45	56.00	34.55	0.00	0.00	QP
10	0.9039420	29.53	-16.47	46.00	29.53	0.00	0.00	Average
11	1.004	36.21	-19.79	56.00	36.21	0.00	0.00	QP
12	1.004	31.23	-14.77	46.00	31.23	0.00	0.00	Average

Temperature	20	Humidity	70%
Test Engineer	Carl Lee	Phase	Neutral
Configuration	Charging + USB Link + WLAN Link + Audio + Video Mode		

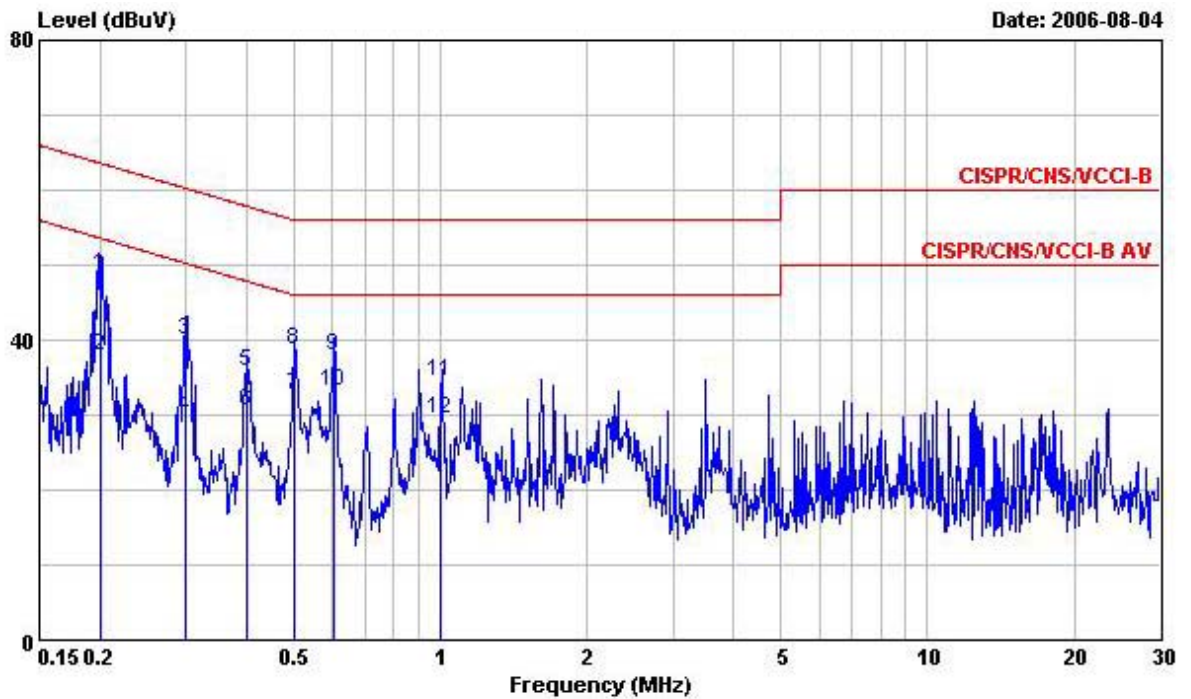

	Freq	Level	Over Limit	Limit Line	Read Level	LISN Factor	Cable Loss	Remark
	MHz	dBuV	dB	dBuV	dBuV	dB	dB	
1	0.2004360	48.63	-14.96	63.59	48.63	0.00	0.00	QP
2	0.2004360	37.82	-15.77	53.59	37.82	0.00	0.00	Average
3	0.3002800	39.93	-20.31	60.24	39.93	0.00	0.00	QP
4	0.3002800	29.76	-20.48	50.24	29.76	0.00	0.00	Average
5	0.4018680	35.70	-22.11	57.81	35.70	0.00	0.00	QP
6	0.4018680	30.50	-17.31	47.81	30.50	0.00	0.00	Average
7	0.5020260	32.64	-13.36	46.00	32.64	0.00	0.00	Average
8	0.5020260	38.67	-17.33	56.00	38.67	0.00	0.00	QP
9	0.6044380	37.80	-18.20	56.00	37.80	0.00	0.00	QP
10	0.6044380	33.15	-12.85	46.00	33.15	0.00	0.00	Average
11	1.004	34.50	-21.50	56.00	34.50	0.00	0.00	QP
12	1.004	29.54	-16.46	46.00	29.54	0.00	0.00	Average

Note:

Level = Read Level + LISN Factor + Cable Loss.

4.2. Maximum Peak Output Power Measurement

4.2.1. Limit

For systems using digital modulation in the 2400-2483.5MHz, the limit for peak output power is 30dBm. The limited has to be reduced by the amount in dB that the gain of the antenna exceeds 6dBi. In case of point-to-point operation, the limit has to be reduced by 1dB for every 3dB that the directional gain of the antenna exceeds 6dBi.

4.2.2. Measuring Instruments and Setting

Please refer to section 5 of equipments list in this report. The following table is the setting of the power meter.

Power Meter Parameter	Setting
Filter No.	Auto
Measurement time	0.135 s ~ 26 s
Used Peak Sensor	NRV-Z32 (model 04)

4.2.3. Test Procedures

1. The transmitter output (antenna port) was connected to the power meter.
2. Turn on the EUT and power meter and then record the peak power value.
3. Repeat above procedures on all channels needed to be tested.

4.2.4. Test Setup Layout

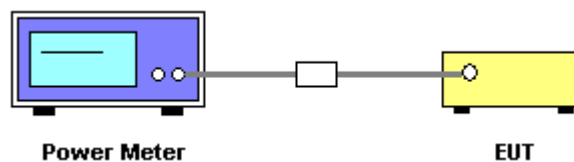

4.2.5. Test Deviation

There is no deviation with the original standard.

4.2.6. EUT Operation during Test

The EUT was programmed to be in continuously transmitting mode.

4.2.7. Test Result of Maximum Peak Output Power

Temperature	27	Humidity	52%
Test Engineer	Sam Lee	Configurations	802.11a

Channel	Frequency	Conducted Power (dBm)	Max. Limit (dBm)	Result
149	5745 MHz	16.88	30.00	Complies
157	5785 MHz	17.71	30.00	Complies
165	5825 MHz	17.68	30.00	Complies

4.3. Power Spectral Density Measurement

4.3.1. Limit

For digitally modulated systems, the power spectral density conducted from the intentional radiator to the antenna shall not be greater than 8 dBm in any 3 kHz band during any time interval of continuous transmission.

4.3.2. Measuring Instruments and Setting

Please refer to section 5 of equipments list in this report. The following table is the setting of Spectrum Analyzer.

Spectrum Parameter	Setting
Attenuation	Auto
Span Frequency	1.5MHz
RB	3 kHz
VB	30 kHz
Detector	Peak
Trace	Max Hold
Sweep Time	500s

4.3.3. Test Procedures

1. The transmitter output (antenna port) was connected to the spectrum analyzer.
2. Set RBW of spectrum analyzer to 3 kHz and VBW to 30 kHz. Set Detector to Peak, Trace to Max Hold.
3. Mark the frequency with maximum peak power as the center of the display of the spectrum.
4. Set the span to 1.5MHz and the sweep time to 500s and record the maximum peak value.

4.3.4. Test Setup Layout

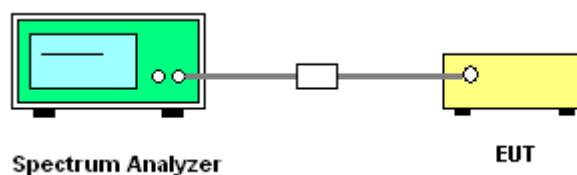

4.3.5. Test Deviation

There is no deviation with the original standard.

4.3.6. EUT Operation during Test

The EUT was programmed to be in continuously transmitting mode.

4.3.7. Test Result of Power Spectral Density

Temperature	27	Humidity	52%
Test Engineer	Sam Lee	Configurations	802.11a

Channel	Frequency	Power Density (dBm)	Max. Limit (dBm)	Result
149	5745 MHz	-13.60	8.00	Complies
157	5785 MHz	-12.53	8.00	Complies
165	5825 MHz	-12.58	8.00	Complies

Power Density Plot on Configuration IEEE 802.11a / 5745 MHz

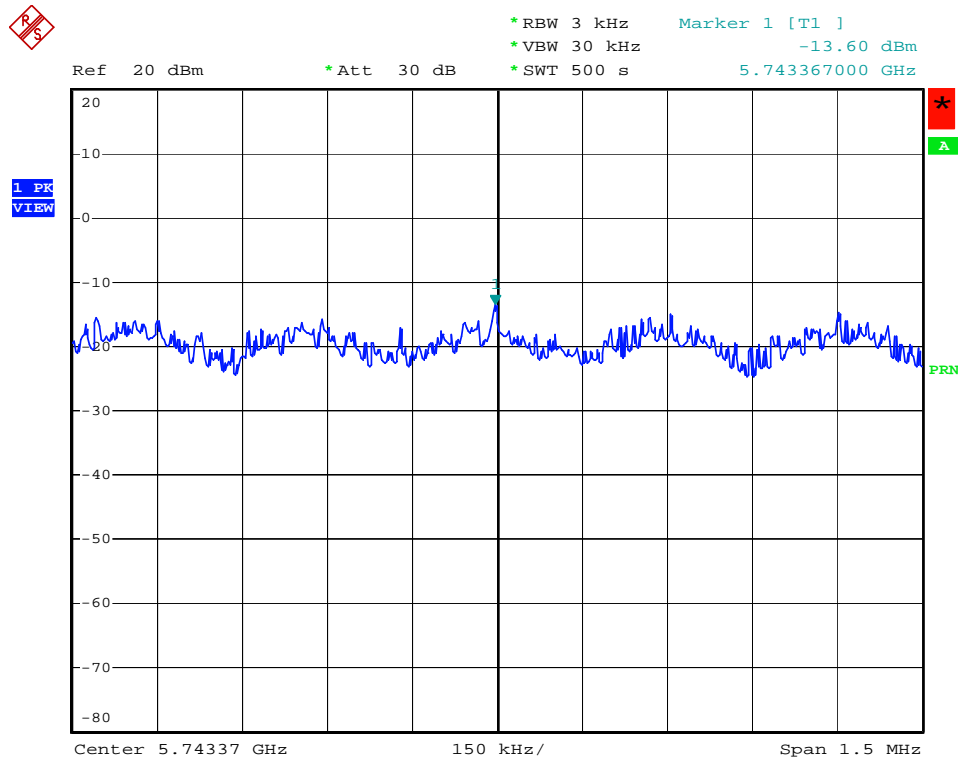

Date: 19.SEP.2006 16:08:06

Power Density Plot on Configuration IEEE 802.11a / 5785 MHz

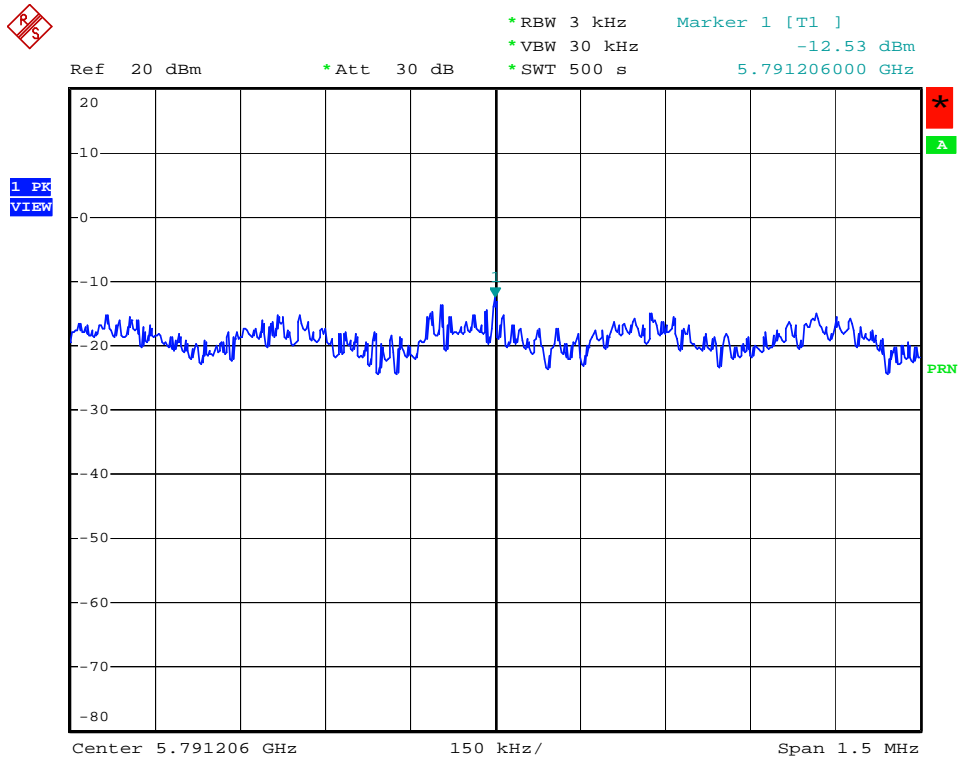

Date: 19.SEP.2006 16:01:44

Power Density Plot on Configuration IEEE 802.11a / 5825 MHz

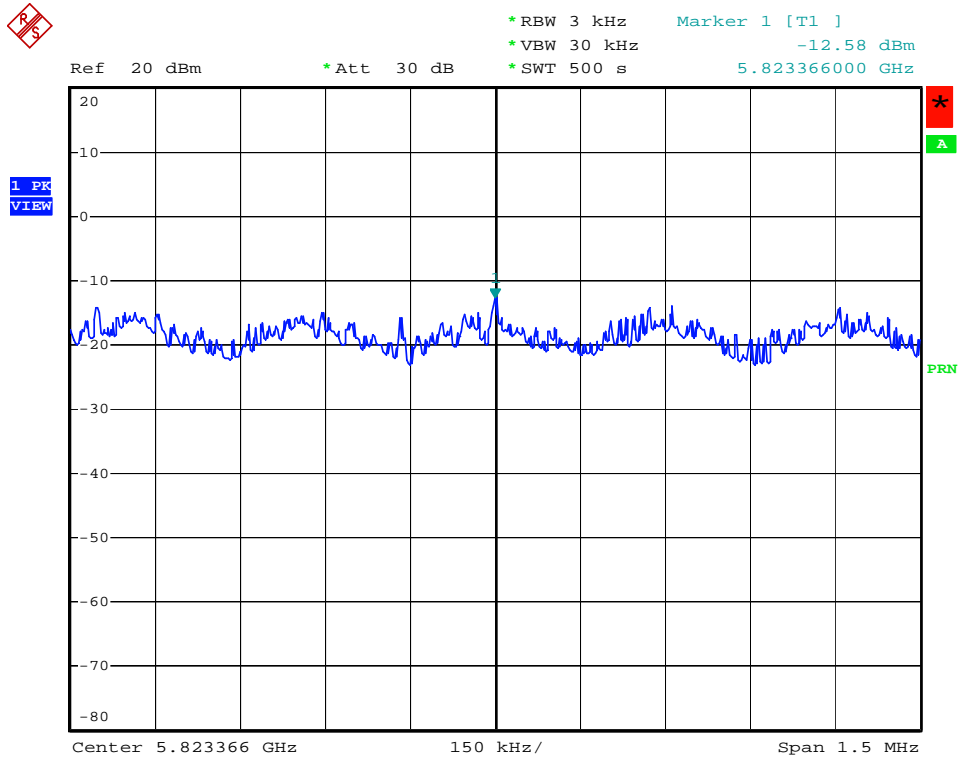

Date: 19.SEP.2006 16:00:15

4.4. 6dB Spectrum Bandwidth Measurement

4.4.1. Limit

For digital modulation systems, the minimum 6dB bandwidth shall be at least 500 kHz.

4.4.2. Measuring Instruments and Setting

Please refer to section 5 of equipments list in this report. The following table is the setting of the Spectrum Analyzer.

Spectrum Parameters	Setting
Attenuation	Auto
Span Frequency	> 6dB Bandwidth
RB	100 kHz
VB	100 kHz
Detector	Peak
Trace	Max Hold
Sweep Time	Auto

4.4.3. Test Procedures

1. The transmitter output (antenna port) was connected to the spectrum analyzer in peak hold mode.
2. The resolution bandwidth of 100 kHz and the video bandwidth of 100 kHz were used.
3. Measured the spectrum width with power higher than 6dB below carrier.

4.4.4. Test Setup Layout

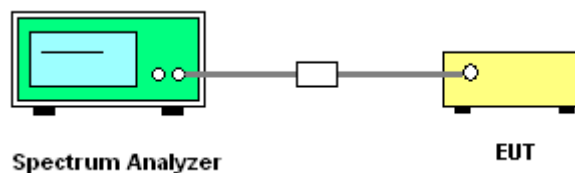

4.4.5. Test Deviation

There is no deviation with the original standard.

4.4.6. EUT Operation during Test

The EUT was programmed to be in continuously transmitting mode.

4.4.7. Test Result of 6dB Spectrum Bandwidth

Temperature	27	Humidity	52%
Test Engineer	Sam Lee	Configurations	802.11a

Channel	Frequency	6dB Bandwidth (MHz)	99% Occupied BW (MHz)	Min. Limit (kHz)	Test Result
149	5745 MHz	15.40	16.36	500	Complies
157	5785 MHz	15.20	16.36	500	Complies
165	5825 MHz	15.36	16.36	500	Complies

6 dB Bandwidth Plot on Configuration IEEE 802.11a / 5745 MHz

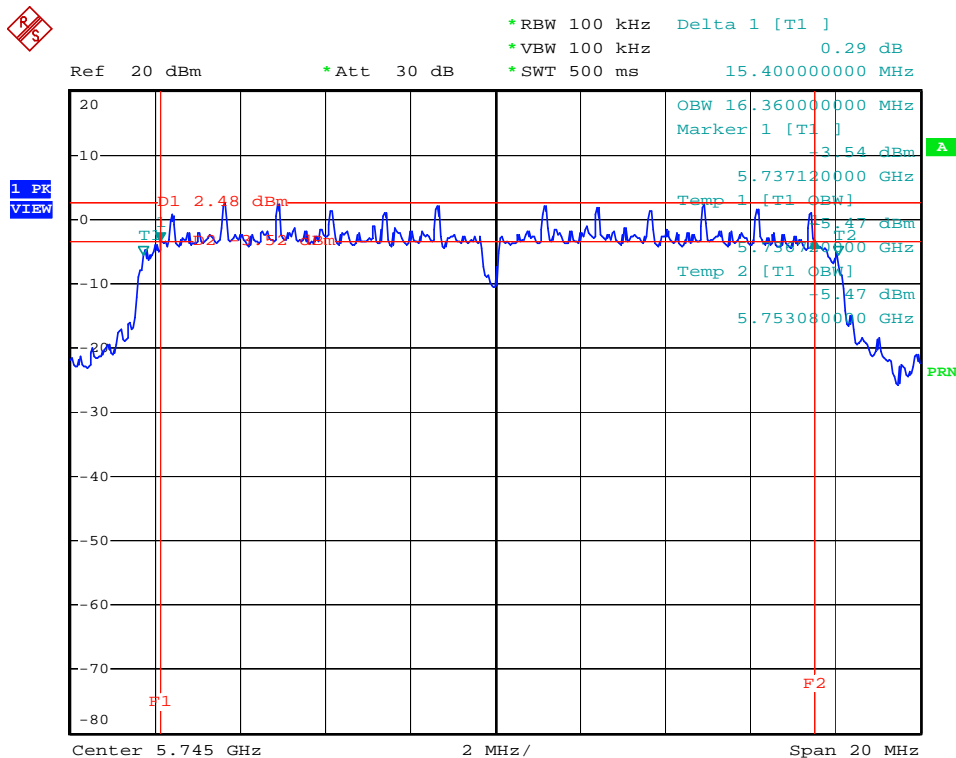

Date: 19.SEP.2006 16:05:19



6 dB Bandwidth Plot on Configuration IEEE 802.11a / 5785 MHz

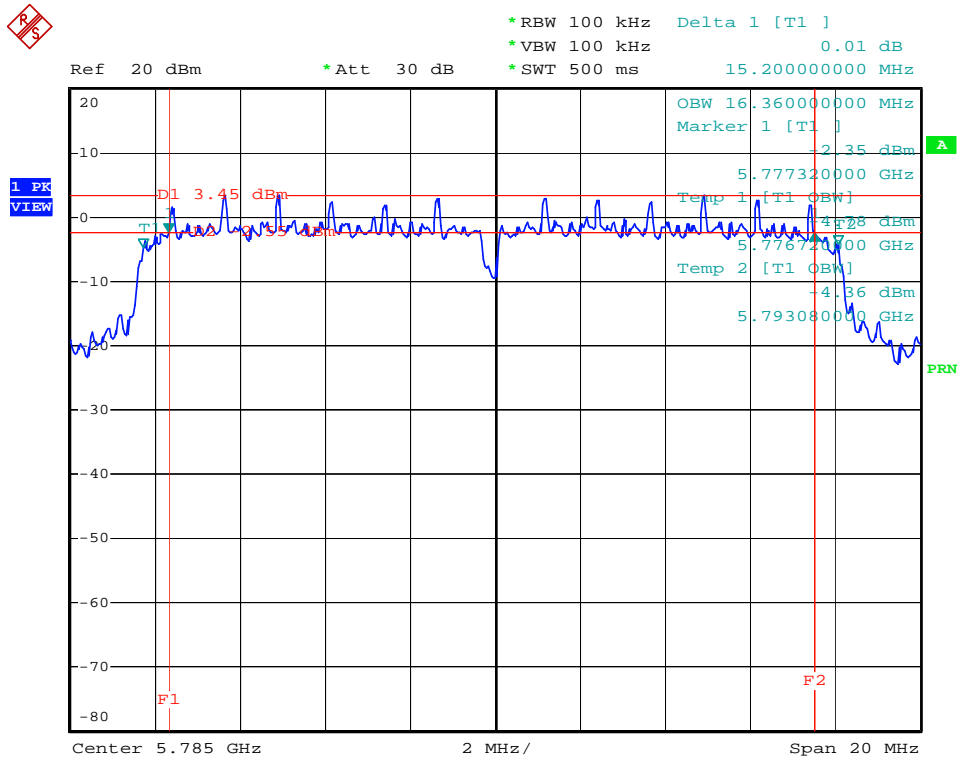

Date: 19.SEP.2006 16:03:24

6 dB Bandwidth Plot on Configuration IEEE 802.11a / 5825 MHz

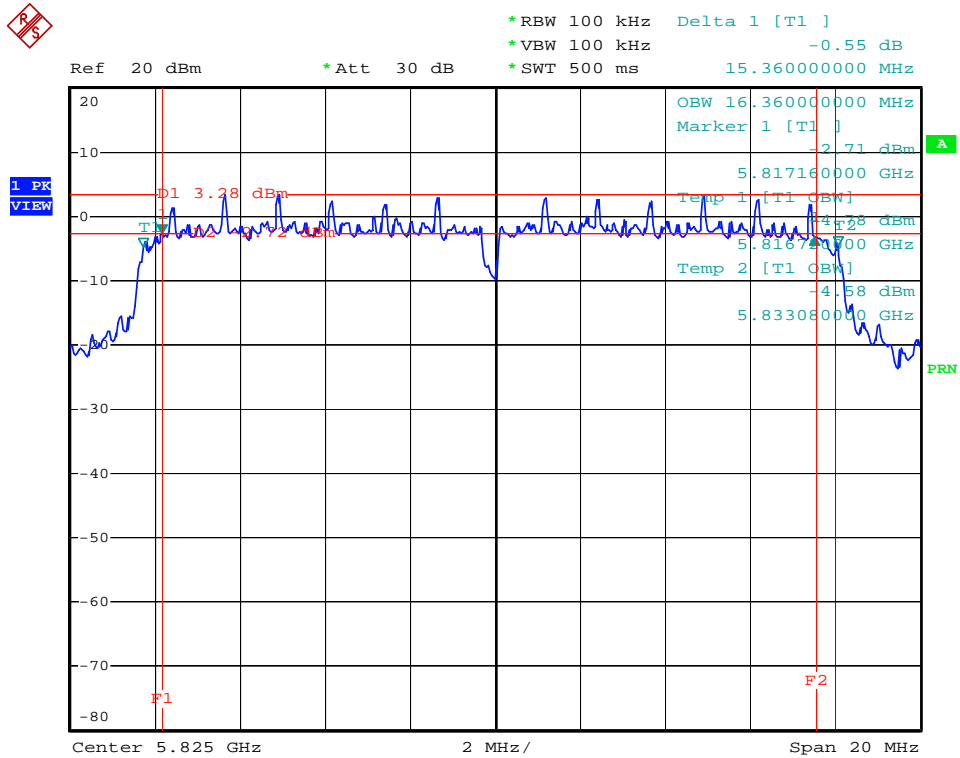

Date: 19.SEP.2006 15:57:37

4.5. Radiated Emissions Measurement

4.5.1. Limit

20dBc in any 100 kHz bandwidth outside the operating frequency band. In case the emission fall within the restricted band specified on 15.205(a), then the 15.209(a) limit in the table below has to be followed.

Frequencies (MHz)	Field Strength (microvolt/meter)	Measurement Distance (meters)
0.009~0.490	2400/F(KHz)	300
0.490~1.705	24000/F(KHz)	30
1.705~30.0	30	30
30~88	100	3
88~216	150	3
216~960	200	3
Above 960	500	3

4.5.2. Measuring Instruments and Setting

Please refer to section 5 of equipments list in this report. The following table is the setting of spectrum analyzer and receiver.

Spectrum Parameter	Setting
Attenuation	Auto
Start Frequency	1000 MHz
Stop Frequency	10th carrier harmonic
RB / VB (Emission in restricted band)	1MHz / 1MHz for Peak, 1 MHz / 10Hz for Average
RB / VB (Emission in non-restricted band)	100KHz / 100KHz for peak

Receiver Parameter	Setting
Attenuation	Auto
Start ~ Stop Frequency	9kHz~150kHz / RB 200Hz for QP
Start ~ Stop Frequency	150kHz~30MHz / RB 9kHz for QP
Start ~ Stop Frequency	30MHz~1000MHz / RB 120kHz for QP

4.5.3. Test Procedures

1. Configure the EUT according to ANSI C63.4. The EUT was placed on the top of the turntable 0.8 meter above ground. The phase center of the receiving antenna mounted on the top of a height-variable antenna tower was placed 3 meters far away from the turntable.
2. Power on the EUT and all the supporting units. The turntable was rotated by 360 degrees to determine the position of the highest radiation.
3. The height of the broadband receiving antenna was varied between one meter and four meters above ground to find the maximum emissions field strength of both horizontal and vertical polarization.
4. For each suspected emissions, the antenna tower was scan (from 1 M to 4 M) and then the turntable was rotated (from 0 degree to 360 degrees) to find the maximum reading.
5. Set the test-receiver system to Peak or CISPR quasi-peak Detect Function with specified bandwidth under Maximum Hold Mode.
6. For emissions above 1GHz, use 1MHz VBW and RBW for peak reading. Then 1MHz RBW and 10Hz VBW for average reading in spectrum analyzer.
7. When the radiated emissions limits are expressed in terms of the average value of the emissions, and pulsed operation is employed, the measurement field strength shall be determined by averaging over one complete pulse train, including blanking intervals, as long as the pulse train does not exceed 0.1 seconds. As an alternative (provided the transmitter operates for longer than 0.1 seconds) or in cases where the pulse train exceeds 0.1 seconds, the measured field strength shall be determined from the average absolute voltage during a 0.1 second interval during which the field strength is at its maximum value.
8. If the emissions level of the EUT in peak mode was 3 dB lower than the average limit specified, then testing will be stopped and peak values of EUT will be reported, otherwise, the emissions which do not have 3 dB margin will be repeated one by one using the quasi-peak method for below 1GHz.
9. For testing above 1GHz, the emissions level of the EUT in peak mode was lower than average limit (that means the emissions level in peak mode also complies with the limit in average mode), then testing will be stopped and peak values of EUT will be reported, otherwise, the emissions will be measured in average mode again and reported.
10. In case the emission is lower than 30MHz, loop antenna has to be used for measurement and the recorded data should be QP measured by receiver. High – Low scan is not required in this case.

4.5.4. Test Setup Layout

For radiated emissions below 30MHz

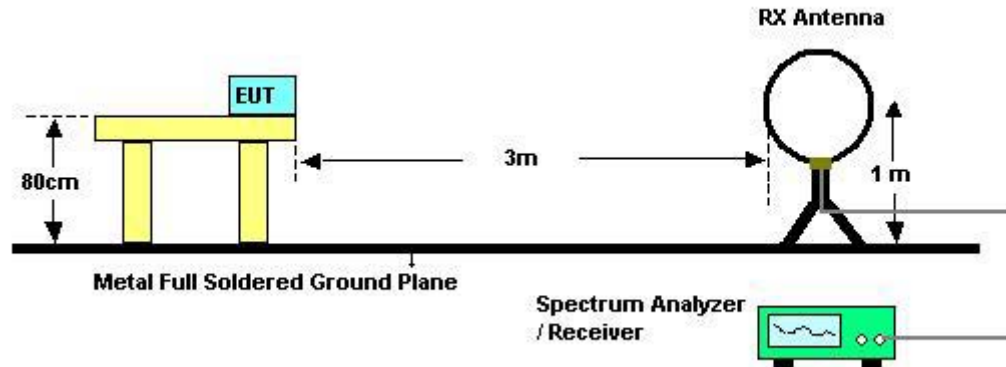

For radiated emissions above 30MHz

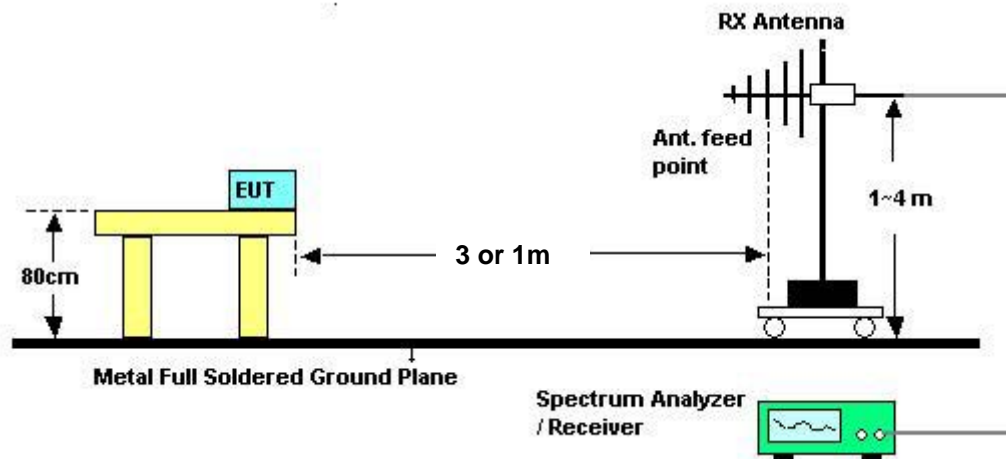

Above 10 GHz shall be extrapolated to the specified distance using an extrapolation factor of 20 dB/decade from 3m to 1m.

Distance extrapolation factor = $20 \log(\text{specific distance [3m]} / \text{test distance [1m]})$ (dB);

Limit line = specific limits (dBuV) + distance extrapolation factor [9.54 dB].

4.5.5. Test Deviation

There is no deviation with the original standard.

4.5.6. EUT Operation during Test

The EUT was programmed to be in continuously transmitting mode.

4.5.7. Results of Radiated Emissions (9 kHz~30MHz)

Temperature	29	Humidity	62%
Test Engineer	Vic Hsiao		

Freq. (MHz)	Level (dBuV)	Over Limit (dB)	Limit Line (dBuV)	Remark
-	-	-	-	See Note

Note:

The amplitude of spurious emissions which are attenuated by more than 20dB below the permissible value has no need to be reported.

Distance extrapolation factor = $40 \log(\text{specific distance} / \text{test distance})$ (dB);

Limit line = specific limits (dBuV) + distance extrapolation factor.

4.5.8. Results of Radiated Emissions (30MHz~ 1GHz)

Temperature	29	Humidity	62%
Test Engineer	Vic Hsiao	Configurations	Scanner RS-309 with long cable

Horizontal

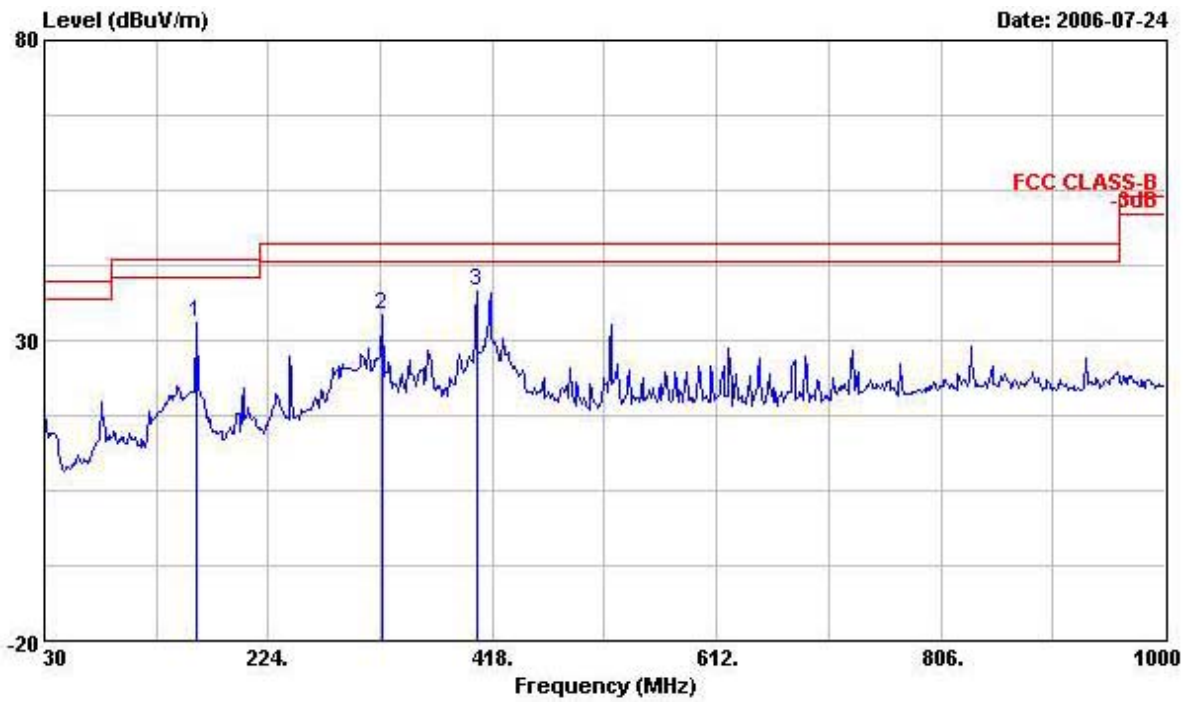

	Freq	Level	Over Limit	Limit Line	ReadAntenna Level	Antenna Factor	Cable Loss	Preamp Factor	Remark
	MHz	dBuV/m	dB	dBuV/m	dBuV	dB/m	dB	dB	
1	160.950	32.86	-10.64	43.50	49.19	9.98	1.76	28.08	Peak
2	322.940	34.30	-11.70	46.00	45.49	14.39	3.11	28.69	Peak
3 @	404.420	38.06	-7.94	46.00	46.83	16.94	3.40	29.11	Peak

Vertical

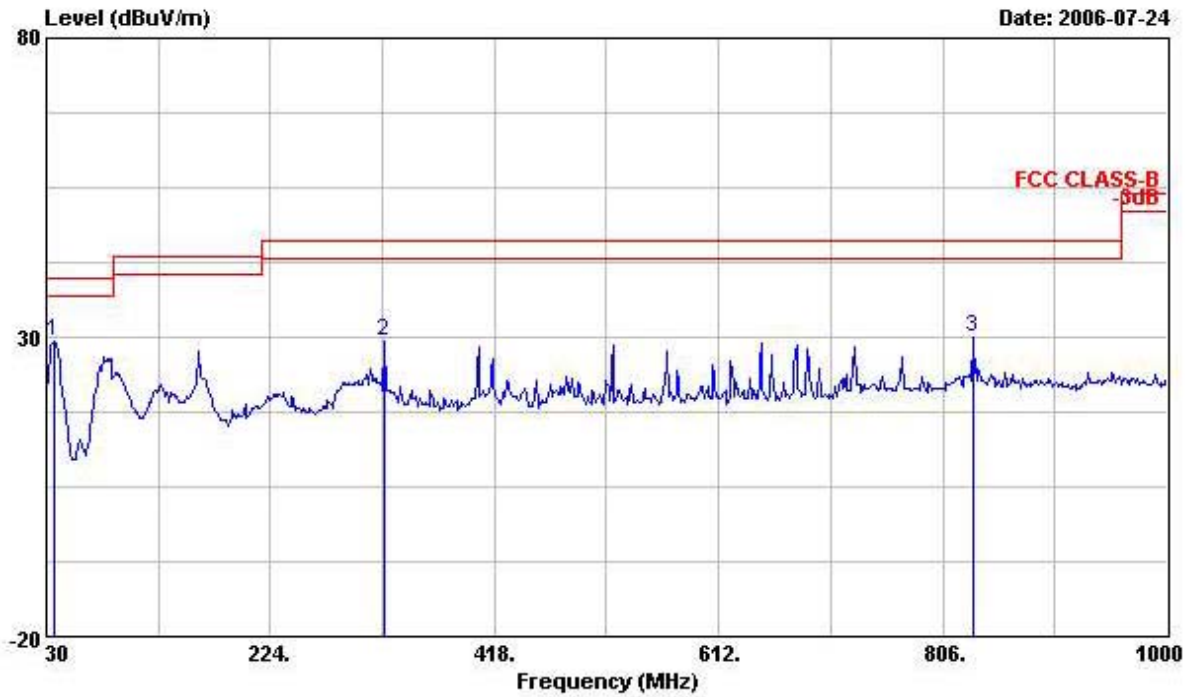

Si
Co
EU
Mo
Me

	Freq	Level	Over Limit	Limit Line	ReadAntenna Level	Antenna Factor	Cable Loss	Preamplifier	Remark
	MHz	dBuV/m	dB	dBuV/m	dBuV	dB/m	dB	dB	
1	36.790	29.50	-10.50	40.00	42.50	14.29	0.53	27.81	Peak
2	322.940	29.24	-16.76	46.00	40.43	14.39	3.11	28.69	Peak
3	832.190	30.02	-15.98	46.00	33.25	21.11	5.36	29.70	Peak

Temperature	29	Humidity	62%
Test Engineer	Vic Hsiao	Configurations	Scanner RS-309 with short cable

Horizontal

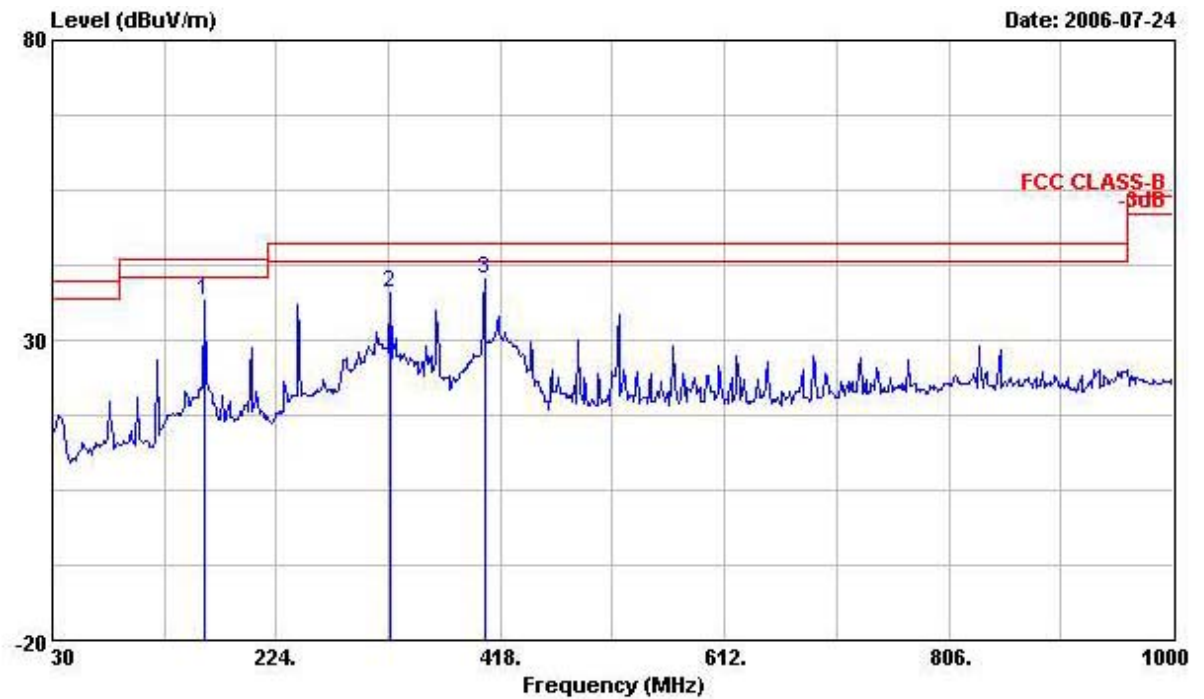

	Freq	Level	Over Limit	Limit Line	ReadAntenna Level	Antenna Factor	Cable Loss	Preamp Factor	Remark
	MHz	dBuV/m	dB	dBuV/m	dBuV	dB/m	dB	dB	
1 @	160.950	36.69	-6.81	43.50	53.02	9.98	1.76	28.08	Peak
2 @	322.940	37.95	-8.05	46.00	49.14	14.39	3.11	28.69	Peak
3 @	404.420	40.34	-5.66	46.00	49.11	16.94	3.40	29.11	Peak

Vertical

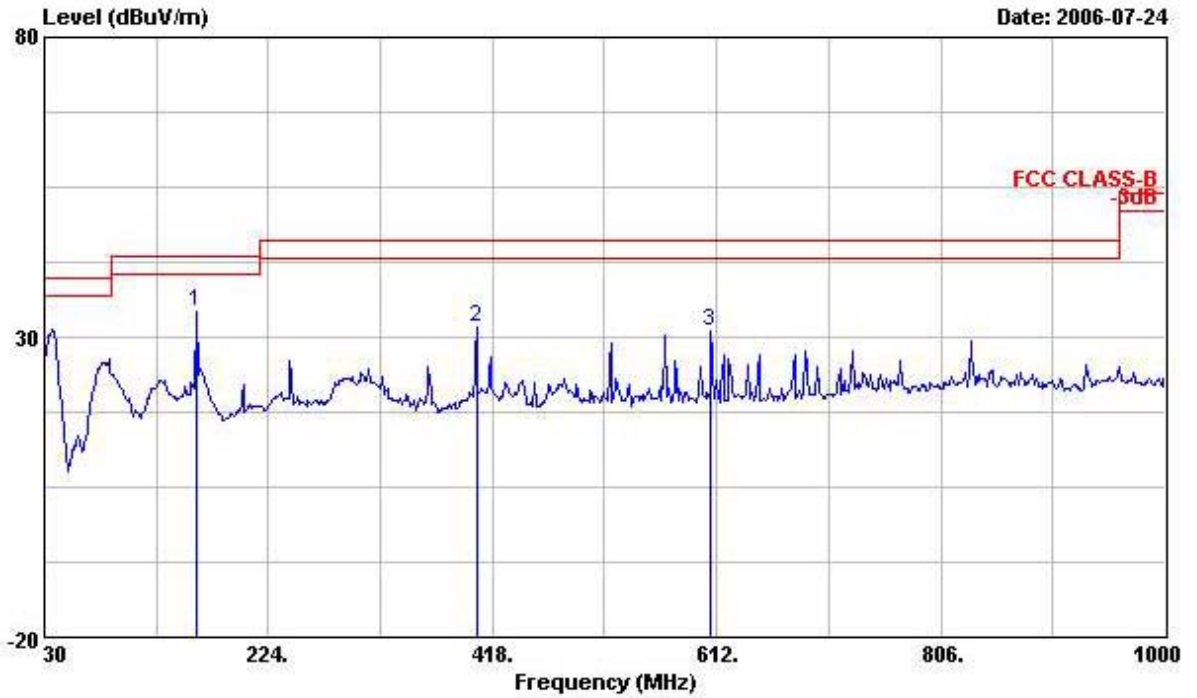

	Freq	Level	Over	Limit	ReadAntenna	Cable	Preamp	Remark
	MHz	dBuV/m	Limit	Line	Level	Loss	Factor	
			dB	dBuV/m	dBuV	dB	dB	
1	160.950	34.39	-9.11	43.50	50.72	9.98	1.76	28.08 Peak
2	404.420	31.65	-14.35	46.00	40.42	16.94	3.40	29.11 Peak
3	607.150	31.14	-14.86	46.00	36.96	19.54	4.38	29.73 Peak

Temperature	29	Humidity	62%
Test Engineer	Vic Hsiao	Configurations	Scanner RS-409 with long cable

Horizontal

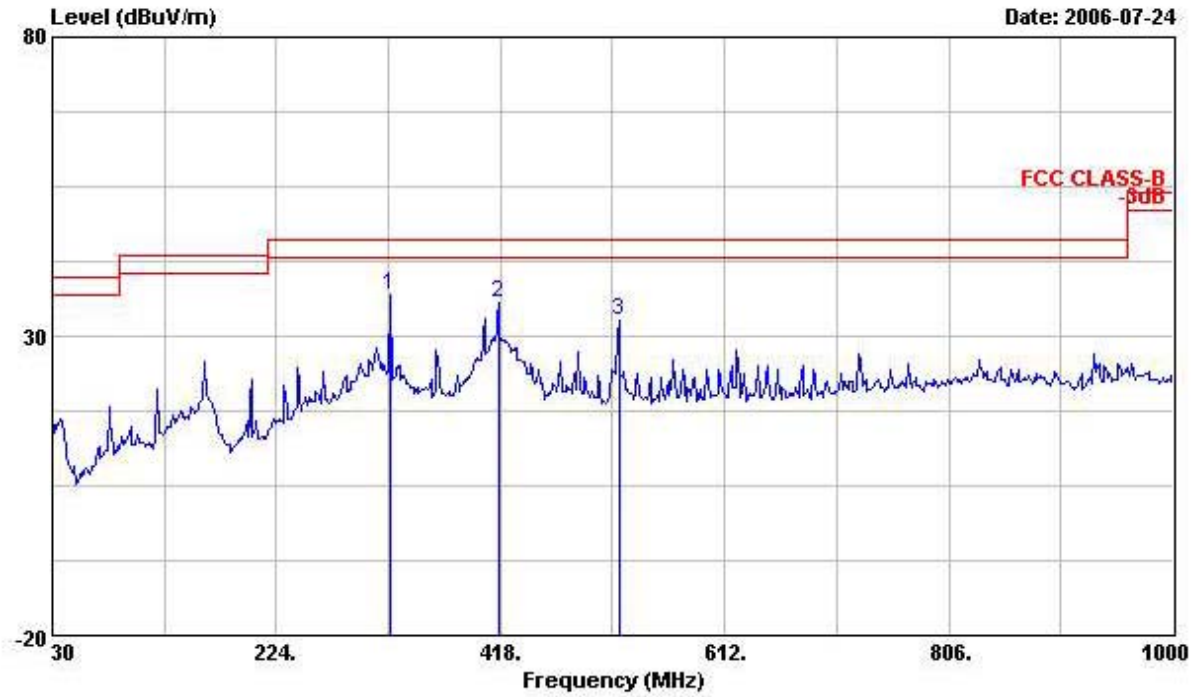

	Freq	Level	Over Limit	Limit Line	ReadAntenna Level	Antenna Factor	Cable Loss	Preamp Factor	Remark
	MHz	dBuV/m	dB	dBuV/m	dBuV	dB/m	dB	dB	
1	322.940	36.88	-9.12	46.00	48.07	14.39	3.11	28.69	Peak
2	416.060	35.53	-10.47	46.00	43.66	17.37	3.48	28.98	Peak
3	520.820	32.73	-13.27	46.00	40.22	18.28	3.92	29.69	Peak

Vertical

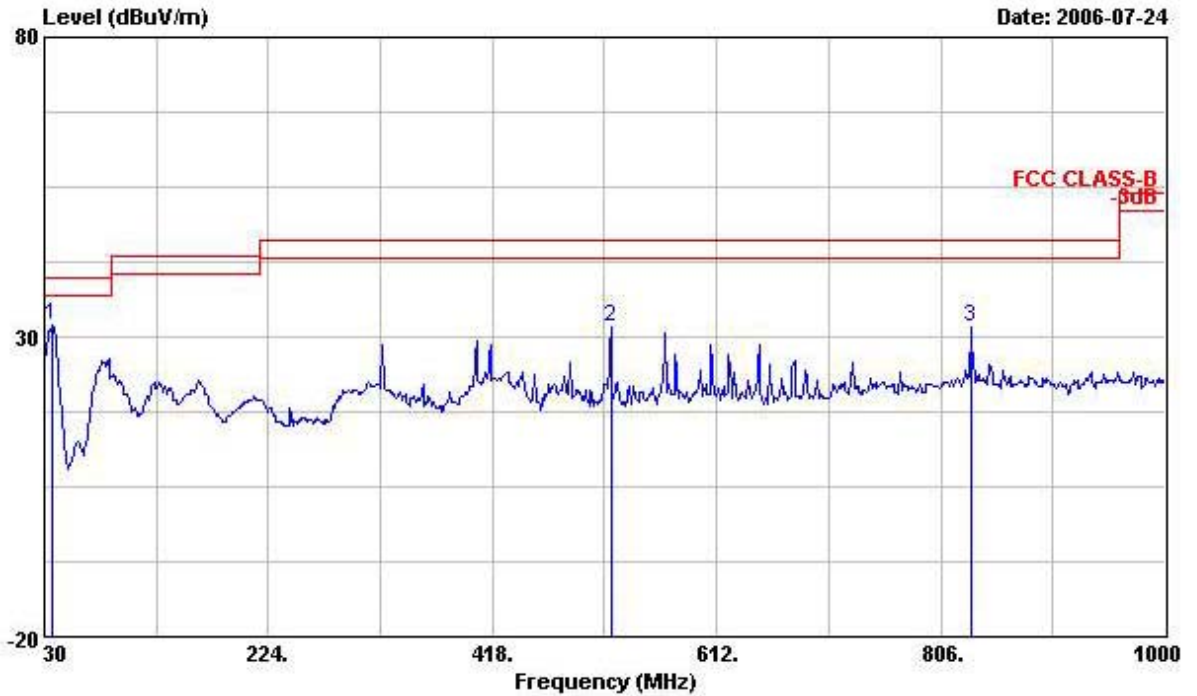

	Freq	Level	Over Limit	Limit Line	Read&Antenna Level	Antenna Factor	Cable Loss	Preamp Factor	Remark
	MHz	dBuV/m	dB	dBuV/m	dBuV	dB/m	dB	dB	
1 @	36.790	31.85	-8.15	40.00	44.85	14.29	0.53	27.81	Peak
2	520.820	31.75	-14.25	46.00	39.24	18.28	3.92	29.69	Peak
3	832.190	31.63	-14.37	46.00	34.86	21.11	5.36	29.70	Peak

Temperature	29	Humidity	62%
Test Engineer	Vic Hsiao	Configurations	Scanner RS-409 with short cable

Horizontal

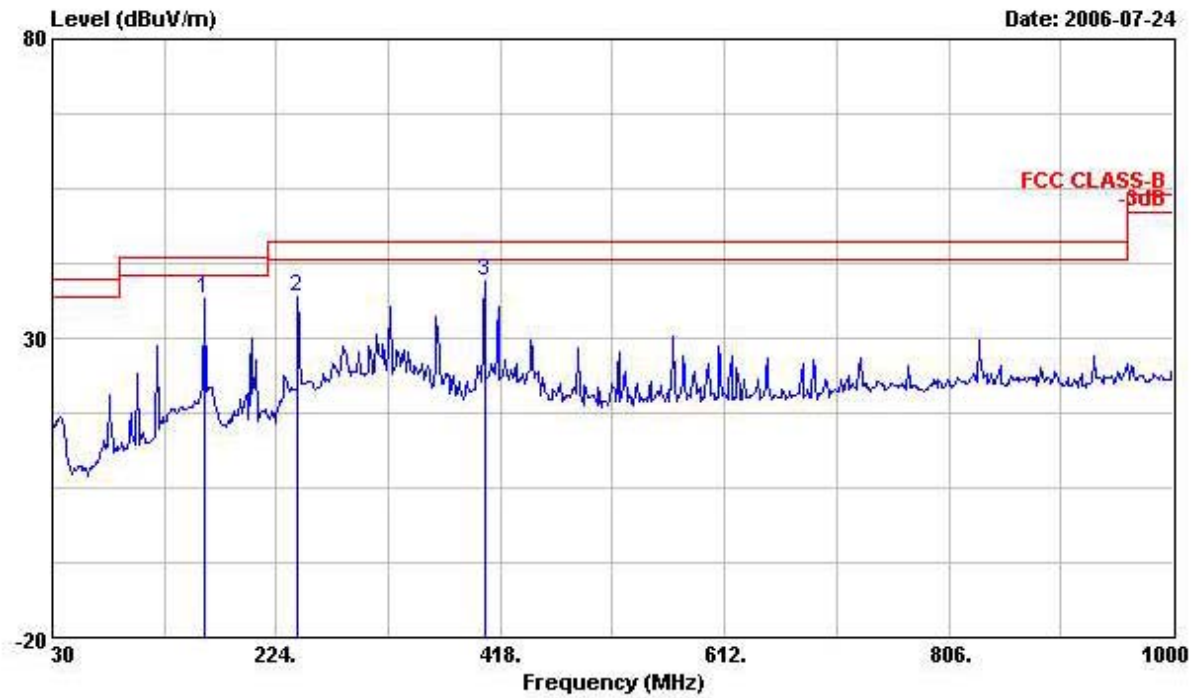

	Freq	Level	Over Limit	Limit Line	ReadAntenna Level	Antenna Factor	Cable Loss	Preamp Factor	Remark
	MHz	dBUV/m	dB	dBUV/m	dBuV	dB/m	dB	dB	
1 @	160.950	36.49	-7.01	43.50	52.82	9.98	1.76	28.08	Peak
2	242.430	36.85	-9.15	46.00	50.51	12.07	2.64	28.36	Peak
3 @	404.420	39.59	-6.41	46.00	48.36	16.94	3.40	29.11	Peak

Vertical

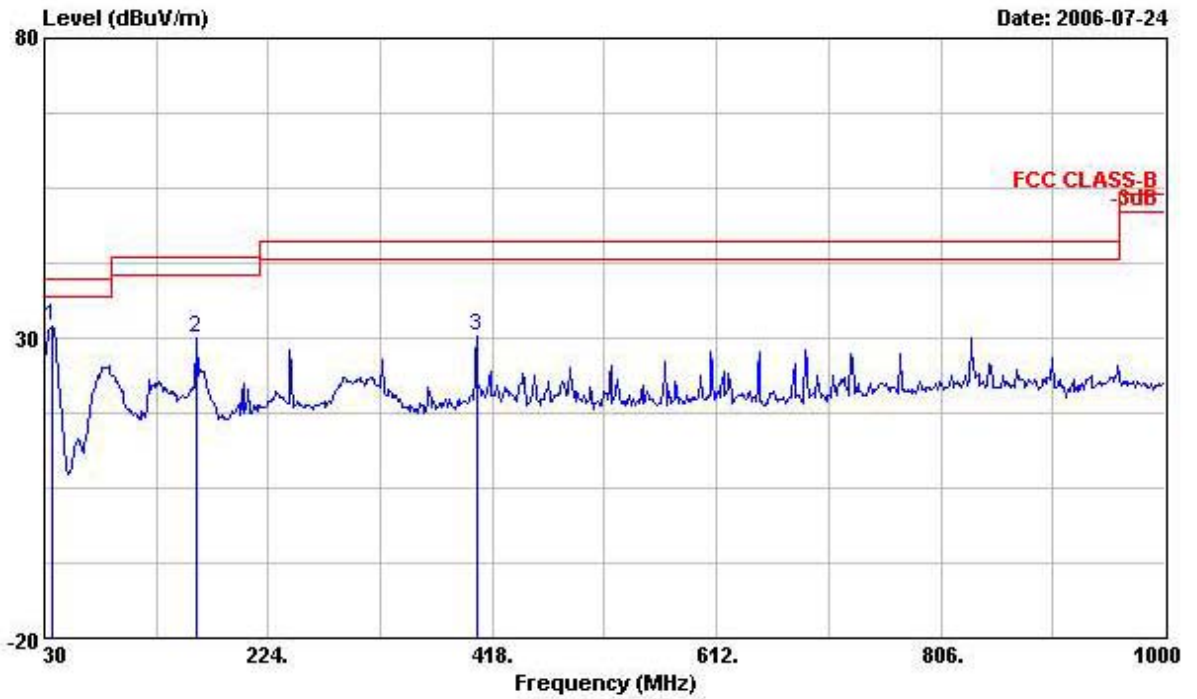

	Freq	Level	Over Limit	Limit Line	Read&Antenna Level	Antenna Factor	Cable Loss	Preamp Factor	Remark
	MHz	dBUV/m	dB	dBUV/m	dBuV	dB/m	dB	dB	
1 @	36.790	32.02	-7.98	40.00	45.02	14.29	0.53	27.81	Peak
2	160.950	30.10	-13.40	43.50	46.43	9.98	1.76	28.08	Peak
3	404.420	30.46	-15.54	46.00	39.23	16.94	3.40	29.11	Peak

Temperature	29	Humidity	62%
Test Engineer	Vic Hsiao	Configurations	Charging Mode

Horizontal

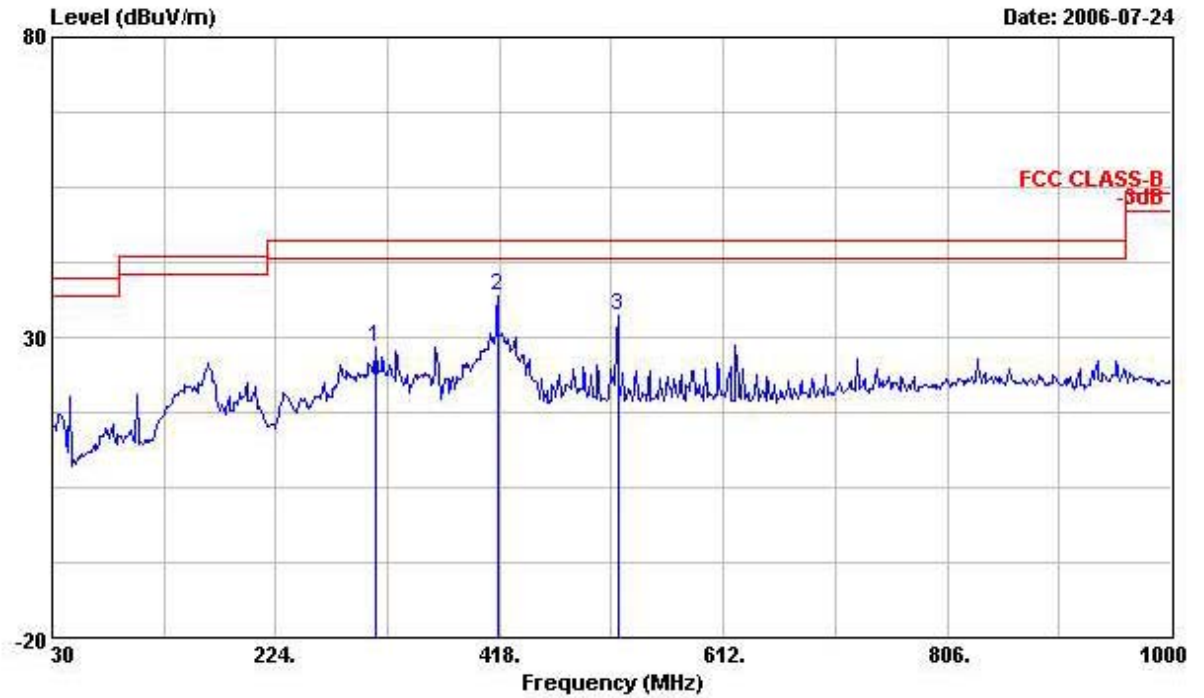

	Freq	Level	Over Limit	Limit Line	ReadAntenna Level	Antenna Factor	Cable Loss	Preamp Factor	Remark
	MHz	dBuV/m	dB	dBuV/m	dBuV	dB/m	dB	dB	
1	311.300	28.26	-17.74	46.00	39.95	13.97	2.98	28.64	Peak
2	416.060	36.90	-9.10	46.00	45.03	17.37	3.48	28.98	Peak
3	520.820	33.60	-12.40	46.00	41.09	18.28	3.92	29.69	Peak

Vertical

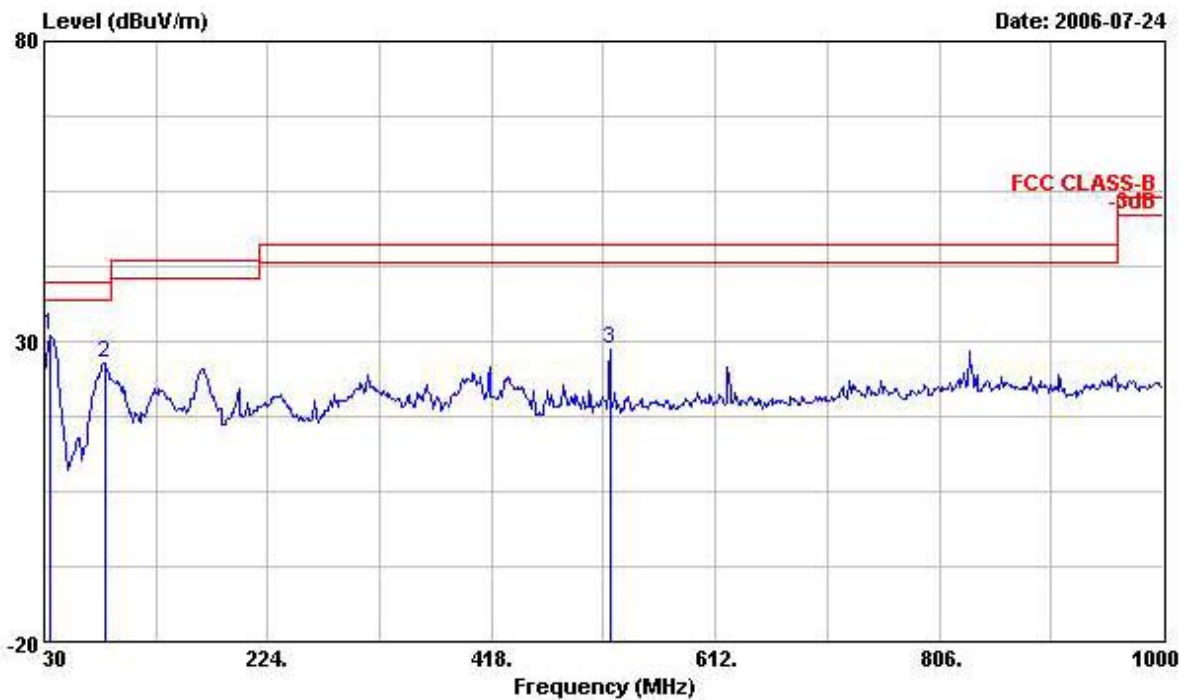

	Freq	Level	Over Limit	Limit Line	Read&Antenna Level	Cable Loss	Preamp Factor	Remark
	MHz	dBUV/m	dB	dBUV/m	dBuV	dB/m	dB	
1 @	35.820	30.99	-9.01	40.00	43.41	14.88	0.50	27.80 Peak
2	82.380	26.38	-13.62	40.00	45.29	7.55	1.33	27.80 Peak
3	520.820	28.56	-17.44	46.00	36.05	18.28	3.92	29.69 Peak

Note:

The amplitude of spurious emissions which are attenuated by more than 20dB below the permissible value has no need to be reported.

Emission level (dBUV/m) = 20 log Emission level (uV/m).

Corrected Reading: Antenna Factor + Cable Loss + Read Level - Preamp Factor = Level.

4.5.9. Results for Radiated Emissions (1GHz~10th Harmonic)

Temperature	29	Humidity	62%
Test Engineer	Vic Hsiao	Configurations	802.11a CH 149

Horizontal

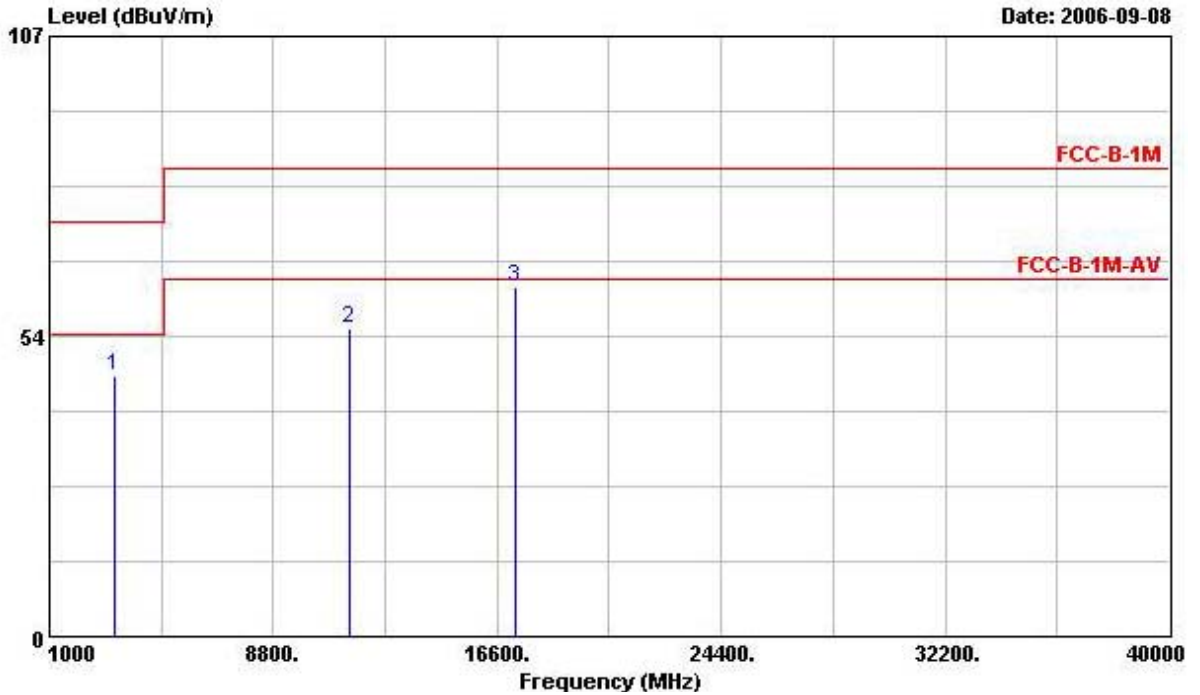

	Freq	Level	Over Limit	Limit Line	Read Antenna Level	Antenna Factor	Cable Loss	Preamp Factor	Remark
	MHz	dBuV/m	dB	dBuV/m	dBuV	dB/m	dB	dB	
1	3258.000	46.51	-27.49	74.00	45.64	31.12	2.46	32.70	PEAK
2	11484.000	54.86	-28.68	83.54	42.53	39.28	4.78	31.73	PEAK
3	17235.000	62.42	-21.12	83.54	44.96	43.05	6.21	31.80	PEAK

Vertical

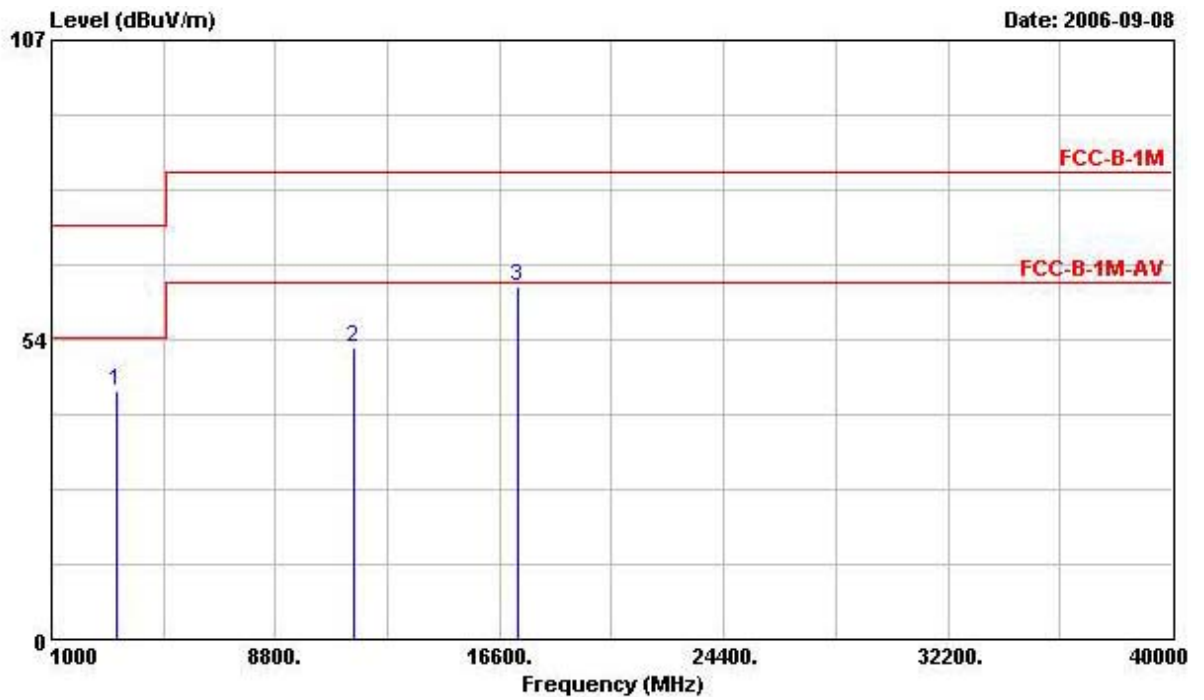

	Freq	Level	Over Limit	Limit Line	ReadAntenna Level	Antenna Factor	Cable Loss	Preamp Factor	Remark
	MHz	dBuV/m	dB	dBuV/m	dBuV	dB/m	dB	dB	
1	3258.000	44.50	-29.50	74.00	43.62	31.12	2.46	32.70	PEAK
2	11490.000	52.05	-31.49	83.54	39.72	39.28	4.78	31.73	PEAK
3	17235.000	63.09	-20.45	83.54	45.63	43.05	6.21	31.80	PEAK

Temperature	29	Humidity	62%
Test Engineer	Vic Hsiao	Configurations	802.11a CH 157

Horizontal

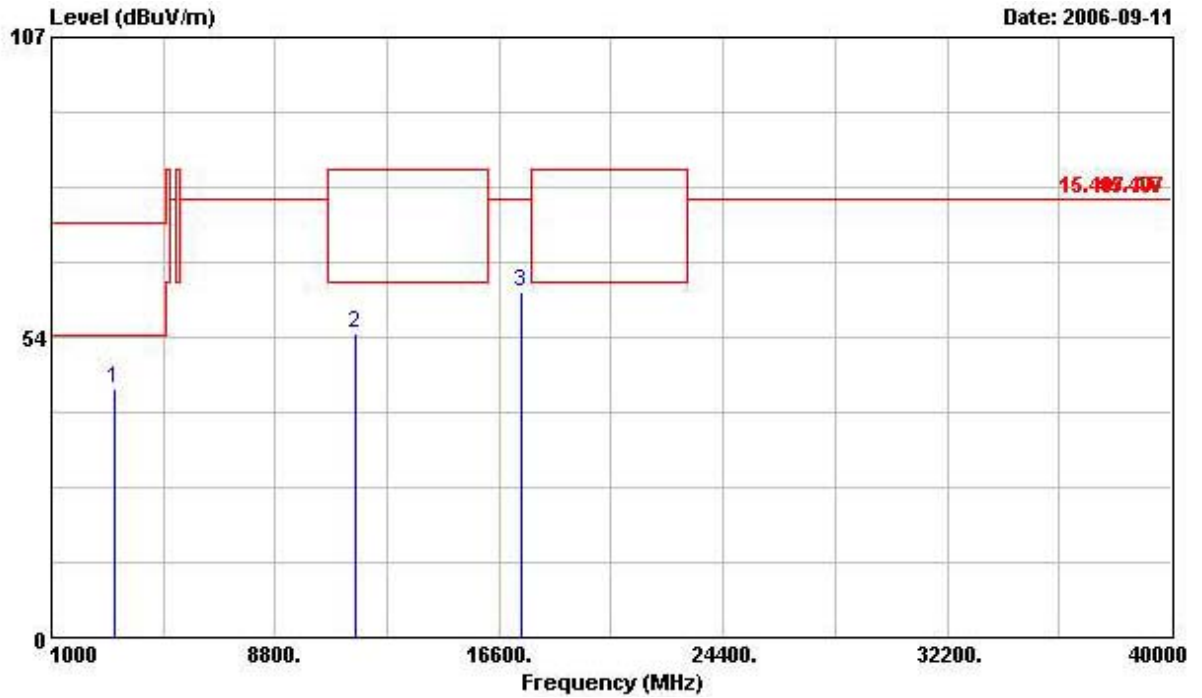

	Freq	Level	Over	Limit	Read	Antenna	Cable	Preamp	Remark
	MHz	dBuV/m	Limit	Line	Level	Factor	Loss	Factor	
			dB	dBuV/m	dBuV	dB/m	dB	dB	
1	3231.000	44.44	-29.56	74.00	44.18	30.54	2.43	32.71	PEAK
2	11570.000	54.29	-29.21	83.50	42.32	38.94	4.82	31.80	PEAK
3	17355.000	61.52	-16.78	78.30	44.56	42.46	6.24	31.74	PEAK

Vertical

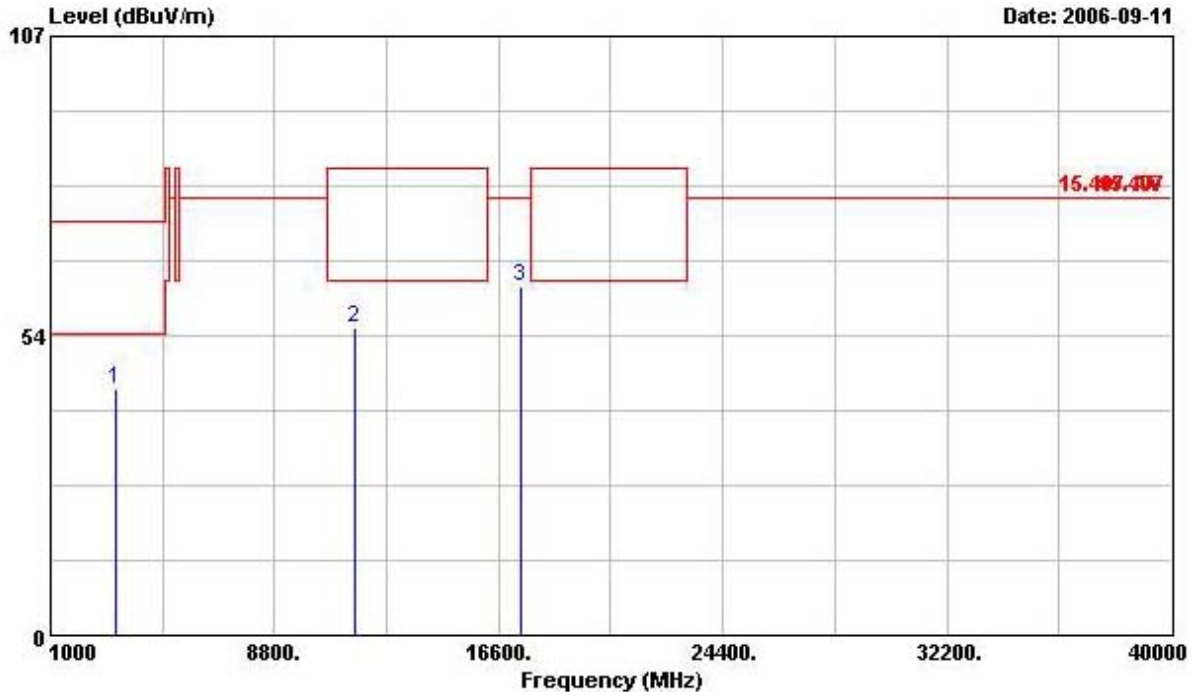

	Freq	Level	Over	Limit	ReadAntenna	Cable	Preamp	
	MHz	dBuV/m	Limit	Line	Level	Loss	Factor	Remark
			dB	dBuV/m	dBuV	dB	dB	
1	3273.000	44.12	-29.88	74.00	43.71	30.66	2.45	32.70 PEAK
2	11570.000	54.80	-28.70	83.50	42.84	38.94	4.82	31.80 PEAK
3	17355.000	62.34	-15.96	78.30	45.38	42.46	6.24	31.74 PEAK

Temperature	29	Humidity	62%
Test Engineer	Vic Hsiao	Configurations	802.11a CH 165

Horizontal

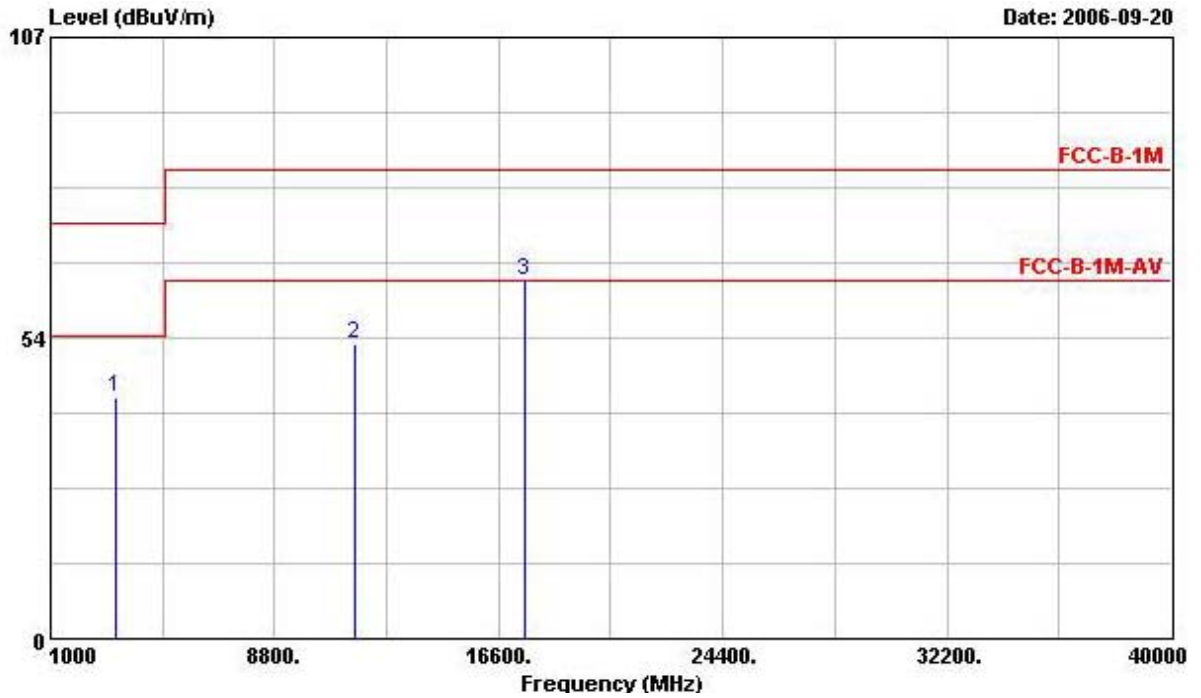

	Freq	Level	Over Limit	Limit Line	ReadAntenna Level	Antenna Factor	Cable Loss	Preamp Factor	Remark
	MHz	dBuV/m	dB	dBuV/m	dBuV	dB/m	dB	dB	
1	3240.000	43.01	-30.99	74.00	42.18	31.08	2.46	32.71	PEAK
2	11560.000	52.31	-31.23	83.54	40.03	39.26	4.80	31.77	PEAK
3	17475.000	63.79	-19.75	83.54	44.07	45.11	6.29	31.67	PEAK

Vertical

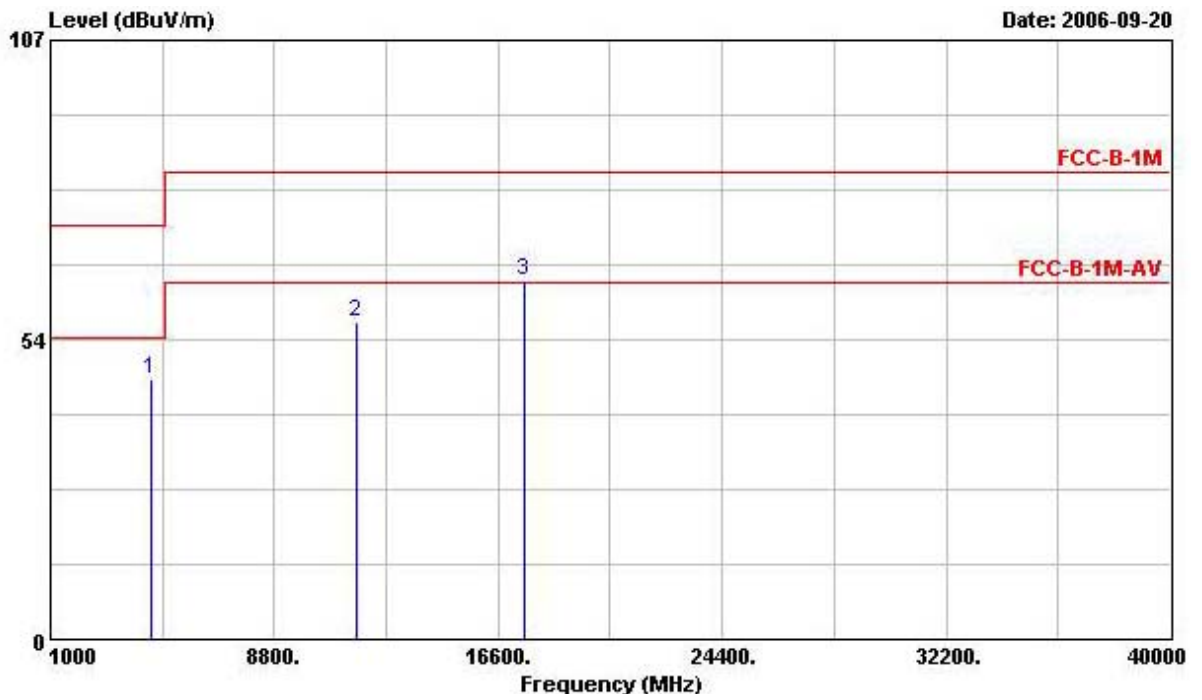

	Freq	Level	Over Limit	Limit Line	ReadAntenna Level	Antenna Factor	Cable Loss	Preamp Factor	Remark
	MHz	dBuV/m	dB	dBuV/m	dBuV	dB/m	dB	dB	
1	4497.000	46.34	-27.66	74.00	43.06	32.70	3.06	32.48	PEAK
2	11646.000	56.66	-26.88	83.54	44.45	39.19	4.87	31.85	PEAK
3	17475.000	63.91	-19.63	83.54	44.19	45.11	6.29	31.67	PEAK

4.6. Band Edge Emissions Measurement

4.6.1. Limit

20dBc in any 100 kHz bandwidth outside the operating frequency band. In case the emission fall within the restricted band specified on 15.205(a), then the 15.209(a) limit in the table below has to be followed.

Frequencies (MHz)	Field Strength (microvolt/meter)	Measurement Distance (meters)
0.009~0.490	2400/F(KHz)	300
0.490~1.705	24000/F(KHz)	30
1.705~30.0	30	30
30~88	100	3
88~216	150	3
216~960	200	3
Above 960	500	3

4.6.2. Measuring Instruments and Setting

Please refer to section 5 of equipments list in this report. The following table is the setting of the spectrum analyzer.

Spectrum Parameter	Setting
Attenuation	Auto
Span Frequency	100 MHz
RB / VB (Emission in restricted band)	1MHz / 1MHz for Peak, 1 MHz / 10Hz for Average
RB / VB (Emission in non-restricted band)	100 KHz /100 KHz for Peak

4.6.3. Test Procedures

- The test procedure is the same as section 4.5.3; only the frequency range investigated is limited to 100MHz around band edges.
- In case the emission is fail due to the used RB/VB is too wide, marker-delta method of FCC Public Notice DA00-705 will be followed.

4.6.4. Test Setup Layout

This test setup layout is the same as that shown in section 4.5.4.

4.6.5. Test Deviation

There is no deviation with the original standard.

4.6.6. EUT Operation during Test

The EUT was programmed to be in continuously transmitting mode.



4.6.7. Test Result of Fundamental Emissions

Temperature	29	Humidity	62%
Test Engineer	Vic Hsiao	Configurations	802.11a CH 149, 165

Channel 149

	Freq	Level	Over Limit	Limit Line	ReadAntenna Level	Antenna Factor	Cable Loss	Preamp Factor	Remark
	MHz	dBuV/m	dB	dBuV/m	dBuV	dB/m	dB	dB	
1 @	5739.600	115.18			76.44	34.80	3.94	0.00	Peak
1 @	5739.600	105.28			66.54	34.80	3.94	0.00	Average

Channel 165

	Freq	Level	Over Limit	Limit Line	ReadAntenna Level	Antenna Factor	Cable Loss	Preamp Factor	Remark
	MHz	dBuV/m	dB	dBuV/m	dBuV	dB/m	dB	dB	
1 @	5827.200	113.35			74.53	34.80	4.02	0.00	Peak
1 @	5827.200	103.67			64.85	34.80	4.02	0.00	Average

For Emission not in Restricted Band, Conducted Measurement
Low Band Edge Plot on Configuration IEEE 802.11a / 5745 MHz

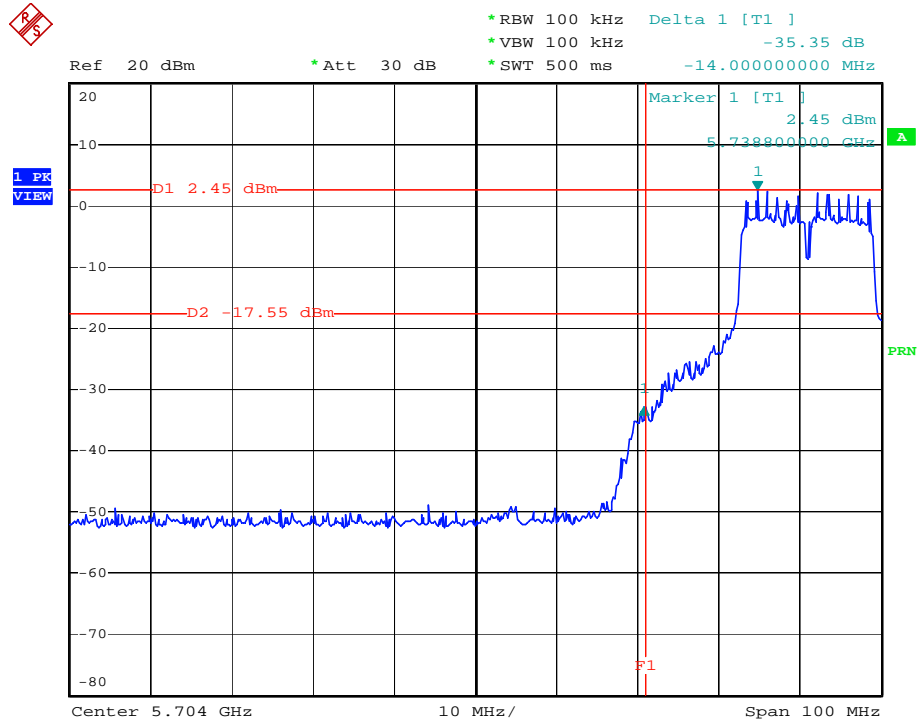

Date: 19.SEP.2006 16:06:55

High Band Edge Plot on Configuration IEEE 802.11a / 5825 MHz

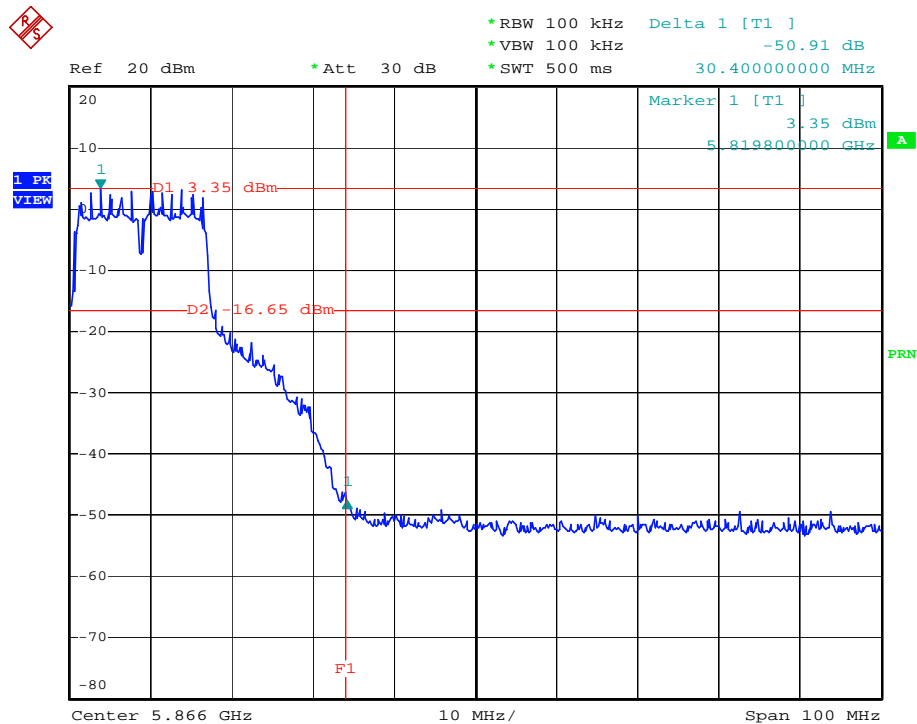

Date: 19.SEP.2006 15:58:44



4.7. Antenna Requirements

4.7.1. Limit

Except for special regulations, the Low-power Radio-frequency Devices must not be equipped with any jacket for installing an antenna with extension cable. An intentional radiator shall be designed to ensure that no antenna other than that furnished by the responsible party shall be used with the device. The use of a permanently attached antenna or of an antenna that uses a unique coupling to the intentional radiator shall be considered sufficient to comply with the provisions of this Section. The manufacturer may design the unit so that the user can replace a broken antenna, but the use of a standard antenna jack or electrical connector is prohibited. Further, this requirement does not apply to intentional radiators that must be professionally installed.

4.7.2. Antenna Connector Construction

Please refer to section 3.3 in this test report; antenna connector complied with the requirements.

5. LIST OF MEASURING EQUIPMENTS

Instrument	Manufacturer	Model No.	Serial No.	Characteristics	Calibration Date	Remark
EMC Receiver	R&S	ESCS 30	100174	9kHz – 2.75GHz	Feb. 22, 2006	Conduction (CO04-HY)
LISN	MessTec	NNB-2/16Z	99079	9kHz – 30MHz	Dec. 19, 2005	Conduction (CO04-HY)
LISN (Support Unit)	EMCO	3810/2NM	9708-1839	9kHz – 30MHz	Mar. 18, 2006	Conduction (CO04-HY)
RF Cable-CON	UTIFLEX	3102-26886-4	CB049	9kHz – 30MHz	Apr. 20, 2006	Conduction (CO04-HY)
EMI Filter	LINDGREN	LRE-2030	2651	< 450 Hz	N/A	Conduction (CO04-HY)
3m Semi Anechoic Chamber	SIDT FRANKONIA	SAC-3M	03CH03-HY	30 MHz - 1 GHz 3m	Jun. 15, 2006	Radiation (03CH03-HY)
Amplifier	SCHAFFNER	CPA9231A	3565	9 kHz - 2 GHz	Jan. 18, 2006	Radiation (03CH03-HY)
Amplifier	Agilent	8449B	3008A02120	1 GHz - 26.5 GHz	May 29, 2006	Radiation (03CH03-HY)
Spectrum Analyzer	R&S	FSP40	100004/040	9 kHz - 40 GHz	Sep. 30, 2005	Radiation (03CH03-HY)
Bilog Antenna	SCHAFFNER	CBL 6112D	22237	30 MHz – 1 GHz	Jul. 24, 2006	Radiation (03CH03-HY)
Horn Antenna	EMCO	3115	6903	1GHz ~ 18GHz	Mar. 15, 2006	Radiation (03CH03-HY)
Horn Antenna	SCHWARZBECK	BBHA9170	BBHA9170154	15 GHz - 40 GHz	NCR	Radiation (03CH03-HY)
RF Cable-R03m	Jye Bao	RG142	CB021	30 MHz - 1 GHz	Dec.02, 2005	Radiation (03CH03-HY)
RF Cable-HIGH	SUHNER	SUCOFLEX 106	03CH03-HY	1 GHz - 40 GHz	Dec.02, 2005	Radiation (03CH03-HY)
Turn Table	HD	DS 420	420/650/00	0 – 360 degree	N/A	Radiation (03CH03-HY)
Antenna Mast	HD	MA 240	240/560/00	1 m - 4 m	N/A	Radiation (03CH03-HY)
Spectrum Analyzer	R&S	FSP30	100023	9kHz ~ 30GHz	Nov. 26, 2005	Conducted (TH01-HY)
Power Meter	R&S	NRVS	100764	DC ~ 40GHz	Jul, 20, 2006	Conducted (TH01-HY)
Power Sensor	R&S	NRV-Z51	100666	DC ~ 40GHz	Jul. 19, 2006	Conducted (TH01-HY)
Power Sensor	R&S	NRV-Z32	100057	30MHz ~ 6GHz	Jun, 10, 2006	Conducted (TH01-HY)
DC Power Source	G.W.	GPC-6030D	C671845	DC 1V ~ 60V	Dec. 28, 2005	Conducted (TH01-HY)
Temp. and Humidity Chamber	KSON	THS-C3L	612	N/A	Oct. 01, 2005	Conducted (TH01-HY)
RF CABLE-1m	Jye Bao	RG142	CB034-1m	20MHz ~ 7GHz	Dec. 30, 2005	Conducted (TH01-HY)
RF CABLE-2m	Jye Bao	RG142	CB035-2m	20MHz ~ 1GHz	Dec. 30, 2005	Conducted (TH01-HY)
Oscilloscope	Tektronix	TDS1012	CO38515	100MHz / 1GS/s	Jun. 20, 2006	Conducted (TH01-HY)
Signal Generator	R&S	SMR40	100116	10MHz ~ 40GHz	Dec. 30, 2005	Conducted (TH01-HY)
Data Generator	Tektronix	DG2030	063-2920-50	0.1Hz~400MHz	Jun. 16, 2006	Conducted (TH01-HY)

Note: Calibration Interval of instruments listed above is one year. NCR: Non-Calibration required.

Instrument	Manufacturer	Model No.	Serial No.	Characteristics	Calibration Date	Remark
Amplifier	MITEQ	AMF-6F-260400	923364	26.5 GHz - 40 GHz	Jan. 24, 2006*	Radiation (03CH03-HY)
Loop Antenna	R&S	HFH2-Z2	860004/001	9 kHz - 30 MHz	May 23, 2006*	Radiation (03CH03-HY)
AC Power Source	HPC	HPA-500W	HPA-9100024	AC 0 ~ 300V	Apr. 21, 2005*	Conducted (TH01-HY)

Note: Calibration Interval of instruments listed above is two year.

6. TEST LOCATION

SHIJR	ADD : 6Fl., No. 106, Sec. 1, Shintai 5th Rd., Shijr City, Taipei, Taiwan 221, R.O.C. TEL : 886-2-2696-2468 FAX : 886-2-2696-2255
HWA YA	ADD : No. 52, Hwa Ya 1st Rd., Kwei-Shan Hsiang, Tao Yuan Hsien, Taiwan, R.O.C. TEL : 886-3-327-3456 FAX : 886-3-318-0055
LINKOU	ADD : No. 30-2, Dingfu Tsuen, Linkou Shiang, Taipei, Taiwan 244, R.O.C TEL : 886-2-2601-1640 FAX : 886-2-2601-1695
DUNGHU	ADD : No. 3, Lane 238, Kangle St., Neihu Chiu, Taipei, Taiwan 114, R.O.C. TEL : 886-2-2631-4739 FAX : 886-2-2631-9740
JUNGHE	ADD : 7Fl., No. 758, Jungjeng Rd., Junghe City, Taipei, Taiwan 235, R.O.C. TEL : 886-2-8227-2020 FAX : 886-2-8227-2626
NEIHU	ADD : 4Fl., No. 339, Hsin Hu 2 nd Rd., Taipei 114, Taiwan, R.O.C. TEL : 886-2-2794-8886 FAX : 886-2-2794-9777
JHUBEI	ADD : No.8, Lane 728, Bo-ai St., Jhubei City, HsinChu County 302, Taiwan, R.O.C. TEL : 886-3-656-9065 FAX : 886-3-656-9085

7. NVLAP CERTIFICATE OF ACCREDITATION

United States Department of Commerce
National Institute of Standards and Technology

NVLAP[®]

Certificate of Accreditation to ISO/IEC 17025:1999

NVLAP LAB CODE: 200079-0

Sporton International, Inc. Hwa Ya EMC Laboratory
Tao Yuan Hsien 333
TAIWAN

*is recognized by the National Voluntary Laboratory Accreditation Program for conformance with criteria set forth in
NIST Handbook 150:2001 and all requirements of ISO/IEC 17025:1999.
Accreditation is granted for specific services, listed on the Scope of Accreditation, for:*

ELECTROMAGNETIC COMPATIBILITY AND TELECOMMUNICATIONS

2006-01-01 through 2006-12-31
Effective dates



[Signature]
For the National Institute of Standards and Technology

NVLAP-01C (REV. 2005-05-19)