



VRC 6940



Product Reference Guide



VRC 6940

Product Reference Guide

72-37641-02

Revision B

June 2001



© 2001 by Symbol Technologies, Inc. All rights reserved.

No part of this publication may be reproduced or used in any form, or by any electrical or mechanical means, without permission in writing from Symbol. This includes electronic or mechanical means, such as photocopying, recording, or information storage and retrieval systems. The material in this manual is subject to change without notice.

The software is provided strictly on an “as is” basis. All software, including firmware, furnished to the user is on a licensed basis. Symbol grants to the user a non-transferable and non-exclusive license to use each software or firmware program delivered hereunder (licensed program). Except as noted below, such license may not be assigned, sublicensed, or otherwise transferred by the user without prior written consent of Symbol. No right to copy a licensed program in whole or in part is granted, except as permitted under copyright law. The user shall not modify, merge, or incorporate any form or portion of a licensed program with other program material, create a derivative work from a licensed program, or use a licensed program in a network without written permission from Symbol. The user agrees to maintain Symbol’s copyright notice on the licensed programs delivered hereunder, and to include the same on any authorized copies it makes, in whole or in part. The user agrees not to decompile, disassemble, decode, or reverse engineer any licensed program delivered to the user or any portion thereof.

Symbol reserves the right to make changes to any software or product to improve reliability, function, or design.

Symbol does not assume any product liability arising out of, or in connection with, the application or use of any product, circuit, or application described herein.

No license is granted, either expressly or by implication, estoppel, or otherwise under any Symbol Technologies, Inc., intellectual property rights. An implied license only exists for equipment, circuits, and subsystems contained in Symbol products.

Symbol, Spectrum One, and Spectrum24 are registered trademarks of Symbol Technologies, Inc. Other product names mentioned in this manual may be trademarks or registered trademarks of their respective companies and are hereby acknowledged.

Symbol Technologies, Inc.
One Symbol Plaza
Holtsville, New York 11742-1300
<http://www.symbol.com>

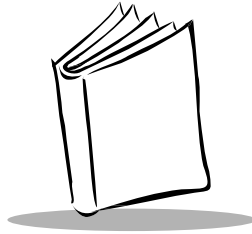

Contents

About This Manual

Notational Conventions	vii
Related Publications	viii
Contact and Service Information	viii

Chapter 1. Getting Started

Purpose of This Manual	1-1
Parts of a VRC 6940 Terminal	1-2
Options and Accessories	1-3
Options	1-3
Accessories	1-3
Radio Cards	1-3
Scanners	1-3
Printers	1-4
Before You Use the Terminal.....	1-4

Chapter 2. Installing Hardware

Equipment Required	2-1
Hardware Installation	2-2
Providing Power: Vehicle Installations	2-5
Providing Power: Wall or Workbench Installations	2-7
Installation and the Internal Battery	2-8

Chapter 3. Configuring Spectrum24

Equipment Required	3-1
Configuring a Spectrum24 Radio Card	3-2

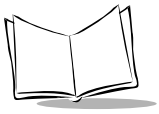

Chapter 4. Installing Software

Equipment Required	4-1
Transferring and Installing Application Programs	4-2
1. Prepare the PC for Communications and File Downloading.	4-2
2. Provide a Reliable Power Source.	4-4
3. Prepare the Terminal for Transferring Files	4-4
4. Start the File Transfer.	4-7
5. Complete the Installation of Transferred Files	4-8

Chapter 5. Operating a VRC 6940

Powering a Terminal On and Off	5-2
Powering On	5-2
Suspending or Turning Off the Terminal	5-2
Powering On or Off Automatically.	5-3
Resetting a Terminal	5-3
Modifier Keys: SHIFT, FUNC and CTRL	5-4
Adjusting Brightness	5-6
Entering Data	5-6
Bar Code Scanning.	5-7
Attaching an External Bar Code Scanner	5-7
Using a Bar Code Scanner.	5-7
Moving a Terminal to a Different Power Source	5-8
Command Mode	5-8

Chapter 6. Troubleshooting

Troubleshooting a VRC 6940 Terminal.	6-1
Error Messages	6-3
Scanning Problems.	6-4
Terminal Stops Responding	6-4
1. Make Sure You are Within Range of an Access Point.	6-4
2. Force the Terminal into Suspend	6-4
3. Restart After Forcing a Suspend	6-5
Booting a VRC 6940	6-5
Warm Boot.	6-5
Cold Boot.	6-6
Command Mode	6-7
If Rebooting Fails.	6-7
Memory Transfer Analyzer (MTA) Utility	6-8
Technical Support Contacts.	6-12

Chapter 7. Maintenance

Maintaining the Internal Battery	7-1
Storing the Terminal	7-2
Cleaning	7-2

Appendix A. Utilities and Diagnostic Tests

VRC 6940 Self Tests	A-2
Keyboard Test	A-4
DIAG24 Diagnostics Utility	A-5
DIAG24 Setup	A-5
Ping Test	A-8
Field Diagnostic Test	A-10
CFG24 Configurator Utility	A-12
Starting the Utility	A-12
Initializing the Radio	A-12
The Configurator Menu	A-13
View Config Parameters	A-13
ESS ID or Net ID	A-14
Subnet Mask	A-14
Default Router	A-15
Terminal IP Address	A-16
Diversity	A-16
MU Sleep Mode	A-17
Boot Mode	A-17
Power Management	A-18
Buffers	A-19
Re-Transmit Delay	A-19
Rate Control	A-20
Scanner/RF Operation	A-20
Flash Utility	A-21
Deleting	A-21
Copying	A-21
Renaming	A-21

Appendix B. Software Environment

Boot Sequence	B-2
LAN WorkPlace (LWP) Software	B-3
Software Files	B-3

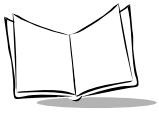

Appendix C. Keyboard Layouts

Keyboard Character & Character Combination Illustrations. C-4

Appendix D. Environmental and Technical Specifications

Specifications. D-1
Scanner Port D-2
COM1 Serial Port D-3
Null Modem D-4

Appendix E. Communications Status Codes

Communications Status Codes. E-1

Glossary

Index

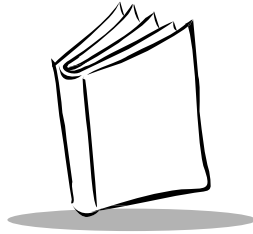

About This Manual

This Product Reference Guide describes the VRC 6940 terminal. Topics include: hardware installation, software configuration, operation, troubleshooting, and maintenance.

Notational Conventions

This document uses the following conventions:

- ◆ “Operator” or “User” refers to anyone using a VRC 6940 terminal.
- ◆ “Terminal” refers to a VRC 6940 terminal.
- ◆ “You” refers to the System Administrator or Technical Support person using this manual to install, configure, operate, maintain or troubleshoot a VRC 6940.
- ◆ Bold upper case type indicates a key on the terminal. For example: “Press **ENTER**”, “Press **J**, then **K**”.
- ◆ `Courier` type is used for command line text and file names.
- ◆ *Italics* are used:
 - ◆ to identify menu items on a terminal screen
 - ◆ for variable names in usage and syntax descriptions
 - ◆ to highlight specific items in the general text
 - ◆ to identify chapters and sections in this and related documents
- ◆ Bullets (◆) indicate:
 - ◆ action items
 - ◆ lists of alternatives
 - ◆ lists of required steps that are not necessarily sequential
- ◆ Sequential lists (*e.g.*, those that describe step-by-step procedures) appear as numbered lists.

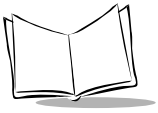

Related Publications

- ◆ *VRC 6900 Series Quick Reference Guide*
p/n 72-37640-XX
- ◆ *Series 3000 Application Programmer's Guide*
p/n 70-16308-XX
- ◆ *Series 3000 Application Programmer's Reference Manual*
p/n 70-16309-XX
- ◆ *Series 3000 System Software Manual*
p/n 70-16310-XX
- ◆ *Spectrum 24 Network Terminal Technical Reference Guide — Radio Firmware and Driver Guide Version 3*
p/n 70-20193-XX
- ◆ *Spectrum 24 Ethernet Access Point User Guide*
p/n 70-12057-XX
- ◆ *Spectrum24 Wireless LAN Adapter Product Reference Guide*
p/n 70-20505-XX

Contact and Service Information

If you have a problem with your equipment, contact the [Symbol Support Center](#) for your region. See [page vii](#) for contact information. Before calling, have the model number, serial number, and several of your bar code symbols at hand.

Call the Support Center from a phone near the scanning equipment so that the service person can try to talk you through your problem. If the equipment is found to be working properly and the problem is symbol readability, the Support Center will request samples of your bar codes for analysis at our plant.

If your problem cannot be solved over the phone, you may need to return your equipment for servicing. If that is necessary, you will be given specific directions.

Note: *Symbol Technologies is not responsible for any damages incurred during shipment if the approved shipping container is not used. Shipping the units improperly can possibly void the warranty. If the original shipping container was not kept, contact Symbol to have another sent to you.*

Symbol Support Center

For service information, warranty information or technical assistance contact or call the Symbol Support Center in:

United States ¹

Symbol Technologies, Inc.
One Symbol Plaza
Holtsville, New York 11742-1300
1-800-653-5350

United Kingdom

Symbol Technologies
Symbol Place
Winnersh Triangle, Berkshire RG41 5TP
United Kingdom
0800 328 2424 (Inside UK)
+44 208 945 7529 (Outside UK)

Australia

Symbol Technologies Pty. Ltd.
432 St. Kilda Road
Melbourne, Victoria 3004
1-800-672-906 (Inside Australia)
+61-3-9866-6044 (Outside Australia)

Denmark/Danmark

Symbol Technologies AS
Gydevang 2,
DK-3450 Allerod, Denmark
7020-1718 (Inside Denmark)
+45-7020-1718 (Outside Denmark)

Finland/Suomi

Oy Symbol Technologies
Kaupintie 8 A 6
FIN-00440 Helsinki, Finland
9 5407 580 (Inside Finland)
+358 9 5407 580 (Outside Finland)

Canada

Symbol Technologies Canada, Inc.
2540 Matheson Boulevard East
Mississauga, Ontario, Canada L4W 4Z2
905-629-7226

Asia/Pacific

Symbol Technologies Asia, Inc.
230 Victoria Street #04-05
Bugis Junction Office Tower
Singapore 188024
337-6588 (Inside Singapore)
+65-337-6588 (Outside Singapore)

Austria/Österreich

Symbol Technologies Austria GmbH
Prinz-Eugen Strasse 70
Suite 3
2.Haus, 5.Stock
1040 Vienna, Austria
1-505-5794 (Inside Austria)
+43-1-505-5794 (Outside Austria)

Europe/Mid-East Distributor Operations

Contact your local distributor or call
+44 208 945 7360

France

Symbol Technologies France
Centre d'Affaire d'Antony
3 Rue de la Renaissance
92184 Antony Cedex, France
01-40-96-52-21 (Inside France)
+33-1-40-96-52-50 (Outside France)

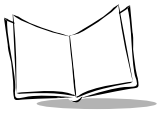

VRC 6940 Product Reference Guide

Germany/Deutschland

Symbol Technologies GmbH
Waldstrasse 68
D-63128 Dietzenbach, Germany
6074-49020 (Inside Germany)
+49-6074-49020 (Outside Germany)

Latin America Sales Support

7900 Glades Road
Suite 340
Boca Raton, Florida 33434 USA
1-800-347-0178 (Inside United States)
+1-561-483-1275 (Outside United States)

Netherlands/Nederland

Symbol Technologies
Kerkplein 2, 7051 CX
Postbus 24 7050 AA
Varsseveld, Netherlands
315-271700 (Inside Netherlands)
+31-315-271700 (Outside Netherlands)

South Africa

Symbol Technologies Africa Inc.
Block B2
Rutherford Estate
1 Scott Street
Waverly 2090 Johannesburg
Republic of South Africa
11-4405668 (Inside South Africa)
+27-11-4405668 (Outside South Africa)

Sweden/Sverige

Symbol Technologies AB
Albygatan 109D
Solna
Sweden
84452900 (Inside Sweden)
+46 84452900 (Outside Sweden)

Italy/Italia

Symbol Technologies Italia S.R.L.
Via Cristoforo Colombo, 49
20090 Trezzano S/N Naviglio
Milano, Italy
2-484441 (Inside Italy)
+39-02-484441 (Outside Italy)

Mexico/México

Symbol Technologies Mexico Ltd.
Torre Picasso
Boulevard Manuel Avila Camacho No 88
Lomas de Chapultepec CP 11000
Mexico City, DF, Mexico
5-520-1835 (Inside Mexico)
+52-5-520-1835 (Outside Mexico)

Norway/Norge

Symbol Technologies
Trollasveien 36
Postboks 72
1414 Trollasen, Norway
66810600 (Inside Norway)
+47-66810600 (Outside Norway)

Spain/España

Symbol Technologies S.A.
Edificio la Piovera Azul
C. Peonias, No. 2 - Sexta Planta
28042 Madrid, Spain
9-1-320-39-09 (Inside Spain)
+34-9-1-320-39-09 (Outside Spain)

¹Customer support is available 24 hours a day, 7 days a week.

If you purchased your Symbol product from a Symbol Business Partner, contact that Business Partner for service.

For the latest version of this guide go to:<http://www.symbol.com/manuals>.

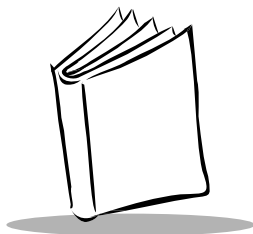

Chapter 1 Getting Started

VRC 6940 terminals are rugged mobile computer terminals that communicate by radio with a host computer on Spectrum24[®] networks. End-users view network applications and data on the terminal's 8-line screen, and use its keyboard or an attached scanner to enter and transmit data.

The terminal uses the DR-DOS[™] V3.41 operating system, compatible with the industry-standard IBM PC-DOS[™]. DR-DOS provides access to a number of commercially available programming tools. Symbol can provide additional programming tools for easier system programming and access to special features.

VRC 6940 features include:

- ◆ 8 line x 40 column screen display
- ◆ 54-key keyboard
- ◆ DOS operating system and 16-bit processing
- ◆ compatibility with laser scanners and pen-based bar code readers
- ◆ support for industrial software applications
- ◆ support for spread-spectrum radio frequency technology

Purpose of This Manual

This manual is for Information Systems and Technical Support personnel who are responsible for installing and supporting VRC 6940 terminals. It describes how to install, configure and maintain a terminal. For information on day-to-day operation for end-users, see the *VRC 6940 Terminal Quick Reference Guide* (p/n 72-37640-XX).

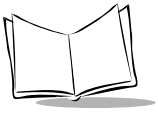

Parts of a VRC 6940 Terminal

Standard Parts

A standard VRC 6940 terminal includes these standard parts:

- ◆ Terminal with attached vehicle-mount bracket
- ◆ Bracket knobs (2)
- ◆ External DC power cable
- ◆ Internal PCMCIA radio card for use with a Symbol Spectrum24 network
- ◆ *VRC 6940 Terminal Quick Reference Guide* (p/n 72-37640-XX)

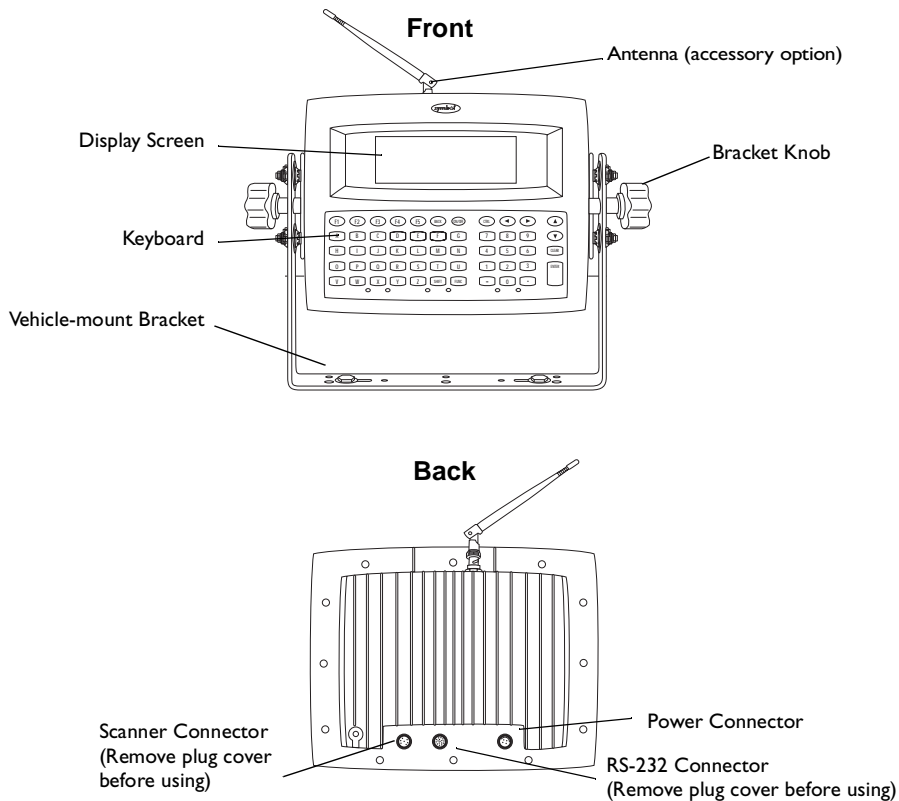

Figure I-1. Parts of a VRC 6940

Options and Accessories

Options

You can also order the VRC 6940 with these options:

- ◆ Keyboard backlight
- ◆ Internal heating device

Accessories

You can order these VRC 6940 accessories separately from Symbol:

- ◆ Scanner cable
- ◆ RS-232 cable
- ◆ Primary antenna
- ◆ Vehicle-mounted antenna
- ◆ Spectrum24[®] PCMCIA radio card
- ◆ AC Universal Power Supply
- ◆ AC cable
- ◆ DC cable

Note: Contact your Symbol Sales representative to order the cable appropriate for your country.

Radio Cards

VRC 6940 models include an internal PCMCIA radio card for use with a Symbol Spectrum24 network. For other information on radio cards, contact Symbol Technologies.

Scanners

The VRC 6940 terminal can use these Symbol laser scanner models:

- ◆ LS 2000
- ◆ LS 3000
- ◆ LS 5000
- ◆ LS 9100
- ◆ LT 1700

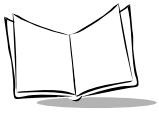

Printers

The VRC 6940 terminal can use these Symbol printer models:

- ◆ PS 1000
- ◆ PS 200

Before You Use the Terminal...

Table I-1. VRC 6940 Installation and ConfigurationTasks

Task	Where to Find the Instructions
Install the hardware in a vehicle or forklift, or on a wall or workbench.	See Hardware Installation page 2-2.
Provide a primary AC or DC power source.	See Providing Power: Vehicle Installations on page 2-5.
Charge the internal battery.	See Installation and the Internal Battery on page 2-8.
Configure the radio card.	See Configuring a Spectrum24 Radio Card on page 3-2.
Transfer, install and configure software.	See Transferring and Installing Application Programs on page 4-2.

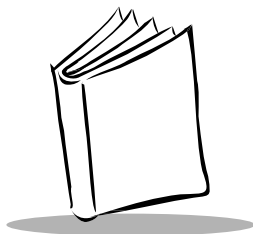

Chapter 2 Installing Hardware

This chapter describes how to install a VRC 6940 terminal into a vehicle or onto a wall or workbench. Please read all of these instructions before you begin.

Caution

A properly trained technician must perform the installation. Improper installation can damage your vehicle.

Equipment Required

Vehicle Mounted VRC 6940

- ◆ an External DC power cable (supplied with terminal).
- ◆ minimum of two 3/8” bolts with self-locking nylon nuts.
- ◆ a drill with a 7/16” drill bit.
- ◆ 7/16” hex wrench.
- ◆ a connector for terminating the External DC power cable. Select one that mates with your vehicle’s power supply.
- ◆ primary or external antenna (optional).

Wall or Workbench Mounted VRC 6940

- ◆ AC universal power supply (Symbol p/n 50-14001-006)
- ◆ AC line cable (Symbol p/n 23844-00-00)
- ◆ DC power cable (Symbol p/n 25-39385-01)
- ◆ minimum of two 3/8” bolts with self-locking nylon nuts

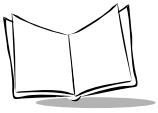

- ◆ a drill with a 7/16” drill bit
- ◆ 7/16” hex wrench
- ◆ primary or external antenna (optional)

Hardware Installation

The physical requirements of the work area affect where you place the terminal. There are different installation options, depending on where you plan to locate it. [Figure 2-1](#) shows a terminal mounted on a vehicle. [Figure 2-2](#) shows a terminal mounted on a wall, and [Figure 2-3](#) shows a terminal mounted on a workbench.

Caution

Do not install a VRC 6940 terminal in a location that will affect vehicle safety or driveability.

To install VRC 6940 hardware:

1. Prepare a mounting location:
 - a. Select a location to mount the terminal. The terminal’s attached bracket has holes cut for bolts. Use these holes to mark bolt hole locations.
 - b. Prepare the mounting surface to accept two 3/8” bolts. Drill two holes with a 7/16” drill bit.
2. Install the terminal onto the mounting surface:
 - a. Position the terminal on the mounting surface.
 - b. Fasten it securely using a minimum of two 3/8” self-locking nuts.
3. Attach the Bracket Knobs. When you first unpack it, the terminal has hex bolts in place of the Bracket Knobs shown in [Figures 2-1](#), [2-2](#), and [2-3](#). These knobs allow users to adjust the angle of the terminal.
 - a. Use a 7/16” hex wrench to remove the bolts.
 - b. Replace them with the Bracket Knobs.
 - c. To adjust the angle of the display, partially unscrew the Bracket Knobs. Then adjust the angle of the terminal and re-tighten the knobs.

Installation Note: Mounting Locations
The bracket and terminal must be: <ul style="list-style-type: none">• firmly secured to a surface that can support the terminal’s weight — on a vehicle, wall or workbench• secured with a minimum of two 3/8” diameter bolts and nylon self-locking nuts• easy to for end-users to see and reach

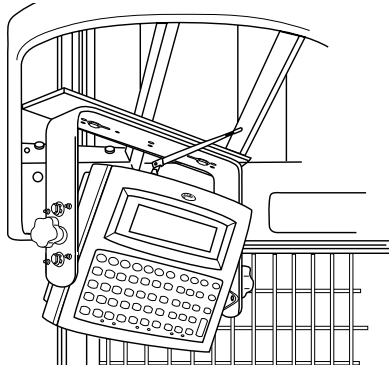

Figure 2-1. Terminal Mounted on a Vehicle

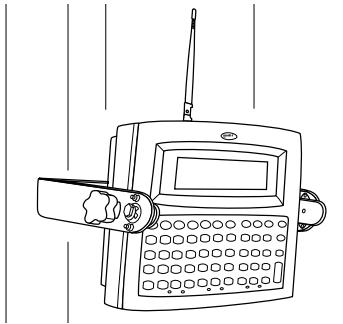

Figure 2-2. Terminal Mounted on a Wall

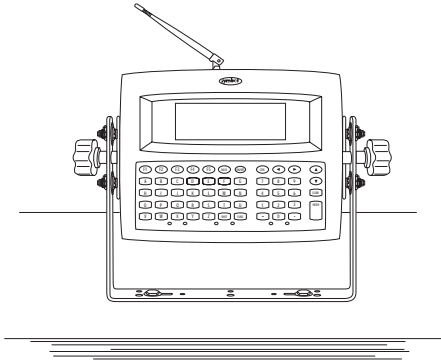
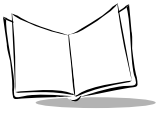

Figure 2-3. Terminal Mounted on a Workbench



4. Optional: attach a primary antenna to the connector at the top of the terminal, as shown in [Figure 2-4](#). To attach the antenna:
 - a. Place the metal end of the antenna onto the connector.
 - b. Line up the posts with the connector openings and press down gently.
 - c. Twist the bottom ring clockwise to lock it into position.

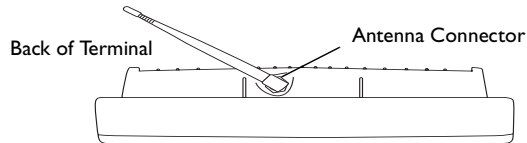

Figure 2-4. Attaching a Primary Antenna

5. Optional: install a vehicle-mounted antenna. Sometimes you can improve wireless communication by mounting an external antenna onto the vehicle, as shown in [Figure 2-5](#). Symbol has several different external antennas available. Contact your Support Representative for more information.

To connect an external vehicle-mounted antenna:

- a. Secure the external antenna to an appropriate location on the vehicle.
- b. Connect one end of a coaxial cable to the terminal's Antenna Connector. Connect the other end to the vehicle-mounted antenna. Make the coaxial cable as short as possible to minimize signal loss.

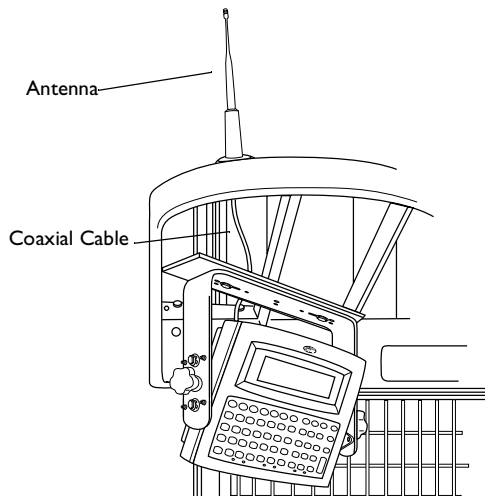

Figure 2-5. Vehicle-Mounted Antenna

Providing Power: Vehicle Installations

VRC 6940 terminals can be powered by:

- ◆ 12V or 24V gas-powered vehicles
- ◆ battery-powered vehicles, up to 60 volts

To provide power to a vehicle-installed VRC 6940:

1. Locate your vehicle's power source. Always connect a VRC 6940 terminal to a continuous or unswitched power source.
2. Prepare the External DC power cable. One end of the power cable fits into the terminal's DC Power connector. The other end has no connector (see [Figure 2-6](#)).

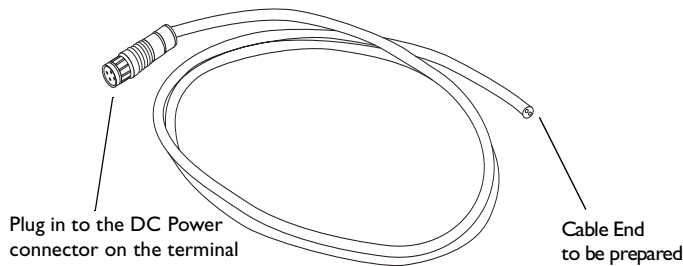

Figure 2-6. Preparing the External DC Power Cable

To prepare the External DC power cable end:

- a. **⚠ In-line fuse holder:** if no fused output is available, add a fuse-holder and 5 Amp fuse to the External DC power cable. Follow these steps and refer to [Figure 2-7](#):
 - i. Strip back six inches of the cable jacket.
 - ii. Cut about 5" from the red power wire and strip 3/8" insulation from the wire.
 - iii. Strip 3/8" insulation from the fuse-holder wire.
 - iv. Twist the stripped wire ends together and splice them using a twist-on nylon wire connector.
 - v. Make sure the fuse holder contains a 5 Amp slow-blow fuse. Wrap the wires neatly, as necessary.

Installation Note: Power Sources

The ideal location for connecting a VRC 6940 External DC power cable would be a fused power source on the vehicle's power distribution panel. If no fused power source is available, connect the terminal directly to a vehicle battery. In this case, Symbol recommends you use an in-line fuse holder and 5A slow-blow fuse. The fuse protects your vehicle from an electrical short on the power cable.

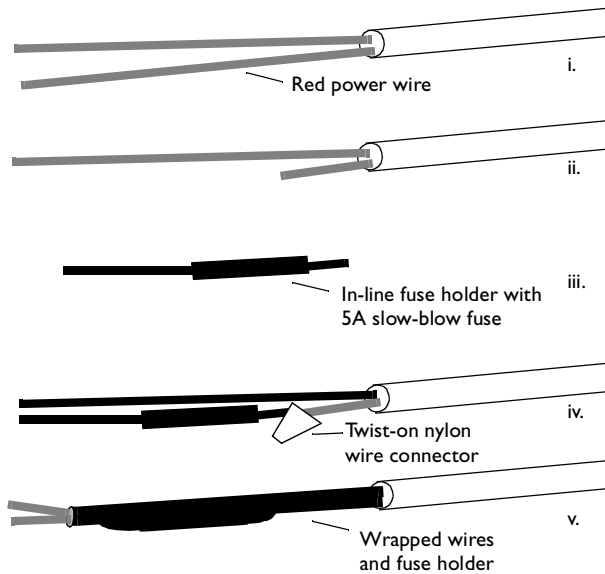
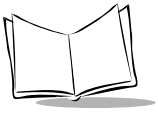

Figure 2-7. Adding an In-line Fuse Holder

- b. Route the External DC power cable from the terminal location to the connection point for your vehicle's power source.

⚠ See the Installation Note below.

⚠ Installation Note: Cable Routing Caution ⚠

The means of routing and securing the External DC power cable from the terminal to the vehicle power source is extremely important. Hazards associated with improper wiring can be severe.

To avoid unintentional contact between the wire and any sharp edges, provide the cable with proper bushings and clamping where it passes through openings. If the wire is subjected to sharp surfaces and excess engine vibration, wiring harness insulation can wear away, causing a short between the bare wire and chassis. This can start a fire.

3. Prepare the cable termination: Strip 3/8” of insulation from the two wire ends and terminate them with a connector that matches your vehicle’s requirements. See the Installation Note, right, for more information.
 - a. Connect the red wire to the vehicle power source. Connect the black wire to a vehicle ground wire or chassis ground.
 - b. Connect the External DC power cable to your vehicle power source.
4. Insert the terminal end of the External DC power cable into the terminal’s Power Connector. Align the red dot on the end of the power cable with the red dot on the Power Connector.

Installation Note: Cable Termination
<p>How the cable terminates depends on your vehicle. If your vehicle has a power output connector, then attach a mating connector to the end of the power cable. You may be able to connect to a fuse panel with a commercially available connector. If your vehicle has <i>no</i> power output connector, attach a ring terminal (for a battery post) or blade terminal connector (for a fuse panel).</p> <p>Consult your vehicle Owner’s Manual for information on how to access your vehicle’s power supply.</p>

WARNING

A Lead Acid battery can leak Hydrogen gas. A spark anywhere near the battery can cause it to explode. Always make your final connection to power as far away from the battery as possible, *i.e.*, connect the power cable to the battery first, then connect it to the terminal.

Providing Power: Wall or Workbench Installations

For wall or workbench-mounted terminals, or for operating a terminal while away from a vehicle, you can power an VRC 6940 from an AC universal power supply. You need the AC universal power supply, an AC line cable, and a DC power cable as listed on [page 2-1](#).

To provide power from an AC source:

1. Insert the AC line cable into the AC connector on the AC universal power supply.
2. Plug the other end of the AC line cable into an AC wall outlet.
3. Insert the DC power cable into the DC connector on the AC universal power supply.
4. Plug the other end of the cable into the terminal’s Power Connector.

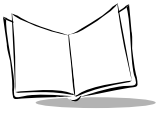

Installation and the Internal Battery

A VRC 6940 terminal has an internal battery that powers the terminal if there is a temporary interruption, disconnection, or fluctuation in the main DC or AC power. We recommend that you save all data and close all applications before removing a terminal's main power supply.

You cannot use the internal battery to operate the terminal.

A terminal's internal battery may be depleted when you first install it. It charges itself from the terminal's main power supply (DC or AC). If the main power supply is stable, you can plug in the terminal and use it immediately.

If the main power supply is not stable, there may be power interruptions that cause the terminal to reset itself during its first few hours of operation. If the terminal resets itself, you may lose unsaved data. To avoid this, we recommend that you plug in the terminal and allow it to charge for two hours before using it.

It takes 48 hours to fully charge the internal battery. A fully charged internal battery can maintain data for up to 72 hours if the unit is disconnected from its main power source. This time is reduced if the radio mode maintains continuous communication with a host.

Note: *Reliable terminal operation during power interruptions cannot be guaranteed without a fully charged internal battery. If the internal battery is not fully charged, a power interruption may cause the terminal to reset itself and erase valuable data.*



Chapter 3 Configuring Spectrum24

Each VRC 6940 terminal has a Spectrum24 radio card that must be configured before the terminal can communicate with a Spectrum24 network. This chapter describes how to do this. For more information on Spectrum24 radio communications, see *Spectrum24 Network Terminal Technical Reference Guide — Radio Firmware and Driver Guide Version 3* (p/n 70-20193-XX).

Before you begin, read the procedures in this chapter all of the way through and provide a power source as described in Chapter 2.

Equipment Required

To configure the terminal and transfer applications, you need these items:

- ◆ a VRC 6940 terminal
- ◆ a reliable power source

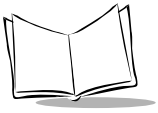

Configuring a Spectrum24 Radio Card

To configure a Spectrum24 radio card.

1. Provide a reliable power source.

If you have not already done so, install the terminal hardware and provide a reliable power source as described in Chapter 2. If the terminal is mounted in a vehicle, it can remain mounted as long as the internal battery is fully charged (see [page 2-8](#)) and you can position it close enough to the host PC for the cables to reach. Otherwise, remove it from the vehicle, position it on a workbench and provide operating power with a Symbol AC universal power supply.

Note: *If there is a power interruption during configuration, simply restore the power and start again at step two (Start the Terminal).*

2. Start the terminal.

The first time you power up a VRC 6940 terminal, press the ON/OFF key to start the terminal, and let it run through a series of messages. The terminal loads essential utilities and system drivers and displays the CFG24 Configurator utility as shown in [Figure 3-1](#).

You can also start the CFG24 Configurator utility by typing CFG24 at a DOS command line and pressing ENTER.

```
CONFIGURATOR X.XX
View config
ESS Id
Subnet Mask
Default Router
MU IP Address
Diversity
↑↓ CLR, Enter
```

Figure 3-1. The CFG24 Configurator Utility

3. Set Spectrum24 configuration parameters.

The CFG24 Configurator utility lets you set Spectrum24 parameters in a text file on the RAM disk (D:\net.cfg). It also saves the parameters in a buffer in flash memory on the radio card. The radio driver and TCP/IP stack get their configuration parameters from net.cfg.

Table 3-1 summarizes Spectrum24 parameters. For more information on setting parameters, see [CFG24 Configurator Utility](#) on page A-12.

Configuration Note: Navigating the Menus

To navigate through the menus:

- Press **UP** or **DOWN** arrow keys to scroll through menu options.
- To select, highlight the menu option you want, then press **ENTER**. A highlighted option shows up in reverse video.
- To erase an entire entry, press **DEL**, and then **D**.
- To erase part of an entry, press **BACK**.
- To return to a previous menu, press **CLEAR**.
- To exit to the DOS prompt, return to the Configurator menu and press **CLEAR**.

Table 3-1. Spectrum24 Configuration Options

Option	Description
View Config	Displays the current Spectrum24 configuration.
ESS Id or Net Id	A radio network ID that lets you differentiate between different radio networks. All equipment on one network must use the same ESS Id or Net Id . Set this parameter to the same value specified for the Spectrum24 Access Points (APs). An ESS Id requires a 32-character alphanumeric value. A Net Id requires a three-character hexadecimal value (101 to 1FE).
Subnet Mask	The network uses a Subnet Mask to determine whether or not one device can communicate directly with another (e.g., a terminal trying to communicate with a host computer). The Subnet Mask depends on your facility's IP address allocations. Set this option as advised by your Network Administrator. The default value is 255.0.0.0 <i>Note: If you change the boot mode, the value set by a server overrides this value. See Boot Mode.</i>
Default Router	The Default Router is the node address that receives all packets destined for remote networks. Set this as advised by your Network Administrator. The default value is 0.0.0.0
MU IP Address	If a terminal is using a fixed IP address, enter it in this field. Networks use IP addresses to determine where to send data that is being transmitted over the network.

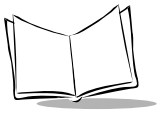
**Table 3-1. Spectrum24 Configuration Options**

Option	Description
Diversity	Determines how many antenna ports the radio will attempt to use for communications. Match this setting to the number of antennas you're using.
MU Sleep Mode	If you set MU Sleep Mode to <i>On</i> , the radio stays on even if an application powers down the terminal because of inactivity. The default setting is <i>On</i> .
Boot Mode	Indicates the source of the terminal's IP address. Options are <i>Boot</i> , <i>DHCP</i> or <i>Manual Entry</i> . If you select <i>Manual Entry</i> , the terminal uses the IP address specified in <i>MU IP Address</i> . See page A-17 for more information.
Pwr Management	If you set Pwr Management to <i>PSP</i> , the radio only powers up when there is traffic on the network. If you set it to <i>CAM</i> , the radio is always ready to receive. The default setting is <i>PSP</i> .
Buffers	Sets the number of data buffers used by the radio driver (<i>4</i> , <i>8</i> or <i>12</i>).
ReXmit Delay	If a terminal tries to transmit a packet and fails, it tries to re-transmit the packet later. ReXmit Delay sets the length of time between re-transmissions. The options are <i>short</i> and <i>long</i> . The <i>short</i> option improves response time but uses more power. If there is high network traffic, or a high amount of electrical "noise" nearby, select <i>short</i> to improve response time.
Rate Control	Determines which Spectrum24 Access Points a terminal can communicate with. The options are <i>1Mb only</i> , <i>2Mb only</i> , <i>1Mb</i> and <i>2 Mb</i> . Select a parameter that matches the Rate Setting for the AP, if one has been specified. For more information see <i>Spectrum24 Wireless LAN Adapter Product Reference Guide</i> (p/n 70-20505-XX).
Scan/RF Op	Determines whether or not the scanner and radio can operate at the same time. <i>Concurrent Op</i> allows both to operate at the same time. <i>Scan Stops RF</i> causes the scanner to lock out the radio during an active scan.
Exit	Closes the utility and displays a DOS prompt.

Note: *If you are using a Spectrum24 card with the 802.11 protocol, the ESS Id option appears on the menu. If you are using a Spectrum24 card with the Spring protocol, the Net Id option appears on the menu.*

4. When you finish setting Spectrum24 parameters, warm boot the terminal:
 - a. Press the **ON/OFF** key to suspend the terminal.
 - b. Press and hold the **SHIFT** and **L** keys.
 - c. Press and release the **ON/OFF** button.
 - d. Release the **SHIFT** and **L** keys.
 - ♦ The terminal reloads the system drivers and attempts to associate with a Spectrum24 AP.
 - ♦ If the radio card is configured correctly, it tries to locate a bootp server, fails, and boots to a DOS prompt. *This means the radio card is working correctly.* Proceed to step 5.
 - ♦ If the radio card is not configured correctly, the CFG24 Configurator utility reappears. Recheck your configuration parameters and perform another warm boot.
5. Turn the VRC 6940 off.

You have successfully configured the Spectrum24 radio card. You may now download and install application programs. See [Transferring and Installing Application Programs on page 4-2](#).

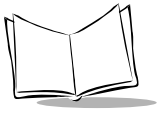

VRC 6940 Product Reference Guide



Chapter 4 Installing Software

This chapter describes how to install application programs onto a terminal. VRC 6940 terminals have a number of drives available for storing user applications and data. For more information on available drive space, the software environment and a list of standard VRC 6940 software, see [Appendix B, Software Environment](#).

Before you begin, read the procedures in this chapter all of the way through.

Equipment Required

To transfer applications, you need:

- ◆ a VRC 6940 terminal
- ◆ a Host PC
- ◆ an RS-232 serial null modem cable with a 16-pin male connector at one end, and a 25-pin female connector at the other end
- ◆ a reliable power supply
- ◆ software for transferring files from a Host PC to the terminal

See [Table 4-1](#) for information on recommended software. Also see the *Series 3000 Application Programmer's Reference Manual* (p/n 70-16309-XX).

Table 4-1. Software Required for Transferring Files

Type of File to be Transferred	Host PC Software	VRC 6940 Software
HEX Image	SENDHEX or WINHEX	Program Loader
Other file types	TFT3000	TDREM

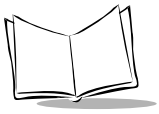

Transferring and Installing Application Programs

This section describes how to transfer a HEX image from a Host PC onto a VRC 6940 terminal over a standard RS-232 null modem cable. The procedure uses the SENDHEX or WINHEX program on the Host PC and the Program Loader utility on the VRC 6940.

The Program Loader installs the HEX image by converting the ASCII data stream into files that are stored in non-volatile memory (NVM) on the terminal (the application EEPROM). Any further installation procedures depend on the contents of the HEX file.

To transfer non-HEX images or files, use the TFT3000 program on the Host PC, and the TDREM utility on the terminal. For details on all of these programs, refer to the *Series 3000 Application Programmer's Reference Manual* (p/n 70-16309-XX).

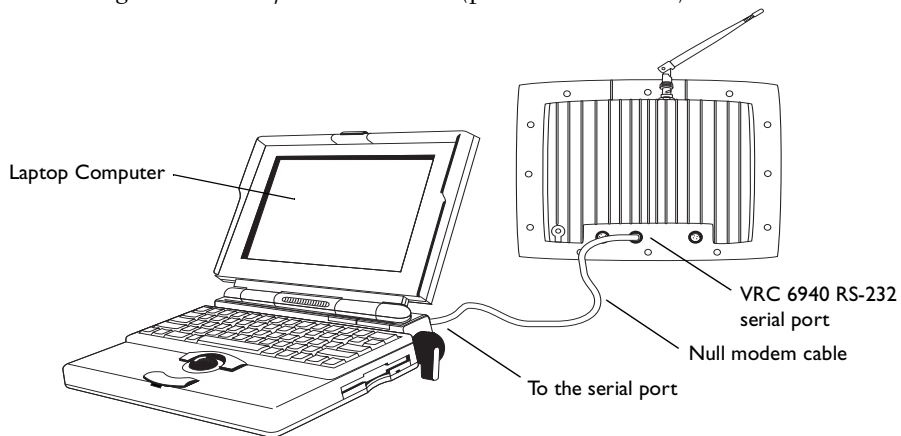

Figure 4-1. Cabling for Downloading on Benchtop

I. Prepare the PC for Communications and File Downloading

To prepare the PC for communications:

1. Begin with the VRC 6940 terminal in suspend mode.
2. Remove the plug cover from the RS-232 serial port on the terminal, and attach the male connector end of the null modem cable.
3. Attach the female end of the null modem cable to the Host PC serial port, as shown in [Figure 4-1](#). Use an adapter, if necessary.
4. On the PC, start the communications program. For example, to use SENDHEX, first open a DOS window. Then type the SENDHEX command with appropriate

parameters, and press ENTER. The example in [Figure 4-2](#) shows a baud rate of 38400, and the COM2 option. For `pgmname`, type the name of the HEX file you are transferring, without the `.hex` extension. The default parameter values are:

- ♦ 9600 bps
- ♦ COM1
- ♦ 7 data bits
- ♦ Odd parity
- ♦ Xon/Xoff flow control

```

C:\>cd\
sendhex pgmname 38400 com2
  
```

SENDHEX Command

HEX File Name (no .hex extension)

Baud Rate

COM Port

Figure 4-2. Setting up Communications with SENDHEX

Note: *Versions of SENDHEX earlier than version 3.0 do not support flow control. If you are using an earlier version, and errors appear, use a lower baud rate.*

5. A prompt appears as shown in [Figure 4-3](#). *Do not press ENTER yet.* You must set up the VRC 6940 terminal next, as described in the next section.

```

C:\>cd\
sendhex pgmname 38400 com2
Version: 3.01-01
Press <Enter> when remote is ready. ESC to abort...
  
```

Figure 4-3. The SENDHEX Prompt

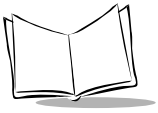

2. Provide a Reliable Power Source

If you have not already done so, install the terminal hardware and provide a reliable power source, as described in Chapter 2. If the terminal is mounted on a vehicle, it can remain mounted as long as the internal battery is fully charged (see [page 2-8](#)) and you can position it close enough to the Host PC for the cables to reach. Otherwise, remove it from the vehicle, position it on a workbench and provide operating power with a Symbol AC Universal Power Supply.

Note: *If there is a power interruption during the file transfer process, restore the power and start again at step three (Prepare the Terminal for Transferring Files).*

3. Prepare the Terminal for Transferring Files

This section describes how to run the Program Loader utility on a VRC 6940 terminal, so the terminal can receive files transferred from a Host PC. To set up the terminal:

1. Boot the VRC 6940 into Command Mode:
 - a. With the terminal in suspend, press and hold the **A** and **D** keys.
 - b. Press and release the **ON/OFF** key.
 - c. Release the **A** and **D** keys.
2. The terminal boots to the Command Mode screen, shown in [Figure 4-4](#).

Installation Note: Using Menus
To navigate the menus: <ul style="list-style-type: none">• Press UP or DOWN arrow keys to scroll through options.• To return to the previous menu, press CLEAR.

```
COMMAND MODE

Select Function
Self Test
```

Figure 4-4. Command Mode screen

3. Press **UP** or **DOWN** arrows to scroll through Command Mode options until you see the *Program Loader* option. Then press **ENTER** to display the message shown in [Figure 4-5](#).

```

Program Loader
WARNING: EEPROM
WILL BE ERASED
CONTINUE? <ENT>

```

Figure 4-5. Erasing NVM (EEPROM)

4. When you are ready to erase EEPROM, press **ENTER**. This message appears:

```

Program Loader
Erasing EEPROM
Please wait...

```

The program erases the EEPROM and prompts you for communications parameters.

Installation Note: Before you Erase EEPROM

If you have *not* configured the Spectrum24 radio card for the terminal, press **CLEAR** to cancel the operation, and configure the radio card now (see [page 3-2](#)). When you run the Program Loader and press **ENTER**, it erases the EEPROM (non-volatile memory). You must erase the EEPROM before you can transfer the HEX file onto the terminal.

5. Set the communications parameters to 38400 bps, 7 data bits, odd parity and Xon/Xoff flow control.
 - a. Baud Rate: Select *38400*. The screen will look like this:

```

Comm Parameters
Baud
6 38400

```

Figure 4-6. Setting Baud Rate on the VRC 6940

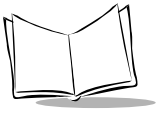

- b. Data Bits: Select 7. The screen will look like this:

```
Comm Parameters
Data Bits
7
```

Figure 4-7. Setting Data Bits on the VRC 6940

- c. Parity: Select *Odd*. The screen will look like this:

```
Comm Parameters
Parity
Odd
```

Figure 4-8. Setting Parity on the VRC 6940

- d. Flow Control: Select *Xon/xoff*. The screen will look like this:

```
Comm Parameters
Flow Control
Xon/xoff
```

Figure 4-9. Setting Flow Control on the VRC 6940

6. When all parameters are set, the screen displays this message:

```
Program Loader
Start? <ENT>
```

7. Press ENTER to start the Program Loader.

4. Start the File Transfer

1. On the Host PC, press **ENTER** to start the transfer. The Host PC displays this message:

```
C:>\ Bytes sent = xxxx  xx%
```

If the Host PC is not ready or the cable is disconnected between the PC and the terminal, the PC displays this message:

```
Awaiting DSR
```

In this case, check the cable connection and then press **ENTER** again on the Host PC to start the download.

2. During the transfer, the VRC 6940 terminal displays these messages:

```
Program Loader
Receiving :xxxx
```

Check the status on both the terminal and the Host PC during data transmission. They should both show program segment addresses being transferred (XXXX). If this does not happen, then the data is not transferring correctly.

3. When the transmission is complete, the terminal displays a status code. A successful download shows a status of 0000. This message appears:

```
Program Loader
Status 0000
```

Any other value indicates a failed transfer. See Appendix E, *Communications Status Codes*.

Failed Transfers

If a file transfer finishes with a status value other than 0000, then the transfer was not successful. In this case:

1. Check cable connections between the VRC 6940 terminal and the Host PC. Make sure the null modem cable is connected to the correct port on the Host PC.
2. Repeat the transfer steps using a lower baud rate (*e.g.*, 19200).
3. If the problem persists, contact Symbol Technical Support for assistance.

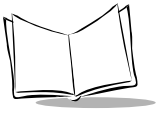

Successful File Transfer

Following a successful file transfer, the files must be copied to the flash disk before you can use them. This happens the next time the terminal is re-initialized (cold booted). See

[5. Complete the Installation of Transferred Files](#), next.

5. Complete the Installation of Transferred Files

To complete the installation of transferred files, you must re-initialize (cold boot) the terminal. To do this:

1. Disconnect the null modem cable from the VRC 6940 terminal and Host PC.
2. Replace the terminal plug cover for the serial port on the VRC 6940.
3. Perform a cold boot:
 - a. Press and hold the ENTER, F1 and F4 keys.
 - b. Press and release the ON/OFF key.
 - c. Release the ENTER, F1 and F4 keys.
4. When the terminal restarts, it boots according to the applications you have loaded. For more information, refer to the documentation for the applications.

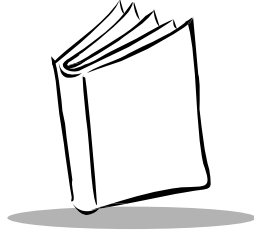

Chapter 5 Operating a VRC 6940

After you install and configure a VRC 6940 terminal for your facility, you can release it for use. This chapter describes how to use the terminal, including:

- ◆ Powering the terminal On and Off
- ◆ Resetting the terminal
- ◆ Adjusting brightness
- ◆ Entering data
- ◆ Attaching a scanner
- ◆ Moving a terminal to different power source
- ◆ Booting into Command Mode

The instructions in this chapter assume that the terminal has been fully installed, configured, and set up to run your facility's software applications. For information on installing and configuring a terminal, see Chapters 2, 3 and 4.

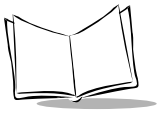

Powering a Terminal On and Off

A terminal must be connected to a main power supply (*e.g.*, a vehicle battery). If you remove this power supply, the terminal suspends and cannot be turned on again until you reconnect the power. An internal battery maintains data while the terminal is suspended, but it cannot be used to operate the terminal. Save all your data and close all applications before removing a terminal's main power supply. See [page 2-8](#) for more information.

Powering On

To turn the terminal on, press the ON/OFF key located at the top right corner of the alpha section of the keyboard. As the terminal starts, several screens of information appear, followed by the application screen set to run at your facility. If the terminal does not power on, see Chapter 6, *Troubleshooting*.

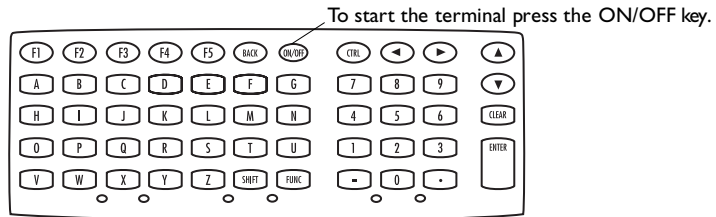

Figure 5-1. The ON/OFF key

Suspending or Turning Off the Terminal

To suspend the terminal, press the ON/OFF key. The terminal appears to turn off. However if you press the ON/OFF key again, the terminal resumes its previous session.

Forcing the Terminal into Suspend

If the terminal does not suspend when you press the ON/OFF key, you can force it into suspend. To do this, press and hold the ON/OFF key for 15 seconds, or until the display goes dark.

Turning the Terminal Off

Normally, you will not turn the terminal off: you will place it into suspend. The terminal only turns off if you have:

- ◆ disconnected the power cable, AND
- ◆ allowed the internal battery to run down.

For more information, see [Installation and the Internal Battery](#) on [page 2-8](#)

Powering On or Off Automatically

Particular applications may cause a VRC 6940 to power on or off automatically. This can be controlled by application programming or default configuration settings. For example, some applications may cause the system to be powered on by:

- ◆ pressing a key other than the ON/OFF key
- ◆ pressing a scanner trigger
- ◆ scheduled, unattended operations such as an overnight communications session

The terminal may also power OFF automatically:

- ◆ as triggered by an application.
- ◆ if it is not used for some period of time determined by settings in the application you are using. For more information, see the documentation for your application.

Resetting a Terminal

You cannot reset the system or applications on a VRC 6940 by pressing the ON/OFF key. When you press the ON/OFF key to suspend a terminal, it maintains its current session and session data. When you turn it on again, it restores the display and continues processing from the point where it was when you powered down.

To reset the system and applications, you must reset the terminal. You may need to reset a terminal if:

- ◆ the power has been forced off.
- ◆ the terminal stops responding to keystrokes or to the ON/OFF key.
- ◆ you need to end the current session and start a new session.

To reset (warm boot) a terminal:

1. Press the ON/OFF key to suspend the terminal. If necessary, force it into suspend by pressing and holding the ON/OFF key for 15 seconds.
2. Press and hold the **SHIFT** and **L** keys.
3. Press and release the ON/OFF key.
4. Release the **SHIFT** and **L** keys.

The terminal restarts and you can log in to an application. Note that if you reset a terminal, you may lose any unsaved data.

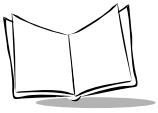

Modifier Keys: SHIFT, FUNC and CTRL

SHIFT, FUNC, and CTRL are modifier keys that generate a special character or function. For example, you might press FUNC, J to brighten the display. To do this:

1. Press and release the FUNC key.
2. Press and release the J.
3. The display brightens and the keyboard returns to normal functioning.

Use modifier keys individually or in combinations. For example:

- ◆ Press **SHIFT** to cause the next alpha key press to generate an upper case letter.
- ◆ Press **FUNC**, and then **CTRL** to generate an ALT function, just like the ALT key on a PC.

The shape of the cursor displayed on the screen indicates the state of the keyboard. [Figure 5-2](#) shows what the standard cursor shapes mean. Note that an application can modify the standard keyboard cursor shape.

Keyboard State	Cursor Character
Unshifted	∨
Shifted	∧
Momentary Shifted	↑
Momentary Unshifted	↓
Control	⌘
Alt	⌥
Function	⌚

Figure 5-2. Keyboard State Cursor Indicators

Key Descriptions

Most of the keys are self-explanatory: alpha keys produce alpha characters, number keys produce numeric characters. [Table 5-1](#) describes special functions performed by specific keys and key sequences. For additional information on keyboard characters and layouts, see [Appendix C, Keyboard Layouts](#).

Table 5-1. Special Key Sequences

Function	Access Method	Description
SHIFT	SHIFT key	After you press SHIFT, the next key you press appears in uppercase (for an alpha key), or as a punctuation mark or symbol (for a number key).
CAPS LOCK	FUNC, L	Places the whole keyboard into Caps Lock mode. Press FUNC, L again to cancel this feature.
FUNC	FUNC key	A function key used to invoke special keyboard functions.
CTRL	CTRL key	A control key used to generate control characters.
ALT	FUNC, CTRL	Generates an Alt key function similar to the one found on a PC. Invokes special keyboard functions.
F1 to F5	F1 to F5 keys	Function keys F1 to F5. Their actions are controlled by application programs.
F6 to F10	FUNC, F1 to FUNC, F5	Function keys F6 to F10. Their actions are controlled by application programs.
ENTER	ENTER key	Usually pressed after typing data or a command.
CLEAR	CLEAR key	This key is controlled by applications. It usually allows you to escape from an application or screen, or clear the data entered in a field.
Darken Screen	FUNC, I	Press to dim the display contrast.
Brighten Screen	FUNC, J	Press to brighten display contrast.

Tips for Using the Keyboard

- ♦ **Press only one key at a time**, unless instructions specifically tell you to press two keys at the same time (*e.g.*, when resetting the terminal). Pressing two or more keys at the same time can cause an error.
- ♦ **Press keys in the correct sequence**. If an applications lists keys in a sequence, press the keys one at a time in the order they are listed.
- ♦ **Auto-repeat feature**. Some applications use the configurable auto-repeat feature of the keyboard. If they do, when you press and hold a key, the character will repeat until you release it.

If a key is pressed immediately after a modifier key, the modifier sequence affects only the first occurrence of the character key. For example, if you press **SHIFT**, and then press and hold **A**, the terminal generates: Aaaaa.

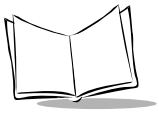

Adjusting Brightness

Task	Key Sequence	Comment
Brighten the screen.	FUNC, J	There are seven levels of brightness. Repeat the key sequence to reach the desired level of brightness.
Darken the screen.	FUNC, I	
Toggle the keyboard backlight on or off.	FUNC, K	Not all terminals include a keyboard backlight option.

Entering Data

To enter data or issue commands, use the terminal's keyboard, or attach a scanner (see [Figure 5-4](#)).

Using the Keyboard

Use the VRC 6940 keyboard to enter data and perform other tasks. The keyboard includes *character* keys (A - Z, 0 - 9), and *modifier* keys, described on [page 5-4](#). When used in combination with one or more modifier keys, each character key can produce more than the usual one or two characters.

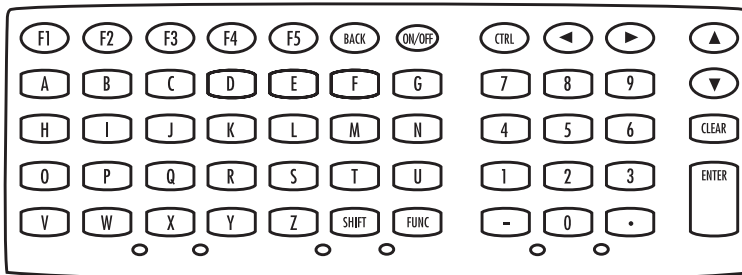

Figure 5-3. VRC 6940 Keyboard

Bar Code Scanning

Attaching an External Bar Code Scanner

1. Press the ON/OFF key to suspend the terminal.
2. Remove the plug cover from the scanner port on the back of the terminal, shown in [Figure 5-4](#).
3. Fit the scanner's connector plug into the connector. Align the red dot on the end of the scanner cable with the red dot on the terminal's scanner connector.
4. Press the ON/OFF key to power the terminal on.

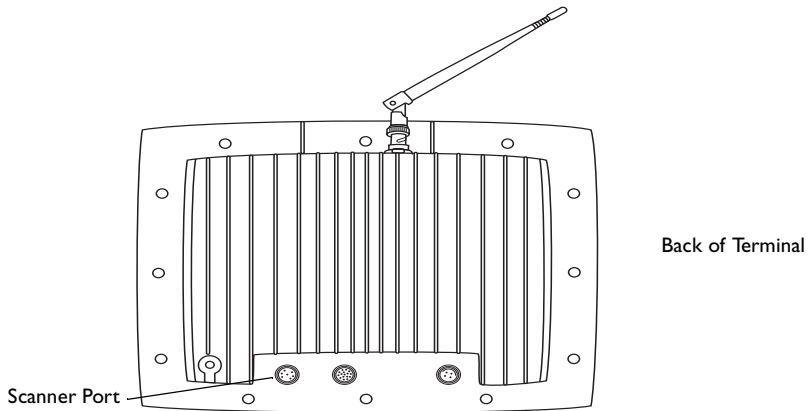
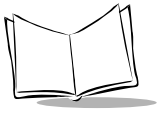

Figure 5-4. ScannerPort

Using a Bar Code Scanner

For information on using a bar code scanner, consult the documentation that came with the scanner.



Moving a Terminal to a Different Power Source

To move a VRC 6940 terminal from one power source to another:

1. Save any data you are working with, and close all applications.
2. Press the **ON/OFF** key to suspend the terminal.
3. Make sure a power source is ready in the new location.
4. Unplug the external power cable from the power connector on the back of the terminal.
5. Remove the terminal from its current mounting.
6. Move the terminal to the new location and mount it.
7. Plug the external power cable into the power connector. Align the red dot on the end of the power cable with the red dot on the terminal's power connector.
8. Press the **ON/OFF** key to restart the terminal.

Command Mode

Command Mode is an operating mode that allows you to use the terminal's built-in system utilities. For example, you can use it to:

- ◆ run Self-Test diagnostics to verify that the hardware is operating properly (see Appendix B)
- ◆ transfer data, hex images or files from a host system to a VRC 6940 (see Chapter 4)

To boot to Command Mode:

1. Press the **ON/OFF** key to suspend the terminal.
2. Press and hold the **A** and **D** keys.
3. Press and release the **ON/OFF** key.
4. Release the **A** and **D** keys.
5. This menu appears on the terminal display:

```
COMMAND MODE
Select function
Self test
```
6. Press **UP** or **DOWN** arrows to display different options. When the option you want appears, press **ENTER** to select it.

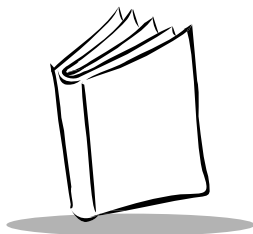

Chapter 6 Troubleshooting

This chapter provides basic problem-solving information for VRC 6940 terminals, including:

- ♦ troubleshooting and error messages
- ♦ warm and cold boot instructions
- ♦ running the Memory Transfer utility to provide more troubleshooting data

Troubleshooting a VRC 6940 Terminal

[Table 6-1](#) describes some problems, their probable causes and some suggested solutions. Some of the situations are discussed further in the pages that follow.

Table 6-1. Troubleshooting VRC 6940 Terminals

Problem	Action
Terminal does not start	Make sure the terminal is connected to a power source. If the external power cable has come unplugged, plug it back in and press the ON/OFF key to restart the terminal. Whether or not your session and data were saved depends on the internal battery and how long the terminal was disconnected. If the internal battery has not been depleted, the session will resume where it left off. See page 2-8 for more information on the internal battery.
	If the terminal uses a vehicle battery as a power source, check the vehicle battery. If it is depleted (dead), replace the vehicle battery.
Terminal suspends suddenly (shuts off)	The terminal suspends if it loses the connection to its main power source. Check the main power supply and power cable. You should be able to restart the terminal when you reconnect to a power source. Whether or not your session and data were saved depends on the internal battery and how long the terminal was disconnected. See page 2-8 for more information on the internal battery.

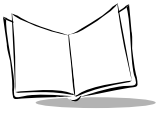

Table 6-1. Troubleshooting VRC 6940 Terminals

Problem	Action
Start-up process fails	The terminal may be out of range of the Access Point (AP) and unable to communicate with the host computer. Move the terminal closer to the AP and try starting it again.
	If one of these messages appears: Boot server doesn't exist. Boot server not configured for this terminal. 1. The bootp server may not be running. Check the bootp server. 2. The radio may not be functioning. Ping test the terminal (see page A-5).
Power fault	This message may appear if the last terminal shutdown was caused by a power failure. The message blinks in place for three seconds, then the terminal starts normally. A power failure can be caused by: <ul style="list-style-type: none">• unplugging the terminal's power cable when the internal battery is not fully charged• removing the vehicle battery• sudden main battery failure If the internal battery is charged, it can maintain session data and your session will resume when you restore the main power source. If the internal battery is depleted the terminal cannot maintain session data, and you may lose unsaved data. See page 2-8 for more information on the internal battery.
Display is blank	The terminal may not be getting power. Make sure the power cable is securely connected to a reliable main power source (vehicle battery or AC) and to the Power Connector on the terminal.
	An application program did not download successfully. Repeat the download process using the procedures described in Transferring and Installing Application Programs on page 4-2.
	The display may be damaged or the video connector may be loose. Return the unit for servicing.
Scanner does not operate	Check to make sure the scanner is properly connected to the terminal. Re-connect the scanner and then reboot the terminal. Check the documentation for the scanner you are using.

Table 6-1. Troubleshooting VRC 6940 Terminals

Problem	Action
Scanner laser works but does not read bar codes	The bar code may not be legible. Try scanning another label of the same product, or type in the data manually.
	The scanner window may be dirty or severely scratched. If it is dirty, clean it with a soft, dry cloth moistened with an ammonia-based glass cleaner. If the scanner window is badly scratched, replace the scanner.
	The scanner may not be programmed or may be programmed incorrectly. Consult the reference guide that came with the scanner for configuration information.
Application does not respond	This can happen if the terminal cannot connect to the Access Point (AP). If the terminal cannot connect to the AP, applications may continue to function until they need to transmit to the AP, then they simply stop responding.
	The terminal may be out of range of the AP. Move the terminal to a location closer to an AP and then try to restart it. See page 6-4 for more information.
	The host computer may be down. Check the host computer.

Error Messages

The terminals use ERR3000.SYS, a factory-installed program that displays error messages. Messages blink in place on the display screen for three seconds. The terminal beeps while the message is showing. Then the system returns to its previous status. [Table 6-2](#) lists some sample messages. Application programs can change or disable messages. For more information, refer to the *Series 3000 Application Programmer's Guide* (p/n 70-16308-XX).

Table 6-2. Error Messages

Message	Explanation
Double Key Error	You have pressed two keys at the same time. This message does not appear for the warm, cold, and Command Mode boot sequences described on page 6-5 .
Too Many Keys	Three or more keys have been pressed at the same time.
Power Fault	The last power off was caused by a power failure. This occurs, for example, if power suddenly fails or is disconnected. For more information, see Table 6-1 .

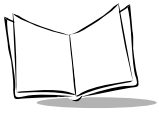

Scanning Problems

Scanning may not work correctly if:

- ◆ the scanner has not been configured, or is configured incorrectly
- ◆ a contact wand scanner has been moved over the bar code too slowly, too quickly or at an uneven speed
- ◆ a contact wand scanner has been moved diagonally across the bar code
- ◆ a bar code scanner was held at the wrong angle or distance from the bar code
- ◆ the scanner window is dirty or severely scratched
- ◆ labels are smudged
- ◆ labels are too dark, too light, or have poor color contrast
- ◆ labels have highly reflective surfaces or coatings
- ◆ labels are torn, folded, or wrinkled

For more information, consult the documentation for your scanner.

Terminal Stops Responding

This section describes what to do if a VRC 6940 terminal stops responding during a session.

1. Make Sure You are Within Range of an Access Point

If you have moved the terminal during use, make sure you are still within range of an Access Point (AP). Move back to a previous working location or to a location closer to the AP to see if it responds. See [page 6-5](#) for information on checking Radio Connection status.

2. Force the Terminal into Suspend

If you are within range of an AP, and the terminal is not responding, force the terminal into suspend and then restart it using the instructions below. To force the terminal into suspend without resetting it, press and hold the **ON/OFF** key for 15 seconds.

3. Restart After Forcing a Suspend

If you have forced the terminal into suspend, *do not use the ON/OFF key to restart the terminal*, as this causes the program to resume where it left off, trying to perform the same unsuccessful operation.

1. First, try to start the terminal with a warm boot, described on [page 6-5](#).
2. If a warm boot does not correct the problem, try a cold boot, described on [page 6-6](#).
3. If a cold boot does not correct the problem, try to boot into Command Mode, described on [page 6-7](#).
4. If you cannot boot into Command Mode, contact Symbol Technical Support.

Booting a VRC 6940

Warm Boot

A warm boot resets the operating system and software while preserving the program and data that may be on the RAM disk. To perform a warm boot:

1. Press the **ON/OFF** key to suspend the terminal.
2. Press and hold the **SHIFT** and **L** keys.
3. Press and release the **ON/OFF** key.
4. Release the **SHIFT** and **L** keys.

The VRC 6940 displays copyright, RAM size, expanded memory size, and other start-up information, depending on the system's configuration.

If a warm boot successfully solves the problem, then the problem may have been caused by:

- ◆ an error in the application program
- ◆ a temporary communications problem in the network

Consider going back into the application that was running when the problem occurred, and try to recreate the problem. If there are network problems during the boot process, the terminal may display a message similar to this one:

NOT ASSOCIATED

and a DOS prompt appears. From here, use the DIAG24 software to run ping tests or identify potential radio problems on the network. See [page A-5](#).

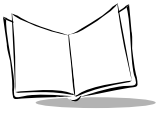

Cold Boot

A cold boot fully resets the system and clears memory, *including the RAM disk*. It resets the software and allows you to restart applications. Any unsaved RAM data will be lost. Programs and data that have been stored in memory or on the RAM Disk are deleted. Non-Volatile Memory (NVM) is not affected. To perform a cold boot:

1. Press the **ON/OFF** key to suspend the terminal.
2. Press and hold the **ENTER**, **F4** and **F1** keys.
3. Press and release the **ON/OFF** key.
4. Release the **ENTER**, **F4** and **F1** keys.

The VRC 6940 displays a copyright message, amount of RAM, and amount of expanded memory. Other messages are displayed as well, varying with the system configuration.

As the terminal boots, watch for cold boot failure messages. You may need to reinstall a device driver. See *Cold Boot Failure Messages*, below.

5. Follow the instructions in [Chapter 4, *Installing Software*](#) to reinstall software.

Caution

The cold boot procedure erases all data and programs residing on the RAM Disk. All contents of the RAM disk are lost.

If you have had problems starting the terminal, and cold booting (clearing memory) allows you to boot the terminal, then something in memory was causing the problem. Perform a Memory Transfer (see [page 6-8](#)) so that a programmer can perform application-specific troubleshooting. Then install the correct version of the software as described on [page 4-2](#).

Cold Boot Failure Messages

During a cold boot, the system briefly displays a status line for each driver as it loads, in this format:

```
0: Drivervname #.##
```

The line shows a status value, usually 0, followed by the driver's name and version number. If the system halts at one of these lines and displays a status value other than 0, the displayed device driver failed to load properly. If such a failure occurs, the driver may need to be reinstalled. Contact Symbol Technical Support.

Command Mode

To boot to Command Mode:

1. Press the **ON/OFF** key to suspend the terminal.
2. Press and hold the **A** and **D** keys.
3. Press and release the **ON/OFF** key.
4. Release the **A** and **D** keys.

This terminal displays this screen:

```
COMMAND MODE

Select Function
Self Test
```

Figure 6-1. Command Mode screen

5. Use the **UP** or **DOWN** arrows to display other options in place of Self Test. When the option you want appears, press **ENTER** to select it.

If warm or cold booting do not clear your problem, but you can boot to Command Mode, the problem may be:

- ◆ BIOS and hardware problems: to check the BIOS and hardware, use the Self Test function to check the system hardware (described on page [A-2](#)). If there is a hardware problem, contact Symbol Technical Support.
- ◆ Application program error: if system hardware is running properly, check for an application error. Perform a Memory Transfer (described on page [6-8](#)) so that a programmer can perform application-specific troubleshooting. Then install the correct version of the software as described on page [4-2](#).

If Rebooting Fails

1. Re-install software following the procedures described in [Chapter 4, Installing Software](#).
2. Contact your authorized Symbol Support representative or Technical Support Services.

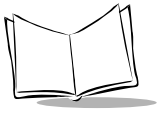

Memory Transfer Analyzer (MTA) Utility

The VRC 6940 has a Memory Transfer Analyzer (MTA) utility for application troubleshooting. It runs from Command Mode. Programmers can analyze applications using RCVHEX.EXE on a PC and the MTA on the VRC 6940. For more information on RCVHEX.EXE, see the *Series 3000 Application Programmer's Guide* (p/n 70-16308-XX).

The MTA transmits data from a VRC 6940 to the Host PC. You may transfer all of the memory, or a selected range.

Transferring Memory

To transfer memory from a VRC 6940 to a Host PC you will need:

- ◆ a Host PC running the RCVHEX.EXE application
- ◆ a VRC 6940 running the MTA
- ◆ a null modem cable

Note: *Always suspend a VRC 6940 terminal before attaching or removing cables or adapters.*

To conduct the Memory Transfer:

1. Start with the VRC 6940 terminal in suspend.
2. Attach the null modem cable.
 - a. Remove the RS-232 plug cover from the VRC 6940 terminal and plug the male connector into it.
 - b. Attach the female connector to the Host PC (see [Figure 4-1 on page 4-2](#)), using an adapter if necessary.
3. On the Host PC, exit to a DOS prompt and start the RCVHEX program. For an example, see [Figure 6-2](#).
 - a. For a filename, use an existing file, or create one by supplying the filename in the command. The example in [Figure 6-2](#) shows a filename of `memory.txt`.
 - b. Set the baud rate to match the baud rate for the VRC 6940.
 - c. Leave Data Bits and Parity set to their defaults.
 - d. Set the COM port as appropriate for your Host PC.
 - e. Press ENTER to send the command.

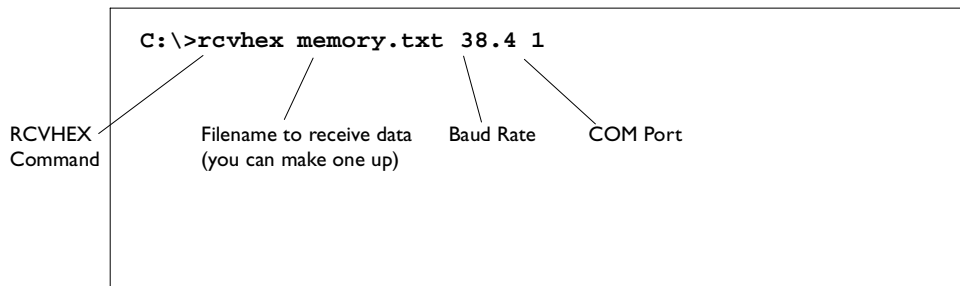

Figure 6-2. Setting up to Receive a Memory Transfer

4. Boot the VRC 6940 to Command Mode:
 - a. Press and hold the **A** and **D** keys.
 - b. Press and release the **ON/OFF** key.
 - c. Release the **A** and **D** keys.
 - d. The terminal boots to the function selector screen in Command Mode, as shown in [Figure 6-3](#). Press **UP** or **DOWN** arrows to scroll through the options.

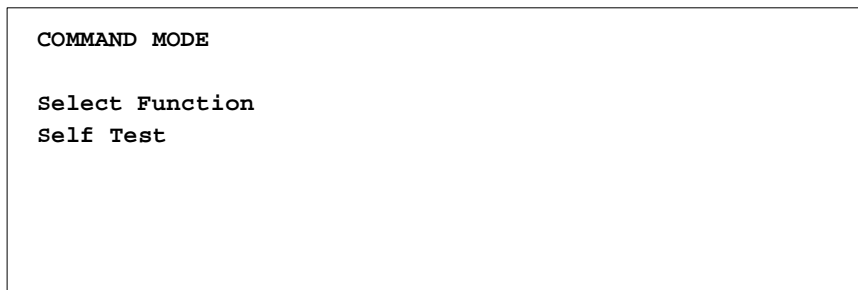
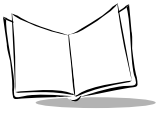

Figure 6-3. Command Mode Screen

5. When the Memory Transfer option appears, press **ENTER**.
6. The systems displays this message:

```
Checking Memory
Please Wait
```



7. Select a range of RAM to transfer. Press the **UP** and **DOWN** arrows to select an option (All, Range or None) and press **ENTER**. If you select **All**, the program skips to the summary screen. Continue at step 10.



Figure 6-4. Selecting a Range of Memory to Transfer

8. Specify a range of RAM by setting Start and End addresses. Use **LEFT** and **RIGHT** arrow keys to move the cursor to a digit that you want to set. Use **UP** and **DOWN** arrow keys to change the value. When the correct range appears, press **ENTER**.



Figure 6-5. Selecting a Range of RAM to Transfer

9. Specify a range of NVM to transfer. Use the arrow keys to select All or None, and then press **ENTER**.



Figure 6-6. Selecting a Range of NVM to Transfer

10. If the VRC 6940 has EMS, use the arrow keys to specify the range to transfer. This prompt only appears if EMS is installed. Then press ENTER.

```
EMS

Use arrow keys
Start  End
```

Figure 6-7. Selecting a Range of EMS to Transfer

11. The terminal displays the ranges you selected. Verify that they are correct. [Figure 6-8](#) shows an example of what you might see. If the values are correct, press **ENTER**. If the values are not correct, press **CLEAR** to clear the fields, then select new values.

```
RAM 0000 9FFF
NVM B135 DFFF
EMS None
Correct? <ENT>
```

Figure 6-8. Verifying Memory Transfer Settings

12. Next, the VRC 6940 prompts you to set communications parameters. Use **UP** or **DOWN** arrows to select communications settings. The defaults are 9600 bps, 7 data bits and odd parity. Xon/xoff flow control may be necessary at 38400 bps. Select the parameters so that they match those used by RCVHEX on the Host PC.

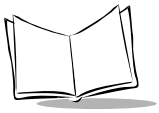

13. Start the Memory Transfer. Make sure the Host PC is ready to receive data, and then press **ENTER** on the VRC 6940. While memory data is transferring, the VRC 6940 displays a report of the 1 KB range being transferred. The screen updates for every 1024 bytes (1 KB) of memory.

```
Memory Transfer
Sending: 0D40
```

Figure 6-9. MemoryTransfer Status Screen

14. Check the transmission results. When the transmission has completed, a status screen appears.

A status of 0000 (all zeros) indicates a successful transfer; any other value means that the transfer failed. If the transfer failed, check the Memory Transfer and communications settings and try the procedure again.

```
Memory Transfer
Status: 0000
```

Figure 6-10. Status Screen when MemoryTransfer is Complete

15. Press **CLEAR** to return to the Command Mode main menu.

Technical Support Contacts

If you cannot solve your technical problem with the information in this manual, contact Symbol Technical Support for assistance. Refer to the section, *About This Manual*, for Symbol Support telephone numbers.

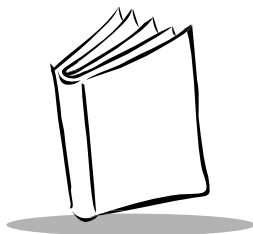

Chapter 7 Maintenance

A VRC 6940 terminal requires minimal maintenance. However, as with any electronic device, proper use and care will increase its life. This chapter provides basic maintenance instructions including:

- ◆ maintaining the internal battery
- ◆ storing the terminal
- ◆ cleaning

Maintaining the Internal Battery

The VRC 6940 has an internal NiMh battery designed to maintain session data while the terminal is disconnected from its main power supply (*e.g.*, while it is being moved from one power source to another). You cannot use the internal battery to operate the terminal. If you remove or disconnect the main power supply (vehicle battery or other external power source), the terminal shuts off and cannot be started again until you reconnect the external power.

As long as the battery is charged, the terminal resumes from where it left off when you reconnect the main power supply. However, if the internal battery is not fully charged, the terminal may lose any unsaved data when you unplug it from the main power supply.

The first time you use a terminal, connect it to a power source and turn it on to make sure that it is working. If the main power supply is not stable, there may be power interruptions that cause the terminal to reset itself during its first few hours of operation. If the terminal resets itself, you may lose unsaved data. To avoid this, we recommend that you plug in the terminal and allow it to charge for a minimum of two hours before using it.

It takes 48 hours to fully charge the internal battery. A fully charged internal battery can maintain data for up to 72 hours if the unit is disconnected from its main power supply. This time is reduced if the radio maintains continuous communication with a host.

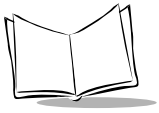

Storing the Terminal

If you are storing the terminal, keep the internal battery charged by connecting the terminal to a main power supply with the terminal in suspend.

If you store the terminal with no main power supply, the internal battery runs down. Before you can use the terminal, you will need to charge the internal battery. See [Maintaining the Internal Battery](#) on page 7-1.

Cleaning

Clean a VRC 6940 regularly to prevent long-term build up of dirt and grime on the keys, terminal case, and display.

Washing the Terminal

To wash the terminal case and keyboard, use a clean, soft cloth dampened with a mild cleaner (for example, soap and water).

The terminal is water-resistant; you do not have to remove it when you send a vehicle through a car wash, or clean it using high-pressure hoses. Use a mild soap. Do not spray wax onto the terminal. When washing is complete, wipe the terminal off with a clean, dry cloth.

Note: If the terminal will be used in a freezer, dry it completely after washing.

Washing the Terminal Display

Clean the terminal's display screen with a regular ammonia-based glass cleaner. Spray it on a clean, soft, lint-free cloth, and then clean the display. Do not use paper products or rough cleaning towels because they can scratch the display screen.

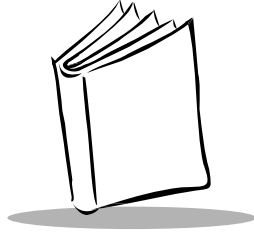

Appendix A Utilities and Diagnostic Tests

VRC 6940 terminals include two sets of diagnostic applications:

- ◆ Self Test diagnostics let you view current hardware settings and run basic diagnostic tests. See [page A-2](#) for instructions on running the Self Tests.
- ◆ DIAG24 diagnostics that allow you to ping the network and troubleshoot possible radio problems. See [page A-12](#) for information on running the DIAG24 utility.

The terminals also include these two utilities:

- ◆ the CFG24 Configurator utility configures Spectrum24 radio communications. Chapter 3 describes how to configure the Spectrum24 radio.
- ◆ the Flash utility lets you copy, delete or rename flash disk files.

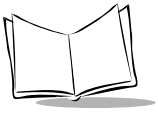

VRC 6940 Self Tests

Run the Self Tests if you suspect a problem with the terminal's hardware. They test the terminal's hardware components to make sure they are working correctly.

To run the Self Tests, first boot to Command Mode:

1. Suspend the terminal.
2. Press and hold the **A** and **D** keys.
3. Press and release the **ON/OFF** key.
4. Release the **A** and **D** keys. The terminal displays the screen shown here:

```
COMMAND MODE

Select Function
Self Test
```

Figure A-1. The Command Mode Menu

5. Press **ENTER** to display the Self Test menu, as shown in [Figure A-2](#).

```
COMMAND MODE

Self Test
Config Screen 1
```

Figure A-2. The Self Test Menu

6. Use **UP** or **DOWN** arrow keys to display the names of the Self Tests. Then press **ENTER** to select and run a test. Config Screen 1 lets you run a keyboard test that requires you to press keys. The other tests all run automatically. [Table A-1](#) summarizes Self Test details.

7. To end a SelfTest and return to the SelfTest menu, press **CLEAR**. To return to the Command Mode function menu, press **CLEAR** again.

Table A-1. Self Test Summary

Self Test	What You Should See	Comments
Config Screen 1	Config Screen 1 Vers: 6940 1.10-00 Time: 09:45:23 Date: 01-01-1980-2 Nicd: Good Main: Good Power Src: Charger COM1: S1 10100 COM2: None	<ul style="list-style-type: none"> • Displays the terminal type and version, time, date, main and backup battery condition, current power source, and serial port status. • Make sure the values shown for Vers, Nicd, Power Src, and COM1 on the terminal match those shown here. • Allows you to perform the keyboard test described on page A-4. • Press CLEAR to return to the Self Test menu.
Config Screen 2	Config Screen 2 LCD: 0 LCD TYPE:08 KBD ID:00 GA REV:00 Wake cause Cmd Mode	<ul style="list-style-type: none"> • Reports keyboard and display information. • Make sure the values for LCD, LCD TYPE and KBD ID on the terminal match those shown here. • Press CLEAR to return to the Self Test menu.
Memory Screen	When the test completes, these results appear: Memory Screen 2 ROM CRC: 0 NVM CRC: 10 RAM:0640K Pass S EMS:0000K None	<ul style="list-style-type: none"> • Tests ROM, RAM and EMS (Expanded) memory, and reports the amount of RAM and EMS. • Takes about one minute to complete. • Make sure the values shown for CRC match those shown here. • The RAM test result must be Pass. • Press CLEAR to return to the Self Test menu.
Fill Screen	Test Pattern	<ul style="list-style-type: none"> • The entire screen fills with a test pattern: make sure that it all displays clearly. • Press CLEAR to return to the Self Test menu.
Set RTC Screen	Set RTC Screen Time: 01:59:13 Date: 01-01-1980-2	<ul style="list-style-type: none"> • Lets you set the real-time clock (time and date). • UP/DOWN arrows change the value at the cursor. LEFT/RIGHT arrows move the cursor. • Set the time and press ENTER. • Set the date and press ENTER. Format: MM-DD-YYYY • Press CLEAR to return to the Self Test menu.

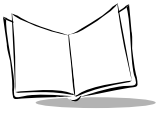

Keyboard Test

The Config Screen 1 Self Test lets you test any keys *except* **CLEAR** and the **ON/OFF** key. When you press a key, the program displays the corresponding key code to the right of the Config Screen 1 test name on the top line. [Table A-2](#) shows the codes for each key.

Table A-2. 54-Key Keyboard Test Codes

Key	Code	Key	Code	Key	Code
F1	00	7	18	R	36
F2	01	8	19	S	37
F3	02	9	20	T	38
F4	03	Ctrl	21	U	39
F5	04	H	22	1	40
Left arrow	5	I	23	2	41
Right arrow	6	J	24	3	42
Up arrow	7	K	25	V	43
Down arrow	8	L	26	W	44
Func	9	M	27	X	45
On/Off		N	28	Y	46
A	11	4	29	Z	47
B	12	5	30	Shift	48
C	13	6	31	Backspace	49
D	14	Clear	39 (clears screen)	_	50
E	15	O	33	0	51
F	16	P	34	.	52
G	17	Q	35	Enter	53

DIAG24 Diagnostics Utility

The DIAG24 Diagnostics utility lets you ping an Access Point (AP) on the network as a way to identify possible problems with wireless network communication. DIAG24 has two options, with the same series of set-up menus for both options.

DIAG24 Setup

To run the utility and set up for the tests:

1. Boot the terminal to a DOS prompt. The DOS prompt appears if you boot the terminal and it cannot connect to the network.
2. At the DOS prompt, type `DIAG24` and press `ENTER` to display the screen shown in [Figure A-3](#).
3. Press `1` to select the AP Ping Test or `2` to select Field Diagnostics. See [Table A-3](#) for test option descriptions.

```
DIAG24 ver x.xx
1. AP Ping Test
2. Field Diagnostics
Select [1-2 or `Q`]
```

Figure A-3. The DIAG24 menu

Table A-3. DIAG24 Diagnostic Test Details

Test Name	Purpose	What it Checks
AP Ping Test	Runs a series of ping tests that are not re-tried on transmission errors. This test is intrusive, as pings are sent as fast as possible.	Cnt: ping test count. Err: number of errors (lost packets). AP: ID number of the Access Point being pinged. RS: Radio Signal Strength Indicator (RSSI) value. The RSSI range is 0 - 99. RSSI should be over 25 for a reliable connection.
Field Diagnostics	Identifies potential radio problems. It determines whether or not a communication problem is in the radio portion of the network.	Cnt: ping test count. Err: number of errors (lost packets). Rty: number of retries. ms: number of milliseconds for the ping test. AP: ID number of the Access Point being pinged.

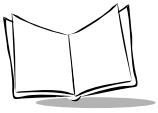

Note: *DIAG24 uses a message file (msg.msg) that it reads from the same drive and directory as the DIAG24 software. If you see corrupted screens, the message file may be missing.*

4. Select a Roaming Mode. If you want the terminal to ping an AP, but roam between APs as you move around, select `Roaming Enabled`. If you want to ping a specific AP, select that AP identifier from the list. If more APs are in range than can fit on one screen, then the last selection will be `More`. Selecting this will present more available APs for selection.

[Figure A-4](#) shows a *Roaming Enabled* option, followed by a list of AP identifiers. For each AP identifier, `bb` represents the AP identifier (or BSS identifier) and `eeeeeeeeeeee` represents the 48-bit MAC address of the AP in hexadecimal notation.

```
<Test Mode>
1. Roaming Enabled
2. bb--eeeeeeeeeeee
3. bb--eeeeeeeeeeee
4. bb--eeeeeeeeeeee
....
n. bb--eeeeeeeeeeee

Select[1-n or 'Q']:
```

Figure A-4. Selecting a Roaming Mode

5. Press 1, 2 or 3 to select the ping message size:

```
<Test Mode>
MESSAGE SIZE
1. 100 bytes
2. 256 bytes
3. 512 bytes
Select[1-3 or 'Q']:
```

Figure A-5. Selecting Ping Message Size

6. Press 1, 2, 3 or 4 to select the number of pings you want to perform:

```
<Test Mode>
NUMBER OF PINGS
1. 100 pings
2. 500 pings
3. 1000 pings
4. Non-stop
Select[1-4 or 'Q']:
```

Figure A-6. Selecting the Number of Pings

7. Press 1 or 2 to determine whether or not errors will cause the terminal to beep:

```
<Test Mode>
BEEP MODE
1. Beep on error
2. Silent

Select[1-2 or 'Q']:
```

Figure A-7. Selecting the Number of Pings

After you select the Beep Mode, the test starts (AP Ping Test or Field Diagnostics test).

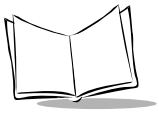

Ping Test

During the AP Ping Test the terminal displays and updates this screen:

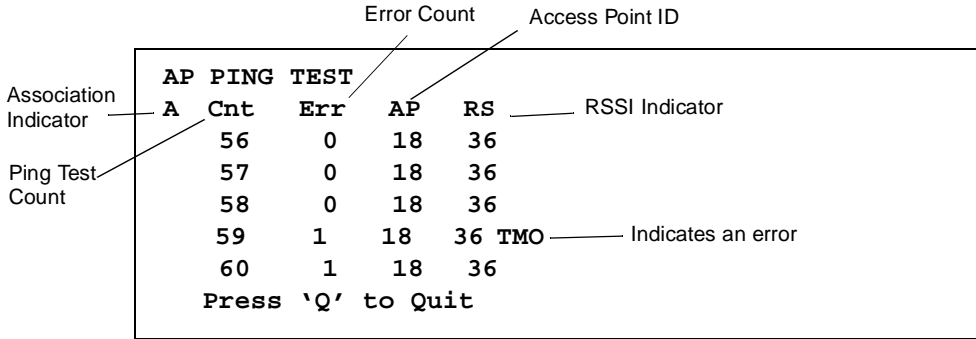

Figure A-8. The AP Ping Test

Table A-4 describes the field contents. The reports wrap so that the last five message reports are visible. If you selected non-stop mode during setup, and the Ping Test or Error count fields overflow, then the first detail line shows the most significant digits of the count, prefixed with an asterisk.

Table A-4. AP Ping Test Field Details

Field	Description
Association Indicator	A — the radio is associating with an AP. U — the radio is not associating with an AP.
Ping Test Count	Displays the number of each test as it runs.
Error Count	Displays the cumulative number of errors that have occurred.
Access Point ID	The ID of the AP with which the terminal is associating.
RSSI Indicator	The Radio Signal Strength Indicator (RSSI) value. The RSSI range is 0 - 99. RSSI should be over 25 for a reliable connection.

When the test stops, the terminal displays a summary screen:

```
AP PING TEST
Total secs = 7.4
RF Secs = 6.7
Pings = 100
Packet size = 100
Timeouts = 4

[R]epeat or [Q]uit
```

Figure A-9. Sample AP Ping Test Results Screen

The summary shows:

- ◆ the elapsed time of the test
- ◆ total pings transmitted
- ◆ packet size used
- ◆ retry count
- ◆ number of timeouts

To repeat the test with the same parameters, press **R**. Press **Q** or **CLEAR** to end the test and return to the **DIAG24** menu.

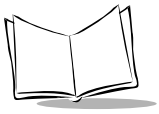

Field Diagnostic Test

During the Field Diagnostic Test the terminal displays and updates this screen:

	AP	PING	TEST	Error Count	Retry Count	Timer	Access Point ID
Association Indicator	A	Cnt	Err	Rty	ms	AP	
		56	0	0	165	18	
Ping Test Count		57	0	0	55	18	
		58	1	1	TMO	18	
		59	1	0	220	18	
		60	1	0	58	18	
		Press 'Q' to Quit					

Figure A-10. The Field DiagnosticTest

Table A-5 describes the field contents. The reports wrap so that the last five message reports are visible. If you selected non-stop mode during setup, and the Ping Test or Error count fields overflow, then the first detail line shows the most significant digits of the count, prefixed with an asterisk.

Table A-5. Field Diagnostic Test Field Details

Field	Description
Association Indicator	A — the radio is associating with an AP. U — the radio is not associating with an AP.
Ping Test Count	Displays the number of each test as it runs.
Error Count	Displays the cumulative number of errors that have occurred.
Retry Count	The retry count for this message.
Timer	The round-trip time in milliseconds, or an indication of error type, if there was an error.
Access Point ID	The ID of the AP with which the terminal is associating.

When the test stops, the terminal displays a summary screen:

```
FIELD DIAGNOSTICS
Total secs = 8.2
RF Secs = 4.9
Pings = 100
Packet size = 100
Timeouts = 4

[R]epeat or [Q]uit
```

Figure A-11. The Field Diagnostic Test Results Screen

The summary shows:

- ◆ the elapsed time of the test
- ◆ total pings transmitted
- ◆ packet size used
- ◆ retry count
- ◆ number of timeouts

To repeat the test with the same parameters, press **R**. Press **Q** or **CLEAR** to end the test and return to the **DIAG24** menu.

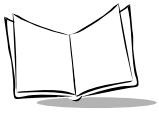

CFG24 Configurator Utility

The CFG24 Spectrum24 Configurator utility lets you:

- ◆ configure radio communication parameters
- ◆ initialize a configuration stored in the NET.CFG file in the terminal's current directory

CFG24 updates NET.CFG settings every time it runs. It saves parameter settings to the radio flash storage initialization area, and then checks for an association between the terminal and an Access Point (AP).

Note: *The Spectrum24 DOS ODI driver must be installed before you use CFG24.*

Starting the Utility

There are two ways to start the utility:

1. The first time you power up a VRC 6940 terminal the terminal loads essential utilities and system drivers and displays the CFG24 Configurator utility as shown in [Figure A-12](#).
2. Alternate method: go to a DOS prompt and type: `CFG24 [-I]`. How you get to a DOS prompt depends on what applications have been loaded onto the terminal, and how they have been programmed. The DOS prompt may also appear if you boot the terminal and it cannot connect to the network.

The optional parameter `[-I]` initializes the current configuration. If you are configuring the terminal for the first time, this option starts the utility and displays the Configurator menu.

Initializing the Radio

When you use the `[-I]` parameter, the utility initializes the radio using the settings currently stored in NET.CFG. Default settings:

```
NET_ID: 101
Terminal IP address: 10.x.y.z (x, y, and z are the last 3 bytes of the IEEE address)
Subnet mask: 255.0.0.0
Default router: 0.0.0.0
```

The Configurator Menu

The Configurator menu appears the first time you start the terminal, or if you launch the CFG24 program without parameters. [Figure A-12](#) shows Configurator menu options. Note that some terminals do not allow you to change the Subnet Mask, Default Router, and Terminal IP addresses.

If you are using Spectrum24 802.11 protocol-based software, the menu shows the ESS ID option. For Spectrum24 Spring protocol-based software, the menu shows Net ID.

Configuration Note: Navigating the Menus

To navigate through the menus:

- Press UP or DOWN arrow keys to scroll through menu options.
- To select, highlight the menu option you want, then press ENTER. A highlighted option shows up in reverse video.
- To erase part of a reverse video, BACK.
- To return to a previous menu press CLEAR.
- To exit to a DOS prompt, return to the Configurator menu and press CLEAR.

```
CONFIGURATOR X.XX
View config
ESS Id
Subnet Mask
Default Router
MU IP Address
Diversity
↑↓ CLR, Enter
```

Figure A-12. The CFG24 Configurator Menu

View Config Parameters

The *View config* option shows the terminal's IEEE address, IP address, firmware version number, and ESS ID or Net ID. To display the existing configuration parameters:

1. Select *View config*. [Figure A-13](#) shows an example of the screen that appears.
2. Press CLEAR or ENTER to return to the Configurator menu.

```
VIEW CONFIG
Terminal IEEE addr
00:A0:F8:28:78:EF
MU IP Address
0.0.0.0
FW: V3.29 981116
Net ID=101
CLR, Enter
```

Figure A-13. Viewing Configuration Parameters

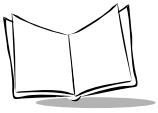

ESS ID or Net ID

An ESS or Net ID identifies a radio network and differentiates between radio networks. All equipment on one network must use the same ESS or Net ID. Spectrum24 terminals can support the Spectrum24 802.11 or Spectrum24 Spring protocols. The menu displays the ESS ID or Net ID, depending on which protocol you are using.

Terminals using Spectrum24 with the 802.11 protocol require an ES SID. The ES SID is a 32-character alphanumeric value. Terminals using Spectrum24 with the Spring proprietary network protocol require a Net ID. The Net ID is a three-character hexadecimal value.

To configure a terminal's ESS ID or NET ID:

1. Select *ESS ID* or *Net ID*. [Figure A-14](#) shows the entry for a Spring-based terminal.
2. Erase all or part of the entry, and type a new value from 100 to 1FE.
3. Press **CLEAR** or **ENTER** to return to the Configurator menu.

```
NET ID
Enter Net Id:
150

BkSp, CLR, Enter
```

Figure A-14. Setting a NET ID

Subnet Mask

To configure the Subnet Mask:

1. Select *Subnet Mask* to display the screen shown in [Figure A-15](#).
2. Erase all or part of the entry.
3. Type an IP address in decimal using the *ddd.ddd.ddd.ddd* format.
4. Press **CLEAR** or **ENTER** to return to the main menu.

```
SUBNET MASK
Enter SN Mask:
255.255.255.0

BkSp, CLR, Enter
```

Figure A-15. Setting a Subnet Mask

Default Router

The Default Router address is the node address that receives all packets destined for remote networks. To configure the Default Router:

1. Select *Default Router* to display the screen shown in [Figure A-16](#).
2. Erase all or part of the entry.
3. Type an IP address in decimal using the *ddd.ddd.ddd.ddd* format.
4. Press CLEAR or ENTER to return to the main menu.

```
DEFAULT ROUTER
Enter D Router:
0.0.0.0

BkSp, CLR, Enter
```

Figure A-16. Setting a Default Router

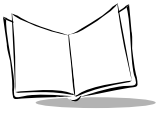

Terminal IP Address

If a boot server is not allocating IP addresses, you can set a Terminal IP Address:

1. Select *MU IP Address* to display the screen shown in [Figure A-17](#).
2. Erase all or part of the entry.
3. Type an IP address in decimal using the *ddd.ddd.ddd.ddd* format.
4. Press **CLEAR** or **ENTER** to return to the main menu.

```
MU IP ADDRESS
Enter IP address:
0.0.0.0

BkSp, CLR, Enter
```

Figure A-17. Setting a Terminal IP Address

Diversity

To configure Diversity:

1. Select *Diversity* to display the screen shown in [Figure A-18](#).
2. Use the **UP** or **DOWN** arrows to select an option. Always set Diversity set to *No* on VRC 6940 terminals with only one antenna.
3. Press **CLEAR** or **ENTER** to return to the main menu.

```
DIVERSITY
2 antennas (Y/N)
No

BkSp, CLR, Enter
```

Figure A-18. Configuring Diversity

MU Sleep Mode

If you set MU Sleep Mode *On*, the radio stays powered on when the rest of the terminal powers down because of inactivity. You can wake the terminal by sending a message directly to it, but broadcast messages will not wake it. If you set the switch *Off*, the radio powers off if the rest of the terminal powers down because of inactivity. The default setting is *On*. To configure MU Sleep Mode:

1. Select MU Sleep Mode to display the screen shown in [Figure A-19](#).
2. Use the UP or DOWN arrow keys to select *On* or *Off*.
3. Press CLEAR or ENTER to return to the main menu.

```
MU SLEEP MODE
Radio State:
On

BkSp, CLR, Enter
```

Figure A-19. Setting Sleep Mode

Boot Mode

This option determines what network communication parameters the terminal will use when it boots. To configure Boot Mode:

1. Select *Boot Mode* to display the screen shown in [Figure A-20](#).
2. Use the UP or DOWN arrow keys to select *Boot*, *DHCP*, or *Manual Entry* options.
3. Press CLEAR or ENTER to return to the main menu.

```
BOOT MODE
Get IP from:
Manual Entry

BkSp, CLR, Enter
```

Figure A-20. Setting Boot Mode

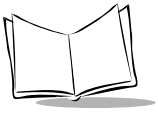

Boot Mode Options:

Boot	Broadcasts a TCP/IP BOOTP request to the network. If they have been configured to do so, boot servers on the network send a response. The terminal accepts the first valid response it receives, which contains a terminal IP address and other network parameters that override any parameters entered through CFG24.
DHCP	Uses the same process as the <i>Boot</i> option but uses the Dynamic Host Configuration Protocol.
Manual Entry	The terminal does not broadcast any configuration messages to the network. It uses the current network parameter values (saved in the radio flash) to connect to the network.

Power Management

If power management is set to *PSP* (the default), the radio only powers up if there is traffic on the network. Because the radio is not always in a ready state when a message is sent to it, *PSP* mode slows response times. If power management is set to *CAM*, the radio is always ready to receive. To configure Power Management:

1. Select *Pwr Management* to display the screen shown in [Figure A-21](#).
2. Use the UP or DOWN arrow keys to select *PSP* or *CAM*, then press ENTER.
3. Press CLEAR or ENTER to return to the main menu.

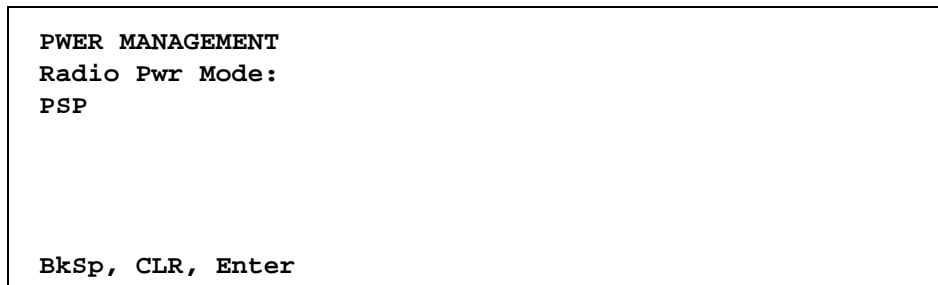

Figure A-21. Configuring Power Management

Buffers

To configure the terminal Buffers:

1. Select *Buffers* to display the screen shown in [Figure A-22](#).
2. Use the UP or DOWN arrow keys to select 4, 8, or 12, then press ENTER.
3. Press CLEAR or ENTER to return to the main menu.

```
BUFFERS
Enter Buf Cnt:
8

BkSp, CLR, Enter
```

Figure A-22. Configuring the Buffers

Re-Transmit Delay

To configure the Re-Transmit Delay:

1. Select *ReXmit Delay* to display the screen shown in [Figure A-23](#).
2. Use the UP or DOWN arrow keys to select *short* or *long*, then press ENTER.
3. Press CLEAR or ENTER to return to the main menu.

```
REXMIT DELAY
Enter Delay:
short

BkSp, CLR, Enter
```

Figure A-23. Setting the Re-Transmit Delay

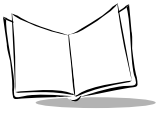

Rate Control

To configure the Rate Control:

1. Select *Rate Control* to display the screen shown in [Figure A-24](#).
2. Use the UP or DOWN arrow keys to select *1Mb only*, *2Mb only*, or *1Mb and 2 Mb* options, then press ENTER. For Spring protocol, *1Mb* is the only choice.

```
RATE CONTROL
TX Rate:
1 MB only

BkSp, CLR, Enter
```

Figure A-24. Setting the Rate Control

Scanner/RF Operation

To configure the Scanner/RF operation:

1. Select *Scan/RF Op* to display the screen shown in [Figure A-24](#).
2. Use the UP or DOWN arrow keys to select *Concurrent Op* or *Scan stops RF*. Then press ENTER.

If you want an attached scanner and the radio to both operate at the same time, select *Concurrent Op*. If you want radio operation to be suspended during a scan, select *Scan stops RF*.

```
SCAN/RF OP
Select Op Mode:
Concurrent Op

BkSp, CLR, Enter
```

Figure A-25. Setting Scanner/RF Operation

Flash Utility

The `flash.bat` utility lets you copy, delete or rename files on the flash disk: it switches the flash disk to write mode, performs the operation, and then returns the flash disk to read-only mode. The LWP software copies `flash.bat` onto the E:\ drive the first time you start the terminal.

Deleting

To delete a named file from the current directory of the flash disk:

```
flash del filename.ext
```

To delete all the files in the root directory of the flash disk:

```
flash del \*.*
```

Important! You don't have to name the E: drive to erase all of the root directory files.

Copying

To copy the protocol stack configuration file (`net.cfg`) from the current directory to the root directory on the flash disk:

```
flash copy net.cfg \
```

To copy a file (`filename.ext`) from the SVTP directory on the flash disk to the STEP directory on the flash disk:

```
flash copy e:\svtp\filename.ext \step
```

Note: If you are copying from the E:\ drive, specify it on the first command parameter, but do NOT specify it on the second parameter, where it is assumed. You can only use this option to copy to the flash drive.

Renaming

To rename `netcfg.1` in the flash disk root directory to `net.cfg`:

```
flash ren \netcfg.1 net.cfg
```

Normal restrictions for a DOS file re-name apply, *i.e.*, `netcfg.1` must exist and `net.cfg` must not exist in the directory before the command is executed.

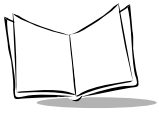

VRC 6940 Product Reference Guide

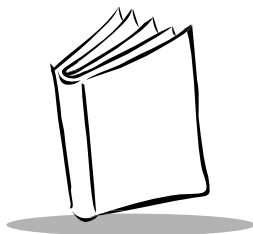

Appendix B Software Environment

This section describes the software environment for a VRC 6940 terminal. A VRC 6940 has four drives as described in [Table B-1](#):

Table B-1. VRC 6940 Drives

Drive	Size	Type	Contents
A:\	256 Kb	Flash, EPROM	This drive contains: <ul style="list-style-type: none">• BIOS, including the Command Mode menus and commands and Self-Test software• Essential system drivers• DOS
B:\	256 Kb	Flash, EEPROM	This drive is the main space for user applications. For the first installation, it contains the LWP hex image. The first time you boot a terminal, LWP copies utilities and applications onto the E:\ drive. When you load user applications onto the terminal, they overwrite LWP, but the utilities and applications stay on the E:\ drive. See Chapter 4 for information on loading applications into this space.
D:\	160 Kb	RAM	This drive contains the net .cfg file and user space. Commands in the b:\autoexec.bat file can write files to this disk. The default size is 160 Kb, but this size can be changed by b:\init.exe. For information on setting the D drive size, see Chapter 5 of the <i>Series 3000 Application Programmer's Guide</i> (p/n 70-16308-XX).

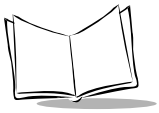
**Table B-1. VRC 6940 Drives**

Drive	Size	Type	Contents
E:	1MB	Flash	This drive is normally read-only, although it can be controlled by application programming on drive B. The LWP hex image copies these utilities into this space: <ul style="list-style-type: none">• BOOTP• CFG24• DIAG24• FLASH.BAT

Boot Sequence

The first time a new terminal powers up:

1. A:\config.sys loads drivers.
2. A:\autoexec.bat calls and runs B:\autoexec.bat.
3. B:\autoexec.bat loads the application files contained in the LWP.HEX file by decompressing them into an application subdirectory on E:\ (see [LAN Workplace \(LWP\) Software on page B-3](#)).
4. A second batch file displays a menu with terminal configuration options.
5. A third batch file loads the protocol stack to enable application-to-host connections.

If the terminal boots and the Spectrum24 radio card has no parameters, the terminal runs the CFG24 software so that you can configure the radio card. Chapter 3 describes how to configure the radio card.

If the Spectrum24 radio card has parameters, the terminal tries to connect to anAP. If it can connect, the terminal starts a session and continues to boot normally. If it can't find an AP, the screen displays a NOT ASSOCIATED message, and a DOS prompt appears. At this point you can run the DIAG24 ping utility (see [page 6-5](#)).

After you have started the terminal, and LWP.HEX has installed the utility files into their appropriate directories, you can install end-user applications onto the terminal. When you transfer a new HEX image onto the terminal, it overwrites the LWP.HEX image. The Program Loader then installs the new HEX image by converting the ASCII data stream into files to be stored in non-volatile flash memory on the B:\ drive.

LAN WorkPlace (LWP) Software

All VRC 6940 terminals have a copy of LWP.HEX loaded at the factory. The first time you start the terminal, it installs the utilities listed below onto the E:\drive.

- CFG24** The CFG24 Configurator utility that allows you to configure the Spectrum24 radio. You can run it from a DOS prompt. See [page A-12](#) for more information.
- DIAG24** The DIAG24 Diagnostics utility that allows you to run Access Point ping tests. You can run it from a DOS prompt. See [page A-5](#) for more information.
- BOOTP** BOOTP boot utility. It requests and receives an IP address and then sets up communications parameters for use by other parts of the system. It executes automatically during start-up procedures. *Do not run it from a DOS prompt.* See [page A-17](#) for more information on configuring boot mode.
- FLASH** A batch file that provides some flash disk housekeeping functions. You can run it from a DOS prompt. See [page A-21](#) for more information.

Software Files

[Table B-2](#) shows the contents of each drive after the LWP hex image is loaded on E:\ drive:

Table B-2. VRC 6940: Software Files

Directory	File Name	Description
A:\	LOADER.EXE	An NVM loader utility that can be used in place of the Command Mode Program Loader. For more information, see the <i>Series 3000 Application Programmer's Reference Manual</i> (p/n 70-16309-XX).
	SHELL.COM	The DOS command shell.
	AUTOEXEC.BAT	Calls B:\autoexec.bat, if it exists, and executes it. If there is no B:\ drive, the terminal boots into Command Mode.
	DSKBCHK.COM	Checks to see if the terminal has been configured with a B:\ drive. For more information, see the <i>Series 3000 Application Programmer's Reference Manual</i> (p/n 70-16309-XX).

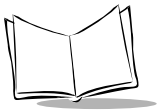
**Table B-2. VRC 6940: Software Files**

Directory	File Name	Description
A:\ (cont'd)	2WAY3000.SYS	A Series 3000 Protocol Device Driver. For more information, see the <i>Series 3000 System Software Manual</i> (p/n 70-16310-XX).
	S1.BIN	A Spectrum One radio driver.
	CONFIG.SYS	A configuration file that loads essential drivers and files. It loads A:\shell.com
B:\	COMMAND.COM	A command batch file.
	AUTOEXEC.BAT	Loads the application files contained in the LWP.HEX file by decompressing them into an application subdirectory on E:\ drive.
	ERR3000.SYS	An error message driver.
	PKUNZJR.COM	An unzip utility.
	FLASHDSK.SYS	The flash disk driver.
	FLSHCTL.EXE	Switches the flash disk between read-write and read-only modes.
	FLSHFMT.EXE	A utility used to format the flash disk.
D:\	NET.CFG	The Spectrum24 configuration file. This file is configured by the CFG24 Configurator utility.
	_AP.BAT	Built by FLSHAUTO.BAT for use in the warm boot process.
E:\	NET.CFG	Configuration file used by LSL.COM, SLAODI3K.COM, and TCPIPEXE to get configuration parameters.
	FLSHAUTO.BAT	Initialization batch file. Loads the radio driver and the TCP/IP stack.
	FLSHAUT1.BAT	Builds the _AP.bat file for use.
	MSG.MSG	File used by the DIAG24 Ping utility.

Table B-2. VRC 6940: Software Files

Directory	File Name	Description
E:\ (cont'd)	APPINIT.COM	Scans the flash disk for valid applications. If it finds more than one, it displays an application selection menu. A valid RF application has a home directory in the flash disk's root directory containing a file called RUN.BAT. This is how the system knows which applications are present, and which are batch applications.
	CBT.COM	Utility to re-initialize (cold boot) the terminal.
	WBT.COM	Utility to re-initialize (warm boot) the application.
	WAIT.EXE	A command used in batch files to pause the display for a specified number of seconds. The pause can be interrupted with the CTRL-FUNC-1 key sequence. If interrupted, the command returns an errorlevel 1.
	GETSTR.EXE	Prompts for keyboard input, which is placed as a character string in the environment variable _STR. Used to customize utility files for building an application HEX during developer kit installation.
	LSL.COM	Novell's Netware Link Support Layer software. Used to access the physical network, in this case a PCMCIA radio card.
	DIAG24.EXE	A diagnostic ping utility for diagnosing possible radio problems. See page A-5 for more information.
	CFG24.EXE	A utility for configuring Spectrum24 radio parameters. See page A-12 for more information.
	BOOTP	A utility that requests and receives an IP address and sets up communications parameters for use by other parts of the system. It runs automatically during start-up. Do not run it from a DOS prompt.
	TCPIP.EXE	Novell's Lan Workplace stack version 5.0.
	PIPCT.EXE	Used to save and restore part of the BIOS work area overwritten when TCPIP.EXE is loaded.
	SS.BAT	Batch file to run DIAG24 for site survey purposes.

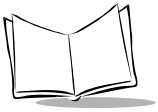
**Table B-2. VRC 6940: Software Files**

Directory	File Name	Description
E:\ (cont'd)	TDREM.EXE	Remote end of serial link used to transfer files to and from a terminal. Used mainly during development but also a useful diagnostic tool.
	FLASH.BAT	A flash utility for copying, renaming or deleting files from flash memory. Useful in development for transferring single files to flash disk. See page A-21 for more information.
	RAMINIT.EXE	Copies _AP.BAT to new RAM disk. The _AP.BAT is saved by a previous RAMCHG. The _AP.BAT <i>must</i> be smaller than 120 bytes.
	RAMCHG.EXE	Changes the RAM disk size and warm boots the terminal. RAMCHG <i>nm</i> changes the RAM disk to <i>nm</i> KBytes.
	RF_VER.COM	Radio utility file.
	RFOFF.COM	Used for batch application to unconditionally turn off the radio adapter to conserve battery life.
	UPD802 (sub-directory)	Stores files to update radio to become 802.11 compatible.
	TFTPC.COM	Encapsulation for TFTP.EXE to allow trapping of error messages. This allows the re-trying of a file transfer if an error is found.
	TFTP.EXE	Trivial File Transfer Protocol software.
	TFTP.MSG	TFTP message file.
	LWP.MSG	TCP/IP message file.
BGET.BAT	Batch file for doing TFTP file transfers from a server to the flash disk. If the file already exists on the current directory on the flash disk (normally the current application's home directory), the file is not transferred. BGET.BAT calls FGET.BAT to perform the actual transfer.	

Table B-2. VRC 6940: Software Files

Directory	File Name	Description
E:\ (cont'd)	FGET.BAT	Batch file for doing TFTP file transfers from a server to the flash disk. If the transfer fails it is retried. The server IP address is picked up from the environment variable SIADDR, which is set up by BOOTP.COM if either a BOOTP or DHCP process is performed.
	UPDATE.BAT	Batch file used for an over-the-air software update facility. It downloads a ZIP file and unzips it into the application directory. The ZIP file is the same file that was placed in the application HEX.
	CHK_ID.EXE	Checks to see if the ident.txt files on the paths specified in the command-line are identical. Used in apphex.bat to check for the need to copy the application files to the flash disk.
	GETNUM.EXE	Returns an errorlevel depending on a single key hit. Returns errorlevel <i>n</i> if the numeric key 'n' is pressed. All other keys return errorlevel 99. Used to make menu selections in batch files.
	IDENT.TXT	Used to identify a particular HEX build.
	SLAODI3K.COM	Wireless LAN adapter driver.
	APP (sub-directory)	Applications stored in this directory.

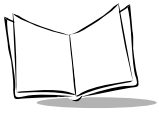

VRC 6940 Product Reference Guide



Appendix C Keyboard Layouts

This section describes the characters and character sequences produced by the 54-key keyboard using the default translation tables. [Table C-1](#) displays the information in table format. Figures C-1 to C-10 show keyboard illustrations.

These key definitions can be changed by application programs. Refer to the *Series 3000 Application Programmer's Reference Manual* (p/n 70-16309-XX) and the *Series 3000 System Software Manual* (p/n 70-16310-XX) for additional information on keyboard translation.

Table C-1. VRC 6940 Key Combinations

Unmodified	Shift	Caplock	Ctrl	Func	Shift+Func	Func+Ctrl	Ctrl+Func	Alt+Func
Enter	Enter	Enter	Line feed	=	+	none	none	none
Clear	Clear	Clear	Clear	Clear	Clear	none	Clear	none
Ctrl	Ctrl	Ctrl	none	Alt	Alt	none	Alt	none
Shift	Shift	Shift	none	none	none	none	Shift	none
Func	Func	Func	none	none	none	Func	none	none
Pwr	Pwr	Pwr	Pwr	Pwr	Pwr	Pwr	Pwr	Pwr
a	A	A	Ctrl, A	a	A	Alt, A	none	none
b	B	B	Ctrl, B	b	B	Alt, B	Ctrl, B	Alt, B
c	C	C	Ctrl, C	c	C	Alt, C	Ctrl, C	Alt, C
d	D	D	Ctrl, D	d	D	Alt, D	Ctrl, D	Alt, D
e	E	E	Ctrl, E	e	E	Alt, E	Ctrl, E	Alt, E
f	F	F	Ctrl, F	f	F	Alt, F	Ctrl, F	Alt, F
g	G	G	Ctrl, G	g	G	Alt, G	Ctrl, G	Alt, G

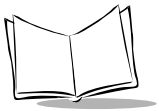

Table C-1. VRC 6940 Key Combinations

Unmodified	Shift	Caplock	Ctrl	Func	Shift+Func	Func+Ctrl	Ctrl+Func	Alt+Func
h	H	H	Ctrl, H	F1	Shift, F1	Alt, H	Ctrl, F1	Alt, F1
i	I	I	Ctrl, I	Dark	Dark	Alt, I	Dark	Dark
j	J	J	Ctrl, J	Light	Light	Alt, J	Light	Light
k	K	K	Ctrl, K	BckLt ¹	BckLt ¹	Alt, K	BckLt ¹	BckLt ¹
l	L	L	Ctrl, L	Caplock	Caplock	Alt, L	Caplock	Caplock
m	M	M	Ctrl, M	F9	Shift, F9	Alt, M	Ctrl, F9	Alt, F9
n	N	N	Ctrl, N	Numlock	Numlock	Alt, N	none	Numlock
o	O	O	Ctrl, O	o	O	Alt, O	Ctrl, O	Alt, O
p	P	P	Ctrl, P	p	P	Alt, P	Ctrl, P	Alt, P
q	Q	Q	Ctrl, Q	q	Q	Alt, Q	Ctrl, Q	Alt, Q
r	R	R	Ctrl, R	r	R	Alt, R	Ctrl, R	Alt, R
s	S	S	Ctrl, S	F10	Shift, F10	Alt, S	Ctrl, F10	Alt, F10
t	T	T	Ctrl, T	t	T	Alt, T	Ctrl, T	Alt, T
u	U	U	Ctrl, U	+	+	Alt, U	none	none
v	V	V	Ctrl, V	-	-	Alt, V	none	none
w	W	W	Ctrl, W	*	none	Alt, W	Ctrl, *	none
x	X	X	Ctrl, X	/	?	Alt, X	none	none
y	Y	Y	Ctrl, Y	y	Y	Alt, Y	Ctrl, Y	Alt, Y
z	Z	Z	Ctrl, Z	z	Z	Alt, Z	Ctrl, Z	Alt, Z
Back	Backspace	Backspace	Ctrl, Break	Space	Space	none	Space	none
Left Arrow	4	Left Arrow	Ctrl, Left Arrow	Home	7	none	Ctrl, Home	none
Right Arrow	6	Right Arrow	Ctrl, Right Arrow	End	1	none	Ctrl, End	none
Up Arrow	8	Up Arrow	Ctrl, Up Arrow	Page Up	9	none	Ctrl, Page Up	none
Dwn Arrow	2	Dwn Arrow	Ctrl, Dwn Arrow	Page Down	3	none	Ctrl, Page Down	none
0)	0	none	Ins	0	Alt, 0	none	none

¹ Functional only on units equipped with the keyboard backlight option.

Table C-1. VRC 6940 Key Combinations

Unmodified	Shift	Caplock	Ctrl	Func	Shift+Func	Func+Ctrl	Ctrl+Func	Alt+Func
1	!	1	none	,	“	Alt, 1	none	none
2	@	2	Ctrl, 2	,	<	Alt, 2	none	none
3	#	3	none	/	?	Alt, 3	none	none
4	\$	4	none	[{	Alt, 4	Ctrl, 4	none
5	%	5	none]	}	Alt, 5	Ctrl, 5	none
6	^	6	Ctrl, 6	;	:	Alt, 6	none	none
7	&	7	none	‘	~	Alt, 7	none	none
8	*	8	none	=	+	Alt, 8	none	Alt, =
9	(9	none	\		Alt, 9	Ctrl, \	none
-	_	-	Ctrl, -	-	_	Alt, -	Ctrl, -	Alt, -
.	>	.	none	Del	.	none	none	none
F1	Shift, F1	F1	Ctrl, F1	F6	Shift, F6	Alt, F1	Ctrl, F6	Alt, F6
F2	Shift, F2	F2	Ctrl, F2	F7	Shift, F7	Alt, F2	Ctrl, F7	Alt, F7
F3	Shift, F3	F3	Ctrl, 3	F8	Shift, F8	Alt, F3	Ctrl, F8	Alt, F8
F4	Shift, F4	F4	Ctrl, F4	F9	Shift, F9	Alt, F4	Ctrl, F9	Alt, F9
F5	Shift, F5	F5	Ctrl, F5	F10	Shift, F10	Alt, F5	Ctrl, F10	Alt, F10

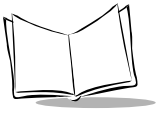

Keyboard Character & Character Combination Illustrations

The captions indicate what sequence of modifier keys produce the keyboard character.

FUNC and SHIFT-FUNC key combinations (Figure C-5 and Figure C-9) produce scan codes, ASCII values, and printable characters/logical key sequence names. The keys are illustrated as follows:

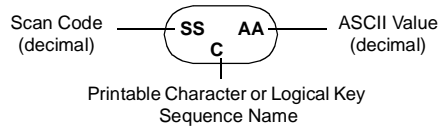

Figure C-1. Key Captions

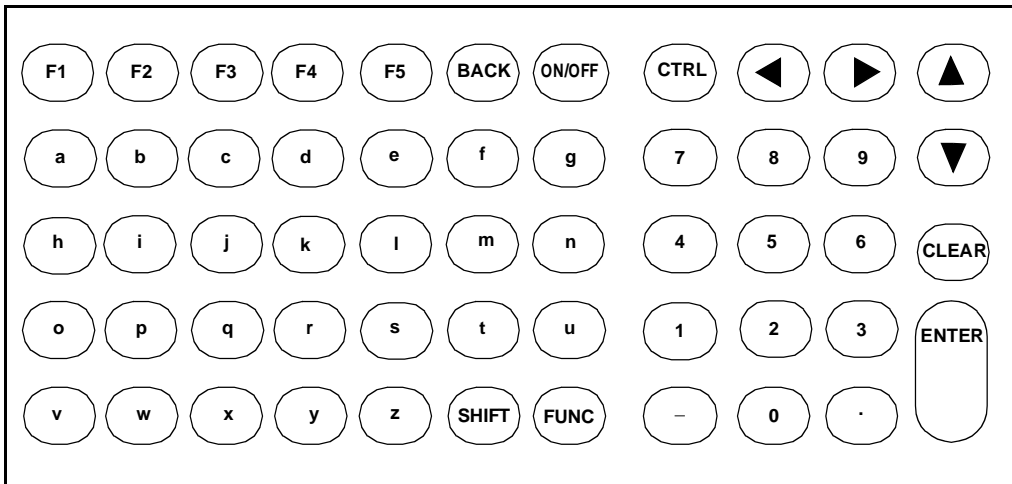

Figure C-2. Unshifted Keyboard

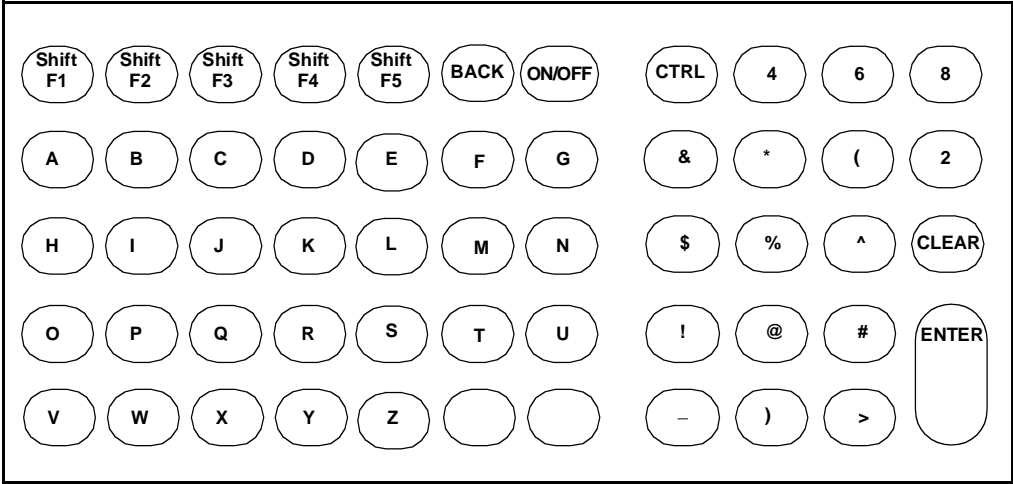

Figure C-3. Shift-Modified Keyboard

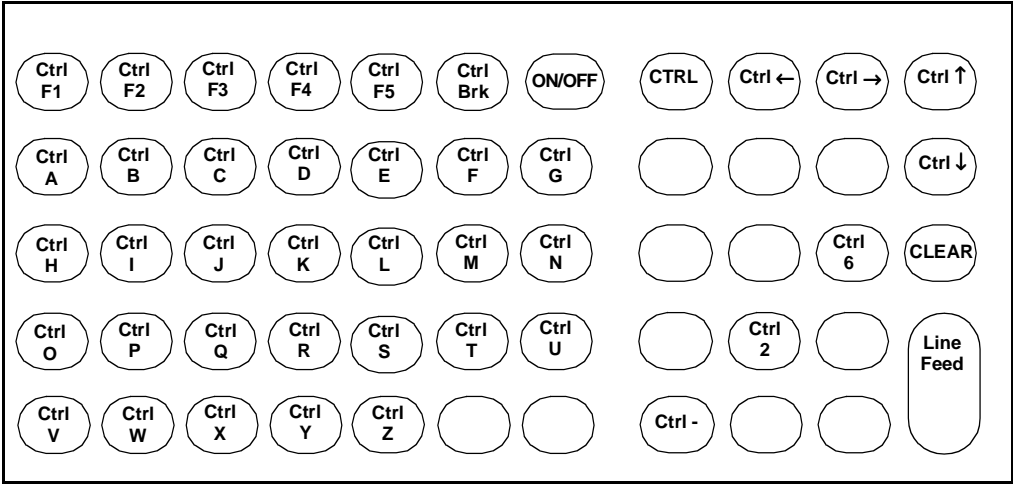
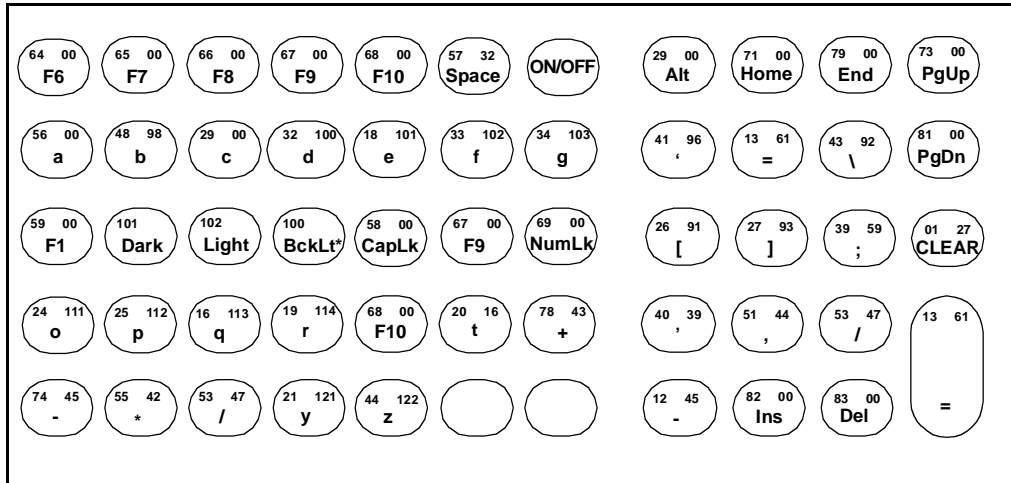
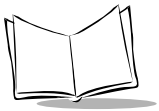

Figure C-4. Ctrl-Modified Keyboard



* Functions only on units equipped with the keyboard backlight option.

Figure C-5. Func-Modified Keyboard

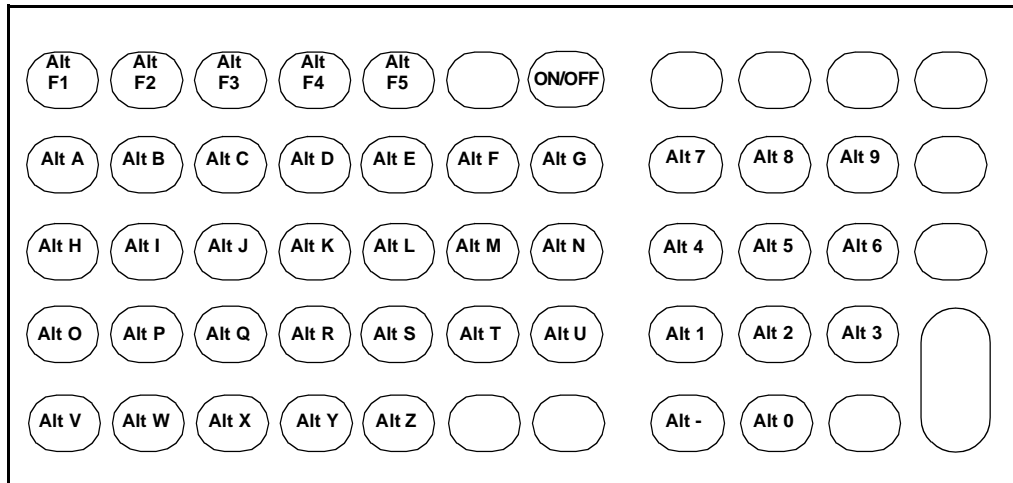

Figure C-6. Alt-Modified Keyboard

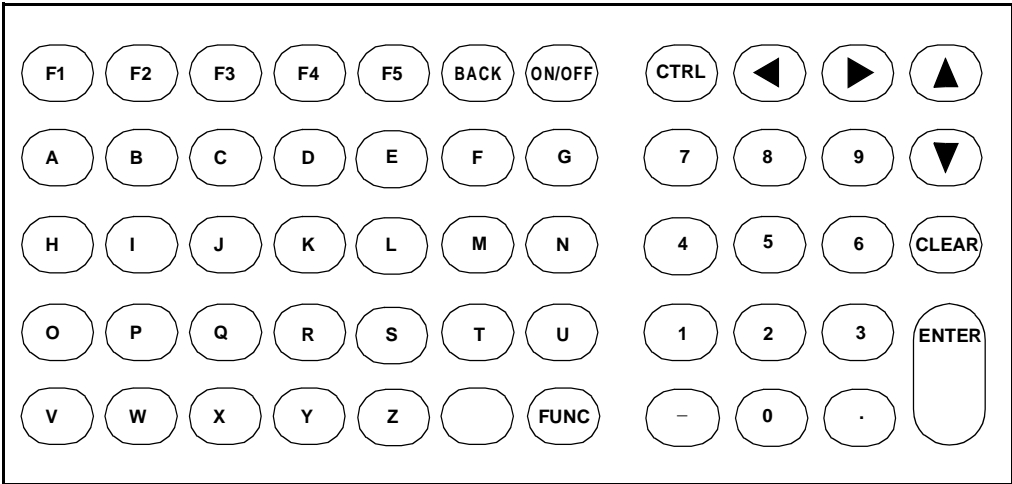
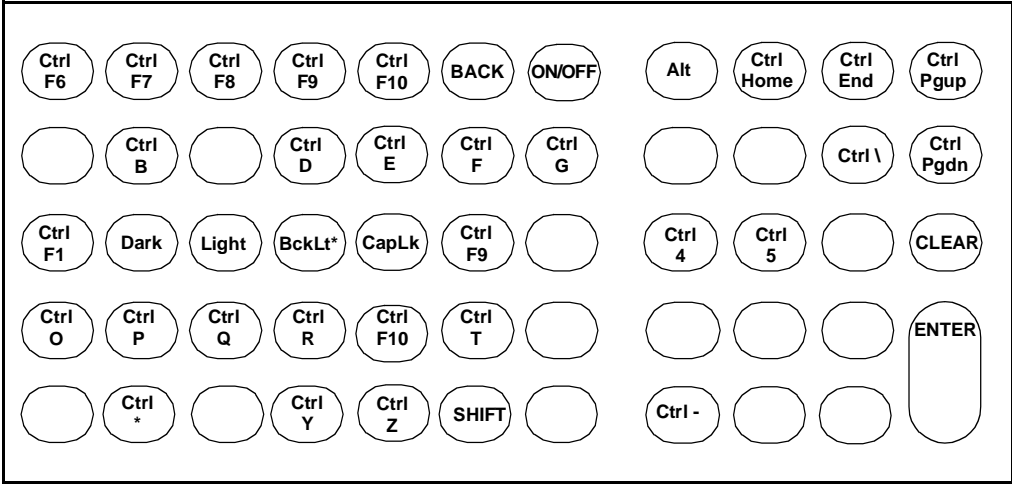
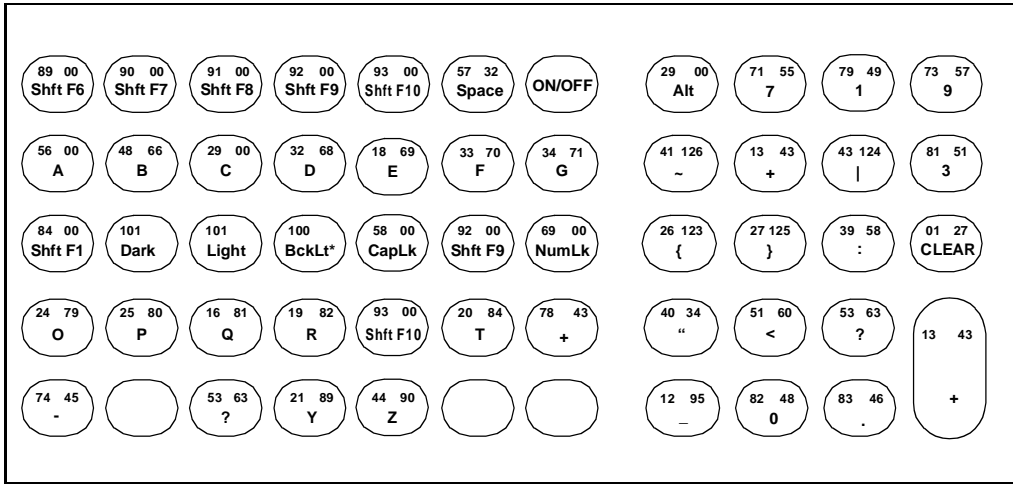
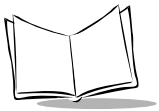

Figure C-7. Caplock-Modified Keyboard



* Functions only on units equipped with the keyboard backlight option.

Figure C-8. Ctrl + Func-Modified Keyboard



* Functions only on units equipped with the keyboard backlight option.

Figure C-9. Shift+ Func-Modified Keyboard

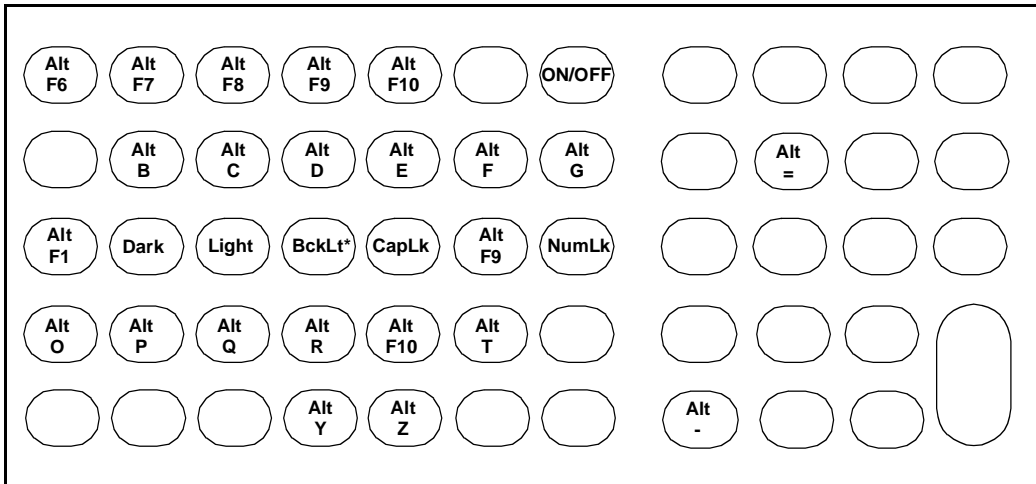

* Functions only on units equipped with the keyboard backlight option.

Figure C-10. ALT + Func-Modified Keyboard



Appendix D Environmental and Technical Specifications

This appendix describes:

- ◆ physical, environmental, and operational information for VRC 6940 terminals
- ◆ reference information for the COM1 and scanner ports
- ◆ mappings for the null modem pinouts

Specifications

[Table D-1](#) summarizes physical, operational, and environmental specifications for the VRC 6940.

Table D-1. VRC 6940 Specifications

Dimensions	12" x 9" x 3" / 310 mm x 234 mm x 81 mm (LxWxD)
Weight	6.7 lbs
Data Communication	RS-232 serial port
Power Requirements	9 - 60 VDC
Backup Battery	NiMH
Display Size	8 line x 40 character
Display	Vacuum Fluorescent
Number of Keys	54 keys
Radio Module	Internal PCMCIA

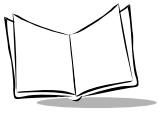
**Table D-1. VRC 6940 Specifications**

Microprocessor	NEC V25
Housing	Magnesium Alloy
Sealing	IP65 and NEMA4
Vibration Specification	SAE 1445
Operating Temperature: without internal heater with optional internal heater	-2°F to 122° F / -20°C to 50° C -22°F to 122°F / -30°C to 50°C
Storage Temperature	-40°F to 140° F/ -40°C to 60° C
RF Technology: 2.4 GHz	Yes
Operating System	DR-DOS
Architecture	16 Bit
Memory: RAM FLASH	640KB 1.2MB
Programming Tool	16 Bit Application Developer's Toolkit

Scanner Port

The Scanner Port is located on the back panel of the VRC 6940. [Table D-2](#) lists the pin descriptions.

Table D-2. Scanner Port Pin Descriptions

Pin	Name	Function	Direction
1	SOS	Start of scan ¹	input
2	BARDATA	Bar code data	input
3	LEDEN	L.E.D. enable	output
4	LASERTRIGN	Laser trigger not	input
5	LASEREN	Laser enable	output
6	GROUND	Logic/power ground	N/A
7	LASERVCC	Laser power (+5V)	output

¹Must be grounded on contact-wand scanners

COM1 Serial Port

The COM1 Serial Port is located on the back panel of the VRC 6940. [Table D-3](#) lists the pin descriptions.

Table D-3. COM1 Serial Port Descriptions

Pin	Name	Signal	Direction
1	GROUND	GND	IN ¹
2	TRANSMIT DATA	TXD	OUT ¹
3	RECEIVED DATA	RXD	IN ¹
4	REQUEST TO SEND	RTS	OUT ¹
5	CLEAR TO SEND	CTS	IN ¹
6	DATA SET READY	DSR	IN ¹
7	SIGNAL GROUND	GND	— ¹
8	CARRIER DETECT	DCD	IN ¹
9	Not used		
10	Not used		
11	REV CH		OUT ¹
12-19	Not used		
20	DATA TERMINAL READY	DTR	OUT ¹
21	Not used		
22	RING INDICATOR	RI	IN ¹
23	Not used		
24	Reserved ²		
25	Reserved ²		

¹RS-232 signal

²Symbol internal test signals

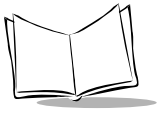

Null Modem

A null modem cable is used for:

- ◆ downloading programs from a PC to a VRC 6940 terminal
- ◆ unloading memory contents from a VRC 6940 terminal to a PC

The cable has a 16-pin male circular connector, and a 25-pin female D-Connector. [Table D-4](#) shows the pin-outs for both connectors.

Table D-4. Null Modem Pin Out Descriptions

VRC6940 16-Pin Circular Connector (Male)		Host 25-Pin D-Connector (Female)	
Pin	Name	Pin	Name
1	DCD	20	DTR
2	RXD	2	TXD
3	TXD	3	RXD
4	DTR	6, 8	DSR, DCD
5	GND	7	GND
6	DSR	20	DTR
7	RTS	5	CTS
8	CTS	4	RTS

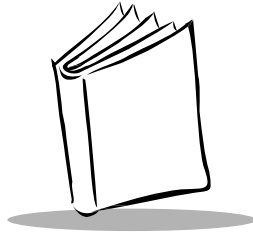

Appendix E Communications Status Codes

Communications Status Codes

When the Program Loader and Memory Transfer utilities complete their functions, they return communication status codes in the form of a four hexadecimal number. A status code of 0000 indicates success; any other code indicates failure. [Table E-1](#) describes the conditions associated with the status codes.

Table E-1. Communications Status Codes

Status Code	Meaning
0002	Receive overrun error
0004	Receive parity error
0008	Receive framing error
0010	Programming voltage not present
0020	Data Set Ready or Carrier Detect not detected on open
0080	ABORT key hit during comm
0100	CD lost during session
0200	Illegal Intel hexadecimal record
0400	Either unsupported Intel record
0600	NVM EEPROM failed to erase
0800	Receive time-out error
1000	Control start character time-out
2000	Clear To Send inactive time-out error
4000	Receive buffer full

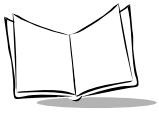

VRC 6940 Product Reference Guide

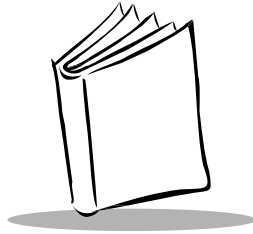

Glossary

Access Point

A device that provides transparent access between Ethernet wired networks and IEEE 802.11 interoperable radio-equipped mobile units (MUs). Symbol's hand-held computers, or other devices equipped with a PCMCIA slot, communicate with wired networks using Access Points (AP). The mobile unit may roam among the APs in the same subnet while maintaining a continuous, seamless connection to the wired network. Refer to **Subnet**.

AP

See **Access Point**.

API

Application Programming Interface. An interface that gives one software component the ability to communicate with or control another. Usually used to refer to services provided by one software component to another when using software interrupts or function calls.

ASCII

American Standard Code for Information Interchange. A 7 bit code representing 128 letters, numerals, punctuation marks, and control characters. It is a standard data transmission code in the U.S.

Bar Code

A pattern of variable-width bars and spaces which represents numeric or alphanumeric data in machine-readable form. The general format of a bar code symbol consists of a leading margin, start character, data or message character, check character (if any), stop character, and trailing margin. Within this framework, each recognizable symbology uses its own unique format. See **Symbology**.

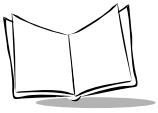

Baud Rate

A measure for data transmission speed.

BIOS

Basic Input Output System. A collection of ROM-based code with a standard API used to interface with standard PC hardware.

Bit

Binary digit. One bit is the basic unit of binary information. Generally, eight consecutive bits compose one byte of data. The pattern of 0 and 1 values within the byte determines its meaning.

Bits per Second (bps)

Number of bits transmitted or received per second.

BOOTP

Bootstrap protocol. A TCP/IP protocol that enables a VRC 6940, for example, to learn its IP address from a centrally administered server. It does this by broadcasting a TCP/IP BOOTP request message to the network. Boot servers on the network respond if configured to do so. The terminal accepts and uses the first valid IP address that it receives and, optionally, other network parameters.

Byte

On an addressable boundary, eight adjacent binary digits (0 and 1) combined in a pattern to represent a specific character or numeric value. Bits are numbered from the right, 0 through 7, with bit 0 the low-order bit. One byte in memory can be used to store one ASCII character.

Data Communications Equipment (DCE)

A device such as a modem that is designed to attach directly to a DTE (Data Terminal Equipment) device.

Data Terminal Equipment (DTE)

A device such as a terminal or printer that is designed to attach directly to a DCE (Data Communications Equipment) device.

Decode

To recognize a bar code symbology (*e.g.*, Codabar, Code 128, Code 3 of 9, UPC/EAN, etc.) and analyze the content of the bar code scanned.

DOS

Disk Operating System. This is basic software that allows you to load and use software applications on your computer. VRC 6940 terminals use a product called DR-DOS.

DR-DOS

Disk operating system software on VRC 6940 terminals. It is compatible with and extends the industry-standard IBM PC-DOS, and provides access to a number of commercially available programming tools.

EEPROM

Electrically Erasable Programmable Read-Only Memory. An on-board non-volatile memory chip. See NVM.

ESS ID

Allows facilities using 802.11 protocol to limit which Access Points a VRC 6940 terminal can communicate with. The terminal can only communicate with Spectrum24 Access Points that have matching ESS IDs. See Spectrum24 documentation for further information.

File Transfer Protocol (FTP)

A TCP/IP application protocol governing file transfer via network. See **TCP/IP**.

Flash Disk

Non-volatile memory for storing application and configuration files.

Flow Control

The procedure for adjusting the flow of data from one device to another to ensure that the receiving device can handle all of the incoming data.

FTP

See **File Transfer Protocol**.

HEX Image

A file format used for installing applications on the VRC 6940. The image may contain BIOS information, applications, and instructions for transferring the applications.

Host

A computer that serves other terminals in a network, providing services such as network control, database access, special programs, supervisory programs, or programming languages.

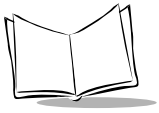

I/O Ports

Input/Output Ports. The I/O ports are primarily dedicated to passing information into or out of the terminal's memory. The VRC 6940 terminal includes a Serial port and a Scanner port.

IP Address

A 32-bit address assigned to nodes on a TCP/IP network. The address is written as four octets separated by periods (dotted decimal format), *e.g.*, 130.24.34.03. They represent a network section, an optional subnet section, and a host section. Also see *Terminal IP Address*.

LAN

Local Area Network.

Liquid Crystal Display (LCD)

A display that uses liquid crystal sealed between two glass plates. The crystals are excited by precise electrical charges, causing them to reflect light outside according to their bias. They use little electricity and react relatively quickly. They require external light to reflect their information to the user.

Light Emitting Diode (LED)

A low power electronic light source commonly used as an indicator light. It uses less power than an incandescent light bulb but more than a Liquid Crystal Display (LCD).

MU

Mobile Unit.

Net ID

A Net ID allows facilities using Spring protocol to limit which Access Points a VRC 6940 terminal can communicate with. The terminal can only communicate with Spectrum24 Access Points that have matching Net IDs. See the Spectrum24 documentation for more information.

NVM

Non-volatile memory. This is memory that retains its contents after its power supply is removed or turned off. Files and programs contained in NVM help load programs onto the terminal and provide an environment for running programs.

Null Modem

A special cable that allows direct connection between two DTE (Data Terminal Equipment) devices by making each one emulate a DCE (Data Communications Equipment) device.

Parity

A technique for verifying whether or not data has been lost or overwritten when it is transferred from one place in storage to another or between computers.

PCMCIA

Personal Computer Memory Card Interface Association.

PCMCIA Card

A plug-in expansion card for laptop computers and other devices, also called a PC Card. PC Cards are 85.6 mm long x 54 mm wide, and have a 68 pin connector. There are several different kinds:

Type	Height	Common Use
Type I	3.3 mm	RAM or Flash RAM
Type II	5 mm	modems, LAN adaptors
Type III	10.5 mm	Hard Disks

RAM

Random Access Memory. Data in RAM can be accessed in random order, and quickly written and read.

RF

Radio Frequency.

ROM

Read-Only Memory. Data stored in ROM cannot be changed or removed.

Router

A device that connects separate networks. Routers are typically used to extend the range of cabling and to organize the topology of a network into subnets. They also support the required protocols for packet filtering. Refer to **Subnet**.

RTC

Real Time Clock.

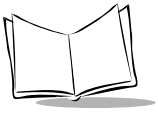

Scanner

An electronic device used to scan bar code symbols and produce a digitized pattern that corresponds to the bars and spaces of the symbol. Its three main components are:

1. Light source (laser or photoelectric cell) - illuminates a bar code.
2. Photodetector - registers the difference in reflected light (more light reflected from spaces).
3. Signal conditioning current - transforms optical detector output into a digitized bar pattern.

Spectrum24

Symbol's frequency-hopping, spread spectrum cellular network.

Spread Spectrum

A technique for uniformly distributing the information content of a radio signal over a frequency range larger than normally required for robust transmission of data. Spreading the signal without adding additional information adds significant redundancy, which allows the data to be recovered in the presence of strong interfering signals such as noise and jamming signals. This is its primary advantage.

Subnet

A subset of nodes on a network that are serviced by the same router. Refer to **Router**.

SVTP

Symbol Virtual Terminal Program.

Terminal

A Symbol portable computer product.

Terminal IP Address

The terminal's network address. Networks use IP addresses to determine where to send data that is being transmitted over a network. An IP address is a 32-bit number referred to as a series of 8-bit numbers in decimal dot notation (*e.g.*, 130.24.34.03). The highest 8-bit number you can use is 254.

TFTP

Trivial File Transfer Protocol.

Transmission Control Protocol/Internet Protocol (TCP/IP)

A suite of standard network protocols that were originally used in UNIX environments but are now used in many others. The TCP governs sequenced data; the IP governs packet forwarding. TCP/IP is the primary protocol that defines the Internet.

VRC

Vehicular Radio Computer.

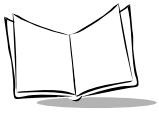

VRC 6940 Product Reference Guide

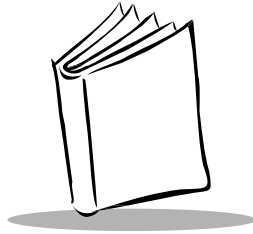

Index

A

Accessories (optional)	1-4
Alt + Func-modified keyboard	C-8
Alt-modified keyboard	C-6
Antenna, vehicle-mounted option	2-4
AP ping test	A-5, A-8
Applications, installing	4-2

B

Backlight, keyboard	5-6
Booting	
boot mode	3-4
cold	6-6
failure to reboot	6-7
sequence	B-2
to Command Mode	6-7
warm	6-5
BOOTP	B-3
Brightness control	5-6

C

Cable, null modem	D-4
Caplock-modified keyboard	C-7
CFG24 Configurator utility	A-1, A-12
boot mode	A-17
buffers	A-19
default router	A-15
diversity	A-16
ESS ID/NET ID	A-14
IP Address	A-16
menu	A-13
parameters	A-13
power management	A-18

rate control	A-20
re-transmit delay	A-19
scanner/rf operation	A-20
sleep mode	A-17
starting utility	3-2
subnet mask	A-14
using menus for	3-3

Changing power sources	5-8
------------------------	-----

Com1 serial port pin descriptions	D-3
-----------------------------------	-----

Command Mode	
diagnostics	5-8
file transfer	4-4

Communications status codes	E-1
-----------------------------	-----

Configuration	
configuration utility	A-12
first time start-up	3-2, A-12
hardware	3-1
parameters	3-3, A-13
Spectrum24 radio card	3-2-3-5

Copying files to flash	A-21
------------------------	------

CTRL functions	5-4
----------------	-----

Ctrl + Func-modified keyboard	C-7
-------------------------------	-----

Ctrl-modified keyboard	C-5
------------------------	-----

D

Data buffer	3-4
Default router	3-3
Deleting files from flash	A-21
DIAG24 diagnostics utility	A-1 – A-10, B-3
Diagnostics	A-1–A-11
DIAG24 diagnostics	A-5
keyboard test	A-4
ping test	A-5

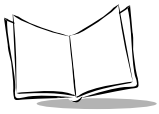

Display
 adjusting brightness 5-6
 blank 6-2
 washing 7-2
Diversity 3-4

E
EEPROM, erasing with Program Loader .. 4-5
802.11 protocol A-14
Entering data 5-6
Equipment, optional 1-3
Error messages 6-3
ESS ID 3-3

F
Field diagnostic tests A-10
File transfer
 baud rate settings 4-5
 Command Mode 4-4
 communications status codes E-1
 data bits settings 4-6
 failed transfer 4-7
 flow control settings 4-6
 HEX image 4-2
 installing transferred files 4-8
 null modem cable 4-2
 parity settings 4-6
 Program Loader 4-2
 SENDHEX 4-2
 starting 4-7
 successful transmission 4-7
 TD Rem utility 4-2
 terminal preparation 4-4
 TFT3000 program 4-2
 using Program Loader 4-4
First time terminal use 1-4, 7-1
Flash disk B-3
 copying files to A-21
 deleting files from A-21
 renaming files on A-21
Flash utility A-21
FUNC key 5-4
Func-modified keyboard C-6

H
HEX image transfer 4-2

I
Initial use, terminal 1-4
Initializing the radio A-12
Installation
 overview of tasks 1-4
 software 4-1-4-8
Internal battery 7-1
IP address 3-3

K
Keyboard
 backlight option 5-6
 cursor indicators 5-4
 key descriptions 5-4
 keyboard layouts C-1
 keyboard test A-4
 modifier keys 5-4
 special functions 5-4
 using keyboard 5-6

L
LWP LAN Workplace software B-3

M
Maintenance 7-1
 internal battery 7-1
 terminal 7-2
Memory transfer 6-8
 communications status code E-1
Modifier keys 5-4
Mounting hardware (illus.) 2-3
Moving a terminal to new power source .. 5-8

N
Net ID 3-3
Null modem cable 4-2
 for memory transfers 6-8
 pin descriptions D-4

O

- ON/OFF key 5-2
- Operation
 - entering data 5-6
 - power on suspend or off 5-2
- Options 1-3

P

- Parts
 - accessories 1-3
 - options 1-3
 - standard 1-2
- Ping test A-5, A-8
- Power
 - changing power sources 5-8
 - connecting to terminal 2-5, 2-7
 - external cable preparation 2-5
 - forcing off 6-4
 - terminal power management 3-4
- Power cable
 - external 2-5
 - external cable preparation 2-5
- Power management A-18
- Power on, suspend or off 5-2
- Printer options 1-4
- Program Loader utility 4-4
 - function 4-2
 - navigating in 4-5

R

- Radio
 - default settings A-12
 - initialization A-12
 - initializing A-12
 - options 1-3
- Related publications viii
- Renaming flash files A-21
- Resetting a terminal 5-3
- Re-transmit delay 3-4

S

- Scanner
 - attaching an external scanner 5-7
 - options 1-3
- scanner and RF operation A-20
- Scanner port
 - pin descriptions D-2
- Self Test diagnostics A-1
 - command mode 5-8
 - menu options A-3
- SENDHEX
 - default values for communications 4-2
 - earlier versions 4-3
- Serial port Com1 pin descriptions D-3
- Service information i-viii
- SHIFT functions 5-4
 - Shift-modified keyboard C-5
 - Shift+Func-modified keyboard C-8
- Sleep mode 3-4
- Software
 - environment B-1
 - files B-3
 - hardware required for installation 4-1
 - installation 4-1–4-8
 - LWP B-3
 - Program Loader utility 4-1
 - required for file transfers 4-1
 - SENDHEX 4-1
 - software utilities. See Utilities.
 - standard B-3
- Specifications, physical, operational,
 - environmental D-1
- Spectrum24 configuration options. 3-3
- Status codes E-1
- Storage 7-2
- Subnet mask 3-3
- Symbol Support Center ix
- System utilities, command mode 5-8
 - Also see Utilities

T

- TDRem utility 4-2
- Technical support viii

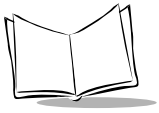

Terminal

accessories	1-3
configurator utility	A-12
initial use	1-4
parts (illus.)	1-2
preparing for file transfer	4-4
restart after forced power off	6-5
T roubleshooting	6-1–6-12
application not responding	6-3
blank display	6-2
booting to Command Mode	6-7
failure to reboot	6-7
power fault	6-2
scanner problems	6-3
start-up problems	6-1, 6-2
terminal shuts off	6-1
terminal stops responding	6-4

U

Utilities

CFG24 configurator	A-12, B-3
command mode	5-8
DIAG24 diagnostics	A-5
flash utility	A-21
keyboard test	A-4
ping test	A-5

V

Vehicle mounted antenna	2-4
-------------------------	-----

W

Warm boot	6-5
-----------	-----

VRC 6940 Product Reference Guide



72-37641-02
Revision B — June 2001