



PCTEST Engineering Laboratory, Inc.

6660-B Dobbin Road • Columbia, MD 21045 • U.S.A.

TEL (410) 290-6652 • FAX (410) 290-6654

www.pctestlab.com

CERTIFICATE OF COMPLIANCE (SAR EVALUATION)

Symbol Technologies Inc.
1 Symbol Plaza
Holtsville, NY 11742-1300
Attn: Sandy Mazzola, Regulatory Engineer
cc: Dean La Rosa, Senior Design Engineer

Dates of Tests: June 07-08, 2001
Test Report S/N: SAR.210531343.H9P
Test Site: PCTEST Lab, Columbia MD U.S.A.

FCC ID

H9PSPT1846

APPLICANT

SYMBOL TECHNOLOGIES INC.

EUT Type:	2.4GHz Pen Terminal w/ 11Mb Direct Sequence Spread Spectrum (DSSS) Internal LAN radio card (PCMCIA internal card FCC ID: H9PLA4121)
Tx/Rx Frequency:	2412 – 2462 MHz
Max. Radiated Power:	0.135 Watts (21.3dBm)
Max. Peak SAR:	0.044 mW/g (1 g. avg) DSSS Body SAR; 0.390 mW/g (10 g. avg) DSSS Hand SAR
Trade Name/Model(s):	SYMBOL SPT1846
FCC Classification:	Part 15 Spread Spectrum Transmitter
Application Type:	Certification
Tx Original Grant Date:	Internal 11Mb DSSS LAN Radio PCMCIA Card Symbol FCC ID: H9PLA4121 July 31, 2000
Serial Number:	n/a (pre-production)
FCC Rule Part(s):	§ 2.1093; ET Docket 96.326

This wireless portable device has been shown to be capable of compliance for localized specific absorption rate (SAR) for uncontrolled environment/general population exposure limits specified in ANSI/IEEE Std. C95.1-1992 and had been tested in accordance with the measurement procedures specified in ANSI/IEEE Std. C95.3-1992 (See Test Report).

I attest to the accuracy of data. All measurements reported herein were performed by me or were made under my supervision and are correct to the best of my knowledge and belief. I assume full responsibility for the completeness of these measurements and vouch for the qualifications of all persons taking them.

NVLAP accreditation does not constitute any product endorsement by NVLAP or any agency of the United States Government.

PCTEST certifies that no party to this application has been denied the FCC benefits pursuant to Section 5301 of the Anti-Drug Abuse Act of 1988, 21 U.S.C. 862.





Randy Ortanez
President



Table of Contents

ATTACHMENT A - COVER LETTER	
ATTACHMENT B - ATTESTATION STATEMENT(S)	
ATTACHMENT C - SAR MEASUREMENT REPORT	
1.1 SCOPE	1
2.1 INTRODUCTION / SAR DEFINITION	2
3.1 SAR MEASUREMENT SET-UP	3
4.1 E-FIELD PROBE SYSTEM	4
5.1 E-FIELD PROBE CALIBRATION PROCESS	5
5.3 DATA EXTRAPOLATION	6
6.1 PHANTOM, HOLDER & EQUIVALENT TISSUES	7
7.1 SYSTEM SPECIFICATIONS	8
8.1 MEASUREMENT PROCESS	9
9.1 TEST POSITION OF THE PHONE	10
10.1 BODY-WORN CONFIGURATION	11
11.1 ANSI/IEEE C95.1 RF EXPOSURE LIMITS	12
12.1 MEASUREMENT UNCERTAINTIES	13
13.1 TEST DATA SUMMARY	14-16
14.1 SAR TEST EQUIPMENT LIST	17
15.1 CONCLUSION	18
16.1 REFERENCES	19
ATTACHMENT D - FCC ID LABEL & LOCATION	
ATTACHMENT E - BLOCK DIAGRAM(S)	
ATTACHMENT F - SCHEMATIC DIAGRAM(S)	
ATTACHMENT G - OPERATIONAL DESCRIPTION	
ATTACHMENT H - EXTERNAL PHOTOGRAPHS	
ATTACHMENT I - INTERNAL PHOTOGRAPHS	
ATTACHMENT J - USER'S MANUAL	
ATTACHMENT K - PART 15.247 MEASUREMENT REPORT	
ATTACHMENT L - SAR TEST DATA	
ATTACHMENT M - SAR TEST SETUP PHOTOGRAPHS	
ATTACHMENT N - DIPOLE VALIDATION PLOTS	
ATTACHMENT O - PROBE CALIBRATION DATA	
ATTACHMENT P - COPY OF INTERNAL FHSS LAN RADIO CARD FCC GRANT	

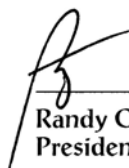
SAR MEASUREMENT REPORT

1.1 Scope

Environmental evaluation measurements of specific absorption rate¹ (SAR) distributions in simulated human head and body tissues exposed to radiofrequency (RF) radiation from wireless portable devices for compliance with the rules and regulations of the U.S. Federal Communications Commission (FCC).²

Company Name:	Symbol Technologies Inc.
Address:	1 Symbol Plaza Holtsville, NY 11742-1300
Attention:	Sandy Mazzola, Regulatory Engineer
cc:	Dean La Rosa, Senior Design Engineer

- EUT Type: 2.4GHz Pen Terminal
w/ 11Mb Direct Sequence Spread Spectrum (DSSS)
Int. LAN radio card (PCMCIA int. card FCC ID: H9PLA4121)
- Trade Name: **SYMBOL**
- FCC IDENTIFIER: **H9PSPT1846**
- Model: **SPT 1846**
- S/N: Pre-production
- Tx/Rx Frequency: 2412 – 2462 MHz
- Application Type: Certification
- FCC Classification: Part 15 Spread Spectrum Transmitter
- Method/System: Direct Sequence Spread Spectrum System (DSSS)
- FCC Rule Part(s): § 2.1093, Docket 96-326
- Max. Radiated Power: 0.135 Watts (21.3dBm)
- Max. SAR Measurements: 0.044 mW/g (1 g. avg) DSSS Body SAR;
0.390 mW/g (10 g. avg) DSSS Hand SAR
- Modulation: Spread Spectrum Transmitter (DSS)
- Dates of Test(s): June 07-08, 2001
- Place of Test(s): PCTEST Engineering Lab.
Columbia, MD, U.S.A.
- Report Serial No.: SAR.210531343.H9P
- Original Grant Date: Internal 11Mb DSSS LAN Radio PCMCIA Card
Symbol FCC ID: H9PLA4121
April 27, 2001



Fig. 1 SAR Test Setup



¹ Specific Absorption Rate (SAR) is a measure of the rate of energy absorption due to exposure to an RF transmitting source (wireless portable device).

² IEEE/ANSI Std. C95.1-1992 limits are used to determine compliance with FCC ET Docket 93-62.

2.1 INTRODUCTION

The FCC has adopted the guidelines for evaluating the environmental effects of radiofrequency radiation in ET Docket 93-62 on Aug. 6, 1996 to protect the public and workers from the potential hazards of RF emissions due to FCC-regulated portable devices.[1]

The safety limits used for the environmental evaluation measurements are based on the criteria published by the American National Standards Institute (ANSI) for localized specific absorption rate (SAR) in *IEEE/ANSI C95.1-1992 Standard for Safety Levels with Respect to Human Exposure to Radio Frequency Electromagnetic Fields, 3 kHz to 300 GHz*. (c) 1992 by the Institute of Electrical and Electronics Engineers, Inc., New York, New York 10017.[2] The measurement procedure described in *IEEE/ANSI C95.3-1992 Recommended Practice for the Measurement of Potentially Hazardous Electromagnetic Fields - RF and Microwave*[3] is used for guidance in measuring SAR due to the RF radiation exposure from the Equipment Under Test (EUT). These criteria for SAR evaluation are similar to those recommended by the National Council on Radiation Protection and Measurements (NCRP) in *Biological Effects and Exposure Criteria for Radiofrequency Electromagnetic Fields*, NCRP Report No. 86 (c) NCRP, 1986, Bethesda, MD 20814.[4] SAR is a measure of the rate of energy absorption due to exposure to an RF transmitting source. SAR values have been related to threshold levels for potential biological hazards.

2.2 SAR Definition

Specific Absorption Rate (SAR) is defined as the time derivative (rate) of the incremental energy (dU) absorbed by (dissipated in) an incremental mass (dm) contained in a volume element (dV) of a given density (ρ). It is also defined as the rate of RF energy absorption per unit mass at a point in an absorbing body (see Fig. 2).

$$SAR = \frac{d}{dt} \left(\frac{dU}{dm} \right) = \frac{d}{dt} \left(\frac{dU}{\rho dV} \right)$$

Figure 2. SAR Mathematical Equation

SAR is expressed in units of Watts per Kilogram (W/kg).

$$SAR = \sigma E^2 / \rho$$

where:

σ	=	conductivity of the tissue-simulant material (S/m)
ρ	=	mass density of the tissue-simulant material (kg/m ³)
E	=	Total RMS electric field strength (V/m)

NOTE: The primary factors that control rate of energy absorption were found to be the wavelength of the incident field in relations to the dimensions and geometry of the irradiated organism, the orientation of the organism in relation to the polarity of field vectors, the presence of reflecting surfaces, and whether conductive contact is made by the organism with a ground plane.[4]

3.1 SAR MEASUREMENT SET-UP

These measurements are performed using the DASY3 automated dosimetric assessment system. It is made by Schmid & Partner Engineering AG (SPEAG) in Zurich, Switzerland. It consists of high precision robotics system (Staubli), robot controller, Pentium III computer, near-field probe, probe alignment sensor, and the generic twin phantom containing the brain equivalent material. The robot is a six-axis industrial robot performing precise movements to position the probe to the location (points) of maximum electromagnetic field (EMF) (see Fig. 2).

A cell controller system contains the power supply, robot controller, teach pendant (Joystick), and remote control, is used to drive the robot motors. The PC consists of the Micron Pentium III 500 MHz computer with Windows NT system and SAR Measurement Software DASY3, A/D interface card, monitor, mouse, and keyboard. The Staubli Robot is connected to the cell controller to allow software manipulation of the robot. A data acquisition electronic (DAE) circuit performs the signal amplification, signal multiplexing, AD-conversion, offset measurements, mechanical surface detection, collision detection, etc. is connected to the Electro-optical coupler (EOC). The EOC performs the conversion from the optical into digital electric signal of the DAE and transfers data to the PC plug-in card. The DAE3 consists of a

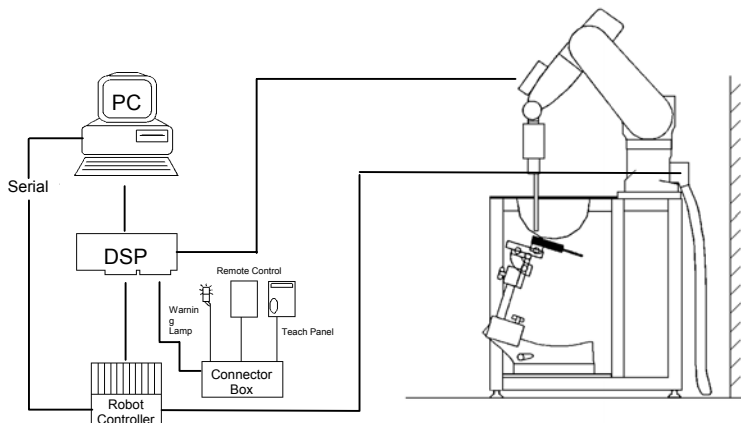

Figure 3. PCTEST SAR Lab II Test Measurement Set-up

highly sensitive electrometer-grade preamplifier with auto-zeroing, a channel and gain-switching multiplexer, a fast 16 bit AD-converter and a command decoder and control logic unit. Transmission to the PC-card is accomplished through an optical downlink for data and status information and an optical uplink for commands and clock lines. The mechanical probe mounting device includes two different sensor systems for frontal and sidewise probe contacts. They are also used for mechanical surface detection and probe collision detection. The robot uses its own controller with a built in VME-bus computer. The system is described in detail in [5].

4.1 DASY3 E-FIELD PROBE SYSTEM

4.2 ET3DV6 Probe Specification

Construction	Symmetrical design with triangular core Built-in optical fiber for surface detection System Built-in shielding against static charges
Calibration	In air from 10 MHz to 2.5 GHz In brain and muscle simulating tissue at Frequencies of 450 MHz, 900 MHz and 1.8 GHz (accuracy $\pm 8\%$)
Frequency	10 MHz to > 6 GHz; Linearity: ± 0.2 dB (30 MHz to 3 GHz)
Directivity	± 0.2 dB in brain tissue (rotation around probe axis) ± 0.4 dB in brain tissue (rotation normal probe axis)
Dynamic Range	5 : W/g to > 100 mW/g; Linearity: ± 0.2 dB
Surface Detection	± 0.2 mm repeatability in air and clear liquids over diffuse reflecting surfaces.
Dimensions	Overall length: 330 mm Tip length: 16 mm Body diameter: 12 mm Tip diameter: 6.8 mm Distance from probe tip to dipole centers: 2.7 mm
Application	General dosimetry up to 3 GHz Compliance tests of mobile phones Fast automatic scanning in arbitrary phantoms

Figure 4. Photograph of the Probe and the Phantom



Fig. 5. ET3DV6 E-field Probe

The SAR measurements were conducted with the dosimetric probe ET3DV6, designed in the classical triangular configuration [5] and optimized for dosimetric evaluation. The probe is constructed using the thick film technique; with printed resistive lines on ceramic substrates. The probe is equipped with an optical multifiber line ending at the front of the probe tip. It is connected to the EOC box on the robot arm and provides an automatic detection of the phantom surface. Half of the fibers are connected to a pulsed infrared transmitter, the other half to a synchronized receiver. As the probe approaches the surface, the reflection from the surface produces a coupling from the transmitting to the receiving fibers. This reflection increases first during the approach, reaches a maximum and then decreases. If the probe is flatly touching the surface, the coupling is zero. The distance of the coupling maximum to the surface is independent of the surface reflectivity and largely independent of the surface to probe angle. The DASY3 software reads the reflection during a software approach and looks for the maximum using a 2nd order fitting. The approach is stopped at reaching the maximum.

5.1 E-FIELD PROBE CALIBRATION PROCESS

5.2 E-Probe Calibration

Each probe is calibrated according to a dosimetric assessment procedure described in [6] with an accuracy better than +/- 10%. The spherical isotropy was evaluated with the procedure described in [7] and found to be better than +/-0.25dB. The sensitivity parameters (NormX, NormY, NormZ), the diode compression parameter (DCP) and the conversion factor (ConvF) of the probe is tested.

The free space E-field from amplified probe outputs is determined in a test chamber. This is performed in a TEM cell for frequencies below 1 GHz, and in a waveguide above 1 GHz for free space. For the free space calibration, the probe is placed in the volumetric center of the cavity and at the proper orientation with the field. The probe is then rotated 360 degrees.

E-field temperature correlation calibration is performed in a flat phantom filled with the appropriate simulated brain tissue. The measured free space E-field in the medium correlates to temperature rise in a dielectric medium. For temperature correlation calibration a RF transparent thermistor-based temperature probe is used in conjunction with the E-field probe.

$$SAR = C \frac{\Delta T}{\Delta t}$$

where:

- Δt = exposure time (30 seconds),
- C = heat capacity of tissue (brain or muscle),
- ΔT = temperature increase due to RF exposure.

SAR is proportional to $\Delta T / \Delta t$, the initial rate of tissue heating, before thermal diffusion takes place. Now it's possible to quantify the electric field in the simulated tissue by equating the thermally derived SAR to the E- field;

$$SAR = \frac{|E|^2 \cdot \sigma}{\rho}$$

where:

- σ = simulated tissue conductivity,
- ρ = Tissue density (1.25 g/cm³ for brain tissue)

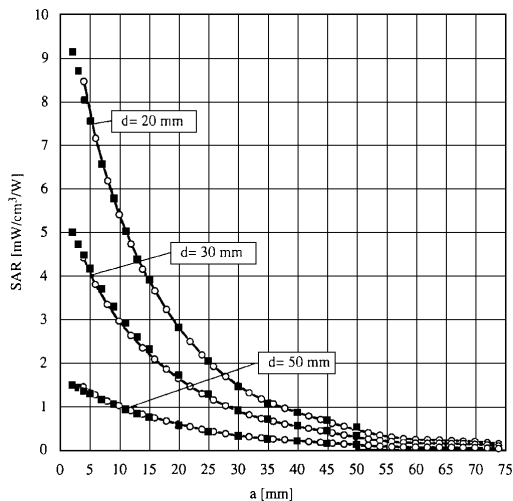

Figure 6. E-Field and Temperature measurements at 900MHz [5]

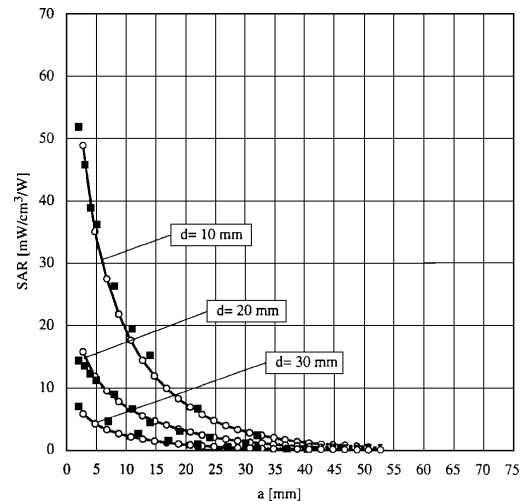

Figure 7. E-Field and temperature measurements at 1.8GHz [5]

5.3 Data Extrapolation

The DASY3 software automatically executes the following procedures to calculate the field units from the microvolt readings at the probe connector. The first step of the evaluation is a linearization of the filtered input signal to account for the compression characteristics of the detector diode. The compensation depends on the input signal, the diode type and the DC-transmission factor from the diode to the evaluation electronics. If the exciting field is pulsed, the crest factor of the signal must be known to correctly compensate for peak power. The formula for each channel can be given as [8]:

$$V_i = U_i + U_i^2 \cdot \frac{cf}{dcp_i}$$

with V_i = compensated signal of channel i (i=x,y,z)
 U_i = input signal of channel i (i=x,y,z)
 cf = crest factor of exciting field (DASY parameter)
 dcp_i = diode compression point (DASY parameter)

From the compensated input signals the primary field data for each channel can be evaluated:

E-field probes: with V_i = compensated signal of channel i (i = x,y,z)
 $Norm_i$ = sensor sensitivity of channel i (i = x,y,z)
 $\mu V/(V/m)^2$ for E-field probes
 $ConvF$ = sensitivity of enhancement in solution
 E_i = electric field strength of channel i in V/m

$$E_i = \sqrt{\frac{V_i}{Norm_i \cdot ConvF}}$$

The RSS value of the field components gives the total field strength (Hermetian magnitude):

$$E_{tot} = \sqrt{E_x^2 + E_y^2 + E_z^2}$$

The primary field data are used to calculate the derived field units.

$$SAR = E_{tot}^2 \cdot \frac{\sigma}{\rho \cdot 1000}$$

with SAR = local specific absorption rate in W/g
 E_{tot} = total field strength in V/m
 σ = conductivity in [mho/m] or [Siemens/m]
 ρ = equivalent tissue density in g/cm³

The power flow density is calculated assuming the excitation field to be a free space field.

$$P_{pwe} = \frac{E_{tot}^2}{3770}$$

with P_{pwe} = equivalent power density of a plane wave in W/cm²
 E_{tot} = total electric field strength in V/m

6.1 PHANTOM, HOLDER, & EQUIVALENT TISSUES

6.2 Generic Twin Phantom

The Generic Twin Phantom is constructed of a fiberglass shell integrated in a wooden table. The shape of the shell is based on data from an anatomical study designed to determine the maximum exposure in at least 90% of all users [9][10]. It enables the dosimetric evaluation of left and right hand phone usage as well as body mounted usage at the flat phantom region. A cover prevents the evaporation of the liquid. Reference markings on the Phantom allow the complete setup of all predefined phantom positions and measurement grids by manually teaching three points in the robot. See Figure 8.



Fig. 8 Generic Twin Phantom

Shell Thickness	2 ± 0.1 mm
Filling Volume	Volume Approx. 20 liters
Dimensions	810 x 1000 x 500 mm (H x L x W)

6.3 Tissue Simulating Mixture Characterization

The tissue mixtures consist of a viscous gel using hydroxethylcellulose (HEC) gelling agent and saline solution (see Table 1). Preservation with a bacteriacide is added and visual inspection is made to make sure air bubbles are not trapped during the mixing process. The mixture is calibrated to obtain proper dielectric constant (permittivity) and conductivity of the desired tissue. The mixture characterizations used for the tissue simulating liquids are according to the data by C. Gabriel and G. Hartsgrove [11].

MIXTURE %	FREQUENCY BRAIN 2450 MHz	FREQUENCY MUSCLE 2450 MHz
WATER	45.0	61.6
SUGAR	53.9	36.0
SALT	0.00	0.30
BACTERIACIDE	0.10	0.10
HEC	1.00	2.00

Table 1. Composition of the Tissue Equivalent Matter

Device Holder for Transmitters

In combination with the Generic Twin Phantom V3.0, the Mounting Device (POM) enables the rotation of the mounted transmitter in spherical coordinates whereby the rotation points is the ear opening. The devices can be easily, accurately, and repeatably positioned according to the FCC and CENELEC specifications. The device holder can be locked at different phantom locations (left head, right head, flat phantom).

* Note: A simulating human hand is not used due to the complex anatomical and geometrical structure of the hand that may produced infinite number of configurations [10]. To produce the worst-case condition (the hand absorbs antenna output power), the hand is omitted during the tests.

Fig. 9. Device Holder

7.1 SYSTEM SPECIFICATIONS

7.2 Robotic System Specifications

Specifications

POSITIONER: Stäubli Unimation Corp. Robot Model: RX60L
Repeatability: 0.02 mm
No. of axis: 6

Data Acquisition Electronic (DAE) System

Cell Controller

Processor: Pentium III
Clock Speed: 450 MHz
Operating System: Windows NT
Data Card: DASY3 PC-Board

Data Converter

Features: Signal Amplifier, multiplexer, A/D converter, and control logic
Software: DASY3 software
Connecting Lines: Optical downlink for data and status info.
Optical uplink for commands and clock

PC Interface Card

Function: 24 bit (64 MHz) DSP for real time processing
Link to DAE3
16 bit A/D converter for surface detection system
serial link to robot
direct emergency stop output for robot

E-Field Probes

Model: ET3DV6 S/N: 1560
Construction: Triangular core fiber optic detection system
Frequency: 10 MHz to 6 GHz
Linearity: ± 0.2 dB (30 MHz to 3 GHz)

Phantom

Phantom: Generic Twin
Shell Material: Fiberglass
Thickness: 2.0 ± 0.1 mm

Tissue Parameters

	2450 MHz (Brain)	2450 MHz (Muscle)
Dielectric Constant: ϵ	39.2	52.2
Conductivity: σ	1.80	2.85

8.1 MEASUREMENT PROCESS

8.2 System Verification

Prior to SAR assessment, the system is verified to the $\pm 5\%$ of the specifications at 1900MHz by using the system validation kit (graphic plot attached).

Validation Kit	Muscle	Targeted SAR _{1g} (mW/g)	Measured SAR _{1g} (mW/g)
D1900V2, S/N # 502		10.7	10.9

8.3 Dosimetric Assessment Setup

The evaluation was performed with the following procedure:

1. The SAR value at a fixed location above the ear point was measured and was used as a reference value for assessing the power drop.
2. The SAR distribution at the exposed side of the head was measured at a distance of 3.9mm from the inner surface of the shell. The area covered the entire dimension of the head and the horizontal grid spacing was 20mm x 20mm. Based on this data, the area of the maximum absorption was determined by spline interpolation.
3. Around this point, a volume of 32mm x 32mm x 34mm was assessed by measuring 5 x 5 x 7 points. On this basis of this data set, the spatial peak SAR value was evaluated with the following procedure:
 - a. The data at the surface were extrapolated, since the center of the dipoles is 2.7mm away from the tip of the probe and the distance between the surface and the lowest measuring point is 1.2mm. The extrapolation was based on a least square algorithm [13]. A polynomial of the fourth order was calculated through the points in z-axes. This polynomial was then used to evaluate the points between the surface and the probe tip.
 - b. The maximum interpolated value was searched with a straight-forward algorithm. Around this maximum the SAR values averaged over the spatial volumes (1g or 10g) were computed using the 3D-Spline interpolation algorithm. The 3D-spline is composed of three one-dimensional splines with the "Not a knot" condition (in x, y, and z directions) [13][14]. The volume was integrated with the trapezoidal algorithm. One thousand points (10 x 10 x 10) were interpolated to calculate the average.
 - c. All neighboring volumes were evaluated until no neighboring volume with a higher average value was found.
4. The SAR value, at the same location as procedure #1, was re-measured. If the value changed by more than 5%, the evaluation is repeated.

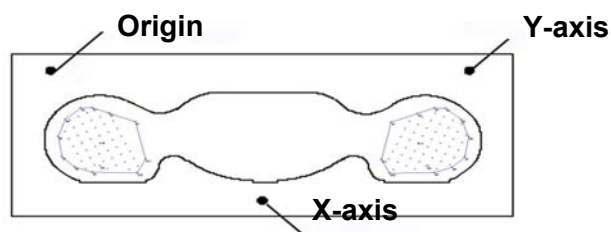

Fig 10. SAR Measurement Points in Area Scan

9.1 TEST POSITION OF THE PHONE

9.2 HANDSET TEST POSITION

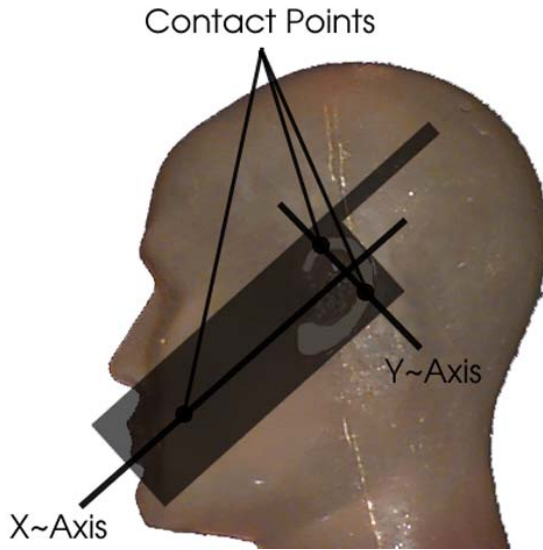

Figure 11. Diagram showing Typical Alignment & Contact Points

The device was placed in a normal operating position with the center of its ear-piece aligned with the location of the ear canal on the phantom (See Fig. 11). With the ear-piece pressed against the head, the vertical center line of the body of the handset was aligned with an imaginary plane consisting of the three lines joining both ears and the tip of the mouth. While maintaining these alignments, the body of the handset was gradually moved towards the cheek until any point on the mouth-piece or keypad contacted the cheek [15]. An upper right-hand corner antenna requires the left-hand phantom while handsets with an upper left antenna requires the right-hand phantom. The handset was tested both with its antenna extended (out) and retracted (in). A sample diagram of a typical handset shows the ear-piece at the center of the X and Y axis, placed at the center of the ear canal of the phantom (see Fig. 12 and 13).

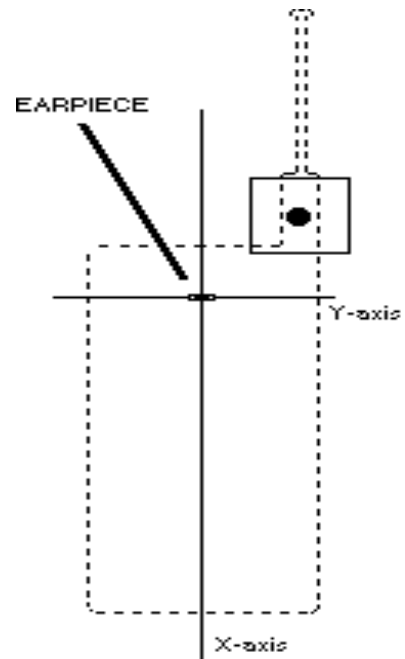

Fig 12. Sample of Handset Alignment with the Ear Canal of the Phantom

Figure 13. Origin of Axis at Ear-piece Position

10.1 BODY-WORN CONFIGURATION TEST SETUP

10.2 Ear-Microphone Jack

Portable transmitting devices which have an Ear-Microphone jack must be evaluated for RF exposure in a body-worn configuration. The testing is performed with the use of a torso phantom filled with muscle equivalent tissue. The EUT is positioned with the keypad facing away from the phantom, and the Ear-Microphone wire attached to the phone jack, simulating the device placed in a shirt pocket or attached to a body holster. The SAR tests are then performed in both the antenna in and antenna out positions using the low, middle, and high channels to investigate the worst case SAR value (see Figure 14). Please note that body-worn configurations which have not been SAR tested may result in operating conditions that could exceed FCC RF exposure limits, therefore, users are cautioned to use tested and/or approved accessories.

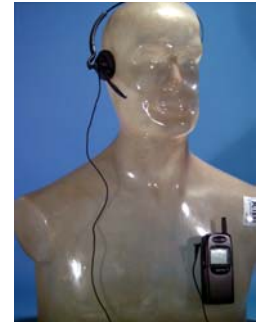

Figure 14.
Ear-Microphone Jack

A. Shirt Pocket Configuration

The shirt pocket configuration is used for devices designed to be body-worn, and small enough to be placed inside a shirt pocket. To simulate the worst-case configuration, the EUT is placed in a torso position on the phantom with the keypad facing away from the phantom, and the Ear-Microphone wire connected to the phone to simulate hands-free operation in a shirt-pocket configuration (see Figure 15).

Figure 15.
Shirt Pocket Configuration

B. Body Holster Configuration

The body holster configuration is used for body-worn devices which have a body holster accessory. Typically, a holster or carrying case is provided or available as an accessory item for supporting headset and body-worn operations. SAR may vary depending on the body separation distance provided by the type of holster and batteries supplied for a phone. In most cases, the antenna may become closer to the user's body than next to the head. The design of the holster permits the phone to be positioned only with the keypad facing away from the phantom. Proper usage of the holster restricts the antenna to a specified distance away from the surface of the body. For this test the EUT is placed into the holster and the holster is positioned against the torso of the phantom in a normal operating position. The Ear-Microphone wire is then connected to the phone to simulate hands-free operation in a body holster configuration (see Figure 16).

Figure 16.
Body Holster Configuration

C. Other Configurations

If other operating configurations are possible (i.e.: pants pocket, car adapter kit, etc), it will be indicated to users in the instruction manual about untested conditions and the possibility of exceeding FCC RF exposure limits for such use or the use of third-party accessories. If there is a high potential for exceeding limits in certain unintended configurations, a warning statement will be included in the manual, warning the user to avoid such operating conditions.

11.1 ANSI/IEEE C95.1 - 1992 RF EXPOSURE LIMITS

HUMAN EXPOSURE	UNCONTROLLED ENVIRONMENT General Population (W/kg) or (mW/g)	CONTROLLED ENVIRONMENT Occupational (W/kg) or (mW/g)
SPATIAL PEAK SAR * (Brain)	1.60	8.00
SPATIAL AVERAGE SAR ** (Whole Body)	0.08	0.40
SPATIAL PEAK SAR *** (Hands / Feet / Ankle / Wrist)	4.00	20.00

Table 2. Safety Limits for Partial Body Exposure [2]

NOTES:

- * The Spatial Peak value of the SAR averaged over any 1 gram of tissue (defined as a tissue volume in the shape of a cube) and over the appropriate averaging time.
- ** The Spatial Average value of the SAR averaged over the whole-body.
- *** The Spatial Peak value of the SAR averaged over any 10 grams of tissue (defined as a tissue volume in the shape of a cube) and over the appropriate averaging time.

Uncontrolled Environments are defined as locations where there is the exposure of individuals who have no knowledge or control of their exposure.

Controlled Environments are defined as locations where there is exposure that may be incurred by persons who are aware of the potential for exposure, (i.e. as a result of employment or occupation).

12.1 MEASUREMENT UNCERTAINTIES

Measurement uncertainties in SAR measurements are difficult to quantify due to several variables including biological, physiological, and environmental. However, we estimate the measurement uncertainties in SAR to be less than 15-25 % [16].

According to ANSI/IEEE C95.3, the overall uncertainties are difficult to assess and will vary with the type of meter and usage situation. However, accuracy's of ± 1 to 3 dB can be expected in practice, with greater uncertainties in near-field situations and at higher frequencies (shorter wavelengths), or areas where large reflecting objects are present. Under optimum measurement conditions, SAR measurement uncertainties of at least ± 2 dB can be expected.[3]

According to CENELEC [17], typical worst-case uncertainty of field measurements is ± 5 dB. For well-defined modulation characteristics the uncertainty can be reduced to ± 3 dB.

Uncertainty Description	Error	Distribution	Weight	Std. Deviation	Offset
Probe Uncertainty					
Axial isotropy	± 0.2 dB	U-Shaped	0.5	± 2.4 %	
Spherical isotropy	± 0.4 dB	U-Shaped	0.5	± 4.8 %	
Isotropy from gradient	± 0.5 dB	U-Shaped	0	\pm	
Spatial resolution	± 0.5 %	Normal	1	± 0.5 %	
Linearity error	± 0.2 dB	Rectangle	1	± 2.7 %	
Calibration error	± 3.3 %	Normal	1	± 3.3 %	
SAR Evaluation Uncertainty					
Data acquisition error	± 1 %	Rectangle	1	± 0.6 %	
ELF and RF disturbances	± 0.25 %	Normal	1	± 0.25 %	
Conductivity assessment	± 10 %	Rectangle	1	± 5.8 %	
Spatial Peak SAR Evaluation Uncertainty					
Extrapolated boundary effect	± 3 %	Normal	1	± 3 %	± 5 %
Probe positioning error	± 0.1 mm	Normal	1	± 1 %	
Integrated and cube orientation	± 3 %	Normal	1	± 3 %	
Cube Shape inaccuracies	± 2 %	Rectangle	1	± 1.2 %	
Device positioning	± 6 %	Normal	1	± 6 %	
Combined Uncertainties				± 11.7 %	± 5 %

Table 3. Breakdown of Errors [18]

13.1 SAR TEST DATA SUMMARY

Ambient TEMPERATURE (°C)	21.8
Relative HUMIDITY (%)	60.1
Atmospheric PRESSURE (kPa)	99.5

Mixture Type: 2450MHz Muscle
 Dielectric Constant: 52.2
 Conductivity: 2.85

13.3 Measurement Results (DSSS Body SAR w/ Holster)

FREQUENCY		Modulation	POWER * (W)	Separation Distance (cm)**	Antenna Position	SAR (W/kg)
MHz	Ch.					
2412	Low	DSSS	177mW	2.0cm [w/Holster]	Fixed	0.044
2437	Mid	DSSS	152mW	2.0cm [w/Holster]	Fixed	0.039
2462	High	DSSS	122mW	2.0cm [w/Holster]	Fixed	0.038
ANSI / IEEE C95.1 1992 - SAFETY LIMIT Spatial Peak Uncontrolled Exposure/General Population				Body 1.6 W/kg (mW/g) averaged over 1 gram		

NOTES:

- All modes of operation were investigated and the worst-case are reported.
 - Battery condition is fully charged for all readings.
 - Battery Type Standard Extended
 - * Power Measured Conducted EIRP ERP
 - SAR Measurement System SPEAG IDX
 - SAR Configuration Head Body Hand
 - ** Test Configuration Body Holster Without Body Holster
- Holster containing EUT is placed at an appropriate angle so as to be entirely against flat phantom.



 Randy Ortanez
 President



Figure 17. Body SAR
 Test Setup w/Holster

13.1 SAR TEST DATA SUMMARY (Continued)

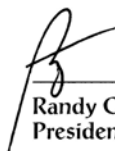
Ambient TEMPERATURE (°C)	22.3
Relative HUMIDITY (%)	59.8
Atmospheric PRESSURE (kPa)	99.7

Mixture Type: 2450MHz Muscle
 Dielectric Constant: 52.2
 Conductivity: 2.85

13.4 Measurement Results (DSSS Hand SAR – Front* of EUT)

FREQUENCY		Modulation	POWER ** (W)	Phantom Position	Antenna Position	SAR (W/kg)
MHz	Ch.					
2412	Low	DSSS	177mW	Flat	Fixed	0.390
2437	Mid	DSSS	152mW	Flat	Fixed	0.337
2462	High	DSSS	122mW	Flat	Fixed	0.305
ANSI / IEEE C95.1 1992 - SAFETY LIMIT Spatial Peak Uncontrolled Exposure/General Population				Hand 4.0 W/kg (mW/g) averaged over 10 grams		

NOTES:

- All modes of operation were investigated and the worst-case are reported.
 - Battery condition is fully charged for all readings.
 - Battery Type Standard Extended
 - ** Power Measured Conducted EIRP ERP
 - SAR Measurement System SPEAG IDX
 - SAR Configuration Head Body Hand
- *Spacing = Touch; Front panel (antenna flip-side) of EUT is placed parallel to flat phantom.



 Randy Ortanez
 President



Figure 18. Hand SAR Test Setup

13.1 SAR TEST DATA SUMMARY (Continued)

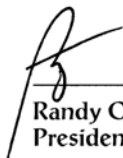
Ambient TEMPERATURE (°C)	22.3
Relative HUMIDITY (%)	59.8
Atmospheric PRESSURE (kPa)	99.7

Mixture Type: 2450MHz Muscle
 Dielectric Constant: 52.2
 Conductivity: 2.85

13.5 Measurement Results (DSSS Hand SAR – Back* of EUT)

FREQUENCY		Modulation	POWER * (W)	Phantom Position	Antenna Position	SAR (W/kg)
MHz	Ch.					
2412	Low	DSSS	177mW	Flat	Fixed	0.091
2437	Mid	DSSS	152mW	Flat	Fixed	0.080
2462	High	DSSS	122mW	Flat	Fixed	0.080
ANSI / IEEE C95.1 1992 - SAFETY LIMIT Spatial Peak Uncontrolled Exposure/General Population				Hand 4.0 W/kg (mW/g) averaged over 10 grams		

NOTES:

- All modes of operation were investigated and the worst-case are reported.
- Battery condition is fully charged for all readings.
- Battery Type Standard Extended
- ** Power Measured Conducted EIRP ERP
- SAR Measurement System SPEAG IDX
- SAR Configuration Head Body Hand
 *Spacing = Touch; Back panel (antenna side) of EUT is placed parallel to flat phantom.



 Randy Ortanez
 President



Figure 19. Hand SAR Test Setup

14.1 SAR TEST EQUIPMENT

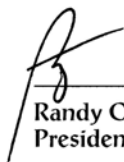
Type / Model	Calib. Date	S/N:
Stäubli Robot RX60L	Feb. 01	599131-01
Stäubli Robot Controller	Feb. 01	PCT592
Stäubli Teach Pendant (Joystick)	Feb. 01	3323-00161
Micron Computer 450 MHz Pentium III, Windows NT	Feb. 01	PCT577
SPEAG EDC3	Feb. 01	321
SPEAG DAE3	Feb. 01	330
SPEAG E-Field Probe ET3DV6	Feb. 01	1560
SPEAG Dummy Probe	Feb. 01	PCT583
SPEAG Generic Twin Phantom	Feb. 01	PCT587
SPEAG Light Alignment Sensor	Feb. 01	205
SPEAG Validation Dipole D1900V2	Feb. 01	PCT593
Muscle Equivalent Matter (2450MHz)	June 01	PCTBEM18
Robot Table		PCT586
Phone Holder		PCT588
A/B Power Indicator		PCT589
Remote Power Switch		PCT590
Phantom Cover		PCT591
HP Spectrum Analyzer	Dec. 00	PCT200
IFI TEM Cell Model: CC110EXX (DC - 2000 MHz)	Jan. 01	A427-0697
Microwave Amp. Model: 5S1G4 (800MHz - 4.2GHz, 5 Watts)	Jan. 01	22332

NOTE:

The E-field probe was calibrated by SPEAG. The SAR calibration of the E-field probe is performed by temperature measurement procedure. A TEM cell is used for the free space calibration of the probe. The brain simulating material is calibrated by PCTEST using the dielectric probe system and network analyzer to determine the conductivity and permittivity (dielectric constant) of the brain-equivalent material.

The following list of equipment was used to calibrate the brain equivalent material:

Power Meter	Gigatronics 8651A
Signal Generator	HP-8651A (9kHz ~ 4GHz)
Power Amp	Amplifier Research 5S1G4 (5 Watts, 800MHz ~ 4.2GHz)
Network Analyzer	HP-8753E (30kHz ~ 3GHz)
Dielectric Probe Kit	HP85070B

15.1 CONCLUSION

The SAR measurement indicates that the EUT complies with the RF radiation exposure limits of the FCC. These measurements are taken to simulate the RF effects exposure under worst-case conditions. Precise laboratory measures were taken to assure repeatability of the tests.

Please note that the absorption and distribution of electromagnetic energy in the body are very complex phenomena that depend on the mass, shape, and size of the body, the orientation of the body with respect to the field vectors, and the electrical properties of both the body and the environment. Other variables that may play a substantial role in possible biological effects are those that characterize the environment (e.g. ambient temperature, air velocity, relative humidity, and body insulation) and those that characterize the individual (e.g. age, gender, activity level, debilitation, or disease). Because innumerable factors may interact to determine the specific biological outcome of an exposure to electromagnetic fields, any protection guide shall consider maximal amplification of biological effects as a result of field-body interactions, environmental conditions, and physiological variables.[3]

16.1 REFERENCES

- [1] Federal Communications Commission, ET Docket 93-62, Guidelines for Evaluating the Environmental Effects of Radiofrequency Radiation, Aug. 1996.
- [2] ANSI/IEEE C95.1 - 1991, *American National Standard safety levels with respect to human exposure to radio frequency electromagnetic fields, 300kHz to 100GHz*, New York: IEEE, Aug. 1992
- [3] ANSI/IEEE C95.3 - 1991, *IEEE Recommended Practice for the Measurement of Potentially Hazardous Electromagnetic Fields - RF and Microwave*, New York: IEEE, 1992.
- [4] NCRP, National Council on Radiation Protection and Measurements, *Biological Effects and Exposure Criteria for RadioFrequency Electromagnetic Fields*, NCRP Report No. 86, 1986. Reprinted Feb. 1995.
- [5] T. Schmid, O. Egger, N. Kuster, *Automated E-field scanning system for dosimetric assessments*, IEEE Transaction on Microwave Theory and Techniques, vol. 44, Jan. 1996, pp. 105-113.
- [6] K. Pokovic, T. Schmid, N. Kuster, *Robust setup for precise calibration of E-field probes in tissue simulating liquids at mobile communications frequencies*, ICECOM97, Oct. 1997, pp. 120-124.
- [7] K. Poković, T. Schmid, and N. Kuster, *E-field Probe with improved isotropy in brain simulating liquids*, Proceedings of the ELMAR, Zadar, Croatia, June 23-25, 1996, pp. 172-175.
- [8] Schmid & Partner Engineering AG, Application Note: Data Storage and Evaluation, June 1998, p2.
- [9] V. Hombach, K. Meier, M. Burkhardt, E. Kuhn, N. Kuster, *The Dependence of EM Energy Absorption upon Human Head Modeling at 900 MHz*, IEEE Transaction on Microwave Theory and Techniques, vol. 44 no. 10, Oct. 1996, pp. 1865-1873.
- [10] N. Kuster and Q. Balzano, *Energy absorption mechanism by biological bodies in the near field of dipole antennas above 300MHz*, IEEE Transaction on Vehicular Technology, vol. 41, no. 1, Feb. 1992, pp. 17-23.
- [11] G. Hartsgrove, A. Kraszewski, A. Surowiec, *Simulated Biological Materials for Electromagnetic Radiation Absorption Studies*, University of Ottawa, Bioelectromagnetics, Canada: 1987, pp. 29-36.
- [12] Q. Balzano, O. Garay, T. Manning Jr., *Electromagnetic Energy Exposure of Simulated Users of Portable Cellular Telephones*, IEEE Transactions on Vehicular Technology, vol. 44, no.3, Aug. 1995.
- [13] W. Gander, *Computermathematick*, Birkhaeuser, Basel, 1992.
- [14] W.H. Press, S.A. Teukolsky, W.T. Vetterling, and B.P. Flannery, *Numerical Recipes in C, The Art of Scientific Computing*, Second edition, Cambridge University Press, 1992.
- [15] Federal Communications Commission, OET Bulletin 65, *Evaluating Compliance with FCC Guidelines for Human Exposure to Radiofrequency Electromagnetic Fields*. Supplement C, Dec. 1997.
- [16] N. Kuster, R. Kastle, T. Schmid, *Dosimetric evaluation of mobile communications equipment with known precision*, IEEE Transaction on Communications, vol. E80-B, no. 5, May 1997, pp. 645-652.
- [17] CENELEC CLC/SC111B, European Prestandard (prENV 50166-2), *Human Exposure to Electromagnetic Fields High-frequency: 10kHz-300GHz*, Jan. 1995.
- [18] Prof. Dr. Niels Kuster, ETH, Eidgenössische Technische Hochschule Zürich, *Dosimetric Evaluation of the Cellular Phone*.



PCTEST Engineering Laboratory, Inc.

6660-B Dobbin Road • Columbia, MD 21045 • U.S.A.

TEL (410) 290-6652 • FAX (410) 290-6654

www.pctestlab.com

CERTIFICATE OF COMPLIANCE (SAR EVALUATION)

Symbol Technologies Inc.
1 Symbol Plaza
Holtsville, NY 11742-1300
Attn: Sandy Mazzola, Regulatory Engineer
cc: Dean La Rosa, Senior Design Engineer

Dates of Tests: June 07-08, 2001
Test Report S/N: SAR.210531343.H9P
Test Site: PCTEST Lab, Columbia MD U.S.A.

FCC ID

H9PSPT1846

APPLICANT

SYMBOL TECHNOLOGIES INC.

EUT Type:	2.4GHz Pen Terminal w/ 11Mb Direct Sequence Spread Spectrum (DSSS) Internal LAN radio card (PCMCIA internal card FCC ID: H9PLA4121)
Tx/Rx Frequency:	2412 – 2462 MHz
Max. Radiated Power:	0.135 Watts (21.3dBm)
Max. Peak SAR:	0.044 mW/g (1 g. avg) DSSS Body SAR; 0.390 mW/g (10 g. avg) DSSS Hand SAR
Trade Name/Model(s):	<i>SYMBOL SPT1846</i>
FCC Classification:	Part 15 Spread Spectrum Transmitter
Application Type:	Certification
Tx Original Grant Date:	Internal 11Mb DSSS LAN Radio PCMCIA Card Symbol FCC ID: H9PLA4121 July 31, 2000
Serial Number:	n/a (pre-production)
FCC Rule Part(s):	§ 2.1093; ET Docket 96.326

This wireless portable device has been shown to be capable of compliance for localized specific absorption rate (SAR) for uncontrolled environment/general population exposure limits specified in ANSI/IEEE Std. C95.1-1992 and had been tested in accordance with the measurement procedures specified in ANSI/IEEE Std. C95.3-1992 (See Test Report).

I attest to the accuracy of data. All measurements reported herein were performed by me or were made under my supervision and are correct to the best of my knowledge and belief. I assume full responsibility for the completeness of these measurements and vouch for the qualifications of all persons taking them.

NVLAP accreditation does not constitute any product endorsement by NVLAP or any agency of the United States Government.

PCTEST certifies that no party to this application has been denied the FCC benefits pursuant to Section 5301 of the Anti-Drug Abuse Act of 1988, 21 U.S.C. 862.





Randy Ortanez
President



Table of Contents

ATTACHMENT A - COVER LETTER	
ATTACHMENT B - ATTESTATION STATEMENT(S)	
ATTACHMENT C - SAR MEASUREMENT REPORT	
1.1 SCOPE	1
2.1 INTRODUCTION / SAR DEFINITION	2
3.1 SAR MEASUREMENT SET-UP	3
4.1 E-FIELD PROBE SYSTEM	4
5.1 E-FIELD PROBE CALIBRATION PROCESS	5
5.3 DATA EXTRAPOLATION	6
6.1 PHANTOM, HOLDER & EQUIVALENT TISSUES	7
7.1 SYSTEM SPECIFICATIONS	8
8.1 MEASUREMENT PROCESS	9
9.1 TEST POSITION OF THE PHONE	10
10.1 BODY-WORN CONFIGURATION	11
11.1 ANSI/IEEE C95.1 RF EXPOSURE LIMITS	12
12.1 MEASUREMENT UNCERTAINTIES	13
13.1 TEST DATA SUMMARY	14-16
14.1 SAR TEST EQUIPMENT LIST	17
15.1 CONCLUSION	18
16.1 REFERENCES	19
ATTACHMENT D - FCC ID LABEL & LOCATION	
ATTACHMENT E - BLOCK DIAGRAM(S)	
ATTACHMENT F - SCHEMATIC DIAGRAM(S)	
ATTACHMENT G - OPERATIONAL DESCRIPTION	
ATTACHMENT H - EXTERNAL PHOTOGRAPHS	
ATTACHMENT I - INTERNAL PHOTOGRAPHS	
ATTACHMENT J - USER'S MANUAL	
ATTACHMENT K - PART 15.247 MEASUREMENT REPORT	
ATTACHMENT L - SAR TEST DATA	
ATTACHMENT M - SAR TEST SETUP PHOTOGRAPHS	
ATTACHMENT N - DIPOLE VALIDATION PLOTS	
ATTACHMENT O - PROBE CALIBRATION DATA	
ATTACHMENT P - COPY OF INTERNAL FHSS LAN RADIO CARD FCC GRANT	

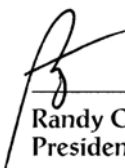
SAR MEASUREMENT REPORT

1.1 Scope

Environmental evaluation measurements of specific absorption rate¹ (SAR) distributions in simulated human head and body tissues exposed to radiofrequency (RF) radiation from wireless portable devices for compliance with the rules and regulations of the U.S. Federal Communications Commission (FCC).²

Company Name:	Symbol Technologies Inc.
Address:	1 Symbol Plaza Holtsville, NY 11742-1300
Attention:	Sandy Mazzola, Regulatory Engineer
cc:	Dean La Rosa, Senior Design Engineer

- EUT Type: 2.4GHz Pen Terminal
w/ 11Mb Direct Sequence Spread Spectrum (DSSS)
Int. LAN radio card (PCMCIA int. card FCC ID: H9PLA4121)
- Trade Name: **SYMBOL**
- FCC IDENTIFIER: **H9PSPT1846**
- Model: **SPT 1846**
- S/N: Pre-production
- Tx/Rx Frequency: 2412 – 2462 MHz
- Application Type: Certification
- FCC Classification: Part 15 Spread Spectrum Transmitter
- Method/System: Direct Sequence Spread
Spectrum System (DSSS)
- FCC Rule Part(s): § 2.1093, Docket 96-326
- Max. Radiated Power: 0.135 Watts (21.3dBm)
- Max. SAR Measurements: 0.044 mW/g (1 g. avg) DSSS Body SAR;
0.390 mW/g (10 g. avg) DSSS Hand SAR
- Modulation: Spread Spectrum Transmitter (DSS)
- Dates of Test(s): June 07-08, 2001
- Place of Test(s): PCTEST Engineering Lab.
Columbia, MD, U.S.A.
- Report Serial No.: SAR.210531343.H9P
- Original Grant Date: Internal 11Mb DSSS LAN Radio PCMCIA Card
Symbol FCC ID: H9PLA4121
April 27, 2001



Fig. 1 SAR Test Setup



¹ Specific Absorption Rate (SAR) is a measure of the rate of energy absorption due to exposure to an RF transmitting source (wireless portable device).

² IEEE/ANSI Std. C95.1-1992 limits are used to determine compliance with FCC ET Docket 93-62.

2.1 INTRODUCTION

The FCC has adopted the guidelines for evaluating the environmental effects of radiofrequency radiation in ET Docket 93-62 on Aug. 6, 1996 to protect the public and workers from the potential hazards of RF emissions due to FCC-regulated portable devices.[1]

The safety limits used for the environmental evaluation measurements are based on the criteria published by the American National Standards Institute (ANSI) for localized specific absorption rate (SAR) in *IEEE/ANSI C95.1-1992 Standard for Safety Levels with Respect to Human Exposure to Radio Frequency Electromagnetic Fields, 3 kHz to 300 GHz*. (c) 1992 by the Institute of Electrical and Electronics Engineers, Inc., New York, New York 10017.[2] The measurement procedure described in *IEEE/ANSI C95.3-1992 Recommended Practice for the Measurement of Potentially Hazardous Electromagnetic Fields - RF and Microwave*[3] is used for guidance in measuring SAR due to the RF radiation exposure from the Equipment Under Test (EUT). These criteria for SAR evaluation are similar to those recommended by the National Council on Radiation Protection and Measurements (NCRP) in *Biological Effects and Exposure Criteria for Radiofrequency Electromagnetic Fields*, NCRP Report No. 86 (c) NCRP, 1986, Bethesda, MD 20814.[4] SAR is a measure of the rate of energy absorption due to exposure to an RF transmitting source. SAR values have been related to threshold levels for potential biological hazards.

2.2 SAR Definition

Specific Absorption Rate (SAR) is defined as the time derivative (rate) of the incremental energy (dU) absorbed by (dissipated in) an incremental mass (dm) contained in a volume element (dV) of a given density (ρ). It is also defined as the rate of RF energy absorption per unit mass at a point in an absorbing body (see Fig. 2).

$$SAR = \frac{d}{dt} \left(\frac{dU}{dm} \right) = \frac{d}{dt} \left(\frac{dU}{\rho dV} \right)$$

Figure 2. SAR Mathematical Equation

SAR is expressed in units of Watts per Kilogram (W/kg).

$$SAR = \sigma E^2 / \rho$$

where:

$$\begin{aligned} \sigma &= \text{conductivity of the tissue-simulant material (S/m)} \\ \rho &= \text{mass density of the tissue-simulant material (kg/m}^3\text{)} \\ E &= \text{Total RMS electric field strength (V/m)} \end{aligned}$$

NOTE: The primary factors that control rate of energy absorption were found to be the wavelength of the incident field in relations to the dimensions and geometry of the irradiated organism, the orientation of the organism in relation to the polarity of field vectors, the presence of reflecting surfaces, and whether conductive contact is made by the organism with a ground plane.[4]

3.1 SAR MEASUREMENT SET-UP

These measurements are performed using the DASY3 automated dosimetric assessment system. It is made by Schmid & Partner Engineering AG (SPEAG) in Zurich, Switzerland. It consists of high precision robotics system (Staubli), robot controller, Pentium III computer, near-field probe, probe alignment sensor, and the generic twin phantom containing the brain equivalent material. The robot is a six-axis industrial robot performing precise movements to position the probe to the location (points) of maximum electromagnetic field (EMF) (see Fig. 2).

A cell controller system contains the power supply, robot controller, teach pendant (Joystick), and remote control, is used to drive the robot motors. The PC consists of the Micron Pentium III 500 MHz computer with Windows NT system and SAR Measurement Software DASY3, A/D interface card, monitor, mouse, and keyboard. The Staubli Robot is connected to the cell controller to allow software manipulation of the robot. A data acquisition electronic (DAE) circuit performs the signal amplification, signal multiplexing, AD-conversion, offset measurements, mechanical surface detection, collision detection, etc. is connected to the Electro-optical coupler (EOC). The EOC performs the conversion from the optical into digital electric signal of the DAE and transfers data to the PC plug-in card. The DAE3 consists of a

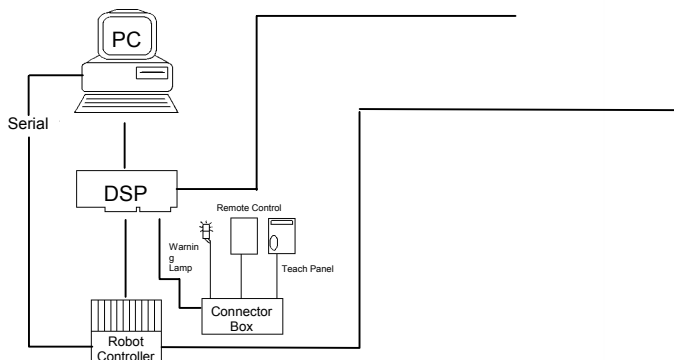

Figure 3. PCTEST SAR Lab II Test Measurement Set-up

highly sensitive electrometer-grade preamplifier with auto-zeroing, a channel and gain-switching multiplexer, a fast 16 bit AD-converter and a command decoder and control logic unit. Transmission to the PC-card is accomplished through an optical downlink for data and status information and an optical uplink for commands and clock lines. The mechanical probe mounting device includes two different sensor systems for frontal and sidewise probe contacts. They are also used for mechanical surface detection and probe collision detection. The robot uses its own controller with a built in VME-bus computer. The system is described in detail in [5].

4.1 DASY3 E-FIELD PROBE SYSTEM

4.2 ET3DV6 Probe Specification

Construction	Symmetrical design with triangular core Built-in optical fiber for surface detection System Built-in shielding against static charges
Calibration	In air from 10 MHz to 2.5 GHz In brain and muscle simulating tissue at Frequencies of 450 MHz, 900 MHz and 1.8 GHz (accuracy $\pm 8\%$)
Frequency	10 MHz to > 6 GHz; Linearity: ± 0.2 dB (30 MHz to 3 GHz)
Directivity	± 0.2 dB in brain tissue (rotation around probe axis) ± 0.4 dB in brain tissue (rotation normal probe axis)
Dynamic Range	5 : W/g to > 100 mW/g; Linearity: ± 0.2 dB
Surface Detection	± 0.2 mm repeatability in air and clear liquids over diffuse reflecting surfaces.
Dimensions	Overall length: 330 mm Tip length: 16 mm Body diameter: 12 mm Tip diameter: 6.8 mm Distance from probe tip to dipole centers: 2.7 mm
Application	General dosimetry up to 3 GHz Compliance tests of mobile phones Fast automatic scanning in arbitrary phantoms

Figure 4. Photograph of the Probe and the Phantom



Fig. 5. ET3DV6 E-field Probe

The SAR measurements were conducted with the dosimetric probe ET3DV6, designed in the classical triangular configuration [5] and optimized for dosimetric evaluation. The probe is constructed using the thick film technique; with printed resistive lines on ceramic substrates. The probe is equipped with an optical multifiber line ending at the front of the probe tip. It is connected to the EOC box on the robot arm and provides an automatic detection of the phantom surface. Half of the fibers are connected to a pulsed infrared transmitter, the other half to a synchronized receiver. As the probe approaches the surface, the reflection from the surface produces a coupling from the transmitting to the receiving fibers. This reflection increases first during the approach, reaches a maximum and then decreases. If the probe is flatly touching the surface, the coupling is zero. The distance of the coupling maximum to the surface is independent of the surface reflectivity and largely independent of the surface to probe angle. The DASY3 software reads the reflection during a software approach and looks for the maximum using a 2nd order fitting. The approach is stopped at reaching the maximum.

5.1 E-FIELD PROBE CALIBRATION PROCESS

5.2 E-Probe Calibration

Each probe is calibrated according to a dosimetric assessment procedure described in [6] with an accuracy better than +/- 10%. The spherical isotropy was evaluated with the procedure described in [7] and found to be better than +/-0.25dB. The sensitivity parameters (NormX, NormY, NormZ), the diode compression parameter (DCP) and the conversion factor (ConvF) of the probe is tested.

The free space E-field from amplified probe outputs is determined in a test chamber. This is performed in a TEM cell for frequencies below 1 GHz, and in a waveguide above 1 GHz for free space. For the free space calibration, the probe is placed in the volumetric center of the cavity and at the proper orientation with the field. The probe is then rotated 360 degrees.

E-field temperature correlation calibration is performed in a flat phantom filled with the appropriate simulated brain tissue. The measured free space E-field in the medium correlates to temperature rise in a dielectric medium. For temperature correlation calibration a RF transparent thermistor-based temperature probe is used in conjunction with the E-field probe.

$$SAR = C \frac{\Delta T}{\Delta t}$$

where:

- Δt = exposure time (30 seconds),
- C = heat capacity of tissue (brain or muscle),
- ΔT = temperature increase due to RF exposure.

SAR is proportional to $\Delta T / \Delta t$, the initial rate of tissue heating, before thermal diffusion takes place. Now it's possible to quantify the electric field in the simulated tissue by equating the thermally derived SAR to the E- field;

$$SAR = \frac{|E|^2 \cdot \sigma}{\rho}$$

where:

- σ = simulated tissue conductivity,
- ρ = Tissue density (1.25 g/cm³ for brain tissue)

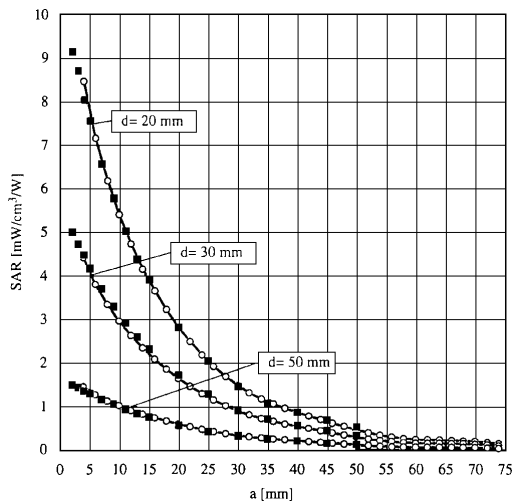

Figure 6. E-Field and Temperature measurements at 900MHz [5]

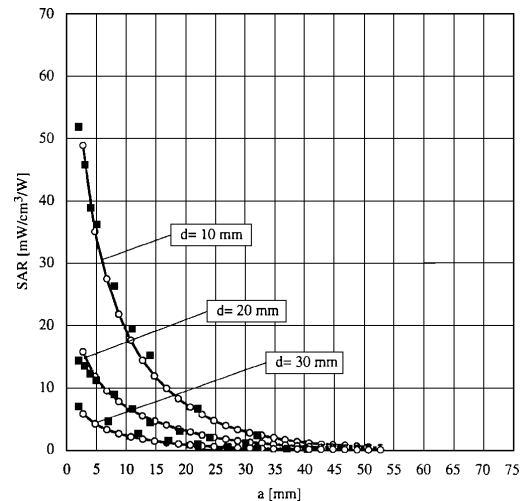

Figure 7. E-Field and temperature measurements at 1.8GHz [5]

5.3 Data Extrapolation

The DASY3 software automatically executes the following procedures to calculate the field units from the microvolt readings at the probe connector. The first step of the evaluation is a linearization of the filtered input signal to account for the compression characteristics of the detector diode. The compensation depends on the input signal, the diode type and the DC-transmission factor from the diode to the evaluation electronics. If the exciting field is pulsed, the crest factor of the signal must be known to correctly compensate for peak power. The formula for each channel can be given as [8]:

$$V_i = U_i + U_i^2 \cdot \frac{cf}{dcP_i}$$

with V_i = compensated signal of channel i (i=x,y,z)
 U_i = input signal of channel i (i=x,y,z)
 cf = crest factor of exciting field (DASY parameter)
 dcP_i = diode compression point (DASY parameter)

From the compensated input signals the primary field data for each channel can be evaluated:

E-field probes:

$$E_i = \sqrt{\frac{V_i}{Norm_i \cdot ConvF}}$$

with V_i = compensated signal of channel i (i = x,y,z)
 $Norm_i$ = sensor sensitivity of channel i (i = x,y,z)
 $\mu V/(V/m)^2$ for E-field probes
 $ConvF$ = sensitivity of enhancement in solution
 E_i = electric field strength of channel i in V/m

The RSS value of the field components gives the total field strength (Hermetian magnitude):

$$E_{tot} = \sqrt{E_x^2 + E_y^2 + E_z^2}$$

The primary field data are used to calculate the derived field units.

$$SAR = E_{tot}^2 \cdot \frac{\sigma}{\rho \cdot 1000}$$

with SAR = local specific absorption rate in W/g
 E_{tot} = total field strength in V/m
 σ = conductivity in [mho/m] or [Siemens/m]
 ρ = equivalent tissue density in g/cm³

The power flow density is calculated assuming the excitation field to be a free space field.

$$P_{pwe} = \frac{E_{tot}^2}{3770}$$

with P_{pwe} = equivalent power density of a plane wave in W/cm²
 E_{tot} = total electric field strength in V/m

6.1 PHANTOM, HOLDER, & EQUIVALENT TISSUES

6.2 Generic Twin Phantom

The Generic Twin Phantom is constructed of a fiberglass shell integrated in a wooden table. The shape of the shell is based on data from an anatomical study designed to determine the maximum exposure in at least 90% of all users [9][10]. It enables the dosimetric evaluation of left and right hand phone usage as well as body mounted usage at the flat phantom region. A cover prevents the evaporation of the liquid. Reference markings on the Phantom allow the complete setup of all predefined phantom positions and measurement grids by manually teaching three points in the robot. See Figure 8.



Fig. 8 Generic Twin Phantom

Shell Thickness	2 ± 0.1 mm
Filling Volume	Volume Approx. 20 liters
Dimensions	810 x 1000 x 500 mm (H x L x W)

6.3 Tissue Simulating Mixture Characterization

The tissue mixtures consist of a viscous gel using hydroxethylcellulose (HEC) gelling agent and saline solution (see Table 1). Preservation with a bacteriacide is added and visual inspection is made to make sure air bubbles are not trapped during the mixing process. The mixture is calibrated to obtain proper dielectric constant (permittivity) and conductivity of the desired tissue. The mixture characterizations used for the tissue simulating liquids are according to the data by C. Gabriel and G. Hartsgrove [11].

MIXTURE %	FREQUENCY BRAIN 2450 MHz	FREQUENCY MUSCLE 2450 MHz
WATER	45.0	61.6
SUGAR	53.9	36.0
SALT	0.00	0.30
BACTERIACIDE	0.10	0.10
HEC	1.00	2.00

Table 1. Composition of the Tissue Equivalent Matter

Device Holder for Transmitters

In combination with the Generic Twin Phantom V3.0, the Mounting Device (POM) enables the rotation of the mounted transmitter in spherical coordinates whereby the rotation points is the ear opening. The devices can be easily, accurately, and repeatably positioned according to the FCC and CENELEC specifications. The device holder can be locked at different phantom locations (left head, right head, flat phantom).

* Note: A simulating human hand is not used due to the complex anatomical and geometrical structure of the hand that may produced infinite number of configurations [10]. To produce the worst-case condition (the hand absorbs antenna output power), the hand is omitted during the tests.

Fig. 9. Device Holder

7.1 SYSTEM SPECIFICATIONS

7.2 Robotic System Specifications

Specifications

POSITIONER:	Stäubli Unimation Corp. Robot Model: RX60L
Repeatability:	0.02 mm
No. of axis:	6

Data Acquisition Electronic (DAE) System

Cell Controller

Processor:	Pentium III
Clock Speed:	450 MHz
Operating System:	Windows NT
Data Card:	DASY3 PC-Board

Data Converter

Features:	Signal Amplifier, multiplexer, A/D converter, and control logic
Software:	DASY3 software
Connecting Lines:	Optical downlink for data and status info. Optical uplink for commands and clock

PC Interface Card

Function:	24 bit (64 MHz) DSP for real time processing Link to DAE3 16 bit A/D converter for surface detection system serial link to robot direct emergency stop output for robot
-----------	---

E-Field Probes

Model:	ET3DV6	S/N: 1560
Construction:	Triangular core fiber optic detection system	
Frequency:	10 MHz to 6 GHz	
Linearity:	± 0.2 dB (30 MHz to 3 GHz)	

Phantom

Phantom:	Generic Twin
Shell Material:	Fiberglass
Thickness:	2.0 ± 0.1 mm

Tissue Parameters

	2450 MHz (Brain)	2450 MHz (Muscle)
Dielectric Constant: ϵ	39.2	52.2
Conductivity: σ	1.80	2.85

8.1 MEASUREMENT PROCESS

8.2 System Verification

Prior to SAR assessment, the system is verified to the $\pm 5\%$ of the specifications at 1900MHz by using the system validation kit (graphic plot attached).

Validation Kit	Muscle	Targeted SAR _{1g} (mW/g)	Measured SAR _{1g} (mW/g)
D1900V2, S/N # 502		10.7	10.9

8.3 Dosimetric Assessment Setup

The evaluation was performed with the following procedure:

1. The SAR value at a fixed location above the ear point was measured and was used as a reference value for assessing the power drop.
2. The SAR distribution at the exposed side of the head was measured at a distance of 3.9mm from the inner surface of the shell. The area covered the entire dimension of the head and the horizontal grid spacing was 20mm x 20mm. Based on this data, the area of the maximum absorption was determined by spline interpolation.
3. Around this point, a volume of 32mm x 32mm x 34mm was assessed by measuring 5 x 5 x 7 points. On this basis of this data set, the spatial peak SAR value was evaluated with the following procedure:
 - a. The data at the surface were extrapolated, since the center of the dipoles is 2.7mm away from the tip of the probe and the distance between the surface and the lowest measuring point is 1.2mm. The extrapolation was based on a least square algorithm [13]. A polynomial of the fourth order was calculated through the points in z-axes. This polynomial was then used to evaluate the points between the surface and the probe tip.
 - b. The maximum interpolated value was searched with a straight-forward algorithm. Around this maximum the SAR values averaged over the spatial volumes (1g or 10g) were computed using the 3D-Spline interpolation algorithm. The 3D-spline is composed of three one-dimensional splines with the "Not a knot" condition (in x, y, and z directions) [13][14]. The volume was integrated with the trapezoidal algorithm. One thousand points (10 x 10 x 10) were interpolated to calculate the average.
 - c. All neighboring volumes were evaluated until no neighboring volume with a higher average value was found.
4. The SAR value, at the same location as procedure #1, was re-measured. If the value changed by more than 5%, the evaluation is repeated.

Origin

Y-axis

X-axis

Fig 10. SAR Measurement Points in Area Scan

9.1 TEST POSITION OF THE PHONE

9.2 HANDSET TEST POSITION

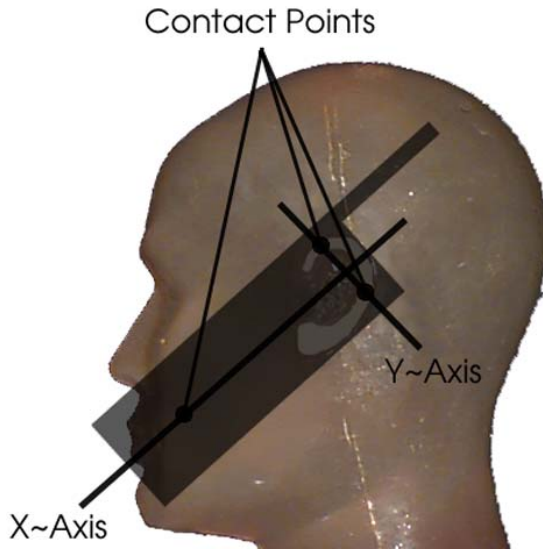

Figure 11. Diagram showing Typical Alignment & Contact Points

The device was placed in a normal operating position with the center of its ear-piece aligned with the location of the ear canal on the phantom (See Fig. 11). With the ear-piece pressed against the head, the vertical center line of the body of the handset was aligned with an imaginary plane consisting of the three lines joining both ears and the tip of the mouth. While maintaining these alignments, the body of the handset was gradually moved towards the cheek until any point on the mouth-piece or keypad contacted the cheek [15]. An upper right-hand corner antenna requires the left-hand phantom while handsets with an upper left antenna requires the right-hand phantom. The handset was tested both with its antenna extended (out) and retracted (in). A sample diagram of a typical handset shows the ear-piece at the center of the X and Y axis, placed at the center of the ear canal of the phantom (see Fig. 12 and 13).

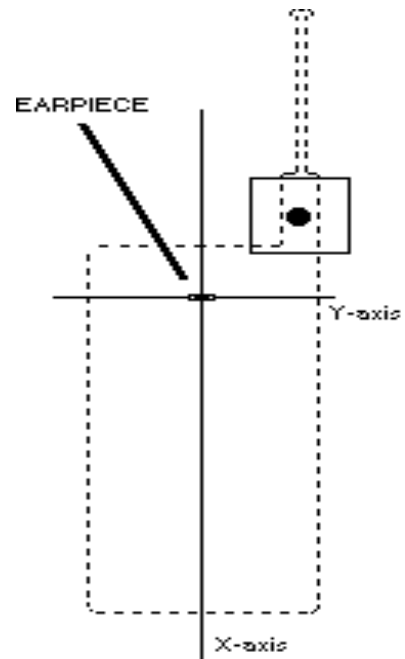

Figure 13. Origin of Axis at Ear-piece Position

Fig 12. Sample of Handset Alignment with the Ear Canal of the Phantom

10.1 BODY-WORN CONFIGURATION TEST SETUP

10.2 Ear-Microphone Jack

Portable transmitting devices which have an Ear-Microphone jack must be evaluated for RF exposure in a body-worn configuration. The testing is performed with the use of a torso phantom filled with muscle equivalent tissue. The EUT is positioned with the keypad facing away from the phantom, and the Ear-Microphone wire attached to the phone jack, simulating the device placed in a shirt pocket or attached to a body holster. The SAR tests are then performed in both the antenna in and antenna out positions using the low, middle, and high channels to investigate the worst case SAR value (see Figure 14). Please note that body-worn configurations which have not been SAR tested may result in operating conditions that could exceed FCC RF exposure limits, therefore, users are cautioned to use tested and/or approved accessories.

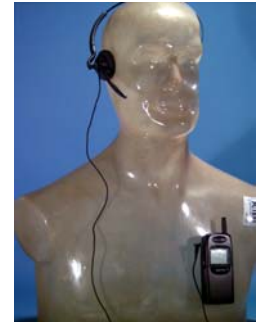

Figure 14.
Ear-Microphone Jack

A. Shirt Pocket Configuration

The shirt pocket configuration is used for devices designed to be body-worn, and small enough to be placed inside a shirt pocket. To simulate the worst-case configuration, the EUT is placed in a torso position on the phantom with the keypad facing away from the phantom, and the Ear-Microphone wire connected to the phone to simulate hands-free operation in a shirt-pocket configuration (see Figure 15).

Figure 15.
Shirt Pocket Configuration

B. Body Holster Configuration

The body holster configuration is used for body-worn devices which have a body holster accessory. Typically, a holster or carrying case is provided or available as an accessory item for supporting headset and body-worn operations. SAR may vary depending on the body separation distance provided by the type of holster and batteries supplied for a phone. In most cases, the antenna may become closer to the user's body than next to the head. The design of the holster permits the phone to be positioned only with the keypad facing away from the phantom. Proper usage of the holster restricts the antenna to a specified distance away from the surface of the body. For this test the EUT is placed into the holster and the holster is positioned against the torso of the phantom in a normal operating position. The Ear-Microphone wire is then connected to the phone to simulate hands-free operation in a body holster configuration (see Figure 16).

Figure 16.
Body Holster Configuration

C. Other Configurations

If other operating configurations are possible (i.e.: pants pocket, car adapter kit, etc), it will be indicated to users in the instruction manual about untested conditions and the possibility of exceeding FCC RF exposure limits for such use or the use of third-party accessories. If there is a high potential for exceeding limits in certain unintended configurations, a warning statement will be included in the manual, warning the user to avoid such operating conditions.

11.1 ANSI/IEEE C95.1 - 1992 RF EXPOSURE LIMITS

HUMAN EXPOSURE	UNCONTROLLED ENVIRONMENT General Population (W/kg) or (mW/g)	CONTROLLED ENVIRONMENT Occupational (W/kg) or (mW/g)
SPATIAL PEAK SAR * (Brain)	1.60	8.00
SPATIAL AVERAGE SAR ** (Whole Body)	0.08	0.40
SPATIAL PEAK SAR *** (Hands / Feet / Ankle / Wrist)	4.00	20.00

Table 2. Safety Limits for Partial Body Exposure [2]

NOTES:

- * The Spatial Peak value of the SAR averaged over any 1 gram of tissue (defined as a tissue volume in the shape of a cube) and over the appropriate averaging time.
- ** The Spatial Average value of the SAR averaged over the whole-body.
- *** The Spatial Peak value of the SAR averaged over any 10 grams of tissue (defined as a tissue volume in the shape of a cube) and over the appropriate averaging time.

Uncontrolled Environments are defined as locations where there is the exposure of individuals who have no knowledge or control of their exposure.

Controlled Environments are defined as locations where there is exposure that may be incurred by persons who are aware of the potential for exposure, (i.e. as a result of employment or occupation).

12.1 MEASUREMENT UNCERTAINTIES

Measurement uncertainties in SAR measurements are difficult to quantify due to several variables including biological, physiological, and environmental. However, we estimate the measurement uncertainties in SAR to be less than 15-25 % [16].

According to ANSI/IEEE C95.3, the overall uncertainties are difficult to assess and will vary with the type of meter and usage situation. However, accuracy's of ± 1 to 3 dB can be expected in practice, with greater uncertainties in near-field situations and at higher frequencies (shorter wavelengths), or areas where large reflecting objects are present. Under optimum measurement conditions, SAR measurement uncertainties of at least ± 2 dB can be expected.[3]

According to CENELEC [17], typical worst-case uncertainty of field measurements is ± 5 dB. For well-defined modulation characteristics the uncertainty can be reduced to ± 3 dB.

Uncertainty Description	Error	Distribution	Weight	Std. Deviation	Offset
Probe Uncertainty					
Axial isotropy	± 0.2 dB	U-Shaped	0.5	± 2.4 %	
Spherical isotropy	± 0.4 dB	U-Shaped	0.5	± 4.8 %	
Isotropy from gradient	± 0.5 dB	U-Shaped	0	\pm	
Spatial resolution	± 0.5 %	Normal	1	± 0.5 %	
Linearity error	± 0.2 dB	Rectangle	1	± 2.7 %	
Calibration error	± 3.3 %	Normal	1	± 3.3 %	
SAR Evaluation Uncertainty					
Data acquisition error	± 1 %	Rectangle	1	± 0.6 %	
ELF and RF disturbances	± 0.25 %	Normal	1	± 0.25 %	
Conductivity assessment	± 10 %	Rectangle	1	± 5.8 %	
Spatial Peak SAR Evaluation Uncertainty					
Extrapolated boundary effect	± 3 %	Normal	1	± 3 %	± 5 %
Probe positioning error	± 0.1 mm	Normal	1	± 1 %	
Integrated and cube orientation	± 3 %	Normal	1	± 3 %	
Cube Shape inaccuracies	± 2 %	Rectangle	1	± 1.2 %	
Device positioning	± 6 %	Normal	1	± 6 %	
Combined Uncertainties				± 11.7 %	± 5 %

Table 3. Breakdown of Errors [18]

13.1 SAR TEST DATA SUMMARY

Ambient TEMPERATURE (°C)	21.8
Relative HUMIDITY (%)	60.1
Atmospheric PRESSURE (kPa)	99.5

Mixture Type: 2450MHz Muscle

Dielectric Constant: 52.2

Conductivity: 2.85

13.3 Measurement Results (DSSS Body SAR w/ Holster)

FREQUENCY		Modulation	POWER * (W)	Separation Distance (cm)**	Antenna Position	SAR (W/kg)
MHz	Ch.					
2412	Low	DSSS	177mW	2.0cm [w/Holster]	Fixed	0.044
2437	Mid	DSSS	152mW	2.0cm [w/Holster]	Fixed	0.039
2462	High	DSSS	122mW	2.0cm [w/Holster]	Fixed	0.038
ANSI / IEEE C95.1 1992 - SAFETY LIMIT Spatial Peak Uncontrolled Exposure/General Population				Body 1.6 W/kg (mW/g) averaged over 1 gram		

NOTES:

- All modes of operation were investigated and the worst-case are reported.
 - Battery condition is fully charged for all readings.
 - Battery Type Standard Extended
 - * Power Measured Conducted EIRP ERP
 - SAR Measurement System SPEAG IDX
 - SAR Configuration Head Body Hand
 - ** Test Configuration Body Holster Without Body Holster
- Holster containing EUT is placed at an appropriate angle so as to be entirely against flat phantom.

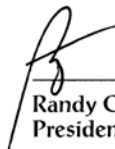

Randy Ortanez
 President

Figure 17. Body SAR
 Test Setup w/Holster

13.1 SAR TEST DATA SUMMARY (Continued)

Ambient TEMPERATURE (°C) _____ 22.3
 Relative HUMIDITY (%) _____ 59.8
 Atmospheric PRESSURE (kPa) _____ 99.7

Mixture Type: _____ 2450MHz Muscle _____

Dielectric Constant: _____ 52.2 _____

Conductivity: _____ 2.85 _____

13.4 Measurement Results (DSSS Hand SAR – Front* of EUT)

FREQUENCY		Modulation	POWER ** (W)	Phantom Position	Antenna Position	SAR (W/kg)
MHz	Ch.					
2412	Low	DSSS	177mW	Flat	Fixed	0.390
2437	Mid	DSSS	152mW	Flat	Fixed	0.337
2462	High	DSSS	122mW	Flat	Fixed	0.305
ANSI / IEEE C95.1 1992 - SAFETY LIMIT Spatial Peak Uncontrolled Exposure/General Population				Hand 4.0 W/kg (mW/g) averaged over 10 grams		

NOTES:

- All modes of operation were investigated and the worst-case are reported.
 - Battery condition is fully charged for all readings.
 - Battery Type Standard Extended
 - ** Power Measured Conducted EIRP ERP
 - SAR Measurement System SPEAG IDX
 - SAR Configuration Head Body Hand
- *Spacing = Touch; Front panel (antenna flip-side) of EUT is placed parallel to flat phantom.

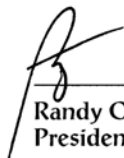

Randy Ortanez
 President

Figure 18. Hand SAR
 Test Setup

13.1 SAR TEST DATA SUMMARY (Continued)

Ambient TEMPERATURE (°C) _____ 22.3
 Relative HUMIDITY (%) _____ 59.8
 Atmospheric PRESSURE (kPa) _____ 99.7

Mixture Type: _____ 2450MHz Muscle
 Dielectric Constant: _____ 52.2
 Conductivity: _____ 2.85

13.5 Measurement Results (DSSS Hand SAR – Back* of EUT)

FREQUENCY		Modulation	POWER * (W)	Phantom Position	Antenna Position	SAR (W/kg)
MHz	Ch.					
2412	Low	DSSS	177mW	Flat	Fixed	0.091
2437	Mid	DSSS	152mW	Flat	Fixed	0.080
2462	High	DSSS	122mW	Flat	Fixed	0.080
ANSI / IEEE C95.1 1992 - SAFETY LIMIT Spatial Peak Uncontrolled Exposure/General Population				Hand 4.0 W/kg (mW/g) averaged over 10 grams		

NOTES:

- All modes of operation were investigated and the worst-case are reported.
- Battery condition is fully charged for all readings.
- Battery Type Standard Extended
- ** Power Measured Conducted EIRP ERP
- SAR Measurement System SPEAG IDX
- SAR Configuration Head Body Hand
 *Spacing = Touch; Back panel (antenna side) of EUT is placed parallel to flat phantom.



 Randy Ortanez
 President

Figure 19. Hand SAR
 Test Setup

14.1 SAR TEST EQUIPMENT

Type / Model	Calib. Date	S/N:
Stäubli Robot RX60L	Feb. 01	599131-01
Stäubli Robot Controller	Feb. 01	PCT592
Stäubli Teach Pendant (Joystick)	Feb. 01	3323-00161
Micron Computer 450 MHz Pentium III, Windows NT	Feb. 01	PCT577
SPEAG EDC3	Feb. 01	321
SPEAG DAE3	Feb. 01	330
SPEAG E-Field Probe ET3DV6	Feb. 01	1560
SPEAG Dummy Probe	Feb. 01	PCT583
SPEAG Generic Twin Phantom	Feb. 01	PCT587
SPEAG Light Alignment Sensor	Feb. 01	205
SPEAG Validation Dipole D1900V2	Feb. 01	PCT593
Muscle Equivalent Matter (2450MHz)	June 01	PCTBEM18
Robot Table		PCT586
Phone Holder		PCT588
A/B Power Indicator		PCT589
Remote Power Switch		PCT590
Phantom Cover		PCT591
HP Spectrum Analyzer	Dec. 00	PCT200
IFI TEM Cell Model: CC110EXX (DC - 2000 MHz)	Jan. 01	A427-0697
Microwave Amp. Model: 5S1G4 (800MHz - 4.2GHz, 5 Watts)	Jan. 01	22332

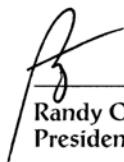
NOTE:

The E-field probe was calibrated by SPEAG. The SAR calibration of the E-field probe is performed by temperature measurement procedure. A TEM cell is used for the free space calibration of the probe. The brain simulating material is calibrated by PCTEST using the dielectric probe system and network analyzer to determine the conductivity and permittivity (dielectric constant) of the brain-equivalent material.

The following list of equipment was used to calibrate the brain equivalent material:

Power Meter	Gigatronics 8651A
Signal Generator	HP-8651A (9kHz ~ 4GHz)
Power Amp	Amplifier Research 5S1G4 (5 Watts, 800MHz ~ 4.2GHz)
Network Analyzer	HP-8753E (30kHz ~ 3GHz)
Dielectric Probe Kit	HP85070B

15.1 CONCLUSION

The SAR measurement indicates that the EUT complies with the RF radiation exposure limits of the FCC. These measurements are taken to simulate the RF effects exposure under worst-case conditions. Precise laboratory measures were taken to assure repeatability of the tests.

Please note that the absorption and distribution of electromagnetic energy in the body are very complex phenomena that depend on the mass, shape, and size of the body, the orientation of the body with respect to the field vectors, and the electrical properties of both the body and the environment. Other variables that may play a substantial role in possible biological effects are those that characterize the environment (e.g. ambient temperature, air velocity, relative humidity, and body insulation) and those that characterize the individual (e.g. age, gender, activity level, debilitation, or disease). Because innumerable factors may interact to determine the specific biological outcome of an exposure to electromagnetic fields, any protection guide shall consider maximal amplification of biological effects as a result of field-body interactions, environmental conditions, and physiological variables.[3]

16.1 REFERENCES

- [1] Federal Communications Commission, ET Docket 93-62, Guidelines for Evaluating the Environmental Effects of Radiofrequency Radiation, Aug. 1996.
- [2] ANSI/IEEE C95.1 - 1991, *American National Standard safety levels with respect to human exposure to radio frequency electromagnetic fields, 300kHz to 100GHz*, New York: IEEE, Aug. 1992
- [3] ANSI/IEEE C95.3 - 1991, *IEEE Recommended Practice for the Measurement of Potentially Hazardous Electromagnetic Fields - RF and Microwave*, New York: IEEE, 1992.
- [4] NCRP, National Council on Radiation Protection and Measurements, *Biological Effects and Exposure Criteria for RadioFrequency Electromagnetic Fields*, NCRP Report No. 86, 1986. Reprinted Feb. 1995.
- [5] T. Schmid, O. Egger, N. Kuster, *Automated E-field scanning system for dosimetric assessments*, IEEE Transaction on Microwave Theory and Techniques, vol. 44, Jan. 1996, pp. 105-113.
- [6] K. Pokovic, T. Schmid, N. Kuster, *Robust setup for precise calibration of E-field probes in tissue simulating liquids at mobile communications frequencies*, ICECOM97, Oct. 1997, pp. 120-124.
- [7] K. Poković, T. Schmid, and N. Kuster, *E-field Probe with improved isotropy in brain simulating liquids*, Proceedings of the ELMAR, Zadar, Croatia, June 23-25, 1996, pp. 172-175.
- [8] Schmid & Partner Engineering AG, Application Note: Data Storage and Evaluation, June 1998, p2.
- [9] V. Hombach, K. Meier, M. Burkhardt, E. Kuhn, N. Kuster, *The Dependence of EM Energy Absorption upon Human Head Modeling at 900 MHz*, IEEE Transaction on Microwave Theory and Techniques, vol. 44 no. 10, Oct. 1996, pp. 1865-1873.
- [10] N. Kuster and Q. Balzano, *Energy absorption mechanism by biological bodies in the near field of dipole antennas above 300MHz*, IEEE Transaction on Vehicular Technology, vol. 41, no. 1, Feb. 1992, pp. 17-23.
- [11] G. Hartsgrove, A. Kraszewski, A. Surowiec, *Simulated Biological Materials for Electromagnetic Radiation Absorption Studies*, University of Ottawa, Bioelectromagnetics, Canada: 1987, pp. 29-36.
- [12] Q. Balzano, O. Garay, T. Manning Jr., *Electromagnetic Energy Exposure of Simulated Users of Portable Cellular Telephones*, IEEE Transactions on Vehicular Technology, vol. 44, no.3, Aug. 1995.
- [13] W. Gander, *Computermathematick*, Birkhaeuser, Basel, 1992.
- [14] W.H. Press, S.A. Teukolsky, W.T. Vetterling, and B.P. Flannery, *Numerical Recipes in C, The Art of Scientific Computing*, Second edition, Cambridge University Press, 1992.
- [15] Federal Communications Commission, OET Bulletin 65, *Evaluating Compliance with FCC Guidelines for Human Exposure to Radiofrequency Electromagnetic Fields*. Supplement C, Dec. 1997.
- [16] N. Kuster, R. Kastle, T. Schmid, *Dosimetric evaluation of mobile communications equipment with known precision*, IEEE Transaction on Communications, vol. E80-B, no. 5, May 1997, pp. 645-652.
- [17] CENELEC CLC/SC111B, European Prestandard (prENV 50166-2), *Human Exposure to Electromagnetic Fields High-frequency: 10kHz-300GHz*, Jan. 1995.
- [18] Prof. Dr. Niels Kuster, ETH, Eidgenössische Technische Hochschule Zürich, *Dosimetric Evaluation of the Cellular Phone*.