



Intertek Testing Services

APPLICATION FOR FCC CERTIFICATION

Symbol Technologies Inc.

2.4 GHz 500mW Radio

Model: LA3021-500

FCC ID: H9PLA3021-500

Job# J99013298

Report# J99013298d

Number of Pages: 34 pp. + Supporting Data and Documents

Date of Report: June 22, 1999

All services undertaken are subject to the following general policy: Reports are submitted for exclusive use of the client to whom they are addressed. Their significance is subject to the adequacy and representative character of the samples and to the comprehensiveness of the tests, examinations or surveys made. No quotations from reports or use of Intertek Testing Services's name is permitted except as expressly authorized by Intertek Testing Services in writing.



Table of Contents

1.0 **Summary of Tests**..... 2

2.0 **General Description**..... 3

 2.1 Product Description 3

 2.2 Related Submittal(s) Grants..... 3

 2.3 Test Methodology..... 4

 2.4 Test Facility 4

3.0 **System Test Configuration** 5

 3.1 Support Equipment..... 5

 3.2 Block Diagram of Test Setup 5

 3.3 Justification 6

 3.4 Software Exercise Program 6

 3.5 Mode of Operation During Test 6

 3.6 Modifications Required for Compliance 6

4.0 Measurement Results..... 7

 4.1 Maximum Conducted Output Power at Antenna Terminals..... 7

 4.2 Hopping Channel 20 dB RF Bandwidth..... 8

 4.3 Minimum Number of Hopping Frequencies..... 9

 4.4 Average Channel Occupancy Time 10

 4.5 Out of Band Conducted Emissions..... 11

 4.6 Out of Band Radiated Emissions..... 12

 4.7 Transmitter Radiated Emissions in Restricted Bands 13

 4.8 Radiated Emission Configuration Photograph..... 14

 4.9 Radiated Emissions from Digital Section of Transceiver (Transmitter), 25

 4.10 Radiated Emissions from Receiver Section of Transceiver (L.O. Radiation), 26

 4.11 AC Line Conducted Emission 27

 4.12 AC Line Conducted Configuration Photograph 28

5.0 **Equipment Photographs** 29

6.0 **Product Labeling** 30

 6.1 Label Artwork 30

 6.2 Label Location..... 30

7.0 **Technical Specifications**..... 31

 7.1 Circuit Diagram..... 31

 7.2 Block Diagram..... 32

 7.3 Antenna gain and Mounting Information 33

8.0 **Instruction Manual**..... 34

Symbol Technologies Inc.

Date of Test: May 13 - June 9, 1999

FCC ID: H9PLA3021-500

1 . 0 Summary of Tests

Symbol Technologies Inc. - Model No.: LA-3021400
FCC ID: H9PLA3021-500

TEST	REFERENCE	RESULTS
Max. Output power	15.247(b)(3)	Pass
20 dB Bandwidth	15.247(a)(1)	Pass
Min. Hopping Channels	15.247(a)(1)	Pass
Average Channel Occupancy Time	15.247(a)(1)	Pass
Out of Band Antenna Conducted Emission	15.247 (c)	Pass
Out of Band Radiated Emission	15.247(c)	Not Applicable
Radiated Emission in Restricted Bands	15.247(c), 15.209(a)	Pass
AC Conducted Emission	15.207	Pass
Radiated Emission from Digital Part	15.109	Pass
Radiated Emission from Receiver L.O.	15.109	Not Applicable
Antenna Requirement	15.203	Pass

Test Engineer:

XI-Ming Yang
XI-Ming Yang

Date:

July 1, 1999

EMC Site Mgr. :

David Chernomordik
David Chernomordik, Ph.D.

Date:

1/2/99

2.0 General Description

2.1 Product Description

The Symbol Technologies Inc. Model LA3021-500 is a 2.4 GHz frequency hopping spread spectrum device.

Overview of the EUT

Applicant	Symbol Technologies Inc.
Trade Name & Model No.	Symbol Technologies, Model No. LA3021-500
FCC Identifier	H9PLA3021-500
Use of Product	
Manufacturer & Model of Spread Spectrum Module	
Type of Transmission	Frequency Hopping Spread Spectrum
Rated RF Output (mW)	500
Frequency Range (MHz)	2402 - 2480
Number of Channel(s)	79
Antenna(s) & Gain, dBi	21 antennas; see antenna data sheet
Processing Gain Measurements	<input checked="" type="checkbox"/> Will be provided directly to the FCC reviewing engineer by the client or manufacturer of the spread spectrum module
Antenna Requirement	<input type="checkbox"/> The EUT uses a permanently connected antenna. <input checked="" type="checkbox"/> The antenna is affixed to the EUT using a unique connector which allows for replacement of a broken antenna, but DOES NOT use a standard antenna jack or electrical connector. <input type="checkbox"/> The EUT requires professional installation (attach supporting documentation if using this option).
Manufacturer name & address	Symbol Technologies 2145 Hamilton Avenue San Jose, CA 95125

2.2 Related Submittal(s) Grants

None.

2.3 Test Methodology

Both AC mains line-conducted and radiated emissions measurements were performed according to the procedures in ANSI C63.4 (1992). Radiated tests were performed at an antenna to EUT distance of 3 meters, unless stated otherwise in the "**Data Sheet**" of this Application. All other measurements were made in accordance with the procedures in part 2 of CFR 47.

2.4 Test Facility

The open area test site and conducted measurement facility used to collect the radiated data is located at 1365 Adams Court, Menlo Park, CA 94025. This test facility and site measurement data have been fully placed on file with the FCC.

3.0 **System Test Configuration**

3.1 Support Equipment

Item #	Description	Model No.	Serial No.	FCC ID
1	Dell Computer	POS3410-N500	F999999	DoC

3.2 Block Diagram of Test Setup

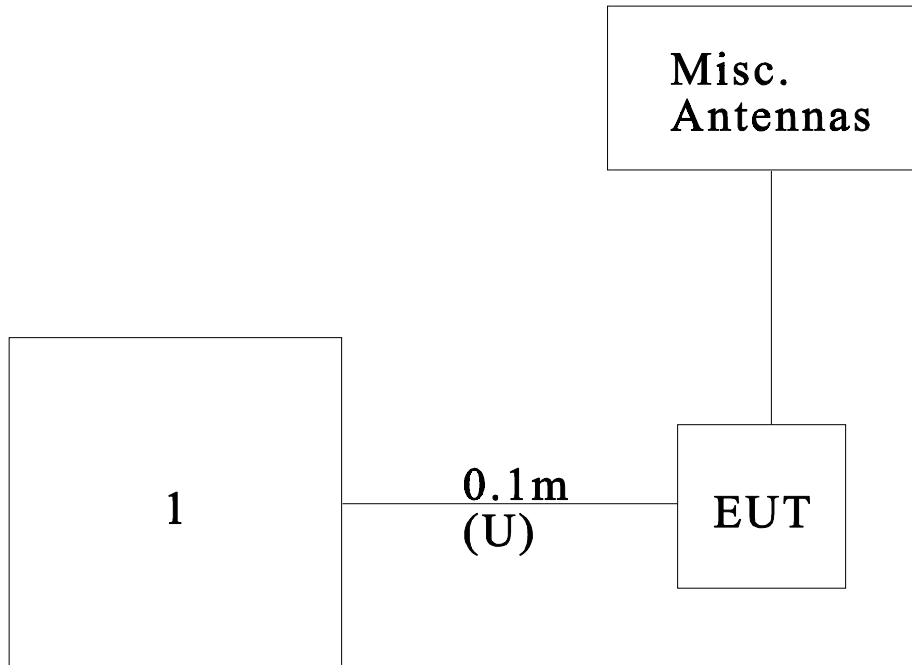

m: Length in meters

U: Unshielded

3.3 Justification

For emission testing, the equipment under test (EUT) was configured for testing in a typical fashion (as a customer would normally use it). During testing, all cables were manipulated to produce worst case emissions.

For radiated emission measurements, the EUT is attached to a cardboard box (if necessary) and placed on the wooden turntable. If the EUT attaches to peripherals, they are connected and operational (as typical as possible). The EUT is wired to transmit full power.

The signal is maximized through rotation and placement in the three orthogonal axes. The antenna height and polarization are varied during the search for maximum signal level. The antenna height is varied from 1 to 4 meters. Radiated emissions are taken at three meters unless the signal level is too low for measurement at that distance. If necessary, a pre-amplifier is used and/or the test is conducted at a closer distance.

All readings are extrapolated back to the equivalent three meter reading using inverse scaling with distance.

3.4 Software Exercise Program

The EUT exercise program used during radiated and conducted testing was designed to exercise the various system components in a manner similar to a typical use.

3.5 Mode of Operation During Test

For emissions testing, the units were setup to transmit continuously to simplify the measurement methodology. Care was taken to ensure proper power supply voltages during testing.

3.6 Modifications Required for Compliance

The following modifications were installed during compliance testing in order to bring the product into compliance (Please note that this list does not include changes made specifically by Symbol Technologies Inc. prior to compliance testing):

No modifications were made to the EUT by Intertek Testing Services.

4.0 Measurement Results

4.1 Maximum Conducted Output Power at Antenna Terminals , FCC Ref: 15.247(b):

With the hopping function turned OFF:

The antenna port of the EUT was connected to the input of a power meter. Power was read directly and cable loss correction was added to the reading to obtain power at the EUT antenna terminals.

The antenna port of the EUT was connected to the input of a spectrum analyzer. The analyzer was set for maximum RES BW and power was read directly in dBm.

For antennas with gains of 6 dBi or less , maximum allowed transmitter output is 1 watt (+30 dBm).

For antennas with gains greater than 6 dBi, transmitter output level must be decreased by an amount equal to (GAIN - 6)/3 dBm.

NOTE: Hopping function disabled during test

Frequency (MHz)	Output in dBm	Output in mWatt
2402	25.2	331
2440	24.9	309
2480	24.5	281

Cable loss: 0.2 dB

External Attenuation: 3.0 dB

Cable loss, external attenuation:

included in OFFSET function

added to SA raw reading

EUT Transmit Antenna Gain (0 dBi) +20.3 dBm max. output level =20.3 dBm.

Please refer to the attached plots for details:

Plot 1.a: Low Channel Output Power

Plot 1.b: Middle Channel Output Power

Plot 1.c: High Channel Output Power

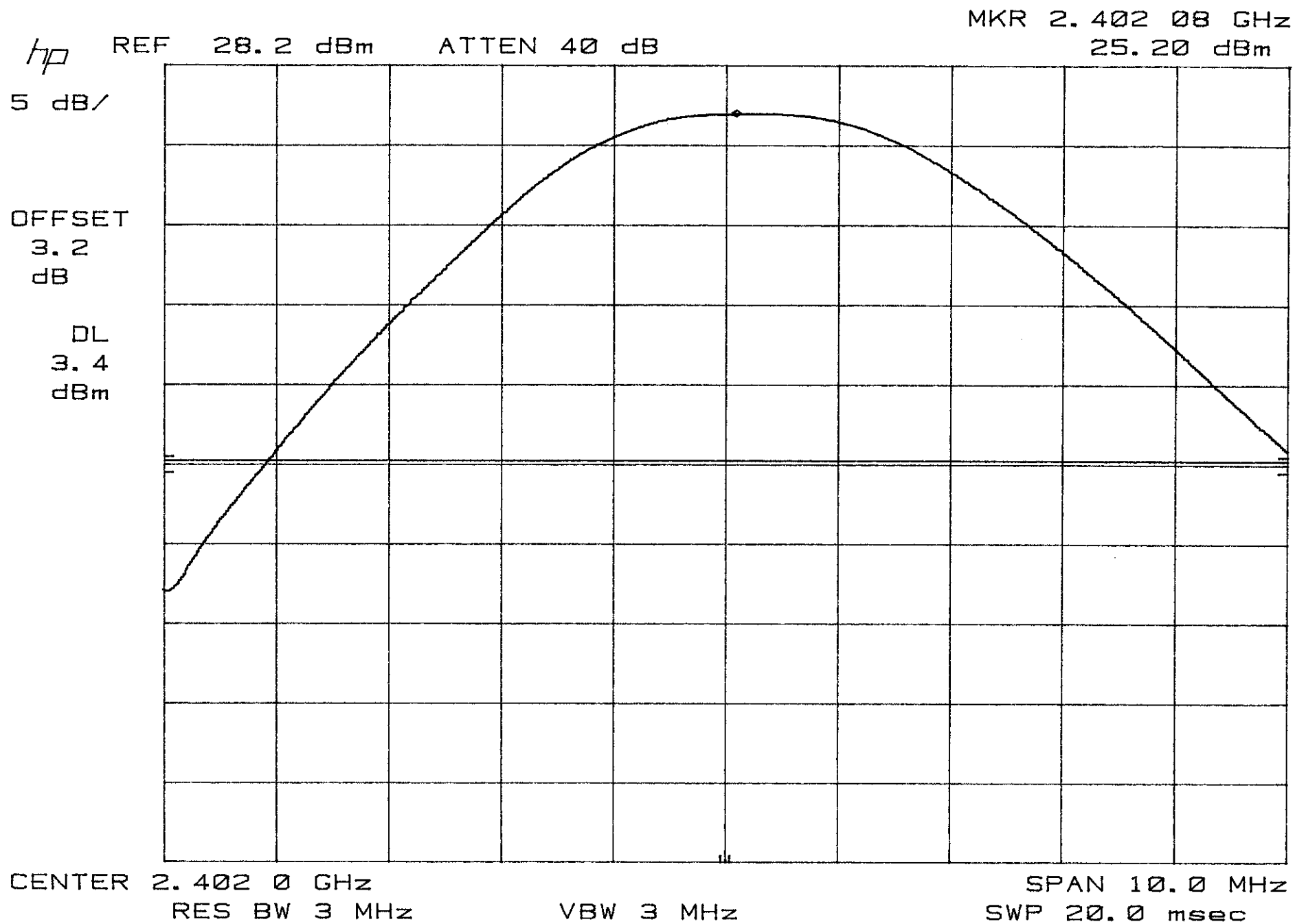

Plot 1a

MKR 2.440 08 GHz
24.90 dBm

hp REF 28.2 dBm ATTN 40 dB

5 dB/

OFFSET
3.2
dB

DL
3.4
dBm

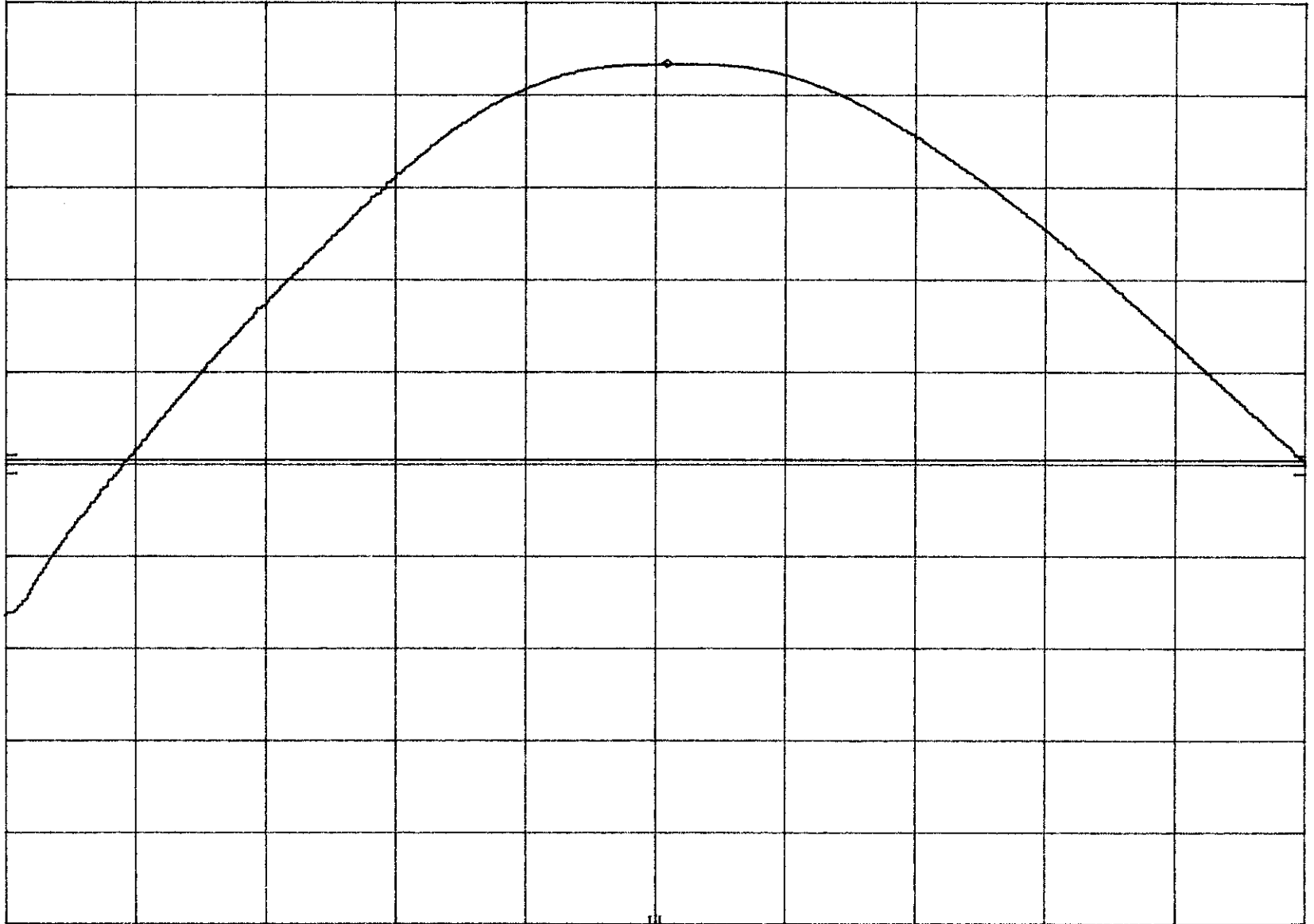

CENTER 2.440 08 GHz

SPAN 10.0 MHz

Plot 1b

RES BW 3 MHz

VBW 3 MHz

SWP 20.0 msec

MKR 2.480 08 GHz
24.45 dBm

hp REF 28.2 dBm ATTN 40 dB

5 dB/

OFFSET
3.2
dB

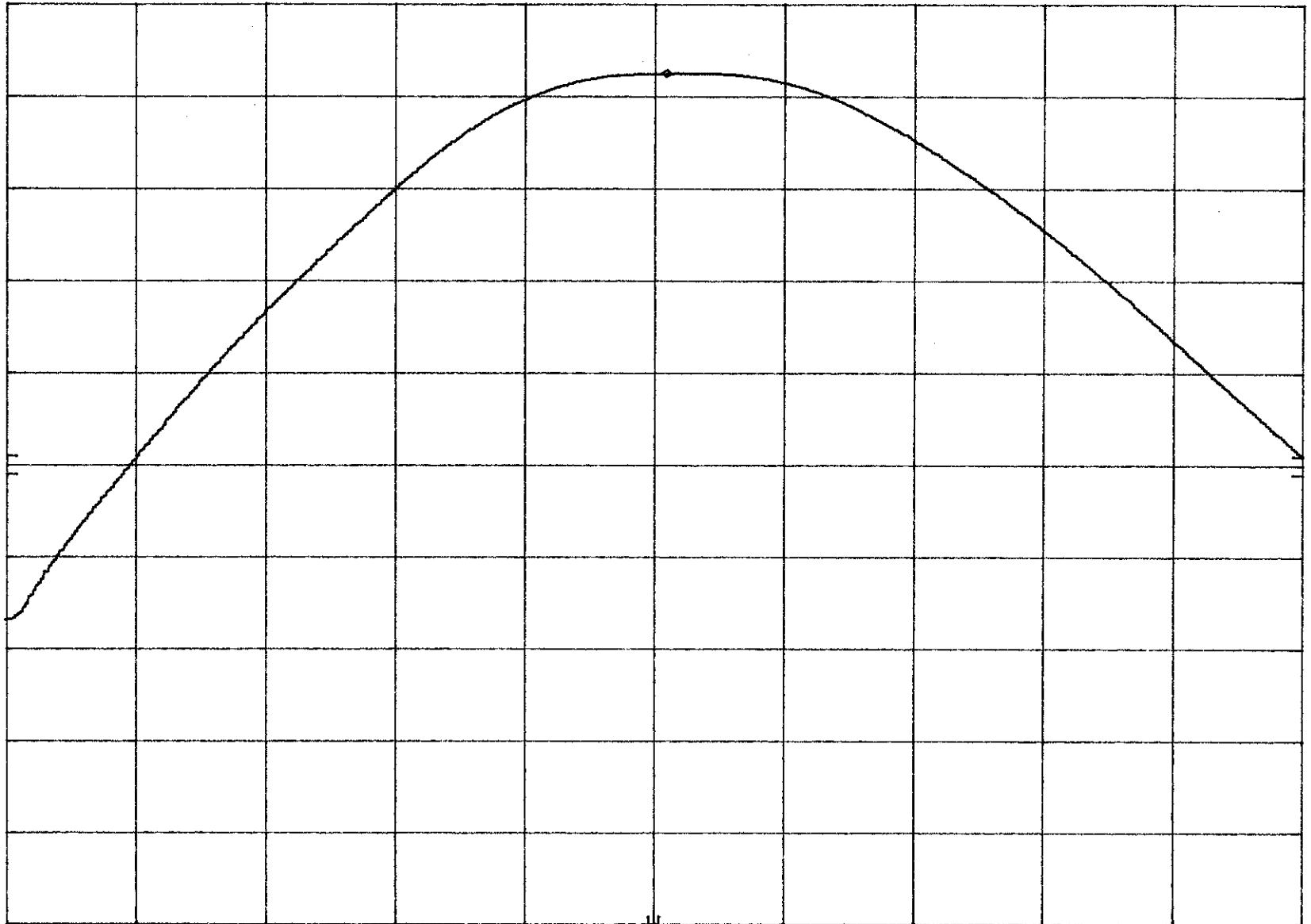

CENTER 2.480 08 GHz

RES BW 3 MHz

VBW 3 MHz

SPAN 10.0 MHz

SWP 20.0 msec

Plot 1c

4.2 Hopping Channel 20 dB RF Bandwidth, FCC Ref: 15.247(a)(1)

Test results:

Channel (Frequency, MHz)	20 dB Bandwidth (kHz)
Low, 2402	998
Middle, 2440	994
High, 2480	996

Please refer to the attached plots for details:

Plot 2.a: Low Channel

Plot 2.b: Middle Channel

Plot 2.c: High Channel

MKR Δ 998 kHz
0.00 dB

hp REF 24.0 dBm ATTEN 30 dB

10 dB/

OFFSET
4.0
dB

DL
2.7
dBm

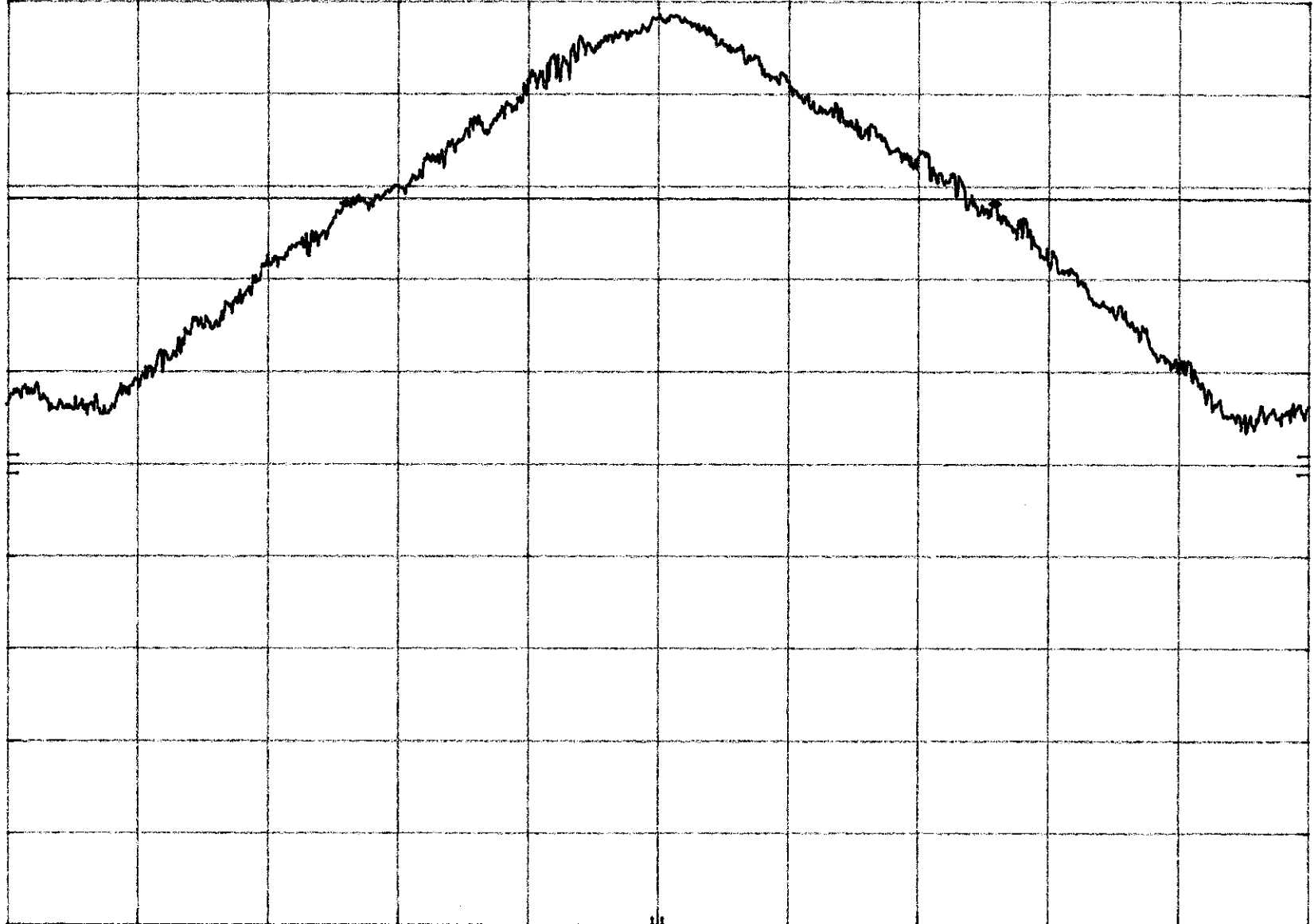

CENTER 2.402 00 GHz
RES BW 30 kHz

VBW 30 kHz

SPAN 2.00 MHz
SWP 20.0 msec

MKR Δ 994 kHz
0.30 dB

hp REF 24.0 dBm ATTEN 30 dB

10 dB/

OFFSET
4.0
dB

DL
2.4
dBm

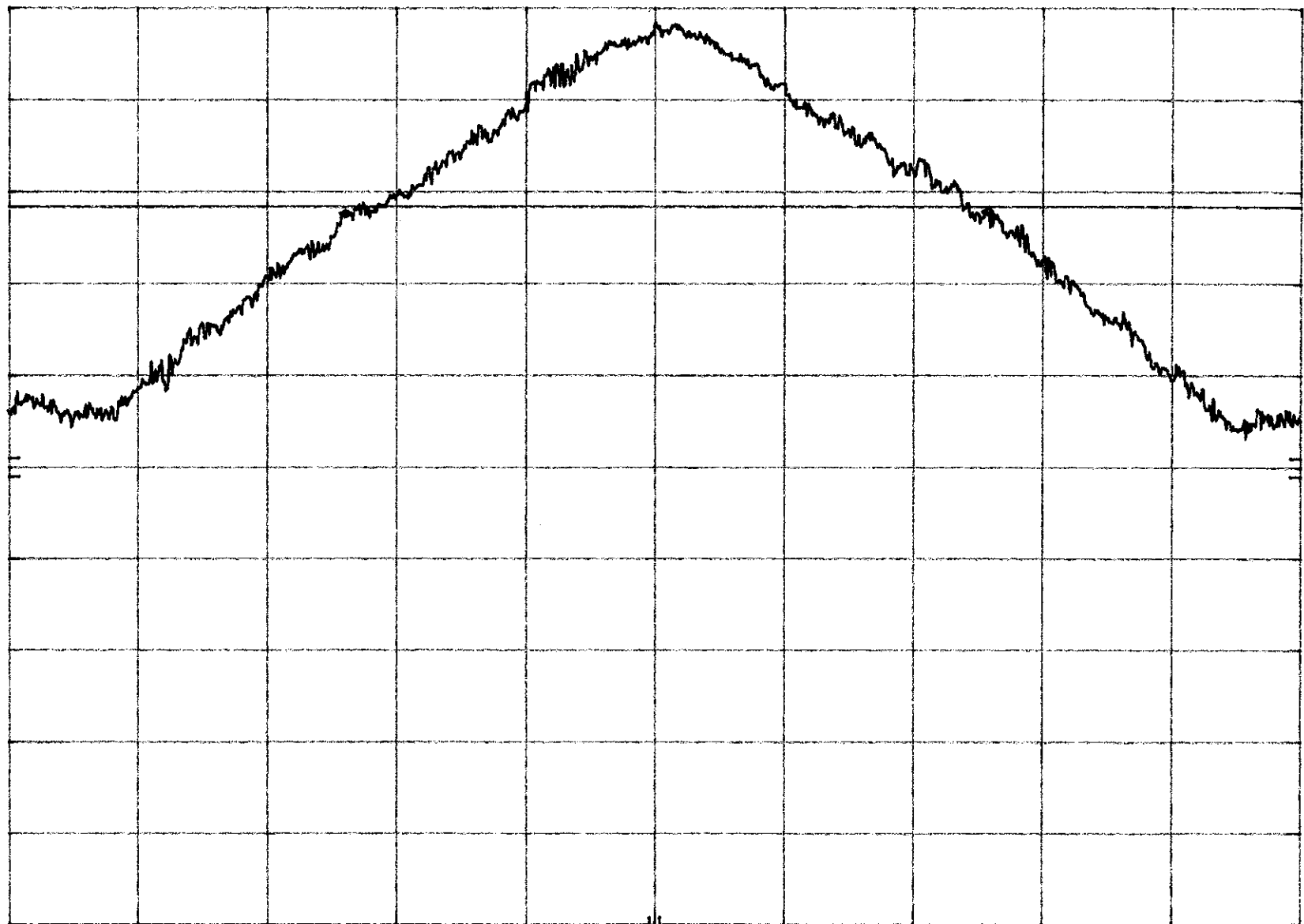

CENTER 2.440 00 GHz

RES BW 30 kHz

VBW 30 kHz

SPAN 2.00 MHz

SWP 20.0 msec

Plot 2b

MKR Δ 996 kHz
0.00 dB

hp REF 24.0 dBm ATTEN 30 dB

10 dB/

OFFSET
4.0
dB

DL
1.9
dBm

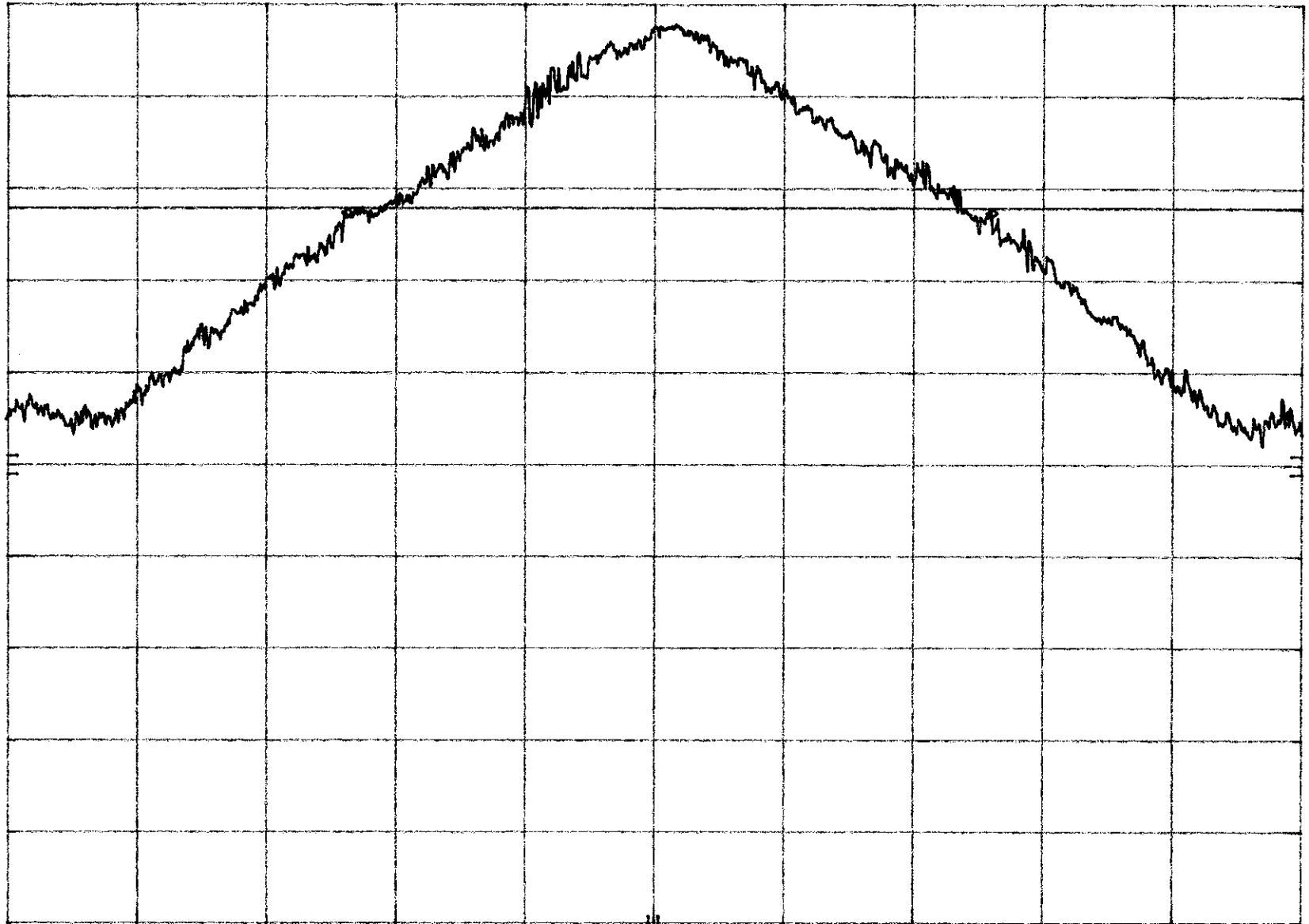

CENTER 2.480 00 GHz

RES BW 30 kHz

VBW 30 kHz

SPAN 2.00 MHz

SWP 20.0 msec

Plot 2c

4.3 Minimum Number of Hopping Frequencies, FCC Ref: 15.247(a)(1)(I&ii)

The RF passband of the EUT was divided into 2 approximately equal bands. With the analyzer set to MAX HOLD readings were taken for 2 - 3 minutes in each band. The channel peaks so recorded were added together, and the total number compared to the minimum number of channels required in the regulation.

Number of hopping channels	79
----------------------------	----

Minimum Requirements:

at least 50 channels for 902 - 928 MHz band;

at least 75 channels for 2400 - 2483.5 and 5725 - 5850 MHz systems

Please refer to the attached plots for details:

Plots 3.a - 3.e

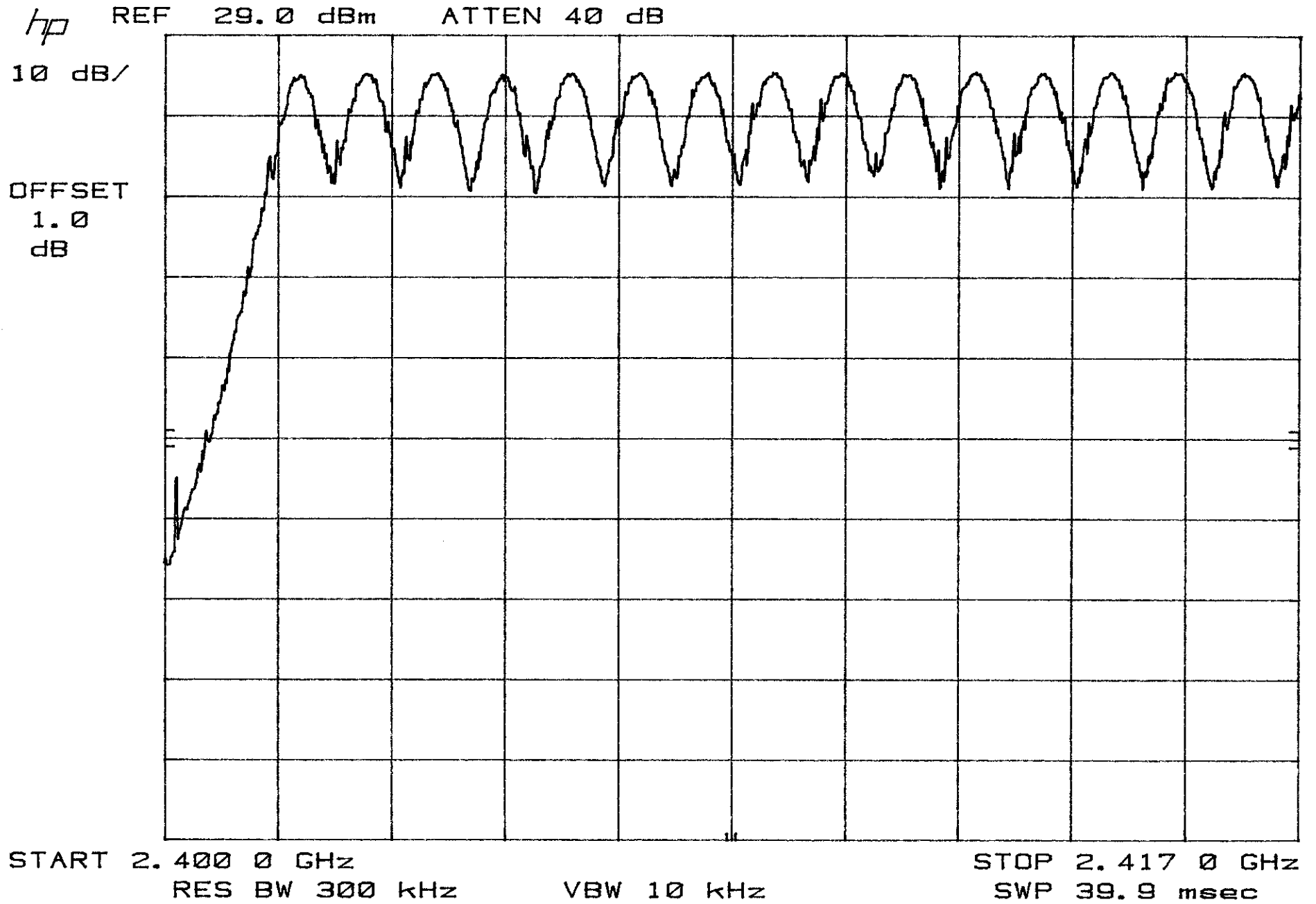

Plot 3a

MKR Δ 10.06 MHz
0.40 dB

hp REF 29.0 dBm ATTEN 40 dB

10 dB/

OFFSET
1.0
dB

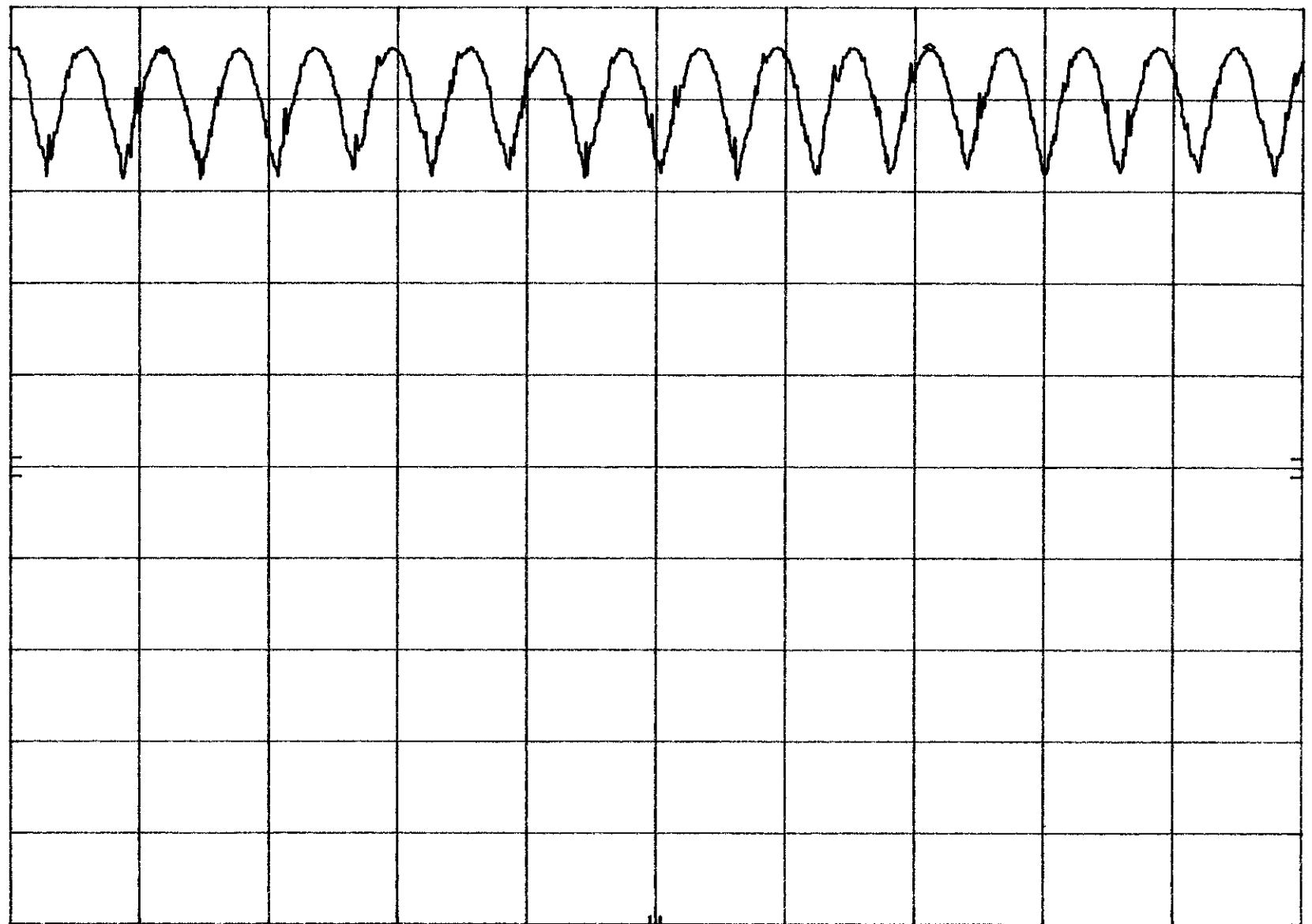

START 2.4170 GHz

RES BW 300 kHz

VBW 10 kHz

STOP 2.4340 GHz

SWP 39.9 msec

Plot 3b

hp REF 29.0 dBm ATTEN 40 dB

10 dB/

OFFSET
1.0
dB

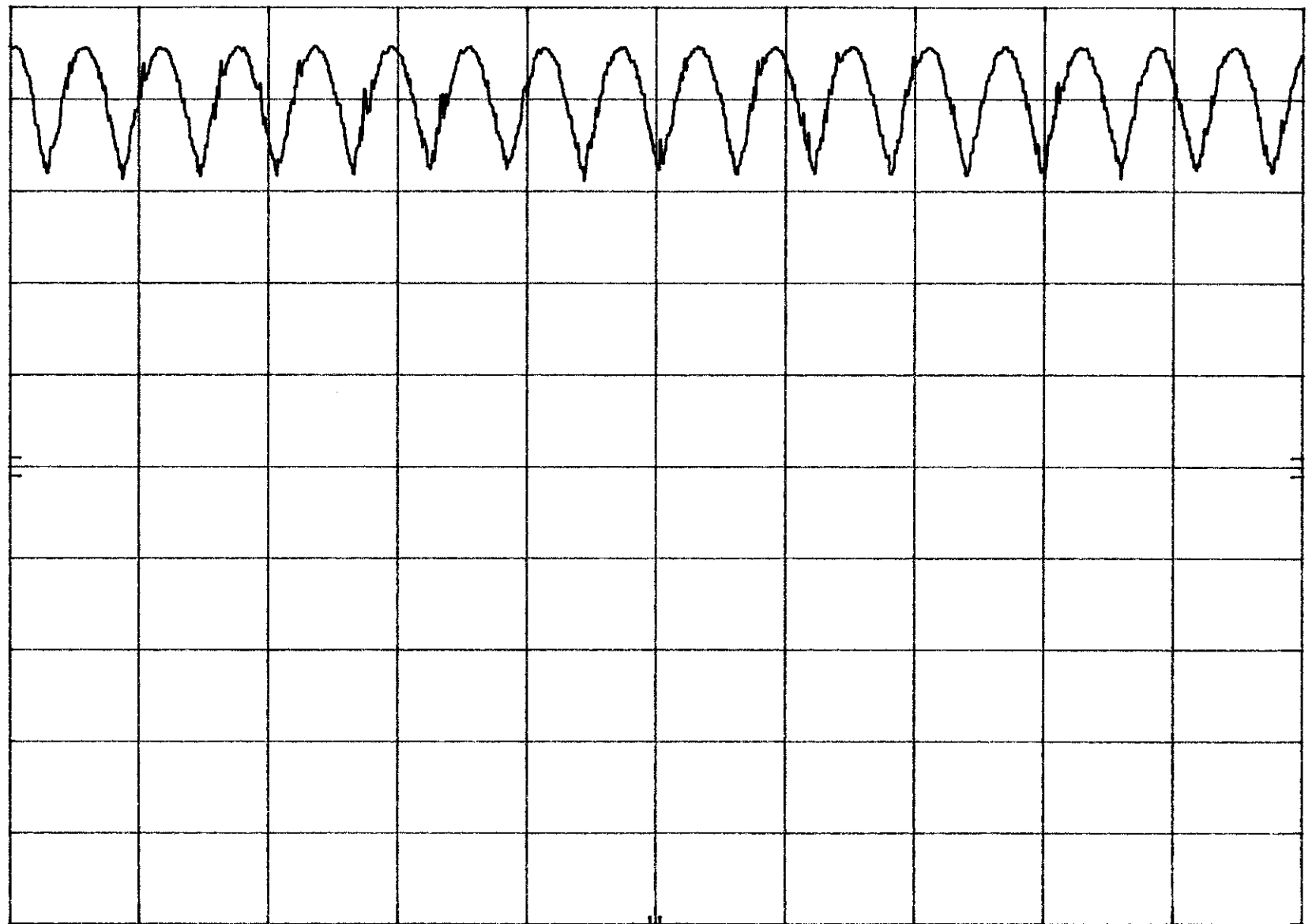

START 2.434 0 GHz

RES BW 300 kHz

VBW 10 kHz

STOP 2.451 0 GHz

SWP 39.9 msec

Plot 3c

hp REF 29.0 dBm ATTEN 40 dB

10 dB/

OFFSET
1.0
dB

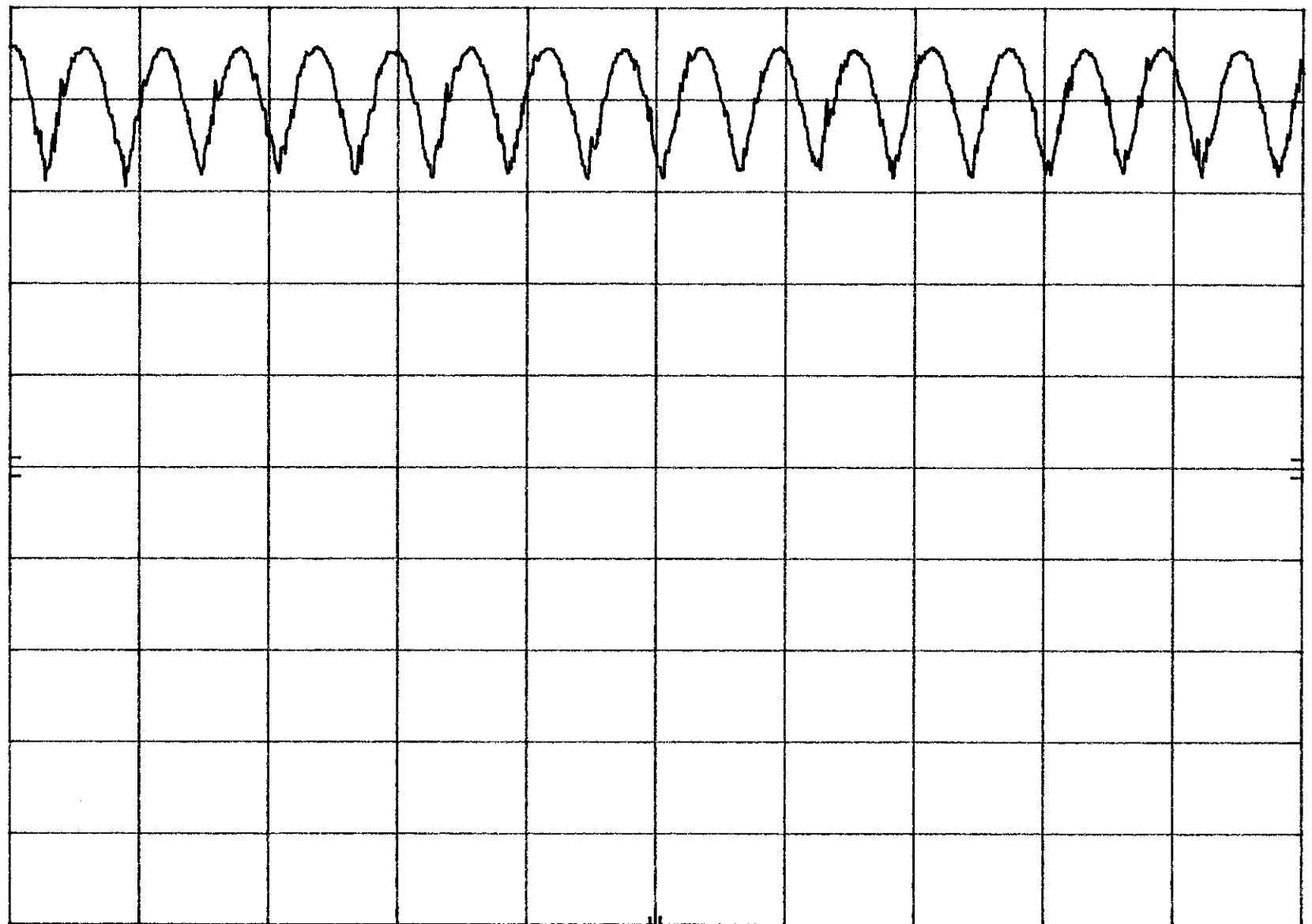

START 2.451 0 GHz

STOP 2.468 0 GHz

PLOT 3d

RES BW 300 kHz

VBW 10 kHz

SWP 39.9 msec

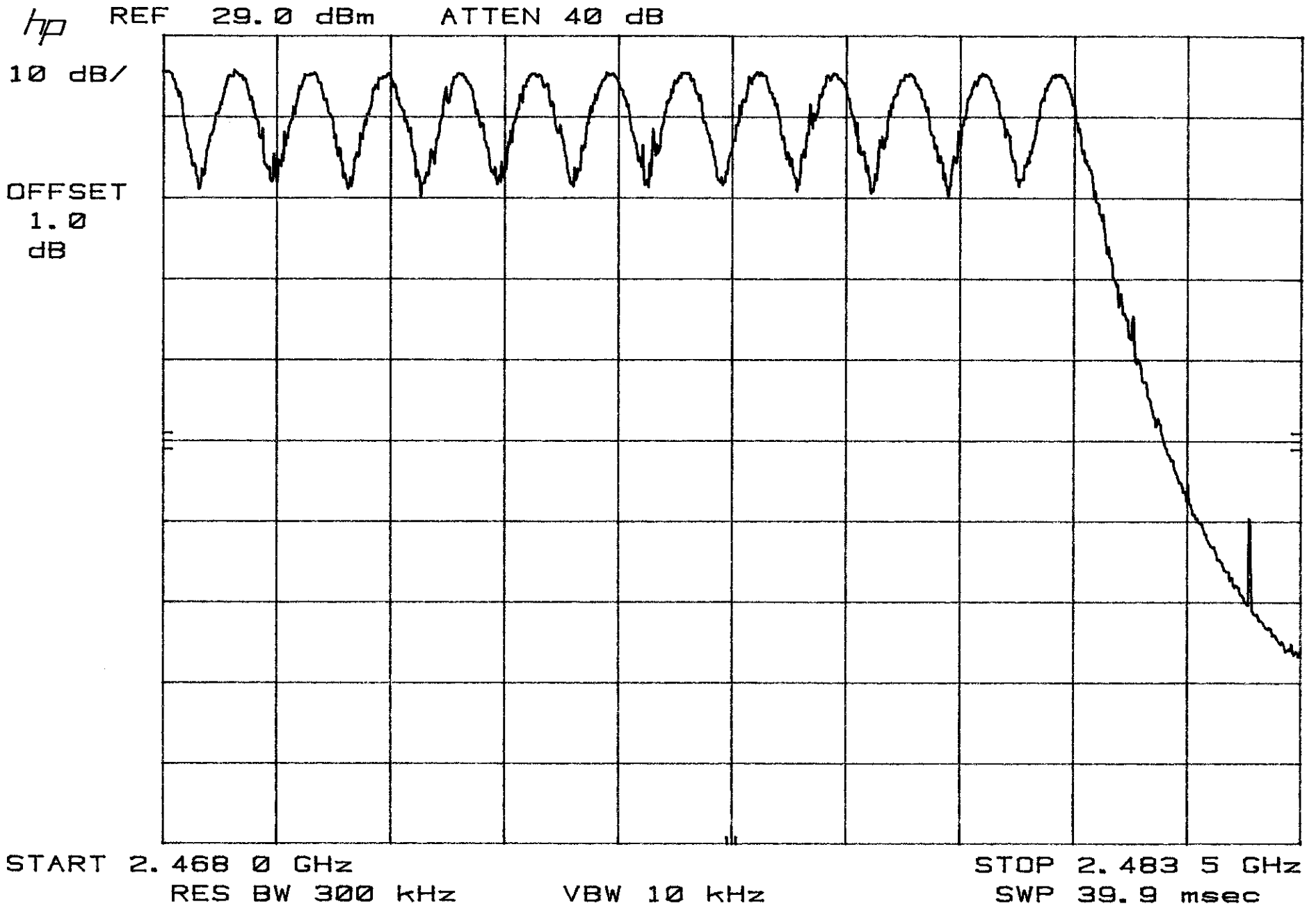

Plot 3e

4.4 Average Channel Occupancy Time, FCC Ref: 15.247(a)(1)(I&ii)

Requirement:

Average 0.4 seconds maximum occupancy in 20 seconds, 902-928 MHz

Average 0.4 seconds maximum occupancy in 30 seconds, 2400-2483.5/5725-5850 MHz

The spectrum analyzer center frequency was set to one of the known hopping channels. The SWEEP was set to 0.4 second, the SPAN was set to ZERO SPAN, and the TRIGGER was set to VIDEO. The time duration of the transmission so captured was measured with the MARKER DELTA function.

The SWEEP was then set to the time required by the regulation (20 seconds for 902-928 MHz devices, 30 seconds for all other bands). The analyzer was set to SINGLE SWEEP, the total ON time was added and compared against the limit (0.4 seconds).

The average time occupancy is:

$$39 \times 9.9 \text{ (ms)} = 386.1 \text{ ms}$$

Please refer to the attached plots for details:

Plots 4.a - 4.b

MKR Δ 9.900 msec
-35.40 dB

hp REF 28.2 dBm ATTEN 40 dB

10 dB/

OFFSET
3.2
dB

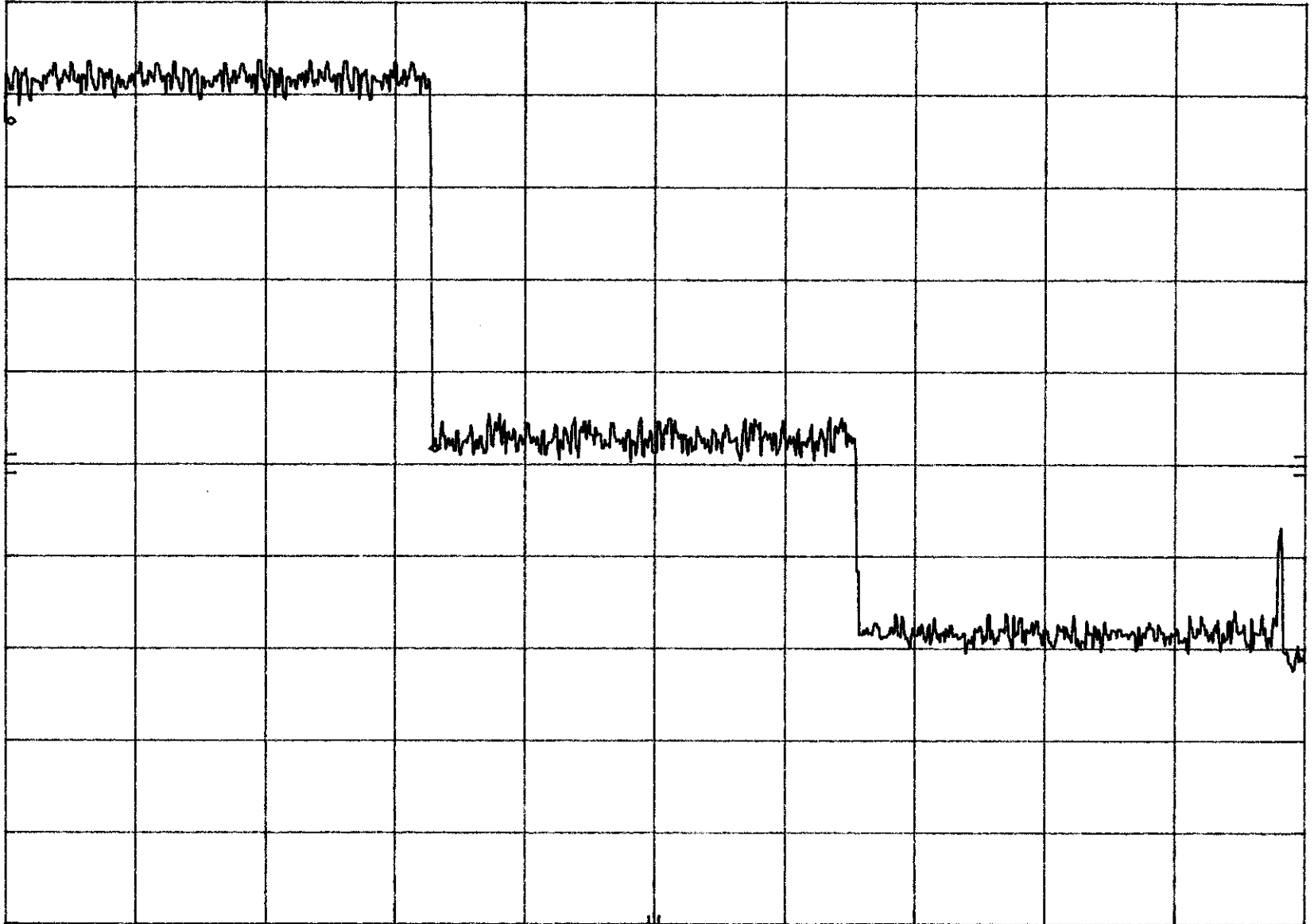

CENTER 2.440 000 000 GHz

RES BW 30 kHz

VBW 30 kHz

SPAN 0 Hz

SWP 30.0 msec

hp REF 28.2 dBm ATTEN 40 dB

10 dB/

OFFSET
3.2
dB

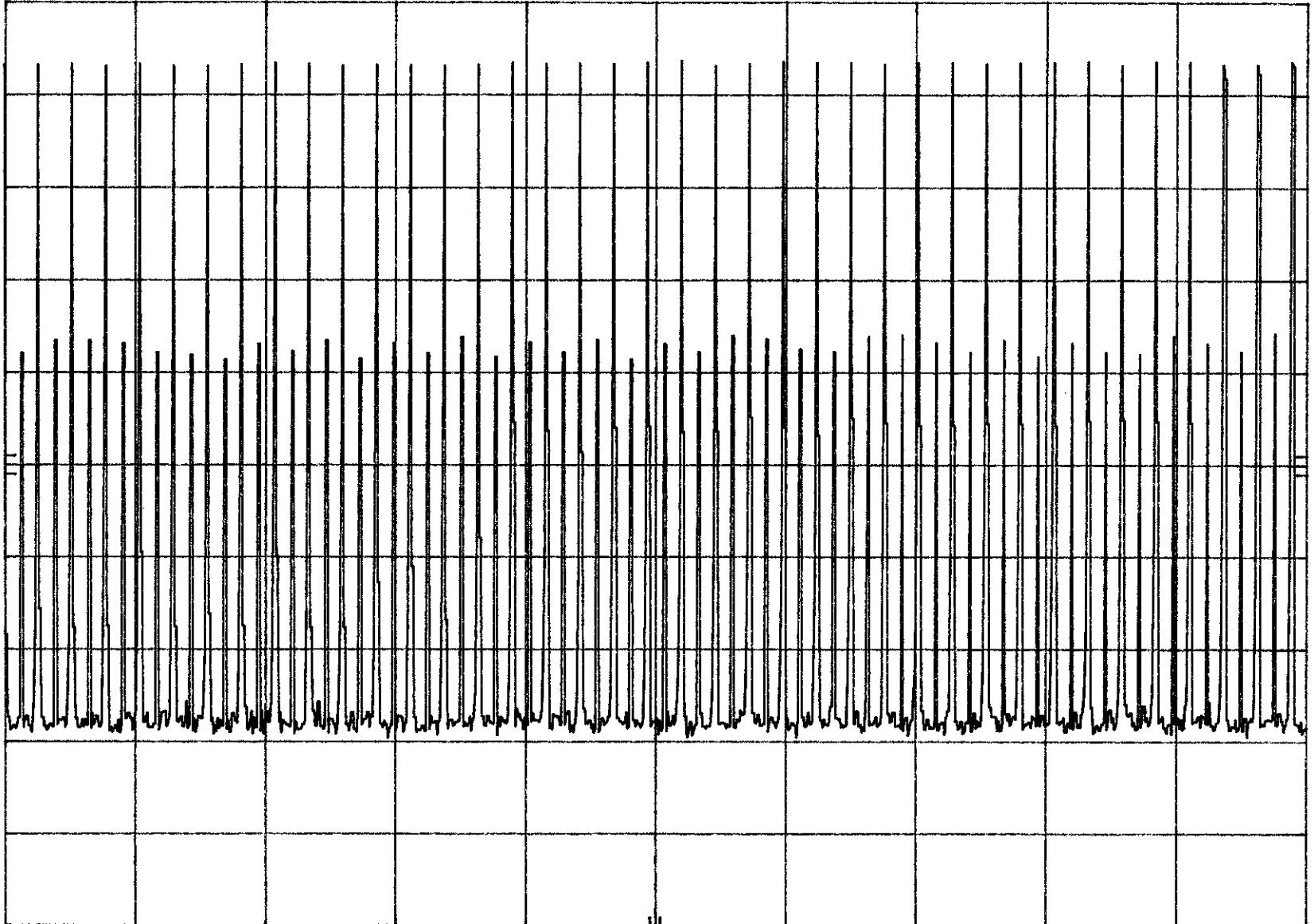

CENTER 2.440 000 000 GHz

SPAN 0 Hz

RES BW 30 kHz

VBW 30 kHz

SWP 30.0 sec

Plot: 4b.g

4.5 Out of Band Conducted Emissions, FCC Ref: 15.247 (c)

Requirements:

In any 100 kHz bandwidth outside the EUT passband, the RF power produced by the modulation products of the spreading sequence, the information sequence, and the carrier frequency shall be at least 20 dB below that of the maximum in-band 100 kHz emission.

Result:

Please refer to the attached Plots for details:

Low Channel	Plots 5.a.1 - 5.a.6
Middle Channel	Plots 5.b.1 - 5.b.5
High Channel	Plots 5.c.1 - 5.c.7

hp REF 28.2 dBm ATTEN 40 dB

10 dB/

OFFSET
3.2
dB

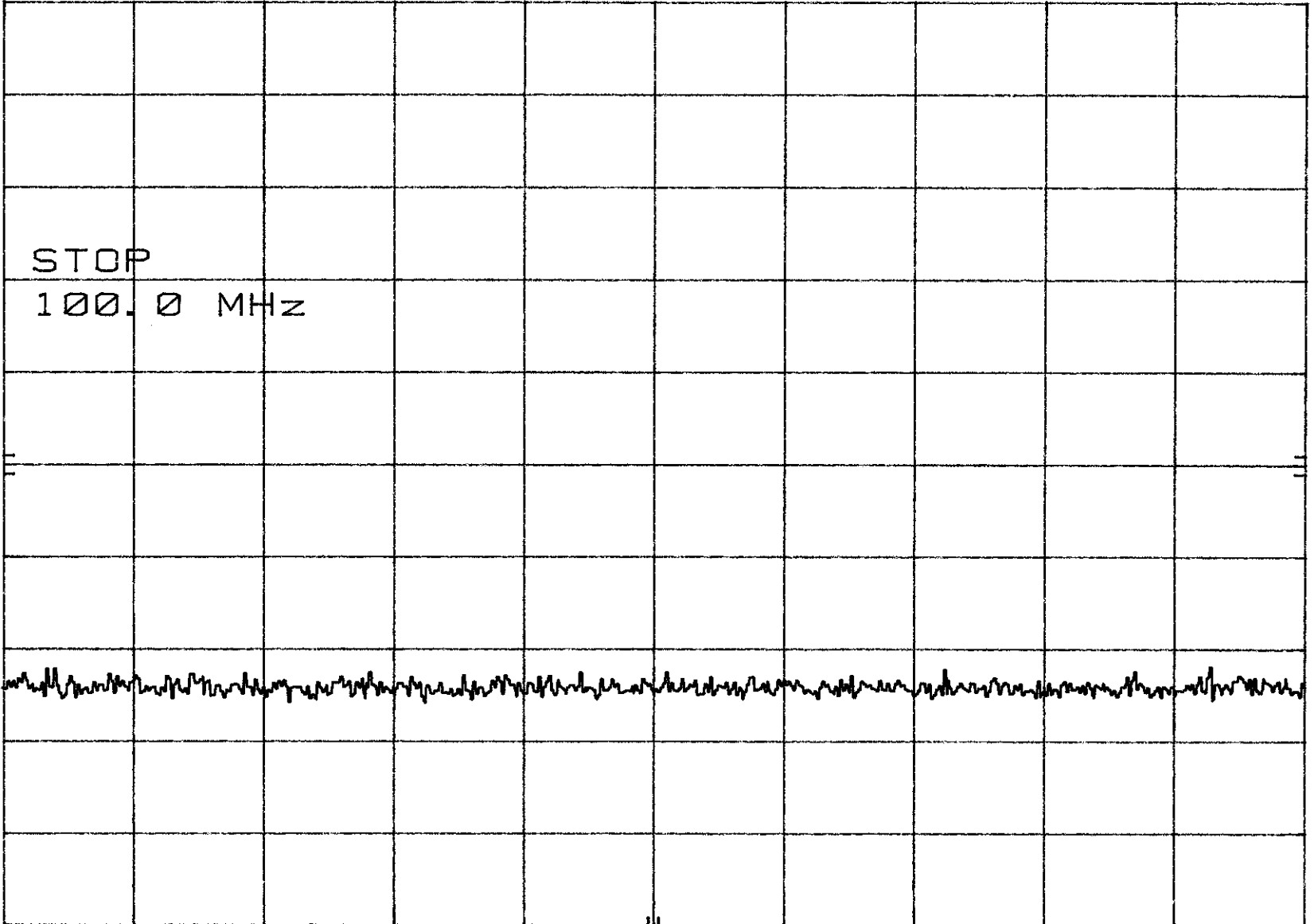

STOP
100.0 MHz

START 1.0 MHz

STOP 100.0 MHz

Plot 5a,1

RES BW 100 kHz

VBW 100 kHz

SWP 30.0 msec

MKR 2.024 GHz
-41.60 dBm

hp REF 28.2 dBm ATTEN 40 dB

10 dB/

OFFSET
3.2
dB

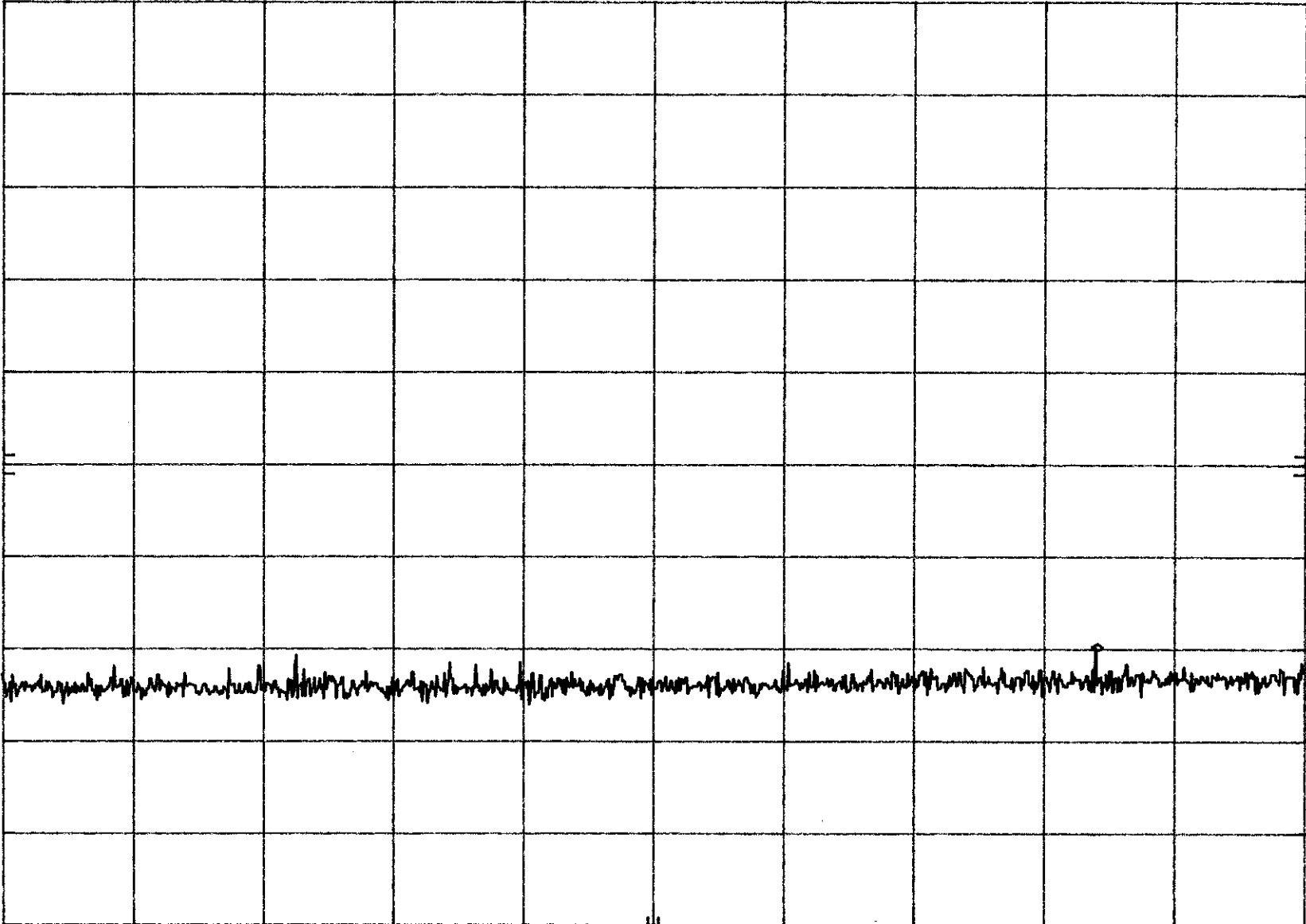

Plot 5a,2

START 100 MHz

RES BW 100 kHz

VBW 100 kHz

STOP 2.39 GHz

SWP 687 msec

MKR 2.399 90 GHz
-30.30 dBm

hp REF 28.2 dBm ATTEN 40 dB

10 dB/

OFFSET
3.2
dB

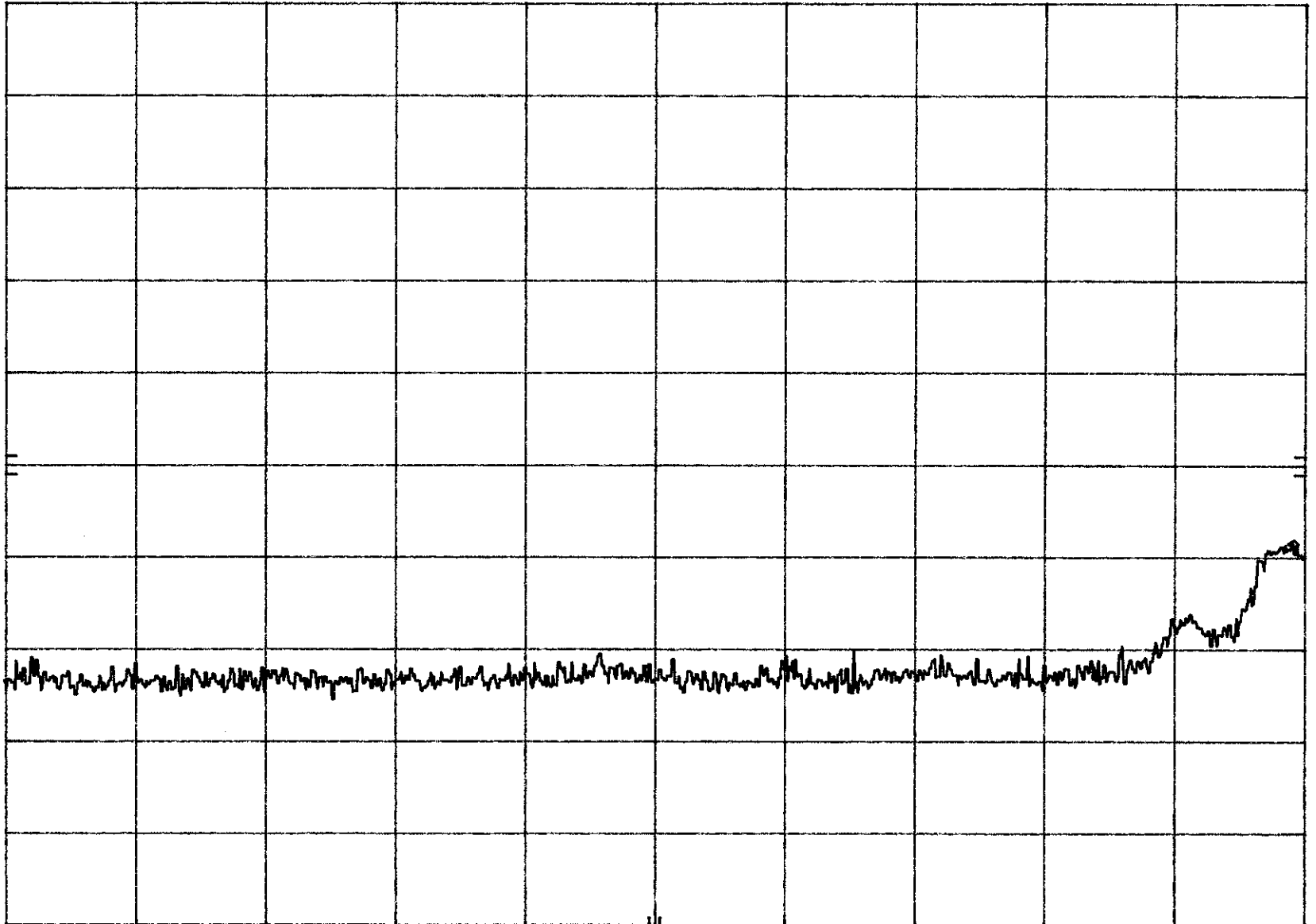

START 2.390 0 GHz

RES BW 100 kHz

VBW 100 kHz

STOP 2.400 0 GHz

SWP 20.0 msec

Plot 5a,3

MKR Δ -2.09 MHz
-57.60 dB

hp REF 23.2 dBm ATTEN 30 dB

10 dB/

OFFSET
3.2
dB

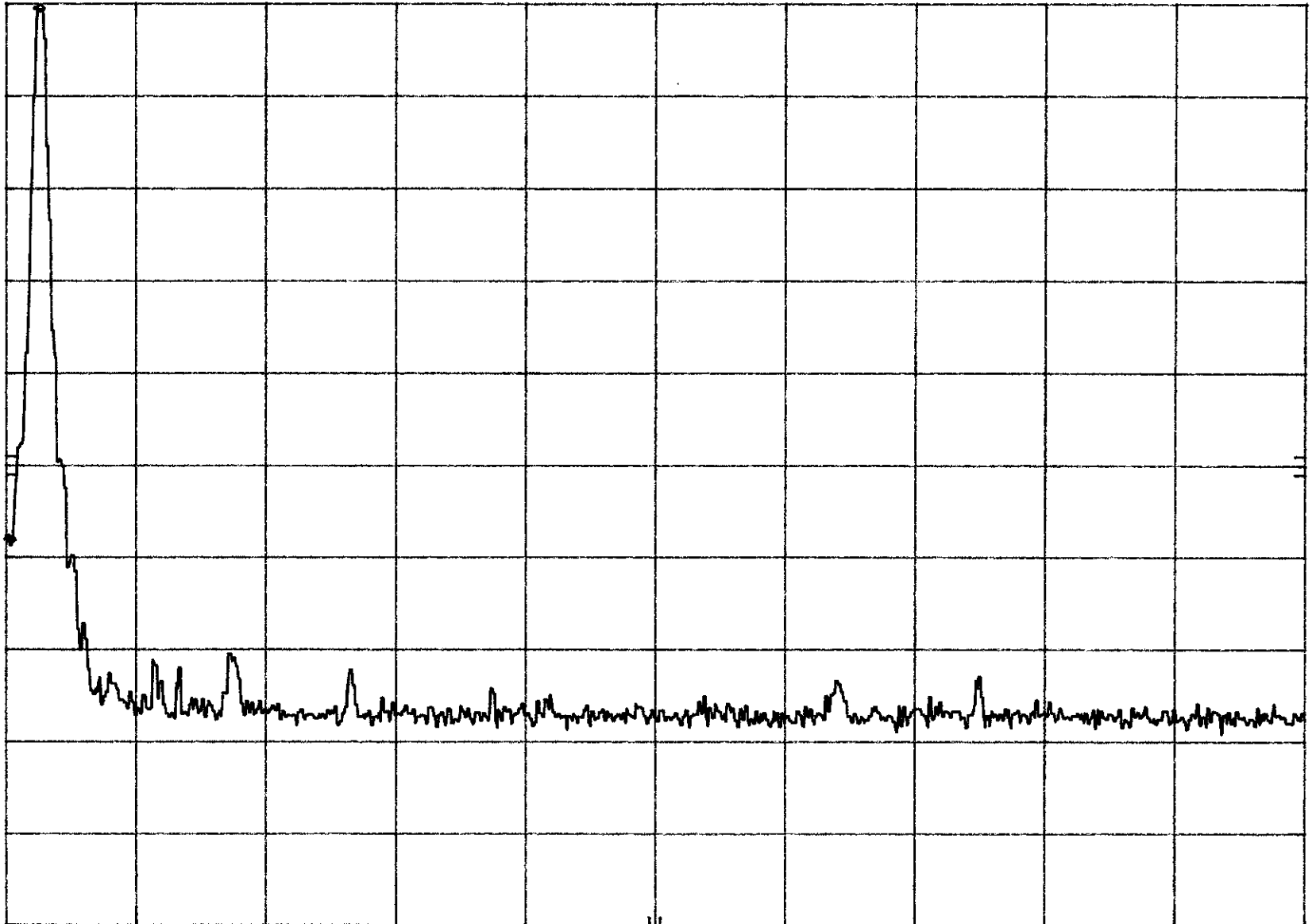

START 2.400 0 GHz

STOP 2.483 5 GHz

Plot 5a, 4

RES BW 100 kHz

VBW 100 kHz

SWP 25.1 msec

MKR 2.574 GHz
-46.20 dBm

hp REF 23.2 dBm ATTN 30 dB

10 dB/

OFFSET
3.2
dB

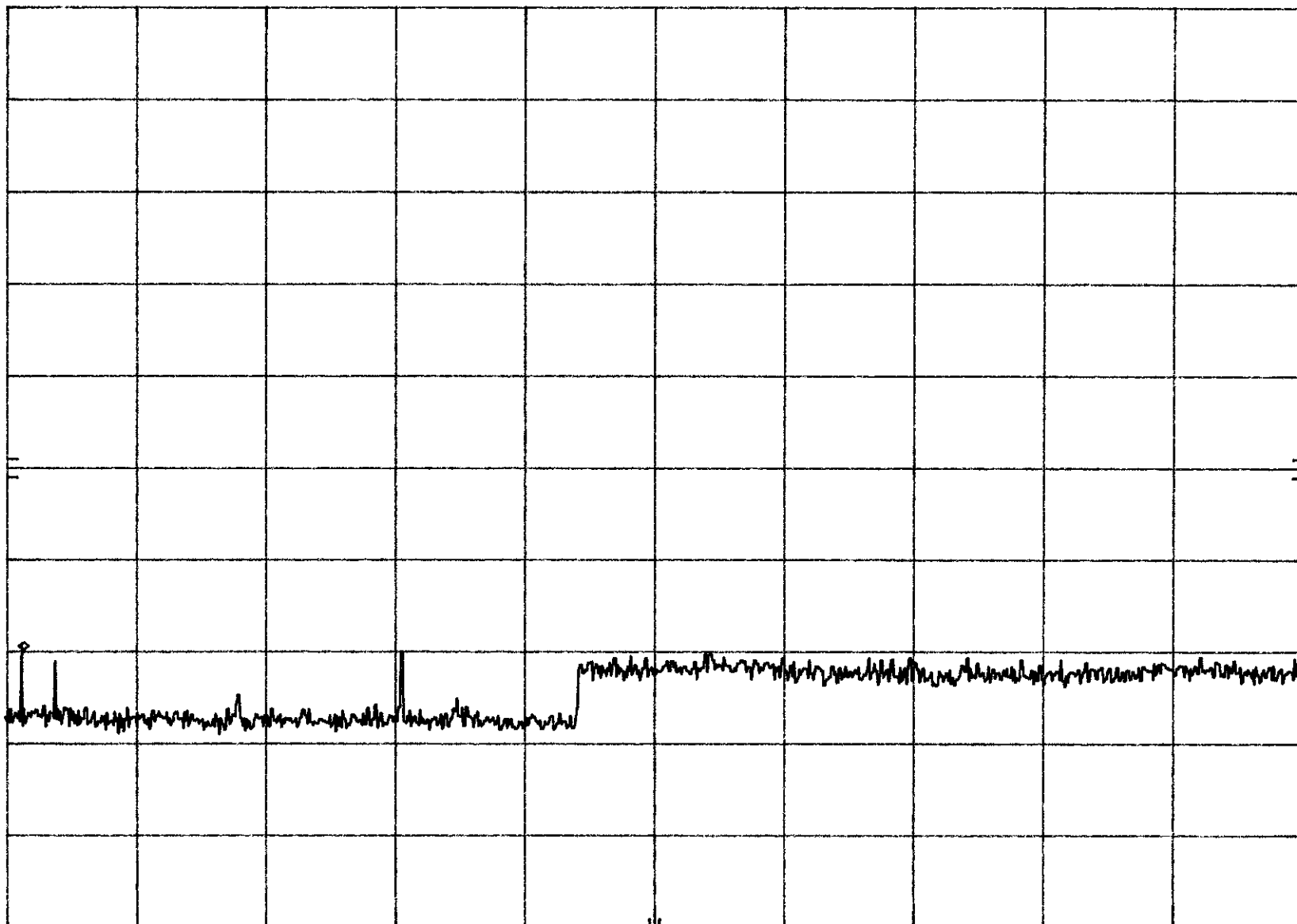

START 2.48 GHz

STOP 10.00 GHz

Plot 5a, 5

RES BW 100 kHz

VBW 100 kHz

SWP 2.25 sec

MKR 23.50 GHz
-33.70 dBm

hp REF 23.2 dBm ATTEN 30 dB

10 dB/

OFFSET
3.2
dB

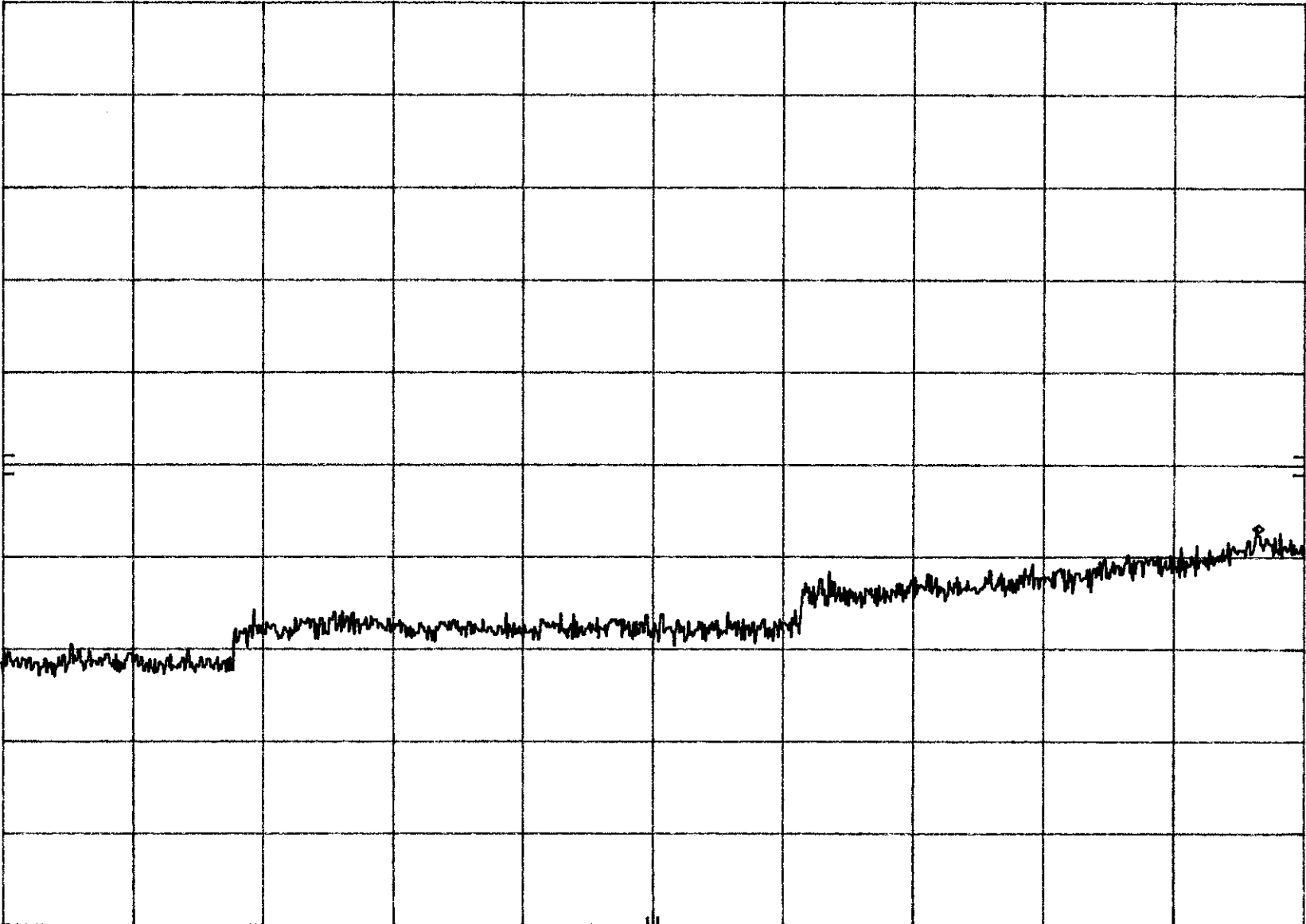

START 10.0 GHz

STOP 24.0 GHz

RES BW 100 kHz

VBW 100 kHz

SWP 4.20 sec

PLOT 5a,6

MKR 78.02 MHz
-49.30 dBm

hp REF 23.2 dBm ATTEN 30 dB

10 dB/

OFFSET
3.2
dB

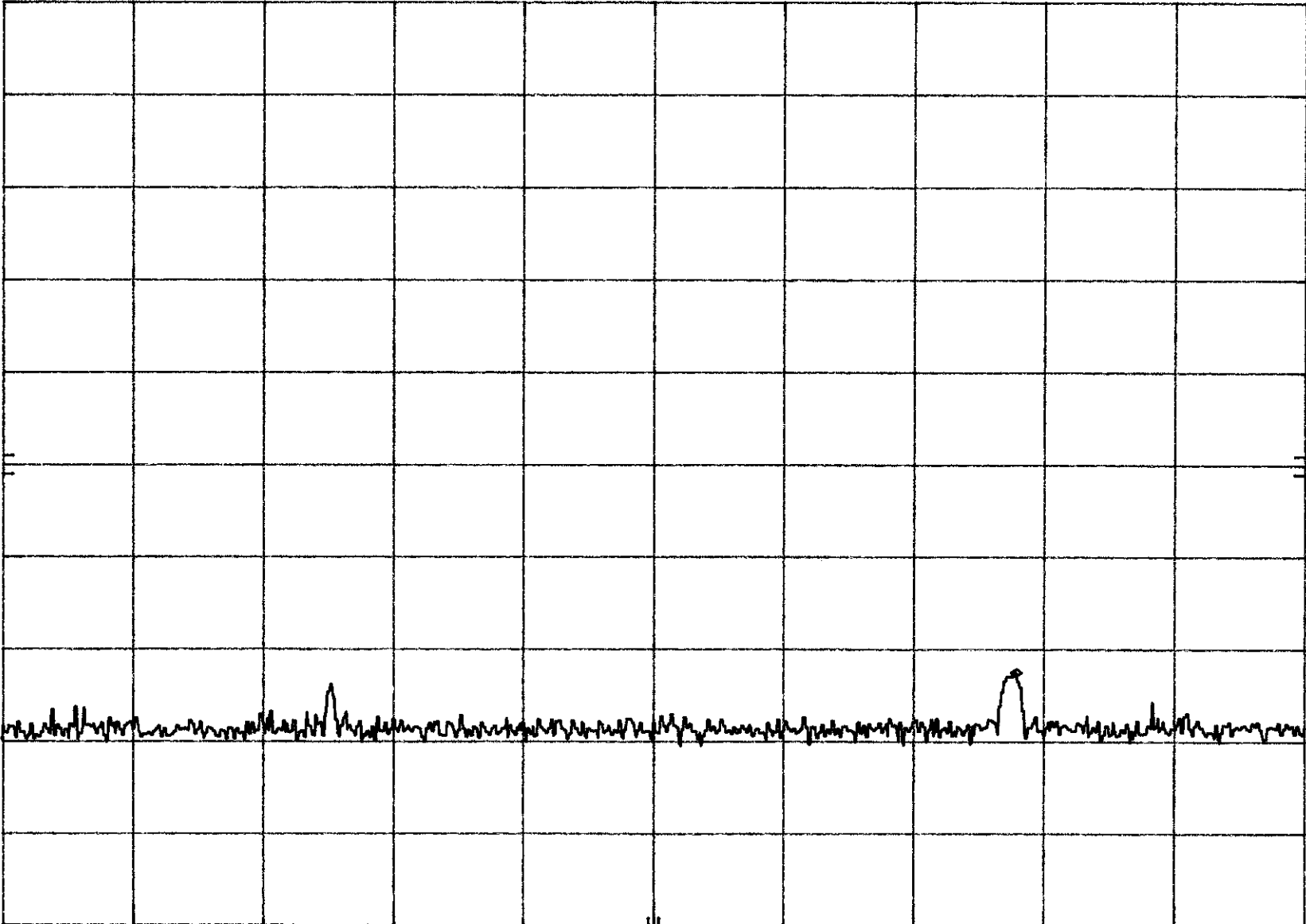

START 1.0 MHz RES BW 100 kHz VBW 100 kHz STOP 100.0 MHz
SWP 29.7 msec

Plot05b,1

MKR 1.889 GHz
-44.60 dBm

hp REF 23.2 dBm ATTEN 40 dB

10 dB/

OFFSET
3.2
dB

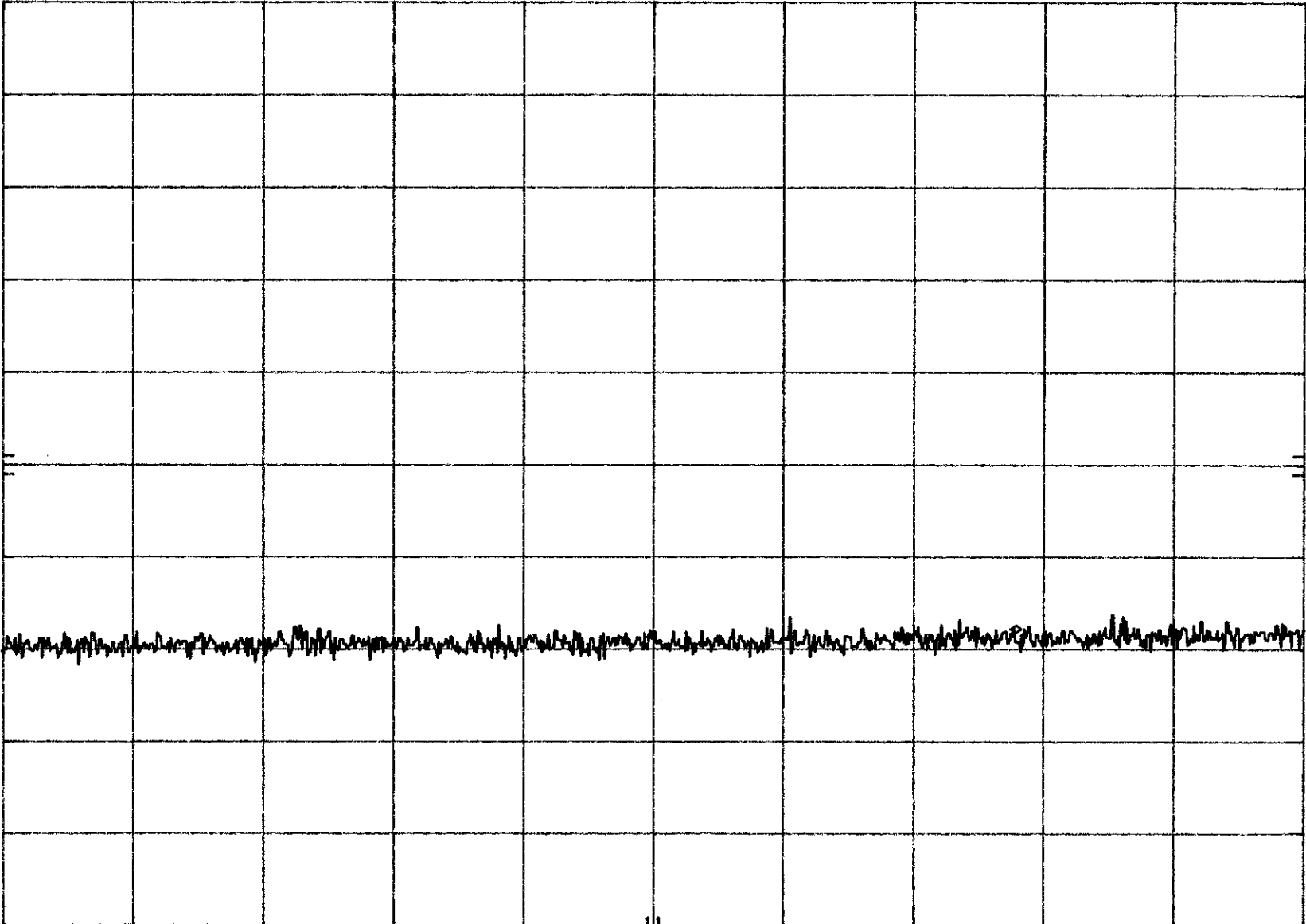

START 100 MHz RES BW 100 kHz VBW 100 kHz STOP 2.40 GHz
SWP 690 msec

Plot 5b, 2

MKR 2.464 96 GHz
-45.10 dBm

hp REF 23.2 dBm ATTEN 40 dB

10 dB/

OFFSET
3.2
dB

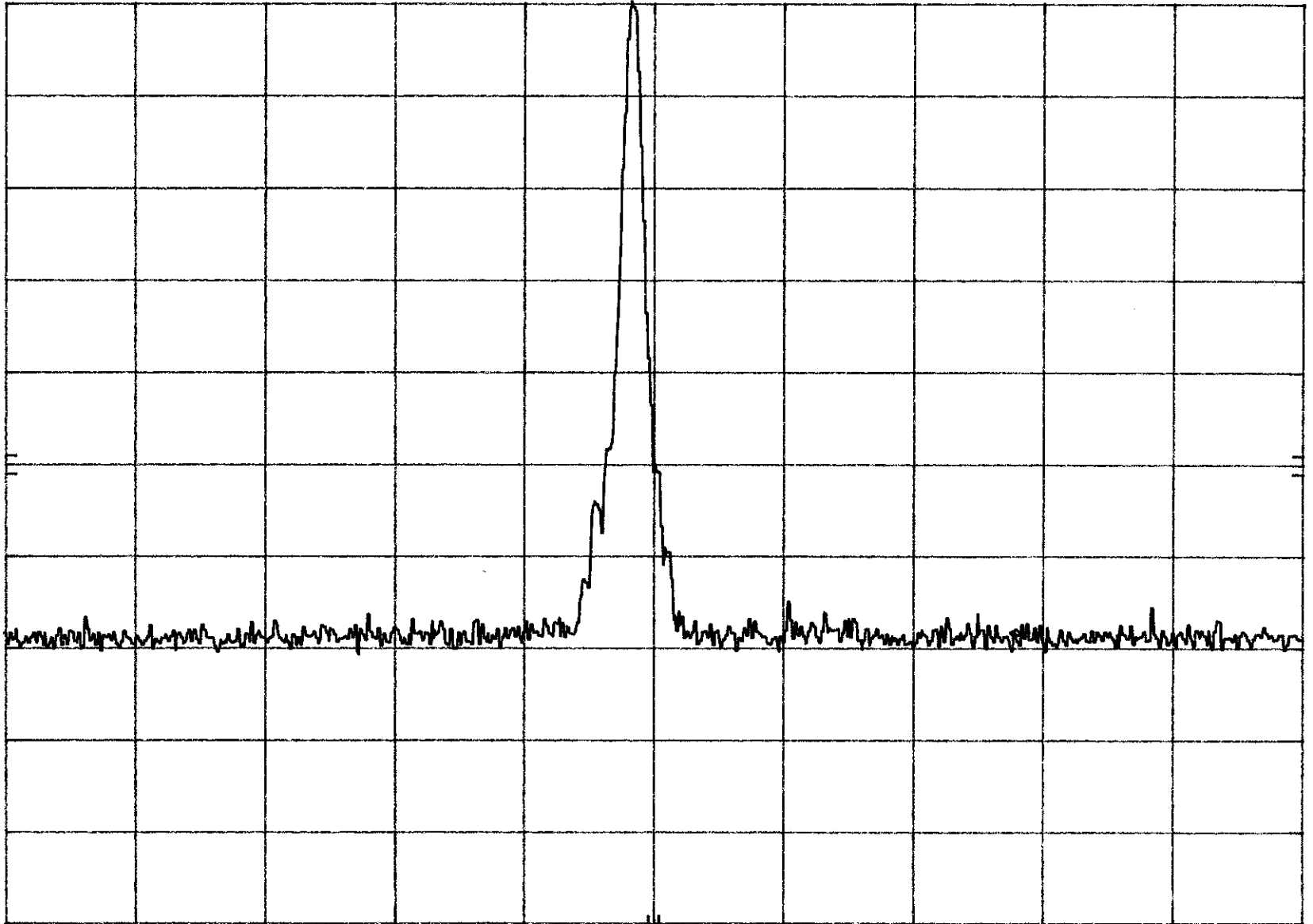

START 2.400 0 GHz

STOP 2.483 5 GHz

RES BW 100 kHz

VBW 100 kHz

SWP 25.1 msec

Plot 5b,3

MKR 6.617 GHz
-37.40 dBm

hp REF 23.2 dBm ATTEN 40 dB

10 dB/

OFFSET
3.2
dB

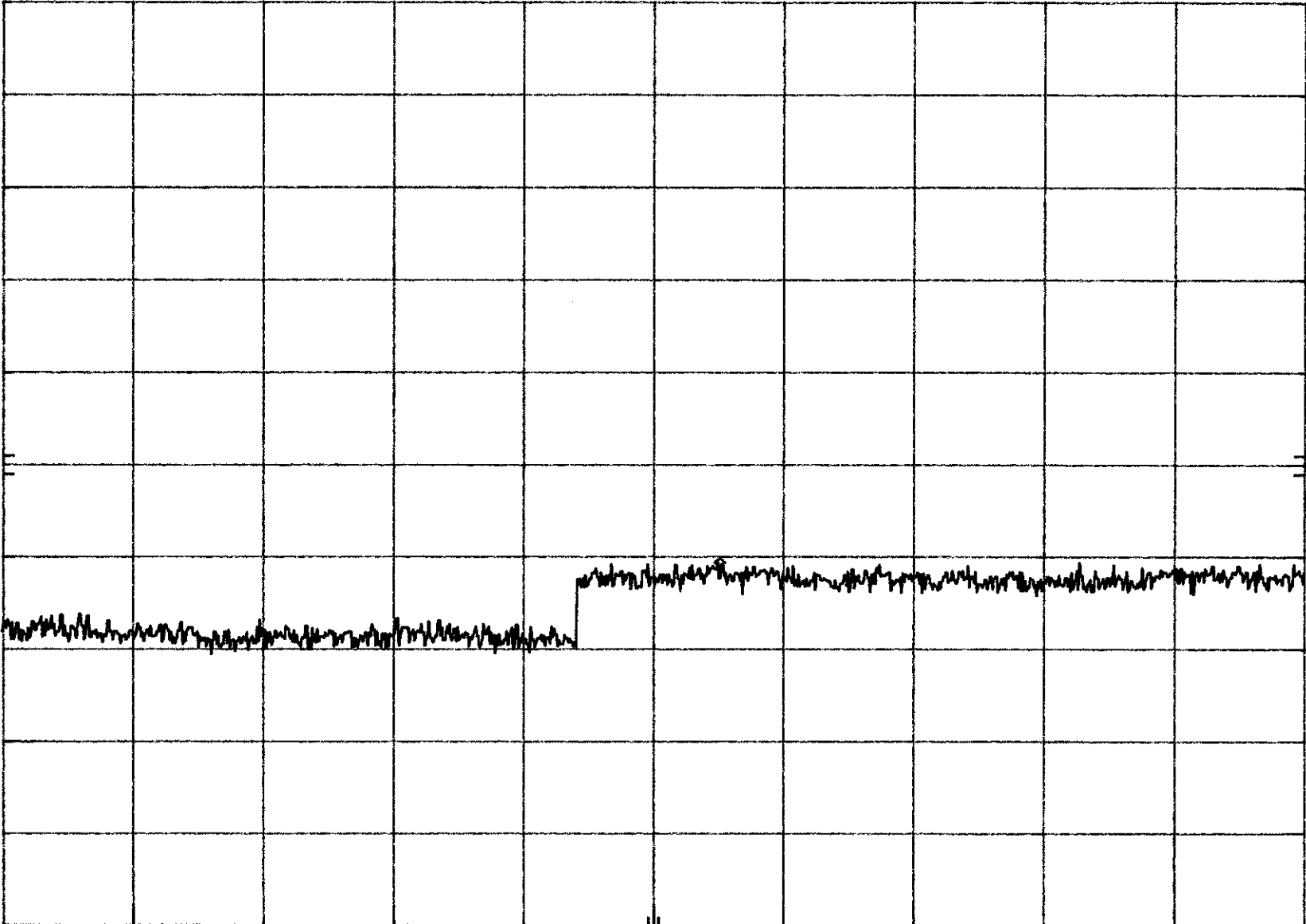

START 2.48 GHz

STOP 10.00 GHz

Plot 5b,4

RES BW 100 kHz

VBW 100 kHz

SWP 2.25 sec

MKR 23.94 GHz
-33.80 dBm

hp REF 23.2 dBm ATTEN 30 dB

10 dB/

OFFSET
3.2
dB

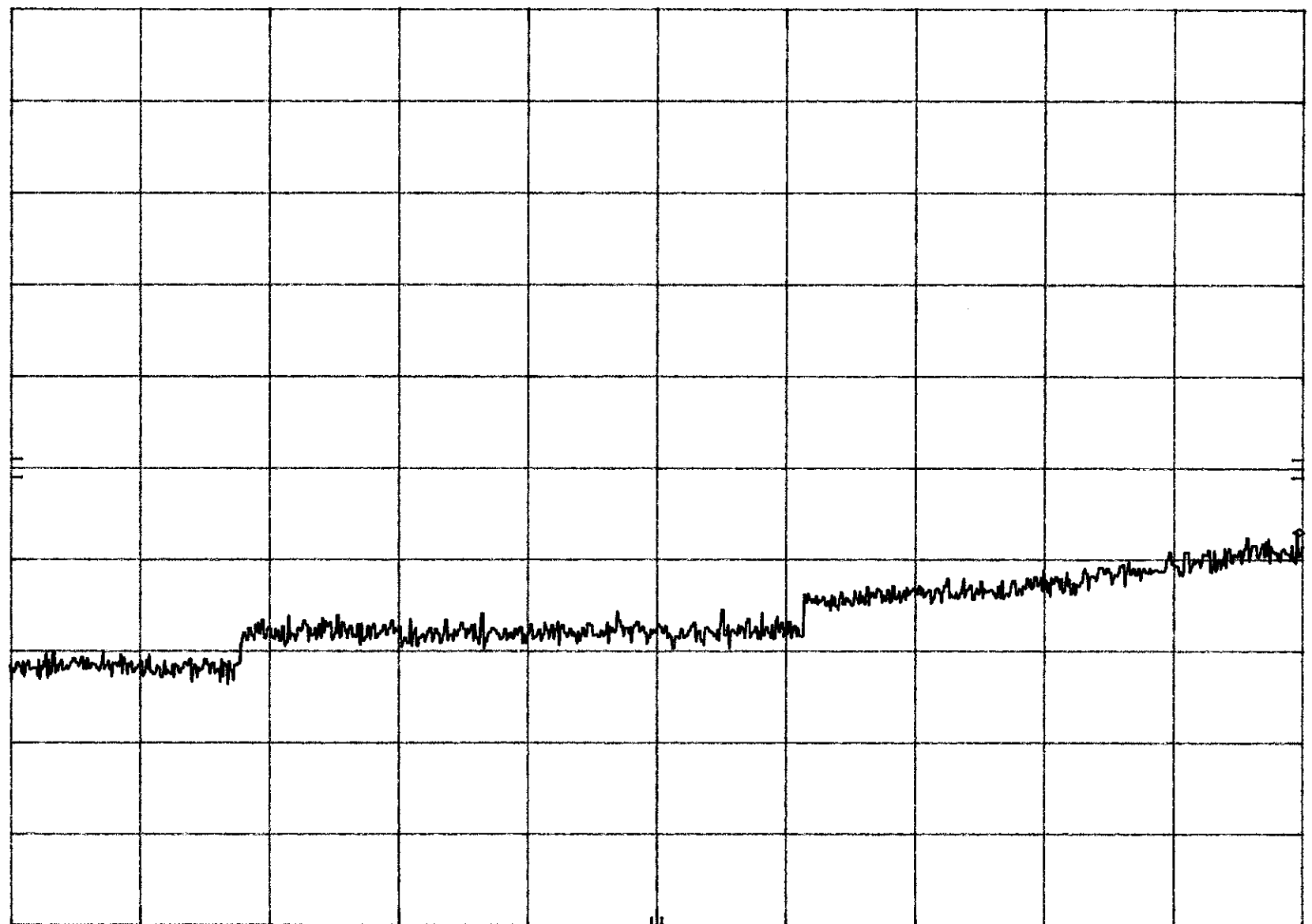

START 10.0 GHz

STOP 24.0 GHz

Plot 5b,5

RES BW 100 kHz

VBW 100 kHz

SWP 4.20 sec

MKR 63.37 MHz
-46.10 dBm

hp REF 26.7 dBm ATTEN 40 dB

10 dB/

OFFSET
1.0
dB

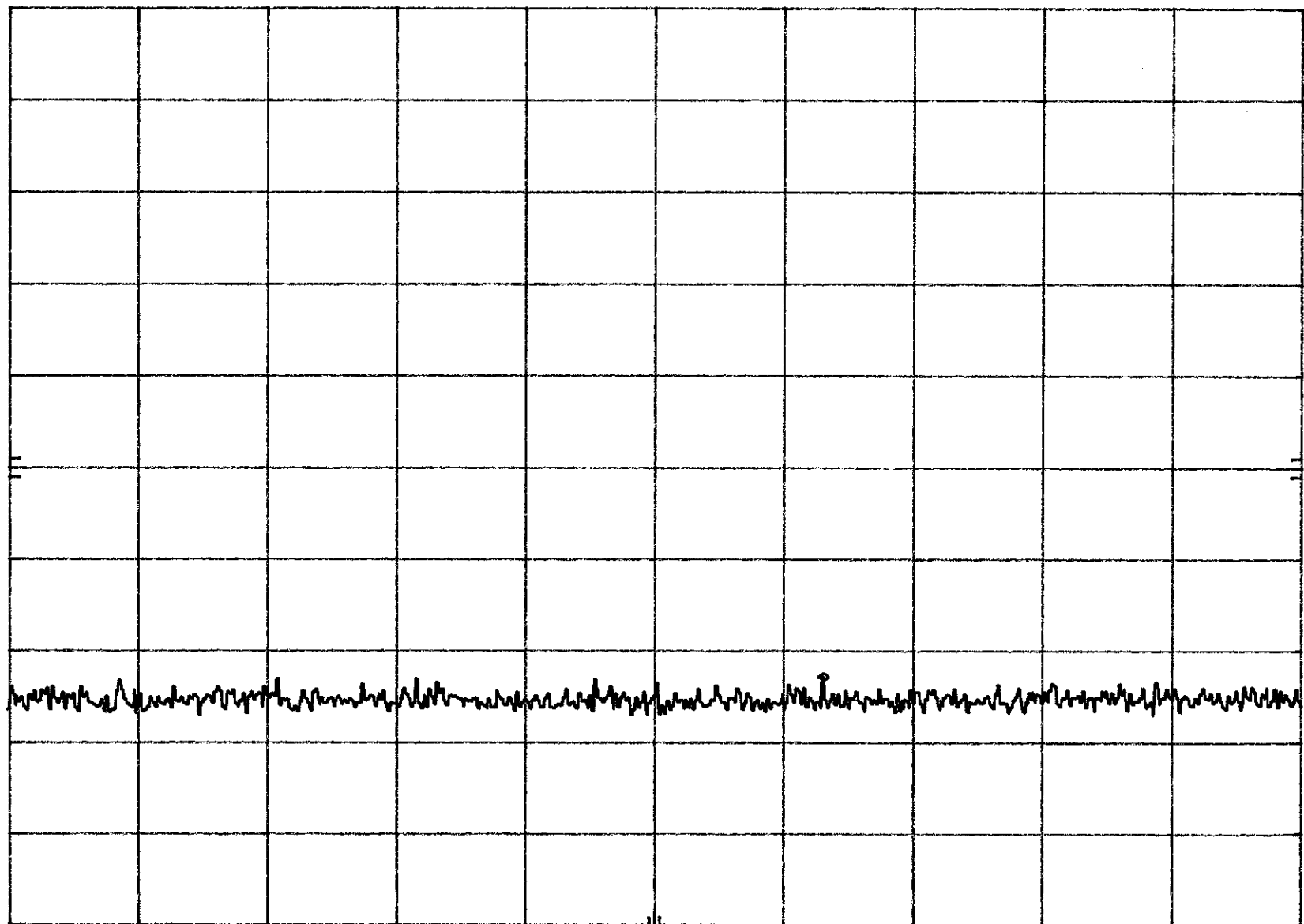

START 1.0 MHz STOP 100.0 MHz
Plot 5c,1 RES BW 100 kHz VBW 100 kHz SWP 29.7 msec

MKR 668.8 MHz
-42.50 dBm

hp REF 26.7 dBm ATTEN 40 dB

10 dB/

OFFSET
1.0
dB

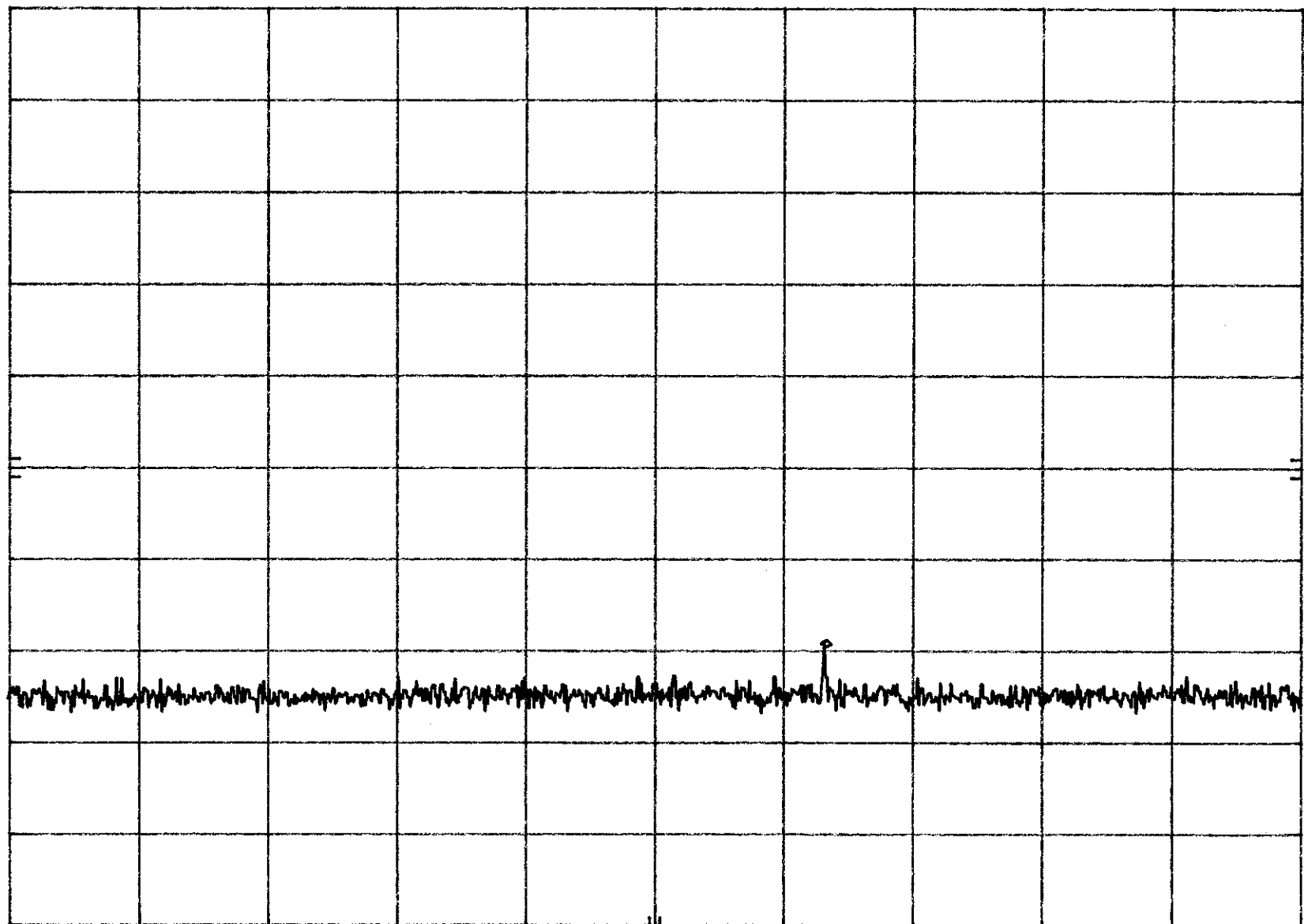

START 100 MHz RES BW 100 kHz VBW 100 kHz STOP 1.000 GHz
SWP 270 msec

MKR 2.186 GHz
-44.50 dBm

hp REF 26.7 dBm ATTEN 40 dB

10 dB/

OFFSET
1.0
dB

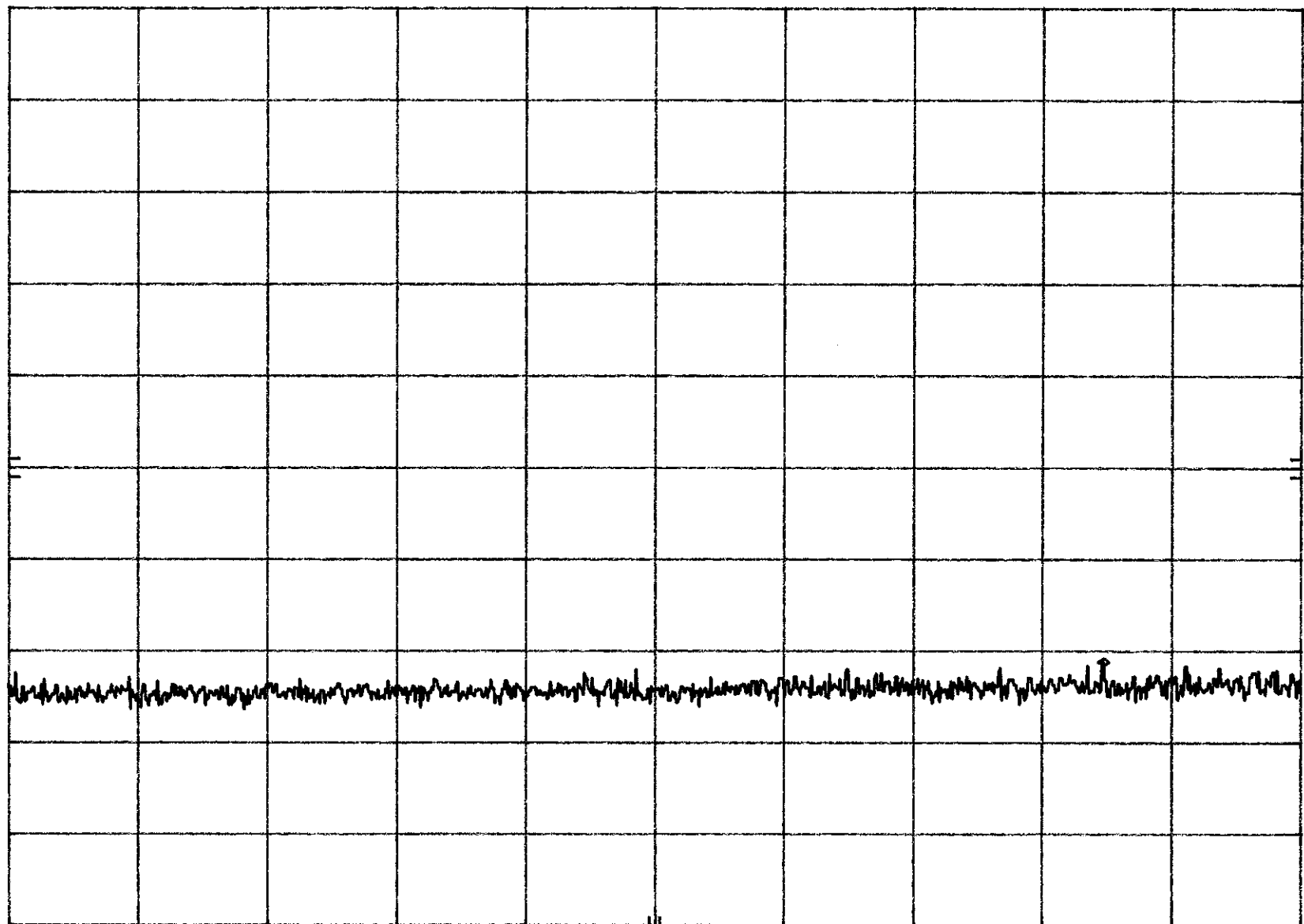

START 1.00 GHz STOP 2.40 GHz
RES BW 100 kHz VBW 100 kHz SWP 420 msec

Plot 5c,3

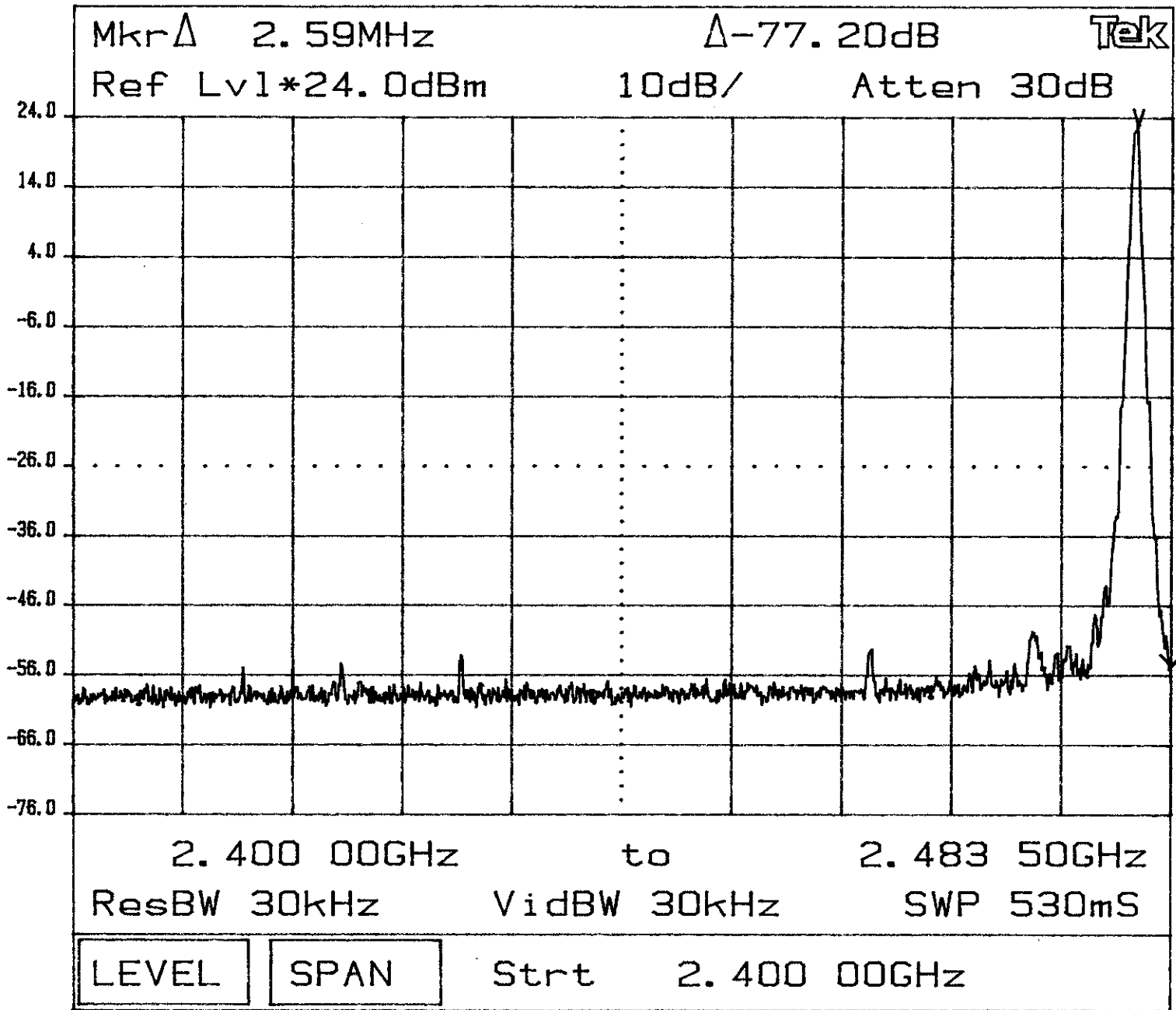

KNOB 2

KNOB 1

KEYPAD

Tektronix

2784

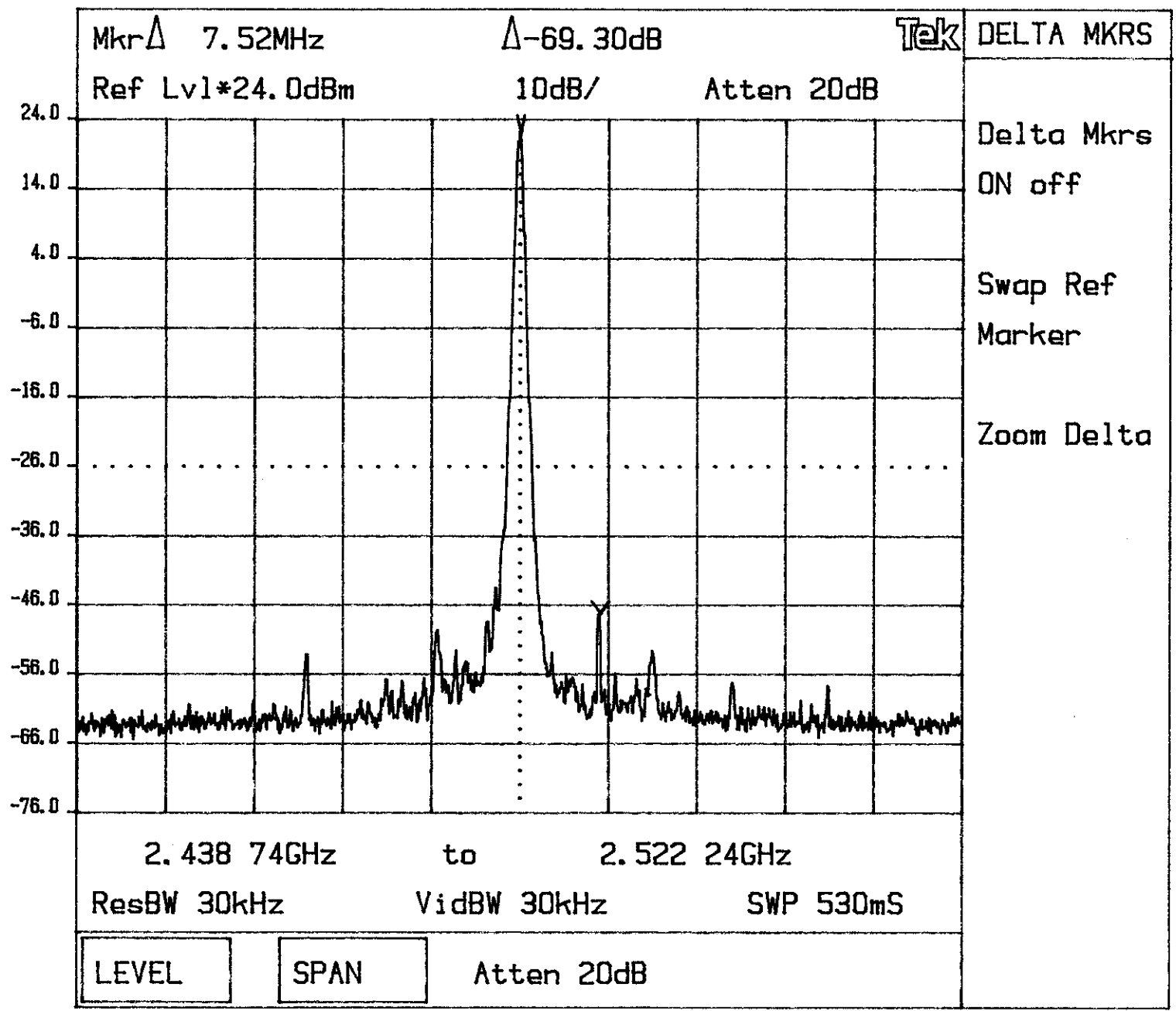

Knob 2

Knob 1

Keypad

Tektronix

2784

MKR 6.572 GHz
-38.50 dBm

hp REF 26.7 dBm ATTEN 40 dB

10 dB/

OFFSET
1.0
dB

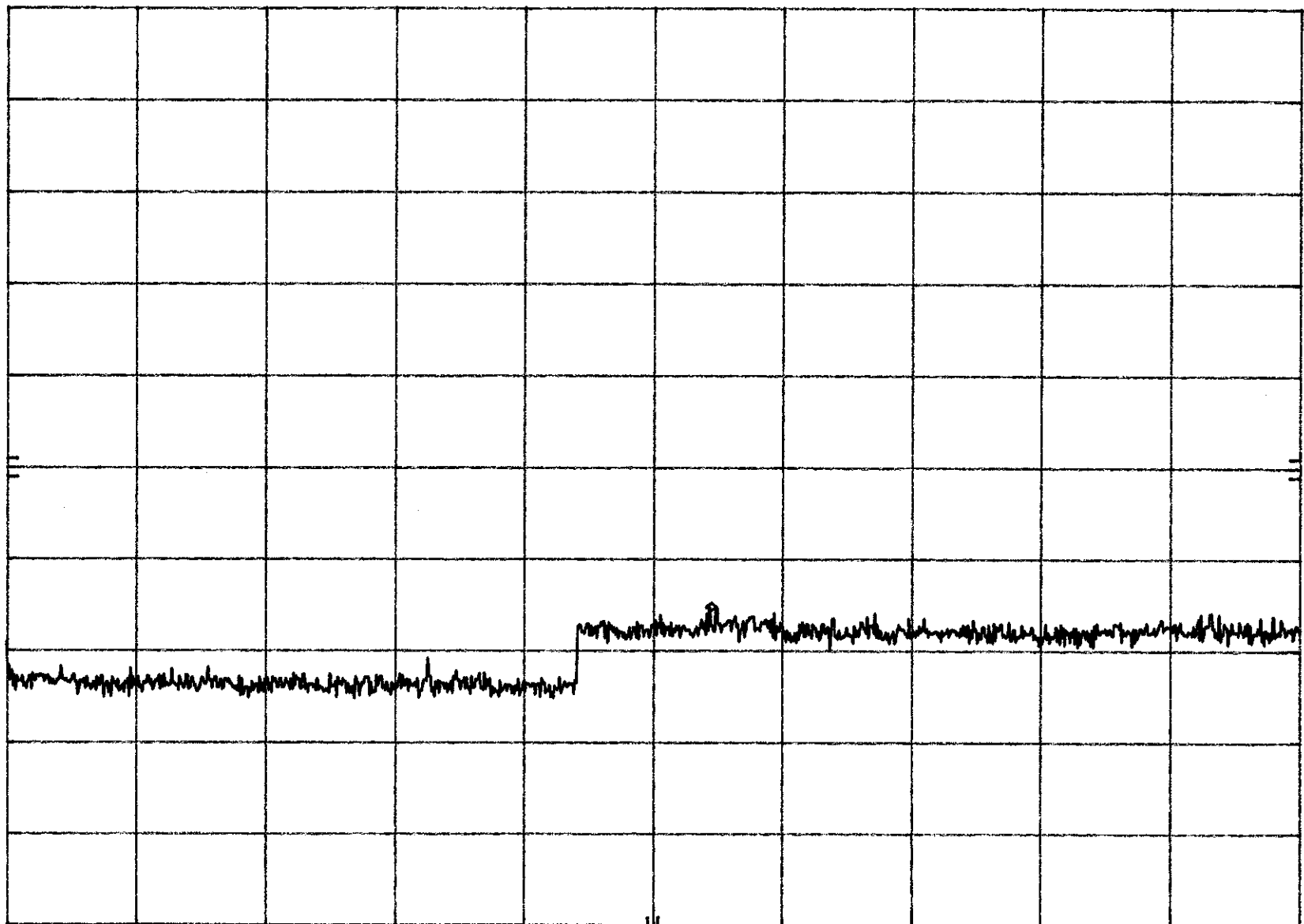

START 2.48 GHz RES BW 100 kHz VBW 100 kHz STOP 10.00 GHz
SWP 2.25 sec

MKR 23.94 GHz
-36.40 dBm

hp REF 21.0 dBm ATTN 30 dB

10 dB/

OFFSET
1.0
dB

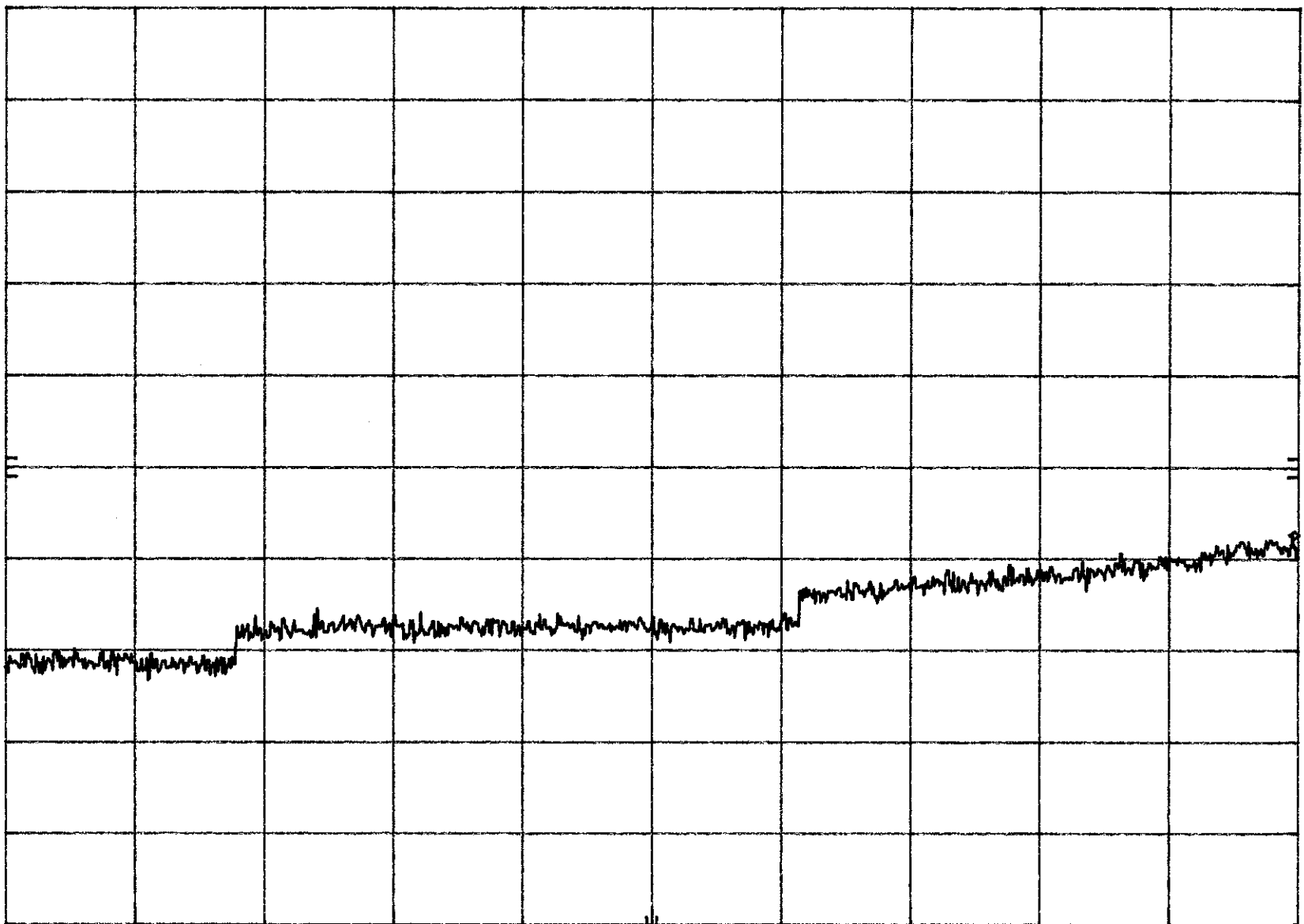

START 10.0 GHz RES BW 100 kHz VBW 100 kHz STOP 24.0 GHz
SWP 4.20 sec

Plot 5c,7

4.6 Out of Band Radiated Emissions (for emissions in § 4.6 above that are less than 26 dB below carrier), FCC Ref: 15.247 (c)

For out of band emissions that are close to or that exceed the 20 dB attenuation requirement described in the specification, radiated measurements were performed at a 3 m separation distance to determine whether these emissions complied with the general radiated emission requirement.

Test results are attached.

Not required, all emissions more than 26 dB below fundamental

4.7 Transmitter Radiated Emissions in Restricted Bands, FCC Ref: 15.247(c),

Radiated emission measurements were performed from 30 MHz to 25000 MHz. Analyzer resolution is 100 kHz or greater for frequencies from 30 MHz to 1000 MHz and 1 MHz for frequencies above 1000 MHz.

Data is included of the worst case configuration (the configuration which resulted in the highest emission levels). A sample calculation, configuration photographs and data tables of the emissions are included. All measurements were performed with peak detection and average detection (above 1 GHz) unless otherwise specified.

On the following pages, the emissions on the harmonics frequencies, the limits, and the margin of compliance are presented. These tests were made when the transmitter is in full radiated power.

The additional test was performed to show compliance with the requirement at the band-edge frequency 2483.5 MHz and up to 2500 MHz.

The transmitter was setup to transmit at the highest channel. The spectrum analyzer with resolution bandwidth 1 MHz was connected to the antenna terminal of the transmitter. The antenna conducted emissions in the band 2400 - 2483.5 MHz were measured and plotted. The difference (delta) between the levels on fundamental frequency and on the frequency 2483.5 MHz was determined. Then the field strength (E_0 in dBuV/m) of radiated emission at the fundamental frequency at 3 m was measured.

The radiated emission (E_1 in dBuV/m) at 2483.5 MHz was calculated as follows:

$$E_1 = E_0 - \text{delta.}$$

The same procedure was used to measure the radiated emissions at the frequency 2390 MHz and down to 2310 MHz.

For the test results, refer to plot numbers 5.a.4, 5.c.4, and 5.c.5 in section 4.5.

For transmitters with hopping channel ON times < 100 msec, DUTY CYCLE CORRECTION is permitted for emissions above 1000 MHz: Duty Cycle of 0 dB was used.

4.9 Radiated Emissions from Digital Section of Transceiver, FCC Ref: 15.109

Not Applicable - No digital part

Test results are attached



ITS Intertek Testing Services

Company: Symbol Technologies
Project #: 599013298
Model: LA 3021-500-US
Engineer: Xi-Ming Yang
Date of test: June 9,1999

FCC 15 Class B Radiated Emissions

Frequency	Antenna Polarity	Reading dB(uV)	Antenna Factor dB/m	Cable Loss dB	Pre-amp dB	Distance Factor dB	Corrected Reading dB(uV/m)	Limit dB(uV/m)	Margin dB
MHz	H N								
60.0	H	31.5	4.7	0.0	0.0	0.0	36.2	40.0	-3.8
140.0	H	27.7	8.4	0.0	0.0	0.0	36.1	43.5	-7.4
160.0	H	31.0	8.8	0.0	0.0	0.0	39.8	43.5	-3.7
200.0	H	29.9	10.2	0.0	0.0	0.0	40.1	43.5	-3.4
240.0	H	30.0	11.0	0.0	0.0	0.0	41.0	46.0	-5.0
260.0	H	31.0	12.0	0.0	0.0	0.0	43.0	46.0	-3.0
280.0	H	30.0	12.1	0.0	0.0	0.0	42.1	46.0	-3.9
300.0	H	26.8	13.1	0.0	0.0	0.0	41.9	46.0	-4.1
380.0	H	26.0	15.0	0.0	0.0	0.0	41.0	46.0	-5.0
450.0	H	25.0	16.0	0.0	0.0	0.0	41.0	46.0	-5.0
720.0	H	10.8	20.4	0.0	0.0	0.0	31.2	46.0	-14.8

- Note:
1. All measurement were made at 3 meters
 2. Negative signs (-) in the margin column signify levels below the limit.

4.10 Radiated Emissions from Receiver Section of Transceiver (L.O. Radiation), FCC Ref:
15.109, 15.111

[X] Not required - EUT operation above 960 MHz only

[] Not Applicable - EUT is transmitter only

[] Not performed; exempt until June 1999

[] Test results are attached

4.11 AC Line Conducted Emission, FCC Rule 15.207:

Not required; battery operation only

Test data attached

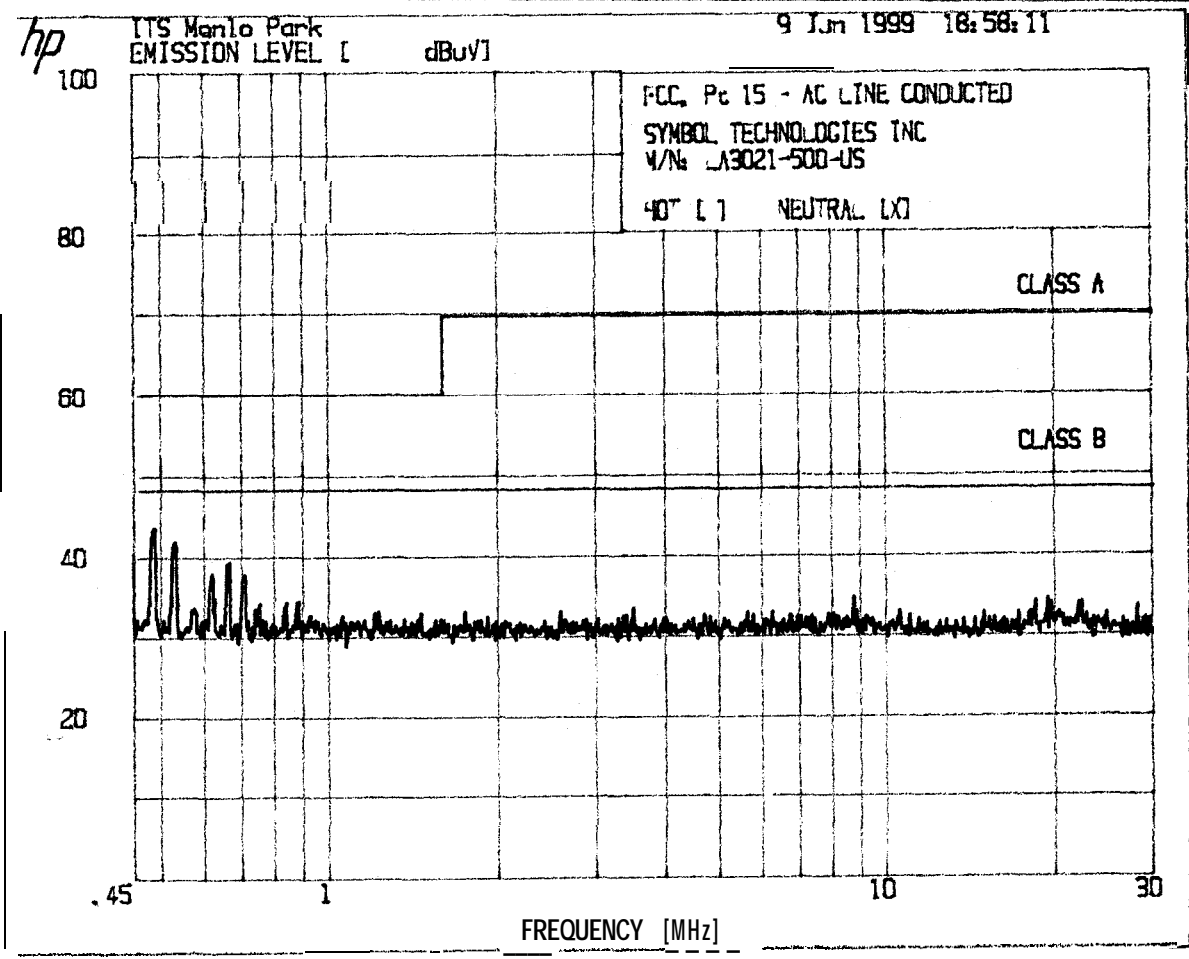
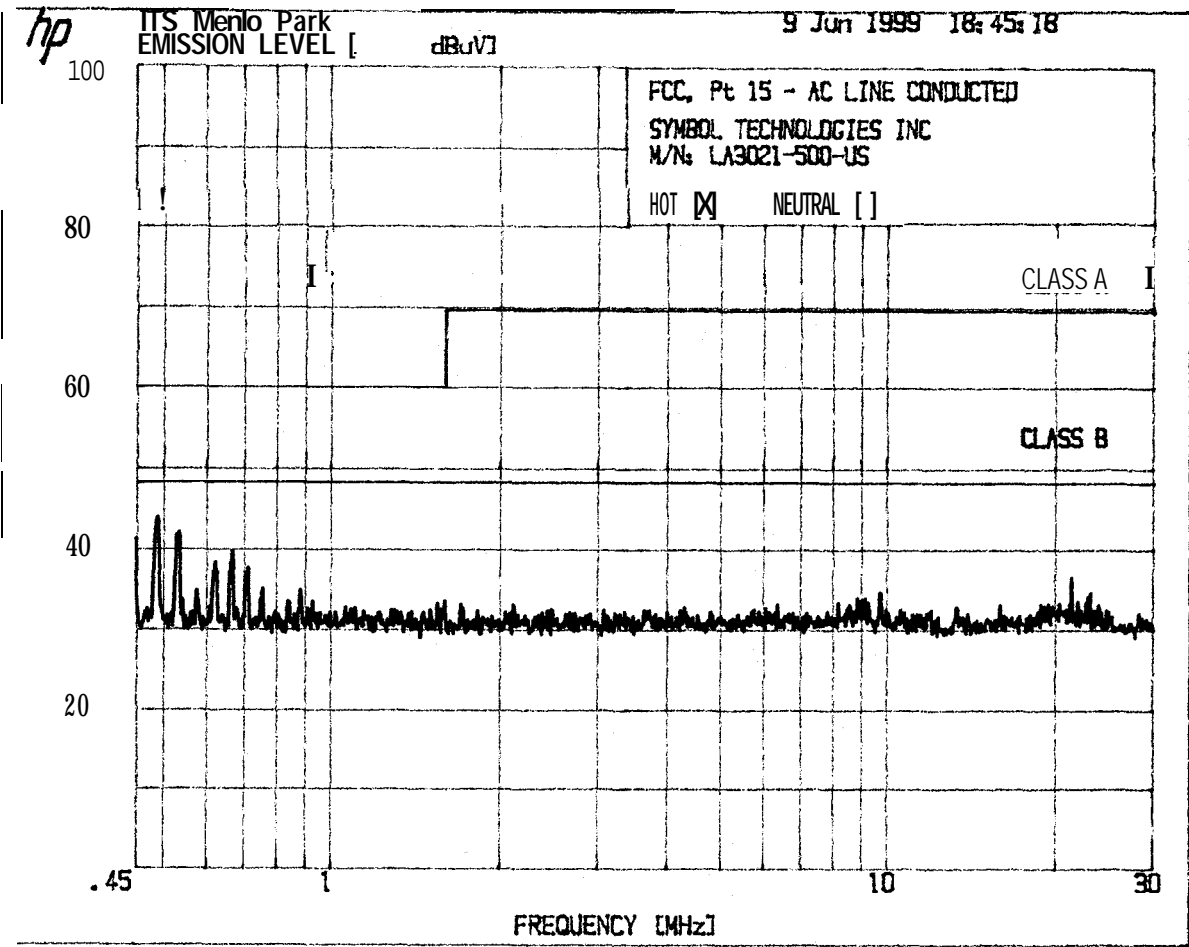

=====
ITS Menlo Park 9 Jun 1999 18:45:18
=====

3. FCC CFR 47, Pt 15
3.1 FCC, Pt 15 - AC LINE CONDUCTED
=====

SYMBOL TECHNOLOGIES INC
M/N: LA3021-500-US

HOT [X] NEUTRAL []

PEAKS FOUND ABOVE 35 dBuV

PEAK#	FREQ (MHz)	AMPL(dBuV)
1	.4935	43.8
2	.5390	42.0
3	.6268	38.2
4	.6732	39.7
5	.7169	37.6
6	21.54	36.6

=====
ITS Menlo Park 9 Jun 1999 18:58:11
=====

3. FCC CFR 47, Pt 15
3.1 FCC, Pt 15 - AC LINE CONDUCTED
=====

SYMBOL TECHNOLOGIES INC
M/N: LA3021-500-US

HOT [] NEUTRAL [X]

PEAKS FOUND ABOVE 38 dBuV

PEAK#	FREQ (MHz)	AMPL (dBuV)
1	.4914	43.4
2	.5367	41.8
3	.6704	39.3

4.12 AC Line Conducted Configuration Photograph



5.0 **Equipment Photographs**

Photographs of the EUT are attached.

6.0 **Product Labeling**

6.1 Label Artwork

6.2 Label Location

See attached pages.

7.0 **Technical Specifications**

7.1 Circuit Diagram

See attached pages.

7.2 Block Diagram

See attached pages.

7.3 Antenna gain and Mounting Information

See attached pages.

8.0 **Instruction Manual**

Attached is a preliminary copy of the Instruction Manual.

Please note that the required FCC Information to the User can be found on Page ___ of this manual.

This manual will be provided to the end-user with each unit sold/leased in the United States.