

S P T 1 8 0 0 S e r i e s



symbol[®]

S P T 1 8 0 0 S e r i e s

© 2001 SYMBOL TECHNOLOGIES, INC. All rights reserved.

Symbol reserves the right to make changes to any product to improve reliability, function, or design.

Symbol does not assume any product liability arising out of, or in connection with, the application or use of any product, circuit, or application described herein.

No license is granted, either expressly or by implication, estoppel, or otherwise under any patent right or patent, covering or relating to any combination, system, apparatus, machine, material, method, or process in which Symbol products might be used. An implied license only exists for equipment, circuits, and subsystems contained in Symbol products.

Symbol and the Symbol logo are registered trademarks of Symbol Technologies, Inc. Other product names mentioned in this manual may be trademarks or registered trademarks of their respective companies and are hereby acknowledged.

Symbol Technologies, Inc.
One Symbol Plaza
Holtsville, N.Y. 11742-1300
<http://www.symbol.com>

Patents

This product is covered by one or more of the following U.S. and foreign Patents:

U.S. Patent No. 4,460,120; 4,496,831; 4,593,186; 4,603,262; 4,607,156; 4,652,750; 4,673,805; 4,736,095; 4,758,717; 4,816,660; 4,845,350; 4,896,026; 4,897,532; 4,923,281; 4,933,538; 4,992,717; 5,015,833; 5,017,765; 5,021,641; 5,029,183; 5,047,617; 5,103,461; 5,113,445; 5,130,520; 5,140,144; 5,142,550; 5,149,950; 5,157,687; 5,168,148; 5,168,149; 5,180,904; 5,216,232; 5,229,591; 5,230,088; 5,235,167; 5,243,655; 5,247,162; 5,250,791; 5,250,792; 5,260,553; 5,262,627; 5,262,628; 5,266,787; 5,278,398; 5,280,162; 5,280,163; 5,280,164; 5,280,498; 5,304,786; 5,304,788; 5,306,900; 5,321,246; 5,324,924; 5,337,361; 5,367,151; 5,373,148; 5,378,882; 5,396,053; 5,399,055; 5,399,846; 5,408,081; 5,410,139; 5,410,140; 5,412,198; 5,418,812; 5,420,411; 5,436,440; 5,444,231; 5,449,891; 5,449,893; 5,468,949; 5,471,042; 5,478,998; 5,479,000; 5,479,002; 5,479,441; 5,504,322; 5,519,577; 5,528,621; 5,532,469; 5,543,610; 5,545,889; 5,552,592; 5,557,093; 5,578,810; 5,581,070; 5,589,679; 5,589,680; 5,608,202; 5,612,531; 5,619,028; 5,627,359; 5,637,852; 5,664,229; 5,668,803; 5,675,139; 5,693,929; 5,698,835; 5,705,800; 5,714,746; 5,723,851; 5,734,152; 5,734,153; 5,742,043; 5,745,794; 5,754,587; 5,762,516; 5,763,863; 5,767,500; 5,789,728; 5,789,731; 5,808,287; 5,811,785; 5,811,787; 5,815,811; 5,821,519; 5,821,520; 5,823,812; 5,828,050; 5,850,078; 5,861,615; 5,874,720; 5,875,415; 5,900,617; 5,902,989; 5,907,146; 5,912,450; 5,914,478; 5,917,173; 5,920,059; 5,923,025; 5,929,420; 5,945,658; 5,945,659; 5,946,194; 5,959,285; 6,002,918; 6,021,947; 6,036,098; 6,047,892; 6,050,491; 6,053,413; 6,056,200; 6,065,678; 6,067,297; 6,068,190; 6,082,621; 6,084,528; 6,088,482; 6,092,725; 6,101,483; 6,102,293; 6,104,620; 6,114,712; 6,115,678; 6,119,944; 6,123,265; 6,131,814; 6,138,180; 6,142,379; 6,172,478; 6,176,428; 6,178,426; 6,186,400; 6,188,681; D305,885; D341,584; D344,501; D359,483; D362,453; D363,700; D363,918; D370,478; D383,124; D391,250; D405,077; D406,581; D414,171; D414,172; D418,500; D419,548; D423,468; D424,035; D430,158; D430,159; D431,562; D436,104.

Invention No. 55,358; 62,539; 69,060; 69,187 (Taiwan); No. 1,601,796; 1,907,875; 1,955,269 (Japan).

European Patent 367,299; 414,281; 367,300; 367,298; UK 2,072,832; France 81/03938; Italy 1,138,713.

rev. 04/01

Introduction

Congratulations on your purchase of Symbol Technologies' SPT 1800 Series Terminal! The unique combination of capabilities offered by this product makes it superior for use in a wide range of applications:

- Personal Information Management software
- RF communication via Symbol's Spectrum24® wireless network (SPT 184X) or wide area network (SPT 183X)
- pocket size
- printing support
- 1-D and 2-D scanning capability.

About This Guide

This guide covers the procedures for the setup and use of the terminal. Specific topics covered include:

- *Parts of the SPT 1800 on page 2*
- *Installing the SIM Card (SPT 1834 Only) on page 5*
- *Installing the Battery on page 6*
- *Starting the SPT 1800 on page 8*
- *Using the SPT 1800 on page 9*
- *Writing with the Stylus on page 10*
- *Resetting the SPT 1800 on page 12*
- *Attaching the Handstrap on page 13*
- *Scanning 1-D Bar Codes on page 14*
- *Scanning PDF417 (2-D) Bar Codes on page 14*
- *Initiating a Network Connection on page 15*
- *Maintaining the SPT 1800 on page 16*
- *Troubleshooting on page 17.*

The *SPT 1800 Product Reference Guide* (p/n 72-51337-xx), available from Symbol or your Reseller, details the applications available on the SPT 1800.



Parts of the SPT 1800

The following illustration indicates each part of the SPT 1800.

Front View

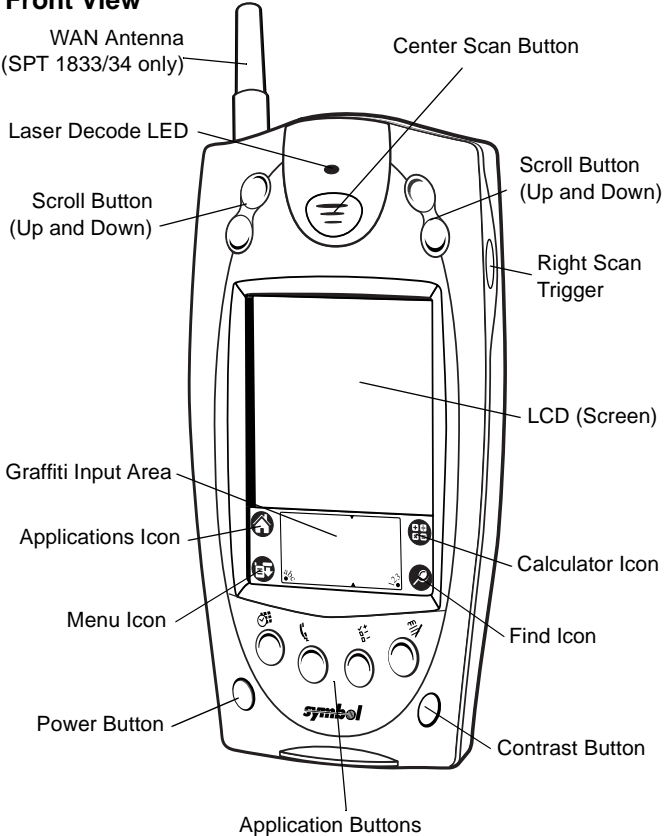

Parts of the SPT 1800 (continued)

Left View

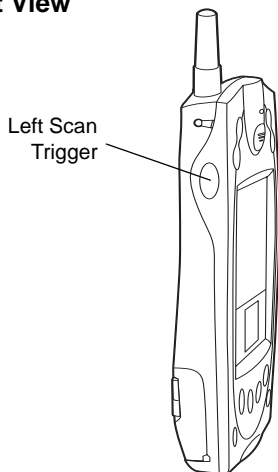

Top View

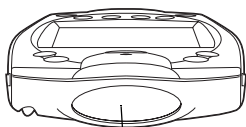

Scanner Exit Window

Bottom View

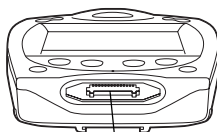

Serial Port



Parts of the SPT 1800 (continued)

Back View

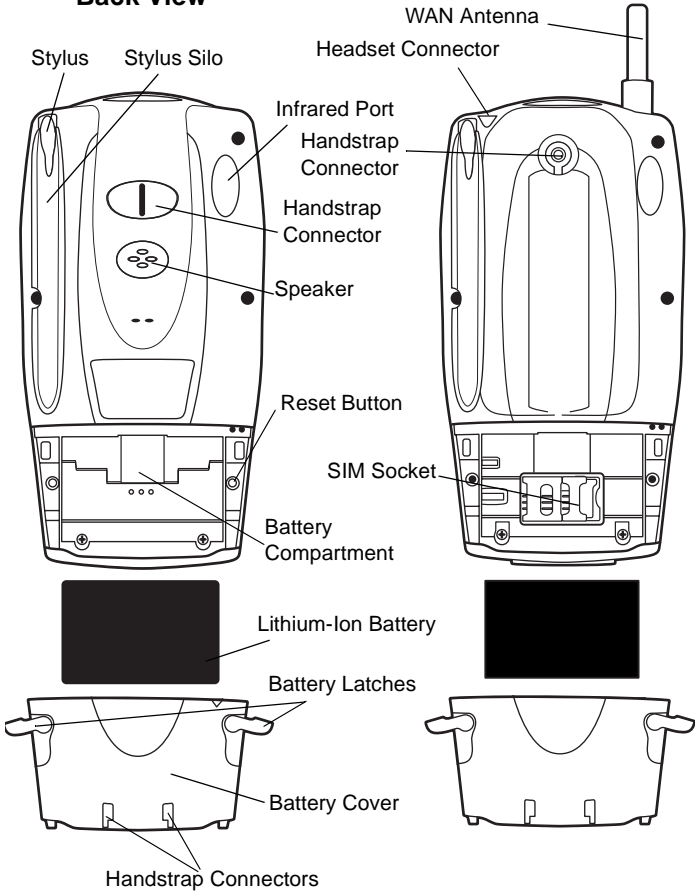

Getting Started

Before you can use your SPT 1800, perform the basic setup procedures:

- Install the SIM card (SPT 1834 only)
- Install and charge the battery
- Start the SPT 1800
- Initiate the network connection (SPT 183X/184X only).

Installing the SIM Card (SPT 1834 Only)

Open the latches on the battery cover and lift it away from the SPT1834.

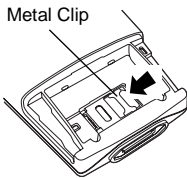

1. Slide the metal clip to the left to release the SIM cardholder.

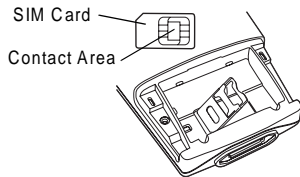

2. Lift the cardholder to an upright position.

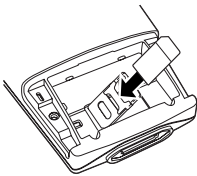

3. Insert the card between the cardholder body and the metal clip; be sure the beveled corner of the SIM card is on the top.

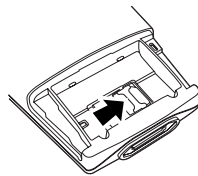

4. Close the cardholder (with the contact area of the card facing down).
5. Slide the metal clip to the right to lock it in place.

Installing the Battery

1. Open the latches on the battery cover and lift it away from the SPT 1800.
2. Insert the lithium-ion (Li-ion) battery into the battery compartment, ensuring that it snaps into place.

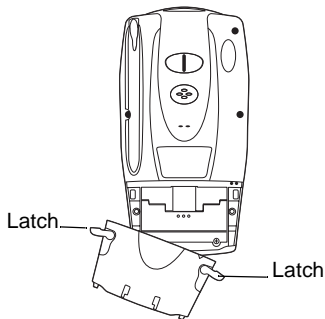

3. Replace the battery cover and close the latches.

Note: Keep the battery latches completely open while securing the battery cover.

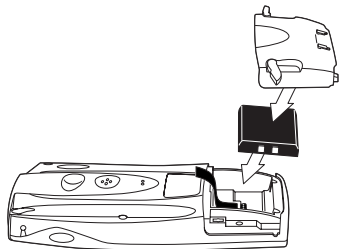

Charging the Battery

Note: The SPT 1800 battery (p/n 20-36098-01) must be used only with the SPT 1800.

Before using your SPT 1800 for the first time, charge the battery using the cradle, the Synchronization/Charging Cable or the Universal Battery Charger (UBC). For instructions on using the UBC, see the *UBC Quick Reference Guide*.

Caution: The main battery charges the backup battery in the SPT 1800. Once the battery is fully charged, do not remove it from the SPT 1800 for 24 hours. During this period, the SPT 1800 cannot maintain any user data if the battery is removed from the terminal.

Using the Cradle to Charge the Battery

1. Ensure the battery is installed in the terminal.
2. Plug the cradle into a wall outlet.
3. Insert the SPT 1800 into the cradle.

The terminal's battery is fully charged after approximately two hours. You can also charge a spare battery by inserting it into the spare battery charging slot on the back of the single slot cradle. The spare battery fully charges in approximately two hours. See the *CRD 1700 Cradle Quick Reference Guide* for more information.

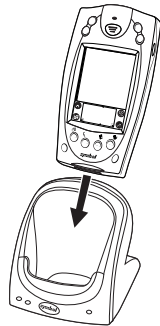

Note: When the battery is fully charged, the cradle's charging LED lights green. On older CRD 1700 single slot and modem cradles, the charging LED may not illuminate green when the terminal's battery is fully charged.

Using the Synchronization/Charging Cable to Charge the Battery

1. Ensure the battery is installed in the terminal.
2. Insert the cable into the bottom of the terminal.

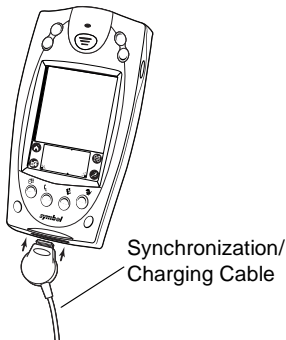

3. Plug the power cable into a wall outlet and plug the other end into the battery charging receptacle on the side of the Synchronization/Charging Cable.

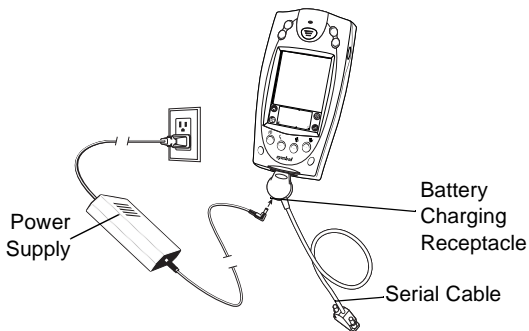

The battery is fully charged after approximately two hours.

Starting the SPT 1800

Press the red power button to power on the terminal. If the terminal does not power on, perform a hard reset. See [Performing a Hard Reset on page 12](#).

Calibrating the Screen

The first time you start your SPT 1800, the Welcome utility appears. Follow the steps to align the internal circuitry of your SPT 1800 with its touch-sensitive screen, and to set the current time and date.

Note: If your SPT 1800 unit came pre-loaded with a custom software application, you may not need to calibrate your screen, in which case you will not see the Welcome utility.

Q u i c k R e f e r e n c e

1. Press the power button on the front panel of your SPT 1800 to display the Welcome utility. (This also displays following a hard reset).



Note: If necessary, adjust the contrast control on the SPT 1800 so the screen is clear and readable. See [Contrast Control on page 10](#) for instructions.

2. Follow the instructions on the screen.
3. Tap the exact center of each target that appears on the screen with the tip of the stylus.

If, at any time, you need to recalibrate the screen, open the *Preferences* application, tap *General* on the top right corner of the screen, and select the *digitizer* option from the pull down menu.

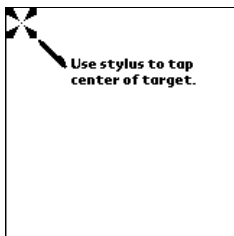

Using the SPT 1800

Power Button/Backlight Control

The power button turns the SPT 1800 on and off. This button also serves as your backlight control for low-light conditions. When the SPT 1800 is on, press and hold the power button for approximately two seconds to turn the backlight on and off.

Contrast Control

The contrast control button is located on the lower right-hand side of the SPT 1800.

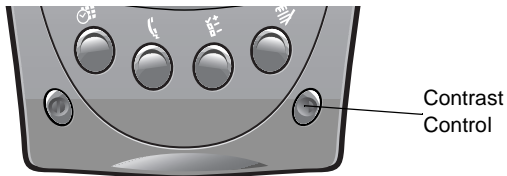

1. Press the contrast control button to display the contrast adjusting bar on the screen.
2. Using your stylus, adjust the contrast by scrolling the contrast bar until the contrast is set to the desired level, or use either of the scroll buttons on the top of the terminal to adjust the contrast level.
3. Press the contrast control button or tap Done on the screen to turn off the contrast control.

Writing with the Stylus

Your SPT 1800 includes Graffiti[®] handwriting software for entering text and numbers. Graffiti translates stylus strokes into letters or numbers. See the *SPT 1800 Product Reference Guide*, p/n 72-51337-xx for more information.

On-screen Keyboard

You can activate the on-screen keyboard any time you need to enter text or numbers on your SPT 1800. Note that you cannot enter Graffiti characters while using the on-screen keyboard.



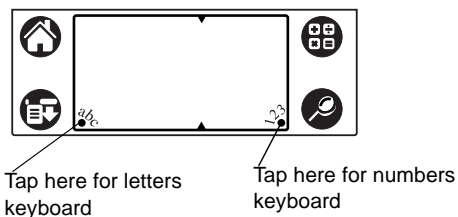

1. Open any application.
2. Tap any record name, or tap the *New* button with the tip of the stylus.

Q u i c k R e f e r e n c e

3. Tap the left target to open the Alpha keyboard, or tap the right target to open the Numeric keyboard.



Icon Descriptions

	Applications Icon	Exits the current application and lists available applications for selection.
	Calculator Icon	Displays the calculator application.
	Menu Icon	Tap from within an application to display the options menu for the application.
	Find Icon	Tap from within an application to enter search criteria to find an entry.

Using a Headset (SPT 1834 Only)

To use a headset with the SPT 1834, plug the headset jack into the audio connector on the top of the terminal

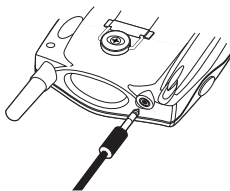

Resetting the SPT 1800

If your SPT 1800 stops responding to input, you may need to perform a reset.

Performing a Soft Reset

A soft reset restarts the SPT 1800 and saves all records and entries stored in your SPT 1800 terminal. After a soft reset, the Palm Computing Platform® Logo screen appears followed by the General Preferences screen.

To perform a soft reset, remove the battery cover and gently press the reset button located under the battery cover.

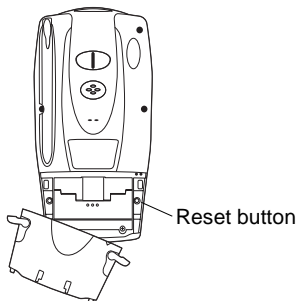

Performing a Hard Reset

A hard reset also restarts your terminal, but erases all records and entries stored in your SPT 1800. *Therefore, never perform a hard reset unless a soft reset does not solve your problem.*

Note: You can restore any data previously synchronized with your computer during the next HotSync operation.

1. Remove the battery cover.
2. Hold down the power button on the front of the SPT 1800, and gently press the reset button.
3. Release the reset button, then release the power button when the Palm logo appears.
4. When a message appears on the screen warning that you are about to erase all data, do one of the following:
 - a. Press the upper half of a scroll button to complete the hard reset.
 - b. Press any other button to perform a soft reset.

Note: With a hard reset, the current date and time are retained. Formats, preferences and other settings are restored to their factory default settings.

Attaching the Handstrap

The SPT 1800 has a handstrap which increases comfort when holding it for extended periods of time.

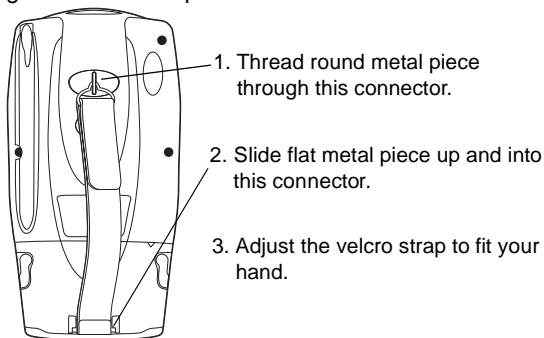

To attach the handstrap for the SPT 1834:

1. Put the side slots of the threaded button over the wire clips on the handstrap.
2. Screw the button into the threaded slot on the back of the terminal.
3. Slide the flat metal piece into the handstrap connection on the bottom of the terminal.

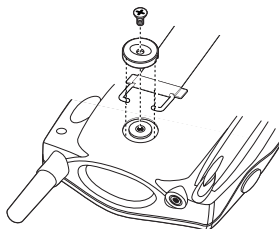

Scanning 1-D Bar Codes

The SPT 1800 has an integrated laser bar code scanner which allows you to collect data by scanning bar codes if your unit is configured with a scanning application. To scan bar codes:

1. Start your scanning application.
2. Aim the scanner at a bar code.
3. Press either the right, left or center scan trigger. Make sure the red scan beam covers the entire bar code. The green scan LED lights and a beep sounds to indicate a successful decode.

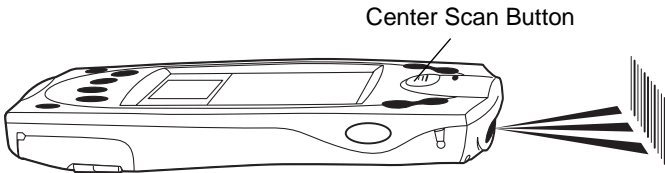

Scanning PDF417 (2-D) Bar Codes

To scan a PDF417 bar code (with a 2-D configured terminal):

1. Aim the scanner at the PDF bar code and press either the right, left, or center scan trigger.
2. Hold the trigger down and keep the scan line parallel to the rows of the symbol.
3. Manually raster the scan line by slowly moving the scanner up and down so it scans the entire bar code at a rate of one inch per second.



Q u i c k R e f e r e n c e

A clicking noise lets you know the 2-D bar code is being decoded. If there is no clicking noise when you are scanning, the bar code is not being scanned properly.

When decoding a very long 2-D bar code, you may notice a slight delay between the time when the terminal completes the decode and the time when the data is displayed on the screen. The first beep you hear indicates a successful decode. The second beep you hear indicates the data has been received by the host. Do not attempt to decode another bar code until you hear the second beep and see the green LED indicating a successful decode.

To improve PDF decoding:

- Check that PDF417 scanning is enabled.
- Make sure the scan line extends at least 1/2" past the left and right edges of the bar code.
- Hold the scanner closer for denser symbols, farther away for larger symbols.
- Make sure you scan the top and bottom rows of the symbol.
- Be patient - it may take a few swipes to decode the symbol.

The bar code is completely decoded when you hear a tone, followed by a short, high tone beep. The green LED stays lit for three seconds or until the next trigger pull.

Initiating a Network Connection

Before using the terminal, set up the Spectrum24, CDPD (Cellular Digital Packet Data) or GSM (Global System for Mobile Communication) network connection. Refer to the *SPT 1800 Series Product Reference Guide*, p/n 72-51337-xx for setup instructions.

A small cursor blinks at the top right-hand corner of the screen when the terminal activates a radio connection (Spectrum24 or CDPD). A blinking cursor does not appear for a GSM radio

connection. A cursor does not appear if you are not connected to the radio.

Maintaining the SPT 1800

For trouble-free service, observe the following tips when using your SPT 1800:

- Do not scratch the screen. Use the supplied stylus or a plastic-tipped pen intended for use with a touch-sensitive screen. Never use a pen or pencil or other sharp object on the screen.
- Although your SPT 1800 is water and dust resistant, do not expose it to rain or moisture for an extended period. Treat your SPT 1800 as you would a pocket calculator or other small electronic instrument.
- The touch-sensitive screen of your SPT 1800 contains glass. Do not subject your SPT 1800 to any strong impact.
- Protect your SPT 1800 from temperature extremes. Do not leave it on the dashboard of a car on a hot day, and keep it away from heaters and other heat sources.
- Do not store or use your SPT 1800 in any location that is extremely dusty, damp or wet.
- If the surface of the SPT 1800 screen becomes soiled, clean it with a soft lens cloth moistened with a diluted window-cleaning solution.

Troubleshooting

Problem	Cause	Solution
SPT 1800 terminal does not turn on.	Contrast is set too light.	Adjust the contrast control.
	Battery is not fully charged.	Make sure the battery is fully charged and installed properly.
	Battery is defective.	Replace the battery. If your SPT 1800 terminal still does not operate, try a soft reset; see Resetting the SPT 1800 on page 12.
Low battery warning after replacing the battery.	A normal condition.	The battery warning message may appear immediately after replacing the battery. In addition, if you check the battery gauge in the Applications Launcher <i>immediately</i> after replacing the battery, the gauge may start at "empty" and slowly rise to "full." This is normal. It takes a minute for the battery gauge to accurately show the condition of the battery.
No sound.	Sound setting is set to off in the <i>Preferences</i> section.	Check the Sound options in the General Preferences screen. If an option is set to off, there will be no sound. Tap the "off" setting to display a menu of options and tap the option you want.
SPT 1800 terminal turns itself off.	Terminal automatically turns itself off after a period of inactivity.	Your SPT 1800 is designed to turn itself off after a period of inactivity. This period can be set at thirty seconds, one minute, two minutes or three minutes. Check the "Auto-off after" setting in the General Preferences screen, and change the setting if you need a longer delay before the automatic shutoff feature activates. See the <i>SPT 1800 Product Reference Guide</i> for more information. Note: The terminal also turns itself off when the battery power is extremely low.



Problem	Cause	Solution
SPT 1800 doesn't recognize my hand-writing.	You are not using Graffiti character strokes.	For your SPT 1800 to recognize hand-writing input with the stylus, you need to use the Graffiti® character strokes. See the <i>SPT 1800 Product Reference Guide</i> for information about how to write Graffiti character strokes.
	You are not writing character strokes in the correct area.	Make the Graffiti character strokes in the Graffiti writing area — not on the display part of the screen.
		Make sure you are writing the strokes for letters in the left-hand side, and the strokes for numbers in the right-hand side of the Graffiti writing area.
	Graffiti is shifted into extended or punctuation modes.	See the <i>SPT 1800 Product Reference Guide</i> for information about shifting into and out of punctuation modes.
Tapping the screen buttons or icons does not activate the corresponding feature.	Screen is out of calibration.	Recalibrate the digitizer. Choose Digitizer from the Preferences application pick list and follow the directions on the screen.
When I tap the Menu icon, nothing happens.	Application does not have menu item.	Not all applications or screens have menus. Try changing to a different application.
Beamed data does not transmit.	Terminals are too far apart or obstructed. File is locked.	Confirm that the SPT 1800 terminals are 5" apart, the receiver has its IrDA capability enabled, and that the path between the two devices is clear of obstacles. Note: You cannot overwrite a .prc file via IrDA if it is locked.
When receiving beamed data an out of memory message appears.	Memory full.	Your SPT 1800 terminal requires at least twice the amount of memory available as the data you are receiving. For example, if you are receiving a 30K application, you must have at least 60K free.

Q u i c k R e f e r e n c e

Problem	Cause	Solution
SPT 1800 does not accept scan input.	Scan application not present.	Verify that the SPT 1800 is loaded with a scanning application. See your System Administrator.
	Bad bar code.	Check to be sure the bar code symbol is not defaced.
	Too far away from bar code.	Be sure you are within proper scanning range.
	Bar code type is not enabled.	Be sure the SPT 1800 is programmed to accept the type of bar code you are scanning.
	Beep is not enabled.	If you are expecting a beep on a good decode and don't hear one, check that the application is set to generate a beep on good decode.
	Battery is low.	If the scanner stops emitting a laser beam when you press the trigger, check your battery level. When the battery is low, the scanner shuts off before the terminal notifies you of the low battery condition. Note: If, after performing these checks, the scanner is still not reading symbols, contact your distributor or Symbol Technologies.

Ergonomic Recommendations

Caution: In order to avoid or minimize the potential risk of ergonomic injury follow the recommendations below. Consult with your local Health & Safety Manager to ensure that you are adhering to your company's safety programs to prevent employee injury.

- Reduce or eliminate repetitive motion
- Maintain a natural position
- Reduce or eliminate excessive force
- Keep objects that are used frequently within easy reach
- Perform tasks at correct heights
- Reduce or eliminate vibration
- Reduce or eliminate direct pressure
- Provide adjustable workstations
- Provide adequate clearance
- Provide a suitable working environment
- Improve work procedures.



Regulatory Information

Radio Frequency Interference Requirements

This device has been tested and found to comply with the limits for a Class B digital device pursuant to Part 15 of the Federal Communications Commissions Rules and Regulations. These limits are designed to provide reasonable protection against harmful interference when the equipment is operated in a commercial environment. This equipment generates, uses, and can radiate radio frequency energy and, if not installed and used in accordance with the instruction manual, may cause harmful interference to radio communications. Operation of this equipment in a residential area is likely to cause harmful interference in which case the user will be required to correct the interference at his own expense.

However, there is no guarantee that interference will not occur in a particular installation. If the equipment does cause harmful interference to radio or television reception, which can be determined by turning the equipment off and on, the user is encouraged to try to correct the interference by one or more of the following measures:

- Re-orient or relocate the receiving antenna.
- Increase the separation between the equipment and receiver.
- Connect the equipment into an outlet on a circuit different from that on which the receiver is connected.
- Consult the dealer or an experienced radio/TV technician for help.

This device complies with FCC Part 15. Operation is subject to the following two conditions: (1) this device may not cause harmful interference and (2) this device must accept any interference received, including interference that may cause undesired operation.



Important Note: To comply with FCC and Industry Canada RF exposure requirements, this hand-held device is approved for operation in a user's hand when there is 20 cm or more between the antenna and the user's body.

Radio Frequency Interference Requirements - Canada

This device complies with RSS 210 of Industry & Science Canada. Operation is subject to the following two conditions: (1) this device may not cause harmful interference and (2) this device must accept any interference received, including interference that may cause undesired operation.

This Class B digital apparatus complies with Canadian ICES-003.

Cet appareil numérique de la classe B est conforme à la norme NMB-003 du Canada.

CE Marking and European Union Compliance



Products intended for sale within the European Union are marked with the CE Mark which indicates compliance to applicable Directives and European Normes (EN), as follows. Amendments to these Directives or ENs are included:

Applicable Directives

- Electromagnetic Compatibility Directive 89/336/EEC
- Low Voltage Directive 73/23/EEC

Applicable Standards

- EN 55022:1998, Limits and Methods of Measurement of Radio Disturbance Characteristics of Information Technology Equipment
- EN 55024:1998; Information Technology equipment - Immunity characteristics - Limits and methods of measurement
- IEC 1000-4-2:1995; Electromagnetic compatibility (EMC); Part 4:Testing and measurement techniques; Section 4.2:Electrostatic discharge immunity test
- IEC 1000-4-3:1997; Electromagnetic Compatibility (EMC); Part 4:Testing and measurement techniques; Section 3. Radiated, radio frequency, electromagnetic field immunity test.
- IEC 1000-4-4:1995; Electromagnetic compatibility (EMC); Part 4:Testing and measurement techniques; Section 4:Testing electrical fast transient,/Burst immunity.
- IEC1000-4-5:1995; Electromagnetic compatibility (EMC), Part 4: Testing and measurement techniques; Section 5: Surge Immunity
- IEC 1000-4-6:1996; Electromagnetic compatibility (EMC), Part 4:Testing and measurement techniques; Section 6: Immunity to conducted disturbances, induced by radio frequency fields.
- IEC 1000-4-11:1994; Electromagnetic compatibility (EMC), Part 4:Testing and measurement techniques; Section 11: Voltage Dips, Short Interruptions, and Voltage Variations.
- EN 60 950 + A1+A2+A3+A4+A11 - Safety of Information Technology Equipment Including Electrical Business Equipment
- EN 60 825-1 (EN 60 825) - Safety of Devices Containing Lasers

RF Devices

Symbol's RF products are designed to be compliant with the rules and regulations in the locations into which they are sold and will be labeled as required. The majority of Symbol's RF devices are type approved and do not require the user to obtain license or authorization before using the equipment. Any changes or modifications to Symbol Technologies equipment not expressly approved by Symbol Technologies could void the user's authority to operate the equipment.

The Spectrum24 equipment is intended for use throughout the European Economic Area, but its authorization for use in France is restricted as follows:



- PAN European Frequency Range: 2.400 - 2.4835 GHz, identified by -EU suffix to the model number found on the product label.
- **France** - Restrict Frequency Range for use in France: 2.4465 - 2.4835 GHz, identified on SPT 1842 by the -FR suffix to the model number found on the product label.
- **Belgium** - Operation in an out-of-doors environment in Belgium must be restricted to 2.460 - 2.4835 GHz band.
- **Italy** - Operation in Italy requires a user license.

WARNING: FCC RF EXPOSURE GUIDELINES

To satisfy FCC RF exposure compliance requirements for a portable transmitting device, this device should be used in hand-held, hand-operated configurations only. The device and its antenna should generally maintain a separation distance of 20cm or more from a person's body; except for the hands and wrists because of higher exposure limit for extremities. This device is designed to be used in a person's hands and its operating configurations generally do not support normal transmissions while it is carried in pockets or holsters next to a person's body.

GSM Regulatory Warnings

Emergency Calls

Please contact your service provider for information about the availability of Emergency Calls.

The GSM version supports Emergency Calls with or without a SIM card fitted. However, as for any other voice call, you must be registered on a GSM network. If you are outside the coverage of a GSM network, or another factor such as insufficient power occurs, then Emergency Call will not work.

The procedure for generating an Emergency Call will depend on the application/service currently in use and the network you are connected to. It is recommended that you familiarize yourself with the appropriate procedures required to generate an Emergency Call.

When connected to the Emergency Operator you should have details of your telephone number and location on hand.

Safety Information

The GSM version emits radio frequency signals in the 900 MHz, 1800 MHz and 1900 MHz frequency bands. The following recommendations are in line with guidelines concerning public exposure to radio frequency electromagnetic energy, issued by various European and International agencies.

Unlike a mobile phone, the transmitter antenna on the GSM version would not (under normal circumstances) be close to the head, and therefore high field strength is not usually encountered. The use of the GSM version is similar to using a mobile phone with a handsfree unit. However, take care to avoid placing any part of your body in proximity to the GSM version antenna when the GSM radio is switched on. In

Q u i c k R e f e r e n c e

particular, it is recommended that you do not grasp the antenna while the GSM version is operating as this will not only significantly degrade its performance, but also expose your hand to the maximum radio frequency power emitted by the GSM version.

Safety on the Road

The GSM version should not be used by the driver of a vehicle when in motion. Always safely park your vehicle before turning your attention to your device. Always adequately secure your device in a moving vehicle, and do not leave it loose on a passenger seat. Remember that in the event of a sudden stop an unsecured device could cause injury to any occupants as well as damage to the vehicle. If your vehicle has an airbag, do not place any objects, including your device, in the area around the airbag or where the airbag deploys. Any item propelled by an activated airbag could cause serious injury and damage.

When receiving calls on a public highway, mobile units are not permitted to use "warning" devices, which permit the vehicles' horn to sound or the light to flash.

Safety on Aircraft

You are required by law to switch off all electrical apparatus when boarding and leaving an aircraft and at any other time when instructed to do so by a member of the crew. You are not allowed to use any mobile phone, as well as the GSM version, at any time when on board an aircraft, as such use may constitute a danger. In such circumstances please ensure that your GSM version is switched off, disabling attempts to log onto networks.

Pacemakers

It is recommended by pacemaker manufacturers that a minimum of 20cm (8 inches) be maintained between a handheld wireless phone and a pacemaker to avoid any possible interference with the pacemaker. These recommendations are consistent with the independent research by and recommendations of Wireless Technology Research.

Hearing Aids

Some digital wireless phones may interfere with some hearing aids. In the event of such interference you may want to consult your hearing aid supplier to discuss solutions.

Persons with pacemakers:

- Should always keep the phone more than 20cm (8 inches) from their pacemaker when the phone is turned on.
- Should not carry the phone in a breast pocket.
- Should use the ear opposite the pacemaker to minimize the potential for interference.



If you have any reason to suspect that interference is taking place, turn off the GSM version immediately. This may be achieved most rapidly by switching off the device using its on/off button.

Other Medical Devices

The GSM version transmits radio frequency energy and as such has the potential to interfere with inadequately protected medical devices. Consult your physician or the manufacturer of the device to see if any particular device has sufficient protection.

It is good practice to completely turn off the GSM version within a hospital or other medical facility where sensitive medical equipment is in use. In some countries, this is a legal requirement applying to all mobile phones and related equipment.

Effect on Vehicles

RF signals may affect improperly installed or inadequately shielded electronic systems in motor vehicles (including safety systems). Check with the manufacturer or its representative regarding your vehicle. You should also consult the manufacturer of any equipment that has been added to your vehicle.

Posted Facilities

Switch off the GSM version in any facility where posted notices require mobile phones to be switched off.

Potentially Hazardous Atmospheres

Do not take a GSM version into any area with a potentially hazardous atmosphere. The GSM version is not rated for use in such environments and therefore such use may pose a threat of explosion.

Such areas are often, but not always, clearly marked. They may include below decks on boats; chemical transfer or storage facilities; fuel filling stations; areas where fuel odors are present such as in a tent or caravan where cooking or heating by bottled gas is taking place; fuel transfer or storage facilities; vehicles using liquid petroleum gas (lpg); areas where the air contains concentrations of grain, dust or metal powders; and any area where you would normally be advised to turn off your vehicle engine.

Blasting Areas

To avoid interference with any blasting operations, turn off your GSM version when in a blasting area and other areas where the use of radio equipment is prohibited. Obey all signs and instructions.

Laser Devices

Symbol products using lasers comply with US 21CFR1040.10, and IEC825-1:1993, EN60825-1:1994+A11:1996. The laser classification is marked on one of the labels on the product.

S P T 1 8 0 0 S e r i e s

In accordance with Clause 5, IEC 0825 and EN60825, the following information is provided to the user:



ENGLISH

CLASS 1 LASER PRODUCT
LASER LIGHT
DO NOT STARE INTO BEAM
CLASS 2 LASER PRODUCT

HEBREW

מוצר לייזר רמה 1
רמה 1
אור לייזר
רמה 2
אין להביט אל תוך הזרם
מוצר לייזר רמה 2

DANISH

KLASSE 1 LASERPRODUKT
LASERLYF
SE IKKE IND I STRÅLEN
KLASSE 2 LASERPRODUKT

ITALIAN

CLASSE 1 PRODOTTO AL LASER DI CLASSE 1
CLASSE 2 LUCE LASER
NON FISSARE IL RAGGIOPRODOTTO
AL LASER DI CLASSE 2

DUTCH

KLASSE 1 LASERPRODUKT
LASERLICHT
NIET IN STRAAL STAREN
KLASSE-2 LASERPRODUKT

NORWEGIAN

KLASSE 1 LASERPRODUKT, KLASSE 1
KLASSE 2 LASERLYS IKKE STIRR INN I LYSSTRÅLEN
LASERPRODUKT, KLASSE 2

FINNISH

LUOKKA 1 LASERTUOTE
LASERVALO
ÄLÄ TUJOTA SÄDETTÄ
LUOKKA 2 LASERTUOTE

PORTUGUESE

CLASSE 1 PRODUTO LASER DA CLASSE 1
CLASSE 2 LUZ DE LASER NÃO FIXAR O RAIOS LUMINOSO
PRODUTO LASER DA CLASSE 2

FRENCH

CLASSE 1 PRODUIT LASER DE CLASSE 1
CLASSE 2 LUMIERE LASER
NE PAS REGARDER LE RAYON FIXEMENT
PRODUIT LASER DE CLASSE 2

SPANISH

CLASSE 1 PRODUCTO LASER DE LA CLASSE 1
CLASSE 2 LUZ LASER
NO MIRE FIJAMENTE EL HAZ
PRODUCTO LASER DE LA CLASSE 2

GERMAN

KLASSE 1 LASERPRODUKT DER KLASSE 1
KLASSE 2 LASERSTRAHLEN
NICHT DIREKT IN DEN LASERSTRAHL. SCHAUEN
LASERPRODUKT DER KLASSE 2

SWEDISH

KLASS 1 LASERPRODUKT KLAS 1
KLASS 2 LASERLJUS STIRRA INTE MOT STRÅLEN
LASERPRODUKT KLAS 2

Q u i c k R e f e r e n c e

DECLARATION OF CONFORMITY

We, Symbol Technologies, Inc.

of One Symbol Plaza, Holtsville, NY 11742-1300, USA

declare under our sole responsibility that the product(s)

Spectrum24, LA302T, Type II Radio Card

Spectrum24HR, LA411T, Type II Radio Card

Spectrum24HR, LA412T, Type II Radio Card

to which this declaration relates, are in conformity with the following standards and/or other normative documents.

ETS 300 328 (November 1996)

ETS 300 826 (November 1997)

EN 60950: 1992 Incl Amdt 1-4, 11

We hereby declare that all essential radio test suites have been carried out and that the above named products are in conformity with all the essential requirements of Directive 1999/5/EC.

The conformity assessment procedure referred to in Article 10(5) and detailed in Annex IV of Directive 1999/5/EC has been followed with the involvement of the following Notified Body(ies):

BABT, Claremont House, 34 Molesey Road, Walton-on-Thames, KT12 4RQ

Identification mark: 0168

The equipment will also carry the Class
2 equipment identifier



The technical documentation relevant to the above equipment can be made available for inspection on application to:

Symbol Technologies EMEA, Symbol Place, Winnersh Triangle, Berkshire, RG 41 5TP, UK

Dornu Narnor

(name)

Director, Regulatory and Technical Sales

(title)

(signature of authorised person)

3, May 2000

(date)

DECLARATION OF CONFORMITY

We, **Ubisoftics**
of **Cambridge Technology Centre, Marlborough**
Herts. SG8 6DP
United Kingdom

Declare under our sole responsibility that the product
GDC200 GSM Dual Band PC Card (Nets@rd)

To which this declaration relates, is in conformity with the following standards and/or other normative documents.

- ETS 300 607-1; Digital Cellular Telecommunications System Mobile Station Conformance Specification; Part 1: Conformance Specification.
- ETS 300 342 -1; Electromagnetic compatibility and Radio spectrum Matters; Electromagnetic Compatibility (EMC) for European digital cellular telecommunications system (GSM 900MHz and DCS 1800 MHz).
- EN55022: 1996 Class B; Radiated Emissions on enclosure ports.
- EN 60950; Safety of Information Technology Equipment.

We hereby declare that [all essential radio test suites have been carried out and that] the above named product is in conformity to all the essential requirements of Directive 1999/5/EC.

The conformity assessment procedure referred to in Article 10 and detailed in Annex [II] or [IV] of Directive 1999/5/EC has been followed with the involvement of the following Notified Body(ies):

BABT, Clement House, 34 Molesey Road, Walton-on-Thames, KT12 4RQ, UK

Identification mark: **168**

The technical documentation relevant to the above equipment will be held at:

Ubisoftics

Cambridge Technology Centre, Marlborough,

Herts. SG8 6DP

Anil Chhabra
Director GSM Development



Signed

1st August 2008

Warranty

Symbol Technologies, Inc. ("Symbol") manufactures its hardware products in accordance with industry-standard practices. Symbol warrants that for a period of twelve (12) months from date of shipment, products will be free from defects in materials and workmanship.

This warranty is provided to the original owner only and is not transferable to any third party. It shall not apply to any product (i) which has been repaired or altered unless done or approved by Symbol, (ii) which has not been maintained in accordance with any operating or handling instructions supplied by Symbol, (iii) which has been subjected to unusual physical or electrical stress, misuse, abuse, power shortage, negligence or accident or (iv) which has been used other than in accordance with the product operating and handling instructions. Preventive maintenance is the responsibility of customer and is not covered under this warranty.

Wear items and accessories having a Symbol serial number, will carry a 90-day limited warranty. Non-serialized items will carry a 30-day limited warranty.

Warranty Coverage and Procedure

During the warranty period, Symbol will repair or replace defective products returned to Symbol's manufacturing plant in the US. For warranty service in North America, call the Symbol Support Center at 1-800-653-5350. International customers should contact the local Symbol office or support center. If warranty service is required, Symbol will issue a Return Material Authorization Number. Products must be shipped in the original or comparable packaging, shipping and insurance charges prepaid. Symbol will ship the repaired or replacement product freight and insurance prepaid in North America. Shipments from the US or other locations will be made F.O.B. Symbol's manufacturing plant.

Symbol will use new or refurbished parts at its discretion and will own all parts removed from repaired products. Customer will pay for the replacement product in case it does not return the replaced product to Symbol within 3 days of receipt of the replacement product. The process for return and customer's charges will be in accordance with Symbol's Exchange Policy in effect at the time of the exchange.

Customer accepts full responsibility for its software and data including the appropriate backup thereof.

Repair or replacement of a product during warranty will not extend the original warranty term.

Symbol's Customer Service organization offers an array of service plans, such as on-site, depot, or phone support, that can be implemented to meet customer's special operational requirements and are available at a substantial discount during warranty period.

General

Except for the warranties stated above, Symbol disclaims all warranties, express or implied, on products furnished hereunder, including without limitation implied warranties of merchantability and fitness for a particular purpose. The stated express warranties are in lieu of all obligations or liabilities on part of Symbol for damages, including without limitation, special, indirect, or consequential damages arising out of or in connection with the use or performance of the product. Seller's liability for damages to buyer or others resulting from the use of any product, shall in no way exceed the purchase price of said product, except in instances of injury to persons or property.

Some states (or jurisdictions) do not allow the exclusion or limitation of incidental or consequential damages, so the preceding exclusion or limitation may not apply to you.

Service Information

Before you use the unit, it must be configured to operate in your facility's network and run your applications.

If you have a problem running your unit or using your equipment, contact your facility's Technical or Systems Support. If there is a problem with the equipment, they will contact the Symbol Support Center:

United States	1-800-653-5350	Canada	905-629-7226
United Kingdom	0800 328 2424	Asia/Pacific	337-6588
Australia	1-800-672-906	Austria	1-505-5794
Denmark	7020-1718	Finland	9 5407 580
France	01-40-96-52-21	Germany	6074-49020
Italy	2-484441	Mexico	5-520-1835
Netherlands	315-271700	Norway	66810600
South Africa	11-4405668	Spain	9-1-320-39-09
Sweden	84452900		
Latin America Sales Support		1-800-347-0178 Inside US	
		+1-561-483-1275 Outside US	
Europe/Mid-East Distributor Operations		Contact local distributor or call	
		+44 208 945 7360	

Visit <http://www.symbol.com/manuals> for all product manuals.



**72-51336-01
Revision A — May 2001**