

P P T 2 8 C 6

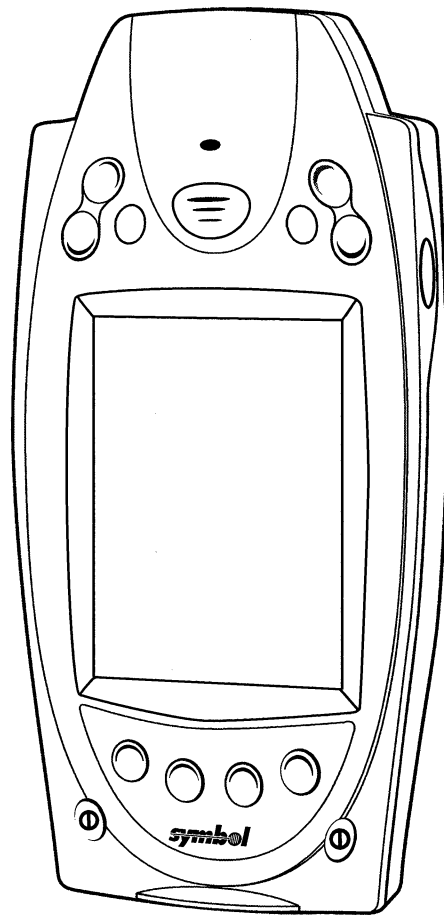

symbol[®]

© 2002 SYMBOL TECHNOLOGIES, INC. All rights reserved.

Symbol reserves the right to make changes to any product to improve reliability, function, or design.

Symbol does not assume any product liability arising out of, or in connection with, the application or use of any product, circuit, or application described herein.

No license is granted, either expressly or by implication, estoppel, or otherwise under any patent right or patent, covering or relating to any combination, system, apparatus, machine, material, method, or process in which Symbol products might be used. An implied license exists only for equipment, circuits, and subsystems contained in Symbol products.

Symbol and the Symbol logo are registered trademarks of Symbol Technologies, Inc. Other product names mentioned in this manual may be trademarks or registered trademarks of their respective companies and are hereby acknowledged.

Symbol Technologies, Inc.
One Symbol Plaza
Holtsville, N.Y. 11742-1300
<http://www.symbol.com>

Patents

This product is covered by one or more of the following U.S. and foreign Patents:

U.S. Patent No. 4,593,186; 4,603,262; 4,607,156; 4,652,750; 4,673,805; 4,736,095;
4,758,717; 4,760,248; 4,806,742; 4,816,660; 4,845,350; 4,896,026; 4,897,532; 4,923,281;
4,933,538; 4,992,717; 5,015,833; 5,017,765; 5,021,641; 5,029,183; 5,047,617; 5,103,461;
5,113,445; 5,130,520; 5,140,144; 5,142,550; 5,149,950; 5,157,687; 5,168,148; 5,168,149;
5,180,904; 5,216,232; 5,229,591; 5,230,088; 5,235,167; 5,243,655; 5,247,162; 5,250,791;
5,250,792; 5,260,553; 5,262,627; 5,262,628; 5,266,787; 5,278,398; 5,280,162; 5,280,163;
5,280,164; 5,280,498; 5,304,786; 5,304,788; 5,306,900; 5,324,924; 5,337,361; 5,367,151;
5,373,148; 5,378,882; 5,396,053; 5,396,055; 5,399,846; 5,408,081; 5,410,139; 5,410,140;
5,412,198; 5,418,812; 5,420,411; 5,436,440; 5,444,231; 5,449,891; 5,449,893; 5,468,949;
5,471,042; 5,478,998; 5,479,000; 5,479,002; 5,479,441; 5,504,322; 5,519,577; 5,528,621;
5,532,469; 5,543,610; 5,545,889; 5,552,592; 5,557,093; 5,578,810; 5,581,070; 5,589,679;
5,589,680; 5,608,202; 5,612,531; 5,619,028; 5,627,359; 5,637,852; 5,664,229; 5,668,803;
5,675,139; 5,693,929; 5,698,835; 5,705,800; 5,714,746; 5,723,851; 5,734,152; 5,734,153;
5,742,043; 5,745,794; 5,754,587; 5,762,516; 5,763,863; 5,767,500; 5,789,728; 5,789,731;
5,808,287; 5,811,785; 5,811,787; 5,815,811; 5,821,519; 5,821,520; 5,823,812; 5,828,050;
5,848,064; 5,850,078; 5,861,615; 5,874,720; 5,875,415; 5,900,617; 5,902,989; 5,907,146;
5,912,450; 5,914,478; 5,917,173; 5,920,059; 5,923,025; 5,929,420; 5,945,658; 5,945,659;
5,946,194; 5,959,285; 6,002,918; 6,021,947; 6,029,894; 6,031,830; 6,036,098; 6,047,892;
6,050,491; 6,053,413; 6,056,200; 6,065,678; 6,067,297; 6,082,621; 6,084,528; 6,088,482;
6,092,725; 6,101,483; 6,102,293; 6,104,620; 6,114,712; 6,115,678; 6,119,944; 6,123,265;
6,131,814; 6,138,180; 6,142,379; 6,172,478; 6,176,428; 6,178,426; 6,186,400; 6,188,681;
6,209,788; 6,209,789; 6,216,951; 6,220,514; 6,243,447; 6,244,513; 6,247,647; 6,308,061;
6,250,551; 6,295,031; 6,308,061; 6,308,892; 6,321,990; 6,328,213; 6,330,244; 6,336,587;
6,340,114; 6,340,115; 6,340,119; 6,348,773; 6,380,949; 6,394,355; D305,885; D341,584;
D344,501; D359,483; D362,453; D363,700; D363,918; D370,478; D383,124; D391,250;
D405,077; D406,581; D414,171; D414,172; D418,500; D419,548; D423,468; D424,035;
D430,158; D430,159; D431,562; D436,104.
Invention No. 55,358; 62,539; 69,060; 69,187, NI-068564 (Taiwan); No. 1,601,796; 1,907,875;
1,955,269 (Japan); European Patent 367,299; 414,281; 367,300; 367,298; UK 2,072,832; France
81/03938; Italy 1,138,713

rev. 06/02

Q u i c k R e f e r e n c e

Introduction

Congratulations on your purchase of Symbol Technologies' PPT 28C6 Terminal! Its unique combination of features make this product superior for use in a wide range of applications. These features include:

- Pocket size
- Personal Information Management software
- Microsoft® Windows® Pocket PC 2002 operating system
- RF communication via Cisco wireless network
- Printing support
- Scanning capability
- Monochrome LCD display.

About This Guide

This guide describes how to set up and use the terminal. Specific topics covered include:

- *Parts of the PPT 28C6* on page 2
- *Installing Batteries* on page 4
- *Charging the Battery* on page 5
- *Aligning the Screen* on page 8
- *Using the PPT 28C6* on page 9
- *Using the Stylus* on page 10
- *Today Screen* on page 11
- *Navigation Bar and Command Bar* on page 12
- *Input Methods* on page 13
- *Scanning with the PPT 28C6* on page 16
- *Initiating a Network Connection* on page 16
- *Resetting Your PPT 28C6 Terminal* on page 17
- *Maintaining the PPT 28C6* on page 19
- *Troubleshooting* on page 19.

The *PPT 2800 Series for Pocket PC 2002 Product Reference Guide* (p/n 72-54894-xx) details the applications available for the PPT 28C6. For the latest version of this guide, visit <http://www.symbol.com/manuals>

Parts of the PPT 28C6

Front View

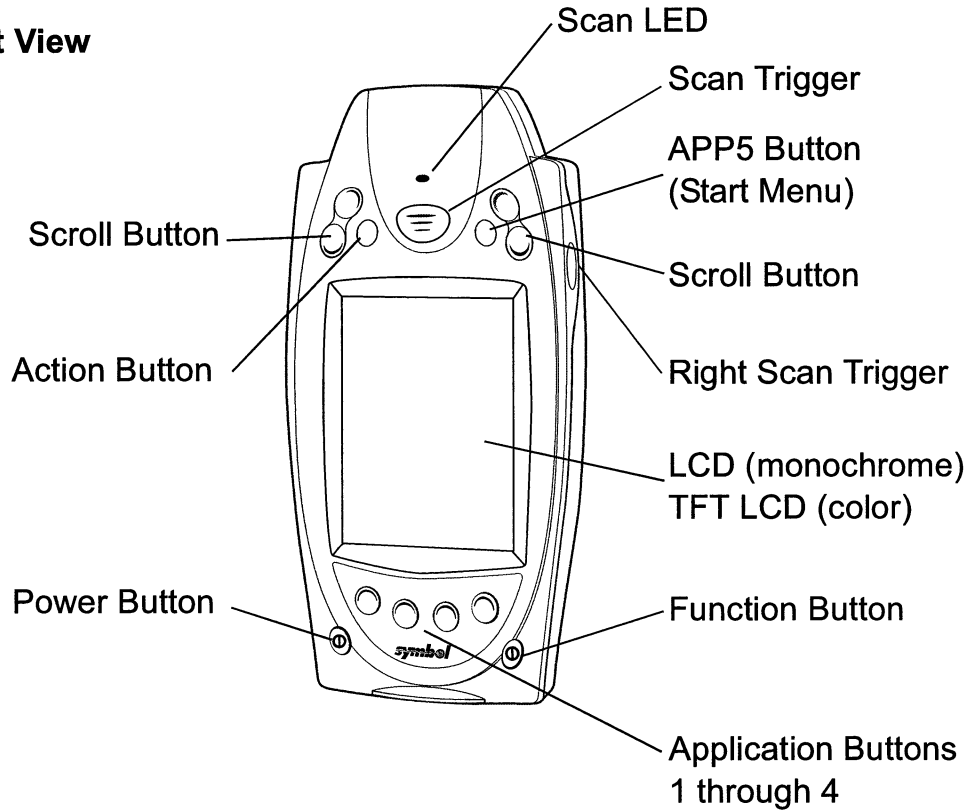

Left View

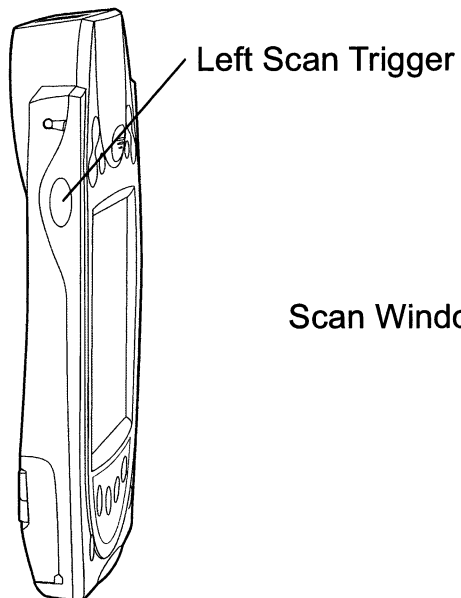

Top View

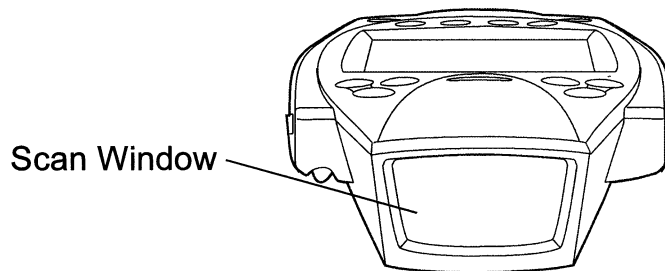

Q u i c k R e f e r e n c e

Parts of the PPT 28C6 (continued)

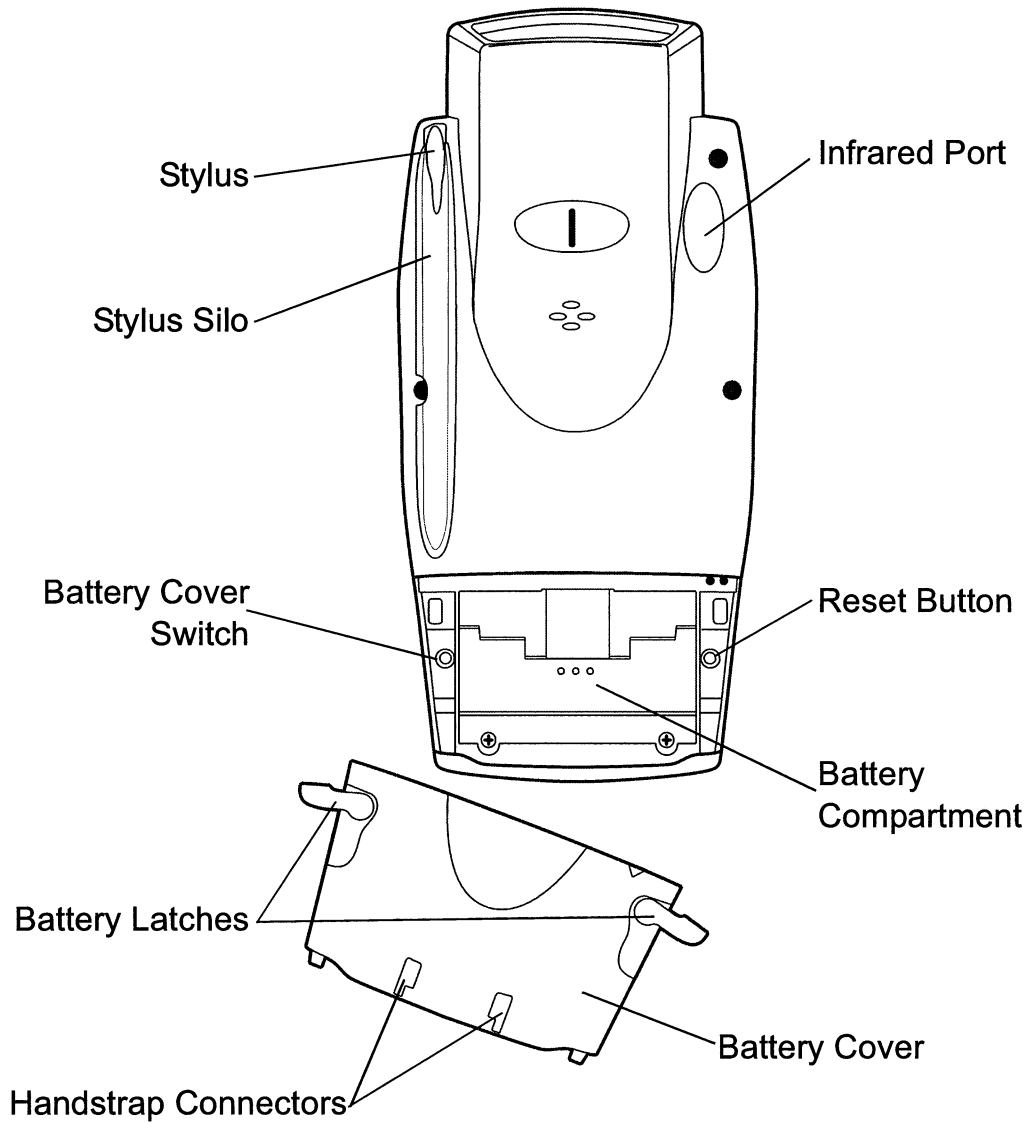

Bottom View

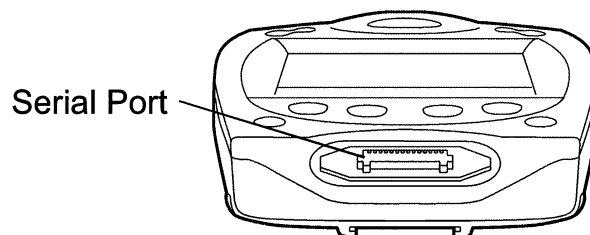

Installing Batteries

Before using your PPT 28C6, install a lithium-ion battery:

1. Open the latches on the battery door and lift the battery door away from the PPT 28C6.

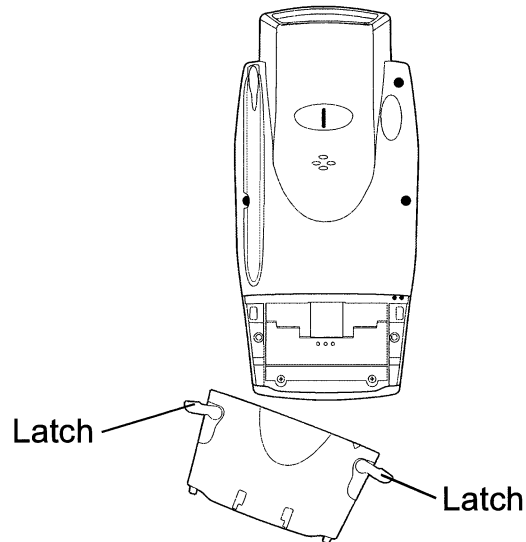

2. Insert the lithium-ion battery in the battery compartment with the battery tether positioned properly (as shown below), making sure the battery snaps into place.

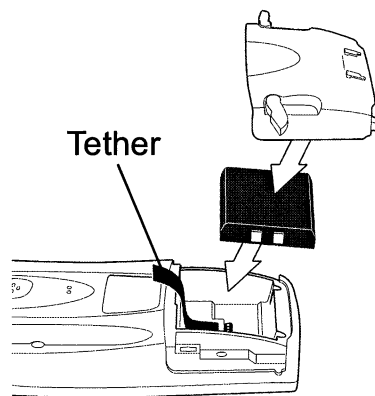

3. Replace the battery cover by inserting the bottom first, then pressing the top in firmly while securing the latches.

Charging the Battery

Before using your PPT 28C6 for the first time, charge the lithium-ion battery in the terminal for about 2 1/2 hours, using the cradle or the synchronization cable. Follow these same procedures to recharge the battery.

Your terminal is equipped with a memory backup battery which automatically charges from the fully-charged lithium-ion battery. This backup battery retains data in memory when the terminal's battery is removed, and takes about 24 hours to charge when you first use your terminal.

Note: If you remove the lithium-ion battery before the backup battery is fully charged, data may be lost. For this reason, **DO NOT** remove the battery within the first 24 hours of use.

Charging the Battery Using the Cradle

1. Plug the cradle into a wall outlet.
2. Insert the PPT 28C6 terminal in the cradle.

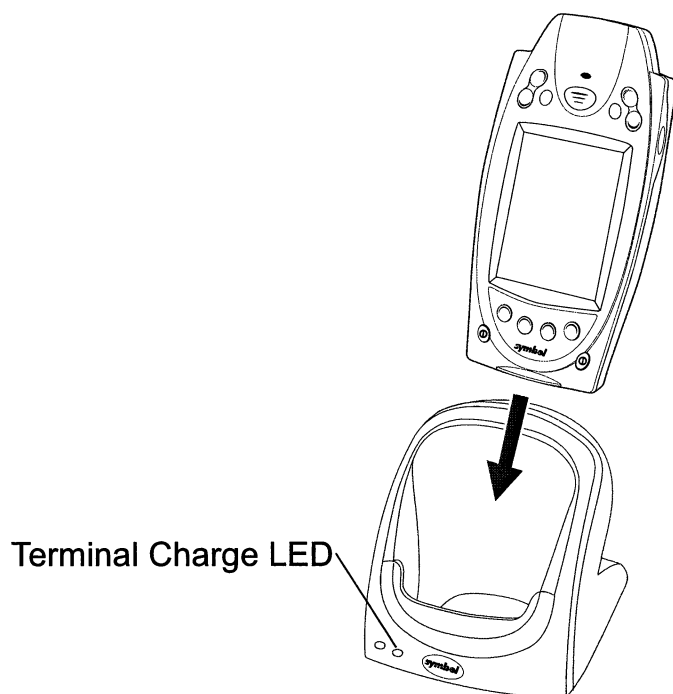

3. The Terminal Charge LED turns red (may take up to one minute) to indicate charging, then green when the battery is fully charged. The terminal's battery is fully charged after approximately 2 1/2 hours.

Charging a Spare Battery

To recharge a terminal's spare battery, insert it in the spare battery charging slot in the back of the cradle, oriented so the contacts are facing down and toward the back of the cradle. Press the battery down into the slot until firmly seated.

The Spare Battery Charge LED turns red to indicate charging, then green when the battery is fully charged. The battery is fully charged after approximately 2 1/2 hours. See the cradle's *Quick Reference Guide* for more information.

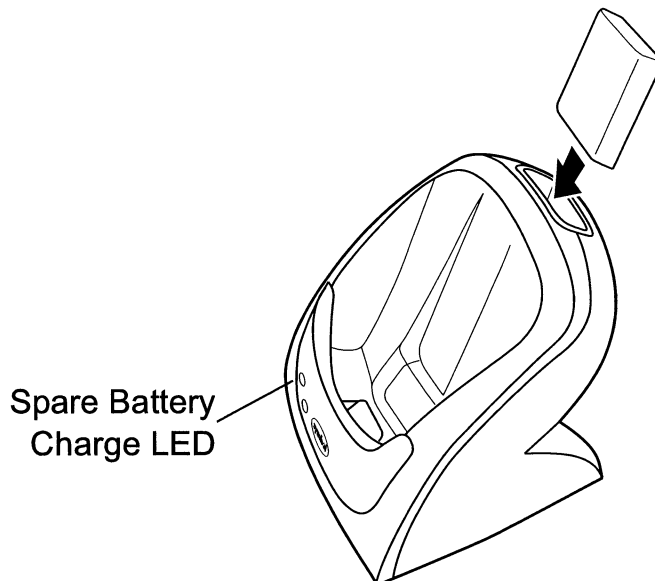

Q u i c k R e f e r e n c e

Charging the Battery Using the Synchronization Cable

1. Insert the cable into the bottom of the terminal.

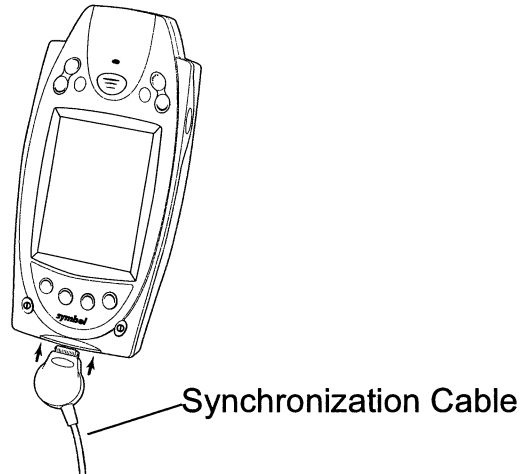

2. Plug the power cable into a wall outlet and plug the other end into the battery charging receptacle on the side of the synchronization cable.

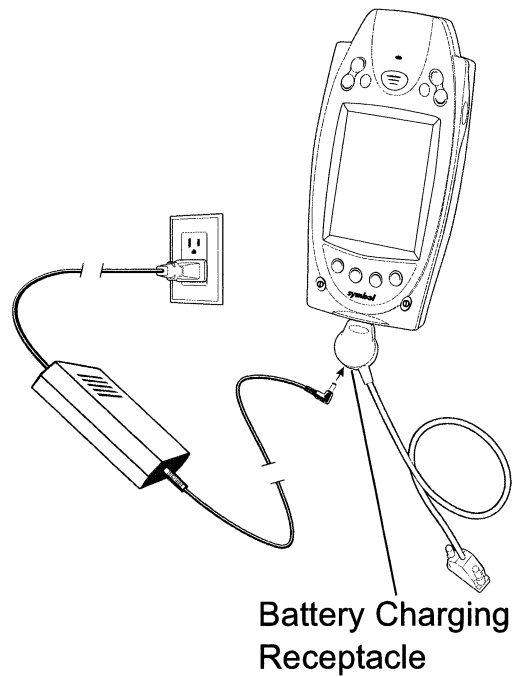

Starting the PPT 28C6

Press the red power button to start the terminal. If the terminal does not power on, perform a hard reset. See *Performing a Hard Reset* on page 18.

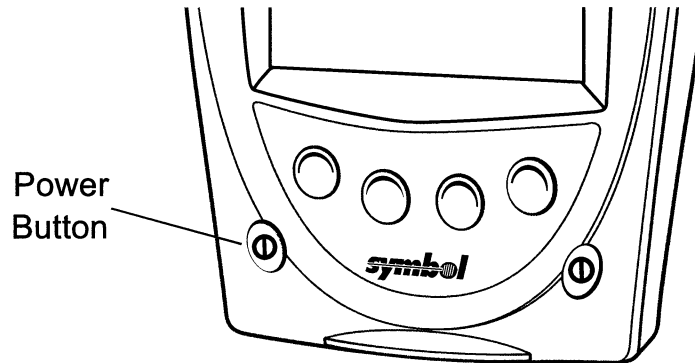

As the terminal initializes its unique Flash File system, the Symbol splash screen displays for about a minute.

When the Welcome screen appears, tap anywhere on the screen to continue to the Align screen. Note that these screens also appear every time you perform a hard reset.

Aligning the Screen

To align your PPT 28C6 so the cursor on the touch screen aligns with the tip of your stylus:

1. If necessary, adjust the contrast (monochrome LCD only) on the PPT 28C6 so the screen is readable. See *Controlling the Backlight* on page 9.
2. Remove the stylus from its storage silo on the back of the PPT 28C6.

Q u i c k R e f e r e n c e

3. Tap the center of each target that appears on the screen with the tip of the stylus.

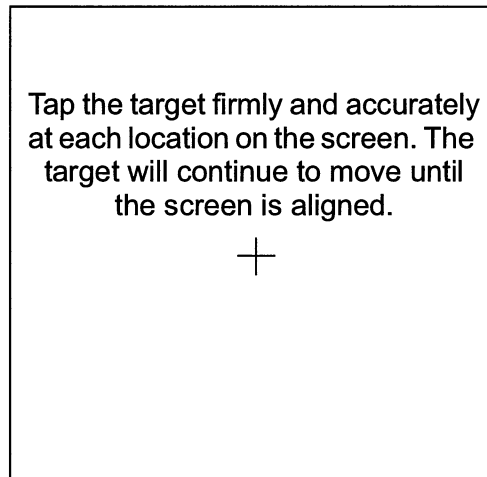

4. Follow the directions on the screen which explain how to use the stylus and pop-up menus, and allow you to set your city and time zone.

Using the PPT 28C6

Using the Power Button

Press the power button on the lower left-hand side of the terminal to turn the PPT 28C6 on and off.

Controlling the Backlight

The Function button, shown below, allows you to adjust the contrast of the screen and control the backlight.

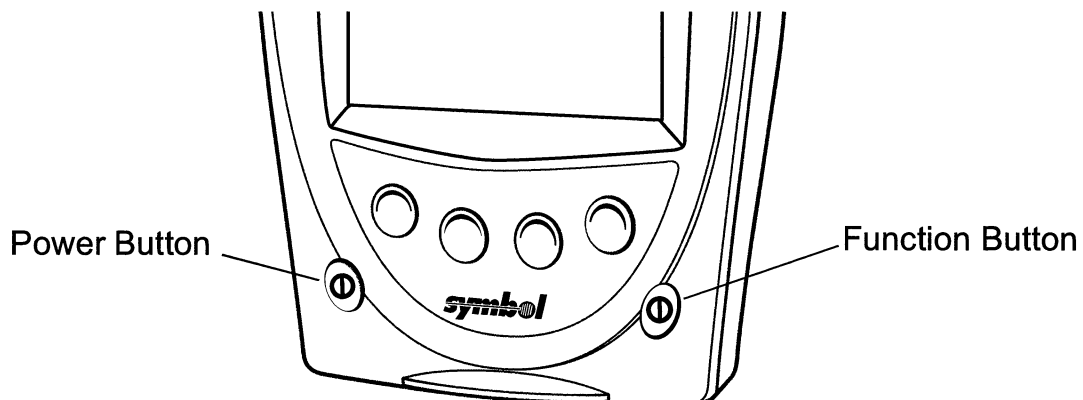

To adjust the contrast (monochrome LCD) or backlight (color TFT LCD):

1. Press and hold the Function button.
2. Press the “up” scroll button at the top of the terminal to brighten the screen, or the “down” scroll button to darken the screen.

To turn the backlight on or off:

1. Press and hold the Function button.
2. Press any application button.

Using the Stylus

The stylus selects items and enters information. The stylus functions as a mouse.

- **Tap:** Touch the screen once with the stylus to open items and select options.
- **Drag:** Hold the stylus on the screen and drag across the screen to select text and images. Drag in a list to select multiple items.
- **Tap-and-hold:** Tap and hold the stylus on an item to see a list of actions available for that item. On the pop-up menu that appears, tap the action you want to perform.

Q u i c k R e f e r e n c e

Today Screen

When you turn on your terminal for the first time each day (or after 4 hours of inactivity), the Today screen appears. You can also display it by tapping , then Today. On the Today screen, you can see important information for the day.

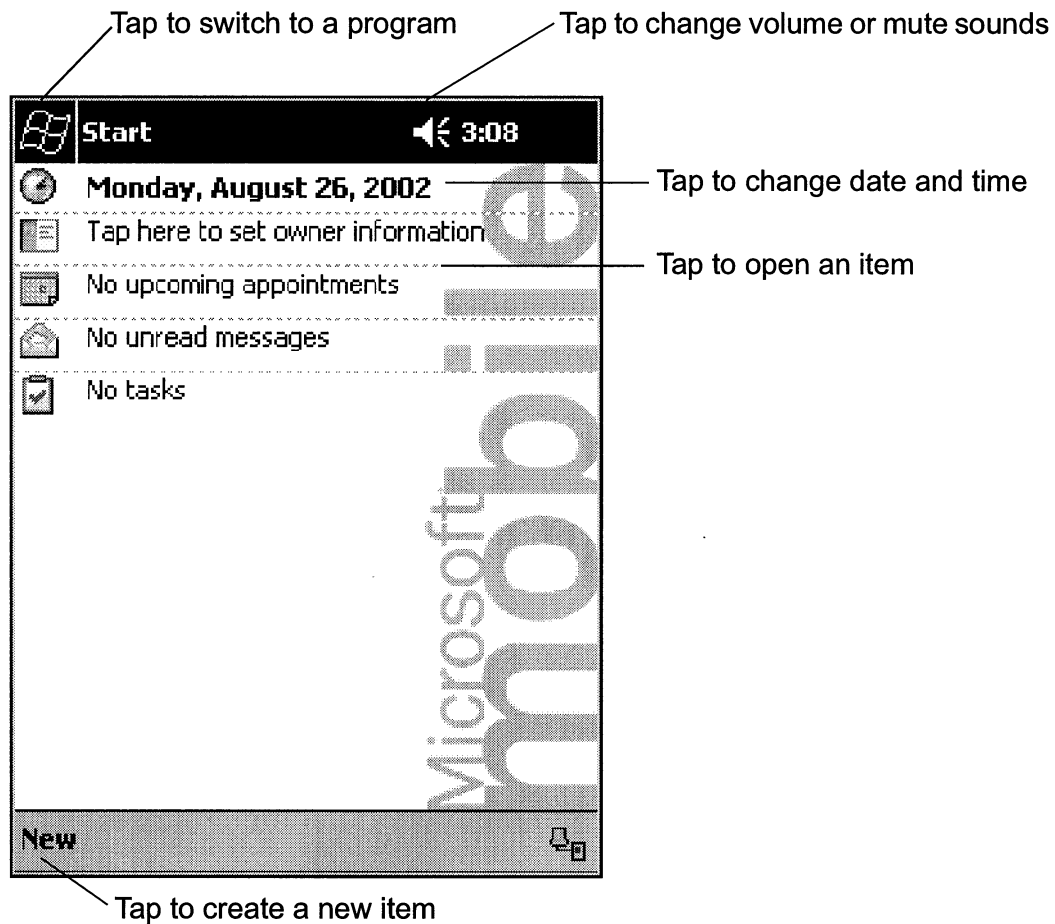

Navigation Bar and Command Bar

The navigation bar at the top of the screen displays the active program and current time, and allows you to select programs and close screens. The command bar at the bottom of the screen contains menus and buttons to perform tasks in programs.

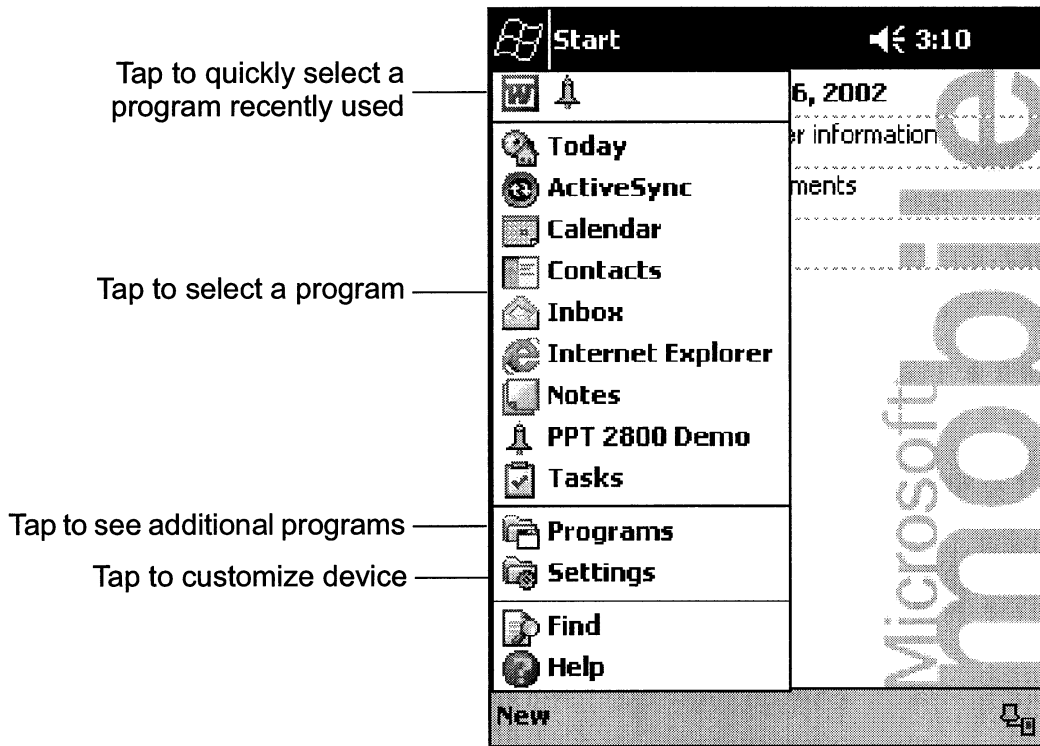

Q u i c k R e f e r e n c e

Input Methods

Use the input panel to enter information in any program. You can either type using the soft keyboard or write using Block Recognizer, or the Letter Recognizer. In any case, the characters appear as typed text on the screen.

To show or hide the input panel, tap the Input Panel button. Tap the arrow next to this button to view input methods.

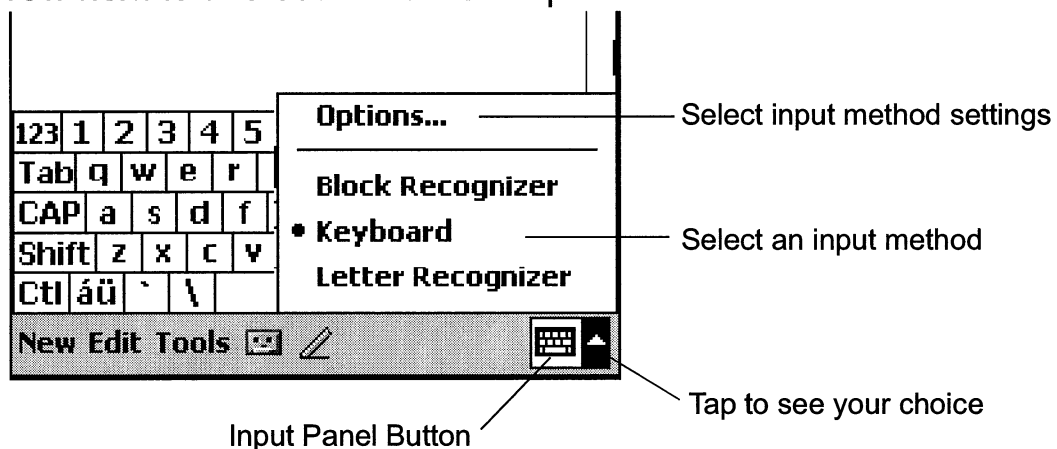

When you use the input panel, your terminal anticipates the word you are typing or writing and displays it above the input panel. When you tap the displayed word, it is inserted into your text at the insertion point. The more you use your terminal, the more words it learns to anticipate.

Using the Soft Keyboard

1. Tap the arrow next to the Input Panel button, then *Keyboard*.
2. On the soft keyboard, tap the keys with your stylus.

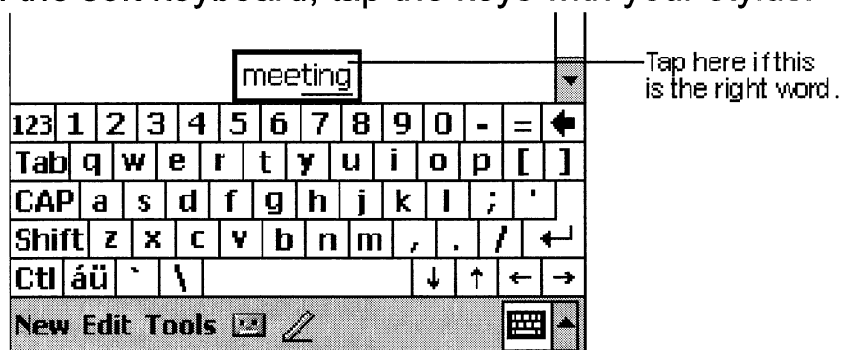

Using the Block Recognizer

1. Tap the arrow next to the Input Panel button, then *Block Recognizer*.
2. Write a letter in the left side of the box, or a number in the right side, using special character strokes.

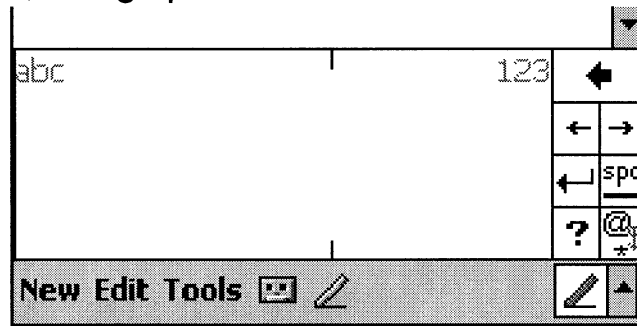

When you write a letter, it is converted to typed text on the screen. For instructions on entering Block Recognizer characters, with Block Recognizer open, tap the question mark next to the writing area, or see *Block Recognizer Characters* on page 15.

Using the Letter Recognizer

1. Tap the arrow next to the Input Panel button, then *Letter Recognizer*.
2. Write letters or numbers in the writing area, just as you would on paper. Write capital letters in the left side of the box, numbers in the right side, and lower case letters in the center.

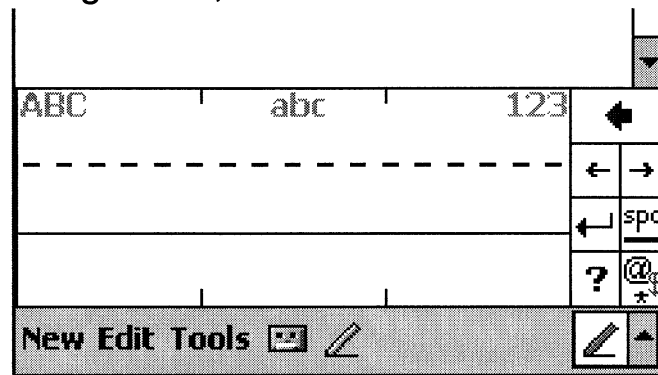

Q u i c k R e f e r e n c e

When you write a letter, it is converted to typed text on the screen. For instructions on using Letter Recognizer, with Letter Recognizer open, tap the question mark next to the writing area.

Block Recognizer Characters

The following chart is a partial display of the characters you can write while using the Block Recognizer (the dot on each character is the starting point for writing).

Letter Area				Number/Punctuation Area											
A	aa			N	n			0	0))		
B	b			O	oo			1	1			+	+		
C	c			P	p			2	2 2			*	* ∞		
D	d			Q	q			3	3			/	/		
E	e			R	r			4	4 4 4 4 L			\	\		
F	f			S	s			5	5 5 5			?	? ?		
G	g			T	t 7 7 7 7			6	6			!	!		
H	h			U	u			7	7			@	@		
I	i			V	v			8	8			&	&		
J	j			W	w			9	9			'	'		
K	k			X	x			>	>			“	“		
L	l			Y	y			.	.			-	-		
M	m			Z	z			((

space	—
back space	—

enter	— ↗
back space	— ←

Scanning with the PPT 28C6

The PPT 28C6 has an integrated scanner which collects data by scanning bar codes. See the *PPT 2800 Series for Pocket PC 2002 Product Reference Guide* for information on configuring your terminal for scanning.

To scan bar codes with the PPT 28C6:

1. Aim the scanner at the bar code.
2. Press either the right, left, or center scan trigger. Make sure the red scan beam covers the entire bar code. The green scan LED lights and a beep sounds to indicate a successful decode.

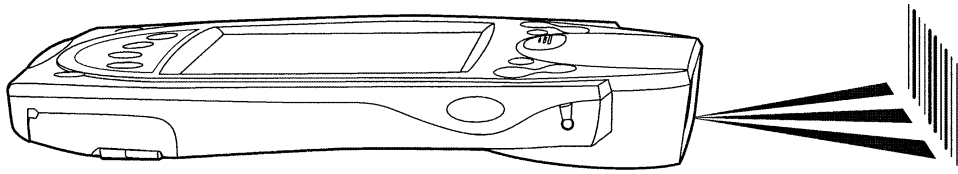

Initiating a Network Connection

Before using the terminal, set up the Cisco network connection using the applications located in the Cisco folder. To access this folder:

1. Select *Programs* from the *Start* menu.
2. Tap the Cisco folder icon.

For information on using these applications, refer to the on-line help on your terminal:

1. Select *Programs* from the *Start* menu.
2. Tap the File Explorer icon.
3. Navigate to the folder:
My Device/Applications/Cisco/
4. Tap Cisco Setup.

Additional information is available at www.cisco.com.

Resetting Your PPT 28C6 Terminal

If your PPT 28C6 terminal stops responding to input, reset it.

Performing a Soft Reset

A soft reset restarts the terminal and saves all stored records and entries.

Caution: Files that remain open during a soft reset may not be retained.

DO NOT perform a soft reset if the terminal is suspended. Press the Power button to wake the terminal.

To perform a soft reset, hold down both the up and down scroll buttons, then press the App 4 button.

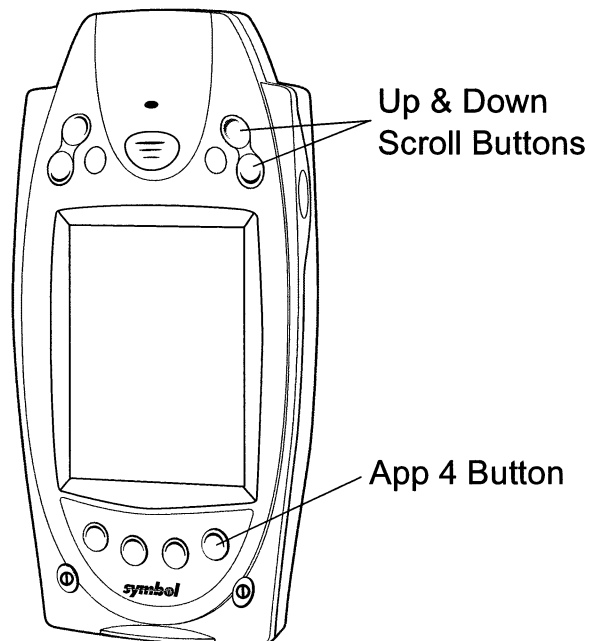

Performing a Hard Reset

A hard reset also restarts your PPT 28C6 terminal, but erases all stored records and entries. *Therefore, never perform a hard reset unless a soft reset does not solve your problem.*

Note: You can restore any data previously synchronized with your computer during the next ActiveSync operation. See the *PPT 2800 Cradle Quick Reference Guide* or the *PPT 2800 Series for Pocket PC 2002 Product Reference Guide*.

To perform a hard reset:

1. Remove the battery cover.
2. While holding down the Function button, use the stylus (or similar object *without* a sharp tip) to gently press the reset button.

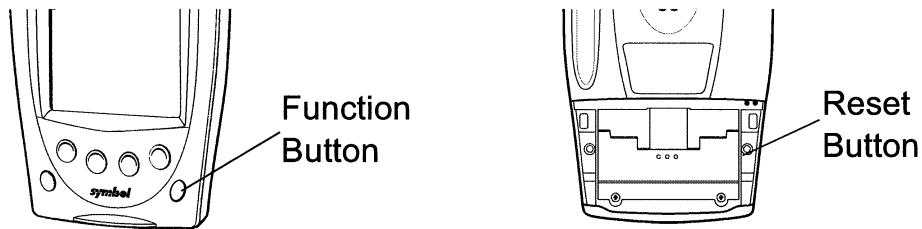

3. Replace the battery cover and press the Power button.
4. As the terminal initializes its unique Flash File system, the Symbol splash screen displays for about a minute.
5. See *Aligning the Screen* on page 8 to perform an initial setup of the terminal.

Caution: With a hard reset, Formats, Preferences, and other settings are restored to their factory default settings.

Maintaining the PPT 28C6

For trouble-free service, observe the following tips when using your PPT 28C6:

- Do not scratch the screen. Use the supplied stylus or plastic-tipped pens intended for use with a touch-sensitive screen. Never use a pen or pencil or other sharp object on the screen.
- Although your PPT 28C6 is water and dust resistant, do not expose it to rain or moisture for an extended period of time. Treat your PPT 28C6 as you would a pocket calculator or other small electronic instrument.
- The touch-sensitive screen of your PPT 28C6 contains glass. Do not drop your PPT 28C6 or subject it to strong impact.
- Protect your PPT 28C6 from temperature extremes. Do not leave it on the dashboard of a car on a hot day, and keep it away from heat sources.
- Do not store or use your PPT 28C6 in any location that is extremely dusty, damp or wet.
- If the surface of the PPT 28C6 screen becomes soiled, clean it with a soft cloth moistened with a diluted window-cleaning solution.

Troubleshooting

PPT 28C6 terminal does not turn on:

- Adjust the contrast/backlight.
- Make sure batteries are installed properly.
- Replace the batteries. If your PPT 28C6 terminal still does not operate, try a soft reset, then a hard reset; see *Resetting Your PPT 28C6 Terminal* on page 17.

No sound:

- Check the System Volume slider in the **Sounds & Notifications** properties screen (under **Start/Settings**) to make sure the volume is not turned down.

PPT 28C6 terminal turns itself off:

- Your PPT 28C6 terminal turns off after a period of inactivity. This period can be set from one to five minutes, in one-minute intervals. Check the **Power** dialog box (in the **System** tab under **Start/Settings**), and change the setting if you need a longer delay before the automatic shutoff feature activates.

PPT 28C6 terminal doesn't recognize my handwriting:

- If you're using the Block Recognizer input method, characters must be written a certain way. See the *PPT 2800 Product Reference Guide* for information about how to write character strokes.
- If you're using the Block Recognizer or Letter Recognizer input method, make the character strokes in the lower character entry area on the screen — not on the display part of the screen.
- Make sure you are writing letters and numbers in the appropriate section of the writing area.

Tapping the screen buttons or icons does not activate the corresponding feature:

- Align the screen. Choose **Screen** from the **System** tab under **Start/Settings**, or hold down the Function button and press the Action button.

A message appears stating that your PPT 28C6 terminal memory is full:

- Delete unused memos and records. You can save these records on your computer.
- Adjust the memory allocation. Select **Start**, then **Settings**, and select the **System** tab. Tap **Memory** and adjust the slider.
- If you have installed additional applications on your PPT 28C6 terminal, remove them to recover memory. Select

Q u i c k R e f e r e n c e

Start, then **Settings**, and select the **System** tab. Tap **Remove Programs**, select the unused program and tap **Remove**.

Beamed data does not transmit:

- Confirm that the PPT 28C6 terminals are 5" apart, and there is a clear path between the two devices.
- Adjust the room lighting or move to a different location.

When receiving beamed data an out of memory message appears:

- Your PPT 28C6 terminal requires at least twice the amount of memory available as the data you are receiving. For example, if you are receiving a 30K application, you must have at least 60K free.

Your PPT 28C6 unit does not accept scan input:

- Verify that the unit is loaded with a scanning application. See your System Administrator.
- Be sure the symbol is not defaced.
- Be sure you are within proper scanning range.
- Be sure the terminal is programmed to accept the type of bar code you are scanning.
- If you are expecting a beep on a good decode and don't hear one, check that the application is set to generate a beep on good decode.
- If the scanner stops emitting a laser beam when you press the trigger, check your battery level. When the battery is low, the scanner shuts off before the terminal notifies you of the low battery condition.

Note: If the scanner is still not reading symbols, contact your distributor or Symbol Technologies.

END-USER LICENSE AGREEMENT

- You have acquired a device (“DEVICE”) that includes software licensed by Symbol Technologies, Inc. (“SYMBOL”) from Microsoft Licensing Inc. or its affiliates (“MS”). Those installed software products of MS origin, as well as associated media, printed materials, and “online” or electronic documentation (“SOFTWARE”) are protected by international intellectual property laws and treaties. The SOFTWARE is licensed, not sold. All rights reserved.
- IF YOU DO NOT AGREE TO THIS END USER LICENSE AGREEMENT (“EULA”), DO NOT USE THE DEVICE OR COPY THE SOFTWARE. INSTEAD, PROMPTLY CONTACT SYMBOL FOR INSTRUCTIONS ON RETURN OF THE UNUSED DEVICE(S) FOR A REFUND. **ANY USE OF THE SOFTWARE, INCLUDING BUT NOT LIMITED TO USE ON THE DEVICE, WILL CONSTITUTE YOUR AGREEMENT TO THIS EULA (OR RATIFICATION OF ANY PREVIOUS CONSENT).**
- **GRANT OF SOFTWARE LICENSE.** This EULA grants you the following license:
- SOFTWARE includes software already installed on the DEVICE (“DEVICE Software”) and MS software contained on the CD-ROM disk (“Desktop Software”).

SYSTEM Software. You may use the DEVICE Software as installed on the DEVICE.

Desktop Software. Desktop Software is included with your DEVICE, and you may install and use the Microsoft® Active Sync® 3.5 component on one (1) or more computers to exchange information with one (1) or more computing devices that contain a compatible version of the Microsoft® Pocket PC Software 2002 operating system. For other software component(s) contained in the Desktop Software, you may install and use such components only in accordance with the terms of the printed or online end user license agreement(s) provided with such component(s). In the absence of an end user license agreement for particular component(s) of the Desktop Software, you may install and use only one (1) copy of such component(s) on the DEVICE or a single computer with which you use the DEVICE.

Back-up Copy. If Manufacturer has not included a back-up copy of the DEVICE Software with the DEVICE, you may make a single back-up copy of the DEVICE Software. You may use the back-up copy solely for archival purposes.

Microsoft® Outlook® 2002. If Microsoft Outlook 2002 is included with your Device, the following terms apply to your use of Microsoft Outlook 2002: (i) regardless of the information contained in “Software Installation and Use” section of the online EULA you may install one (1) copy of Microsoft Outlook 2002 on one (1) computer to use, exchange data, share data, access and interact with the DEVICE, and (ii) the EULA for Microsoft Outlook 2002 is between Manufacturer (as defined above) and the end user – not between the PC Manufacturer and end user.

DESCRIPTION OF OTHER RIGHTS AND LIMITATIONS.

- **Speech/Handwriting Recognition.** If the SOFTWARE includes speech and/or handwriting recognition component(s), you should understand that speech and handwriting recognition are inherently statistical processes; that recognition errors are inherent in the processes; that it is your responsibility to provide for handling such errors and to monitor the recognition processes and correct any errors. Neither Manufacturer nor its suppliers shall be liable for any damages arising out of errors in the speech and handwriting recognition processes.
- **Limitations on Reverse Engineering, Decompilation and Disassembly.** You may not reverse engineer, decompile, or disassemble the SOFTWARE, except and only to the extent that such activity is expressly permitted by applicable law notwithstanding this limitation.
- **Single DEVICE.** The DEVICE Software is licensed with the DEVICE as a single integrated product. The DEVICE Software installed in read only memory (“ROM”) of the DEVICE may only be used as part of the DEVICE.
- **Single EULA.** The package for the DEVICE may contain multiple versions of this EULA, such as multiple translations and/or multiple media versions (e.g., in the user documentation and in the software). Even if you receive multiple versions of the EULA, you are licensed to use only one (1) copy of the DEVICE Software.
- **Rental.** You may not rent or lease the SOFTWARE.
- **Software Transfer.** You may permanently transfer all of your rights under this EULA, only as

Q u i c k R e f e r e n c e

part of a sale or transfer of the DEVICE, provided you retain no copies, you transfer all of the SOFTWARE (including all component parts, the media and printed materials, any upgrades or backup copies, this EULA and, if applicable, the Certificate(s) of Authenticity), and the recipient agrees to the terms of this EULA. If the Software is an upgrade, any transfer must include all prior versions of the SOFTWARE.

- **Termination.** Without prejudice to any other rights, Manufacturer or MS may terminate this EULA if you fail to comply with the terms and conditions of this EULA. In such event, you must destroy all copies of the SOFTWARE and all of its component parts.

UPGRADES AND RECOVERY MEDIA.

- **DEVICE Software.** If the DEVICE Software is provided by Manufacturer separate from the DEVICE on media such as a ROM chip, CD ROM disk(s) or via web download or other means, and is labeled "For Upgrade Purposes Only" or "For Recovery Purposes Only", you may install one copy of such DEVICE Software onto the DEVICE as a replacement copy for the existing DEVICE Software and use it in accordance with Section 1 of this EULA.
- **Desktop Software.** If any Desktop Software component(s) is provided by Manufacturer separate from the DEVICE on CD ROM disk(s) or via web download or other means, and labeled "For Upgrade Purposes Only" or "For Recovery Purposes Only", you may (i) install and use one copy of such component(s) on the computer(s) you use to exchange data with the DEVICE as a replacement copy for the existing Desktop Software component(s).

COPYRIGHT. All title and intellectual property rights in and to the SOFTWARE (including but not limited to any images, photographs, animations, video, audio, music, text and "applets," incorporated into the SOFTWARE), the accompanying printed materials, and any copies of the SOFTWARE, are owned by MS or its suppliers (including Microsoft Corporation). You may not copy the printed materials accompanying the SOFTWARE. All title and intellectual property rights in and to the content which may be accessed through use of the SOFTWARE is the property of the respective content owner and may be protected by applicable copyright or other intellectual property laws and treaties. This EULA grants you no rights to use such content. All rights not specifically granted under this EULA are reserved by MS and its suppliers (including Microsoft Corporation).

EXPORT RESTRICTIONS. You agree that you will not export or re-export the SOFTWARE to any country, person, or entity subject to U.S. export restrictions. You specifically agree not to export or re-export the SOFTWARE: (i) to any country to which the U.S. has embargoed or restricted the export of goods or services, which as of May 1999 include, but are not necessarily limited to Cuba, Iran, Iraq, Libya, North Korea, Sudan, Syria, and the Federal Republic of Yugoslavia (including Serbia, but not Montenegro), or to any national of any such country, wherever located, who intends to transmit or transport the products back to such country; (ii) to any person or entity who you know or have reason to know will utilize the SOFTWARE or portion thereof in the design, development or production of nuclear, chemical or biological weapons; or (iii) to any person or entity who has been prohibited from participating in U.S. export transactions by any federal agency of the U.S. government.

NOTE ON JAVA SUPPORT. The SOFTWARE may contain support for programs written in Java. Java technology is not fault tolerant and is not designed, manufactured, or intended for use or resale as on-line control equipment in hazardous environments requiring fail-safe performance, such as in the operation of nuclear facilities, aircraft navigation or communication systems, air traffic control, direct life support machines, or weapons systems, in which the failure of Java technology could lead directly to death, personal injury, or severe physical or environmental damage.

PRODUCT SUPPORT. Product support for the SOFTWARE is not provided by MS, its parent corporation, Microsoft Corporation, or their affiliates or subsidiaries. For product support, please refer to the SYMBOL support number provided in the documentation for the DEVICE. Should you have any questions concerning this EULA, or if you desire to contact SYMBOL for any other reason, please refer to the address provided in the documentation for the DEVICE.

NO LIABILITY FOR CERTAIN DAMAGES. EXCEPT AS PROHIBITED BY LAW, MS SHALL HAVE NO LIABILITY FOR ANY INDIRECT, SPECIAL, CONSEQUENTIAL OR INCIDENTAL DAMAGES ARISING FROM OR IN CONNECTION WITH THE USE OR PERFORMANCE OF THE SOFTWARE. THIS LIMITATION SHALL APPLY EVEN IF ANY REMEDY FAILS OF ITS ESSENTIAL PURPOSE.

FOR APPLICABLE LIMITED WARRANTIES AND SPECIAL PROVISIONS PERTAINING TO YOUR PARTICULAR JURISDICTION, PLEASE REFER TO YOUR WARRANTY BOOKLET INCLUDED WITH THIS PACKAGE OR PROVIDED WITH THE SOFTWARE PRINTED MATERIALS.

Ergonomic Recommendations

Caution: In order to avoid or minimize the potential risk of ergonomic injury follow the recommendations below. Consult with your local Health & Safety Manager to ensure that you are adhering to your company's safety programs to prevent employee injury.

- Reduce or eliminate repetitive motion
- Maintain a natural position
- Reduce or eliminate excessive force
- Keep objects that are used frequently within easy reach
- Perform tasks at correct heights
- Reduce or eliminate vibration
- Reduce or eliminate direct pressure
- Provide adjustable workstations
- Provide adequate clearance
- Provide a suitable working environment
- Improve work procedures.

Regulatory Information

All Symbol devices are designed to be compliant with rules and regulations in locations they are sold and will be labeled as required.

Any changes or modifications to Symbol Technologies equipment, not expressly approved by Symbol Technologies, could void the user's authority to operate the equipment.



FCC RF Exposure Guidelines

This device was tested for typical body-worn operations with the holster providing a minimal spacing of 2.5 cm from the body to the back of the terminal/antenna. To maintain compliance with FCC RF exposure compliance requirements, use only belt-clips, holsters, or similar accessories that maintain a 2.5 cm separation distance between the user's body and the back of the terminal, including the antenna. The use of third-party belt-clips, holsters, and similar accessories should not contain metallic components in its assembly. The use of these accessories that do not satisfy these requirements may not comply with FCC RF exposure compliance requirements, and should be avoided.

Q u i c k R e f e r e n c e

Radio Frequency Interference Requirements

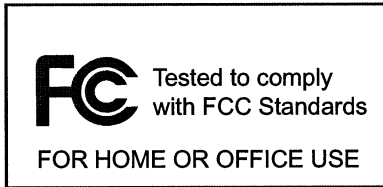

Note: This equipment has been tested and found to comply with the limits for a Class B digital device, pursuant to Part 15 of the FCC rules. These limits are designed to provide reasonable protection against harmful interference in a residential installation. This equipment generates, uses, and can radiate radio frequency energy and, if not

installed and used in accordance with the instructions, may cause harmful interference to radio communications. However there is no guarantee that interference will not occur in a particular installation. If this equipment does cause harmful interference to radio or television reception, which can be determined by turning the equipment off and on, the user is encouraged to try to correct the interference by one or more of the following measures:

- Reorient or relocate the receiving antenna
- Increase the separation between the equipment and receiver
- Connect the equipment into an outlet on a circuit different from that to which the receiver is connected
- Consult the dealer or an experienced radio/TV technician for help.

Radio Frequency Interference Requirements - Canada

This device complies with RSS 210 of Industry & Science Canada. Operation is subject to the following two conditions: (1) this device may not cause harmful interference and (2) this device must accept any interference received, including interference that may cause undesired operation.

This Class B digital apparatus complies with Canadian ICES-003.

Cet appareil numérique de la classe B est conforme à la norme NMB-003 du Canada.

Label Marking: The Term "IC:" before the radio certification only signifies that Industry Canada technical specifications were met.

Marking and European Economic Area (EEA)

RLAN's (2.4GHz) for use through the EEA have the following restrictions:

- Maximum radiated transmit power of 100 mW EIRP in the frequency range 2.400 -2.4835 GHz
- France, equipment is restricted to 2.4465 -2.4835 GHz frequency range
- Belgium outside usage, the equipment is restricted to 2.460 -2.4835 GHz frequency range
- Italy requires a user license for outside usage.

Statement of Compliance

Symbol Technologies, Inc., hereby, declares that this device is in compliance with the essential requirements and other relevant provisions of Directives 1999/5/EC, 89/336/EEC and 73/23/EEC. Declaration of Conformities may be obtained from <http://www2.symbol.com/doc/>

Other Countries

Mexico - Restrict Frequency Range to: 2.450 - 2.4835 GHz.
Israel - Restrict Frequency Range to: 2.418 - 2.457 GHz.
Sri Lanka- Restrict Frequency Range to: 2.400 - 2.430 GHz.

Power Supply

Note: Use only a Symbol-approved power supply 50-14000-107 output rated 9 Vdc and minimum 2 A. The power supply is certified to EN60950 with SELV outputs.

Hinweis: Benutzen Sie nur eine Symbol Technologies genehmigt Stromversorgung 50-14000-107 in den Ausgabe: 9 Vdc und minimum 2 A. Die Stromversorgung ist bescheinigt nach EN60950 mit SELV Ausgaben

Laser Devices

Symbol devices using lasers comply with US 21CFR1040.10, and IEC825-1:1993, EN60825-1:1994+A11:1996. The laser classification is marked on one of the labels on the device.

Class 1 Laser devices are not considered to be hazardous when used for their intended purpose. The following statement is required to comply with US and international regulations:

Caution: Use of controls, adjustments or performance of procedures other than those specified herein may result in hazardous laser light exposure.

Class 2 laser scanners use a low power, visible light diode. As with any very bright light source, such as the sun, the user should avoid staring directly into the light beam. Momentary exposure to a Class 2 laser is not known to be harmful.

Q u i c k R e f e r e n c e

Scanner Labeling

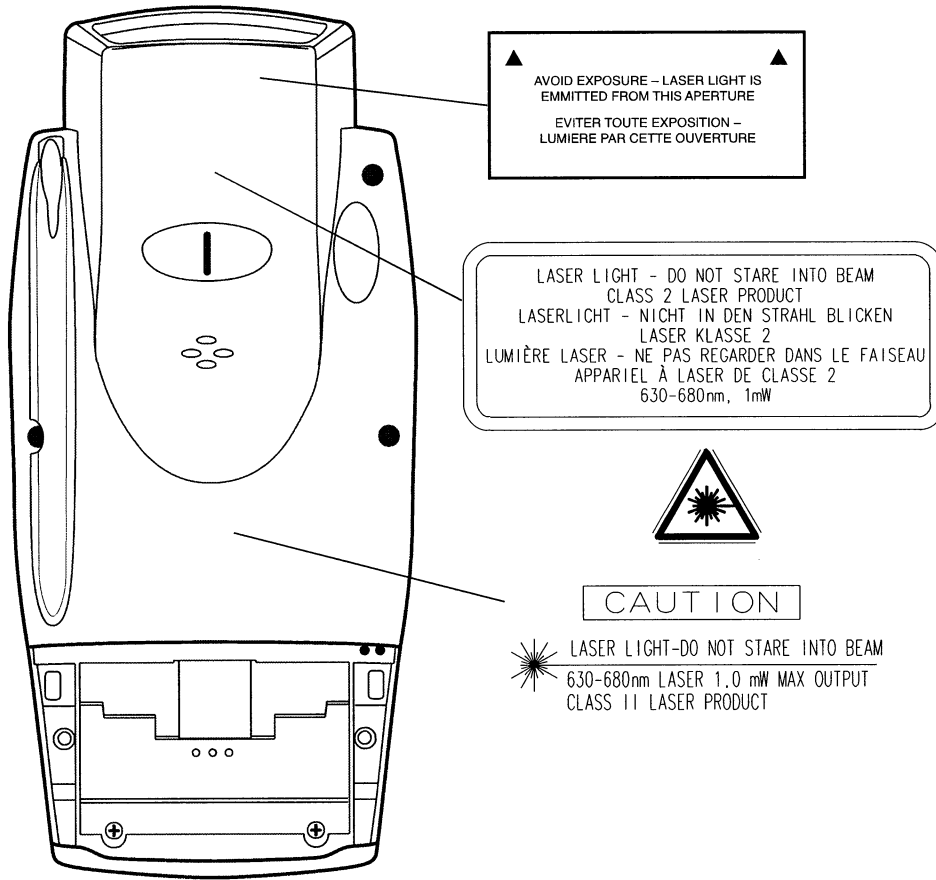

P P T 2 8 C 6

In accordance with Clause 5, IEC 825 and EN60825, the following information is provided to the user:

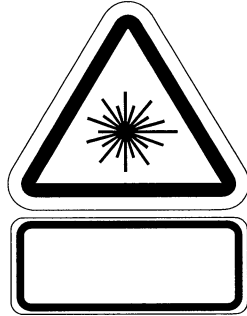

ENGLISH

CLASS 1 CLASS 2
CLASS 1 LASER PRODUCT
LASER LIGHT
DO NOT STARE INTO BEAM
CLASS 2 LASER PRODUCT

DANISH

KLASSE 1
KLASSE 2
KLASSE 1 LASERPRODUKT
LASERLYF
SE IKKE IND I STRÅLEN
KLASSE 2 LASERPRODUKT
AL LASER DI CLASSE 2

DUTCH

KLASSE 1
KLASSE 2
KLASSE-1 LASERPRODUKT
LASERLICHT
NIET IN STRAAL STAREN
KLASSE-2 LASERPRODUKT

FINNISH

LUOKKA 1
LUOKKA 2
LUOKKA 1 LASERTUOTE
LASERVALO
ÄLÄ TUIJOTA SÄDETTÄ
LUOKKA 2 LASERTUOTE

FRENCH

CLASSE 1
CLASSE 2
PRODUIT LASER DE CLASSE 1
LUMIERE LASER
NE PAS REGARDER LE RAYON FIXEMENT
PRODUIT LASER DE CLASSE 2

GERMAN

KLASSE 1
KLASSE 2
LASERPRODUKT DER KLASSE 1
LASERSTRAHLEN
NICHT DIREKT IN DEN LASERSTRAHL SCHAUEN
LASERPRODUKT DER KLASSE 2

HEBREW

מוצר לייזר רמה 1 רמה 1
אור לייזר רמה 2
אין להביט אל תוך הזרם
מוצר לייזר רמה 2

ITALIAN

CLASSE 1
CLASSE 2
PRODOTTO AL LASER DI CLASSE 1
LUCE LASER
NON FISSARE IL RAGGIOPRODOTTO

NORWEGIAN

KLASSE 1
KLASSE 2
LASERPRODUKT, KLASSE 1
LASERLYS IKKE STIRR INN I LYSSTRÅLEN
LASERPRODUKT, KLASSE 2

PORTUGUESE

CLASSE 1
CLASSE 2
PRODUTO LASER DA CLASSE 1
LUZ DE LASER NÃO FIXAR O RAIOS LUMINOSOS
PRODUTO LASER DA CLASSE 2

SPANISH

CLASE 1
CLASE 2
PRODUCTO LASER DE LA CLASE 1
LUZ LASER
NO MIRE FIJAMENTE EL HAZ
PRODUCTO LASER DE LA CLASE 2

SWEDISH

KLASS 1
KLASS 2
LASERPRODUKT KLASS 1
LASERLJUS STIRRA INTE MOT STRÅLEN
LASERPRODUKT KLASS 2

Q u i c k R e f e r e n c e

Warranty

(A) Seller's hardware Products are warranted against defects in workmanship and materials for a period of twelve (12) months from the date of shipment, provided the Product remains unmodified and is operated under normal and proper conditions. Warranty provisions and durations on software, integrated installed systems, Product modified or designed to meet specific customer specifications ("Custom Products"), remanufactured products, and reconditioned or upgraded products, shall be as provided in the applicable Product specification in effect at the time of purchase or in the accompanying software license. (B) Products may be serviced or manufactured with parts, components, or subassemblies that originate from returned products and that have been tested as meeting applicable specifications for equivalent new material and Products. The sole obligation of Seller for defective hardware Products is limited to repair or replacement (at Seller's option) on a "return to service depot" basis with prior Seller authorization. Shipment to and from Seller will be at Seller's expense, unless no defect is found. No charge will be made to Buyer for replacement parts for warranty repairs. Seller is not responsible for any damage to or loss of any software programs, data or removable data storage media, or the restoration or reinstallation of any software programs or data other than the software, if any, installed by Seller during manufacture of the Product. The aforementioned provisions do not extend the original warranty period of any Product that had either been repaired or replaced by Seller. (C) The above warranty provisions shall not apply to any Product (i) which has been repaired, tampered with, altered or modified, except by Seller's authorized service personnel; (ii) in which the defects or damage to the Product result from normal wear and tear, misuse, negligence, improper storage, water or other liquids, battery leakage or failure to perform operator handling and scheduled maintenance instructions supplied by Seller; (iii) which has been subjected to unusual physical or electrical stress, abuse, or accident, or forces or exposure beyond normal use within the specified operational and environmental parameters set forth in the applicable Product specification; nor shall the above warranty provisions apply to any expendable or consumable items, such as batteries, supplied with the Product. EXCEPT FOR THE WARRANTY OF TITLE AND THE EXPRESS WARRANTIES STATED ABOVE, SELLER DISCLAIMS ALL WARRANTIES ON PRODUCTS FURNISHED HERUNDER INCLUDING ALL IMPLIED WARRANTIES OF MERCHANTABILITY AND FITNESS FOR A PARTICULAR USE. ANY IMPLIED WARRANTIES THAT MAY BE IMPOSED BY LAW ARE LIMITED IN DURATION TO THE LIMITED WARRANTY PERIOD. SOME STATES OR COUNTRIES DO NOT ALLOW A LIMITATION ON HOW LONG AN IMPLIED WARRANTY LASTS OR THE EXCLUSION OR LIMITATION OF INCIDENTAL OR CONSEQUENTIAL DAMAGES FOR CONSUMER PRODUCTS. IN SUCH STATES OR COUNTRIES, FOR SUCH PRODUCTS, SOME EXCLUSIONS OR LIMITATIONS OF THIS LIMITED WARRANTY MAY NOT APPLY. The stated express warranties are in lieu of all obligations or liabilities on the part of Seller for damages, including but not limited to, special, indirect or consequential damages arising out of or in connection with the use or performance of the Product or service. Seller's liability for damages to Buyer or others resulting from the use of any Product or service furnished hereunder shall in no way exceed the purchase price of said Product or the fair market value of said service, except in instances of injury to persons or property.

Service Information

Before you use the unit, it must be configured to operate in your facility's network and run your applications.

If you have a problem running your unit or using your equipment, contact your facility's Technical or Systems Support. If there is a problem with the equipment, they will contact the Symbol Support Center:

United States ¹	1-800-653-5350 1-631-738-2400	Canada	905-629-7226
United Kingdom	0800 328 2424	Asia/Pacific	+65-6796-9600
Australia	1-800-672-906	Austria/Österreich	1-505-5794-0
Denmark/Danmark	7020-1718	Finland/Suomi	9 5407 580
France	01-40-96-52-21	Germany/Deutschland	6074-49020
Italy/Italia	2-484441	Mexico/México	5-520-1835
Netherlands/Nederland	315-271700	Norway/Norge	+47 2232 4375
South Africa	11-8095311	Spain/España	91 324 40 00 Inside Spain
Sweden/Sverige	84452900		+34 91 324 40 00 Outside Spain
Latin America Sales Support	1-800-347-0178 Inside US +1-561-483-1275 Outside US		
Europe/Mid-East Distributor Operations	Contact local distributor or call +44 118 945 7360		

¹Customer support is available 24 hours a day, 7 days a week.

For the latest version of this guide go to:
<http://www.symbol.com/manuals>.

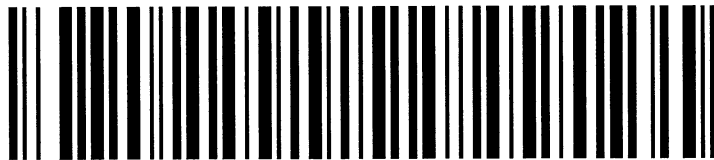

72-58805-01
Revision A — August 2002