



# PCTEST Engineering Laboratory, Inc.

6660-B Dobbin Road • Columbia, MD 21045 • U.S.A.

TEL (410) 290-6652 • FAX (410) 290-6654

<http://www.pctestlab.com>



## CERTIFICATE OF COMPLIANCE FCC Part 24 Certification

Symbol Technologies Inc.  
1 Symbol Plaza  
Holtsville, NY 11742-1300  
Attention: Sandy Mazzola, Regulatory Engineer  
CC: Dean La Rosa, Senior Design Engineer

Dates of Tests: May 20-21, 2002  
Test Report S/N: 24.220416159.H9P  
Test Site: PCTEST Lab, Columbia MD

FCC ID

**H9PPPT2837**

APPLICANT

**SYMBOL TECHNOLOGIES Inc.**

Classification: Licensed Portable Transmitter Worn on Body (PCT)  
FCC Rule Part(s): §24(E), §2  
EUT Type: PCS GSM Handheld Terminal  
Model: PPT-2837  
Tx Frequency Range: 1850.2MHz – 1909.8MHz (PCS CDMA)  
Rx Frequency Range: 1931.25MHz – 1988.75MHz (PCS CDMA)  
Max. RF Output Power: 1.00 W EIRP PCS CDMA (30.001 dBm)  
Max. SAR Measurement: 0.165mW/g PCS GSM Body SAR  
Emission Designator(s): 250KGXW



This equipment has been shown to be capable of compliance with the applicable technical standards as indicated in the measurement report and was tested in accordance with the measurement procedures specified in §2.947.

I attest to the accuracy of data. All measurements reported herein were performed by me or were made under my supervision and are correct to the best of my knowledge and belief. I assume full responsibility for the completeness of these measurements and vouch for the qualifications of all persons taking them.

*PCTEST certifies that no party to this application has been denied the FCC benefits pursuant to Section 5301 of the Anti-Drug Abuse Act of 1988, 21 U.S.C. 862.*

  
Randy Ortanez  
President



PCTEST™ PT. 24 REPORT	 <b>FCC CERTIFICATION</b>			Reviewed By: Quality Manager
Test Report S/N: 24.220416199.H9P	Test Dates: April 29-30, 2002	EUT Type: PCS GSM Handheld Terminal	FCC ID: H9PPPT2837	Page 1 of 20

## TABLE OF CONTENTS

---

ATTACHMENT A: COVER LETTER(S)	
ATTACHMENT B: ATTESTATION STATEMENT(S)	
ATTACHMENT C: TEST REPORT	
1.1 SCOPE	3
2.1 INTRODUCTION	4
3.1 INSERTS	5
4.1 DESCRIPTION OF TESTS	6-10
5.1 EQUIVALENT ISOTROPIC RADIATED POWER	11
6.1 RADIATED MEASUREMENTS	12-14
7.1 FREQUENCY STABILITY	15-16
8.1 PLOTS OF EMISSIONS	17
9.1 LIST OF TEST EQUIPMENT	18
10.1 SAMPLE CALCULATIONS	19
11.1 CONCLUSION	20
ATTACHMENT D: TEST PLOTS	
ATTACHMENT E: FCC ID LABEL / LOCATION	
ATTACHMENT F: TEST SETUP PHOTOGRAPHS	
ATTACHMENT G: EXTERNAL PHOTOGRAPHS	
ATTACHMENT H: INTERNAL PHOTOGRAPHS	
ATTACHMENT I: BLOCK DIAGRAM(S)	
ATTACHMENT J: SCHEMATIC DIAGRAM(S)	
ATTACHMENT K: OPERATIONAL / CIRCUIT DESCRIPTION	
ATTACHMENT L: PARTS LIST/TUNE UP PROCEDURE	
ATTACHMENT M: USER'S MANUAL	
ATTACHMENT N: SAR MEASUREMENT DATA	
ATTACHMENT O: SAR TEST DATA	
ATTACHMENT P: SAR TEST SETUP PHOTOGRAPHS	

PCTEST™ PT. 24 REPORT	 <b>FCC CERTIFICATION</b>	<b>symbol</b>	Reviewed By: Quality Manager
Test Report S/N: 24.220416199.H9P	Test Dates: April 29-30, 2002	EUT Type: PCS GSM Handheld Terminal	FCC ID: H9PPPT2837

# MEASUREMENT REPORT

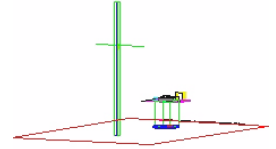
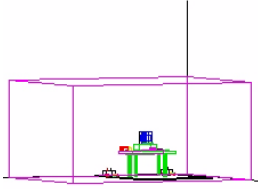



## 1.1 Scope

Measurement and determination of electromagnetic emissions (EME) of radio frequency devices including intentional and/or unintentional radiators for compliance with the technical rules and regulations of the Federal Communications Commission.

## §2.1033 General Information

<b>Applicant Name:</b>	<b>SYMBOL TECHNOLOGIES Inc.</b>
<b>Address:</b>	<b>1 Symbol Plaza Holtsville, NY 11742-1300</b>
<b>Attention:</b>	<b>Sandy Mazzola, Regulatory Engineer</b>
<b>CC:</b>	<b>Dean La Rosa, Senior Design Engineer</b>

- FCC ID: **H9PPPT2837**
- Quantity: Quantity production is planned
- Emission Designators: 250KGXW
- Tx Freq. Range: 1850.2 – 1909.8 MHz (PCS CDMA)
- Rx Freq. Range: 1931.25 – 1988.75 MHz (PCS CDMA)
- Max. Power Rating: 1.00 W EIRP PCS CDMA (30.001 dBm)
- FCC Classification(s): Licensed Portable Transmitter Worn on Body (PCT)
- Equipment (EUT) Type: PCS GSM Handheld Terminal
- Modulation(s): PCS
- Frequency Tolerance:  $\pm 0.00025\%$  (2.5 ppm)
- FCC Rule Part(s): § 24(E)
- Dates of Tests: May 20-21, 2002
- Place of Tests: PCTEST Lab, Columbia, MD U.S.A.
- Test Report S/N: 24.220416159.H9P

PCTEST™ PT. 24 REPORT	 <b>FCC CERTIFICATION</b>			Reviewed By: Quality Manager
Test Report S/N: 24.220416199.H9P	Test Dates: April 29-30, 2002	EUT Type: PCS GSM Handheld Terminal	FCC ID: H9PPPT2837	Page 3 of 20

## 2.1 INTRODUCTION

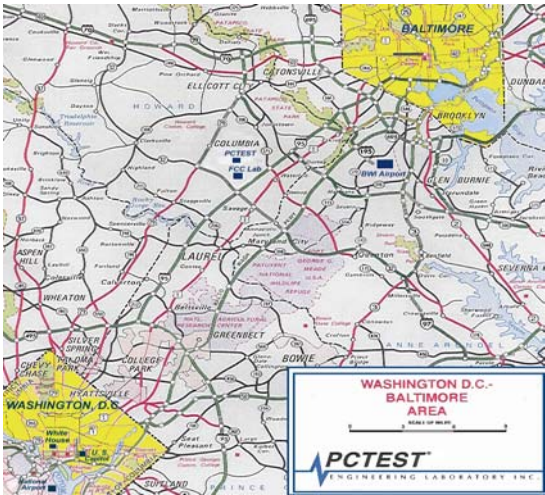

Figure 1. Map of the Greater Baltimore and Metropolitan Washington, D.C. area.

These measurement tests were conducted at *PCTEST Engineering Laboratory, Inc.* facility in New Concept Business Park, Guilford Industrial Park, Columbia, Maryland. The site address is 6660-B Dobbin Road, Columbia, MD 21045. The test site is one of the highest points in the Columbia area with an elevation of 390 feet above mean sea level. The site coordinates are 39° 11'15" N latitude and 76° 49'38" W longitude. The facility is 1.5 miles North of the FCC laboratory, and the ambient signal and ambient signal strength are approximately equal to those of the FCC laboratory. There are no FM or TV transmitters within 15 miles of the site. The detailed description of the measurement facility was found to be in compliance with the requirements of § 2.948 according to ANSI C63.4 on October 19, 1992.

### Measurement Procedure

The radiated and spurious measurements were made outdoors at a 3-meter test range (see Figure2). The equipment under test is placed on a wooden turntable 3-meters from the receive antenna.

The receive antenna height and turntable rotations were adjusted for the highest reading on the receive spectrum analyzer. A half-wave dipole was substituted in place of the EUT. This dipole antenna was driven by a signal generator and the level of the signal generator was adjusted to obtain the same receive spectrum analyzer reading. This level is recorded. For readings above 1GHz, the above procedure is repeated using horn antennas and the difference between the gain of the horn and an isotropic antenna are taken into consideration.

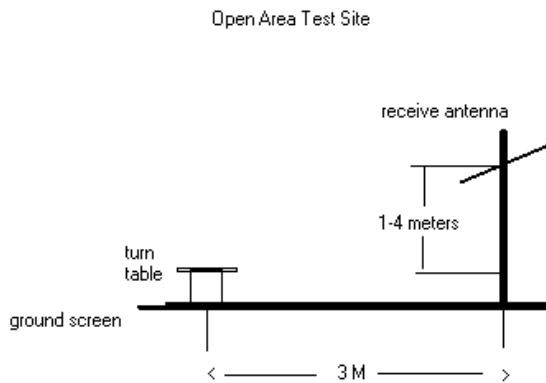



Figure 2. Diagram of 3-meter outdoor test range

PCTEST™ PT. 24 REPORT	 FCC CERTIFICATION		Reviewed By: Quality Manager
Test Report S/N: 24.220416199.H9P	Test Dates: April 29-30, 2002	EUT Type: PCS GSM Handheld Terminal	FCC ID: H9PPPT2837

## 3.1 INSERTS

---

### Function of Active Devices (Confidential)

The Function of active devices are shown in Attachment K.

### Block & Schematic Diagrams (Confidential)

The block diagrams are shown in Attachment I, and the schematic diagrams are shown in Attachment J.

### Operating Instructions

The instruction manual is shown in Attachment M.

### Parts List & Tune-Up Procedure (Confidential)

The parts list & tune-up procedure is shown in Attachment L.

### Description of Freq. Stabilization Circuit (Confidential)

The description of frequency stabilization circuit is shown in Attachment K.

### Description for Suppression of Spurious Radiation, for Limiting Modulation, and Harmonic Suppression Circuits (Confidential)

The description of suppression stabilization circuits is shown in Attachment K.

PCTEST™ PT. 24 REPORT		FCC CERTIFICATION	<b>symbol</b>	Reviewed By: Quality Manager
Test Report S/N: 24.220416199.H9P	Test Dates: April 29-30, 2002	EUT Type: PCS GSM Handheld Terminal	FCC ID: H9PPPT2837	Page 5 of 20

## 4.1 DESCRIPTION OF TESTS

### 4.2 Transmitter Audio Frequency Response

The frequency response of the audio modulating circuit over the frequency range 100 – 5000 Hz is measured. The audio signal generator is connected to the audio input circuit/microphone of the EUT. The audio signal input is adjusted to obtain 50% modulation at 1kHz and this point is taken as the 0dB reference. With the input held constant and below the limit at all frequencies, the audio signal generator is varied from 100 to 50 kHz.

### 4.3 Audio Low Pass Filter Frequency Response

The response in dB relative to 1kHz is measured using the HP8901 a Modulation Analyzer. For the frequency response of the audio low-pass filter, the audio input is connected at the input to the modulation limiter and the modulated stage. The audio output is connected at the output of the modulated stage. The corresponding plots are shown herein.

### 4.4 Modulation Limiting

The audio signal generator is connected to the audio input circuit/microphone of the EUT. The modulation response is measured for each of the three modulating frequencies (300Hz, 1000 Hz, and 3000Hz), and the input voltage is varied from 30% modulation ( $\pm 3.6$ kHz deviation) to at least 20dB higher than the saturation point. Measurements of modulation and the plots are attached herein. Measurements were performed for ST, SAT, and wide-band data modulations. The corresponding results are shown herein.

Note: ST, SAT, & Wide-Band data were internally generated by the EUT.

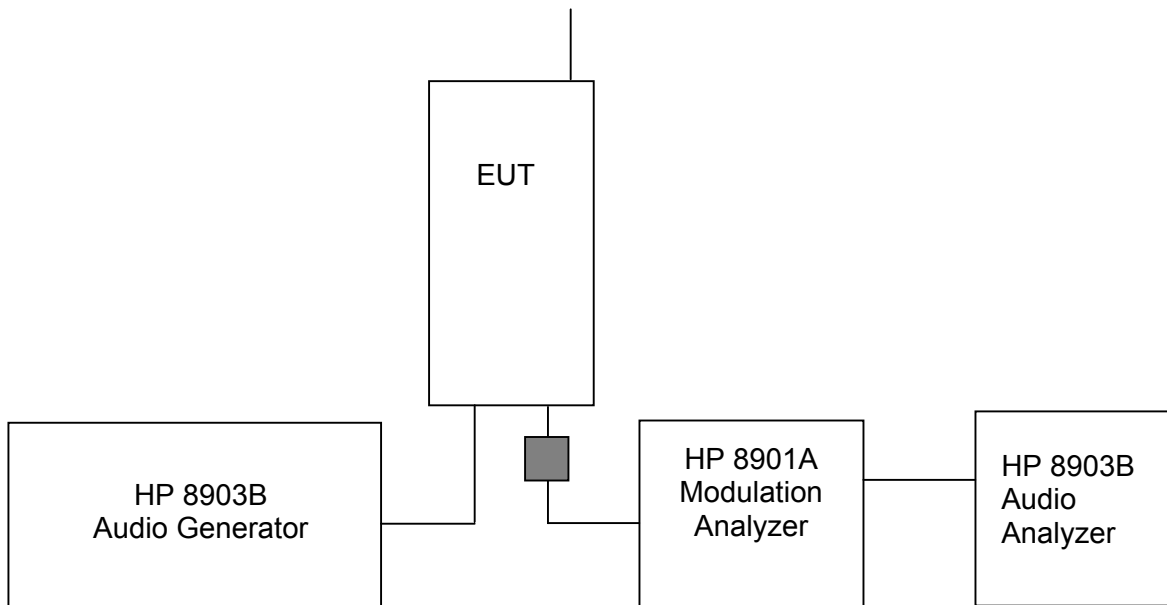



Fig. 3. Transmitter Audio Frequency & Tone Modulation Test Setup.

PCTEST™ PT. 24 REPORT	 PCTEST	FCC CERTIFICATION	 symbol	Reviewed By: Quality Manager
Test Report S/N: 24.220416199.H9P	Test Dates: April 29-30, 2002	EUT Type: PCS GSM Handheld Terminal	FCC ID: H9PPPT2837	Page 6 of 20



## 4.1 DESCRIPTION OF TESTS (CONTINUED)

### 4.5 Occupied Bandwidth Emission Limits

- (a) On any frequency outside a licensee's frequency block, the power of any emission shall be attenuated below the transmitter power (P) by at least  $43 + 10 \log(P)$  dB.
- (b) Compliance with these provisions is based on the use of measurement instrumentation employing a resolution bandwidth of 1 MHz or greater. However, in the 1 MHz bands immediately outside and adjacent to the frequency block a resolution bandwidth of at least one percent of the emission bandwidth of the fundamental emission of the transmitter may be employed. The emission bandwidth is defined as the width of the signal between two points, one below the carrier center frequency and one above the carrier center frequency, outside of which all emission are attenuated at least 26 dB below the transmitter power.
- (c) When measuring the emission limits, the nominal carrier frequency shall be adjusted as close to the licensee's frequency block edges, both upper and lower, as the design permits.
- (d) The measurement of emission power can be expressed in peak or average values, provided they are expressed in the same parameters as the transmitter power.

BLOCK	Freq. Range (MHz) Transmitter (Tx)	Freq. Range (MHz) Receiver (Rx)
A	1850 - 1865	1930 - 1945
B	1870 - 1885	1950 - 1965
C	1895 - 1910	1975 - 1990
D	1865 - 1870	1945 - 1950
E	1885 - 1890	1965 - 1970
F	1890 - 1895	1970 - 1975

Table 1. Broadband PCS Service Frequency Blocks.

PCTEST™ PT. 24 REPORT	 <b>FCC CERTIFICATION</b>			Reviewed By: Quality Manager
Test Report S/N: 24.220416199.H9P	Test Dates: April 29-30, 2002	EUT Type: PCS GSM Handheld Terminal	FCC ID: H9PPPT2837	Page 7 of 20

## 4.1 DESCRIPTION OF TESTS (CONTINUED)

### 4.6 Occupied Bandwidth

The audio signal generator is adjusted to 1kHz. The output level is set to  $\pm 6$ kHz deviation. With the level constant, the frequency is set to 2500Hz. Then the audio signal level is increased by 16dB. The occupied bandwidth data is obtained for the SAT (Supervisory Audio Tone), ST (Signaling Tone), WBD (Wideband data), and DTMF (Dual Tone Multi Frequencies). The results are shown on the attached graphs.

Specified Limits:

- On any frequency removed from the assigned carrier frequency by more than 20 kHz, up to and including 45kHz, the sideband is at least 26dB below the carrier.
- On any frequency removed from the assigned carrier frequency by more than 45 kHz, up to and including 90kHz, the sideband is at least 45dB below the carrier.
- On any frequency removed from the assigned carrier frequency by more than 90 kHz, up to the first multiple of the carrier frequency, the sideband is at least 60dB below the carrier or  $40 + \log_{10}$  (mean power output in Watts) dB, whichever is the smaller attenuation.

### 4.7 Spurious and Harmonic Emissions at Antenna Terminal

The level of the carrier and the various conducted spurious and harmonic frequencies is measured by means of a calibrated spectrum analyzer. The spectrum is scanned from the lowest frequency generated in the equipment up to 10 GHz. The transmitter is modulated with a 2500Hz tone at a level of 16dB greater than that required to provide 50% modulation.

At the input terminals of the spectrum analyzer, an isolator (RF circulator with one port terminated with 50 ohms) and an 870 MHz to 890 MHz bandpass filter is connected between the test transceiver (for conducted tests) or the receive antenna (for radiated tests) and the analyzer. The rejection of the bandpass filter to signals in the 825 – 845 MHz range is adequate to limit the transmit energy from the test transceiver which appears to a level which will allow the analyzer to measure signals less than – 90dBm. Calibration of the test receiver is performed in the 870 – 890 MHz range to insure accuracy to allow variation in the bandpass filter insertion loss to be calibrated.

### 4.8 Frequencies

At the input terminals of the spectrum analyzer, an isolator (RF pad) and an high-pass filter are connected between the test transceiver (for conducted tests) or the receive antenna (for radiated tests) and the analyzer. The high-pass filter (signals below 1.6 GHz) is to limit the fundamental frequency from interfering with the measurement of low-level spurious and harmonic emissions and to ensure that the preamplifier is not saturated.

PCTEST™ PT. 24 REPORT		FCC CERTIFICATION	<b>symbol</b>	Reviewed By: Quality Manager
Test Report S/N: 24.220416199.H9P	Test Dates: April 29-30, 2002	EUT Type: PCS GSM Handheld Terminal	FCC ID: H9PPPT2837	Page 8 of 20



## 4.9 Radiation Spurious and Harmonic Emissions

Radiation and harmonic emissions above 1 GHz is measured outdoors at our 3-meter test range. The equipment under test is placed on a wooden turntable 3-meters from the receive antenna. The receive antenna height and turntable rotations were adjusted for the highest reading on the receive spectrum analyzer. A half-wave dipole was substituted in place of the EUT. This dipole antenna was driven by a signal generator with the level of the signal generator being adjusted to obtain the same receive spectrum analyzer reading. This level is recorded. For readings above 1GHz, the above procedure is repeated using horn antennas and the difference between the gain of the horn and an isotropic or dipole antenna are taken into consideration.

PCTEST™ PT. 24 REPORT	 <b>FCC CERTIFICATION</b>		<b>symbol</b>	Reviewed By: Quality Manager
Test Report S/N: 24.220416199.H9P	Test Dates: April 29-30, 2002	EUT Type: PCS GSM Handheld Terminal	FCC ID: H9PPPT2837	Page 9 of 20

## 5.0 Frequency Stability/Temperature Variation.

The frequency stability of the transmitter is measured by:

- a.) **Temperature:** The temperature is varied from -30°C to +60°C using an environmental chamber.
- b.) **Primary Supply Voltage:** The primary supply voltage is varied from 85% to 115% of the voltage normally at the input to the device or at the power supply terminals if cables are not normally supplied.

*Specification – The frequency stability shall be sufficient to ensure that the fundamental emission stays within the authorized frequency block. The frequency stability of the transmitter shall be maintained within ±0.00025 (±2.5 ppm) of the center frequency.*

### Time Period and Procedure:

1. The carrier frequency of the transmitter and the individual oscillators is measured at room temperature (25°C to 27°C to provide a reference).
2. The equipment is subjected to an overnight “soak” at -30°C without any power applied.
3. After the overnight “soak” at 30°C (usually 14-16 hours), the equipment is turned on in a “standby” condition for one minute before applying power to the transmitter. Measurement of the carrier frequency of the transmitter and the individual oscillators is made within a three minute interval after applying power to the transmitter.
4. Frequency measurements are made at 10°C interval up to room temperature. At least a period of one and one half-hour is provided to allow stabilization of the equipment at each temperature level.
5. Again the transmitter carrier frequency and the individual oscillators is measured at room temperature to begin measurement of the upper temperature levels.
6. Frequency measurements are at 10 intervals starting at 30°C up to +50°C allowing at least two hours at each temperature for stabilization. In all measurements the frequency is measured within three minutes after re-applying power to the transmitter.
7. The artificial load is mounted external to the temperature chamber.

**NOTE: The EUT is tested down to the battery endpoint.**

PCTEST™ PT. 24 REPORT		 <b>FCC CERTIFICATION</b>		<b>symbol</b>	Reviewed By: Quality Manager
Test Report S/N: 24.220416199.H9P	Test Dates: April 29-30, 2002	EUT Type: PCS GSM Handheld Terminal	FCC ID: H9PPPT2837	Page 10 of 20	

## 5.1 Test Data

### 5.2 Equivalent Isotropic Radiated Power (E.I.R.P.)

Radiated measurements at 3 meters

Supply Voltage: 3.6 VDC

Modulation: PCS CDMA



FREQ. (MHz)	REF. LEVEL (dBm)	POL (H/V)	Azimuth (o angle)	EIRP (dBm)	EIRP (W)	Battery
1851.20	-13.500	V	60	29.581	0.910	Standard
1880.00	-13.250	V	60	30.001	1.003	Standard
1908.80	-13.500	V	60	29.921	0.984	Standard

Note: Standard batteries are the only battery options for this phone

#### NOTES:

Equivalent Isotropic Radiated Power Measurements by Substitution Method according to ANSI/TIA/EIA-603-A-2001, Aug. 15, 2001:

The EUT was placed on a wooden turn table 3-meters from the receive antenna. The receive antenna height and turntable rotation was adjusted for the highest reading on the receive spectrum analyzer. A Horn antenna was substituted in place of the EUT. This Horn antenna was driven by a signal generator and the level of the signal generator was adjusted to obtain the same receive spectrum analyzer reading. The conducted power at the terminals of the Horn antenna is measured. The difference between the gain of the horn and an isotropic antenna is taken into consideration and the EIRP is recorded.

PCTEST™ PT. 24 REPORT	 <b>FCC CERTIFICATION</b>			Reviewed By: Quality Manager
Test Report S/N: 24.220416199.H9P	Test Dates: April 29-30, 2002	EUT Type: PCS GSM Handheld Terminal	FCC ID: H9PPPT2837	Page 11 of 20

## 6.1 Test Data (Continued)

### 6.2 PCS CDMA Radiated Measurements

#### Field Strength of SPURIOUS Radiation



OPERATING FREQUENCY: 1850.20 MHz  
 CHANNEL: 0025 (Low)  
 MEASURED OUTPUT POWER: 29.581 dBm = 0.908 W  
 MODULATION SIGNAL: CDMA (Internal)  
 DISTANCE: 3 meters  
 LIMIT:  $43 + 10 \log_{10}(W) =$  42.58 dBc

FREQ. (MHz)	REFERENCE LEVEL (dBm)	POL (H/V)	(dBc)
3700.40	-35.83	V	65.4
5550.60	-39.53	V	69.1
7400.80	-51.03	V	80.6

#### NOTES:

Radiated Spurious Emission Measurements by Substitution Method according to ANSI/TIA/EIA-603-A-2001, Aug. 15, 2001:

The EUT was placed on a wooden turn table 3-meters from the receive antenna. The receive antenna height and turntable rotation was adjusted for the highest reading on the receive spectrum analyzer. A half-wave dipole was substituted in place of the EUT. This dipole antenna was driven by a signal generator and the level of the signal generator was adjusted to obtain the same receive spectrum analyzer reading. This spurious level is recorded. For readings above 1GHz, the above procedure is repeated using horn antennas and the difference between the gain of the horn and an isotropic or dipole antenna are taken into consideration.

PCTEST™ PT. 24 REPORT	 <b>FCC CERTIFICATION</b>			Reviewed By: Quality Manager
Test Report S/N: 24.220416199.H9P	Test Dates: April 29-30, 2002	EUT Type: PCS GSM Handheld Terminal	FCC ID: H9PPPT2837	Page 12 of 20

## 6.1 Test Data (Continued)

### 6.3 PCS CDMA Radiated Measurements

#### Field Strength of SPURIOUS Radiation



OPERATING FREQUENCY: 1880.00 MHz  
 CHANNEL: 0600 (Mid)  
 MEASURED OUTPUT POWER: 30.001 dBm = 1.000 W  
 MODULATION SIGNAL: CDMA (Internal)  
 DISTANCE: 3 meters  
 LIMIT:  $43 + 10 \log_{10}(W) =$  43.00 dBc

FREQ. (MHz)	REFERENCE LEVEL (dBm)	POL (H/V)	(dBc)
3760.00	-34.53	V	64.5
5640.00	-39.83	V	69.8
7520.00	-50.43	V	80.4

#### NOTES:

Radiated Spurious Emission Measurements by Substitution Method according to ANSI/TIA/EIA-603-A-2001, Aug. 15, 2001:

The EUT was placed on a wooden turn table 3-meters from the receive antenna. The receive antenna height and turntable rotation was adjusted for the highest reading on the receive spectrum analyzer. A half-wave dipole was substituted in place of the EUT. This dipole antenna was driven by a signal generator and the level of the signal generator was adjusted to obtain the same receive spectrum analyzer reading. This spurious level is recorded. For readings above 1GHz, the above procedure is repeated using horn antennas and the difference between the gain of the horn and an isotropic or dipole antenna are taken into consideration.

PCTEST™ PT. 24 REPORT	 <b>FCC CERTIFICATION</b>			Reviewed By: Quality Manager
Test Report S/N: 24.220416199.H9P	Test Dates: April 29-30, 2002	EUT Type: PCS GSM Handheld Terminal	FCC ID: H9PPPT2837	Page 13 of 20

## 6.1 Test Data (Continued)

### 6.4 PCS CDMA Radiated Measurements

#### Field Strength of SPURIOUS Radiation

OPERATING FREQUENCY: 1909.80 MHz  
 CHANNEL: 1175 (High)  
 MEASURED OUTPUT POWER: 29.921 dBm = 0.982 W  
 MODULATION SIGNAL: CDMA (Internal)  
 DISTANCE: 3 meters  
 LIMIT:  $43 + 10 \log_{10}(W) =$  42.92 dBc

FREQ. (MHz)	REFERENCE LEVEL (dBm)	POL (H/V)	(dBc)
3819.60	-35.73	V	65.6
5729.40	-39.53	V	69.4
7639.20	-50.73	V	80.6

#### NOTES:

Radiated Spurious Emission Measurements by Substitution Method according to ANSI/TIA/EIA-603-A-2001, Aug. 15, 2001:

The EUT was placed on a wooden turn table 3-meters from the receive antenna. The receive antenna height and turntable rotation was adjusted for the highest reading on the receive spectrum analyzer. A half-wave dipole was substituted in place of the EUT. This dipole antenna was driven by a signal generator and the level of the signal generator was adjusted to obtain the same receive spectrum analyzer reading. This spurious level is recorded. For readings above 1GHz, the above procedure is repeated using horn antennas and the difference between the gain of the horn and an isotropic or dipole antenna are taken into consideration.

PCTEST™ PT. 24 REPORT		FCC CERTIFICATION	<b>symbol</b>	Reviewed By: Quality Manager
Test Report S/N: 24.220416199.H9P	Test Dates: April 29-30, 2002	EUT Type: PCS GSM Handheld Terminal	FCC ID: H9PPPT2837	Page 14 of 20

## 7.1 Test Data (Continued)

### 7.2 FREQUENCY STABILITY (PCS CDMA)



OPERATING FREQUENCY: 1,880,000,004 Hz

CHANNEL: 0661

REFERENCE VOLTAGE: 3.7 VAC

DEVIATION LIMIT: ± 0.00025 % or 2.5 ppm

VOLTAGE (%)	POWER (VDC)	TEMP (°C)	FREQ. (Hz)	Deviation (%)
100 %	3.70	+ 20 (Ref)	1,880,000,004	0.000000
100 %		- 30	1,879,999,760	0.000013
100 %		- 20	1,879,999,778	0.000012
100 %		- 10	1,879,999,816	0.000010
100 %		0	1,879,999,948	0.000003
100 %		+ 10	1,879,999,966	0.000002
100 %		+ 20	1,880,000,004	0.000000
100 %		+ 25	1,879,999,910	0.000005
100 %		+ 30	1,879,999,854	0.000008
100 %		+ 40	1,880,000,023	-0.000001
100 %		+ 50	1,880,000,230	-0.000012
100 %		+ 60	1,880,000,211	-0.000011
85 %		3.17	+ 20	1,880,000,004
115 %	4.26	+ 20	1,880,000,004	0.000000
BATT. ENDPOINT	2.93	+ 20	1,880,000,004	0.000000

PCTEST™ PT. 24 REPORT	 <b>FCC CERTIFICATION</b>			Reviewed By: Quality Manager
Test Report S/N: 24.220416199.H9P	Test Dates: April 29-30, 2002	EUT Type: PCS GSM Handheld Terminal	FCC ID: H9PPPT2837	Page 15 of 20

## 7.1 Test Data (Continued)

### 7.3 FREQUENCY STABILITY (PCS CDMA)

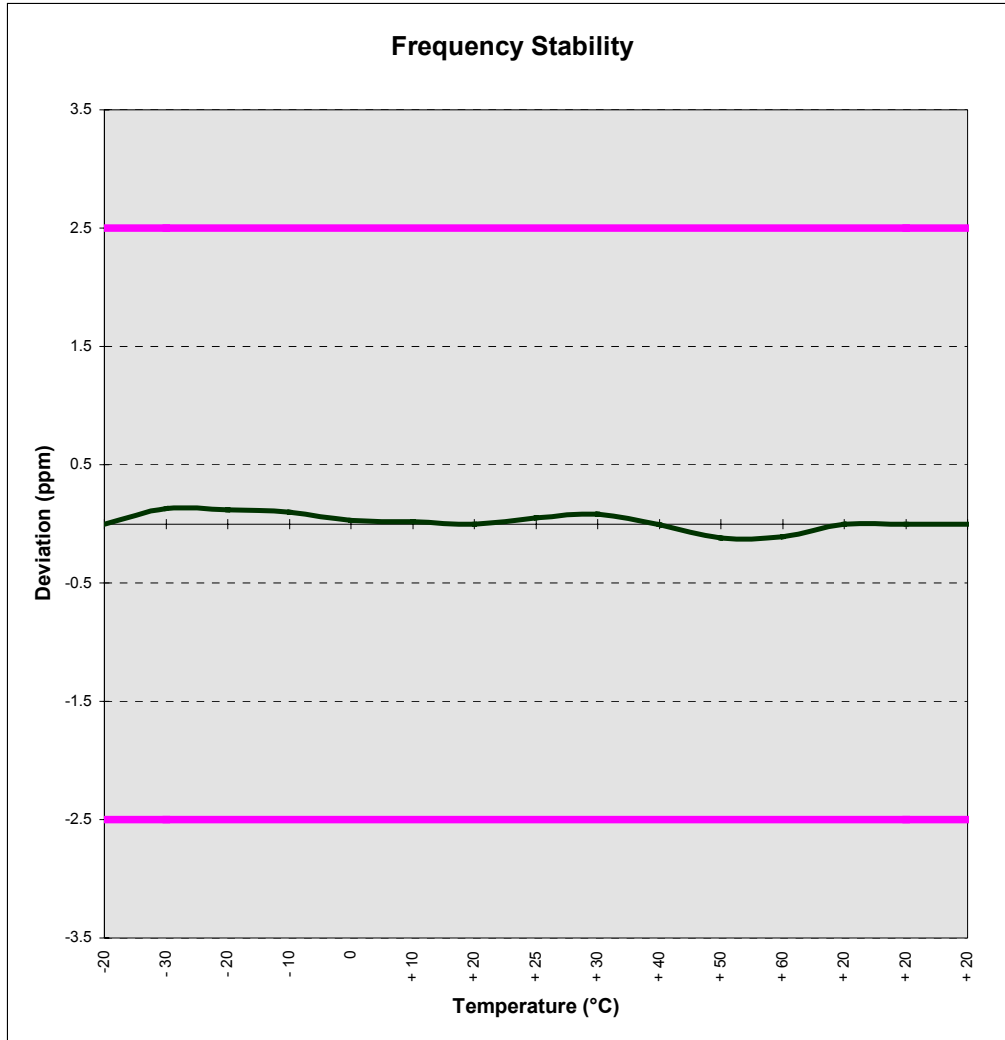

PCTEST™ PT. 24 REPORT	<b>PCTEST</b> FCC CERTIFICATION		<b>symbol</b>	Reviewed By: Quality Manager
Test Report S/N: 24.220416199.H9P	Test Dates: April 29-30, 2002	EUT Type: PCS GSM Handheld Terminal	FCC ID: H9PPPT2837	Page 16 of 20



## 8.1 PLOT(S) OF EMISSIONS

---



(SEE ATTACHMENT D)

PCTEST™ PT. 24 REPORT		FCC CERTIFICATION	<b>symbol</b>	Reviewed By: Quality Manager
Test Report S/N: 24.220416199.H9P	Test Dates: April 29-30, 2002	EUT Type: PCS GSM Handheld Terminal	FCC ID: H9PPPT2837	Page 17 of 20

## 9.1 TEST EQUIPMENT

Type	Model	Cal. Due Date	S/N
Microwave Spectrum Analyzer	HP 8566B (100Hz-22GHz)	08/15/02	3638A08713
Microwave Spectrum Analyzer	HP 8566B (100Hz-22GHz)	04/17/03	2542A11898
Spectrum Analyzer/Tracking Gen.	HP 8591A (100Hz-1.8GHz)	08/10/02	3144A02458
Signal Generator	HP 8640B (500Hz-1GHz)	06/03/02	2232A19558
Signal Generator	HP 8640B (500Hz-1GHz)	06/03/02	1851A09816
Signal Generator	Rohde & Schwarz (0.1-1000MHz)	09/11/02	894215/012
Ailtech/Eaton Receiver	NM 37/57A-SL (30-1000MHz)	04/12/03	0792-03271
Ailtech/Eaton Receiver	NM 37/57A (30-1000MHz)	03/11/03	0805-03334
Ailtech/Eaton Receiver	NM 17/27A (0.1-32MHz)	09/17/02	0608-03241
Quasi-Peak Adapter	HP 85650A	08/15/02	2043A00301
Ailtech/Eaton Adapter	CCA-7 CISPR/ANSI QP Adapter	03/11/03	0194-04082
Gigatronics Universal Power Meter	8657A		1835256
Gigatronics Power Sensor	80701A (0.05-18GHz)		1833460
Signal Generator	HP 8648D (9kHz-4GHz)		3613A00315
Amplifier Research	5SIG4 (5W, 800MHz-4.2GHz)		22322
Network Analyzer	HP 8753E (30kHz-3GHz)		JP38020182
Audio Analyzer	HP 8903B		3011A09025
Modulation Analyzer	HP 8901A		2432A03467
Power Meter	HP 437B		3125U24437
Power Sensor	HP 8482H (30 $\mu$ W-3W)		2237A02084
Harmonic/Flicker Test System	HP 6841A (IEC 555-2/3)		3531A00115
Broadband Amplifier (2)	HP 8447D		1145A00470, 1937A03348
Broadband Amplifier	HP 8447F		2443A03784
Horn Antenna	EMCO Model 3115 (1-18GHz)		9704-5182
Horn Antenna	EMCO Model 3115 (1-18GHz)		9205-3874
Horn Antenna	EMCO Model 3116 (18-40GHz)		9203-2178
Biconical Antenna (4)	Eaton 94455/Eaton 94455-1/Singer 94455-1/Compliance Design 1295, 1332, 0355		0608, 1103, 1104
Log-Spiral Antenna (3)	Ailtech/Eaton 93490-1		
Roberts Dipoles	Compliance Design (1 set)		
Ailtech Dipoles	DM-105A (1 set)		33448-111
EMCO LISN (6)	3816/2		1079
Microwave Preamplifier 40dB Gain	HP 83017A (0.5-26.5GHz)		3123A00181
Microwave Cables	MicroCoax (1.0-26.5GHz)		
Ailtech/Eaton Receiver	NM37/57A-SL		0792-03271
Spectrum Analyzer	HP 8594A		3051A00187
Spectrum Analyzer (2)	HP 8591A		3034A01395, 3108A02053
Microwave Survey Meter	Holaday Model 1501 (2.450GHz)		80931
Digital Thermometer	Extech Instruments 421305		426966
Attenuator	HP 8495A (0-70dB) DC-4GHz		
Bi-Directional Coax Coupler	Narda 3020A (50-1000MHz)		
Shielded Screen Room	RF Lindgren Model 26-2/2-0		6710 (PCT270)
Shielded Semi-Anechoic Chamber	Ray Proof Model S81		R2437 (PCT278)
Environmental Chamber	Associated Systems Model 1025 (Temperature/Humidity)		PCT285

\* Calibration traceable to the National Institute of Standards and Technology (NIST).

PCTEST™ PT. 24 REPORT	 <b>FCC CERTIFICATION</b>			Reviewed By: Quality Manager
Test Report S/N: 24.220416199.H9P	Test Dates: April 29-30, 2002	EUT Type: PCS GSM Handheld Terminal	FCC ID: H9PPPT2837	Page 18 of 20

## 10.1 SAMPLE CALCULATIONS

### A. Emission Designator

**Emission Designator = 1M25F9W**

CDMA BW = 1.25 MHz

F = Frequency Modulation

9 = Composite Digital Info

W = Combination (Audio/Data)

(Measured at the 99.75% power bandwidth)

**Emission Designator = 40K0F8W**

Calculation: Voice + SAT

Modulation: Voice is 2.5 kHz and SAT is 6 kHz – Maximum modulation is M = 6 kHz

Deviation: Voice is 12 kHz and SAT is 2 kHz – Maximum deviation is D = 12 + 2 = 14 kHz

Bn = 2xM + 2xDK with K = 1

Bn = 40 kHz

Calculation: Signaling Tone (ST) + SAT

Modulation: ST is 10 kHz and SAT is 6 kHz – Maximum modulation is M = 10 kHz

Deviation: ST is 8 kHz and SAT is 2 kHz – Maximum deviation is D = 8 + 2 = 10 kHz

Bn = 2xM + 2xDK with K = 1

Bn = 40 kHz

**Emission Designator = 40K0F1D**

Calculation: Voice + SAT

Modulation: Wideband Data is 10 kHz and SAT is 6 kHz – Maximum modulation is M = 10 kHz

Deviation: Wideband Data is 8 kHz and SAT is 2 kHz – Maximum deviation is D = 8 + 2 = 10 kHz

Bn = 2xM + 2xDK with K = 1

Bn = 40 kHz

### B. Spurious Radiated Emission - PCS Band

**Example: Channel 25 PCS Mode 2<sup>nd</sup> Harmonic (3702.50 MHz)**

The receive analyzer reading at 3 meters with the EUT on the turntable was -81.0 dBm. The gain of the substituted antenna is 8.1 dBi. The signal generator connected to the substituted antenna terminals is adjusted to produce a reading of -81.0 dBm on the receive analyzer. The loss of the cable between the signal generator and the terminals of the substituted antenna is 2.0 dB at 3702.50 MHz. So 6.1 dB is added to the signal generator reading of -30.9 dBm yielding -24.80 dBm. The fundamental EIRP was 25.501 dBm so this harmonic was 25.501 dBm - (-24.80) = 50.3 dBc

PCTEST™ PT. 24 REPORT		FCC CERTIFICATION	<b>symbol</b>	Reviewed By: Quality Manager
Test Report S/N: 24.220416199.H9P	Test Dates: April 29-30, 2002	EUT Type: PCS GSM Handheld Terminal	FCC ID: H9PPPT2837	Page 19 of 20

## 11.1 CONCLUSION

---

The data collected shows that the **SYMBOL GSM PCS Handheld Terminal FCC ID: H9PPPT2837** complies with all the requirements of Parts 2, 22, and 24 of the FCC rules.

PCTEST™ PT. 24 REPORT	 <b>FCC CERTIFICATION</b>		<b>symbol</b>	Reviewed By: Quality Manager
Test Report S/N: 24.220416199.H9P	Test Dates: April 29-30, 2002	EUT Type: PCS GSM Handheld Terminal	FCC ID: H9PPPT2837	Page 20 of 20