

**TEST REPORT**

**Report Number: 30567601**

**Project Number: 3056760**

**March 29, 2004**

**Testing performed on the**

**Mobile Computer**

**Model: MC9063**

**FCC ID: H9PMC9063A**

**IC ID: 1549D-MC9063A**

**to**

**FCC Parts: 15 (Subparts C & B), 22H & 24E**

**for**

**Symbol Technologies Inc.**



A2LA Certificate Number: 1755-01

Test Performed by:  
Intertek Testing Services  
1365 Adams Court  
Menlo Park, CA 94025

Test Authorized by:  
Symbol Technologies Inc.  
One Symbol Plaza  
Holtsville, NY 11742-1300

Tested by:   
Bruce Gordon

Date: March 18, 2004

Reviewed by:   
David Chernomordik

Date: March 31, 2004

*This report is for the exclusive use of Intertek's Client and is provided pursuant to the agreement between Intertek and its Client. Intertek's responsibility and liability are limited to the terms and conditions of the agreement. Intertek assumes no liability to any party, other than to the Client in accordance with the agreement, for any loss, expense or damage occasioned by the use of this report. Only the Client is authorized to copy or distribute this report and then only in its entirety. Any use of the Intertek name or one of its marks for the sale or advertisement of the tested material, product or service must first be approved in writing by Intertek. The observations and test results in this report are relevant only to the sample tested. This report by itself does not imply that the material, product, or service is or has ever been under an Intertek certification program. This report must not be used to claim product endorsement by A2LA, NIST nor any other agency of the U.S. Government.*

## TABLE OF CONTENTS

<b>1.0</b>	<b>Test Rationale</b> .....	<b>3</b>
<b>2.0</b>	<b>Summary of Tests</b> .....	<b>4</b>
<b>3.0</b>	<b>General Description</b> .....	<b>5</b>
3.1	Product Description .....	5
3.2	Related Submittal(s) Grants .....	6
3.3	Test Methodology .....	6
3.4	Test Facility .....	6
<b>4.0</b>	<b>System Test Configuration</b> .....	<b>8</b>
4.1	Support Equipment and description.....	8
4.2	Block Diagram of Test Setup.....	8
4.3	Justification .....	9
4.4	Software Exercise Program.....	10
4.5	Mode of operation during test.....	10
4.6	Modifications required for Compliance .....	10
4.7	Additions, deviations and exclusions from standards .....	10
<b>5.0</b>	<b>RLAN Test</b> .....	<b>11</b>
5.1	EIRP measurement.....	11
5.2	Radiated emission measurement.....	12
<b>6.0</b>	<b>Bluetooth tests</b> .....	<b>14</b>
6.1	EIRP measurement.....	14
6.2	Radiated emission measurement.....	15
<b>7.0</b>	<b>CDMA RF Modem tests</b> .....	<b>17</b>
7.1	ERP/EIRP measurement .....	17
7.2	Spurious radiated emission measurement .....	19
<b>8.0</b>	<b>Radiated Emissions from Digital Part and Receiver</b> .....	<b>21</b>
<b>9.0</b>	<b>AC line conducted emissions</b> .....	<b>24</b>
<b>10.0</b>	<b>List of Test Equipment</b> .....	<b>26</b>
<b>10.0</b>	<b>Document History</b> .....	<b>27</b>
	<b>Appendix A – Duty Cycle Calculation for BT module</b> .....	<b>28</b>

## 1.0 Test Rationale

This report is intended to show verification of compliance of the Symbol Technologies Inc. **Mobile Computer**, model MC9063 to the requirements of FCC Specification Parts 15, 22H, and 24E.

The MC9063 integrates three radio modules listed below, which have been certified.

- RLAN module – Part 15 Spread Spectrum transmitter, FCC ID: H9P2164436
- Bluetooth module - Part 15 Spread Spectrum transmitter, FCC ID: H9P2164381
- CDMA module – Part 22/24 800/1900 MHz Dual Band CDMA Data Modem, FCC ID: N7N-EM3420P

As declared by the Applicant, the modules are identical (unmodified) to the original granted devices, except that the different antennas are used. Therefore, the following test results from the original reports are applicable to the MC9063:

TEST	REFERENCE	RESULTS
<b>RLAN, FCC ID: H9P2164436</b>		
6 dB Bandwidth	15.247(a)(2)	Complies
Power Density	15.247(d)	Complies
Out-of-band Antenna Conducted Emission	15.247(c)	Complies
<b>Bluetooth, FCC ID: H9P2164381</b>		
20 dB Bandwidth	15.247(a)(1)	Complies
Min. Channel Separation	15.247(a)(1)	Complies
Min. Hopping Channels	15.247(a)(1)	Complies
Average Channel Occupancy Time	15.47(a)(1)	Complies
Out-of-band Antenna Conducted Emission	15.247(c)	Complies
<b>CDMA, FCC ID: N7N-EM3420P</b>		
Out-of-band Antenna Conducted Emission including emission on the block-edge frequencies	2.1051, 22.901(d), 24.938(a)	Complies
Frequency stability vs temperature and voltage	2.1053	Complies
Occupied Bandwidth	2.1049	Complies

The only required tests to be performed are:

for Part 15C RLAN

- radiated emissions in the restricted bands
- EIRP (to verify the conducted output power, because the device does not have an antenna connector)

for Part 15C BT

- radiated emissions in the restricted bands
- EIRP (to verify the conducted output power, because the device does not have an antenna connector)

for Part 22/24 CDMA

- ERP/EIRP
- Spurious radiated emissions

In addition, Part 15 Subpart B radiated and AC line conducted emissions tests are required.

**2.0 Summary of Tests**

TEST	REFERENCE	RESULTS
<b>RLAN, FCC ID: H9P2164436</b>		
Conducted output power	15.247(b)	Complies
Radiated emissions in the restricted bands	15.247(c), 15.205, 15.209	Complies
<b>Bluetooth, FCC ID: H9P2164381</b>		
Conducted output power	15.247(b)	Complies
Radiated emissions in the restricted bands	15.247(c), 15.205, 15.209	Complies
<b>CDMA, FCC ID: N7N-EM3420P</b>		
ERP/EIRP	22.913, 24.232	Complies
Spurious radiated emissions	2.1053	Complies
MC9063		
Radiated emissions from digital part and receiver	15.109	Complies
AC line conducted emissions	15.107	Complies

A pre-production version of the EUT was received on March 10, 2004 in good operating condition. As declared by the Applicant, it is identical to the production units.

Date of Test: March 11, 2004 – March 18, 2004

### 3.0 General Description

#### 3.1 Product Description

Equipment Under Test				
Description	Mobile Computer			
Manufacturer	Symbol Technologies Inc.			
Type	MC9063			
Part Number	MC9063-KKEHBEEA7WW			
Serial Number	ALP75427			
FCC ID	H9PMC9063A			
IC ID	1549D-MC9063A			
Radio Modules Integrated	RLAN (21-64436), Bluetooth (21-64381), CDMA (EM3420)			
Technical Description	Symbol MC9063 is Mobile Computer supporting a full alpha numeric keypad, which offers 2.4 GHz 802.11b Wireless LAN and Bluetooth connectivity, and includes Sierra EM3420 CDMA2000-1X dual band (800/1900) radio card.			
Battery/ Power Supply				
Description	Lithium Battery			
Manufacturer	Symbol Technologies Inc.			
Part Number	21-65587-01			
Voltage	7.2 V			
Radio Modules				
Description	RLAN radio	Bluetooth radio	CDMA dual band radio	
Manufacturer	Symbol Tech.	Symbol Tech.	Sierra Wireless	
Type	21-64436	21-64381	EM3420	
Power	7-16 V	3.3 V	3.4 – 4.5V	
Transmitter Operating Range, MHz	2412 –2462	2402 –2480	824.7-848.31	1851.25-1908.75
RF Output Power (conducted)	100 mW (peak)	100 mW (peak)	260 mW (ave.)	250 mW (ave.)
Receiver Operating Range, MHz	2412 –2462	2402 –2480	869.7 – 893.31	1930 - 1990
Intermediate Frequency	374 MHz	N/A	N/A	N/A
Emission Designator	11M0F1D	1M00F1D	1M25F9W	
Type of transmission	DSSS	FHSS	CDMA	
FCC ID	H9P2164436	H9P2164381	N7N-EM3420P	
IC ID	1549D-2164436	1549D-2164381	2417C-EM3420	
Ancillaries				
Description	Headset			
Manufacturer	VXI Corporation			
Type	VXI 61-SYB			
Part Number	50-11300-050			

### 3.2 Related Submittal(s) Grants

None.

### 3.3 Test Methodology

Both conducted and radiated emissions measurements were performed according to the procedures in ANSI C63.4 (1992). Radiated tests were performed at an antenna to EUT distance of 3 meters, unless stated otherwise in the "**Data Sheet**" of this Application. All other measurements were made in accordance with the procedures in parts 2 and 15 of CFR 47.

### 3.4 Test Facility

The test facility is located at 1365 Adams Court, Menlo Park, California. Menlo Park is approximately 30 miles SE from San Francisco and 20 miles NW from San Jose. The geographic coordinates are 37° 28' 43" N Latitude and 122° 8' 40" W Longitude. Elevation is 60 feet above sea level.

Radiated emission measurements were performed in a 10 meter Semi-Anechoic Chamber, referred to as Site 1. Site 1 is a radio frequency semi-anechoic chamber / Alternate Test Site (ATS) intended to closely simulate the measurement environment as established for the Open Area test Site (OATS). The chamber is a shielded enclosure used to control and maintain a predictable EMI environment within the test region. A lining of RF absorbing material (Absorber) and other anechoic materials are installed over all interior wall and ceiling surfaces as to completely shroud exposed metallic components and disrupt reflective properties. The ground plane is an exposed RF reflective surface. The turntable is flush mounted, 3 meters in diameter, and remotely controlled. The antenna mast can be positioned at 3 or 10 meters away from the turntable. The antenna mast is remote controlled and can lower/raise an antenna between 1 – 4 meters. The antenna mast can also rotate between horizontal and vertical polarizations. The site meets the characteristics of ANSI C63.4 and is registered with the FCC.

Diagram of 10 meter Chamber for Radiated Emissions Testing

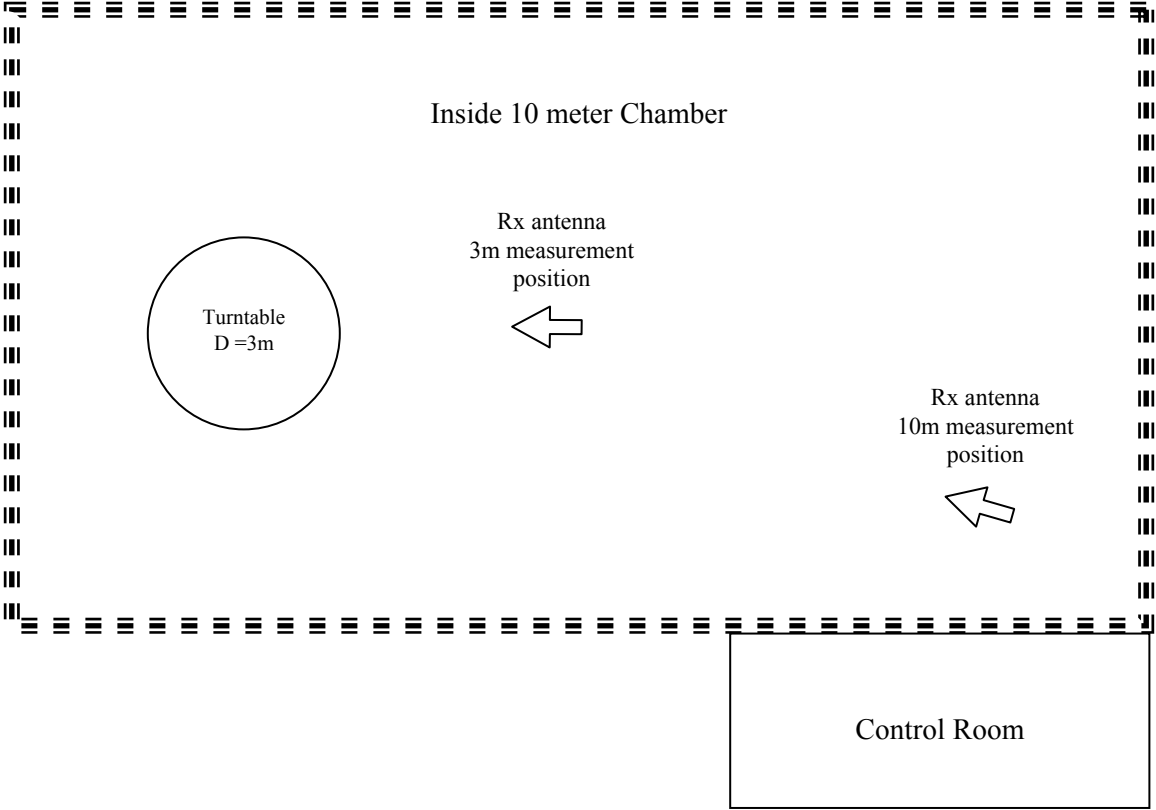

**4.0 System Test Configuration**

4.1 Support Equipment and description

Laptop computer: DELL, Latitude CPi, model PPX

4.2 Block Diagram of Test Setup

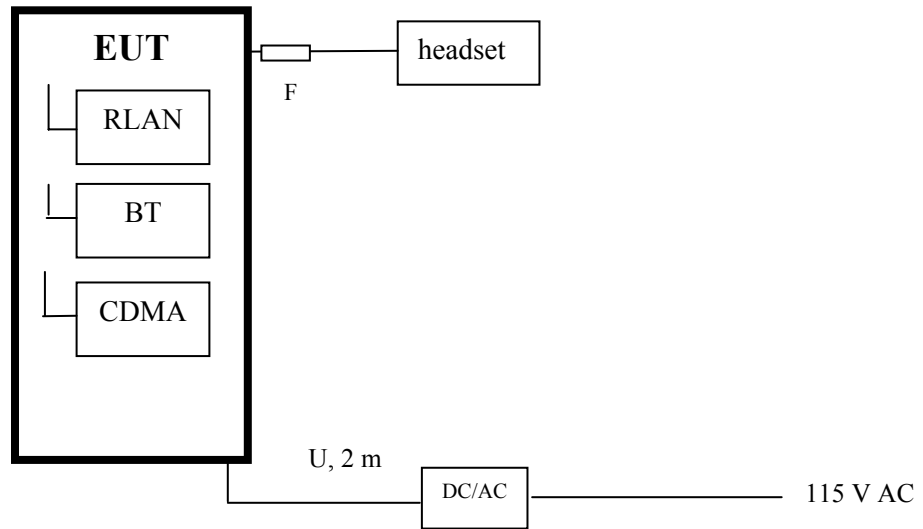

<b>S</b> = Shielded	<b>F</b> = With Ferrite
<b>U</b> = Unshielded	<b>m</b> = Meter



### 4.3 Justification

For emission testing, the Equipment Under Test (EUT) was configured for testing in a typical fashion (as a customer would normally use it). During testing, all cables were manipulated to produce worst-case emissions.

For radiated emission measurements, the EUT is attached to a cardboard box (if necessary) and placed on the wooden turntable. If the EUT attaches to peripherals, they are connected and operational (as typical as possible). The EUT is wired to transmit full power.

The signal is maximized through rotation and placement in the three orthogonal axes. The antenna height and polarization are varied during the search for maximum signal level. The antenna height is varied from 1 to 4 meters.

Radiated emissions are taken at three meters unless the signal level is too low for measurement at that distance. If necessary, a pre-amplifier is used and/or the test is conducted at a closer distance. All readings are extrapolated back to the equivalent three-meter reading using inverse scaling with distance.

Care was taken to ensure proper power supply voltages during testing.

#### Diagram of the test setup

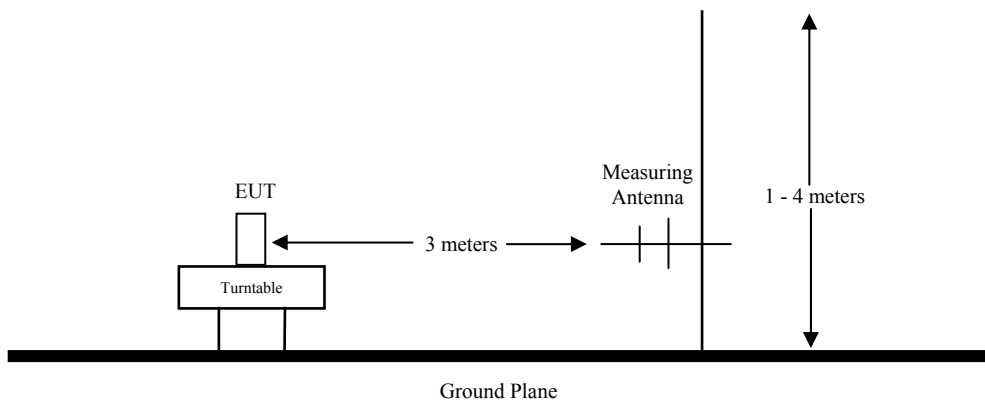

### Field Strength Calculation

The field strength is calculated by adding the Antenna Factor and Cable Factor, and subtracting the Amplifier Gain (if any) from the measured reading. The basic equation with a sample calculation is as follows:

$$FS = RA + AF + CF - AG$$

Where FS = Field Strength in dB( $\mu$ V/m)

RA = Receiver Amplitude (including preamplifier) in dB( $\mu$ V)

CF = Cable Attenuation Factor in dB

AF = Antenna Factor in dB(1/m)

AG = Amplifier Gain in dB

Assume a receiver reading of 52.0 dB( $\mu$ V) is obtained. The antenna factor of 7.4 dB(1/m) and cable factor of 1.6 dB is added. The amplifier gain of 29 dB is subtracted, giving field strength of 32 dB( $\mu$ V/m). This value in dB( $\mu$ V/m) was converted to Intertek corresponding level in  $\mu$ V/m.

RA = 52.0 dB( $\mu$ V); CF = 1.6 dB; AF = 7.4 dB(1/m); AG = 29.0 dB

FS = 52 + 7.4 + 1.6 - 29 = 32 dB( $\mu$ V/m)

Level in  $\mu$ V/m = Common Antilogarithm [(32 dB( $\mu$ V/m)/20)] = 39.8  $\mu$ V/m

#### 4.4 Software Exercise Program

The EUT exercise program used during radiated and conducted testing was designed to exercise the various system components in a manner similar to a typical use. For emissions testing, the units were setup to transmit continuously to simplify the measurement methodology.

#### 4.5 Mode of operation during test

Continuously transmitting signal on different channels.

#### 4.6 Modifications required for Compliance

Intertek installed no modifications during compliance testing in order to bring the product into compliance.

#### 4.7 Additions, deviations and exclusions from standards

No additions, deviations or exclusion have been made from standard.

**5.0 RLAN Test**  
FCC Rule: 15.247

5.1 EIRP measurement

Requirement

There is no requirement for EIRP, however, as the transmitter does not have accessible antenna connector, alternative method for conducted RF power output measurement is used.

Procedure

The EUT is powered from a fully charged battery.

The EUT is placed on a non-conductive turntable, 0.8m above the ground plane, in the 10m semi-anechoic chamber.

The radiated emission at the fundamental frequency is measured at 3m distance with a receiving antenna connected to a spectrum analyzer. The emission level is maximized through the rotation of the turntable and by raising/lowering the receiving antenna from 1m to 4m. The highest spectrum analyzer reading (U in dBm) is recorded using the same setup as described in section 2.1.

EIRP is measured using the substitution method. The EUT is replaced by horn antenna connected to a signal generator. The emission level is maximized through the rotation of the turntable and the raising and lowering of the receiving antenna from 1m to 4 m. On each channel the signal generator output is adjusted to obtain the previously recorded spectrum analyzer reading (U in dBm). The Power of the signal generator ( $V_g$  in dBm) on the end of the cable is recorded.

EIRP (in dBm) is calculated as:  $EIRP = V_g + G$ , where G is the transmitting antenna gain (in dBi).

Conducted RF output power (in dBm) is calculated as:  $EIRP - AG$ , where AG is the gain of the transmitting antenna of the EUT (in dBi).

Test Result

1	2	3	4	5	6
<b>Frequency</b>	<b>Antenna Polarization</b>	<b>SA Reading (from EUT)</b>	<b>SG Power (to obtain the same SA reading)</b>	<b>EIRP * (EUT)</b>	<b>Conducted RF Output Power</b>
<b>MHz</b>	<b>H/V</b>	<b>dBm</b>	<b>dBm</b>	<b>dBm</b>	<b>dBm</b>
2412	V	84.6	12.5	21.2	20.2 **
2442	V	82.3	12.3	21.0	20.0 **
2462	V	82.4	11.0	19.7	18.7 **

\* Calculated as SG Power (in column 4) + substitution horn antenna gain (8.7 dBi)

\*\* Calculated for transmitter antenna gain AG=1 dBi

5.2 Radiated emission measurement  
FCC Rule: 15.247(c)

Requirement

Radiated emissions which fall in the restricted bands, must comply with the radiated emission limits specified in 15.209.

Procedure

The EUT is powered from a fully charged battery.

The measuring antenna is placed at a distance of 3 meters from the EUT. During the tests, the EUT azimuth is varied and the antenna height is adjusted from 1m – 4m in the horizontal and vertical polarization in order to identify the maximum level of emissions from the EUT.

The frequency ranges up to tenth harmonic of each of the three fundamental frequencies (low, middle, and high channels). The tests are performed with the EUT positioned in three orthogonal axes. The worst-case emissions are reported.

Test Result

The data listed on the following tables list the significant emission frequencies in the restricted bands, the limit and the margin of compliance. The EUT passed by 2.6 dB.

The data listed on the following tables were the only emissions found in the investigation up to 25 GHz. No other emissions were found above the system noise floor, which is at least 6 dB below the regulatory limit.

No emissions from the fundamental transmit frequencies were detected in the restricted bands listed in FCC section 15.205.

All radiated spurious emissions in the restricted bands, including the emissions in the adjacent channels, are below the limits listed in FCC section 15.205.

Radiated emissions in the restricted bands									
Test dates: March 8-12, 2004, Test engineer: Bruce Gordon									
Freq	Field strength	Detector	Search antenna polarization	Limit	Margin	RA	CF	AG	AF
GHz	dB(uV/m)			dB(uV/m)	dB	dB(uV/)	dB	dB	dB(1/m)
<b>Tx @ 2412 MHz</b>									
4.824	49.3	Peak	V	74	-24.7	48.7	2.7	35.9	33.8
4.824	38.3	Average	V	54	-15.7	37.7	2.7	35.9	33.8
12.06	46.1	Peak	V	74	-27.9	39.7*	4.0	37.2	39.6
12.06	35.1	Average	V	54	-18.9	28.7*	4.0	37.2	39.6
14.472	49.8	Peak	V	74	-24.2	40.3*	4.8	36.4	41.1
14.472	37.9	Average	V	54	-16.1	28.4*	4.8	36.4	41.1
19.296	57.5	Peak	V	74	-16.5	33.8*	7.4	24	40.3
19.296	48.1	Average	V	54	-5.9	24.4*	7.4	24	40.3
<b>Tx @ 2442 MHz</b>									
4.884	49.8	Peak	V	74	-24.2	48.8	2.9	35.9	34.0
4.884	41.1	Average	V	54	-12.9	40.1	2.9	35.9	34.0
7.326	43.9	Peak	V	74	-30.1	39.3	3.4	35.4	36.6
7.326	31.5	Average	V	54	-22.5	26.9	3.4	35.4	36.6
12.21	47.2	Peak	V	74	-26.8	40.7*	4.1	37.1	39.5
12.21	34.9	Average	V	54	-19.1	28.4*	4.1	37.1	39.5
19.536	58.0	Peak	V	74	-16.0	34.2*	7.5	24	40.3
19.536	47.7	Average	V	54	-6.3	23.9*	7.5	24	40.3
<b>Tx @ 2462 MHz</b>									
2484	54.2**	Peak	V	74	-19.8	29.5**	4.0	-	30.2
2484	49.9**	Average	V	54	-4.1	25.2**	4.0	-	30.2
4.924	46.0	Peak	V	74	-28.0	44.7	2.9	35.8	34.2
4.924	41.7	Average	V	54	-12.3	40.4	2.9	35.8	34.2
7.386	52.3	Peak	V	74	-21.7	47.6	3.5	35.4	36.6
7.386	42.3	Average	V	54	-11.7	37.6	3.5	35.4	36.6
12.31	47.4	Peak	V	74	-26.6	41.0*	4.1	37.1	39.4
12.31	39.9	Average	V	54	-14.1	33.5*	4.1	37.1	39.4
19.696	58.4	Peak	V	74	-15.6	34.6*	7.5	24.0	40.3
19.696	48.0	Average	V	54	-6.0	24.2*	7.5	24.0	40.3
22.158	59.3	Peak	V	74	-14.7	32.8*	10.2	24.0	40.3
22.158	47.8	Average	V	54	-6.2	21.3*	10.2	24.0	40.3

Field strength = RA (spectrum analyzer reading) + AF (search antenna correction factor) + CF (cable factor) – AG (preamplifier gain)

\* noise floor measurement

**6.0 Bluetooth tests**  
FCC Rule: 15.247

6.1 EIRP measurement

Requirement

There is no requirement for EIRP, however, as the transmitter does not have accessible antenna connector, alternative method for conducted RF power output measurement is used.

Procedure

The EUT is powered from a fully charged battery.

The EUT is placed on a non-conductive turntable, 0.8m above the ground plane, in the 10m semi-anechoic chamber.

The radiated emission at the fundamental frequency is measured at 3m distance with a receiving antenna connected to a spectrum analyzer. The emission level is maximized through the rotation of the turntable and by raising/lowering the receiving antenna from 1m to 4m. The highest spectrum analyzer reading (U in dBm) is recorded using the same setup as described in section 2.1.

EIRP is measured using the substitution method. The EUT is replaced by horn antenna connected to a signal generator. The emission level is maximized through the rotation of the turntable and the raising and lowering of the receiving antenna from 1m to 4 m. On each channel the signal generator output is adjusted to obtain the previously recorded spectrum analyzer reading (U in dBm). The Power of the signal generator ( $V_g$  in dBm) on the end of the cable is recorded.

EIRP (in dBm) is calculated as:  $EIRP = V_g + G$ , where G is the transmitting antenna gain (in dBi).

Conducted RF output power (in dBm) is calculated as:  $EIRP - AG$ , where AG is the gain of the transmitting antenna of the EUT (in dBi).

Test Result

1	2	3	4	5	6
Frequency	Antenna Polarization	SA Reading (from EUT)	SG Power (to obtain the same SA reading)	EIRP * (EUT)	Conducted RF Output Power
MHz	H/V	dBm	dBm	dBm	dBm
2402	V	85.4	13.4	22.1	21.1 **
2442	V	84.6	13.1	21.8	20.8 **
2480	V	82.4	11.5	20.2	19.2 **

\* Calculated as SG Power (in column 4) + substitution horn antenna gain (8.7 dBi)

\*\* Calculated for transmitter antenna gain AG=1 dBi

6.2 Radiated emission measurement  
FCC Rule: 15.247(c)

Requirement

Radiated emissions which fall in the restricted bands, must comply with the radiated emission limits specified in 15.209.

Procedure

The EUT is powered from a fully charged battery.

The measuring antenna is placed at a distance of 3 meters from the EUT. During the tests, the EUT azimuth is varied and the antenna height is adjusted from 1m – 4m in the horizontal and vertical polarization in order to identify the maximum level of emissions from the EUT.

The frequency ranges up to tenth harmonic of each of the three fundamental frequencies (low, middle, and high channels). The tests are performed with the EUT positioned in three orthogonal axes. The worst-case emissions are reported.

Test Result

The data listed on the following tables list the significant emission frequencies in the restricted bands, the limit and the margin of compliance. The EUT passed by 14.3 dB.

The data listed on the following tables were the only emissions found in the investigation up to 25 GHz. No other emissions were found above the system noise floor, which is at least 6 dB below the regulatory limit.

No emissions from the fundamental transmit frequencies were detected in the restricted bands listed in FCC section 15.205.

All radiated spurious emissions in the restricted bands, including the emissions in the adjacent channels, are below the limits listed in FCC section 15.205.

Radiated emissions in the restricted bands									
Test dates: March 8-12, 2004, Test engineer: Bruce Gordon									
Freq	Field strength	Detector	Search antenna polarization	Limit	Margin	RA	CF	AG	AF
GHz	dB(uV/m)			dB(uV/m)	dB	dB(uV/)	dB	dB	dB(1/m)
<b>Tx @ 2402 MHz</b>									
4.804	47.8	Peak	V	74.0	-26.2	47.2	2.7	35.9	33.8
4.804	21.0**	Average	V	54.0	-33.0	20.4**	2.7	35.9	33.8
12.010	48.5	Peak	V	74.0	-25.5	42.1*	4.0	37.2	39.6
12.010	34.4	Average	V	54.0	-19.6	28.0*	4.0	37.2	39.6
14.412	49.5	Peak	V	74.0	-24.5	40.0*	4.8	36.4	41.1
14.412	37.6	Average	V	54.0	-16.4	28.1*	4.8	36.4	41.1
19.216	57.7	Peak	V	74.0	-16.3	34.0*	7.4	24.0	40.3
19.216	47.7	Average	V	54.0	-6.3	24.0*	7.4	24.0	40.3
<b>Tx @ 2442 MHz</b>									
4.886	50.6	Peak	V	74.0	-23.4	49.6	2.9	35.9	34.0
4.886	24.5**	Average	V	54.0	-29.5	23.5**	2.9	35.9	34.0
7.329	53.4	Peak	V	74.0	-20.6	48.8	3.4	35.4	36.6
7.329	26.1**	Average	V	54.0	-27.8	21.5**	3.4	35.4	36.6
12.215	46.5	Peak	V	74.0	-27.5	40.0*	4.1	37.1	39.5
12.215	36.5	Average	V	54.0	-17.5	30.0*	4.1	37.1	39.5
19.554	57.8	Peak	V	74.0	-16.2	34.0*	7.5	24.0	40.3
19.554	47.8	Average	V	54.0	-6.2	24.0*	7.5	24.0	40.3
<b>Tx @ 2480 MHz</b>									
2483.5	65.6	Peak	V	74.0	-8.4	35.2	1.8	-	28.6
2483.5	39.1**	Average	V	54.0	-14.9	8.7**	1.8	-	28.6
4.960	52.4	Peak	V	74.0	-21.6	51.1	2.9	35.8	34.2
4.960	23.4**	Average	V	54.0	-30.6	22.1**	2.9	35.8	34.2
7.440	56.6	Peak	V	74.0	-17.4	51.9	3.5	35.4	36.6
7.440	26.7**	Average	V	54.0	-27.3	22.0**	3.5	35.4	36.6
12.400	46.4	Peak	V	74.0	-27.6	40.0*	4.1	37.1	39.4
12.400	36.4	Average	V	54.0	-17.6	30.0*	4.1	37.1	39.4
19.840	57.8	Peak	V	74.0	-16.2	34.0*	7.5	24.0	40.3
19.840	47.8	Average	V	54.0	-6.2	24.0*	7.5	24.0	40.3
22.320	59.5	Peak	V	74.0	-14.5	33.0*	10.2	24.0	40.3
22.320	46.5	Average	V	54.0	-7.5	20.0*	10.2	24.0	40.3

Field strength = RA (spectrum analyzer reading) + AF (search antenna correction factor) + CF (cable factor) – AG (preamplifier gain)

Notes: \* noise floor measurement

\*\* includes a Duty Cycle CF = 24.7 dB. The Duty Cycle CF was used for selected measurements.

See Appendix A for Duty Cycle calculation.



## 7.0 CDMA RF Modem tests

### 7.1 ERP/EIRP measurement FCC Rule: 22.913, 24.232

#### Requirement

##### FCC 22.913

The Effective Radiated Power (ERP) of mobile transmitters and auxiliary test transmitters must not exceed 7 Watts.

##### FCC 24.232

The Equivalent Isotropic Radiated Power (EIRP) must not exceed 2 Watts.

#### Procedure

The EUT is powered from a fully charged battery.

The EUT is placed on a non-conductive turntable, 0.8m above the ground plane, in the 10m semi-anechoic chamber.

The radiated emission at the fundamental frequency is measured at 3m distance with a receiving antenna connected to a spectrum analyzer. The emission level is maximized through the rotation of the turntable and by raising/lowering the receiving antenna from 1m to 4m. The highest spectrum analyzer reading (U in dBm) is recorded using the same setup as described in section 2.1.

ERP in the frequency band 824 - 849 MHz, and EIRP in the frequency band 1851.25 - 1910 MHz are measured using the substitution method. The EUT is replaced by half-wave dipole (824 - 849 MHz) or horn antenna (1851.25 - 1908.75 MHz) connected to a signal generator. The emission level is maximized through the rotation of the turntable and the raising and lowering of the receiving antenna from 1m to 4 m. On each channel the signal generator output is adjusted to obtain the previously recorded spectrum analyzer reading (U in dBm). The Power of the signal generator ( $V_g$  in dBm) on the end of the cable is recorded.

ERP/EIRP (in dBm) is calculated as:

$$\text{ERP} = V_g ; \text{EIRP} = V_g + G$$

Where G is the transmitting antenna gain (in dBi).

Result

Cellular Band					
1	2	3	4	5	6
Mode	Frequency MHz	Antenna Polarization H/V	SA Reading (average) from EUT dBm	SG Power (to obtain the same SA reading) dBm	Effective Radiated Power (EUT) dBm
CDMA	825.25	H	96.3	18.2	18.2
	836.52	H	96.7	20.3	20.3
	847.75	H	96.1	18.8	18.8
PCS Band					
Mode	Frequency MHz	Antenna Polarization H/V	SA Reading (average) from EUT dBm	SG Power (to obtain the same SA reading) dBm	Equivalent Isotropic Radiated Power * (EUT) dBm
CDMA	1851.25	V	91.9	17.4	25.0
	1880.00	V	94.1	18.9	26.5
	1908.75	V	93.5	18.5	26.1

\* Calculated as SG Power (in column 5) + substitution horn antenna gain (in dBi)

7.2 Spurious radiated emission measurement  
FCC Rule: 2.1053, 22.901(d), 24.238(a)

Requirement

The mean power of emissions must be attenuated below the mean power of the unmodulated carrier (P) on any frequency outside the frequency band by at least  $(43 + 10 \log P)$  dB.

Note: This requirement corresponds to ERP/EIRP Limit for spurious radiation as  $-13$  dBm.

Procedure

The EUT is powered from a fully charged battery.

The measuring antenna is placed at a distance of 3 meters from the EUT. During the tests, the EUT azimuth is varied and the antenna height is adjusted from 1m – 4m in the horizontal and vertical polarization in order to identify the maximum level of emissions from the EUT.

The frequency ranges up to tenth harmonic of each of the three fundamental frequencies (low, middle, and high channels) for each band (cellular and PCS) are investigated. The tests are performed with the EUT positioned in three orthogonal axes. The worst-case emissions are reported.

For spurious emissions attenuation, the substitution method is used. The EUT is substituted by a reference antenna (half-wave dipole - below 1 GHz, or Horn antenna - above 1GHz) which is connected to a signal generator (SG). The signal generator output was adjusted to obtain the same reading from the measuring antenna as from EUT. The ERP/EIRP at the spurious emissions frequency is calculated in the same manner referred to in section 7.1 of this report. The spurious emissions attenuation is calculated as the difference between ERP/EIRP at the fundamental frequency (refer to section 7.1 of this report) and at the spurious emissions frequency.

Test Result

1	2	3	4	5
Frequency	SA Reading when measured the EUT	SG Power to get the same reading	ERP/EIRP * of spurious emissions	ERP/EIRP Limit
MHz	dB(μV)	dBm	dBm	dBm
Tx at 825.25 MHz				
1650.50	46.1	-66.3	-61.3	-13.0
2475.75	38.1	-67.4	-60.6	-13.0
3301.00	50.1	-52.7	-45.1	-13.0
Tx at 836.50 MHz				
1673.00	44.5	-67.1	-62.1	-13.0
2509.60	38.3	-67.7	-60.9	-13.0
3364.12	48.0	-55.8	-48.2	-13.0
Tx at 847.75 MHz				
1695.50	47.7	-63.1	-58.1	-13.0
2543.30	40.0	-66.8	-60.0	-13.0
3391.00	48.9	-56.0	-48.4	-13.0
Tx at 1851.25 MHz				
3702.50	57.0	-45.7	-35.9	-13.0
5553.75	51.8	-48.4	-37.8	-13.0
7405.00	37.2	-64.2	-53.0	-13.0
Tx at 1880.00 MHz				
3760.00	54.6	-48.0	-38.2	-13.0
5640.00	52.0	-48.3	-37.7	-13.0
7520.00	37.1	-63.6	-52.4	-13.0
Tx at 1908.75 MHz				
3817.50	55.7	-46.8	-37.0	-13.0
5726.25	50.5	-49.8	-39.1	-13.0
7635.00	37.0	-63.0	-51.8	-13.0

\* Calculated as SG Power (in column 4) + substitution horn antenna gain (in dBd - for Cell band, or in dBi - for PCS band)

All other spurious emissions, not reported, are a noise floor.  
The EUT passed by 16 dB.

**8.0 Radiated Emissions from Digital Part and Receiver**  
 FCC Ref: 15.109

Requirement

**Radiated Emissions Limits, Section 15.109(a)**

<b>Frequency MHz</b>	<b>Class B at 3m <math>\mu\text{V/m}</math></b>	<b>Class B at 3m <math>\text{dB}(\mu\text{V/m})</math></b>
30-88	100	40
88-216	150	43.5
216-960	200	46
Above 960	500	54

Procedure

Radiated emission measurements were performed from 30 MHz to 5000 MHz. Spectrum Analyzer Resolution Bandwidth is 100 kHz or greater. See also section 4.3 for the test procedure and field strength calculation.

Result

The result is presented on the following pages.  
 The EUT passed by 10.1 dB

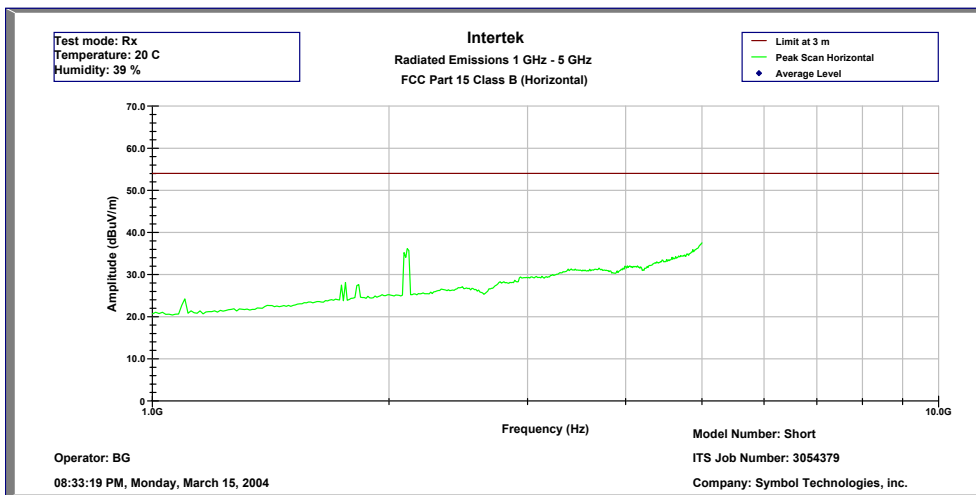
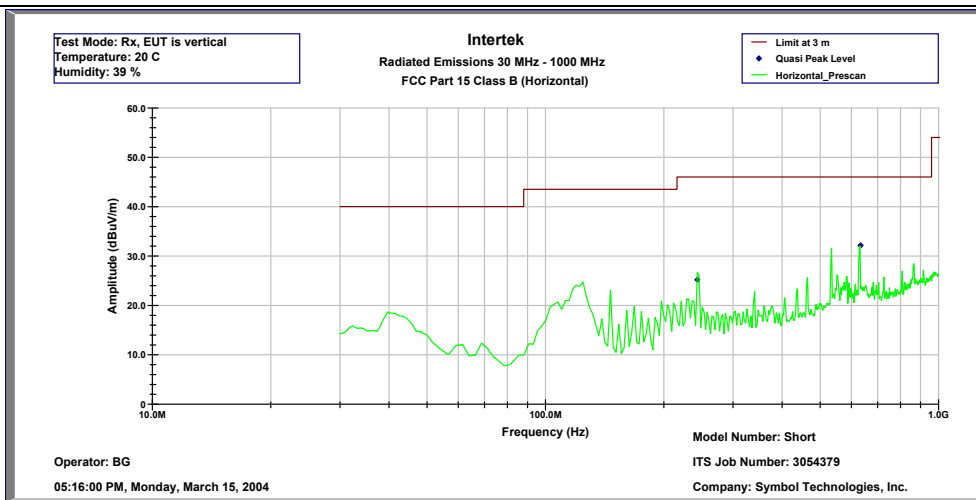

<b>Intertek</b>							
<b>Radiated Emissions 30 MHz – 5000 MHz</b>							
<b>FCC Class B (Horizontal)</b>							
<b>EUT Model Number:</b> Short				<b>ITS Job Number:</b> 3054379			
<b>Company:</b> Symbol Technologies, Inc.				<b>Test Date:</b> March 15, 2004			
<b>Operator:</b> BG							
Frequency	Quasi Pk FS	Limit@3m	Margin	RA	AG	CF	AF
MHz	dB(uV/m)	dB(uV/m)	dB	dB(uV)	dB	dB	dB(1/m)
243.57	25.2	46.0	-20.8	40.4	32.2	5.3	11.8
633.40	32.1	46.0	-13.9	37.2	32.5	6.9	20.5
<b>Test Mode:</b> Rx		<b>Temperature:</b> 20 C		<b>Humidity:</b> 39%			

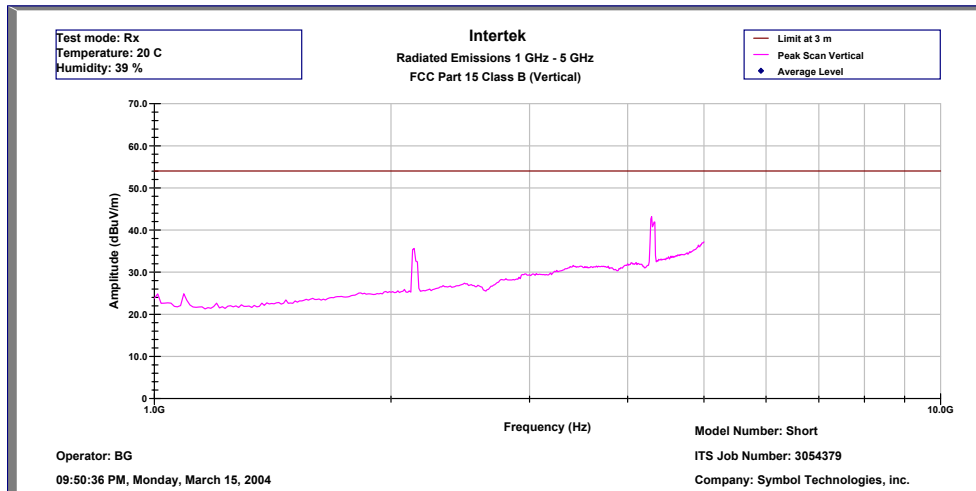
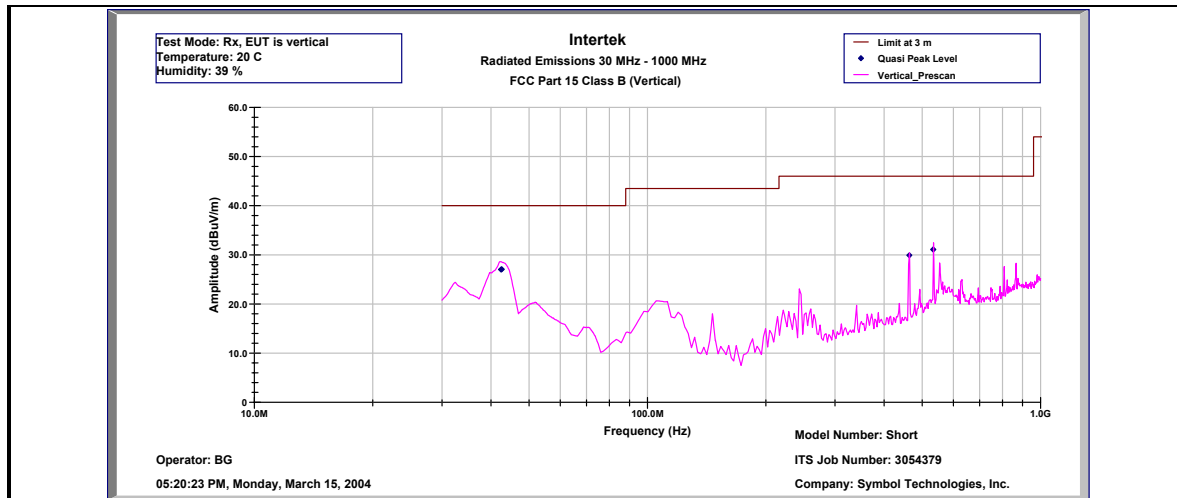

<b>Intertek</b>							
<b>Radiated Emissions 30 MHz – 5000 MHz</b>							
<b>FCC Class B (Vertical)</b>							
<b>EUT Model Number:</b> Short				<b>ITS Job Number:</b> 3054379			
<b>Company:</b> Symbol Technologies, Inc.				<b>Test Date:</b> March 15, 2004			
<b>Operator:</b> BG							
Frequency	Quasi Pk FS	Limit@3m	Margin	RA	AG	CF	AF
MHz	dB(uV/m)	dB(uV/m)	dB	dB(uV)	dB	dB	dB(1/m)
42.40	27.0	40.0	-13.0	47.5	32.4	3.9	8.0
42.60	27.1	40.0	-12.9	47.4	32.4	3.9	8.1
463.66	29.9	46.0	-16.1	38.6	32.4	6.2	17.4
533.33	31.1	46.0	-14.9	38.3	32.4	6.5	18.7
<b>Test Mode:</b> Rx		<b>Temperature:</b> 20 C		<b>Humidity:</b> 39%			

## 9.0 AC line conducted emissions

### Requirement

The following line conducted emission limits apply to Class B devices:

<b>Class B AC Line Conducted Emission</b>		
<b>Frequency band (MHz)</b>	<b>Quasi-Peak (dB<math>\mu</math>V)</b>	<b>Average (dB<math>\mu</math>V)</b>
0.15 to 0.50	66-56	56-46
0.50 to 5	56	46
5 to 30	60	50

*Note: The lower limit shall apply at the transition frequency.*

### Procedure

These measurements were performed in accordance with the test arrangements and methods defined in ANSI C63.4 and CISPR 16.

### Result

The results on the following page were obtained.  
The EUT passed by 3 dB.



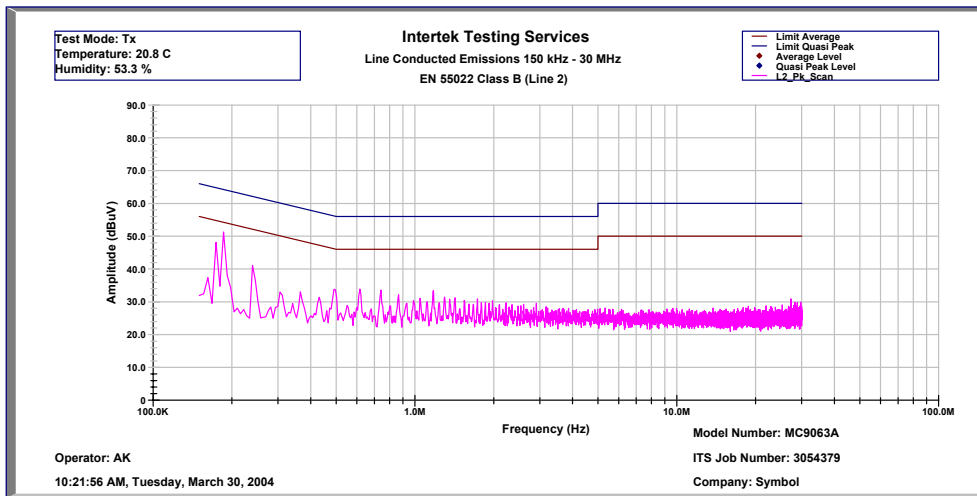
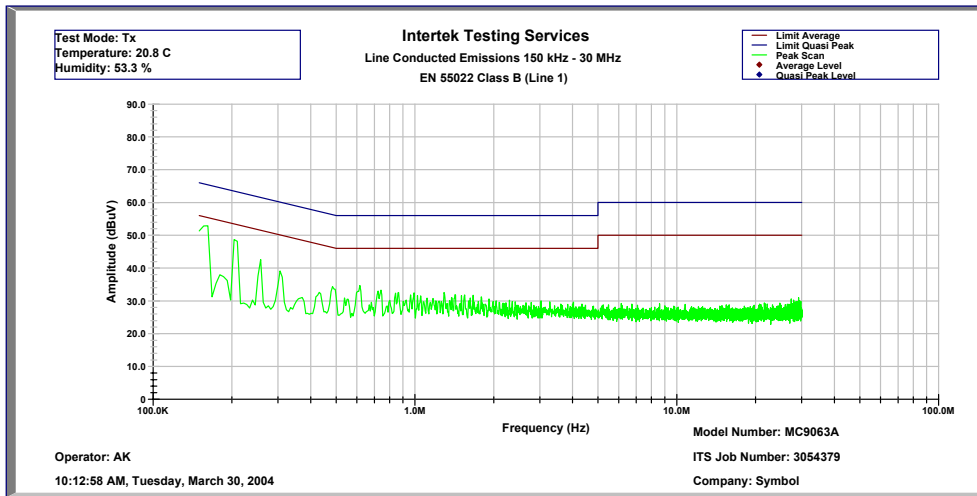

## 10.0 List of Test Equipment

Measurement equipment used for emission compliance testing utilized the equipment on the following list:

EQUIPMENT	MANUFACTURER	MODEL NUMBER	SERIAL NUMBER	CAL. INTERVAL	CAL. DUE
Spectrum Analyzer w/85650 QP Adapter	Hewlett Packard	8566B	2416A00317 2043A00251	12	10/28/04
Spectrum Analyzer	R & S	FSP40	036612004	12	2/04/05
BI-Log Antenna	EMCO	3143	9509-1160	12	3/24/04
Dipole Antenna	CDI	Roberts	331	12	9/10/04
Horn Antenna	EMCO	3115	8812-3049	12	4/08/04
Horn Antenna #8	EMCO	3115	9170-3712	12	7/05/04
Horn Antenna	EMCO	3160-09	Not Labeled	#	#
Pre-Amplifier	Miteq	AMF-4D-001180-24-10P	799159	12	4/06/04
Pre-Amplifier	Avantek	AFT-18855	8723H705	12	4/10/04
Pre-amplifier	CTT	ACO/400	47526	12	4/10/04

# No Calibration required

**10.0 Document History**

<b>Revision/ Job Number</b>	<b>Writer Initials</b>	<b>Date</b>	<b>Change</b>
1.0 / 3054379	DC	March 19, 2003	Original document

## Appendix A – Duty Cycle Calculation for BT module

The test mode being used for BT emissions is the DH5 Packet on a fixed channel.

In accordance with FCC Public Notice DA 00-705, Released 30th March 2003, Section 15.247(c) Spurious Radiated Emissions, if the dwell time per channel of the hopping signal is less than 100ms, then the reading obtained with the 10Hz VBW may be further adjusted by a duty cycle correction factor, derived from  $20\log(\text{dwell time}/100\text{ms})$ .

In an effort to demonstrate compliance with the 15.209 limit, the following adjustment has been calculated for use with Average Measurements only:

Dwell Time = 5.81 ms this is derived from:

Total slot time per time slot for DH5 packet  $625\mu\text{s} \times 5 = 3.125 \text{ ms}$

Actual transmit time during this time slot is 2.905 ms and the reply time slot after each DH5 packet is 625  $\mu\text{s}$ .

Total time slot length per channel  $3.125 + 0.625 = 3.75 \text{ ms}$ .

Multiply Total time slot length per channel by 32 channels per hop sequence  $32 \times 3.75 = 120 \text{ ms}$

It is therefore possible to have a maximum of two hop sequences in any given 100 ms period, a single channel could occur twice within any 100ms time window;  $2 \times 2.905 = 5.81 \text{ ms}$

Therefore; the Bluetooth Duty Cycle Correction Factor for the EUT is  $20\text{Log}(5.81/100) = -24.7\text{dB}$

This correction factor may be applied to all Average Measurements related to the FH signal.