REPORT ON

The Specific Absorption Rate Assessment Of The Symbol MC9050 Mobile Computer.

Report Number: WS611296 – 01 issue 3

August 2003

REPORT ON: The Specific Absorption Rate Assessment Of The
Symbol MC9050 Mobile Computer

Report No: WS611296 – 01 issue 3

FCC ID: H9PMC9050

PREPARED FOR: Symbol Technologies Inc
One Symbol Plaza
Holtsville
NY 11742-1300

ATTESTATION: The wireless portable device described within this report have been shown to be capable of compliance for localised specific absorption rate (SAR) for General Population/Uncontrolled Exposure Limits as defined in the European standard EN50361: 2002 of 2.0W/kg, FCC standard Supplement C (Edition 01-01) to OET Bulletin 65 (Edition 97-01) and RSS-102 Issue 1 (Provisional) September 25, 1999 of 1.6 W/kg.

The devices were tested in accordance with the measurement procedures specified in European standard EN50361: 2002, Supplement C (Edition 01-01) to OET Bulletin 65 (Edition 97-01), RSS-102 Issue 1 (Provisional) September 25 and IEEE1528-200x (Draft December 2002).

I attest to the accuracy of data. All measurements reported herein were performed by me or were made under my supervision and are correct to the best of my knowledge and belief. I assume full responsibility for the completeness of these measurements.



A. Miller
Senior SAR Test Engineer

APPROVED BY:

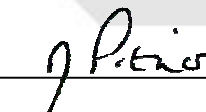

TJ PITHER
Quality Manager

DATED: 19th August 2003

DISTRIBUTION:	Symbol Technologies Inc	Copy No: 1
	Symbol Technologies Inc (CD ROM).	Copy No(s): 2
	BABT	Copy No.: 3
		Copy No.: 1

Note: The test results reported herein relate only to the item tested as identified above and on the Status Page.

This report has been reissued due to typographical errors



CONTENTS

EXECUTIVE SUMMARY	3
1.1 Status	4
1.2 Summary	5
1.3 Test Result Summary	6
TEST DETAILS	8
2.1 Test Equipment	9
2.2 Test Software	9
2.3 Dielectric Properties of Simulant Liquids	10
2.4 Test Conditions	11
2.5 Measurement Uncertainty	11
2.6 SAR Measuring System Probe and Amplifier Specification Probe Calibration SAR Measurement Procedure	12
2.7 OET65(c) Flat Phantom Test Position – Graphical Representation	30
2.8 SAR Distributions (Area Scans – 2D)	34
2.9 Test Positional Photographs	42
2.10 Record Photographs	43

For copyright details see page 0 of 0.



EXECUTIVE SUMMARY

The Specific Absorption Rate Assessment Of The
Symbol MC9050 Mobile Computer.

PROJECT MANAGER: M. GLASSPOOL



1.1 STATUS

MANUFACTURING DESCRIPTION	Mobile Computer
STATUS OF TEST	Specific Absorption Rate Testing
APPLICANT	Symbol Technologies Inc
MANUFACTURER	Symbol Technologies Inc
TYPE	MC9050
MODEL NUMBER	MC9050-GJOJAEB2WW
SERIAL NUMBER	ALP68681
HARDWARE VERSION	Rev 1
RADIO LAN	Symbol Compact Flash Card
	2.4GHz Direct Spread Spectrum
TYPE	LA-4137
POWER	+17dBm
RADIO BLUETOOTH	Symbol Bluetooth Module
TYPE	21-58466
POWER	0 (Zero) dBm (Class 1)
BATTERY MANUFACTURER	Symbol Technologies Inc
TYPE OR MODEL NUMBER	21-61261-01

TEST SPECIFICATIONS:

Federal Communications Commission, Code of Federal Regulations, Title 47 (CFR47), Vol. 1, Chapter 1, Part 2 (§2.1091 and §2.1093).

Federal Communications Commission (FCC) OET Bulletin 65c, Edition 01-01, Evaluating Compliance with FCC Guidelines for Human Exposure to Radiofrequency Electromagnetic Fields – Additional Information for Evaluating Compliance of Mobile and Portable Devices with FCC Limits for Human Exposure to Radiofrequency Emissions

CENELEC EN 50360: July 2001, Product Standard to demonstrate the compliance of mobile phones with the basic restrictions related to human exposure electromagnetic (300 MHz - 3 GHz).

CENELEC EN 50361: July 2001, Basic standard for the measurement of Specific Absorption Rate related to human exposure to electromagnetic fields from mobile phones (300 MHz - 3 GHz).

RSS-102 Issue 1 (Provisional) September 25, 1999: Evaluation Procedure for Mobile and Portable Radio Transmitters with respect to Health Canada's Safety Code 6 for Exposure of Humans to radio Frequency Fields

REFERENCES:

IEEE 1528 –200X: DRAFT Recommended Practice for Determining the Peak Spatial-Average Specific Absorption Rate (SAR) in the Human Body Due to Wireless Communications Devices: Experimental Techniques

Council Recommendations 1999/519/EC on the limitations of exposure of the general public to electromagnetic fields (0 Hz - 3 GHz) annex II.

BABT REGISTRATION NUMBER:	OR611296/01.
RECEIPT OF TEST SAMPLES:	23 rd June 2003.
START OF TEST:	01 st July 2003.
FINISH OF TEST:	23 rd July 2003.



1.2 SUMMARY

The unit supplied for testing is a MC9050 Mobile Computer, which offers 2.4GHz 802.11b Wireless LAN and Bluetooth connectivity.

The Mobile Computer utilizes the approved LA-4137 Symbol Compact Flash 802.11b RLAN radio card and the 21-58466 Symbol Bluetooth module.

SAR testing was first performed with the Compact Flash 802.11b RLAN radio card set to a CW test signal and then placed against a Flat Phantom dimensions 220mmx200mmx150mm and with a sidewall thickness of 2.0mm. The phantom was filled to a depth of 150mm with 2450MHz Body simulant liquid. The dielectric properties were in accordance with the requirements for the dielectric properties specified in Supplement C (Edition 01-01) to OET Bulletin 65 (Edition 97-01).

An initial investigation using a measurement probe to establish where the transmitter was positioned and the position giving the maximum energy was carried out. SAR testing was then performed initially using the middle channel of the operating bands. The left hand side of the device was first placed against the side of the flat phantom and was in contact. Then the top side of the device was placed against the side of the flat phantom and was in contact.

A SAR test performed with the left hand side of the device positioned in contact against the side of the flat phantom. The device was set to channel 1 (2412MHz). The 1g SAR value of 2.037 W/kg was recorded, this exceeds the limit of 1.6 W/kg. The client requested a separation distance of 1.0 cm from the left hand side of the device when placed against the side of the flat phantom. The assessment was completed with this distance set for all channels.

The Symbol MC9050 had an integral antenna so that the requirement for testing with antenna extended and retracted was not applicable. The testing was performed with a fully charged battery for the positions for which higher SAR levels were recorded.

The device was then placed into the RLAN mode using onboard software supplied by the client, which enabled the device to be placed into a CW test mode. Maximum power level setting as defined by the client was achieved by setting 169 as the power level setting. The channels 1, 6 & 11 were selected in turn and the maximum SAR levels recorded

The Bluetooth module was activated using onboard software in a CW test mode. The Bluetooth module is a Class 1 device, max 1mW (0dBm) power output. SAR scans were performed, at the clients request, at the top, centre and bottom frequencies 2402, 2441 and 2480MHz and no SAR values were recorded above Noise floor levels. No Bluetooth SAR Plots are included in this report.

Co-Location, this unit is designed to operate in co-located mode; with the LA-4137 Symbol Compact Flash 802.11b RLAN radio card and the Bluetooth module operating simultaneously. No SAR scans were carried out with the unit in this mode due to no SAR values being recorded above Noise floor levels for the bluetooth module.

Note: for Body worn operation, the MC9050 is a Mobile Computer has been tested and meets the FCC RF exposure guidelines when used with an accessory which contains no metal and that positions these devices a minimum of 1.0cm from the body. Use of other accessories may not ensure compliance with FCC RF guidelines.

Included in this report are descriptions of the test method; the equipment used and an analysis of the test uncertainties applicable and diagrams indicating the locations of maximum SAR for each test position along with photographs indicating the positioning of the handset against the flat phantom, as appropriate,

The maximum 10g volume averaged SAR level measured for all the tests performed did not exceed the 2 W/kg level defined for limiting the exposure of the general population to time-varying electric and magnetic fields by ICNIRP (1998), which is the relevant Standard for testing according to the CENELEC EN50361 test method.

The maximum 1g volume averaged SAR level measured for all the tests performed did not exceed the limits for General Population/Uncontrolled Exposure (W/kg) Partial Body of 1.6 W/kg. Level defined in Supplement C (Edition 01-01) to OET Bulletin 65 (97-01), when a minimum separation distance of 1.0cm from the left hand side of the device to the body is maintained.



1.3 TEST RESULT SUMMARY

SYSTEM PERFORMANCE / VALIDATION CHECK RESULTS

Prior formal to formal testing being performed a System Check was performed in accordance with Appendix D IEEE1528 April 4th 2002 Draft Standard. The following results were obtained: -

Dipole Used	Frequency (MHz)	Max 1g SAR (W/kg)*	Percentage Drift on 1g Reference	Max 10g SAR (W/kg)*	Percentage Drift on 10g Reference
2450	2450	51.2*	-2.3%	23.92*	-0.34%

*Normalised to 1W

OUTPUT POWER OF TEST DEVICE MEASUREMENT METHOD – For the Symbol MC9050 Mobile Computer

The Spectrum Analyser was tuned to the test frequency. The device Output power setting was controlled via the ‘Test Mode’ on each handset being set to the conditions specified in the Summary on page 5 of this document. The device was then rotated through 360 degrees until the highest power level was observed in both planes of polarisation. The device was then replaced with a substitution antenna, the signal to the antenna was adjusted to equal the related level detected from the device.

MAXIMUM POWER – Recorded from the Symbol MC9050 Mobile Computer

Radio Device	Frequency (MHz)	Raw Result (dBm)	Substitution Level (dBm)	Cable Loss (dB)	Substitution Antenna Gain (dB)	Result ERP (dBm)	Result ERP (mW)
RLAN	2412	-26.80	14.10	-5.00	7.78	16.88	48.75
RLAN	2437	-26.93	14.10	-4.89	7.92	17.13	51.64
RLAN	2462	-26.55	14.40	-4.89	8.06	17.57	57.15
Bluetooth	2402	-46.17	-34.80	-4.68	7.73	-31.75	0.0007
Bluetooth	2441	-40.42	-29.70	-5.00	7.95	-26.75	0.0020
Bluetooth	2480	-43.70	-31.60	-4.79	8.17	-28.22	0.0015



1.3 TEST RESULT SUMMARY - Continued

MAXIMUM SAR VALUES

The following is a summary of the maximum SAR values found during the assessment.

DSS 2450 MHz Specific Absorption Rate (Maximum SAR) 1g & 10g Results for Symbol MC9050 placed against the Flat Phantom (Body SAR) with a separation distance of 0.0mm

Position	Channel Number	Frequency (MHz)	Max Spot (W/kg)	Max 1g SAR (W/kg)	Max 10g SAR (W/kg)	Area scan (Figure number)
Phantom: 2mm Side Device: Touch – Left Hand side	6	2437	1.03	0.727	0.282	Figure 18
Phantom: 2mm Side Device: Touch – LCD side	6	2437	0.60	0.418	0.183	Figure 19
Phantom: 2mm Side Device: Touch – End –on	6	2437	0.02	0.014	0.009	Figure 20
Phantom: 2mm Side Device: Touch – Left Hand side	1	2412	3.12	2.037*	0.789	Figure 21
Limit for General Population (Uncontrolled Exposure) 1.6 W/kg (1g) & 2.0 W/kg (10g)						

*Client requested a 1.0cm separation distance from side of flat phantom for the completion of the assessment, see below for the results.

DSS 2450 MHz Specific Absorption Rate (Maximum SAR) 1g & 10g Results for Symbol MC9050 placed against the Flat Phantom (Body SAR) with a separation distance of 10 mm.

Position	Channel Number	Frequency (MHz)	Max Spot (W/kg)	Max 1g SAR (W/kg)	Max 10g SAR (W/kg)	Area scan (Figure number)
Phantom: 2mm Side Device: 10mm Gap – Left Hand side	1	2412	0.71	0.527	0.236	Figure 22
Phantom: 2mm Side Device: 10mm Gap – Left Hand side	6	2437	0.80	0.585	0.261	Figure 23
Phantom: 2mm Side Device: 10mm Gap – Left Hand side	11	2462	0.85	0.646	0.287	Figure 24
Phantom: 2mm Side Device: 10mm Gap – Left Hand side	13	2472	0.99	0.755	0.334	Figure 25
Limit for General Population (Uncontrolled Exposure) 1.6 W/kg (1g) & 2.0 W/kg (10g)						



TEST DETAILS

The Specific Absorption Rate Assessment Of The
Symbol MC9050 Mobile Computer

TEST ENGINEERS: A. MILLER



2.1 TEST EQUIPMENT

The following test equipment was used at BABT:

INSTRUMENT DESCRIPTION	MANUFACTURER	MODEL TYPE	INVENTORY NO.	SERIAL NUMBER	CALIBRATION DATES
Bench-top Robot	Mitsubishi	RV-E2	4691	EA009006	N/A
2450 MHz – Head Tissue Simulant	BABT	Head	N/A	Batch 4	14/07/03*
2450 MHz – Body Tissue Simulant	BABT	Body	N/A	Batch 1	14/07/03*
2450 MHz Calibration Dipole	BABT	IEEE1528	A	N/A	15/01/03
RF Amplifier	Vectawave	10M-2.5G	4697	N/A	N/A
Directional Coupler	Krytar	1850	4651	N/A	TU
20dB Attenuator	Narda	766F-10	EMC 1791	1791	24/05/04 (due)
Power Meter	Rohde Schwarz	NRV	2472	860327/025	24/05/04 (due)
Hygrometer	Rotronic	I-1000	3230	N/A	02/10/03 (due)
Digital Thermometer	Digitron	T208	3178	N/A	24/08/03 (due)
Thermocouple	RS	219-4539	4859	N/A	24/08/03 (due)
SAR Probe	IndexSAR	IXP-050	N/A	84	18/03/04 (due)
Flat Phantom box 2mm side(200mm cube)	IndexSAR.	N/A	N/A	N/A	N/A

* Verified at time of test.

2.2 TEST SOFTWARE

The following software was used to control the BABT SARA2 System:

INSTRUMENT	VERSION NO.	DATE
SARA2 system	v.0.281	023/07/2002
Mitsubishi robot controller firmware revision	RV-E2 Version C9a	-
IXA-10 Probe amplifier	Version 2.5	-



2.3 DIELECTRIC PROPERTIES OF SIMULANT LIQUIDS

The dielectric properties of the tissue simulant liquids used for the SAR testing at BABT are as follows:-

FLUID TYPE AND FREQUENCY	RELATIVE PERMITTIVITY ϵ_r (e') TARGET	RELATIVE PERMITTIVITY ϵ_r (e') MEASURED	CONDUCTIVITY σ TARGET	CONDUCTIVITY σ MEASURED
Head 2450MHz	39.2	37.46	1.80 S/m	1.893
Body 2450MHz	52.7	51.95	1.95 S/m	2.031

Fluid Mass Density, $\rho = 1000 \text{ kg/m}^3$

The fluids were calibrated in our Laboratory and re-checked prior to any measurements being made against reference fluids stated in IEEE 1528-200X of 0.9% NaCl (Salt Solution) at 20°C and also for Dimethylsulphoxide (DMS) at 20°C.

The fluids were made at BABT under controlled conditions from the following OET(65)c formulae and reference made to Draft Standard IEEE1528-200x. The composition of ingredients may have been modified accordingly to achieve the desired target tissue parameters required for routine SAR evaluation:

Ingredients (% by weight)	Frequency (MHz)									
	450		835		915		1900		2450	
Tissue Type	Head	Body	Head	Body	Head	Body	Head	Body	Head	Body
Water	38.56	51.16	41.45	52.4	41.05	56.0	54.9	40.4	62.7	73.2
Salt (NaCl)	3.95	1.49	1.45	1.4	1.35	0.76	0.18	0.5	0.5	0.04
Sugar	56.32	46.78	56.0	45.0	56.5	41.76	0.0	58.0	0.0	0.0
HEC	0.98	0.52	1.0	1.0	1.0	1.21	0.0	1.0	0.0	0.0
Bactericide	0.19	0.05	0.1	0.1	0.1	0.27	0.0	0.1	0.0	0.0
Triton X-100	0.0	0.0	0.0	0.0	0.0	0.0	0.0	0.0	36.8	0.0
DGBE	0.0	0.0	0.0	0.0	0.0	0.0	44.92	0.0	0.0	26.7
Dielectric Constant	43.42	58.0	42.54	56.1	42.0	56.8	39.9	54.0	39.8	52.5
Conductivity (S/m)	0.85	0.83	0.91	0.95	1.0	1.07	1.42	1.45	1.88	1.78



2.4 TEST CONDITIONS

Ambient Temperature: Within +15°C to +35°C at 20% RH to 75% RH.

The actual Temperature during the testing ranged from 21.6°C to 23.2°C.

The actual Humidity during the testing ranged from 43.0% to 64.9% RH.

Tissue simulating liquid temperature: +20°C to +25°C.

The actual tissue simulating liquid temperature was recorded as min 21.6°C and max 23.5°C

SAR Drift in during scans. The maximum SAR Drift, drift due to the mobile phone electronics, was recorded as -0.162 dB all of the testing.

2.5 MEASUREMENT UNCERTAINTY

ERROR SOURCES	EN 50361 Description (Subclause)	Uncertainty (%)	Probability Distribution	Divisor	ci	ci ²	Standard Uncertainty (%)	Stand Uncert ²	(Stand Uncert ²) X (ci ²)
Measurement Equipment									
Calibration	7.2.1.1	10	Normal	2.00	1	1	5.00	25.00	25.00
Isotropy	7.2.1.2	10.6	Rectangular	1.73	1	1	6.12	37.45	37.45
Linearity	7.2.1.3	2.92	Rectangular	1.73	1	1	1.69	2.84	2.84
Probe Stability	-	2.46	Rectangular	1.73	1	1	1.42	2.02	2.02
Detection limits	7.2.1.4	0	Rectangular	1.73	1	1	0.00	0.00	0.00
Boundary effect	7.2.1.5	1.7	Rectangular	1.73	1	1	0.98	0.96	0.96
Measurement device	7.2.1.6	0	Normal	1.00	1	1	0.00	0.00	0.00
Response time	7.2.1.7	0	Normal	1.00	1	1	0.00	0.00	0.00
Noise	7.2.1.8	0	Normal	1.00	1	1	0.00	0.00	0.00
Integration time	7.2.1.9	2.3	Normal	1.00	1	1	2.30	5.29	5.29
Mechanical constraints									
Scanning system	7.2.2.1	0.57	Rectangular	1.73	1	1	0.33	0.11	0.11
Phantom shell	7.2.2.2	1.43	Rectangular	1.73	1	1	0.83	0.68	0.68
Matching between probe and phantom	7.2.2.3	2.86	Rectangular	1.73	1	1	1.65	2.73	2.73
Positioning of the phone 'Y' Co-ordinate	7.2.2.4	1.5	Normal	1.00	1	1	1.50	2.25	2.25
Positioning of the phone 'Z' Co-ordinate	7.2.2.4	1.73	Normal	1.00	1	1	1.73	2.99	2.99
Physical Parameters									
Liquid conductivity (deviation from target)	7.2.3.2	5	Rectangular	1.73	0.5	0.25	2.89	8.33	2.08
Liquid conductivity (measurement error)	7.2.3.2	5	Rectangular	1.73	0.5	0.25	2.89	8.33	2.08
Liquid permittivity (deviation from target)	7.2.3.3	5	Rectangular	1.73	0.5	0.25	2.89	8.33	2.08
Liquid permittivity (measurement error)	7.2.3.3	5	Rectangular	1.73	0.5	0.25	2.89	8.33	2.08
Drifts in output power of the phone, probe, temperature and humidity	7.2.3.4	5	Rectangular	1.73	1	1	2.89	8.33	8.33
Perturbation by the environment	7.2.3.5	3	Rectangular	1.73	1	1	1.73	3.00	3.00
Post-Processing									
SAR interpolation and extrapolation	7.2.4.1	2.4	Rectangular	1.73	1	1	1.39	1.92	1.92
Maximum SAR evaluation	7.2.4.2	2.4	Rectangular	1.73	1	1	1.39	1.92	1.92
Combined standard uncertainty	10.29						Total		105.83
Expanded uncertainty = 20.57 % (Using a Coverage Factor of K=2) (confidence interval of 95 %)									



2.6 SAR MEASUREMENT SYSTEM

ROBOT SYSTEM SPECIFICATION

The SAR measurement system being used is the IndexSAR SARA2 system, which consists of a Mitsubishi RV-E2 6-axis robot arm and controller, IndexSAR probe and amplifier and SAM phantom Head Shape. The robot is used to articulate the probe to programmed positions inside the phantom head to obtain the SAR readings from the DUT.

The system is controlled remotely from a PC, which contains the software to control the robot and data acquisition equipment. The software also displays the data obtained from test scans.

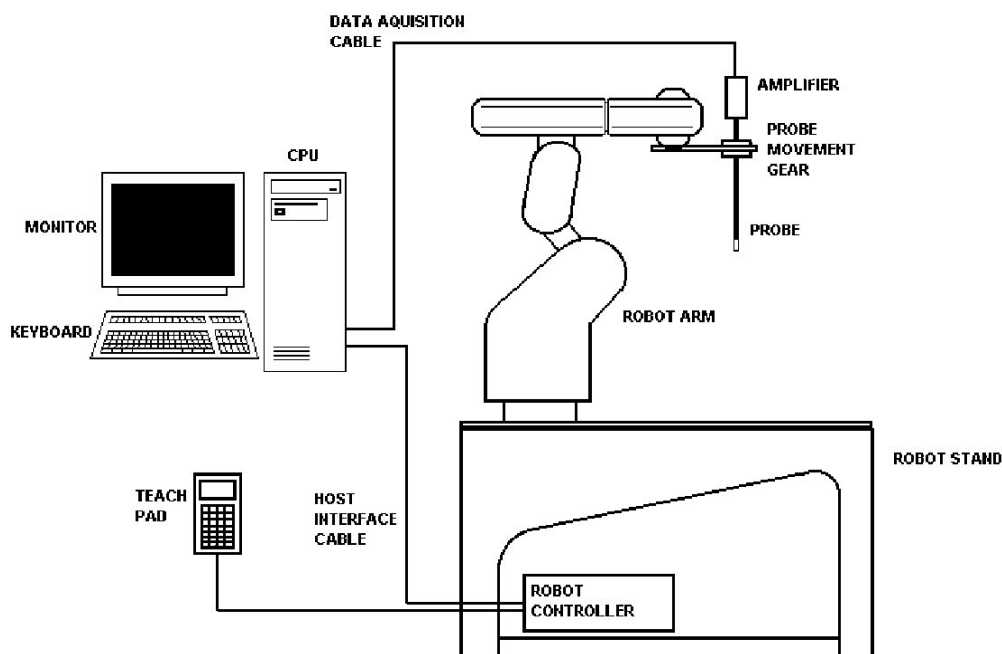

Figure 1: Schematic diagram of the SAR measurement system

The position and digitised shape of the phantom heads are made available to the software for accurate positioning of the probe and reduction of set-up time.

The SAM phantom heads are individually digitised using a Mitutoyo CMM machine to a precision of 0.001mm. The data is then converted into a shape format for the software, providing an accurate description of the phantom shell.

In operation, the system first does an area (2D) scan at a fixed depth within the liquid from the inside wall of the phantom. When the maximum SAR point has been found, the system will then carry out a 3D scan centred at that point to determine volume averaged SAR level.



2.6 SAR MEASUREMENT SYSTEM

PROBE AND AMPLIFIER SPECIFICATION

IXP-050 Indexsar isotropic immersible SAR probe

The probes are constructed using three orthogonal dipole sensors arranged on an interlocking, triangular prism core. The probes have built-in shielding against static charges and are contained within a PEEK cylindrical enclosure material at the tip. Probe calibration is described in the following section.

IXP-039 Amplifier

The amplifier unit has a multi-pole connector to connect to the probe and a multiplexer selects between the 3-channel single-ended inputs. A 16-bit AtoD converter with programmable gain is used along with an on-board micro-controller with non-volatile firmware. Battery life is around 150 hours and data are transferred to the PC via 3m of duplex optical fibre and a self-powered RS232 to optical converter.

Phantoms

The Specific Anthropomorphic Mannequin (SAM) Upright Phantom is fabricated using moulds generated from the CAD files as specified by CENELEC EN50361. It is mounted via a rotation base to a supporting table, which also holds the robotic positioner. The phantom and robot alignment is assured by both mechanical and laser registration systems.



2.6 SAR MEASUREMENT SYSTEM

PROBE CALIBRATION PROCEDURE

EQUIPMENT USED

For the first part of the characterisation procedure, the probe is placed in an isotropy measurement jig as pictured in Figure 2. In this position the probe can be rotated about its axis by a non-metallic belt driven by a stepper motor.

The probe is attached via its amplifier and an optical cable to a PC. A schematic representation of the test geometry is illustrated in Figure 3.

A balanced dipole (900 MHz) is inserted horizontally into the bracket attached to a second belt (Figure 2). The dipole can also be rotated about its axis. A cable connects the dipole to a signal generator, via a directional coupler and power meter. The signal generator feeds an RF amplifier at constant power, the output of which is monitored using the power meter. The probe is positioned so that its sensors line up with the rotation center of the source dipole. By recording output voltage measurements of each channel as both the probe and the dipole are rotated, data are obtained from which the spherical isotropy of the probe can be optimised and its magnitude determined.

The calibration process requires E-field measurements to be taken in air, in 900 MHz simulated brain liquid and at other frequencies/liquids as appropriate.

LINEARISING PROBE OUTPUT

The probe channel output signals are linearised in the manner set out in Refs [1] and [2]. The following equation is utilized for each channel:

$$U_{lin} = U_{o/p} + U_{o/p}^2 / DCP \quad (1)$$

where U_{lin} is the linearised signal, $U_{o/p}$ is the raw output signal in voltage units and DCP is the diode compression potential in similar voltage units.

DCP is determined from fitting equation (1) to measurements of U_{lin} versus source feed power over the full dynamic range of the probe. The DCP is a characteristic of the schottky diodes used as the sensors. For the IXP-050 probes with CW signals the DCP values are typically 0.10V (or 20 in the voltage units used by Indexsar software, which are $V*200$).

SELECTING CHANNEL SENSITIVITY FACTORS TO OPTIMISE ISOTROPIC RESPONSE

The basic measurements obtained using the calibration jig (Fig 2) represent the output from each diode sensor as a function of the presentation angle of the source (probe and dipole rotation angles). The directionality of the orthogonally-arranged sensors can be checked by analysing the data using dedicated Indexsar software, which displays the data in 3D format as in Figure 4. The left-hand side of this diagram shows the individual channel outputs after linearisation (see above). The program uses these data to balance the channel outputs and then applies an optimisation process, which makes fine adjustments to the channel factors for optimum isotropic response.



2.6 SAR MEASUREMENT SYSTEM

PROBE CALIBRATION PROCEDURE - Continued

The next stage of the process is to calibrate the Indexsar probe to a W&G EMR300 E-field meter in air. The principal reasons for this are to obtain conversion factors applicable should the probe be used in air and to provide an overall measure of the probe sensitivity.

A multiplier is applied to factors to bring the magnitudes of the average E-field measurements as close as possible to those of the W&G probe.

The following equation is used (where linearised output voltages are in units of V*200):

$$E_{\text{air}}^2 \text{ (V/m)} = U_{\text{linx}} * \text{Air Factor}_x + U_{\text{liny}} * \text{Air Factor}_y + U_{\text{linz}} * \text{Air Factor}_z \quad (2)$$

It should be noted that the air factors are not separately used for normal SAR testing. The IXP-050 probes are optimised for use in tissue-simulating liquids and do not behave isotropically in air.

900 MHz LIQUID CALIBRATION

Conversion factors for use when the probes are immersed in tissue-simulant liquids at 900 MHz are determined either using a waveguide or by comparison to a reference probe that has been calibrated by NPL. Waveguide procedures are described later. The summary sheet indicates the method used for the probe S/N 0084.

The conversion factor, referred to as the 'liquid factor' is also applied to the measurements of each channel. The following equation is used (where output voltages are in units of V*200):

$$E_{\text{liq}}^2 \text{ (V/m)} = U_{\text{linx}} * \text{Air Factor}_x * \text{Liq Factor}_x + U_{\text{liny}} * \text{Air Factor}_y * \text{Liq Factor}_y + U_{\text{linz}} * \text{Air Factor}_z * \text{Liq Factor}_z \quad (3)$$

A 3D representation of the spherical isotropy for probe S/N 0084 using these factors is shown in Figure 4

The rotational isotropy can also be determined from the calibration jig measurements and is reported as the 900MHz isotropy in the summary table. Note that waveguide measurements can also be used to determine rotational isotropy (Fig. 6).

The design of the cells used for determining probe conversion factors are waveguide cells is shown in Figure 5. The cells consist of a coax to waveguide transition and an open-ended section of waveguide containing a dielectric separator. Each waveguide cell stands in the upright position and is filled with liquid within 10 mm of the open end. The separator provides a liquid seal and is designed for a good electrical transition from air filled guide to liquid filled guide. The choice of cell depends on the portion of the frequency band to be examined and the choice of liquid used. The depth of liquid ensures there is negligible radiation from the waveguide open top and that the probe calibration is not influenced by reflections from nearby objects. The return loss at the coaxial connector of the filled waveguide cell is measured initially using a network analyser and this information is used subsequently in the calibration procedure. The probe is positioned in the centre of the waveguide and is adjusted vertically or rotated using stepper motor arrangements. The signal generator is connected to the waveguide cell and the power is monitored with a coupler and a power meter. A fuller description of the waveguide method is given below.



2.6 SAR MEASUREMENT SYSTEM

PROBE CALIBRATION PROCEDURE - Continued

The liquid dielectric parameters used for the probe calibrations are listed in the Tables below. The final calibration factors for the probe are listed in the summary chart.

WAVEGUIDE MEASUREMENT PROCEDURE

The calibration method is based on setting up a calculable specific absorption rate (SAR) in a vertically-mounted WG8 (R22) waveguide section [1]. The waveguide has an air-filled, launcher section and a liquid-filled section separated by a matching window that is designed to minimise reflections at the liquid interface. A TE_{01} mode is launched into the waveguide by means of a N-type-to-waveguide adapter. The power delivered to the liquid section is calculated from the forward power and reflection coefficient measured at the input to the waveguide. At the centre of the cross-section of the waveguide, the local spot SAR in the liquid as a function of distance from the window is given by functions set out in IEEE1528 as below:

Because of the low cutoff frequency, the field inside the liquid nearly propagates as a TEM wave. The depth of the medium (greater than three penetration depths) ensures that reflections at the upper surface of the liquid are negligible. The power absorbed in the liquid is determined by measuring the waveguide forward and reflected power. Equation (4) shows the relationship between the SAR at the cross-sectional center of the lossy waveguide and the longitudinal distance (z) from the dielectric separator

$$SAR(z) = \frac{4(P_f - P_b)}{\rho ab \delta} e^{-2z/\delta} \quad (4)$$

where the density ρ is conventionally assumed to be 1000 kg/m^3 , ab is the cross-sectional area of the waveguide, P_f and P_b are the forward and reflected power inside the lossless section of the waveguide, respectively. The penetration depth δ , which is the reciprocal of the waveguide-mode attenuation coefficient, is determined from a scan along the z -axis and compared with the theoretical value determined from Equation (5) using the measured dielectric properties of the lossy liquid.

$$\delta = \left[\text{Re} \left\{ \sqrt{(\pi/a)^2 + j\omega\mu_o(\sigma + j\omega\epsilon_o\epsilon_r)} \right\} \right]^{-1} \quad (5)$$

Table A.1 of [1] can be used for designing calibration waveguides with a return loss greater than 30 dB at the most important frequencies used for personal wireless communications. Values for the penetration depth for these specific fixtures and tissue-simulating mixtures are also listed in Table A.1.

According to [1], this calibration technique provides excellent accuracy, with standard uncertainty of less than 3.6% depending on the frequency and medium. The calibration itself is reduced to power measurements traceable to a standard calibration procedure. The practical limitation to the frequency band of 800 to 2500 MHz because of the waveguide size is not severe in the context of compliance testing.

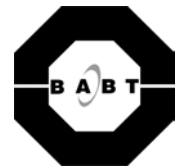

2.6 SAR MEASUREMENT SYSTEM

PROBE CALIBRATION PROCEDURE - Continued

CALIBRATION FACTORS MEASURED FOR PROBE S/N 0084

The probe was calibrated at 900, 1800, 1900 and 2450MHz MHz in liquid samples representing both brain liquid and body fluid at these frequencies. The calibration was for CW signals only, and the axis of the probe was parallel to the direction of propagation of the incident field i.e. end-on to the incident radiation. The axial isotropy of the probe was measured by rotating the probe about its axis in 10 degree steps through 360 degrees in this orientation.

The reference point for the calibration is in the centre of the probe's cross-section at a distance of 2.7 m from the probe tip in the direction of the probe amplifier. A value of 2.7 mm should be used for the tip to sensor offset distance in the software.

It is important that the diode compression point and air factors used in the software are the same as those quoted in the results tables, as these are used to convert the diode output voltages to a SAR value.

DIELECTRIC PROPERTIES OF LIQUIDS

The dielectric properties of the brain and body tissue-simulant liquids employed for calibration are listed in the tables below. The measurements were performed prior to each waveguide test using an Indexsar DiLine measurement kit, which uses the TEM method as recommended in [2].

AMBIENT CONDITIONS

Measurements were made in the open laboratory at $22 \pm 2.0^{\circ}\text{C}$. The temperature of the liquids in the waveguide used was measured using a mercury thermometer.

RESPONSE TO MODULATED SIGNALS

To measure the response of the probe and amplifier to modulated signals, the probe is held vertically in a liquid-filled waveguide.

An RF amplifier is allowed to warm up and stabilise before use. A spectrum analyser is used to demonstrate that the peak power of the RF amplifier for the CW signals and the pulsed signals are within 0.1dB of each other when the signal generator is switched from CW to modulated output. Subsequently, the power levels recorded are read from a power meter when a CW signal is being transmitted.

The test sequence involves manually stepping the power up in regular (e.g. 2 dB) steps from the lowest power that gives a measurable reading on the SAR probe up to the maximum that the amplifiers can deliver.

At each power level, the individual channel outputs from the SAR probe are recorded at CW and then recorded again with the modulation setting. The results are entered into a spreadsheet. Using the spreadsheets, the modulated power is calculated by applying a factor to the measured CW power (e.g. for GSM, this factor is 9.03dB). This process is repeated 3 times with the response maximised for each channel sensor in turn.



2.6 SAR MEASUREMENT SYSTEM

PROBE CALIBRATION PROCEDURE - Continued

The probe channel output signals are linearised in the manner set out in Section 1 above using equation (1) with the DCPs determined from the linearisation procedure. Calibration factors for the probe are used to determine the E-field values corresponding to the probe readings using equation (3). SAR is determined from the equation

$$\text{SAR (W/kg)} = E_{\text{liq}}^2 \text{ (V/m)} * \sigma \text{ (S/m)} / 1000 \quad (6)$$

Where σ is the conductivity of the simulant liquid employed.

Using the spreadsheet data, the DCP value for linearising each of the individual channels (X, Y and Z) is assessed separately. The corresponding DCP values are listed in the summary page of the calibration factors for each probe.

Figure 9 shows the linearised probe response to 900MHz GSM signals, Figure 9a the response to 1800MHz GSM signals, Figure 10 the response to GPRS signals (GSM with 2 timeslots) and Figure 11 & 12 the response to CDMA IS-95A and W-CDMA signals.

Additional tests have shown that the modulation response is similar at 1800MHz and is not affected by the orientation between the source and the probe.



2.6 SAR MEASUREMENT SYSTEM

PROBE CALIBRATION PROCEDURE - Continued

SUMMARY OF CALIBRATION FACTORS FOR PROBE IXP-050 S/N 0084

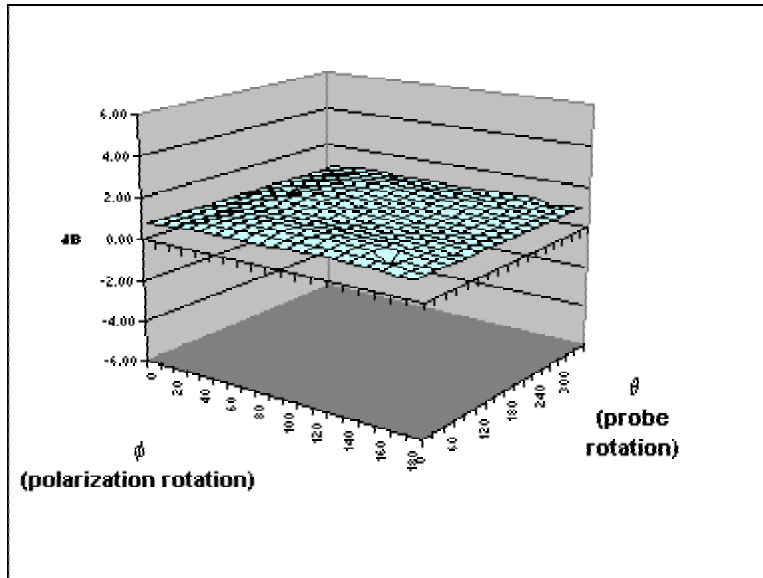

	X	Y	Z	
Air factors	500	410	385	(V*200)
DCPs	20	20	20	(V*200)
GSM	10.9	13	11.4	(V*200)
GPRS	16.1	16.1	14.7	(V*200)
CDMA	20	20	20	(V*200)

f (MHz)	Axial isotropy (+/- dB)		SAR conversion factors(liq/air)		Notes
	BRAIN	BODY	BRAIN	BODY	
900	0.09	0.09	0.279	0.300	3,4
1800	0.12	0.10	0.342	0.375	3,4
1900	0.13	0.10	0.354	0.405	3,4
2450	0.12	0.09	0.396	0.468	3,4

Notes	
1)	Calibrations done at 22C +/- 2C
2)	Probe calibration by substitution against NPL-calibrated probe (Probe IXP-050 S/N0071; NPL Cal Rept. No: EF07/2002/03/IndexSAR)
3)	Waveguide calibration
4)	Checked using box-phantom validation test

(The graph shows a simple, spreadsheet representation of surface shown in 3D in Figure 4)



2.6 SAR MEASUREMENT SYSTEM

PROBE CALIBRATION PROCEDURE - Continued

PROBE SPECIFICATIONS

IndexSAR probe 0084, along with its calibration, is compared with CENELEC and IEEE standards recommendations (Refs [1] and [2]) in the Tables below. A listing of relevant specifications is contained in the tables below:

DIMENSIONS	S/N 0084	CENELEC [1]	IEEE [2]
Overall length (mm)	350		
Tip length (mm)	10		
Body diameter (mm)	12		
Tip diameter (mm)	5.2	8	8
Distance from probe tip to dipole centers (mm)	2.7		

DYNAMIC RANGE	S/N 0084	CENELEC [1]	IEEE [2]
Minimum (W/kg)	0.01	<0.02	0.01
Maximum (W/kg)	>100	>100	100

LINEARITY OF RESPONSE	S/N 0084	CENELEC [1]	IEEE [2]
Over range 0.01 – 100 W/kg (+/- dB)	0.125	0.50	0.25

Isotropy (measured at 900MHz)	S/N 0084	CENELEC [1]	IEEE [2]
Axial rotation with probe normal to source (+/- dB) at 900, 1800, 1900 and 2450 MHz	Max. 0.13 (see summary table)	0.5	0.25
Spherical isotropy covering all orientations to source (+/- dB)	0.34	1.0	0.50

CONSTRUCTION	Each probe contains three orthogonal dipole sensors arranged on a triangular prism core, protected against static charges by built-in shielding, and covered at the tip by PEEK cylindrical enclosure material. No adhesives are used in the immersed section. Outer case materials are PEEK and heat-shrink sleeving.
CHEMICAL RESISTANCE	Tested to be resistant to glycol and alcohol containing simulant liquids but probes should be removed, cleaned and dried when not in use.



2.6 SAR MEASUREMENT SYSTEM

PROBE CALIBRATION PROCEDURE - Continued

REFERENCES

- [1] CENELEC, EN 50361, July 2001. Basic Standard for the measurement of specific absorption rate related to human exposure to electromagnetic fields from mobile phones.
- [2] IEEE 1528, Recommended practice for determining the spatial-peak specific absorption rate (SAR) in the human body due to wireless communications devices: Experimental techniques.
- [3] Calibration report on SAR probe IXP-050 S/N 0071 from National Physical Laboratory. Test Report EF07/2002/03/IndexSAR. Dated 20 February 2002.

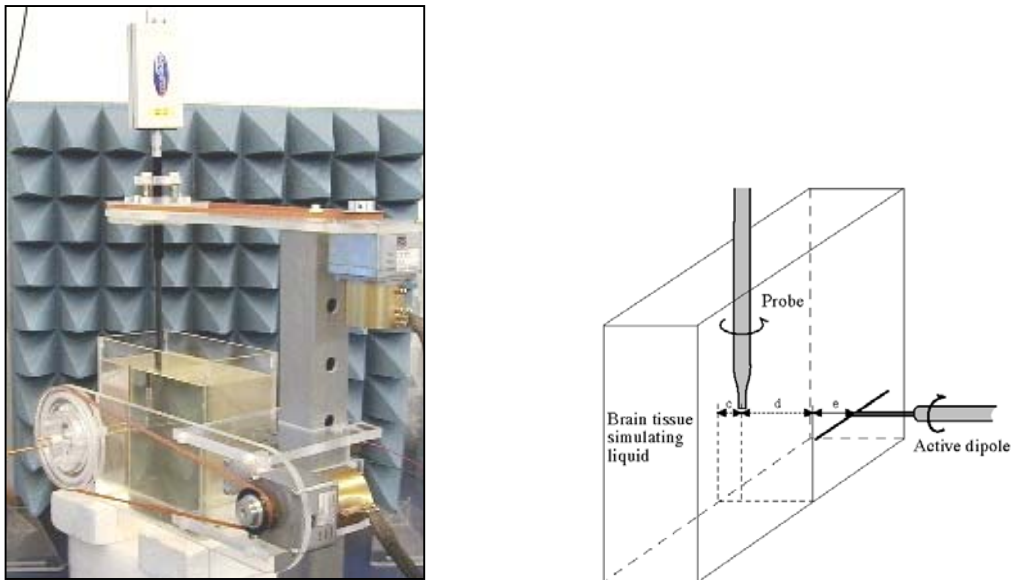

Figure 2. Spherical isotropy jig showing probe, dipole and box filled with simulated brain liquid (see Ref [2], Section A.5.2.1)

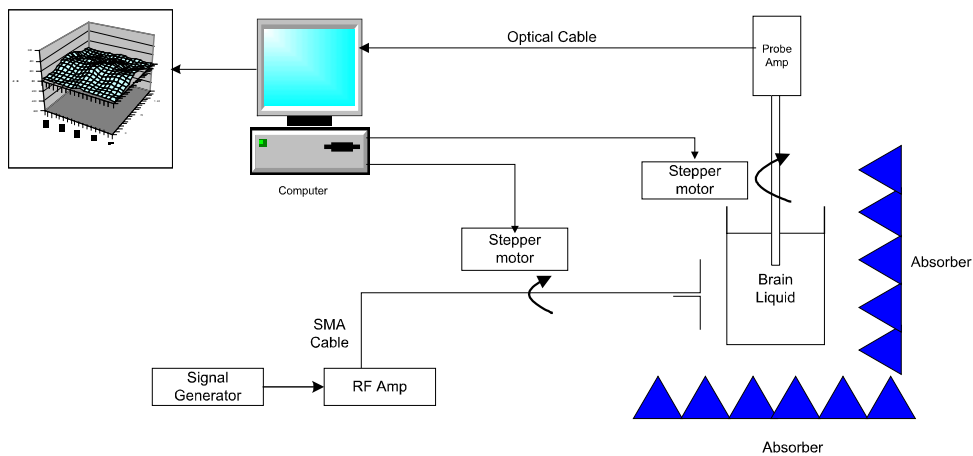

Figure 3. Schematic diagram of the test geometry used for isotropy determination

2.6 SAR MEASUREMENT SYSTEM



PROBE CALIBRATION PROCEDURE - Continued

REFERENCES

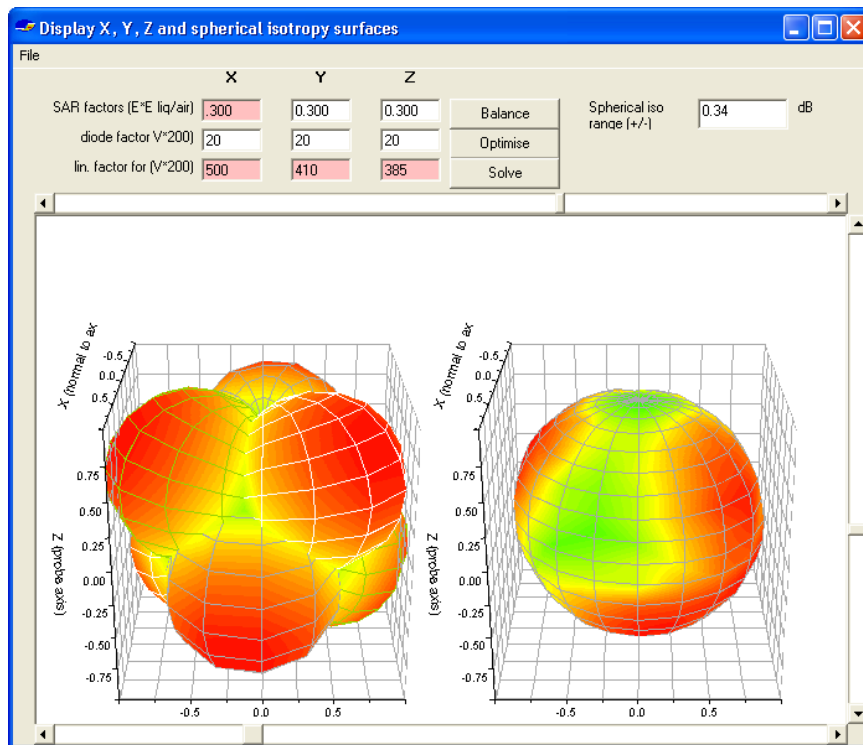

Figure 4. Graphical representation of the probe response to fields applied from each direction. The diagram on the left shows the individual response characteristics of each of the three channels and the diagram on the right shows the resulting probe sensitivity in each direction. The colour range in the figure images the lowest values as blue and the maximum values as red. For the probe S/N 0084, this range is (+/-) 0.34 dB. The probe is more sensitive to fields parallel to the axis and less sensitive to fields normal to the probe axis.

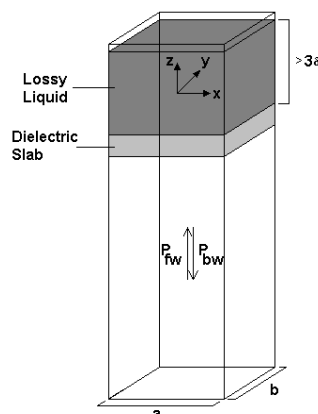

Figure 5. Geometry used for waveguide calibration (after Ref [2]. Section A.3.2.2)



2.6 SAR MEASUREMENT SYSTEM

PROBE CALIBRATION PROCEDURE - Continued

REFERENCES

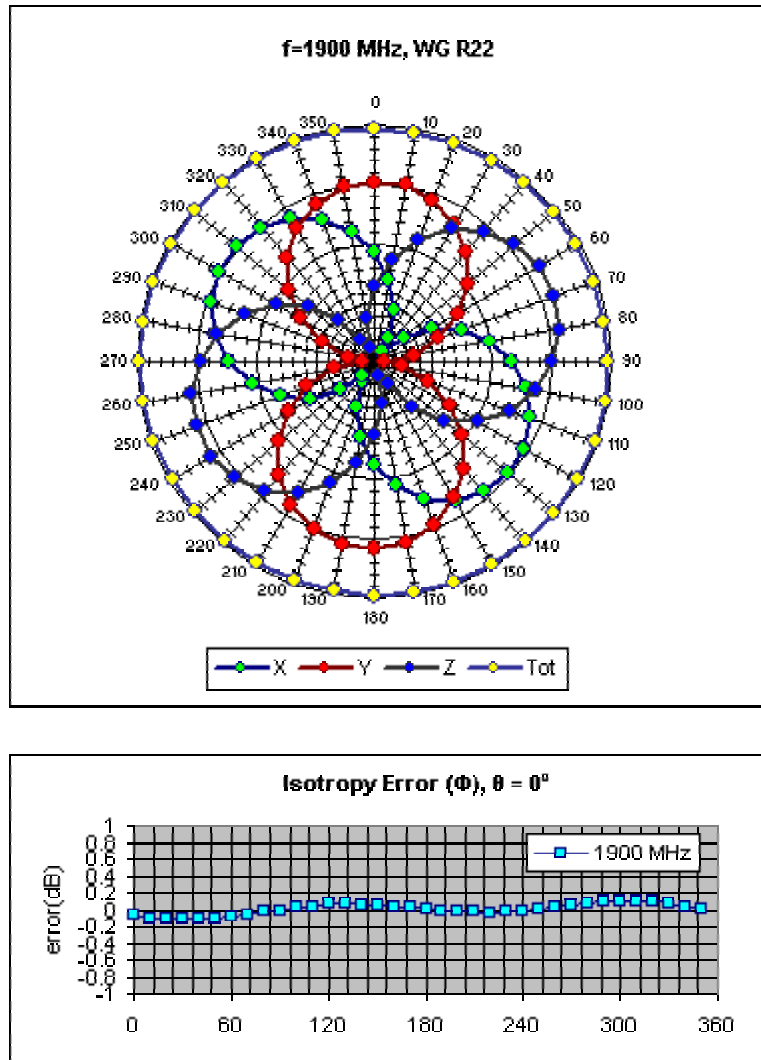

Figure 6. Example of the rotational isotropy of probe S/N 0084 obtained by rotating the probe in a liquid-filled waveguide at 1800 MHz. Similar distributions are obtained at the other test frequencies (900, 1900 and 2450 MHz) both in brain liquids and body fluids (see summary table)



2.6 SAR MEASUREMENT SYSTEM

PROBE CALIBRATION PROCEDURE - Continued

REFERENCES

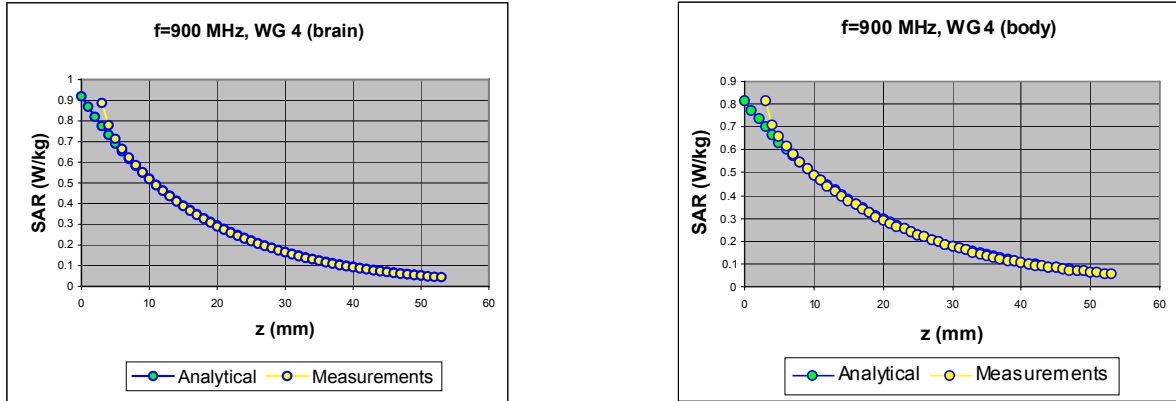

Figure 7. The measured SAR decay function along the centreline of the WG4 waveguide with conversion factors adjusted to fit to the theoretical function for the particular dimension, frequency, power and liquid properties employed.

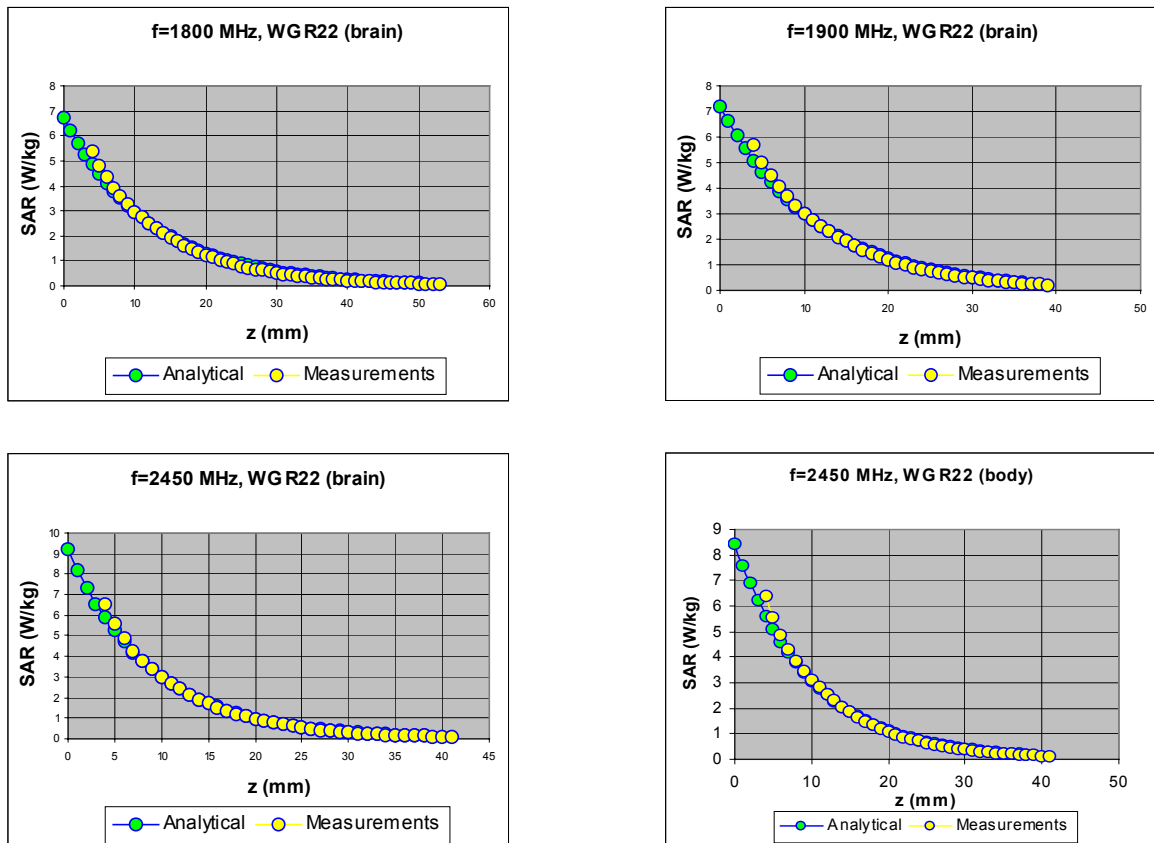

Figure 8. The measured SAR decay function along the centreline of the R22 waveguide with conversion factors adjusted to fit to the theoretical function for the particular dimension, frequency, power and liquid properties employed.



2.6 SAR MEASUREMENT SYSTEM

PROBE CALIBRATION PROCEDURE - Continued

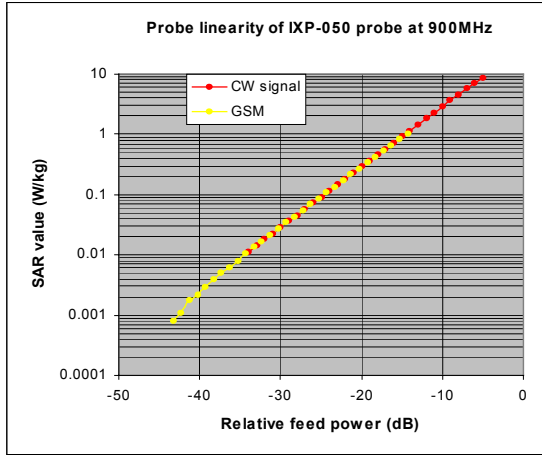

Figure 9. The GSM response of an IXP-050 probe at 900MHz

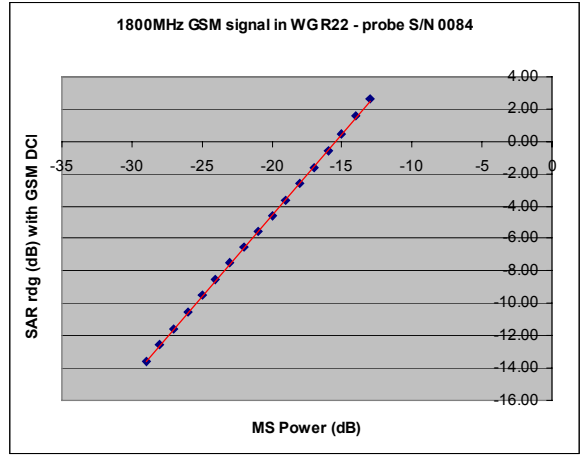

Figure 9a. The actual GSM response of IXP-050 probe S/N 0084 at 1800MHz.

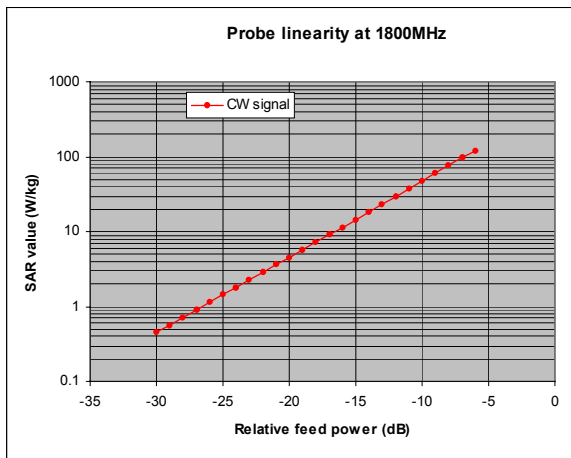

Figure 9b. The actual CW response of IXP-050 probe SN0084 up to 100W/kg

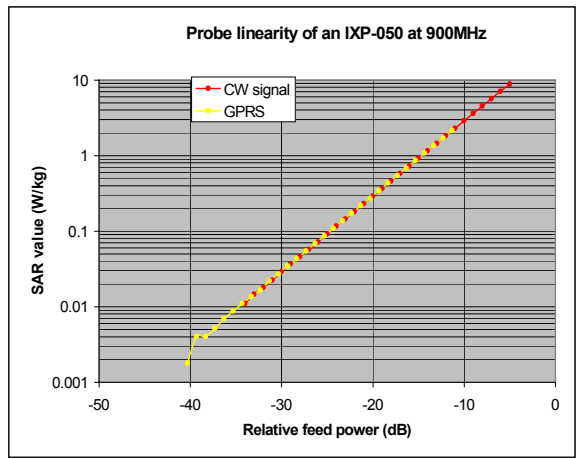

Figure 10. The GPRS response of an IXP-050 probe at 900MHz.



2.6 SAR MEASUREMENT SYSTEM

PROBE CALIBRATION PROCEDURE - Continued

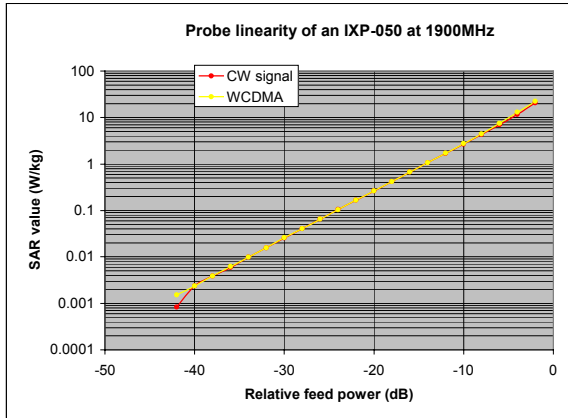

Figure 11. The WCDMA response of an IXP-050 probe at 1900MHz.

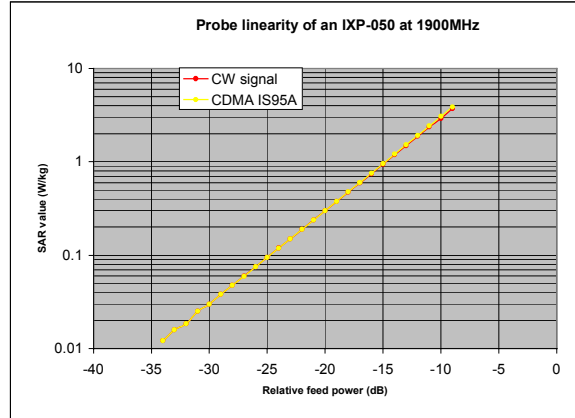

Figure 12. The CDMA IS95A response of an IXP-050 probe at 1900MHz.

TABLE INDICATING THE DIELECTRIC PARAMETERS OF THE LIQUIDS USED FOR CALIBRATIONS AT EACH FREQUENCY

Liquid used	Relative permittivity (measured)	Conductivity (S/m) (measured)
900 MHz BRAIN	41.8	1.00
900 MHz BODY	57.5	1.031
1800 MHz BRAIN	38.64	1.38
1800 MHz BODY	54.3	1.587
1900 MHz BRAIN	38.12	1.47
1900 MHz BODY	52.97	1.46
2450 MHz BRAIN	38.67	1.881
2450 MHz BODY	52.19	1.949



2.6 SAR MEASUREMENT SYSTEM

SAR MEASUREMENT PROCEDURE



Figure 13: Principal components of the SAR measurement test bench

The major components of the test bench are shown in the picture above. A test set and dipole antenna control the handset via an air link and a low-mass phone holder can position the phone at either ear. Graduated scales are provided to set the phone in the 15 degree position. The upright phantom head holds approx. 7 litres of simulant liquid. The phantom is filled and emptied through a 45mm diameter penetration hole in the top of the head.

After an area scan has been done at a fixed distance of 8mm from the surface of the phantom on the source side, a 3D scan is set up around the location of the maximum spot SAR. First, a point within the scan area is visited by the probe and a SAR reading taken at the start of testing. At the end of testing, the probe is returned to the same point and a second reading is taken. Comparison between these start and end readings enables the power drift during measurement to be assessed.

SARA2 Interpolation and Extrapolation schemes

SARA2 software contains support for both 2D cubic B-spline interpolation as well as 3D cubic B-spline interpolation. In addition, for extrapolation purposes, a general n^{th} order polynomial fitting routine is implemented following a singular value decomposition algorithm presented in [4]. A 4th order polynomial fit is used by default for data extrapolation, but a linear-logarithmic fitting function can be selected as an option. The polynomial fitting procedures have been tested by comparing the fitting coefficients generated by the SARA2 procedures with those obtained using the polynomial fit functions of Microsoft Excel when applied to the same test input data.

Interpolation of 2D area scan

The 2D cubic B-spline interpolation is used after the initial area scan at fixed distance from the phantom shell wall. The initial scan data are collected with approx. 10mm spatial resolution and spline interpolation is used to find the location of the local maximum to within a 1mm resolution for positioning the subsequent 3D scanning.



2.6 SAR MEASUREMENT SYSTEM

SAR MEASUREMENT PROCEDURE - Continued

Extrapolation of 3D scan

For the 3D scan, data are collected on a spatially regular 3D grid having (by default) 6.4 mm steps in the lateral dimensions and 3.5 mm steps in the depth direction (away from the source). SARA2 enables full control over the selection of alternative step sizes in all directions.

The digitised shape of the head is available to the SARA2 software, which decides which points in the 3D array are sufficiently well within the shell wall to be 'visited' by the SAR probe. After the data collection, the data are extrapolated in the depth direction to assign values to points in the 3D array closer to the shell wall. A notional extrapolation value is also assigned to the first point outside the shell wall so that subsequent interpolation schemes will be applicable right up to the shell wall boundary.

Interpolation of 3D scan and volume averaging

The procedure used for defining the shape of the volumes used for SAR averaging in the SARA2 software follow the method of adapting the surface of the 'cube' to conform with the curved inner surface of the phantom (see Appendix C.2.2.1 in EN 50361). This is called, here, the conformal scheme.

For each row of data in the depth direction, the data are extrapolated and interpolated to less than 1mm spacing and average values are calculated from the phantom surface for the row of data over distances corresponding to the requisite depth for 10g and 1g cubes. This results in two 2D arrays of data, which are then cubic B-spline interpolated to sub mm lateral resolution. A search routine then moves an averaging square around through the 2D array and records the maximum value of the corresponding 1g and 10g volume averages. For the definition of the surface in this procedure, the digitised position of the headshell surface is used for measurement in head-shaped phantoms. For measurements in rectangular, box phantoms, the distance between the phantom wall and the closest set of gridded data points is entered into the software.

For measurements in box-shaped phantoms, this distance is under the control of the user. The effective distance must be greater than 2.5mm as this is the tip-sensor distance and to avoid interface proximity effects, it should be at least 5mm. A value of 6 or 8mm is recommended. This distance is called **dbe** in EN 50361.

For automated measurements inside the head, the distance cannot be less than 2.5mm, which is the radius of the probe tip and to avoid interface proximity effects, a minimum clearance distance of x mm is retained. The actual value of **dbe** will vary from point to point depending upon how the spatially-regular 3D grid points fit within the shell. The greatest separation is when a grid point is just not visited due to the probe tip dimensions. In this case the distance could be as large as the step-size plus the minimum clearance distance (i.e with $x=5$ and a step size of 3.5, **dbe** will be between 3.5 and 8.5mm).

The default step size (**dstep** in EN 50361) used is 3.5mm, but this is under user-control. The compromise is with time of scan, so it is not practical to make it much smaller or scan times become long and power-drop influences become larger.

The robot positioning system specification for the repeatability of the positioning (**dss** in EN50361) is +/- 0.04mm.



2.6 SAR MEASUREMENT SYSTEM

SAR MEASUREMENT PROCEDURE - Continued

The phantom shell is made by an industrial moulding process from the CAD files of the SAM shape, with both internal and external moulds. For the upright phantoms, the external shape is subsequently digitised on a Mitutoyo CMM machine (Euro C574) to a precision of 0.001mm. Wall thickness measurements made non-destructively with an ultrasonic sensor indicate that the shell thickness (**dph**) away from the ear is 2.0 +/- 0.1mm. The ultrasonic measurements were calibrated using additional mechanical measurements on available cut surfaces of the phantom shells.

For the upright phantom, the alignment is based upon registration of the rotation axis of the phantom on its 253mm-diameter baseplate bearing and the position of the probe axis when commanded to go to the axial position. A laser alignment tool is provided (procedure detailed elsewhere). This enables the registration of the phantom tip (**dmis**) to be assured to within approx. 0.2mm. This alignment is done with reference to the actual probe tip after installation and probe alignment. The rotational positioning of the phantom is variable – offering advantages for special studies, but locating pins ensure accurate repositioning at the principal positions (LH and RH ears).



2.7 TEST POSITIONS

OET65(c) FLAT PHANTOM TEST POSITIONS – GRAPHICAL REPRESENTATION

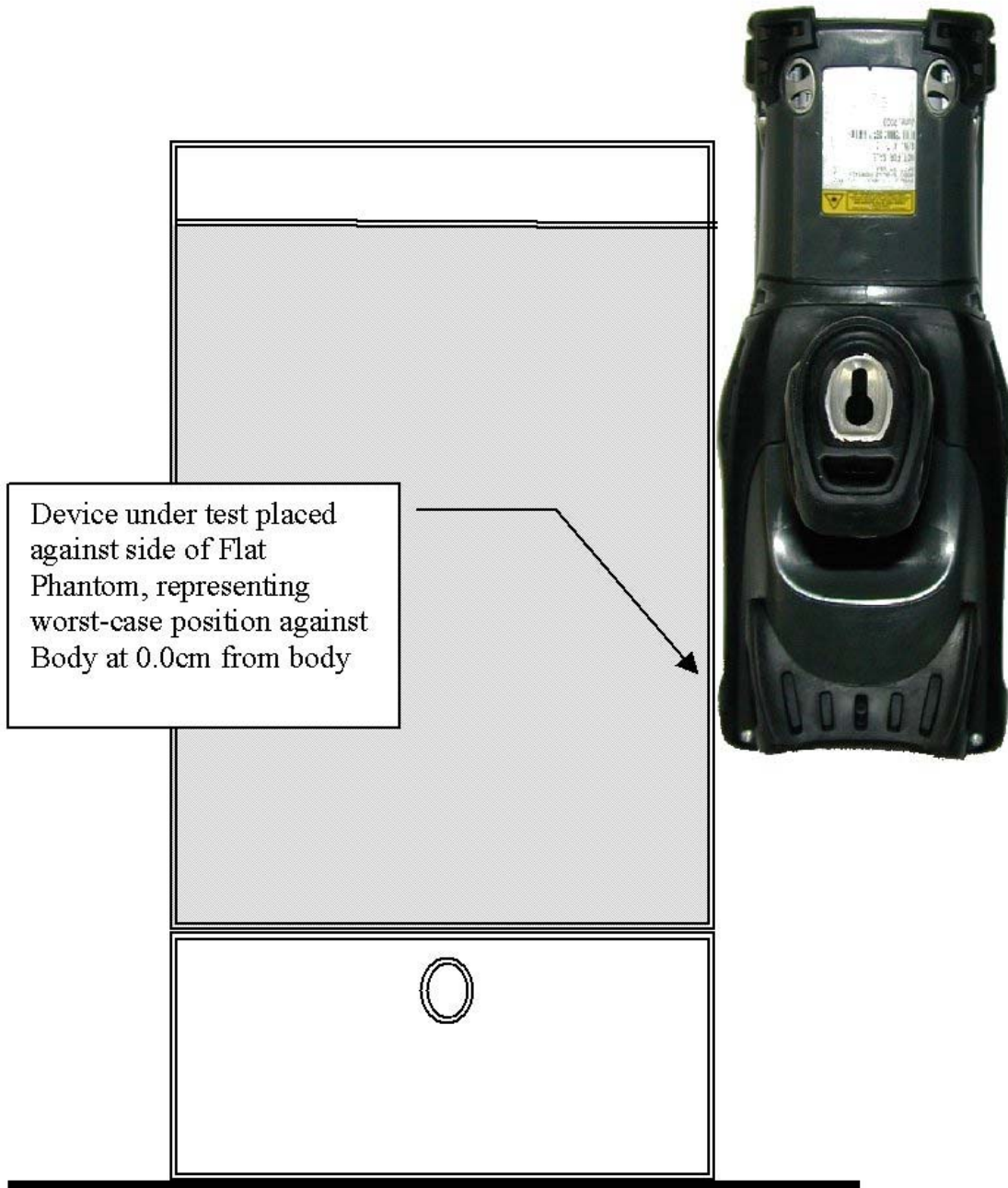

Figure 14. – Touch Position; Left Hand side facing.



2.7 TEST POSITIONS

OET65(c) FLAT PHANTOM TEST POSITIONS – GRAPHICAL REPRESENTATION

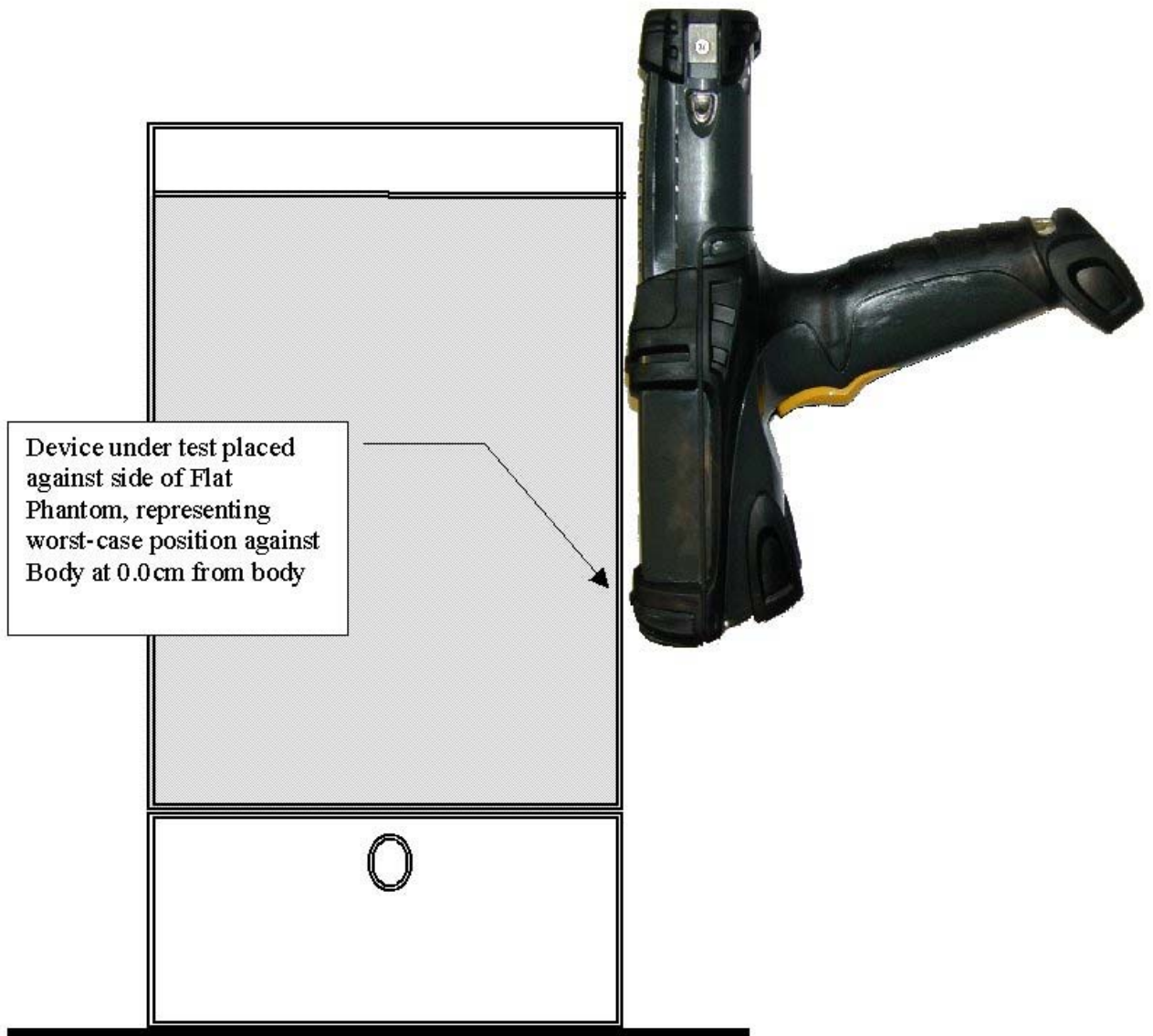

Figure 15. – Touch Position; LCD facing.



2.7 TEST POSITIONS

OET65(c) FLAT PHANTOM TEST POSITIONS – GRAPHICAL REPRESENTATION

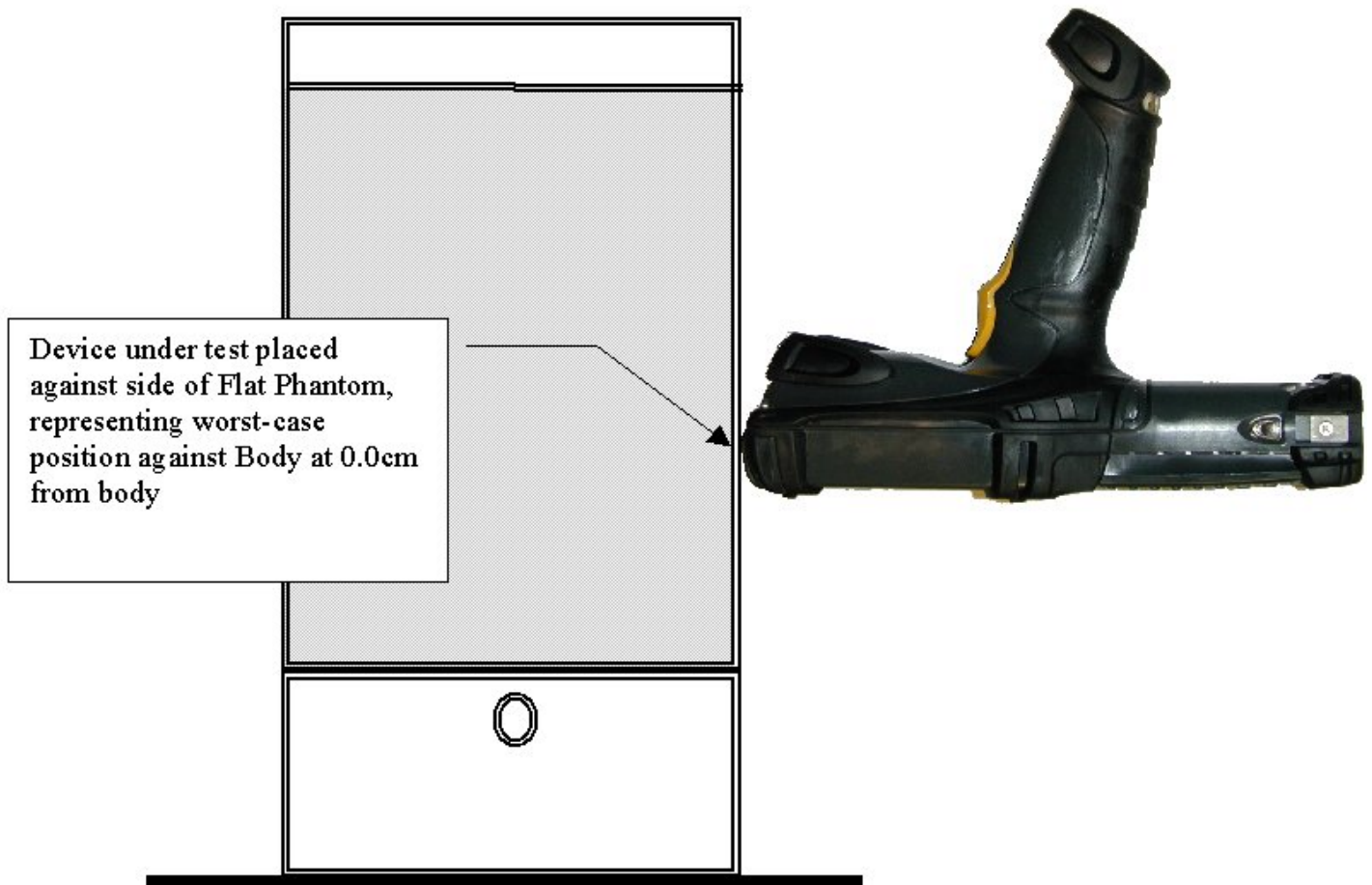

Figure 16. – Touch Position; End-on.



2.7 TEST POSITIONS

OET65(c) FLAT PHANTOM TEST POSITIONS – GRAPHICAL REPRESENTATION

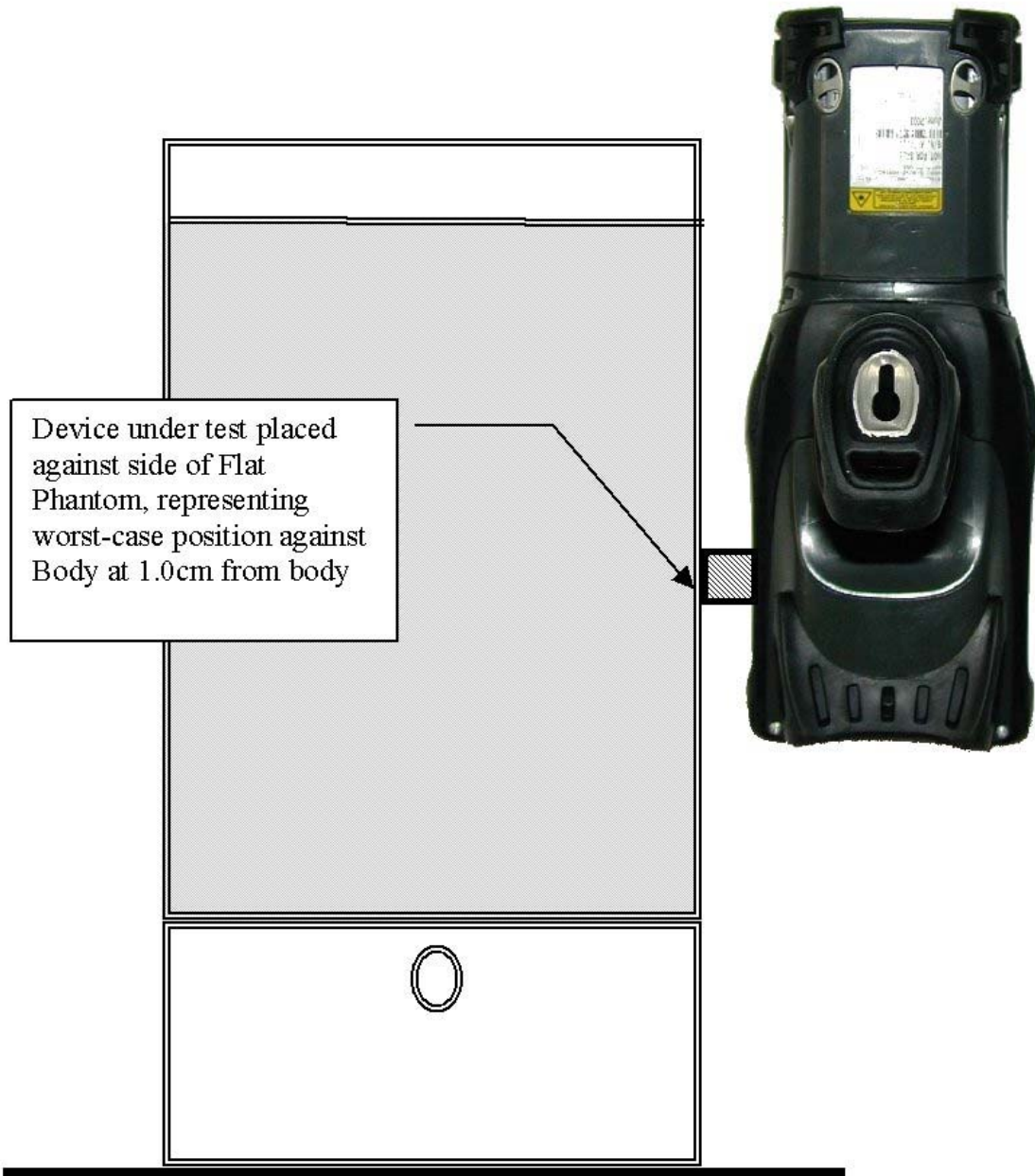

Figure 17. – 1.0 cm separation; Left hand side.



2.8 TEST RESULTS INCLUDING SAR DISTRIBUTIONS (AREA SCANS – 2D)

System.....	: IndexSAR SARA2	Power Drift.....	:0.1 dB
Date of Test.....	: 01/07/03	Battery Model.....	: 21-61261-01
Lab Ambient.....	: 23.1°C	Probe Serial Number.....	: IXP-050 0084
Device ID.....	: MC9050	Liquid Simulant.....	: 2450 MHz Body
Phantom.....	: Flat 2mm side	Permittivity.....	: 51.95
Phantom S/No.....	: 02	Conductivity.....	: 2.031
Phantom Rotation (deg).....	: 0	Liquid Ambient.....	: 21.6
Test Position.....	: Touch – LH side Facing	Max SAR 'Y' Axis Location ..	: -2.4 mm
Antenna Position.....	: Integrated	Max SAR 'Z' Axis Location ..	: -134.0 mm
Test Frequency.....	: 2437MHz	SAR 1g.....	: 0.727 W/kg
Modulation / Test Mode.....	: CW / RLAN	SAR 10g.....	: 0.282 W/kg
Crest Factor.....	: 1.0	SAR Drift.....	: -0.162 dB
Diode Compression factor ..	: 20; 20; 20		

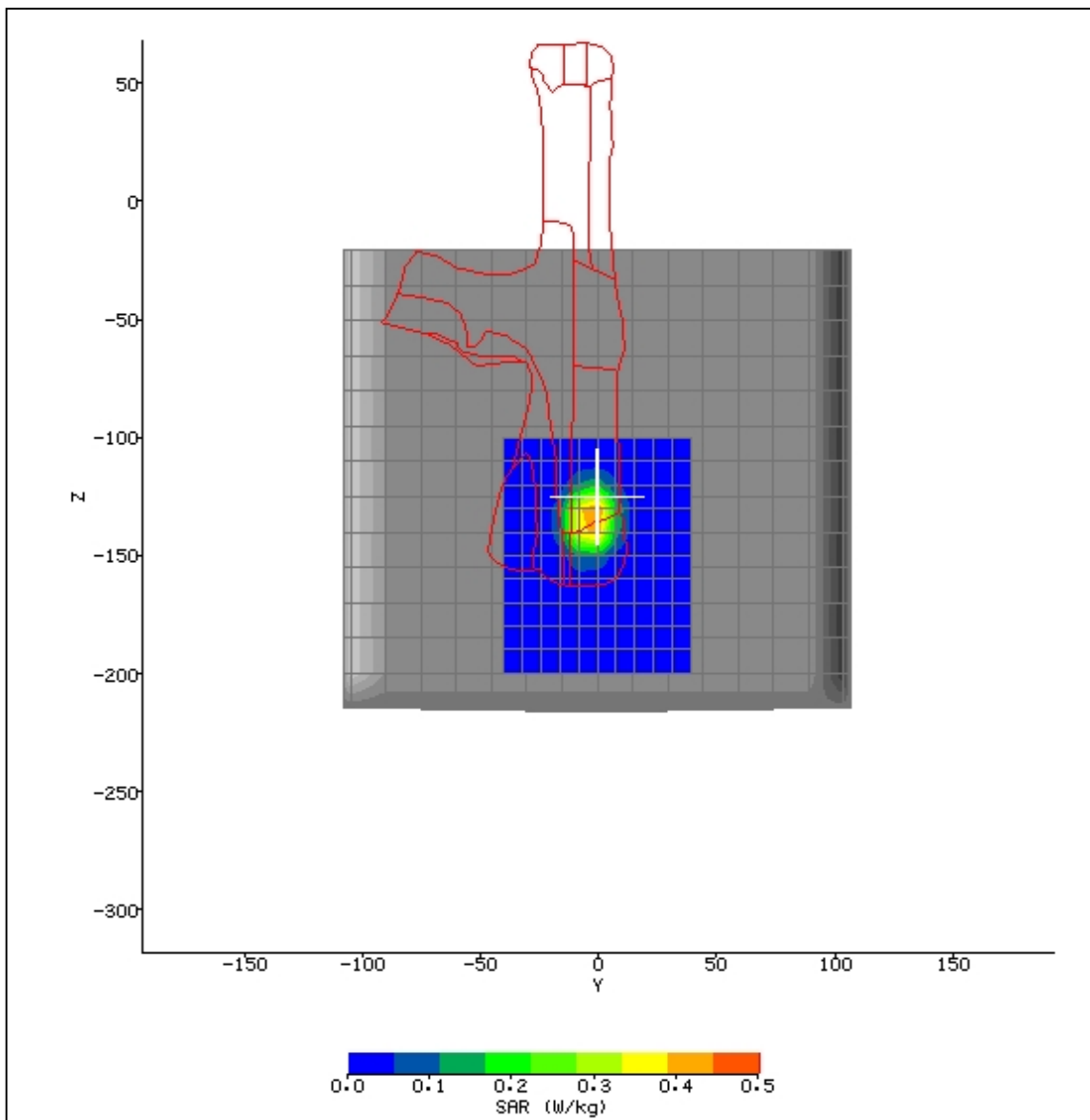

Figure 18



2.8 TEST RESULTS INCLUDING SAR DISTRIBUTIONS (AREA SCANS – 2D)

System.....	: IndexSAR SARA2	Power Drift.....	:0.0 dB
Date of Test.....	: 01/07/03	Battery Model.....	: 21-61261-01
Lab Ambient.....	: 22.0°C	Probe Serial Number.....	: IXP-050 0084
Device ID.....	: MC9050	Liquid Simulant.....	: 2450 MHz Body
Phantom.....	: Flat 2mm side	Permittivity.....	: 51.95
Phantom S/No.....	: 02	Conductivity.....	: 2.031
Phantom Rotation (deg).....	: 0	Liquid Ambient.....	: 21.6
Test Position.....	: Touch – LCD Facing	Max SAR 'Y' Axis Location ..	: -49.0 mm
Antenna Position.....	: Integrated	Max SAR 'Z' Axis Location ..	: -133.0 mm
Test Frequency.....	: 2437MHz	SAR 1g.....	: 0.418 W/kg
Modulation / Test Mode.....	: CW / RLAN	SAR 10g.....	: 0.183 W/kg
Crest Factor.....	: 1.0	SAR Drift.....	: -0.044 dB
Diode Compression factor ..	: 20; 20; 20		

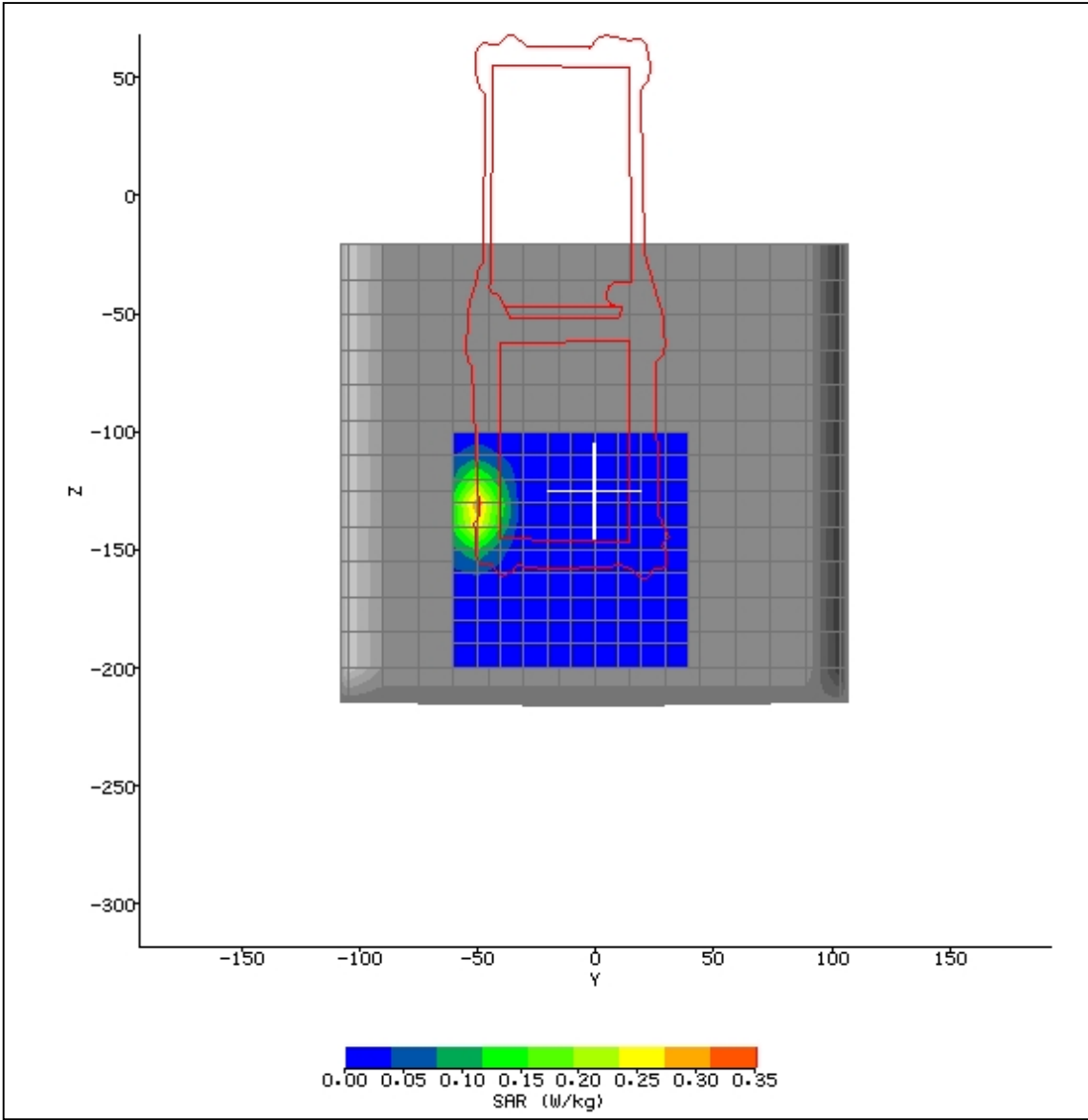

Figure 19



2.8 TEST RESULTS INCLUDING SAR DISTRIBUTIONS (AREA SCANS – 2D)

System.....	: IndexSAR SARA2	Power Drift.....	:0.1 dB
Date of Test.....	: 01/07/03	Battery Model.....	: 21-61261-01
Lab Ambient.....	: 23.3°C	Probe Serial Number.....	: IXP-050 0084
Device ID.....	: MC9050	Liquid Simulant.....	: 2450 MHz Body
Phantom.....	: Flat 2mm side	Permittivity.....	: 51.95
Phantom S/No.....	: 02	Conductivity.....	: 2.031
Phantom Rotation (deg).....	: 0	Liquid Ambient.....	: 21.6
Test Position.....	: Touch – End-on	Max SAR 'Y' Axis Location...:	: 40.0 mm
Antenna Position.....	: Integrated	Max SAR 'Z' Axis Location...:	: -163.0 mm
Test Frequency.....	: 2437MHz	SAR 1g.....	: 0.020 W/kg
Modulation / Test Mode.....	: CW / RLAN	SAR 10g.....	: 0.013 W/kg
Crest Factor.....	: 1.0	SAR Drift.....	: -0.580 dB
Diode Compression factor...:	: 20; 20; 20		

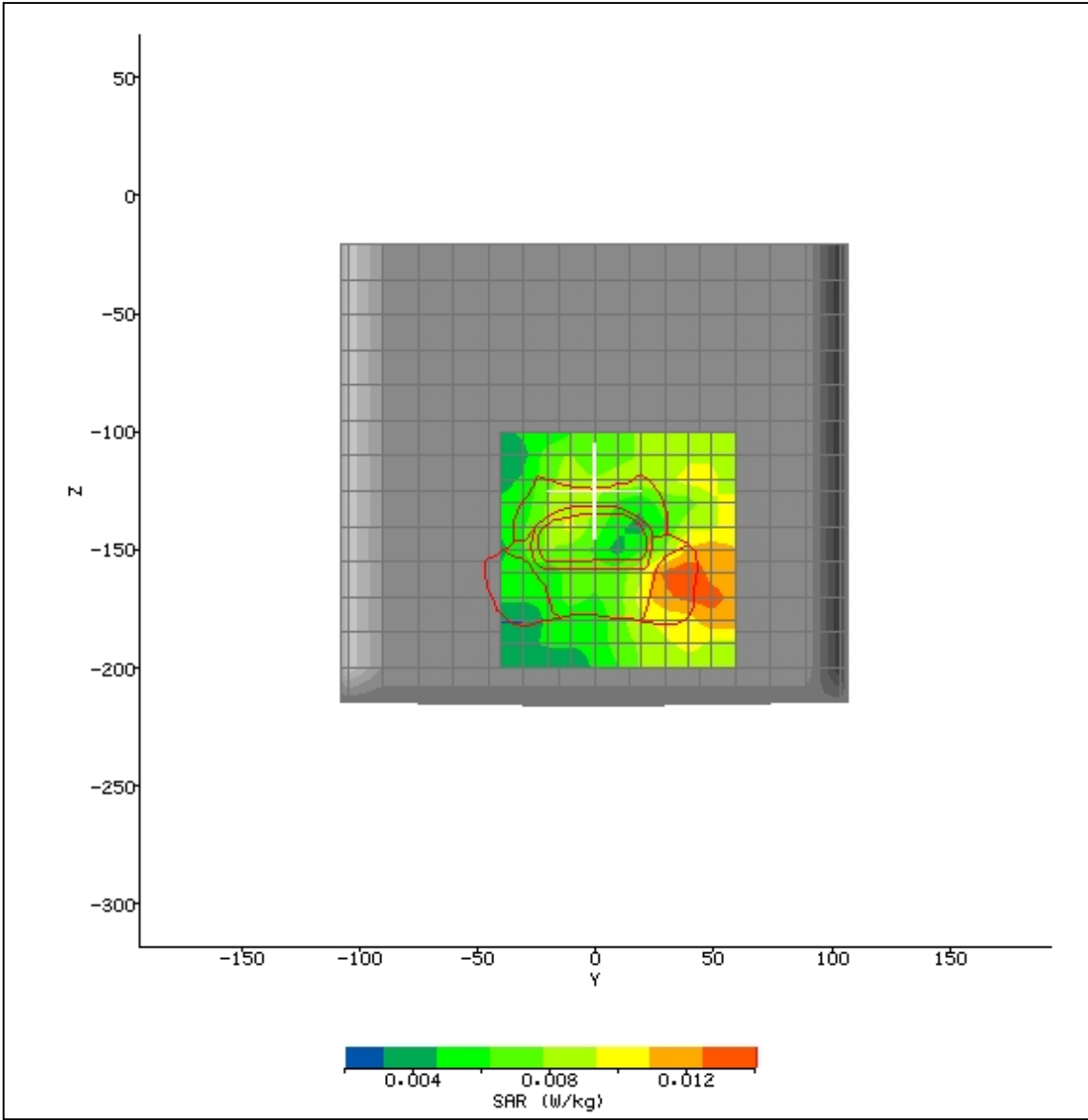

Figure 20



2.8 TEST RESULTS INCLUDING SAR DISTRIBUTIONS (AREA SCANS – 2D)

System.....	: IndexSAR SARA2	Power Drift.....	: 0.1 dB
Date of Test.....	: 01/07/03	Battery Model.....	: 21-61261-01
Lab Ambient.....	: 23.4°C	Probe Serial Number.....	: IXP-050 0084
Device ID.....	: MC9050	Liquid Simulant.....	: 2450 MHz Body
Phantom.....	: Flat 2mm side	Permittivity.....	: 51.95
Phantom S/No.....	: 02	Conductivity.....	: 2.031
Phantom Rotation (deg).....	: 0	Liquid Ambient.....	: 21.6
Test Position.....	: Touch – LH side Facing	Max SAR 'Y' Axis Location ..	: -6.4 mm
Antenna Position.....	: Integrated	Max SAR 'Z' Axis Location ..	: -133.0 mm
Test Frequency.....	: 2412MHz	SAR 1g.....	: 2.037 W/kg
Modulation / Test Mode.....	: CW / RLAN	SAR 10g.....	: 0.789 W/kg
Crest Factor.....	: 1.0	SAR Drift.....	: -0.039 dB
Diode Compression factor ..	: 20; 20; 20		

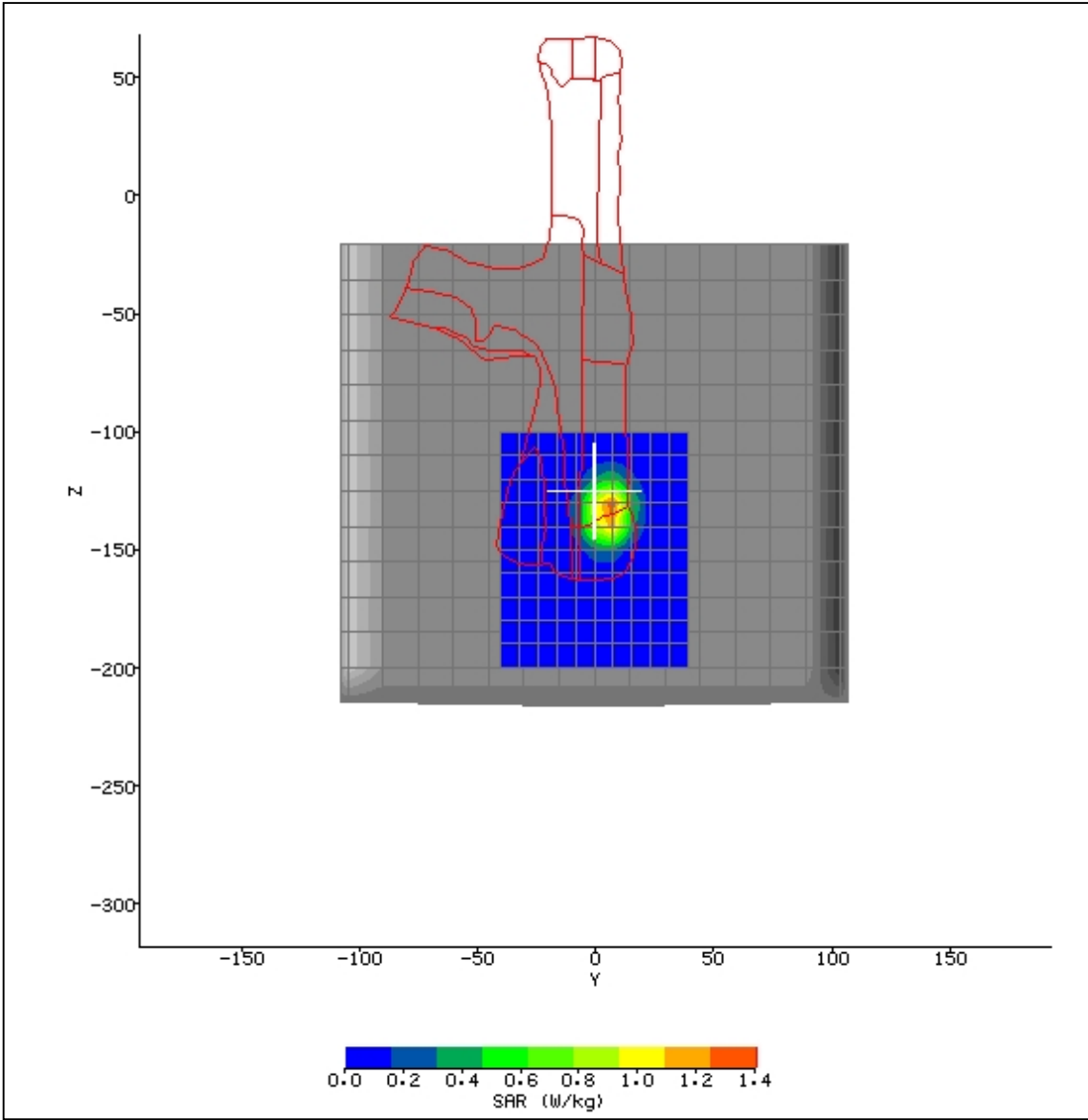

Figure 21



2.8 SAR DISTRIBUTIONS (AREA SCANS – 2D)

System.....	: IndexSAR SARA2	Power Drift.....	:0.0 dB
Date of Test.....	: 01/07/03	Battery Model.....	: 21-61261-01
Lab Ambient.....	: 22.4°C	Probe Serial Number.....	: IXP-050 0084
Device ID.....	: MC9050	Liquid Simulant.....	: 2450 MHz Body
Phantom.....	: Flat 2mm side	Permittivity.....	: 51.95
Phantom S/No.....	: 02	Conductivity.....	: 2.031
Phantom Rotation (deg).....	: 0	Liquid Ambient.....	: 21.8
Test Position.....	: 1cm GAP– LH side Facing	Max SAR 'Y' Axis Location ..	: 4.8 mm
Antenna Position.....	: Integrated	Max SAR 'Z' Axis Location ..	: -134.0 mm
Test Frequency.....	: 2412MHz	SAR 1g.....	: 0.527 W/kg
Modulation / Test Mode	: CW / RLAN	SAR 10g.....	: 0.236 W/kg
Crest Factor.....	: 1.0	SAR Drift.....	: -0.0 dB
Diode Compression factor ..	: 20; 20; 20		

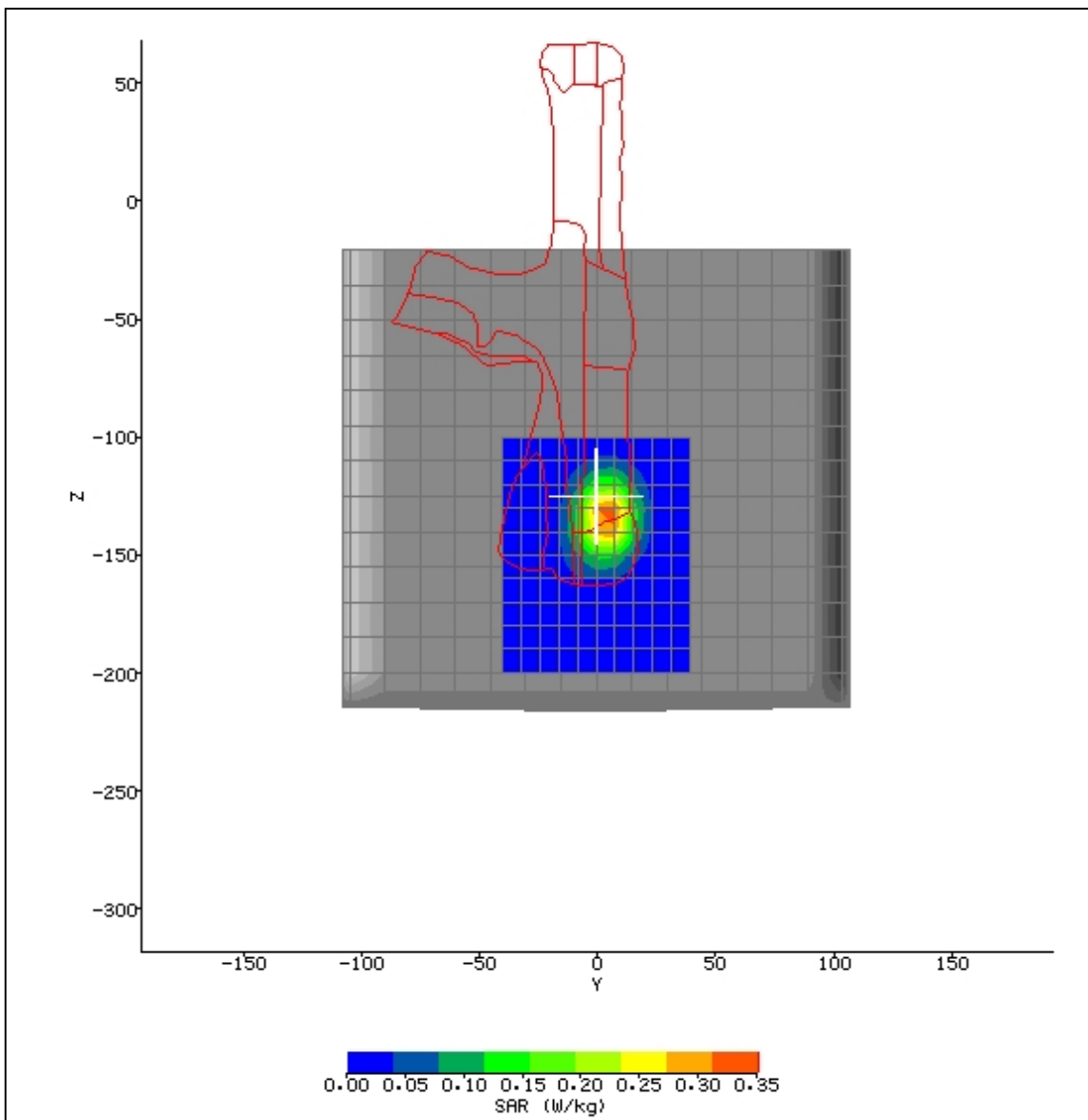

Figure 22



2.8 SAR DISTRIBUTIONS (AREA SCANS – 2D)

System.....	: IndexSAR SARA2	Power Drift.....	:0.0 dB
Date of Test.....	: 01/07/03	Battery Model.....	: 21-61261-01
Lab Ambient.....	: 23.5°C	Probe Serial Number.....	: IXP-050 0084
Device ID.....	: MC9050	Liquid Simulant.....	: 2450 MHz Body
Phantom.....	: Flat 2mm side	Permittivity.....	: 51.95
Phantom S/No.....	: 02	Conductivity.....	: 2.031
Phantom Rotation (deg).....	: 0	Liquid Ambient.....	: 21.8
Test Position.....	: 1cm GAP– LH side Facing	Max SAR 'Y' Axis Location ..	: 4.0 mm
Antenna Position.....	: Integrated	Max SAR 'Z' Axis Location ..	: -134.0 mm
Test Frequency.....	: 2437MHz	SAR 1g.....	: 0.585 W/kg
Modulation / Test Mode	: CW / RLAN	SAR 10g.....	: 0.261 W/kg
Crest Factor.....	: 1.0	SAR Drift.....	: -0.03 dB
Diode Compression factor ..	: 20; 20; 20		

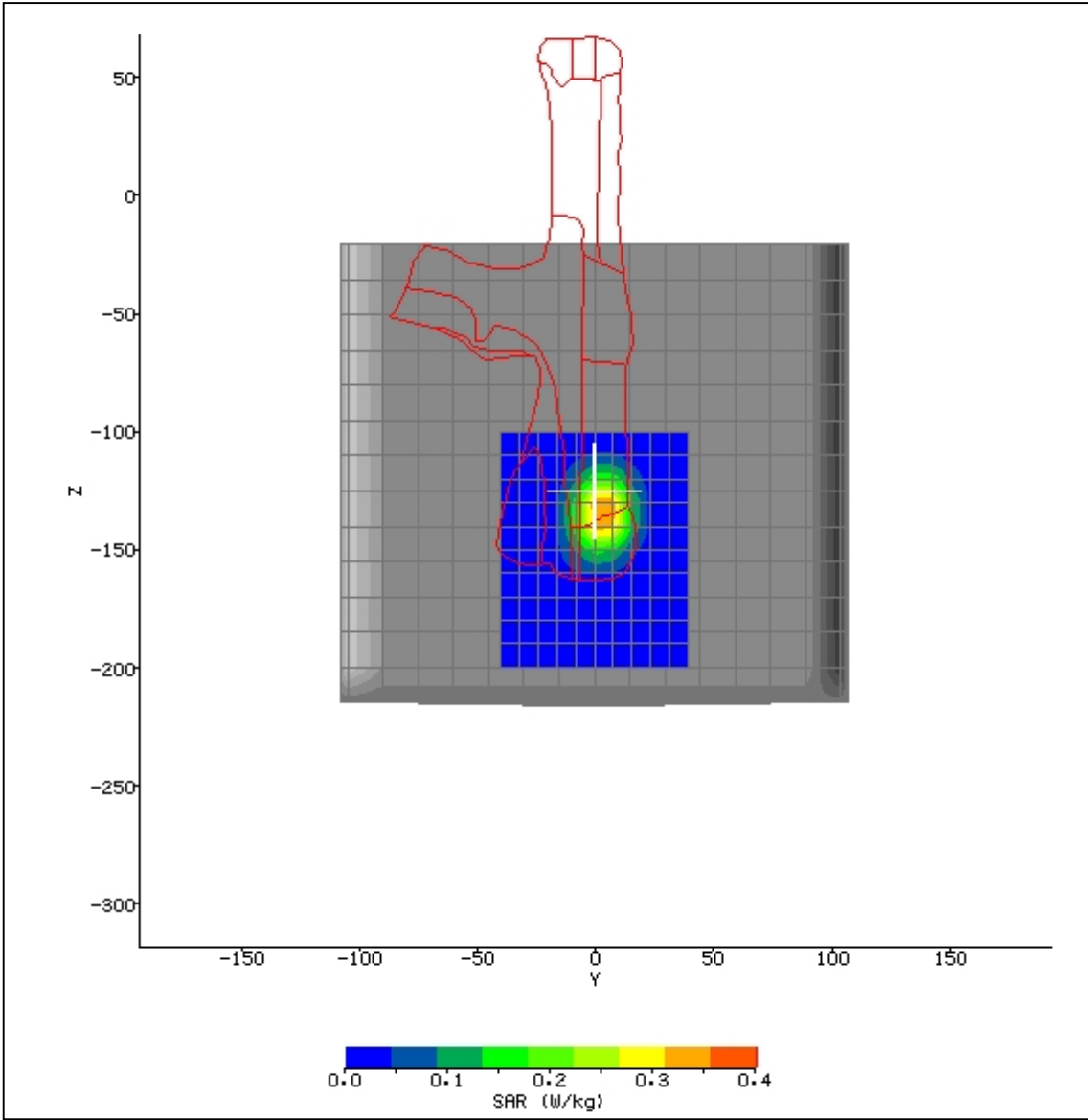

Figure 23



2.8 SAR DISTRIBUTIONS (AREA SCANS – 2D)

System.....	: IndexSAR SARA2	Power Drift.....	:0.1 dB
Date of Test.....	: 01/07/03	Battery Model.....	: 21-61261-01
Lab Ambient.....	: 23.4°C	Probe Serial Number.....	: IXP-050 0084
Device ID.....	: MC9050	Liquid Simulant.....	: 2450 MHz Body
Phantom.....	: Flat 2mm side	Permittivity.....	: 51.95
Phantom S/No.....	: 02	Conductivity.....	: 2.031
Phantom Rotation (deg).....	: 0	Liquid Ambient.....	: 21.8
Test Position.....	: 1cm GAP– LH side Facing	Max SAR 'Y' Axis Location ..	: 2.4 mm
Antenna Position.....	: Integrated	Max SAR 'Z' Axis Location ..	: -134.0 mm
Test Frequency.....	: 2462MHz	SAR 1g.....	: 0.646 W/kg
Modulation / Test Mode	: CW / RLAN	SAR 10g.....	: 0.287 W/kg
Crest Factor.....	: 1.0	SAR Drift.....	: -0.0289 dB
Diode Compression factor ..	: 20; 20; 20		

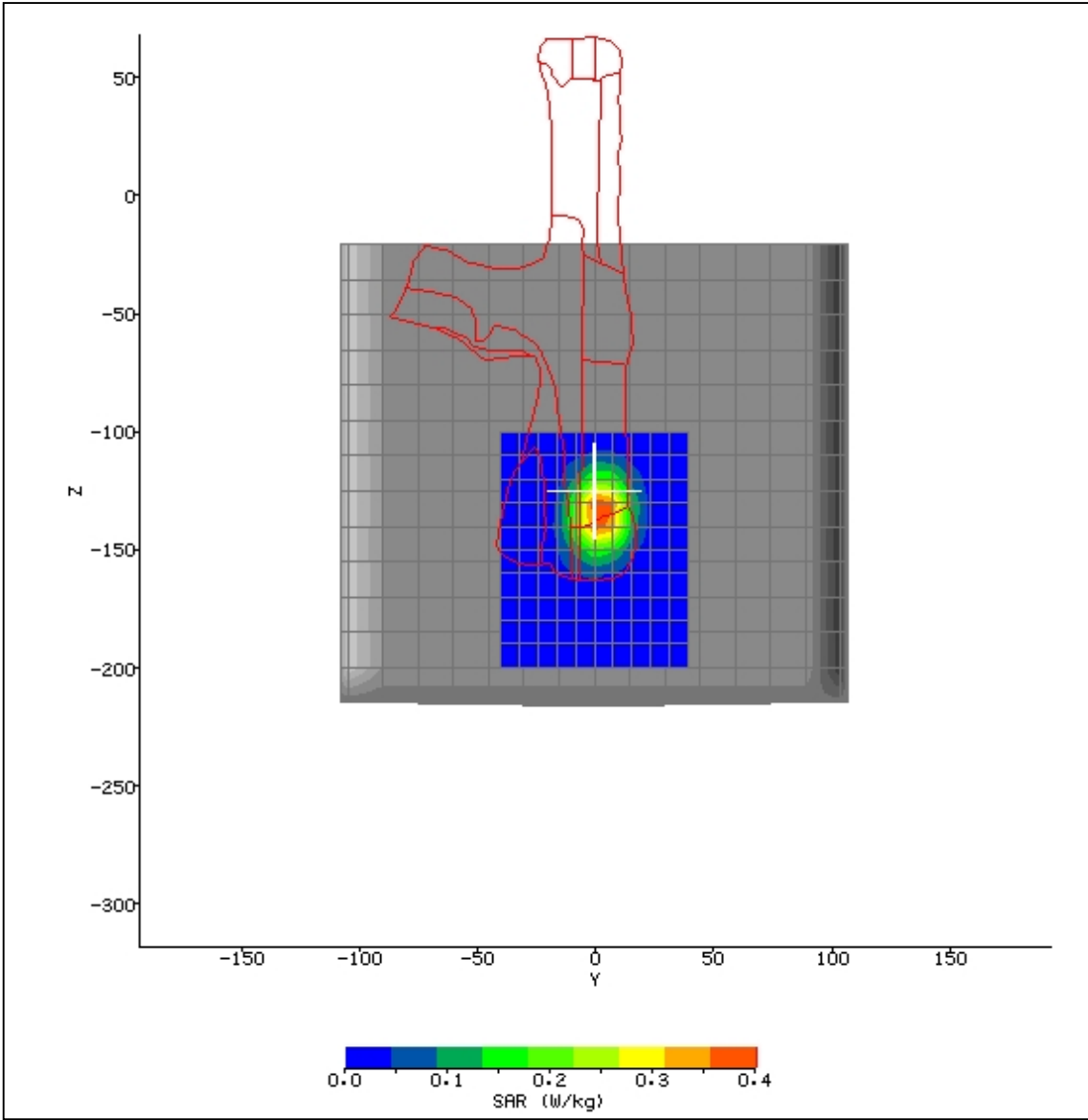

Figure 24



2.8 SAR DISTRIBUTIONS (AREA SCANS – 2D)

System.....	: IndexSAR SARA2	Power Drift.....	:0.2 dB
Date of Test	: 23/07/03	Battery Model	: 21-61261-01
Lab Ambient.....	: 23.0°C	Probe Serial Number	: IXP-050 0084
Device ID	: MC9050	Liquid Simulant.....	: 2450 MHz Body
Phantom	: Flat 2mm side	Permittivity.....	: 51.95
Phantom S/No	: 02	Conductivity.....	: 2.031
Phantom Rotation (deg).....	: 0	Liquid Ambient.....	: 22.0 °C
Test Position	: 1cm GAP– LH side Facing	Max SAR 'Y' Axis Location ..	: 7.2 mm
Antenna Position.....	: Integrated	Max SAR 'Z' Axis Location ..	: -135.0 mm
Test Frequency.....	: 2472MHz	SAR 1g	: 0.755 W/kg
Modulation / Test Mode	: CW / RLAN	SAR 10g	: 0.334 W/kg
Crest Factor	: 1.0	SAR Drift	: -0.262 dB
Diode Compression factor ..	: 20; 20; 20		

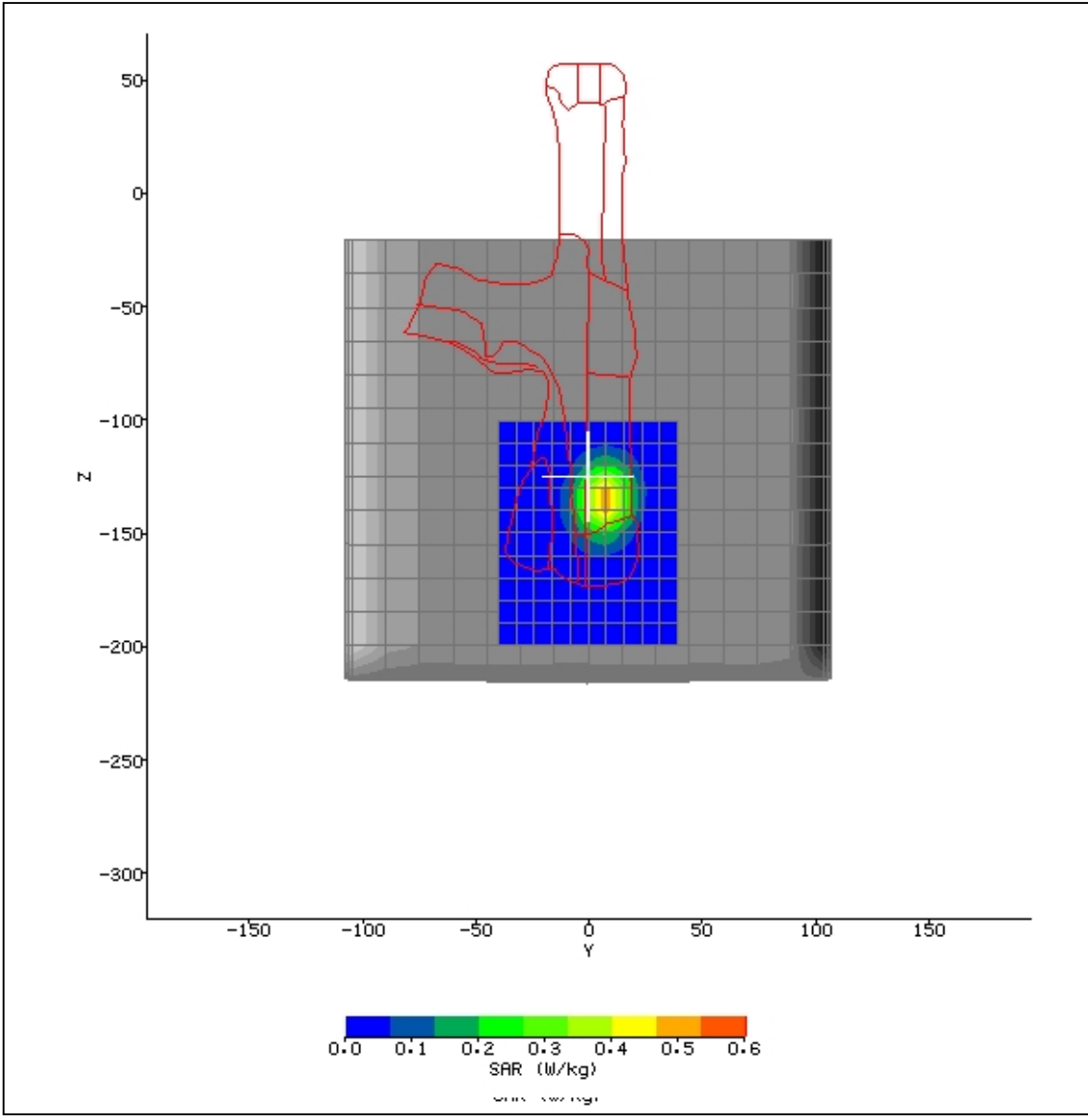

Figure 25



2.9 TEST POSITIONAL PHOTOGRAPHS

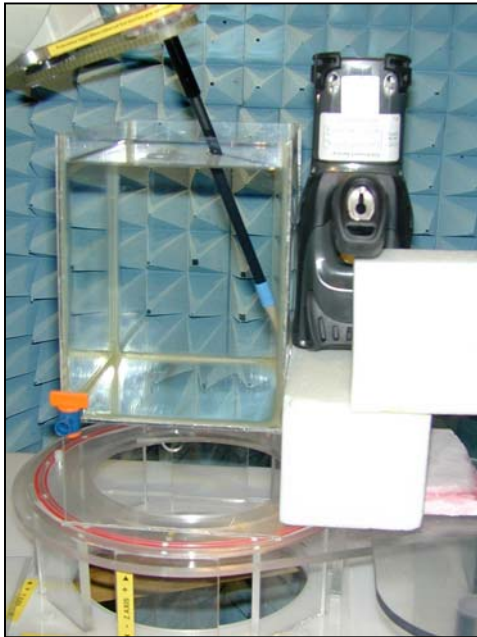

Figure 27. Positional photograph of MC9050
Left-Hand side in Touch Position



Figure 28. Positional photograph of MC9050
Touch Position LCD Facing

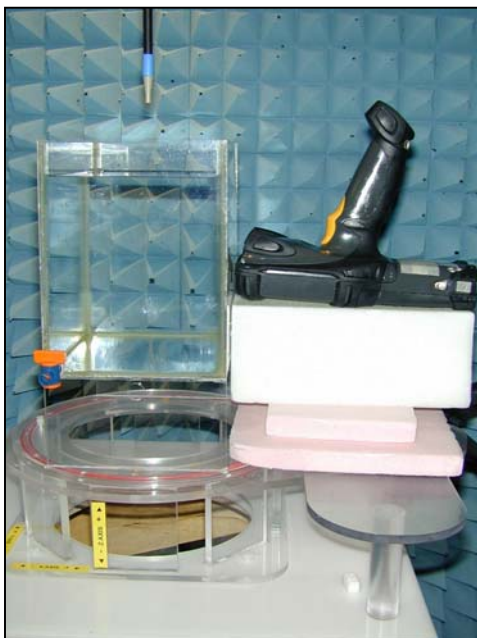

Figure 29. Positional photograph MC9050
Front End on Facing Touch Position

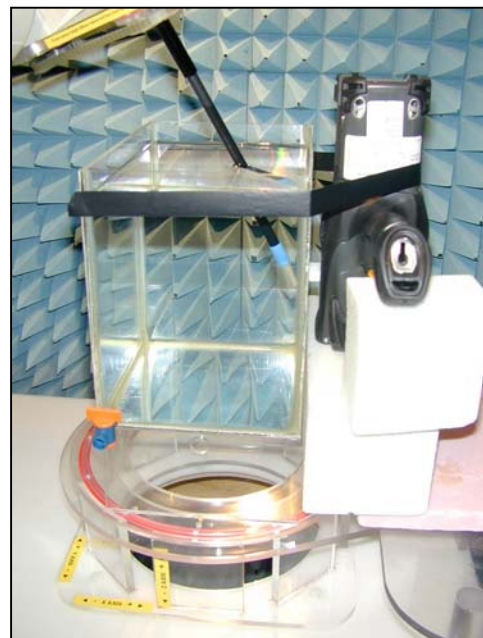

Figure 30. Positional photograph MC9050
Left-Hand side in 1.0 cm spacing

2.10 RECORD PHOTOGRAPHS



Figure 31. Front view of the Symbol Mobile Computer MC9050.

2.10 RECORD PHOTOGRAPHS



Figure 32. Rear view of the Symbol Mobile Computer MC9050.



2.10 RECORD PHOTOGRAPHS

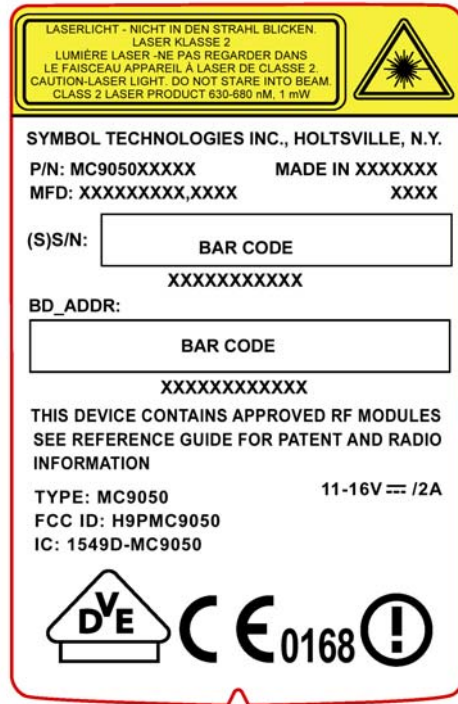

Figure 33. Symbol MC9050 Mobile Computer – product label



© 2003 BABT

This report must not be reproduced without the written permission of BABT.