REPORT ON

The Specific Absorption Rate Assessment of the Symbol
MC9062 Mobile Computer.

Report Number: WS611524 – 001 Issue 2.00

August 2004

REPORT ON: The Specific Absorption Rate Assessment of the Symbol
MC9062 Mobile Computer.

Report No: WS611524 – 001 Issue 2.00

FCC ID: H9PMC9062A
IC: 1549D–MC9062A

PREPARED FOR: Symbol Technologies
One Symbol Plaza
Holtsville
NY 11742-1300
New York
United States of America

ATTESTATION: The wireless portable device described within this report has been shown to be capable of compliance for localised specific absorption rate (SAR) for General Population/Uncontrolled Exposure Limits as defined in the European standard EN50361: 2002 and Australian Communications Authority Radio communications (Electromagnetic Radiation – Human Exposure) Standard 2003 of 2.0W/kg, FCC standard Supplement C (Edition 01-01) to OET Bulletin 65 (Edition 97-01) and RSS-102 Issue 1 (Provisional) September 25, 1999 of 1.6 W/kg.

The measurements shown in this report were made in accordance with the procedures specified in European standard EN50361: 2002, Supplement C (Edition 01-01) to OET Bulletin 65 (Edition 97-01), RSS-102 Issue 1 (Provisional) September 25 and IEEE1528-200x (Draft December 2002).

All reported testing was carried out on a sample of equipment to demonstrate compliance with the above standards. The sample tested was found to comply with the requirements in the applied rules.



A. Miller
Senior SAR Test Engineer

APPROVED BY:



M J Hardy
UKAS Signatory

DATED: 3rd August 2004

DISTRIBUTION: Symbol Technologies Corporation (CD ROM). Copy No: 1
BABT Copy No.: 2
Copy No.: 1

Note: The test results reported herein relate only to the item tested as identified above and on the Status Page.



CONTENTS

EXECUTIVE SUMMARY	3
1.1 Status	4
1.2 Declaration of Build Status	5
1.3 Summary	6
1.4 Test Result Summary	8
TEST DETAILS	11
2.1 Test Equipment	12
2.2 Test Software	12
2.3 Dielectric Properties of Simulant Liquids	13
2.4 Test Conditions	14
2.5 Measurement Uncertainty	15
2.6 SAR Measuring System Probe and Amplifier Specification Probe Calibration SAR Measurement Procedure	16
2.7 OET65(c) Flat Phantom Test Position – Graphical Representation	34
2.8 SAR Distributions (Area Scans – 2D)	38
2.9 Test Positional Photographs	57
2.10 Record Photographs	58
2.11 Copyright Statement	64



EXECUTIVE SUMMARY

The Specific Absorption Rate Assessment of Symbol
MC9062 Mobile Computer.

PROJECT MANAGER: M. Glasspool



1.1 STATUS

MANUFACTURING DESCRIPTION	Mobile Computer
STATUS OF TEST	Specific Absorption Rate Testing
APPLICANT	Symbol Technologies Inc
MANUFACTURER	Symbol Technologies Inc
TYPE NUMBER	MC9062
PART NUMBER	MC9062-SHAH9AEA721
SERIAL NUMBER	ALP75815
HARDWARE VERSION	Build Status Rev 8 (To be released as Rev A)
RADIO LAN	Symbol Main Terminal Module (MTM) with 802.11b embedded Radio.
TYPE	21-64436
POWER	+20dBm
BLUETOOTH MODULE	Symbol Bluetooth Module
TYPE	21-64381
CLASS	Class 1
POWER	+20dBm
GPRS/GSM TRI-BAND RADIO	Siemens AG
TYPE	MC46
GPRS MULTISLOT CLASS	Mutli-slot Class 10
IMEI NUMBER	IMEI 004999002540317
GSM/GPRS POWER CLASS	Class 4 (E-GSM850) Class 1 (DCS1800 & PCS1900)

TEST SPECIFICATIONS:

US Federal Government, Code of Federal Regulations, Title 47 Telecommunication, Chapter 1 Federal Communications Commission, part 2, section 1093.

Federal Communications Commission (FCC) OET Bulletin 65c, Edition 01-01, Evaluating Compliance with FCC Guidelines for Human Exposure to Radiofrequency Electromagnetic Fields – Additional Information for Evaluating Compliance of Mobile and Portable Devices with FCC Limits for Human Exposure to Radiofrequency Emissions

CENELEC EN 50360: July 2001, Product Standard to demonstrate the compliance of mobile phones with the basic restrictions related to human exposure electromagnetic (300 MHz - 3 GHz).

CENELEC EN 50361: July 2001, Basic standard for the measurement of Specific Absorption Rate related to human exposure to electromagnetic fields from mobile phones (300 MHz - 3 GHz).

RSS-102 Issue 1 (Provisional) September 25, 1999: Evaluation Procedure for Mobile and Portable Radio Transmitters with respect to Health Canada's Safety Code 6 for Exposure of Humans to radio Frequency Fields.

Australian Communications Authority – Radio communications (Electromagnetic Radiation – Human Exposure) Standard 2003.

REFERENCES:

IEEE 1528 –200X: DRAFT Recommended Practice for Determining the Peak Spatial-Average Specific Absorption Rate (SAR) in the Human Body Due to Wireless Communications Devices: Experimental Techniques

Council Recommendations 1999/519/EC on the limitations of exposure of the general public to electromagnetic fields (0 Hz - 3 GHz) annex II.

BABT REGISTRATION NUMBER: WS611524.

RECEIPT OF TEST SAMPLES: 16th February 2004.

START OF TEST: 16th February 2004

FINISH OF TEST: 20th February 2004.



1.2 DECLARATION OF BUILD STATUS

MAIN EUT			
MANUFACTURING DESCRIPTION	Mobile Computer		
MANUFACTURER	Symbol Technologies Inc.		
COUNTRY OF ORIGIN	USA		
TYPE	MC9062		
PART NUMBER	MC9062-SHAH9AEA721		
SERIAL NUMBER	ALP75716, ALP75718, ALP75714, ALP75715, ALP75716, ALP75772, ALP75794, ALP75904, ALP75801, ALP75815		
HARDWARE VERSION	Rev 8 (Manufactured as Rev A)		
FCC ID	H9PMC9062A		
INDUSTRY CANADA ID	1549D-MC9062A		
RADIO MODULES INTEGRATED	RLAN, (21-64436) and Bluetooth, (21-64381), GSM/GPRS 850/1800/1900, (MC46)		
TECHNICAL DESCRIPTION	The unit supplied for testing is a Symbol MC9062 Mobile Computer, which offers Tri-Band GSM/GPRS 850/1800/1900, 2.4GHz 802.11b Wireless LAN and Bluetooth connectivity with the following options: SE824 Scan Engine; Colour (touch) display; 128/32 memory option; 28 Key Keyboard; PPC2003; Audio; Bluetooth		
BATTERY/POWER SUPPLY			
MANUFACTURING DESCRIPTION	Lithium Battery		
MANUFACTURER	Symbol Technologies Inc.		
COUNTRY OF ORIGIN	USA		
TYPE	N/A		
PART NUMBER	21-62960-01		
VOLTAGE	7.2V		
RADIO MODULES			
MANUFACTURING DESCRIPTION	Main Terminal Module with Embedded RLAN Radio	Bluetooth Module	GPRS/GSM Tri-Band Radio Module
MANUFACTURER	Symbol Technologies Inc	Symbol Technologies Inc	Siemens AG
COUNTRY OF ORIGIN	USA	USA	Germany
TYPE	21-64436	21-64381	MC46
POWER	7 - 16V	3.3V	3.2 - 4.5V
TRANSMITTER OPERATING BAND	2400 - 2483.5MHz	2400 - 2483.5MHz	824-849 / 1710-1785 / 1850-1910
TRANSMITTER POWER	100mW (+20dBm)	100mW (+20dBm)	2W (GSM850) 1W (GSM1800/1900)
RECEIVER OPERATING RANGE BAND	2400 - 2483.5MHz	2400 - 2483.5MHz	869-894 / 1805-1880 / 1930-1990
INTERMEDIATE FREQUENCIES	374MHz	Direct Conversion	Receiver: 0; Transmitter: 80MHz
EMISSION DESIGNATOR	11M0F1D	1M00F1D	GXW
DHSS/FHSS/COMBINED	DSSS	FHSS	GSM
FCC ID	H9P2164436	H9P2164381	QIPMC46
INDUSTRY CANADA ID	1549D-2164436	1549D-2164381	267W-MC46
ANCILLARIES			
MANUFACTURING DESCRIPTION	Headset		
MANUFACTURER	VXI Corporation		
TYPE	VXI 61-SYB		
PART NUMBER	50-11300-050		
SERIAL NUMBER	Not Serialised		
HARDWARE VERSION	Rev A		

Signature

Date
 D of B S Serial No

9th February 2004
 OR611524



1.3 SUMMARY

The unit supplied for testing is a Symbol MC9062 Mobile Computer in a 'Short' housing, which offers Tri-Band GSM/GPRS 850/1800/1900, 2.4GHz 802.11b Wireless LAN and Bluetooth connectivity with the following options: SE824 Scan Engine; Colour (touch) display; 128/32 memory option; 28 Key Keyboard; PPC2003; Audio; Bluetooth

Prior to full SAR assessment, the device was placed into the appropriate test mode and an area scan was performed on each face of the device to ascertain the location of the transmitter to enable the SAR testing to be performed on the appropriate face. This was performed for each Radio Module fitted.

Co-transmission was not considered as the client declared the supplied product was not capable of co-transmission.

SAR testing was carried out at the top, middle and bottom frequency of each of the device operating bands.

For the Bluetooth and RLAN Body worn assessment SAR testing was performed with the device set in the appropriate Test Mode for the Radio Module under test. Each side of the device (left and right sides), which contained the antennas was placed at distance of 1.0 cm from the side of the flat phantom for both. This position was chosen as it represented the worst-case position for SAR measurement, the 1.0 cm separation was required in order to conform to the limits applied. It is acknowledged that this is not representative of the normal worn position of use, but considered to give the manufacturer the worst-case SAR level.

For RLAN SAR assessment the device was placed into a test mode using onboard software supplied by the client, which enabled the device to be placed into a CW test mode. The channels 1, 6, 11 & 13 were selected in turn and the maximum SAR levels recorded

For Bluetooth SAR assessment the device was placed into a test mode using onboard software supplied by the client, which enabled the device to be placed into a CW test mode. The channels 0, 39 & 78 were selected in turn and the maximum SAR levels recorded.

For The GPRS/GSM Tri-Band Radio SAR assessment the device was placed into the MC9062 Mobile Computer Holster, with the LCD facing to the rear of the Holster defined normal use position. The Holster was then positioned with the belt clip in contact with the 2.0mm sidewall of the Flat Phantom. Flat Phantom dimensions 220mmx200mmx150mm and with a sidewall thickness of 2.0mm. The phantom was filled to a depth of 150mm with 2450MHz Body simulant liquid. The dielectric properties were in accordance with the requirements for the dielectric properties specified in Supplement C (Edition 01-01) to OET Bulletin 65 (Edition 97-01) the frequency under test. A single SAR assessment was also carried out with the rear of the device facing to the rear of the holster (This position is not designated as normal use position).

For the GPRS/GSM Tri-Band Radio SAR assessment the testing was performed at the bottom, middle and top frequency of each band. Testing was performed at the maximum power for the GSM 850, DCS 1800 and PCS1900 bands. This was achieved using a GSM test set, which controlled the handset at power level 5, power level 0 and power level 0 respectively. The MC9062 had an internal antenna so that the requirement for testing with antenna extended and retracted was not applicable.



1.3 SUMMARY– Continued

The following accessories were supplied for assessment with the device, these were: -

- Symbol Headset – Model Number VXI 61-SYB (p/n 50-11300-050)
- MC9062 Mobile Computer Holster – Manufactured by AGORA (p/n 11-66061-01)

The holster in normal operation will be placed on the belt at the side of the body. This position has declared as being the position typical body-worn operation.

The belt clip of the Mobile Computer Holster contains a metal spring enclosed within a plastic housing, with nominal dimensions: Overall length 80mm (formed into a semi-closed U shape); width 25mm and thickness 0.5mm.

The following SAR statement will be included in the Regulatory Guide for the MC9062.

'This device was tested for typical body-worn operations with the holster providing a minimal spacing of 4.0cm from the body to the rear case terminal/antenna. The holster is designed to hold the terminal with the screen facing the body. The holster should be worn on the hip. Use of the terminal/holster in any other position may not comply with FCC RF Exposure requirements and should be avoided.'

Included in this report are descriptions of the test method; the equipment used and an analysis of the test uncertainties applicable and diagrams indicating the locations of maximum SAR for each test position along with photographs indicating the positioning of the handset against either the right or left ear, as appropriate,

The maximum 10g volume averaged SAR level measured for all the tests performed did not exceed the 2 W/kg level defined for limiting the exposure of the general population to time-varying electric and magnetic fields by ICNIRP (1998), which is the relevant Standard for testing according to the CENELEC EN50361 test method.

The maximum 1g volume averaged SAR level measured for all the tests performed did not exceed the limits for General Population/Uncontrolled Exposure (W/kg) Partial Body of 1.6 W/kg. Level defined in Supplement C (Edition 01-01) to OET Bulletin 65 (97-01).

WORST CASE SAR VALUE / POSITION / MODE

POSITION: The MC9062 in Holster rear facing to phantom*.
DISTANCE: 4.0cm from terminal case to phantom
MODE: GSM 1900.
SAR Value: 0.695 W/kg ((1g Limit 1.6 W/kg) 10g limit 2.0 W/kg).

* Note: Not designated as normal use position.



1.4 TEST RESULT SUMMARY

SYSTEM PERFORMANCE / VALIDATION CHECK RESULTS

Prior to formal testing being performed a System Check was performed in accordance with Appendix D IEEE1528 December 29, 2002 Draft Standard. The following results were obtained: -

Dipole Used	Frequency (MHz)	Max 1g SAR (W/kg)*	Percentage Drift on 1g Reference	Max 10g SAR (W/kg)*	Percentage Drift on 10g Reference
900	907.5	10.83*	0.30%	6.95*	0.79%
1800	1812	36.25*	-4.84%	19.53*	-0.013%
1900	1833.6	39.28*	-1.06%	20.88*	1.87%
2450	2450	49.9*	-4.78%	23.42*	-2.43%

*Normalised to 1W

MAXIMUM SAR VALUES

The following is a summary of the maximum SAR values found during the assessment.

GSM/GPRS 850 Specific Absorption Rate (Maximum SAR) 10g Results for the Symbol Technologies MC9062 Mobile Computer

Position	Channel Number	Frequency (MHz)	Max Spot SAR (W/kg)	Max 1g SAR (W/kg)	Max 10g SAR (W/kg)	SAR Drift dB	Area scan (Figure number)
LCD to Phantom in Holster	128	824.2	0.06	0.053	0.041	-0.13	Figure 18
LCD to Phantom in Holster	189	836.5	0.05	0.042	0.033	-0.13	Figure 19
LCD to Phantom in Holster	251	848.8	0.04	0.037	0.029	0.23	Figure 20
*Rear to Phantom in Holster	128	824.2	0.21	0.195	0.148	-0.05	Figure 21
Limit for General Population (Uncontrolled Exposure) 1.6 W/kg (1g) & 2.0 W/kg (10g)							

* Note: not designated as normal use position, data provided as additional information

GSM/GPRS 1800 Specific Absorption Rate (Maximum SAR) 10g Results for the Symbol Technologies MC9062 Mobile Computer

Position	Channel Number	Frequency (MHz)	Max Spot SAR (W/kg)	Max 1g SAR (W/kg)	Max 10g SAR (W/kg)	SAR Drift dB	Area scan (Figure number)
LCD to Phantom in Holster	698	1747.4	0.02	0.016	0.012	-0.45	Figure 22
LCD to Phantom in Holster	512	1710.2	0.01	0.014	0.010	0.29	Figure 23
LCD to Phantom in Holster	885	1784.8	0.02	0.020	0.015	0.00	Figure 24
*Rear to Phantom in Holster	885	1784.8	0.59	0.462	0.243	-0.05	Figure 25
Limit for General Population (Uncontrolled Exposure) 1.6 W/kg (1g) & 2.0 W/kg (10g)							

* Note: not designated as normal use position, data provided as additional information



1.4 TEST RESULT SUMMARY

GSM 1900 Specific Absorption Rate (Maximum SAR) 10g Results for the Symbol Technologies MC9062 Mobile Computer

Position	Channel Number	Frequency (MHz)	Max Spot SAR (W/kg)	Max 1g SAR (W/kg)	Max 10g SAR (W/kg)	SAR Drift dB	Area scan (Figure number)
LCD to Phantom in Holster	1850.2	512	0.02	0.022	0.015	0.23	Figure 26
LCD to Phantom in Holster	1880.0	661	0.02	0.016	0.011	-0.24	Figure 27
LCD to Phantom in Holster	1909.8	810	0.01	0.009	0.006	0.00	Figure 28
*Rear to Phantom in Holster	1850.2	512	0.90	0.695	0.370	-0.07	Figure 29
Limit for General Population (Uncontrolled Exposure) 1.6 W/kg (1g) & 2.0 W/kg (10g)							

* Note: Not designated as normal use position, data provided as additional information

Bluetooth 2450 MHz Specific Absorption Rate (Maximum SAR) 1g & 10g WLAN Results for Symbol Technologies MC9062 Mobile Computer at a distance of 10mm from the Flat Phantom (Body SAR)

Position	Channel Number	Frequency (MHz)	Max Spot SAR (W/kg)	Max 1g SAR (W/kg)	Max 10g SAR (W/kg)	SAR Drift dB	Area scan (Figure number)
MC9062 placed 1.0cm from phantom 2.0mm side	0	2402	0.03	0.026	0.016	0.17	Figure 30
MC9062 placed 1.0cm from phantom 2.0mm side	39	2441	0.06	0.030	0.023	0.09	Figure 31
MC9062 placed 1.0cm from phantom 2.0mm side	78	2480	0.04	0.029	0.019	0.00	Figure 32
Limit for General Population (Uncontrolled Exposure) 1.6 W/kg (1g) & 2.0 W/kg (10g)							

DSSS 2450 MHz Specific Absorption Rate (Maximum SAR) 1g & 10g WLAN Results for Symbol Technologies MC9062 Mobile Computer at a distance of 10mm from the Flat Phantom (Body SAR)

Position	Channel Number	Frequency (MHz)	Max Spot SAR (W/kg)	Max 1g SAR (W/kg)	Max 10g SAR (W/kg)	SAR Drift dB	Area scan (Figure number)
MC9062 placed 1.0cm from phantom 2.0mm side	1	2412	0.44	0.329	0.161	-0.418	Figure 33
MC9062 placed 1.0cm from phantom 2.0mm side	6	2437	0.51	0.380	0.184	-0.07	Figure 34
MC9062 placed 1.0cm from phantom 2.0mm side	11	2462	0.63	0.471	0.226	-0.07	Figure 35
MC9062 placed 1.0cm from phantom 2.0mm side	13	2472	0.69	0.516	0.246	-0.03	Figure 36
Limit for General Population (Uncontrolled Exposure) 1.6 W/kg (1g) & 2.0 W/kg (10g)							



1.4 TEST RESULT SUMMARY

OUTPUT POWER OF TEST DEVICE MEASUREMENT METHOD

For the Symbol Technologies MC9062 Mobile Computer.

The Spectrum Analyser was tuned to the test frequency. The device output power setting was controlled via the 'Test Mode' on each handset being set to the conditions specified in the Summary on page 5 of this document. The device was then rotated through 360 degrees until the highest power level was observed in both planes of polarisation. The device was then replaced with a substitution antenna, the signal to the antenna was adjusted to equal the related level detected from the device.

MAXIMUM POWER

Recorded from the Symbol Technologies MC9062 Mobile Computer

Radio Device	Frequency (MHz)	Raw Result (dBm)	Substitution Level (dBm)	Substitution Antenna Gain (dB)	Result ERP (dBm)	Result ERP (mW)
850MHz GSM MC46	824.2	-3.45	26.0	2.5	28.5	707.9
850MHz GSM MC46	836.5	-4.07	25.0	3.2	28.2	660.7
850MHz GSM MC46	848.8	-4.87	24.5	4.0	28.5	707.9
1800MHz GSM MC46	1710.2	-10.61	21.3	8.8	30.1	1023.3
1800MHz GSM MC46	1747.4	-11.54	20.2	8.9	29.1	812.8
1800MHz GSM MC46	1784.8	-10.78	20.4	8.9	29.3	851.1
1900MHz GSM MC46	1850.2	-10.5	23.6	8.9	32.5	1778.3
1900MHz GSM MC46	1880.0	-10.4	22.6	8.9	30.1	1023.3
1900MHz GSM MC46	1908.8	-12.0	21.2	8.9	30.1	1023.3
2.4GHz DSSS WLAN Radio	2412	-35.0	3.7	9.1	12.8	19.1
2.4GHz DSSS WLAN Radio	2437	-34.4	3.8	9.1	12.9	19.5
2.4GHz DSSS WLAN Radio	2462	-34.9	3.8	9.2	13.0	20.0
Symbol Bluetooth Module	2402	-36.9	1.5	9.1	10.6	11.5
Symbol Bluetooth Module	2441	-37.6	1.1	9.9	10.2	10.5
Symbol Bluetooth Module	2480	-42.2	-3.2	9.2	6.0	4.0



TEST DETAILS

The Specific Absorption Rate Assessment of the Symbol
MC9062 Mobile Computer.

TEST ENGINEER: A. MILLER



2.1 TEST EQUIPMENT

The following test equipment was used at BABT:

INSTRUMENT DESCRIPTION	MANUFACTURER	MODEL TYPE	INVENTORY NO.	SERIAL NUMBER	CALIBRATION DATES
Bench-top Robot	Mitsubishi	RV-E2	4691	EA009006	N/A
900 MHz – Head Tissue Simulant	BABT	Head	N/A	Batch 1	14/02/04*
850 MHz – Body Tissue Simulant	BABT	Body	N/A	Batch 1	14/02/04*
1800 MHz – Head Tissue Simulant	BABT	Head	N/A	Batch 4	14/02/04*
1800 MHz – Body Tissue Simulant	BABT	Body	N/A	Batch 1	14/02/04*
1900 MHz – Head Tissue Simulant	BABT	Head	N/A	Batch 1	14/02/04*
1900 MHz – Body Tissue Simulant	BABT	Body	N/A	Batch 1	14/02/04*
2450 MHz – Head Tissue Simulant	BABT	Head	N/A	Batch 5	14/02/04*
2450 MHz – Body Tissue Simulant	BABT	Body	N/A	Batch 3	14/02/04*
850 MHz Calibration Dipole	BABT	IIEEE1528	A	N/A	18/02/04*
1800 MHz Calibration Dipole	BABT	IIEEE1528	A	N/A	17/02/04*
1900 MHz Calibration Dipole	BABT	IIEEE1528	A	N/A	20/02/04*
2450 MHz Calibration Dipole	BABT	IIEEE1528	A	N/A	19/02/04*
RF Amplifier	Vectawave	10M-2.5G	4697	N/A	N/A
Directional Coupler	Krytar	1850	4651	N/A	TU
20dB Attenuator	Narda	766F-10	EMC 1791	1791	24/05/04 (due)
Power Meter	Rohde Schwarz	NRV	2472	860327/025	24/05/04 (due)
Hygrometer	Rotronic	I-1000	3230	N/A	04/10/04 (due)
Radio Communications Test Set	Rohde Schwarz	CMU200	4858	N/A	17/06/04 (due)
Digital Thermometer	Digitron	T208	3178	N/A	16/06/04 (due)
Thermocouple	RS	219-4539	4859	N/A	16/06/04 (due)
SAR Probe	IndexSAR	IXP-050	N/A	84	18/03/04 (due)
Flat Phantom box 2mm side(200mm cube)	IndexSAR.	N/A	N/A	N/A	N/A

* Verified at time of test.

2.2 TEST SOFTWARE

The following software was used to control the BABT SARA2 System:

INSTRUMENT	VERSION NO.	DATE
SARA2 system	v2.1 VPM	01/12/2003
Mitsubishi robot controller firmware revision	RV-E2 Version C9a	-
IXA-10 Probe amplifier	Version 2.5	-



2.3 DIELECTRIC PROPERTIES OF SIMULANT LIQUIDS

The fluids were calibrated in our Laboratory and re-checked prior to any measurements being made against reference fluids stated in IEEE 1528-200X of 0.9% NaCl (Salt Solution) at 23°C and also for Dimethylsulphoxide (DMS) at 21°C.

The fluids were made at BABT under controlled conditions from the following OET(65)c formulae and reference made to Draft Standard IEEE1528-200x. The composition of ingredients may have been modified accordingly to achieve the desired target tissue parameters required for routine SAR evaluation:

OET 65(c)Recipes

Ingredients (% by weight)	Frequency (MHz)									
	450		835		915		1900		2450	
Tissue Type	Head	Body	Head	Body	Head	Body	Head	Body	Head	Body
Water	38.56	51.16	41.45	52.4	41.05	56.0	54.9	40.4	62.7	73.2
Salt (NaCl)	3.95	1.49	1.45	1.4	1.35	0.76	0.18	0.5	0.5	0.04
Sugar	56.32	46.78	56.0	45.0	56.5	41.76	0.0	58.0	0.0	0.0
HEC	0.98	0.52	1.0	1.0	1.0	1.21	0.0	1.0	0.0	0.0
Bactericide	0.19	0.05	0.1	0.1	0.1	0.27	0.0	0.1	0.0	0.0
Triton X-100	0.0	0.0	0.0	0.0	0.0	0.0	0.0	0.0	36.8	0.0
DGBE	0.0	0.0	0.0	0.0	0.0	0.0	44.92	0.0	0.0	26.7
Dielectric Constant	43.42	58.0	42.54	56.1	42.0	56.8	39.9	54.0	39.8	52.5
Conductivity (S/m)	0.85	0.83	0.91	0.95	1.0	1.07	1.42	1.45	1.88	1.78

IEEE 1528 Recipes

Frequency (MHz)	300	450	835	900			1450	1800				1900	1950	2000	2100		2450			3000	
Recipe #	1	1	3	1	1	2	3	1	1	2	2	3	1	2	4	1	1	2	2	3	1
Ingredients (% by weight)																					
I,2-Propanediol						64.81															
Bactericide	0.19	0.19	0.5	0.1	0.1		0.5					0.5									0.5
Diacetin			48.9				49.2					49.43									49.75
DGBE								45.41	47	13.84	44.92		44.92	13.84	45	50	50	7.99	7.99		7.99
HEC	0.98	0.98		1	1																
NaCl	5.95	3.95	1.7	1.45	1.48	0.79	1.1	0.67	0.36	0.35	0.18	0.64	0.18	0.35					0.16	0.16	0.16
Sucrose	55.32	56.32		57	56.5																
Triton X-100											30.45									19.97	19.97
Water	37.56	38.56	48.9	40.45	40.92	34.4	49.2	53.82	52.64	55.36	54.9	49.43	54.9	55.36	55	50	50	71.88	71.88	49.75	71.88
Measured dielectric parameters																					
ϵ'_r	46	43.4	44.3	41.6	41.2	41.8	42.7	40.9	39.3	41	40.4	39.2	39.9	41	40.1	37	36.8	41.1	40.3	39.2	37.9
σ (S/m)	0.86	0.85	0.9	0.9	0.98	0.97	0.99	1.21	1.39	1.38	1.4	1.4	1.42	1.38	1.41	1.4	1.51	1.55	1.88	1.82	2.46
Temp. (°C)	22	22	20	22	22	22	20	22	22	21	22	20	21	21	20	22	22	20	20	20	20
Target dielectric parameters (Table 5-1)																					
ϵ'_r	45.3	43.5	41.5	41.5				40.5	40								39.8	39.2	38.5		
σ (S/m)	0.87	0.87	0.9	0.97				1.2	1.4								1.49	1.8	2.4		



2.3 DIELECTRIC PROPERTIES OF SIMULANT LIQUIDS

The dielectric properties of the tissue simulant liquids used for the SAR testing at BABT are as follows:-

FLUID TYPE AND FREQUENCY	RELATIVE PERMITTIVITY ϵ_r (ϵ') TARGET	RELATIVE PERMITTIVITY ϵ_r (ϵ') MEASURED	CONDUCTIVITY σ TARGET	CONDUCTIVITY σ MEASURED
Head 900MHz	41.5	42.08	0.97 S/m	0.987
Head 850MHz	41.5	42.62	0.90 S/m	0.914
Body 850MHz	55.2	57.65	0.97 S/m	0.993
Head 1800MHz	40.0	39.81	1.40 S/m	1.365
Body 1800MHz	53.3	54.96	1.52 S/m	1.585
Head 1900MHz	40.0	39.60	1.40 S/m	1.385
Body 1900MHz	53.3	52.29	1.52 S/m	1.543
Head 2450MHz	39.2	36.88	1.80 S/m	1.900
Body 2450MHz	52.7	51.32	1.95 S/m	2.040

Fluid Mass Density, $\rho = 1000 \text{ kg/m}^3$

2.4 TEST CONDITIONS

TEST LABORATORY CONDITIONS

Ambient Temperature: Within +15°C to +35°C at 20% RH to 75% RH.
 The actual Temperature during the testing ranged from 22.1°C to 24.5°C.
 The actual Humidity during the testing ranged from 16.8% to 29.8% RH.

TEST FLUID TEMPERATURE RANGE

TISSUE SIMULATING LIQUID TEMPERATURE: +20°C TO +25°C.								
FREQUENCY	850 MHz	850 MHz	1800 MHz	1800 MHz	1900 MHz	1900 MHz	2450 MHz	2450 MHz
BODY / HEAD FLUID	HEAD	BODY	HEAD	BODY	HEAD	BODY	HEAD	BODY
MIN TEMPERATURE	22.7	21.8	22.7	22.4	22.7	22.7	22.6	22.2
MAX TEMPERATURE	22.7	22.7	22.7	22.9	22.7	22.4	22.6	23.7

SAR DRIFT

SAR Drift during scans. The maximum SAR Drift, drift due to the mobile phone electronics, was recorded as -16.7% for all of the testing. The SAR drift figure of 16.7% has been included in the overall measurement uncertainty.



2.5 MEASUREMENT UNCERTAINTY

ERROR SOURCES	EN 50361 Description (Subclause)	Uncertainty (%)	Probability Distribution	Divisor	ci	ci ²	Standard Uncertainty (%)	Stand Uncert ²	(Stand Uncert ²) X (ci ²)	
Measurement Equipment										
Calibration	7.2.1.1	10	Normal	2.00	1	1	5.00	25.00	25.00	
Isotropy	7.2.1.2	10.6	Rectangular	1.73	1	1	6.12	37.45	37.45	
Linearity	7.2.1.3	2.92	Rectangular	1.73	1	1	1.69	2.84	2.84	
Probe Stability	-	2.46	Rectangular	1.73	1	1	1.42	2.02	2.02	
Detection limits	7.2.1.4	0	Rectangular	1.73	1	1	0.00	0.00	0.00	
Boundary effect	7.2.1.5	1.7	Rectangular	1.73	1	1	0.98	0.96	0.96	
Measurement device	7.2.1.6	0	Normal	1.00	1	1	0.00	0.00	0.00	
Response time	7.2.1.7	0	Normal	1.00	1	1	0.00	0.00	0.00	
Noise	7.2.1.8	0	Normal	1.00	1	1	0.00	0.00	0.00	
Integration time	7.2.1.9	2.3	Normal	1.00	1	1	2.30	5.29	5.29	
Mechanical constraints										
Scanning system	7.2.2.1	0.57	Rectangular	1.73	1	1	0.33	0.11	0.11	
Phantom shell	7.2.2.2	1.43	Rectangular	1.73	1	1	0.83	0.68	0.68	
Matching between probe and phantom	7.2.2.3	2.86	Rectangular	1.73	1	1	1.65	2.73	2.73	
Positioning of the phone 'Y' Co-ordinate	7.2.2.4	1.5	Normal	1.00	1	1	1.50	2.25	2.25	
Positioning of the phone 'Z' Co-ordinate	7.2.2.4	1.73	Normal	1.00	1	1	1.73	2.99	2.99	
Physical Parameters										
Liquid conductivity (deviation from target)	7.2.3.2	5	Rectangular	1.73	0.5	0.25	2.89	8.33	2.08	
Liquid conductivity (measurement error)	7.2.3.2	5	Rectangular	1.73	0.5	0.25	2.89	8.33	2.08	
Liquid permittivity (deviation from target)	7.2.3.3	5	Rectangular	1.73	0.5	0.25	2.89	8.33	2.08	
Liquid permittivity (measurement error)	7.2.3.3	5	Rectangular	1.73	0.5	0.25	2.89	8.33	2.08	
Drifts in output power of the phone, probe, temperature and humidity	7.2.3.4	16.7	Rectangular	1.73	0.5	0.25	9.64	92.96	92.96	
Perturbation by the environment	7.2.3.5	3	Rectangular	1.73	1	1	1.73	3.00	3.00	
Post-Processing										
SAR interpolation and extrapolation	7.2.4.1	2.4	Rectangular	1.73	1	1	1.39	1.92	1.92	
Maximum SAR evaluation	7.2.4.2	2.4	Rectangular	1.73	1	1	1.39	1.92	1.92	
Combined standard uncertainty	13.80						Total	190.46		
Expanded uncertainty = 27.60 % (Using a Coverage Factor of K=2) (confidence interval of 95 %)										



2.6 SAR MEASUREMENT SYSTEM

ROBOT SYSTEM SPECIFICATION

The SAR measurement system being used is the IndexSAR SARA2 system, which consists of a Mitsubishi RV-E2 6-axis robot arm and controller, IndexSAR probe and amplifier and SAM phantom Head Shape. The robot is used to articulate the probe to programmed positions inside the phantom head to obtain the SAR readings from the DUT.

The system is controlled remotely from a PC, which contains the software to control the robot and data acquisition equipment. The software also displays the data obtained from test scans.

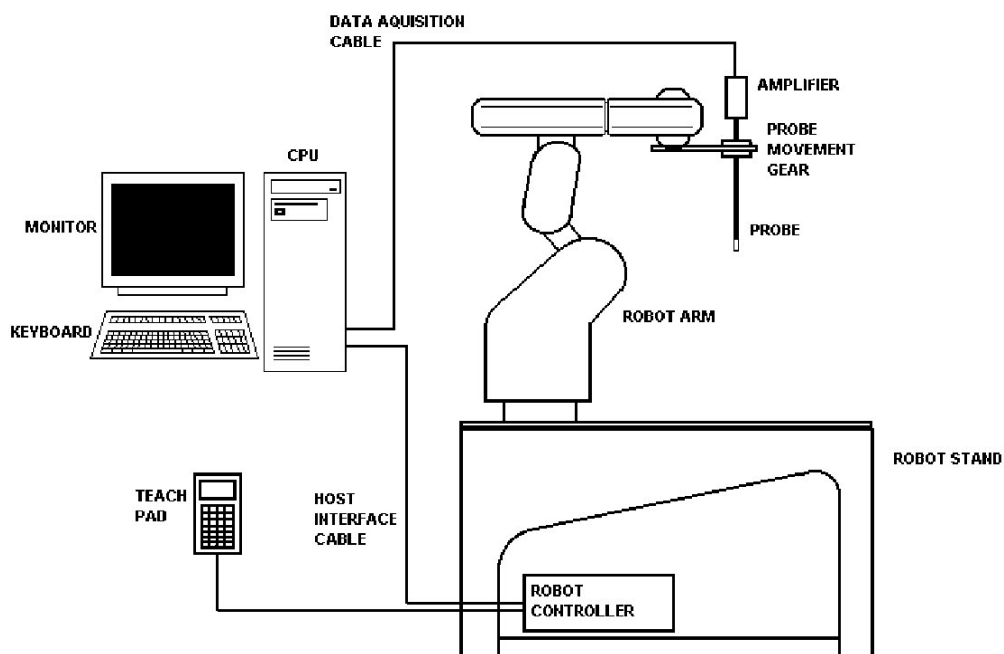

Figure 1: Schematic diagram of the SAR measurement system

The position and digitised shape of the phantom heads are made available to the software for accurate positioning of the probe and reduction of set-up time.

The SAM phantom heads are individually digitised using a Mitutoyo CMM machine to a precision of 0.001mm. The data is then converted into a shape format for the software, providing an accurate description of the phantom shell.

In operation, the system first does an area (2D) scan at a fixed depth within the liquid from the inside wall of the phantom. When the maximum SAR point has been found, the system will then carry out a 3D scan centred at that point to determine volume averaged SAR level.



2.6 SAR MEASUREMENT SYSTEM

PROBE AND AMPLIFIER SPECIFICATION

IXP-050 Indexsar isotropic immersible SAR probe

The probes are constructed using three orthogonal dipole sensors arranged on an interlocking, triangular prism core. The probes have built-in shielding against static charges and are contained within a PEEK cylindrical enclosure material at the tip. Probe calibration is described in the following section.

IXP-039 Amplifier

The amplifier unit has a multi-pole connector to connect to the probe and a multiplexer selects between the 3-channel single-ended inputs. A 16-bit AtoD converter with programmable gain is used along with an on-board micro-controller with non-volatile firmware. Battery life is around 150 hours and data are transferred to the PC via 3m of duplex optical fibre and a self-powered RS232 to optical converter.

Phantoms

The Specific Anthropomorphic Mannequin (SAM) Upright Phantom is fabricated using moulds generated from the CAD files as specified by CENELEC EN50361. It is mounted via a rotation base to a supporting table, which also holds the robotic positioner. The phantom and robot alignment is assured by both mechanical and laser registration systems.



2.6 SAR MEASUREMENT SYSTEM

PROBE CALIBRATION PROCEDURE

EQUIPMENT USED

For the first part of the characterisation procedure, the probe is placed in an isotropy measurement jig as pictured in Figure 2. In this position the probe can be rotated about its axis by a non-metallic belt driven by a stepper motor.

The probe is attached via its amplifier and an optical cable to a PC. A schematic representation of the test geometry is illustrated in Figure 3.

A balanced dipole (900 MHz) is inserted horizontally into the bracket attached to a second belt (Figure 2). The dipole can also be rotated about its axis. A cable connects the dipole to a signal generator, via a directional coupler and power meter. The signal generator feeds an RF amplifier at constant power, the output of which is monitored using the power meter. The probe is positioned so that its sensors line up with the rotation center of the source dipole. By recording output voltage measurements of each channel as both the probe and the dipole are rotated, data are obtained from which the spherical isotropy of the probe can be optimised and its magnitude determined.

The calibration process requires E-field measurements to be taken in air, in 900 MHz simulated brain liquid and at other frequencies/liquids as appropriate.

LINEARISING PROBE OUTPUT

The probe channel output signals are linearised in the manner set out in Refs [1] and [2]. The following equation is utilized for each channel:

$$U_{lin} = U_{o/p} + U_{o/p}^2 / DCP \quad (1)$$

where U_{lin} is the linearised signal, $U_{o/p}$ is the raw output signal in voltage units and DCP is the diode compression potential in similar voltage units.

DCP is determined from fitting equation (1) to measurements of U_{lin} versus source feed power over the full dynamic range of the probe. The DCP is a characteristic of the schottky diodes used as the sensors. For the IXP-050 probes with CW signals the DCP values are typically 0.10V (or 20 in the voltage units used by Indexsar software, which are $V*200$).

SELECTING CHANNEL SENSITIVITY FACTORS TO OPTIMISE ISOTROPIC RESPONSE

The basic measurements obtained using the calibration jig (Fig 2) represent the output from each diode sensor as a function of the presentation angle of the source (probe and dipole rotation angles). The directionality of the orthogonally-arranged sensors can be checked by analysing the data using dedicated Indexsar software, which displays the data in 3D format as in Figure 4. The left-hand side of this diagram shows the individual channel outputs after linearisation (see above). The program uses these data to balance the channel outputs and then applies an optimisation process, which makes fine adjustments to the channel factors for optimum isotropic response.



2.6 SAR MEASUREMENT SYSTEM

PROBE CALIBRATION PROCEDURE - Continued

The next stage of the process is to calibrate the Indexsar probe to a W&G EMR300 E-field meter in air. The principal reasons for this are to obtain conversion factors applicable should the probe be used in air and to provide an overall measure of the probe sensitivity.

A multiplier is applied to factors to bring the magnitudes of the average E-field measurements as close as possible to those of the W&G probe.

The following equation is used (where linearised output voltages are in units of V*200):

$$E_{air}^2 \text{ (V/m)} = U_{linx} * \text{Air Factor}_x + U_{liny} * \text{Air Factor}_y + U_{linz} * \text{Air Factor}_z \quad (2)$$

It should be noted that the air factors are not separately used for normal SAR testing. The IXP-050 probes are optimised for use in tissue-simulating liquids and do not behave isotropically in air.

900 MHz LIQUID CALIBRATION

Conversion factors for use when the probes are immersed in tissue-simulant liquids at 900 MHz are determined either using a waveguide or by comparison to a reference probe that has been calibrated by NPL. Waveguide procedures are described later. The summary sheet indicates the method used for the probe S/N 0084.

The conversion factor, referred to as the 'liquid factor' is also applied to the measurements of each channel. The following equation is used (where output voltages are in units of V*200):

$$E_{liq}^2 \text{ (V/m)} = U_{linx} * \text{Air Factor}_x * \text{Liq Factor}_x + U_{liny} * \text{Air Factor}_y * \text{Liq Factor}_y + U_{linz} * \text{Air Factor}_z * \text{Liq Factor}_z \quad (3)$$

A 3D representation of the spherical isotropy for probe S/N 0084 using these factors is shown in Figure 4

The rotational isotropy can also be determined from the calibration jig measurements and is reported as the 900MHz isotropy in the summary table. Note that waveguide measurements can also be used to determine rotational isotropy (Fig. 6).

The design of the cells used for determining probe conversion factors are waveguide cells is shown in Figure 5. The cells consist of a coax to waveguide transition and an open-ended section of waveguide containing a dielectric separator. Each waveguide cell stands in the upright position and is filled with liquid within 10 mm of the open end. The separator provides a liquid seal and is designed for a good electrical transition from air filled guide to liquid filled guide. The choice of cell depends on the portion of the frequency band to be examined and the choice of liquid used. The depth of liquid ensures there is negligible radiation from the waveguide open top and that the probe calibration is not influenced by reflections from nearby objects. The return loss at the coaxial connector of the filled waveguide cell is measured initially using a network analyser and this information is used subsequently in the calibration procedure. The probe is positioned in the centre of the waveguide and is adjusted vertically or rotated using stepper motor arrangements. The signal generator is connected to the waveguide cell and the power is monitored with a coupler and a power meter. A fuller description of the waveguide method is given below.



2.6 SAR MEASUREMENT SYSTEM

PROBE CALIBRATION PROCEDURE - Continued

The liquid dielectric parameters used for the probe calibrations are listed in the Tables below. The final calibration factors for the probe are listed in the summary chart.

WAVEGUIDE MEASUREMENT PROCEDURE

The calibration method is based on setting up a calculable specific absorption rate (SAR) in a vertically-mounted WG8 (R22) waveguide section [1]. The waveguide has an air-filled, launcher section and a liquid-filled section separated by a matching window that is designed to minimise reflections at the liquid interface. A TE_{01} mode is launched into the waveguide by means of a N-type-to-waveguide adapter. The power delivered to the liquid section is calculated from the forward power and reflection coefficient measured at the input to the waveguide. At the centre of the cross-section of the waveguide, the local spot SAR in the liquid as a function of distance from the window is given by functions set out in IEEE1528 as below:

Because of the low cutoff frequency, the field inside the liquid nearly propagates as a TEM wave. The depth of the medium (greater than three penetration depths) ensures that reflections at the upper surface of the liquid are negligible. The power absorbed in the liquid is determined by measuring the waveguide forward and reflected power. Equation (4) shows the relationship between the SAR at the cross-sectional center of the lossy waveguide and the longitudinal distance (z) from the dielectric separator

$$SAR(z) = \frac{4(P_f - P_b)}{\rho ab\delta} e^{-2z/\delta} \quad (4)$$

where the density ρ is conventionally assumed to be 1000 kg/m^3 , ab is the cross-sectional area of the waveguide, P_f and P_b are the forward and reflected power inside the lossless section of the waveguide, respectively. The penetration depth δ , which is the reciprocal of the waveguide-mode attenuation coefficient, is determined from a scan along the z -axis and compared with the theoretical value determined from Equation (5) using the measured dielectric properties of the lossy liquid.

$$\delta = \left[\text{Re} \left\{ \sqrt{(\pi/a)^2 + j\omega\mu_o(\sigma + j\omega\varepsilon_o\varepsilon_r)} \right\} \right]^{-1} \quad (5)$$

Table A.1 of [1] can be used for designing calibration waveguides with a return loss greater than 30 dB at the most important frequencies used for personal wireless communications. Values for the penetration depth for these specific fixtures and tissue-simulating mixtures are also listed in Table A.1.

According to [1], this calibration technique provides excellent accuracy, with standard uncertainty of less than 3.6% depending on the frequency and medium. The calibration itself is reduced to power measurements traceable to a standard calibration procedure. The practical limitation to the frequency band of 800 to 2500 MHz because of the waveguide size is not severe in the context of compliance testing.



2.6 SAR MEASUREMENT SYSTEM

PROBE CALIBRATION PROCEDURE - Continued

CALIBRATION FACTORS MEASURED FOR PROBE S/N 0084

The probe was calibrated at 900, 1800, 1900 and 2450MHz in liquid samples representing both brain liquid and body fluid at these frequencies. The calibration was for CW signals only, and the axis of the probe was parallel to the direction of propagation of the incident field i.e. end-on to the incident radiation. The axial isotropy of the probe was measured by rotating the probe about its axis in 10 degree steps through 360 degrees in this orientation.

The reference point for the calibration is in the centre of the probe's cross-section at a distance of 2.7 mm from the probe tip in the direction of the probe amplifier. A value of 2.7 mm should be used for the tip to sensor offset distance in the software.

It is important that the diode compression point and air factors used in the software are the same as those quoted in the results tables, as these are used to convert the diode output voltages to a SAR value.

DIELECTRIC PROPERTIES OF LIQUIDS

The dielectric properties of the brain and body tissue-simulant liquids employed for calibration are listed in the tables below. The measurements were performed prior to each waveguide test using an Indexasar DiLine measurement kit, which uses the TEM method as recommended in [2].

AMBIENT CONDITIONS

Measurements were made in the open laboratory at $22 \pm 2.0^{\circ}\text{C}$. The temperature of the liquids in the waveguide used was measured using a mercury thermometer.

RESPONSE TO MODULATED SIGNALS

To measure the response of the probe and amplifier to modulated signals, the probe is held vertically in a liquid-filled waveguide.

An RF amplifier is allowed to warm up and stabilise before use. A spectrum analyser is used to demonstrate that the peak power of the RF amplifier for the CW signals and the pulsed signals are within 0.1dB of each other when the signal generator is switched from CW to modulated output. Subsequently, the power levels recorded are read from a power meter when a CW signal is being transmitted.

The test sequence involves manually stepping the power up in regular (e.g. 2 dB) steps from the lowest power that gives a measurable reading on the SAR probe up to the maximum that the amplifiers can deliver.

At each power level, the individual channel outputs from the SAR probe are recorded at CW and then recorded again with the modulation setting. The results are entered into a spreadsheet. Using the spreadsheets, the modulated power is calculated by applying a factor to the measured CW power (e.g. for GSM, this factor is 9.03dB). This process is repeated 3 times with the response maximised for each channel sensor in turn.



2.6 SAR MEASUREMENT SYSTEM

PROBE CALIBRATION PROCEDURE - Continued

The probe channel output signals are linearised in the manner set out in Section 1 above using equation (1) with the DCPs determined from the linearisation procedure. Calibration factors for the probe are used to determine the E-field values corresponding to the probe readings using equation (3). SAR is determined from the equation

$$\text{SAR (W/kg)} = E_{\text{liq}}^2 \text{ (V/m)} * \sigma \text{ (S/m)} / 1000 \quad (6)$$

Where σ is the conductivity of the simulant liquid employed.

Using the spreadsheet data, the DCP value for linearising each of the individual channels (X, Y and Z) is assessed separately. The corresponding DCP values are listed in the summary page of the calibration factors for each probe.

Figure 9 shows the linearised probe response to 900MHz GSM signals, Figure 9a the response to 1800MHz GSM signals, Figure 10 the response to GPRS signals (GSM with 2 timeslots) and Figure 11 & 12 the response to CDMA IS-95A and W-CDMA signals.

Additional tests have shown that the modulation response is similar at 1800MHz and is not affected by the orientation between the source and the probe.



2.6 SAR MEASUREMENT SYSTEM

PROBE CALIBRATION PROCEDURE - Continued

SUMMARY OF CALIBRATION FACTORS FOR PROBE IXP-050 S/N 0084

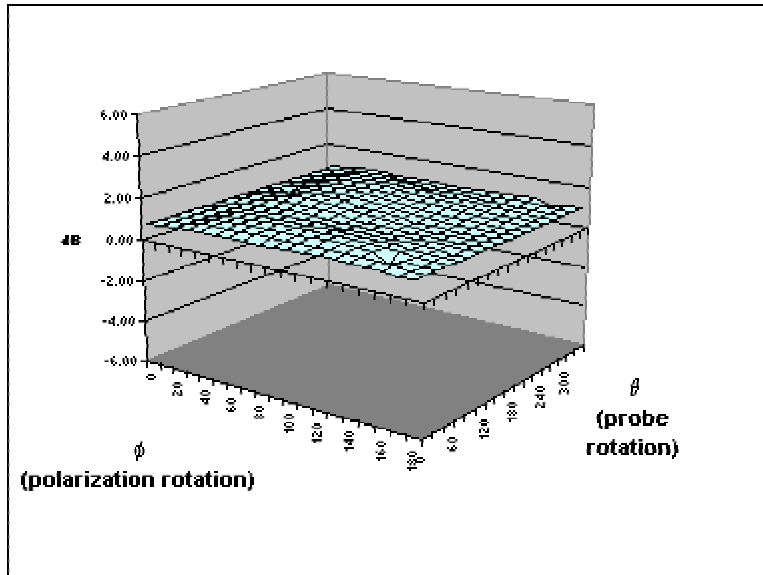

	X	Y	Z	
Air factors	500	410	385	(V*200)
DCPs	20	20	20	(V*200)
GSM	10.9	13	11.4	(V*200)
GPRS	16.1	16.1	14.7	(V*200)
CDMA	20	20	20	(V*200)

f (MHz)	Axial isotropy (+/- dB)		SAR conversion factors(liq/air)		Notes
	BRAIN	BODY	BRAIN	BODY	
900	0.09	0.09	0.279	0.300	3,4
1800	0.12	0.10	0.342	0.375	3,4
1900	0.13	0.10	0.354	0.405	3,4
2450	0.12	0.09	0.396	0.468	3,4

Notes	
1)	Calibrations done at 22C +/- 2C
2)	Probe calibration by substitution against NPL-calibrated probe (Probe IXP-050 S/N0071; NPL Cal Rept. No: EF07/2002/03/IndexSAR)
3)	Waveguide calibration
4)	Checked using box-phantom validation test

(The graph shows a simple, spreadsheet representation of surface shown in 3D in Figure 4)



2.6 SAR MEASUREMENT SYSTEM

PROBE CALIBRATION PROCEDURE - Continued

PROBE SPECIFICATIONS

IndexSAR probe 0084, along with its calibration, is compared with CENELEC and IEEE standards recommendations (Refs [1] and [2]) in the Tables below. A listing of relevant specifications is contained in the tables below:

DIMENSIONS	S/N 0084	CENELEC [1]	IEEE [2]
Overall length (mm)	350	-	-
Tip length (mm)	10	-	-
Body diameter (mm)	12	-	-
Tip diameter (mm)	5.2	8	8
Distance from probe tip to dipole centers (mm)	2.7	-	-

DYNAMIC RANGE	S/N 0084	CENELEC [1]	IEEE [2]
Minimum (W/kg)	0.01	<0.02	0.01
Maximum (W/kg)	>100	>100	100

LINEARITY OF RESPONSE	S/N 0084	CENELEC [1]	IEEE [2]
Over range 0.01 – 100 W/kg (+/- dB)	0.125	0.50	0.25

Isotropy (measured at 900MHz)	S/N 0084	CENELEC [1]	IEEE [2]
Axial rotation with probe normal to source (+/- dB) at 900, 1800, 1900 and 2450 MHz	Max. 0.13 (see summary table)	0.5	0.25
Spherical isotropy covering all orientations to source (+/- dB)	0.34	1.0	0.50

CONSTRUCTION	Each probe contains three orthogonal dipole sensors arranged on a triangular prism core, protected against static charges by built-in shielding, and covered at the tip by PEEK cylindrical enclosure material. No adhesives are used in the immersed section. Outer case materials are PEEK and heat-shrink sleeving.
CHEMICAL RESISTANCE	Tested to be resistant to glycol and alcohol containing simulant liquids but probes should be removed, cleaned and dried when not in use.

2.6 SAR MEASUREMENT SYSTEM

PROBE CALIBRATION PROCEDURE - Continued

REFERENCES

- [1] CENELEC, EN 50361, July 2001. Basic Standard for the measurement of specific absorption rate related to human exposure to electromagnetic fields from mobile phones.
- [2] IEEE 1528, Recommended practice for determining the spatial-peak specific absorption rate (SAR) in the human body due to wireless communications devices: Experimental techniques.
- [3] Calibration report on SAR probe IXP-050 S/N 0071 from National Physical Laboratory. Test Report EF07/2002/03/IndexSAR. Dated 20 February 2002.

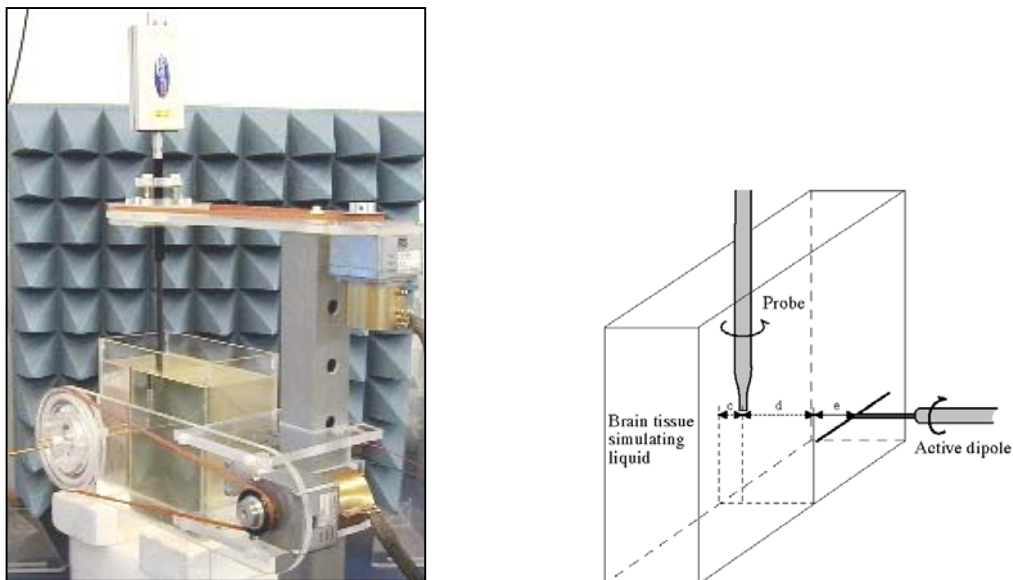

Figure 2. Spherical isotropy jig showing probe, dipole and box filled with simulated brain liquid (see Ref [2], Section A.5.2.1)

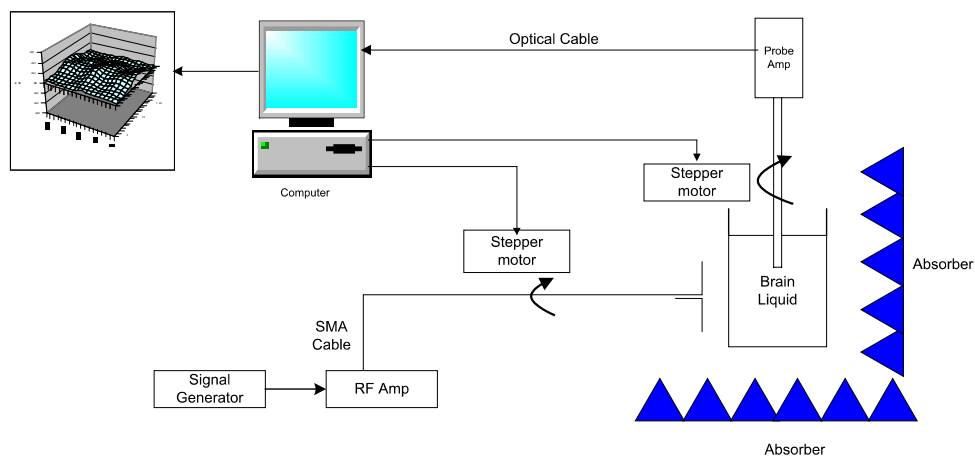

Figure 3. Schematic diagram of the test geometry used for isotropy determination



2.6 SAR MEASUREMENT SYSTEM

PROBE CALIBRATION PROCEDURE - Continued

REFERENCES

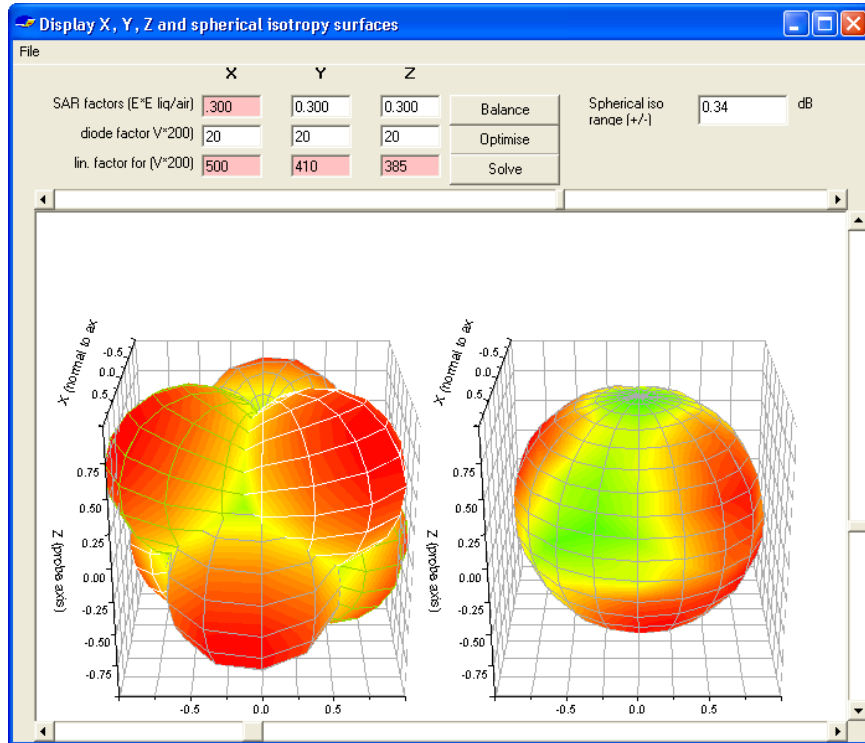

Figure 4. Graphical representation of the probe response to fields applied from each direction. The diagram on the left shows the individual response characteristics of each of the three channels and the diagram on the right shows the resulting probe sensitivity in each direction. The colour range in the figure images the lowest values as blue and the maximum values as red. For the probe S/N 0084, this range is (+/-) 0.34 dB. The probe is more sensitive to fields parallel to the axis and less sensitive to fields normal to the probe axis.

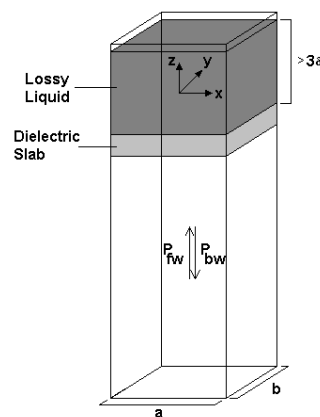

Figure 5. Geometry used for waveguide calibration (after Ref [2]. Section A.3.2.2)



2.6 SAR MEASUREMENT SYSTEM

PROBE CALIBRATION PROCEDURE - Continued

REFERENCES

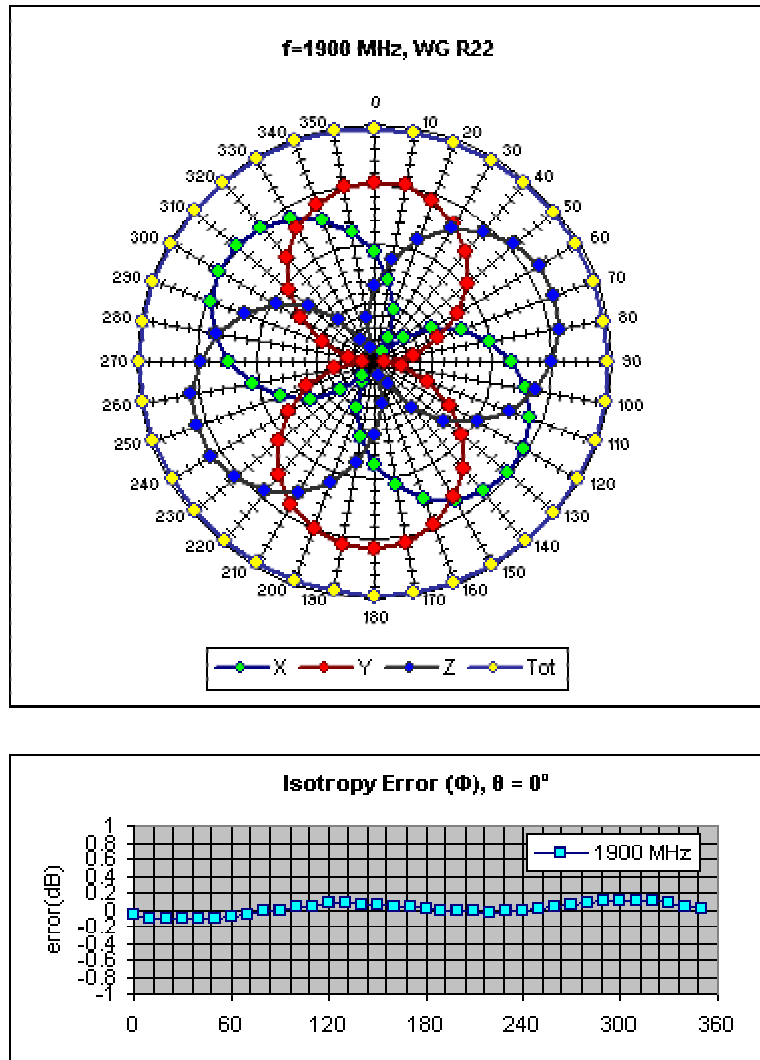

Figure 6. Example of the rotational isotropy of probe S/N 0084 obtained by rotating the probe in a liquid-filled waveguide at 1800 MHz. Similar distributions are obtained at the other test frequencies (900, 1900 and 2450 MHz) both in brain liquids and body fluids (see summary table)



2.6 SAR MEASUREMENT SYSTEM

PROBE CALIBRATION PROCEDURE - Continued

REFERENCES

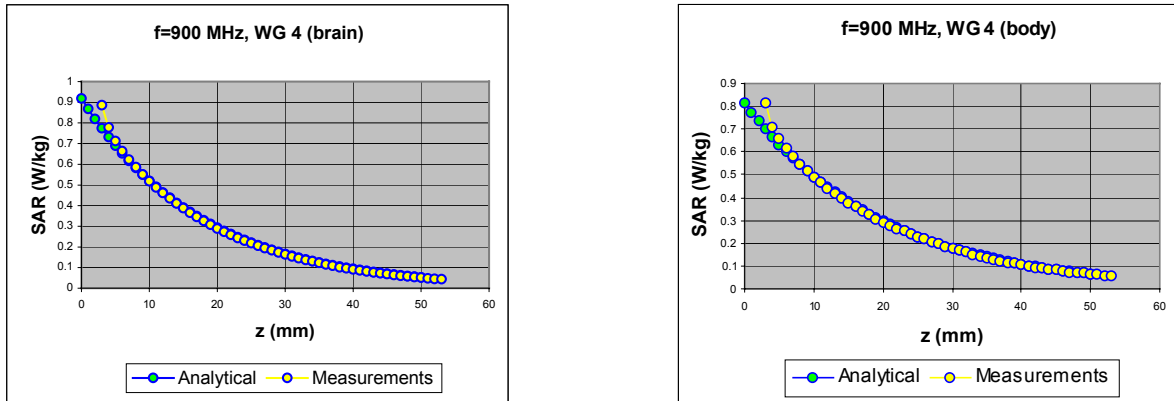

Figure 7. The measured SAR decay function along the centreline of the WG4 waveguide with conversion factors adjusted to fit to the theoretical function for the particular dimension, frequency, power and liquid properties employed.

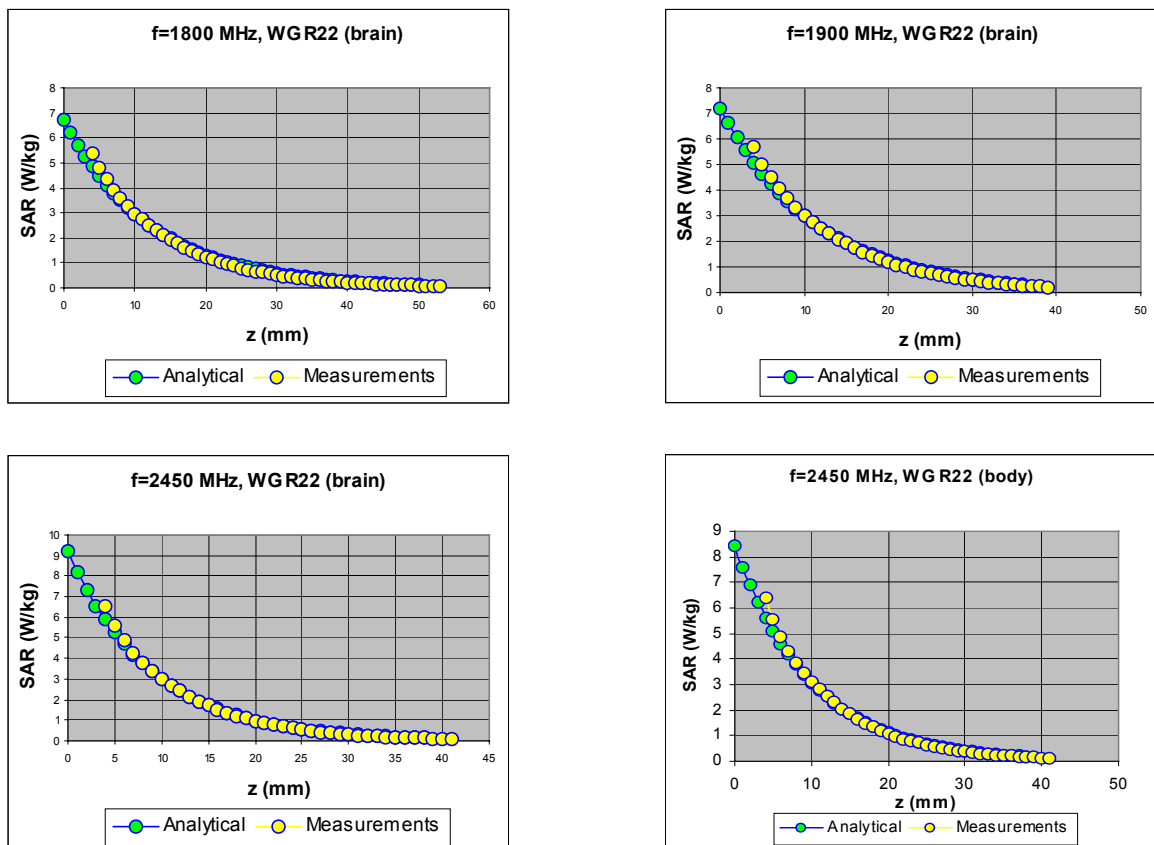

Figure 8. The measured SAR decay function along the centreline of the R22 waveguide with conversion factors adjusted to fit to the theoretical function for the particular dimension, frequency, power and liquid properties employed.



2.6 SAR MEASUREMENT SYSTEM

PROBE CALIBRATION PROCEDURE - Continued

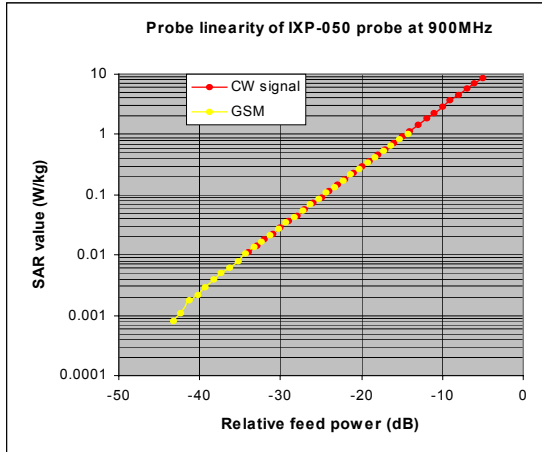

Figure 9. The GSM response of an IXP-050 probe at 900MHz

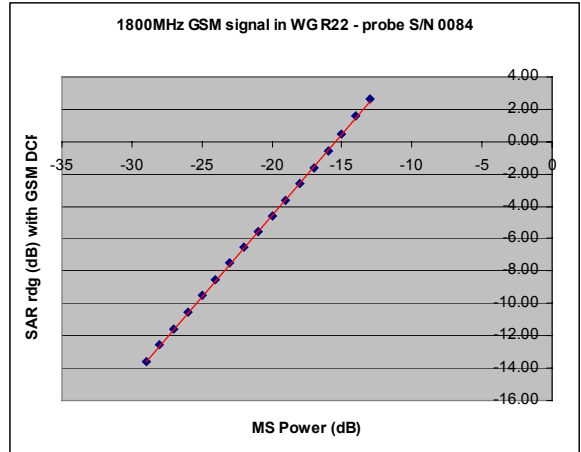

Figure 9a. The actual GSM response of IXP-050 probe S/N 0084 at 1800MHz.

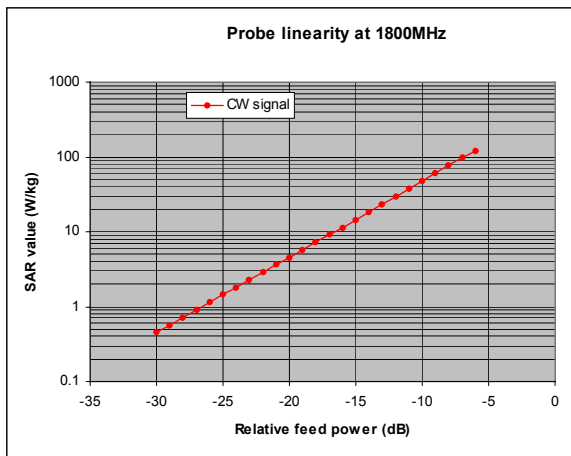

Figure 9b. The actual CW response of IXP-050 probe SN0084 up to 100W/kg

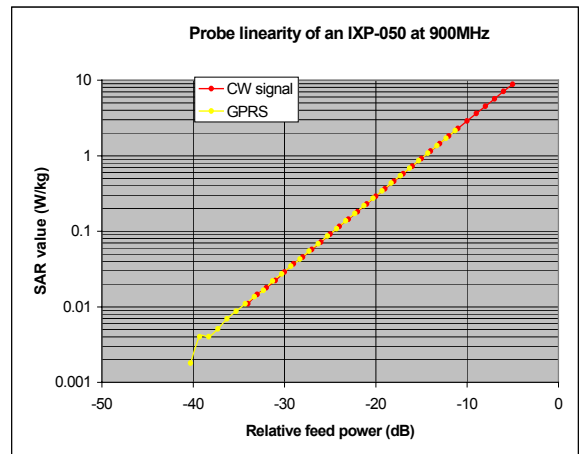

Figure 10. The GPRS response of an IXP-050 probe at 900MHz.



2.6 SAR MEASUREMENT SYSTEM

PROBE CALIBRATION PROCEDURE - Continued

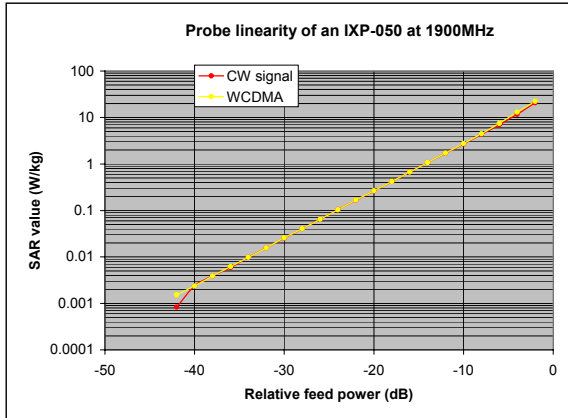

Figure 11. The WCDMA response of an IXP-050 probe at 1900MHz.

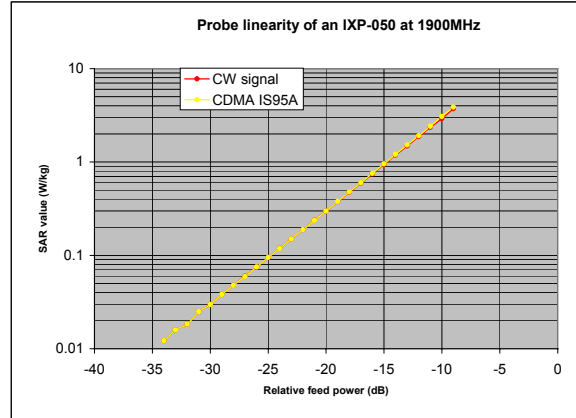

Figure 12. The CDMA IS95A response of an IXP-050 probe at 1900MHz.

TABLE INDICATING THE DIELECTRIC PARAMETERS OF THE LIQUIDS USED FOR CALIBRATIONS AT EACH FREQUENCY

Liquid used	Relative permittivity (measured)	Conductivity (S/m) (measured)
900 MHz BRAIN	41.8	1.00
900 MHz BODY	57.5	1.031
1800 MHz BRAIN	38.64	1.38
1800 MHz BODY	54.3	1.587
1900 MHz BRAIN	38.12	1.47
1900 MHz BODY	52.97	1.46
2450 MHz BRAIN	38.67	1.881
2450 MHz BODY	52.19	1.949



2.6 SAR MEASUREMENT SYSTEM

SAR MEASUREMENT PROCEDURE

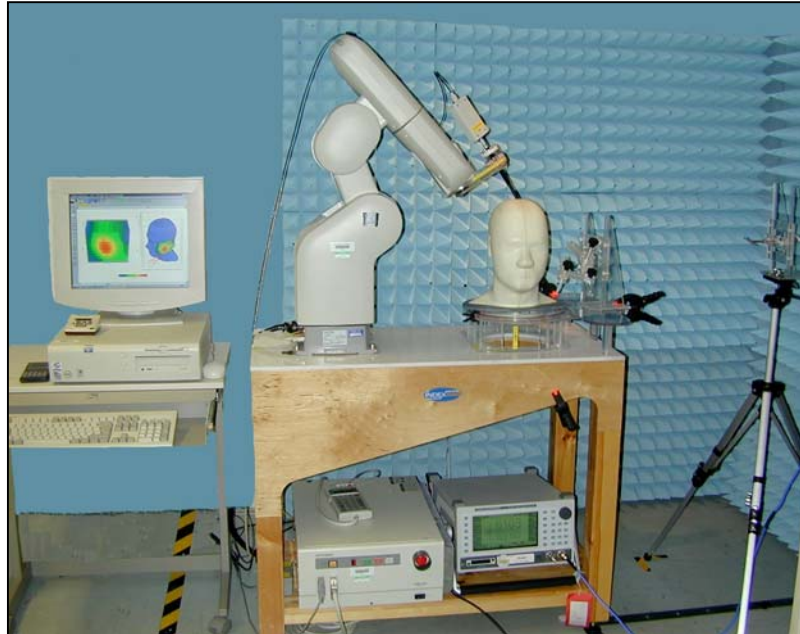

Figure 13: Principal components of the SAR measurement test bench

The major components of the test bench are shown in the picture above. A test set and dipole antenna control the handset via an air link and a low-mass phone holder can position the phone at either ear. Graduated scales are provided to set the phone in the 15 degree position. The upright phantom head holds approx. 7 litres of simulant liquid. The phantom is filled and emptied through a 45mm diameter penetration hole in the top of the head.

After an area scan has been done at a fixed distance of 8mm from the surface of the phantom on the source side, a 3D scan is set up around the location of the maximum spot SAR. First, a point within the scan area is visited by the probe and a SAR reading taken at the start of testing. At the end of testing, the probe is returned to the same point and a second reading is taken. Comparison between these start and end readings enables the power drift during measurement to be assessed.

SARA2 Interpolation and Extrapolation schemes

SARA2 software contains support for both 2D cubic B-spline interpolation as well as 3D cubic B-spline interpolation. In addition, for extrapolation purposes, a general n^{th} order polynomial fitting routine is implemented following a singular value decomposition algorithm presented in [4]. A 4th order polynomial fit is used by default for data extrapolation, but a linear-logarithmic fitting function can be selected as an option. The polynomial fitting procedures have been tested by comparing the fitting coefficients generated by the SARA2 procedures with those obtained using the polynomial fit functions of Microsoft Excel when applied to the same test input data.

Interpolation of 2D area scan

The 2D cubic B-spline interpolation is used after the initial area scan at fixed distance from the phantom shell wall. The initial scan data are collected with approx. 10mm spatial resolution and spline interpolation is used to find the location of the local maximum to within a 1mm resolution for positioning the subsequent 3D scanning.



2.6 SAR MEASUREMENT SYSTEM

SAR MEASUREMENT PROCEDURE - Continued

Extrapolation of 3D scan

For the 3D scan, data are collected on a spatially regular 3D grid having (by default) 6.4 mm steps in the lateral dimensions and 3.5 mm steps in the depth direction (away from the source). SARA2 enables full control over the selection of alternative step sizes in all directions.

The digitised shape of the head is available to the SARA2 software, which decides which points in the 3D array are sufficiently well within the shell wall to be 'visited' by the SAR probe. After the data collection, the data are extrapolated in the depth direction to assign values to points in the 3D array closer to the shell wall. A notional extrapolation value is also assigned to the first point outside the shell wall so that subsequent interpolation schemes will be applicable right up to the shell wall boundary.

Interpolation of 3D scan and volume averaging

The procedure used for defining the shape of the volumes used for SAR averaging in the SARA2 software follow the method of adapting the surface of the 'cube' to conform with the curved inner surface of the phantom (see Appendix C.2.2.1 in EN 50361). This is called, here, the conformal scheme.

For each row of data in the depth direction, the data are extrapolated and interpolated to less than 1mm spacing and average values are calculated from the phantom surface for the row of data over distances corresponding to the requisite depth for 10g and 1g cubes. This results in two 2D arrays of data, which are then cubic B-spline interpolated to sub mm lateral resolution. A search routine then moves an averaging square around through the 2D array and records the maximum value of the corresponding 1g and 10g volume averages. For the definition of the surface in this procedure, the digitised position of the headshell surface is used for measurement in head-shaped phantoms. For measurements in rectangular, box phantoms, the distance between the phantom wall and the closest set of gridded data points is entered into the software.

For measurements in box-shaped phantoms, this distance is under the control of the user. The effective distance must be greater than 2.5mm as this is the tip-sensor distance and to avoid interface proximity effects, it should be at least 5mm. A value of 6 or 8mm is recommended. This distance is called **dbe** in EN 50361.

For automated measurements inside the head, the distance cannot be less than 2.5mm, which is the radius of the probe tip and to avoid interface proximity effects, a minimum clearance distance of x mm is retained. The actual value of **dbe** will vary from point to point depending upon how the spatially-regular 3D grid points fit within the shell. The greatest separation is when a grid point is just not visited due to the probe tip dimensions. In this case the distance could be as large as the step-size plus the minimum clearance distance (i.e with $x=5$ and a step size of 3.5, **dbe** will be between 3.5 and 8.5mm).

The default step size (**dstep** in EN 50361) used is 3.5mm, but this is under user-control. The compromise is with time of scan, so it is not practical to make it much smaller or scan times become long and power-drop influences become larger.

The robot positioning system specification for the repeatability of the positioning (**dss** in EN50361) is +/- 0.04mm.



2.6 SAR MEASUREMENT SYSTEM

SAR MEASUREMENT PROCEDURE - Continued

The phantom shell is made by an industrial moulding process from the CAD files of the SAM shape, with both internal and external moulds. For the upright phantoms, the external shape is subsequently digitised on a Mitutoyo CMM machine (Euro C574) to a precision of 0.001mm. Wall thickness measurements made non-destructively with an ultrasonic sensor indicate that the shell thickness (**dph**) away from the ear is 2.0 +/- 0.1mm. The ultrasonic measurements were calibrated using additional mechanical measurements on available cut surfaces of the phantom shells.

For the upright phantom, the alignment is based upon registration of the rotation axis of the phantom on its 253mm-diameter baseplate bearing and the position of the probe axis when commanded to go to the axial position. A laser alignment tool is provided (procedure detailed elsewhere). This enables the registration of the phantom tip (**dmis**) to be assured to within approx. 0.2mm. This alignment is done with reference to the actual probe tip after installation and probe alignment. The rotational positioning of the phantom is variable – offering advantages for special studies, but locating pins ensure accurate repositioning at the principal positions (LH and RH ears).



2.7 TEST POSITIONS

OET65(c) FLAT PHANTOM TEST POSITIONS – GRAPHICAL REPRESENTATION

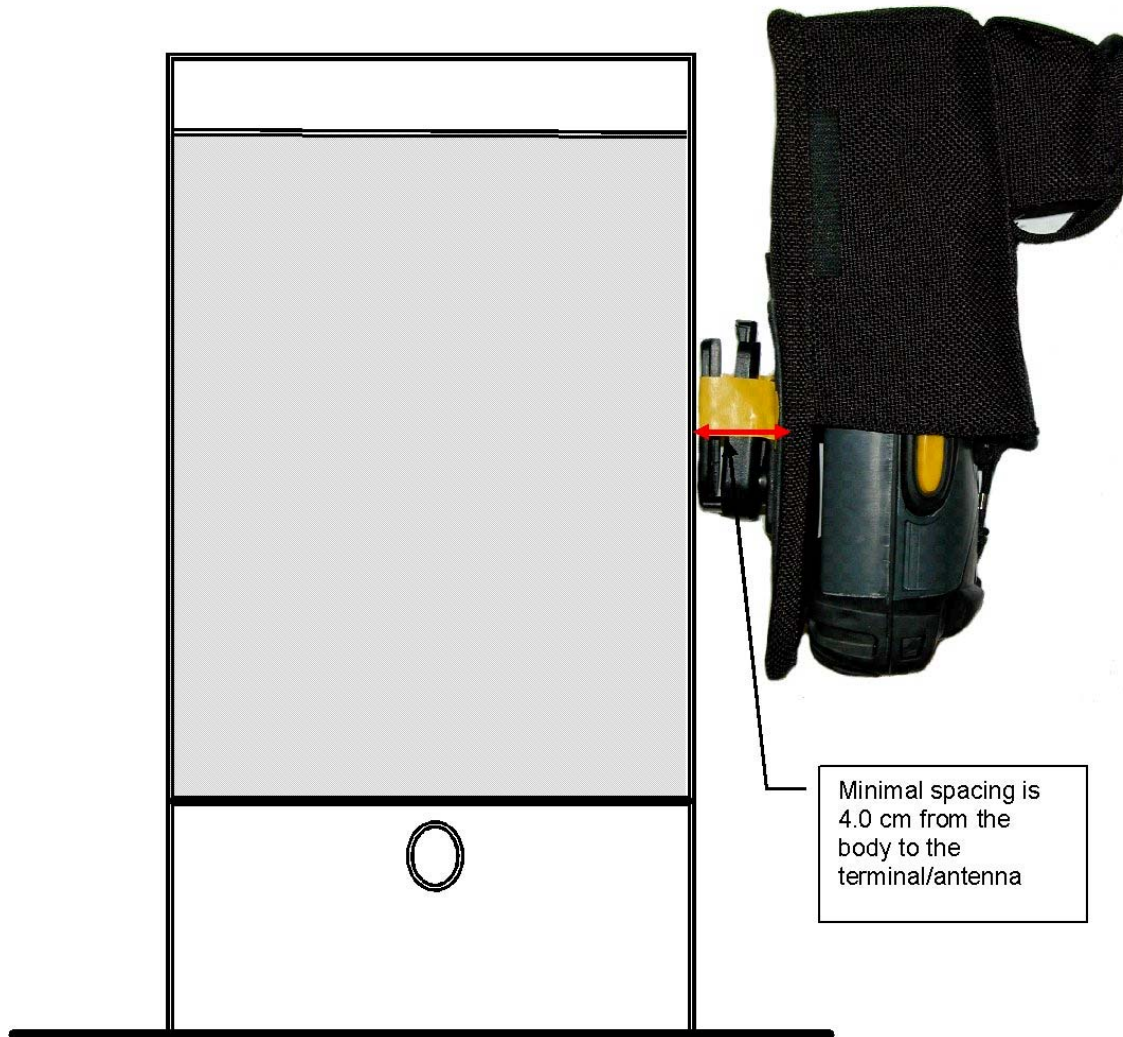

Figure 14. – MC9062 Test position for body assessment in declared NORMAL use position; holster belt clip 0.0 cm from phantom side.



2.7 TEST POSITIONS

OET65(c) FLAT PHANTOM TEST POSITIONS – GRAPHICAL REPRESENTATION

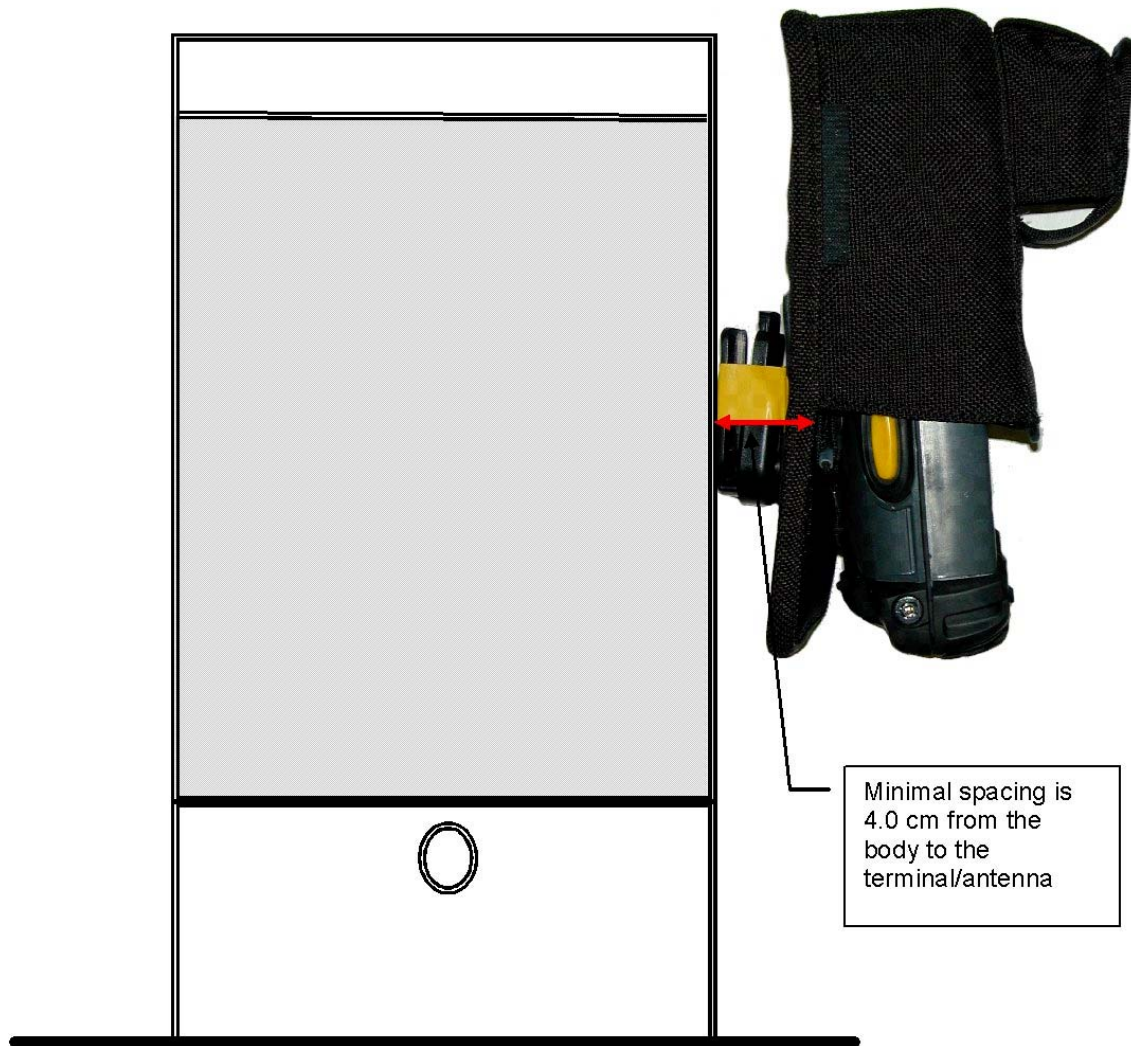

Figure 15. – MC9062 Test position for body assessment in declared ABNORMAL use position; holster belt clip 0.0 cm from phantom side.



2.7 TEST POSITIONS

OET65(c) FLAT PHANTOM TEST POSITIONS – GRAPHICAL REPRESENTATION

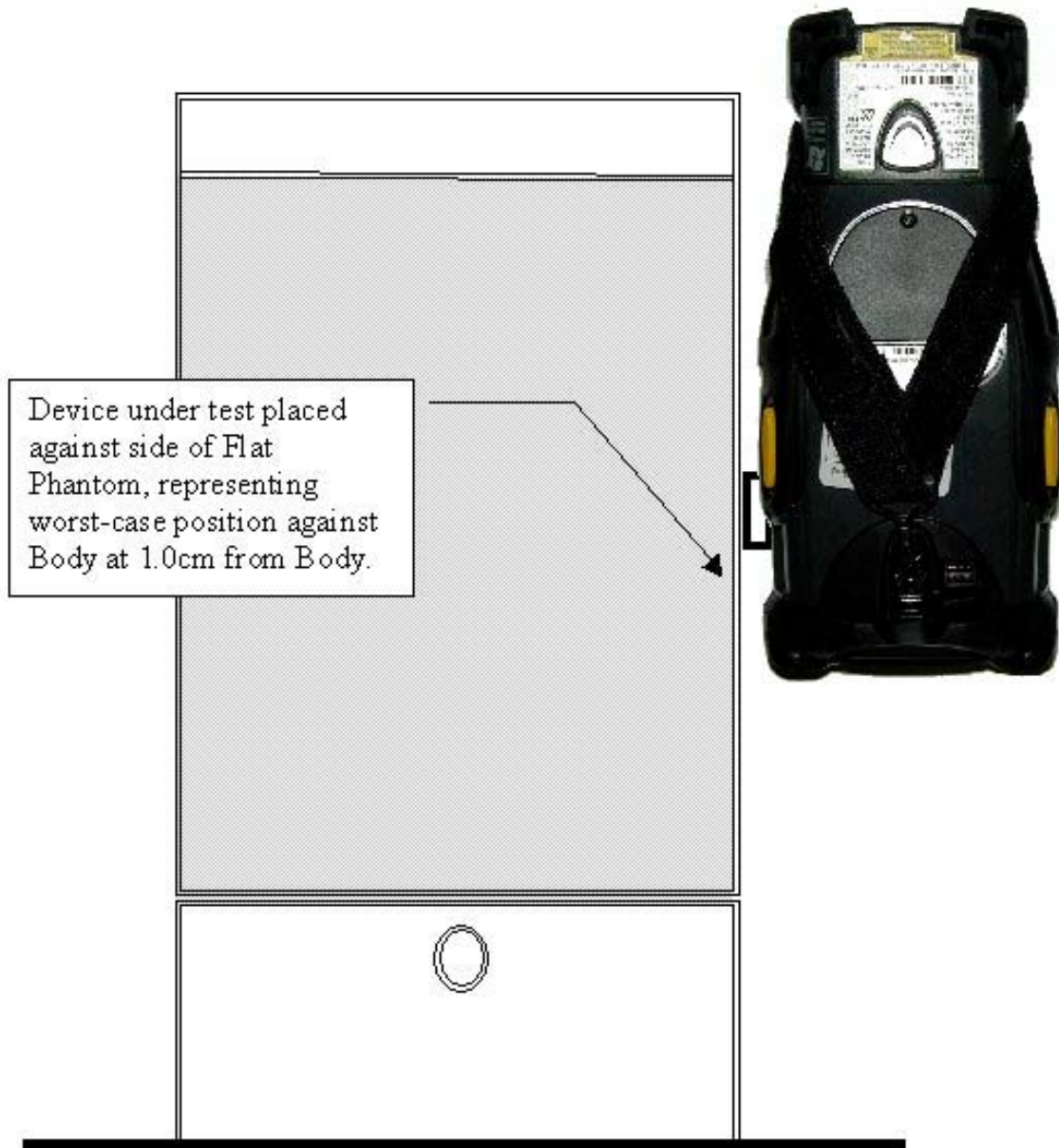

Figure 16. – MC9062 Test Position for WLAN Mode; 1.0 cm from phantom side (this does not represent the position of normal use but does give the maximum SAR level.)



2.7 TEST POSITIONS

OET65(c) FLAT PHANTOM TEST POSITIONS – GRAPHICAL REPRESENTATION

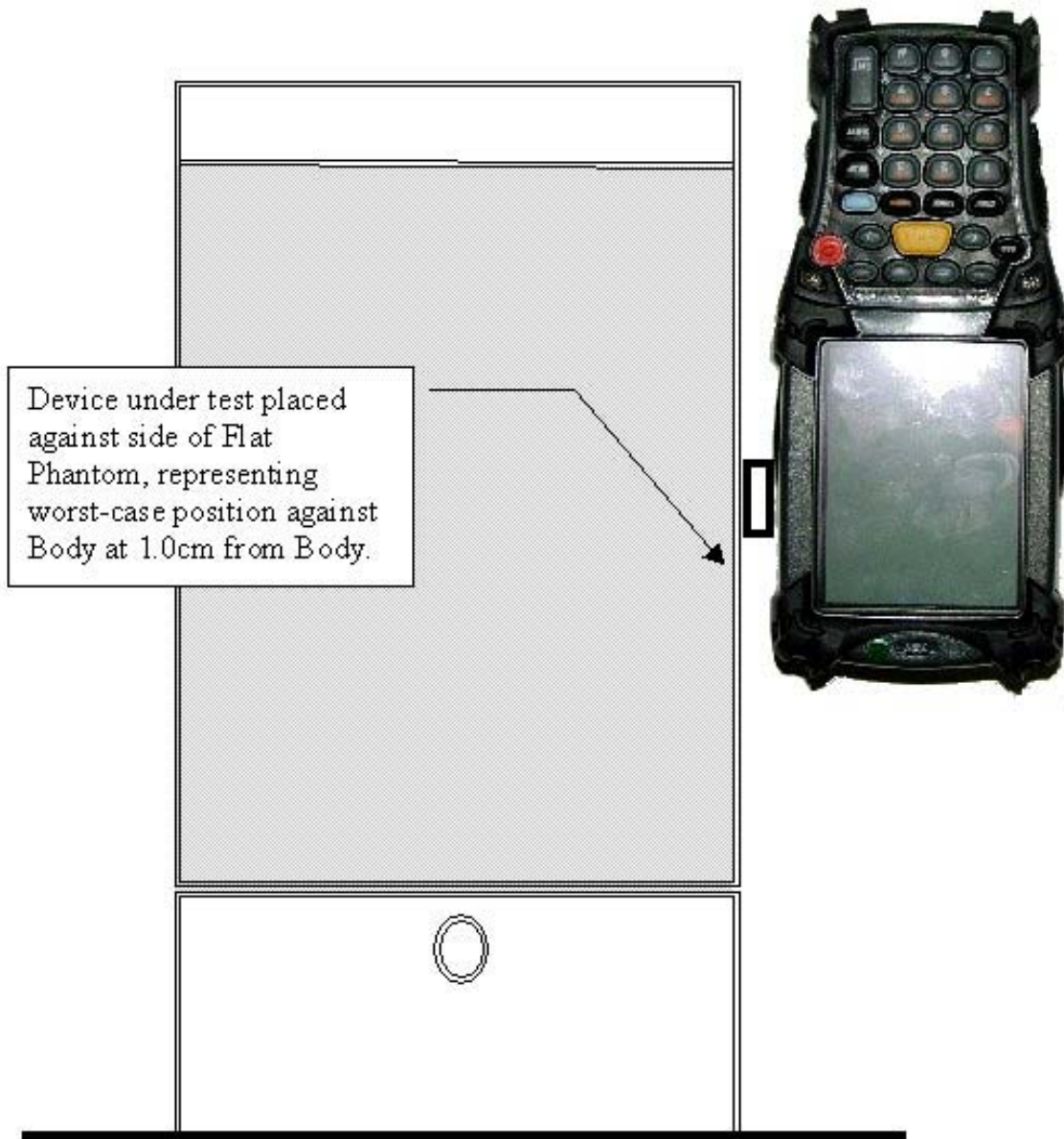

Figure 17. – MC9062 Test Position for BLUETOOTH Mode; 1.0 cm from phantom side (this does not represent the position of normal use but does give the maximum SAR level.)



2.8 TEST RESULTS INCLUDING SAR DISTRIBUTIONS (AREA SCANS – 2D)

SYSTEM / SOFTWARE:	SARA2 / 2.1 VPM	INPUT POWER DRIFT:	0.1 dB
DATE / TIME:	18/02/2004 18:52:06	DUT BATTERY MODEL/NO:	21-62960-01
FILENAME:	611524_01.txt	PROBE SERIAL NUMBER:	0084
AMBIENT TEMPERATURE:	23.0°C	LIQUID SIMULANT:	835 Body
DEVICE UNDER TEST:	Symbol MC9062	RELATIVE PERMITTIVITY:	57.65
RELATIVE HUMIDITY:	25.4%	CONDUCTIVITY:	0.993
PHANTOM S/NO:	HeadBox2mmb.csv	LIQUID TEMPERATURE:	22.2°C
PHANTOM ROTATION:	0°	MAX SAR Y-AXIS LOCATION:	9.8 mm
DUT POSITION:	LCD to phantom in holster	MAX SAR Z-AXIS LOCATION:	-110.3 mm
ANTENNA CONFIGURATION:	Internal	MAX E FIELD:	7.61 V/m
TEST FREQUENCY:	824.2MHz	SAR 1g:	0.053 W/kg
AIR FACTORS:	500 / 410 / 385	SAR 10g:	0.041 W/kg
CONVERSION FACTORS:	0.3 / 0.3 / 0.3	SAR START:	0.032 W/kg
TYPE OF MODULATION:	GMSK	SAR END:	0.031 W/kg
MODN. DUTY CYCLE:	25%	SAR DRIFT DURING SCAN:	-0.13 dB
DIODE COMPRESSION FACTORS (V*200):	16.1 / 16.1 / 14.7	PROBE BATTERY LAST CHANGED:	16/02/04
INPUT POWER LEVEL:	5	EXTRAPOLATION:	poly4

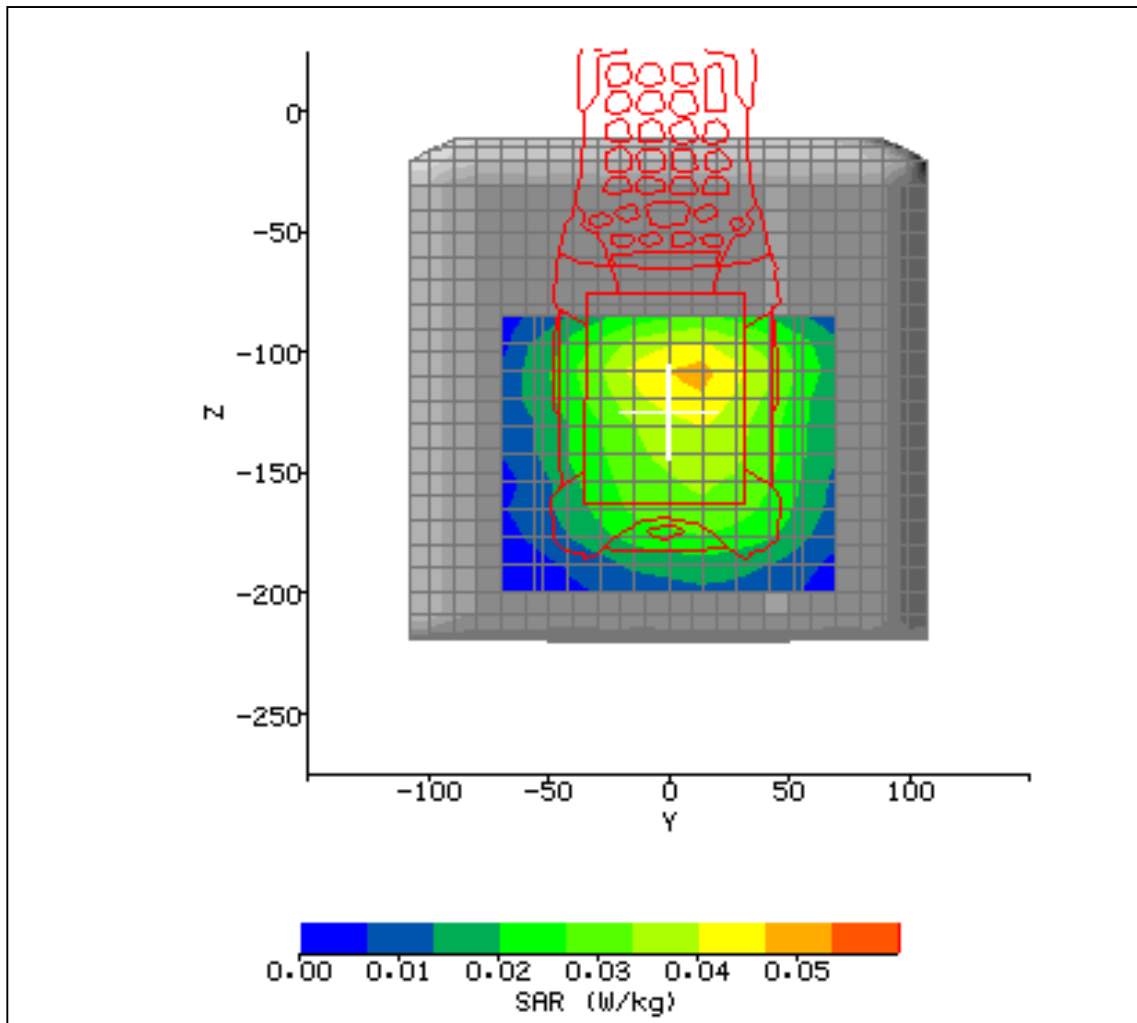

Figure 18



2.8 TEST RESULTS INCLUDING SAR DISTRIBUTIONS (AREA SCANS – 2D)

SYSTEM / SOFTWARE:	SARA2 / 2.1 VPM	INPUT POWER DRIFT:	0.3 dB
DATE / TIME:	18/02/2004 19:48:09	DUT BATTERY MODEL/NO:	21-62960-01
FILENAME:	611524_02.txt	PROBE SERIAL NUMBER:	0084
AMBIENT TEMPERATURE:	22.8°C	LIQUID SIMULANT:	835 Body
DEVICE UNDER TEST:	Symbol MC9062	RELATIVE PERMITTIVITY:	57.65
RELATIVE HUMIDITY:	25.5%	CONDUCTIVITY:	0.993
PHANTOM S/NO:	HeadBox2mmb.csv	LIQUID TEMPERATURE:	22.2°C
PHANTOM ROTATION:	0°	MAX SAR Y-AXIS LOCATION:	9.8 mm
DUT POSITION:	LCD to phantom in holster	MAX SAR Z-AXIS LOCATION:	-110.3 mm
ANTENNA CONFIGURATION:	Internal	MAX E FIELD:	6.78 V/m
TEST FREQUENCY:	836.5MHz	SAR 1g:	0.042 W/kg
AIR FACTORS:	500 / 410 / 385	SAR 10g:	0.033 W/kg
CONVERSION FACTORS:	0.3 / 0.3 / 0.3	SAR START:	0.026 W/kg
TYPE OF MODULATION:	GMSK	SAR END:	0.025 W/kg
MODN. DUTY CYCLE:	25%	SAR DRIFT DURING SCAN:	-0.13 dB
DIODE COMPRESSION FACTORS (V*200):	16.1 / 16.1 / 14.7	PROBE BATTERY LAST CHANGED:	16/02/04
INPUT POWER LEVEL:	5	EXTRAPOLATION:	poly4

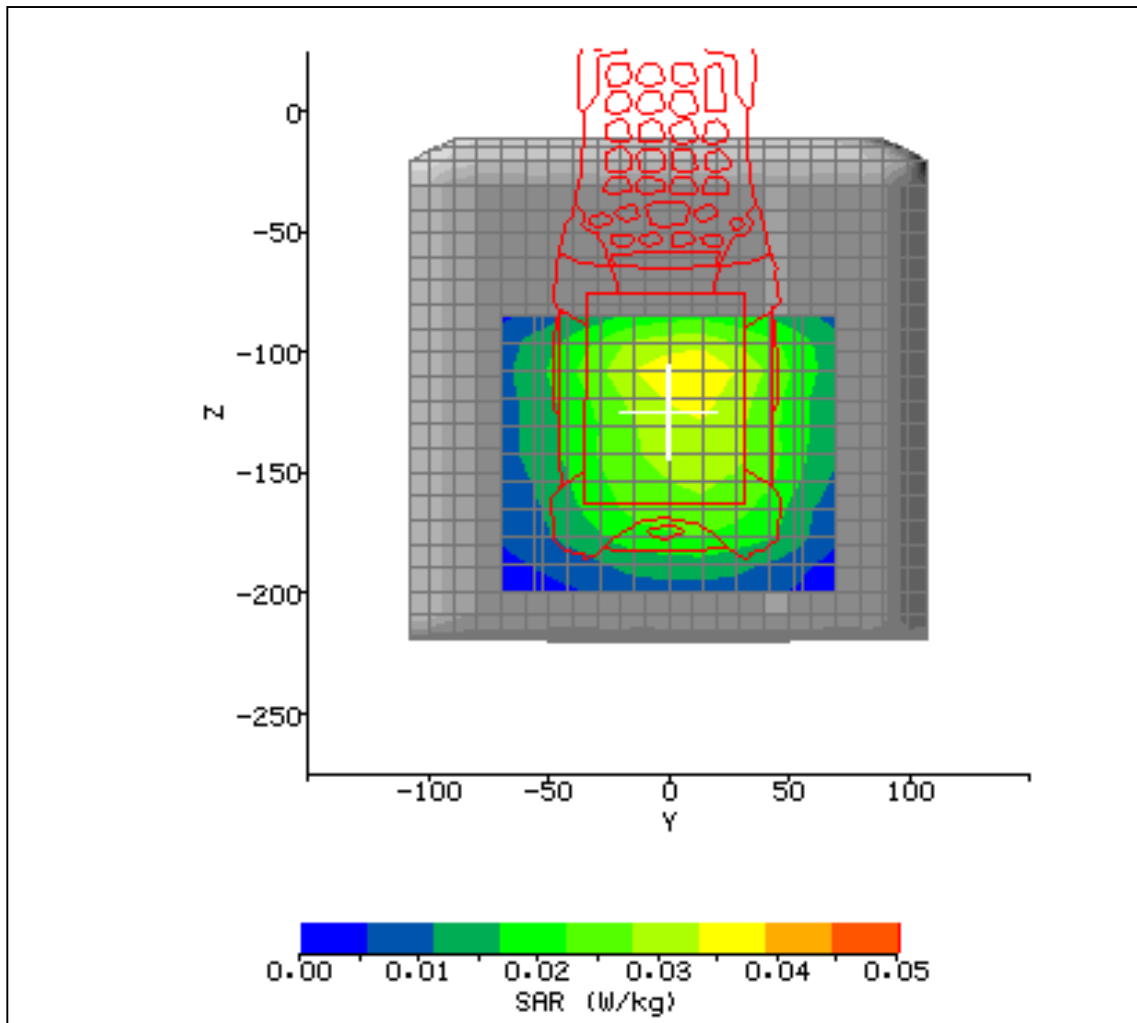

Figure 19



2.8 TEST RESULTS INCLUDING SAR DISTRIBUTIONS (AREA SCANS – 2D)

SYSTEM / SOFTWARE:	SARA2 / 2.1 VPM	INPUT POWER DRIFT:	0.1 dB
DATE / TIME:	18/02/2004 20:24:25	DUT BATTERY MODEL/NO:	21-62960-01
FILENAME:	611524_03.txt	PROBE SERIAL NUMBER:	0084
AMBIENT TEMPERATURE:	22.8°C	LIQUID SIMULANT:	835 Body
DEVICE UNDER TEST:	Symbol MC9062	RELATIVE PERMITTIVITY:	57.65
RELATIVE HUMIDITY:	25.7%	CONDUCTIVITY:	0.993
PHANTOM S/NO:	HeadBox2mmb.csv	LIQUID TEMPERATURE:	21.8°C
PHANTOM ROTATION:	0°	MAX SAR Y-AXIS LOCATION:	9.8 mm
DUT POSITION:	LCD to phantom in holster	MAX SAR Z-AXIS LOCATION:	-109.15 mm
ANTENNA CONFIGURATION:	Internal	MAX E FIELD:	6.38 V/m
TEST FREQUENCY:	848.8MHz	SAR 1g:	0.037 W/kg
AIR FACTORS:	500 / 410 / 385	SAR 10g:	0.029 W/kg
CONVERSION FACTORS:	0.3 / 0.3 / 0.3	SAR START:	0.021 W/kg
TYPE OF MODULATION:	GMSK	SAR END:	0.022 W/kg
MODN. DUTY CYCLE:	25%	SAR DRIFT DURING SCAN:	0.23 dB
DIODE COMPRESSION FACTORS (V*200):	16.1 / 16.1 / 14.7	PROBE BATTERY LAST CHANGED:	16/02/04
INPUT POWER LEVEL:	5	EXTRAPOLATION:	poly4

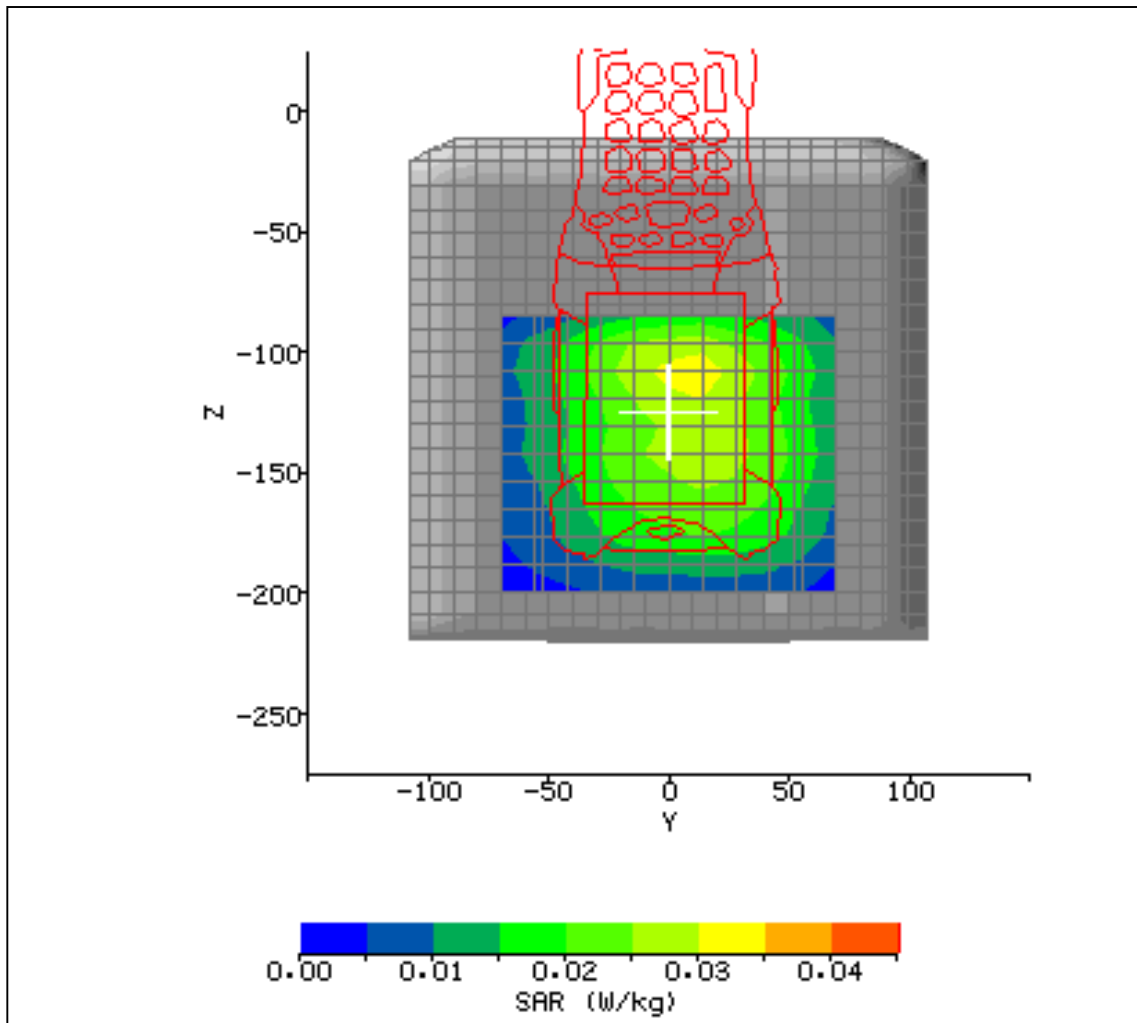

Figure 20



2.8 TEST RESULTS INCLUDING SAR DISTRIBUTIONS (AREA SCANS – 2D)

SYSTEM / SOFTWARE:	SARA2 / 2.1 VPM	INPUT POWER DRIFT:	0.1 dB
DATE / TIME:	19/02/2004 16:14:11	DUT BATTERY MODEL/NO:	21-62960-01
FILENAME:	611524_04.txt	PROBE SERIAL NUMBER:	0084
AMBIENT TEMPERATURE:	22.1°C	LIQUID SIMULANT:	835 Body
DEVICE UNDER TEST:	Symbol MC9062	RELATIVE PERMITTIVITY:	57.65
RELATIVE HUMIDITY:	20.2%	CONDUCTIVITY:	0.993
PHANTOM S/NO:	HeadBox2mmb.csv	LIQUID TEMPERATURE:	21.8°C
PHANTOM ROTATION:	0°	MAX SAR Y-AXIS LOCATION:	9.8 mm
DUT POSITION:	Rear to phantom in holster	MAX SAR Z-AXIS LOCATION:	-109.15 mm
ANTENNA CONFIGURATION:	Internal	MAX E FIELD:	14.60 V/m
TEST FREQUENCY:	824.2MHz	SAR 1g:	0.195 W/kg
AIR FACTORS:	500 / 410 / 385	SAR 10g:	0.148 W/kg
CONVERSION FACTORS:	0.3 / 0.3 / 0.3	SAR START:	0.105 W/kg
TYPE OF MODULATION:	GMSK	SAR END:	0.104 W/kg
MODN. DUTY CYCLE:	25%	SAR DRIFT DURING SCAN:	-0.05 dB
DIODE COMPRESSION FACTORS (V*200):	16.1 / 16.1 / 14.7	PROBE BATTERY LAST CHANGED:	16/02/04
INPUT POWER LEVEL:	5	EXTRAPOLATION:	poly4

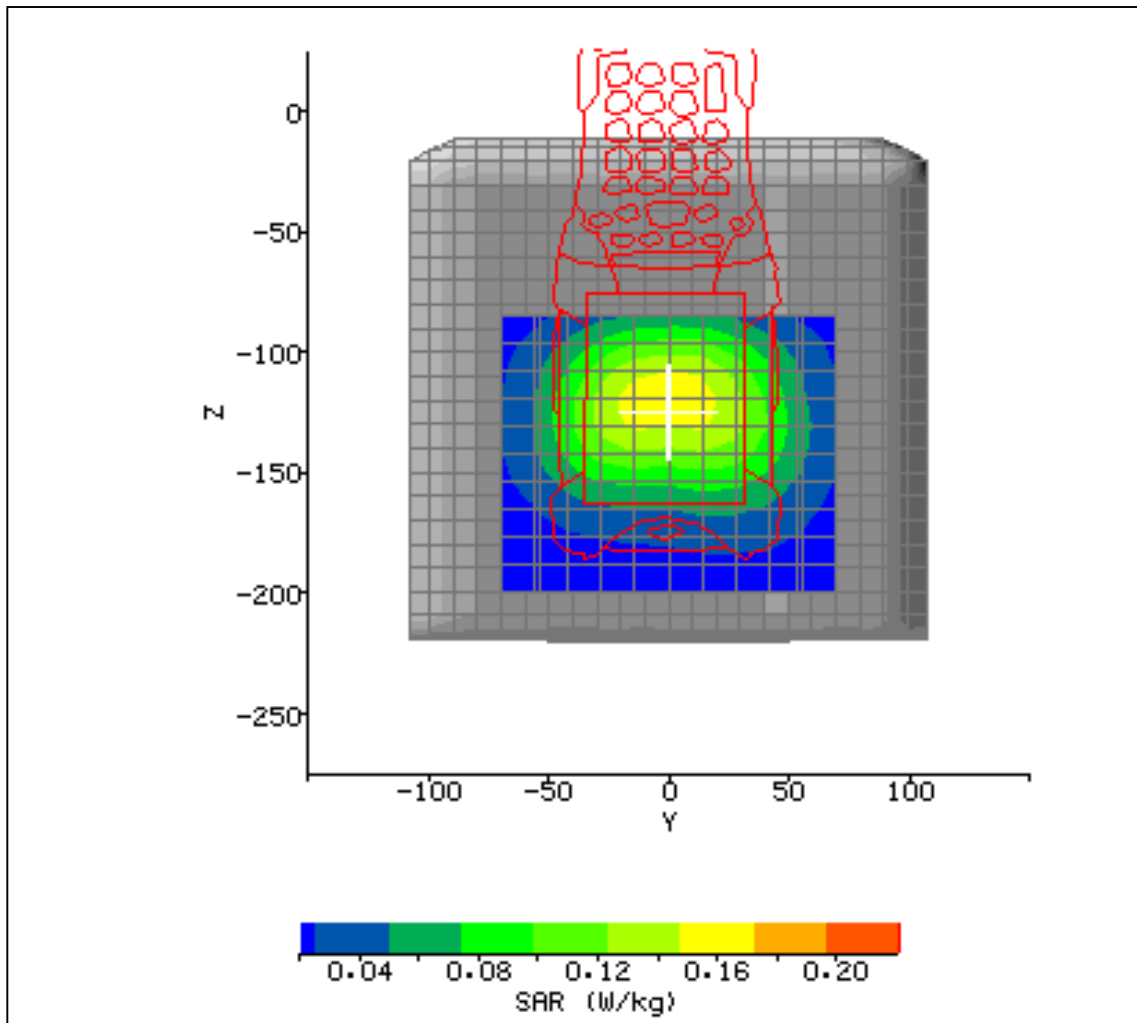

Figure 21



2.8 TEST RESULTS INCLUDING SAR DISTRIBUTIONS (AREA SCANS – 2D)

SYSTEM / SOFTWARE:	SARA2 / 2.1 VPM	INPUT POWER DRIFT:	0.1 dB
DATE / TIME:	17/02/2004 18:51:49	DUT BATTERY MODEL/NO:	21-62960-01
FILENAME:	611524_06.txt	PROBE SERIAL NUMBER:	0084
AMBIENT TEMPERATURE:	23.7°C	LIQUID SIMULANT:	1800 Body
DEVICE UNDER TEST:	Symbol MC9062	RELATIVE PERMITTIVITY:	54.96
RELATIVE HUMIDITY:	29.3%	CONDUCTIVITY:	1.585
PHANTOM S/NO:	HeadBox2mmb.csv	LIQUID TEMPERATURE:	22.9°C
PHANTOM ROTATION:	0°	MAX SAR Y-AXIS LOCATION:	29.4 mm
DUT POSITION:	LCD to phantom in holster	MAX SAR Z-AXIS LOCATION:	-182.7 mm
ANTENNA CONFIGURATION:	Internal	MAX E FIELD:	3.39 V/m
TEST FREQUENCY:	1747.4MHz	SAR 1g:	0.016 W/kg
AIR FACTORS:	500 / 410 / 385	SAR 10g:	0.012 W/kg
CONVERSION FACTORS:	0.375 / 0.375 / 0.375	SAR START:	0.009 W/kg
TYPE OF MODULATION:	GMSK	SAR END:	0.008 W/kg
MODN. DUTY CYCLE:	25%	SAR DRIFT DURING SCAN:	-0.45 dB
DIODE COMPRESSION FACTORS (V*200):	16.1 / 16.1 / 14.7	PROBE BATTERY LAST CHANGED:	16/02/04
INPUT POWER LEVEL:	1	EXTRAPOLATION:	poly4

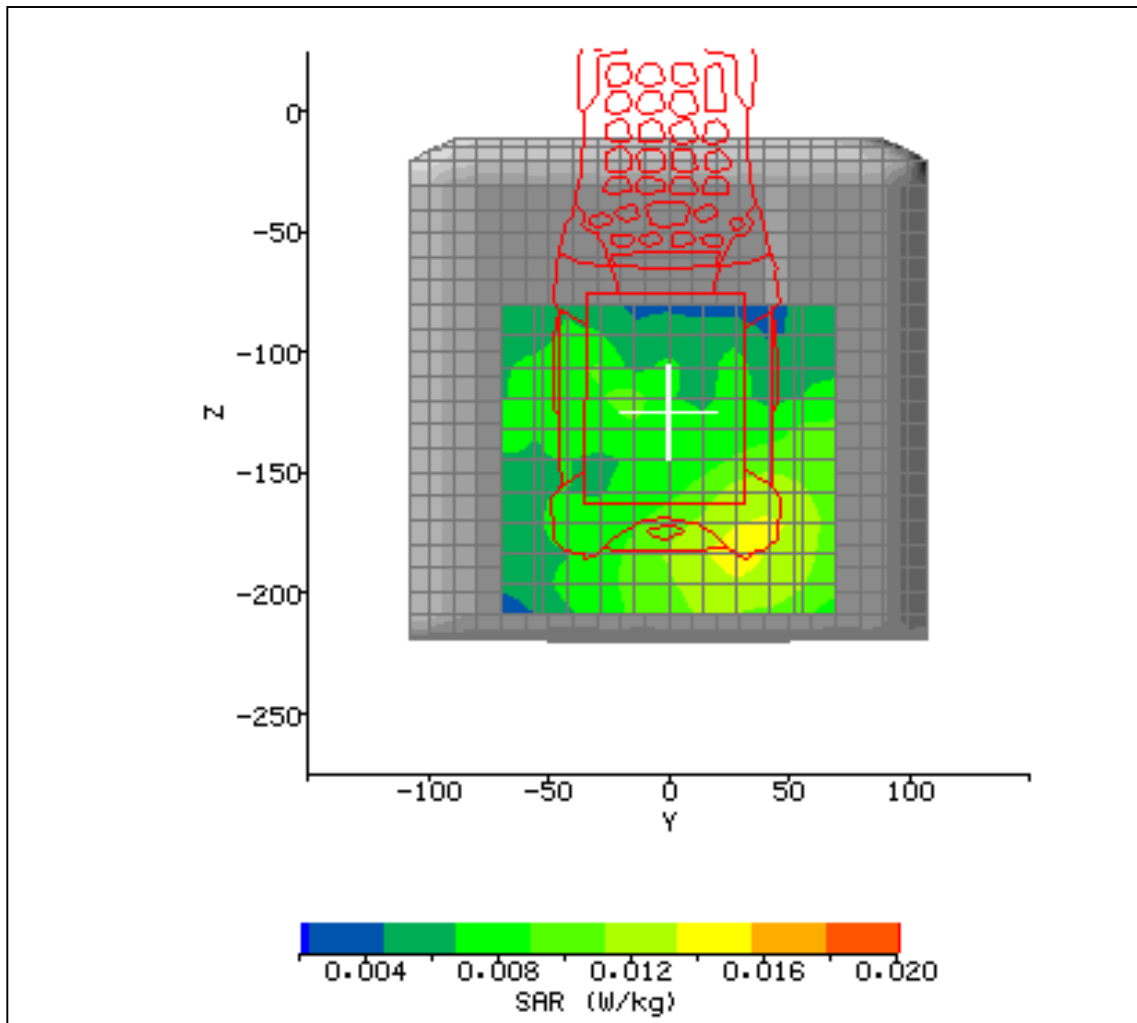

Figure 22



2.8 TEST RESULTS INCLUDING SAR DISTRIBUTIONS (AREA SCANS – 2D)

SYSTEM / SOFTWARE:	SARA2 / 2.1 VPM	INPUT POWER DRIFT:	0.2 dB
DATE / TIME:	17/02/2004 19:29:08	DUT BATTERY MODEL/NO:	21-62960-01
FILENAME:	611524_07.txt	PROBE SERIAL NUMBER:	0084
AMBIENT TEMPERATURE:	23.6°C	LIQUID SIMULANT:	1800 Body
DEVICE UNDER TEST:	Symbol MC9062	RELATIVE PERMITTIVITY:	54.96
RELATIVE HUMIDITY:	29.1%	CONDUCTIVITY:	1.585
PHANTOM S/NO:	HeadBox2mmb.csv	LIQUID TEMPERATURE:	22.7°C
PHANTOM ROTATION:	0°	MAX SAR Y-AXIS LOCATION:	21.0 mm
DUT POSITION:	LCD to phantom in holster	MAX SAR Z-AXIS LOCATION:	-193.1 mm
ANTENNA CONFIGURATION:	Internal	MAX E FIELD:	3.07 V/m
TEST FREQUENCY:	1710.2MHz	SAR 1g:	0.014 W/kg
AIR FACTORS:	500 / 410 / 385	SAR 10g:	0.010 W/kg
CONVERSION FACTORS:	0.375 / 0.375 / 0.375	SAR START:	0.007 W/kg
TYPE OF MODULATION:	GMSK	SAR END:	0.007 W/kg
MODN. DUTY CYCLE:	25%	SAR DRIFT DURING SCAN:	0.29 dB
DIODE COMPRESSION FACTORS (V*200):	16.1 / 16.1 / 14.7	PROBE BATTERY LAST CHANGED:	16/02/04
INPUT POWER LEVEL:	1	EXTRAPOLATION:	poly4

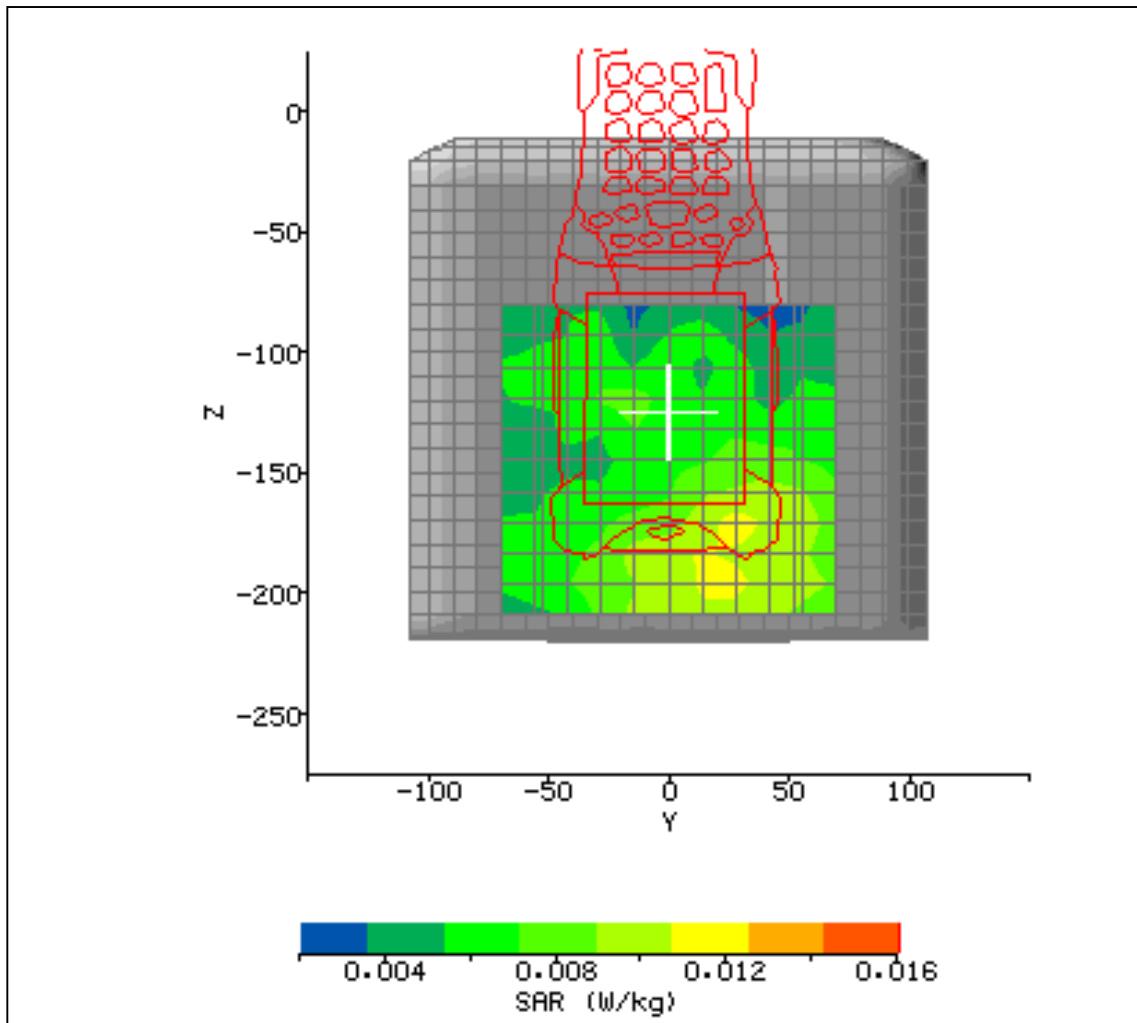

Figure 23



2.8 TEST RESULTS INCLUDING SAR DISTRIBUTIONS (AREA SCANS – 2D)

SYSTEM / SOFTWARE:	SARA2 / 2.1 VPM	INPUT POWER DRIFT:	0.0 dB
DATE / TIME:	17/02/2004 20:15:53	DUT BATTERY MODEL/NO:	21-62960-01
FILENAME:	611524_08.txt	PROBE SERIAL NUMBER:	0084
AMBIENT TEMPERATURE:	23.3°C	LIQUID SIMULANT:	1800 Body
DEVICE UNDER TEST:	Symbol MC9062	RELATIVE PERMITTIVITY:	54.96
RELATIVE HUMIDITY:	28.8%	CONDUCTIVITY:	1.585
PHANTOM S/NO:	HeadBox2mmb.csv	LIQUID TEMPERATURE:	22.4°C
PHANTOM ROTATION:	0°	MAX SAR Y-AXIS LOCATION:	39.2 mm
DUT POSITION:	LCD to phantom in holster	MAX SAR Z-AXIS LOCATION:	-180.1 mm
ANTENNA CONFIGURATION:	Internal	MAX E FIELD:	3.82 V/m
TEST FREQUENCY:	1784.8MHz	SAR 1g:	0.020 W/kg
AIR FACTORS:	500 / 410 / 385	SAR 10g:	0.015 W/kg
CONVERSION FACTORS:	0.375 / 0.375 / 0.375	SAR START:	0.008 W/kg
TYPE OF MODULATION:	GMSK	SAR END:	0.008 W/kg
MODN. DUTY CYCLE:	25%	SAR DRIFT DURING SCAN:	0.00 dB
DIODE COMPRESSION FACTORS (V*200):	16.1 / 16.1 / 14.7	PROBE BATTERY LAST CHANGED:	16/02/04
INPUT POWER LEVEL:	0	EXTRAPOLATION:	poly4

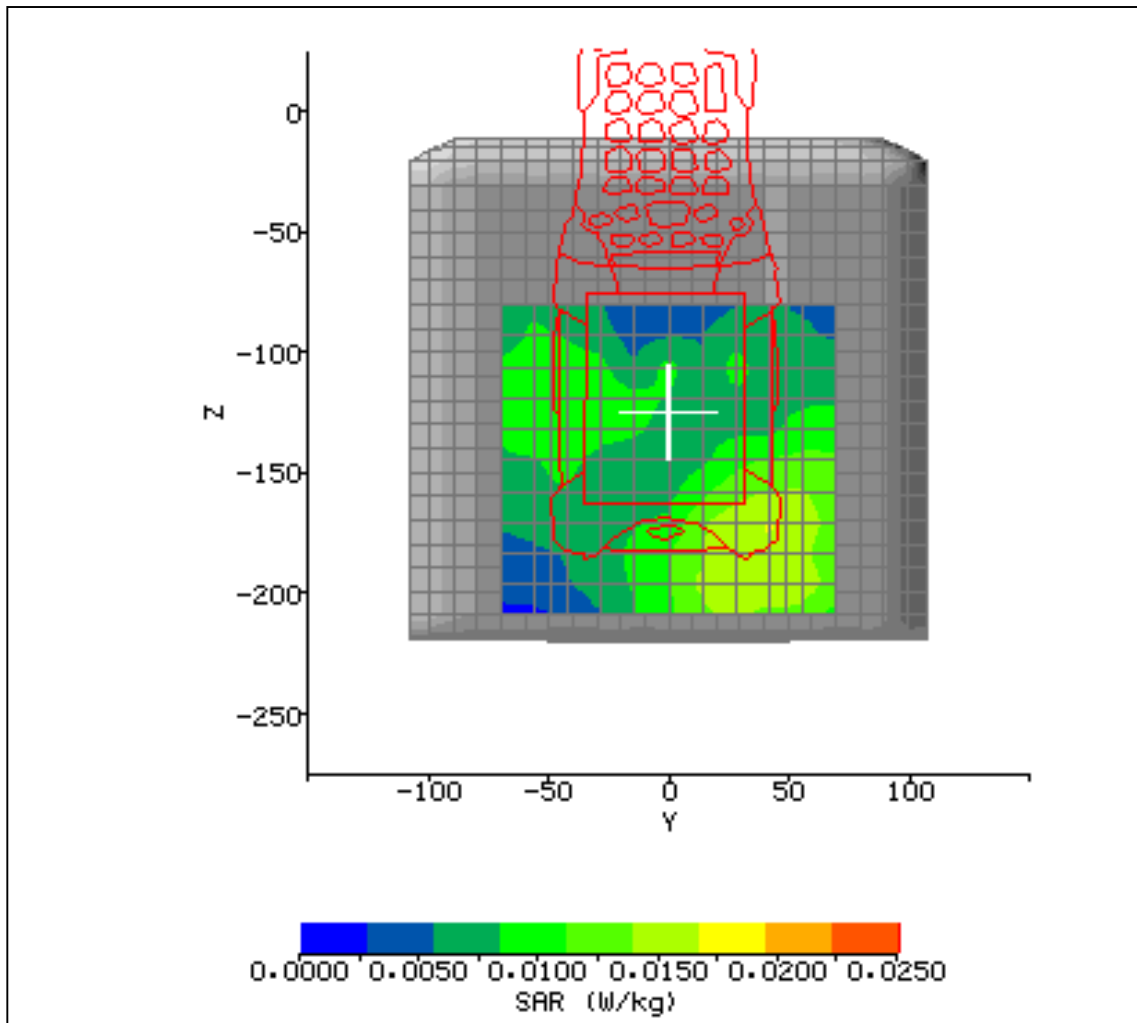

Figure 24



2.8 TEST RESULTS INCLUDING SAR DISTRIBUTIONS (AREA SCANS – 2D)

SYSTEM / SOFTWARE:	SARA2 / 2.1 VPM	INPUT POWER DRIFT:	0.0 dB
DATE / TIME:	17/02/2004 21:27:45	DUT BATTERY MODEL/NO:	21-62960-01
FILENAME:	611524_09.txt	PROBE SERIAL NUMBER:	0084
AMBIENT TEMPERATURE:	23.1°C	LIQUID SIMULANT:	1800 Body
DEVICE UNDER TEST:	Symbol MC9062	RELATIVE PERMITTIVITY:	54.96
RELATIVE HUMIDITY:	28.0%	CONDUCTIVITY:	1.585
PHANTOM S/NO:	HeadBox2mmb.csv	LIQUID TEMPERATURE:	22.4°C
PHANTOM ROTATION:	0°	MAX SAR Y-AXIS LOCATION:	-1.4 mm
DUT POSITION:	Rear to phantom in holster	MAX SAR Z-AXIS LOCATION:	-100.8 mm
ANTENNA CONFIGURATION:	Internal	MAX E FIELD:	19.28 V/m
TEST FREQUENCY:	1784.8MHz	SAR 1g:	0.462 W/kg
AIR FACTORS:	500 / 410 / 385	SAR 10g:	0.243 W/kg
CONVERSION FACTORS:	0.375 / 0.375 / 0.375	SAR START:	0.155 W/kg
TYPE OF MODULATION:	GMSK	SAR END:	0.153 W/kg
MODN. DUTY CYCLE:	25%	SAR DRIFT DURING SCAN:	-0.05 dB
DIODE COMPRESSION FACTORS (V*200):	16.1 / 16.1 / 14.7	PROBE BATTERY LAST CHANGED:	16/02/04
INPUT POWER LEVEL:	0	EXTRAPOLATION:	poly4

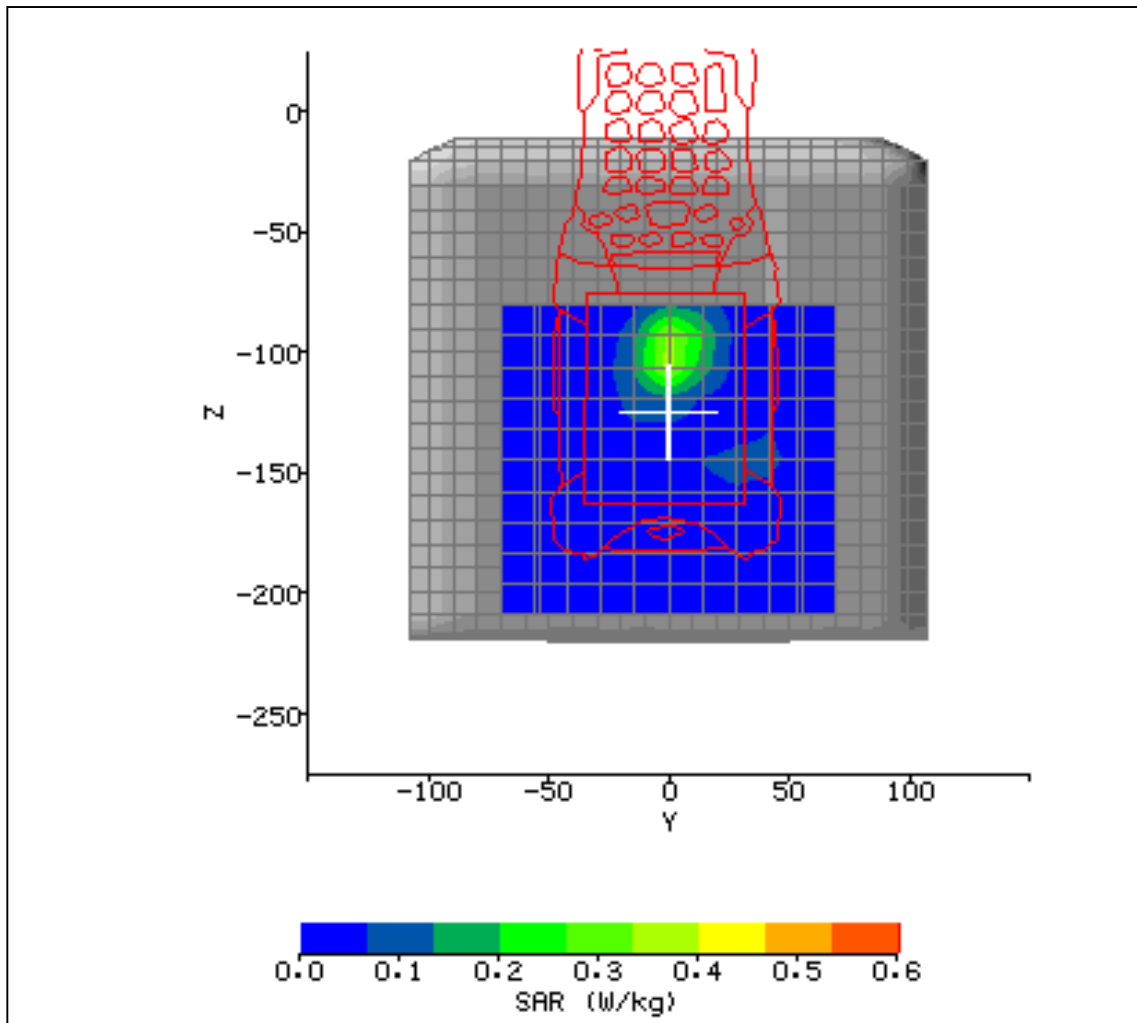

Figure 25



2.8 TEST RESULTS INCLUDING SAR DISTRIBUTIONS (AREA SCANS – 2D)

SYSTEM / SOFTWARE:	SARA2 / 2.1 VPM	INPUT POWER DRIFT:	0.1 dB
DATE / TIME:	16/02/2004 19:33:39	DUT BATTERY MODEL/NO:	21-62960-01
FILENAME:	611524_11.txt	PROBE SERIAL NUMBER:	0084
AMBIENT TEMPERATURE:	23.4°C	LIQUID SIMULANT:	1900 Body
DEVICE UNDER TEST:	Symbol MC9062	RELATIVE PERMITTIVITY:	52.29
RELATIVE HUMIDITY:	27.2%	CONDUCTIVITY:	1.543
PHANTOM S/NO:	HeadBox2mmb.csv	LIQUID TEMPERATURE:	22.4°C
PHANTOM ROTATION:	0°	MAX SAR Y-AXIS LOCATION:	42.0 mm
DUT POSITION:	LCD to phantom in holster	MAX SAR Z-AXIS LOCATION:	-185.6 mm
ANTENNA CONFIGURATION:	Internal	MAX E FIELD:	4.02 V/m
TEST FREQUENCY:	1850.2MHz	SAR 1g:	0.022 W/kg
AIR FACTORS:	500 / 410 / 385	SAR 10g:	0.015 W/kg
CONVERSION FACTORS:	0.405 / 0.405 / 0.405	SAR START:	0.008 W/kg
TYPE OF MODULATION:	GMSK	SAR END:	0.008 W/kg
MODN. DUTY CYCLE:	25%	SAR DRIFT DURING SCAN:	0.23 dB
DIODE COMPRESSION FACTORS (V*200):	16.1 / 16.1 / 14.7	PROBE BATTERY LAST CHANGED:	16/02/04
INPUT POWER LEVEL:	0	EXTRAPOLATION:	poly4

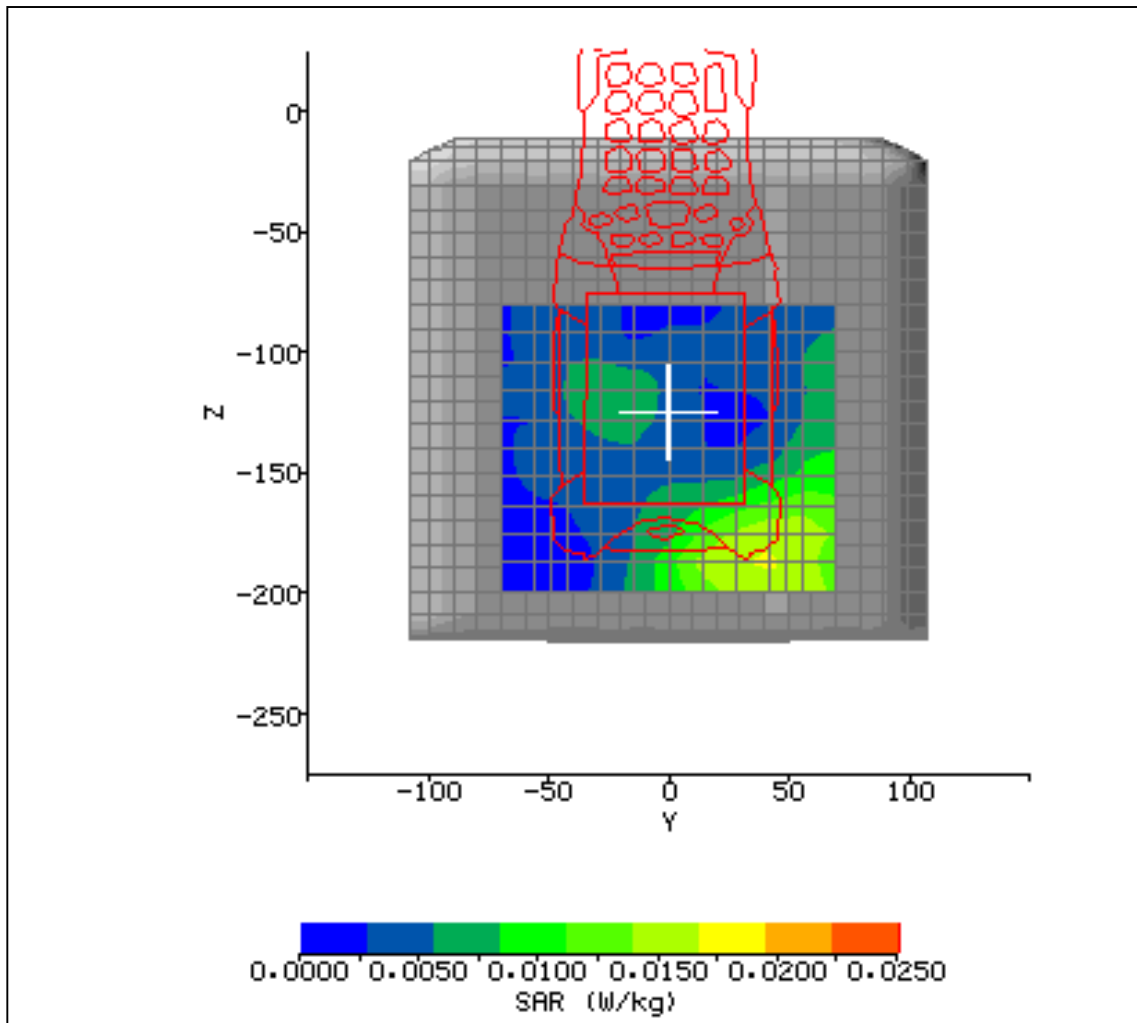

Figure 26



2.8 TEST RESULTS INCLUDING SAR DISTRIBUTIONS (AREA SCANS – 2D)

SYSTEM / SOFTWARE:	SARA2 / 2.1 VPM	INPUT POWER DRIFT:	0.0 dB
DATE / TIME:	16/02/2004 18:57:47	DUT BATTERY MODEL/NO:	21-62960-01
FILENAME:	611524_12.txt	PROBE SERIAL NUMBER:	0084
AMBIENT TEMPERATURE:	23.6°C	LIQUID SIMULANT:	1900 Body
DEVICE UNDER TEST:	Symbol MC9062	RELATIVE PERMITTIVITY:	52.29
RELATIVE HUMIDITY:	27.1%	CONDUCTIVITY:	1.543
PHANTOM S/NO:	HeadBox2mmb.csv	LIQUID TEMPERATURE:	22.7°C
PHANTOM ROTATION:	0°	MAX SAR Y-AXIS LOCATION:	46.2 mm
DUT POSITION:	LCD to phantom in holster	MAX SAR Z-AXIS LOCATION:	-183.2 mm
ANTENNA CONFIGURATION:	Internal	MAX E FIELD:	3.49 V/m
TEST FREQUENCY:	1880.0MHz	SAR 1g:	0.016 W/kg
AIR FACTORS:	500 / 410 / 385	SAR 10g:	0.011 W/kg
CONVERSION FACTORS:	0.405 / 0.405 / 0.405	SAR START:	0.006 W/kg
TYPE OF MODULATION:	GMSK	SAR END:	0.005 W/kg
MODN. DUTY CYCLE:	25%	SAR DRIFT DURING SCAN:	-0.24 dB
DIODE COMPRESSION FACTORS (V*200):	16.1 / 16.1 / 14.7	PROBE BATTERY LAST CHANGED:	16/02/2004
INPUT POWER LEVEL:	0	EXTRAPOLATION:	poly4

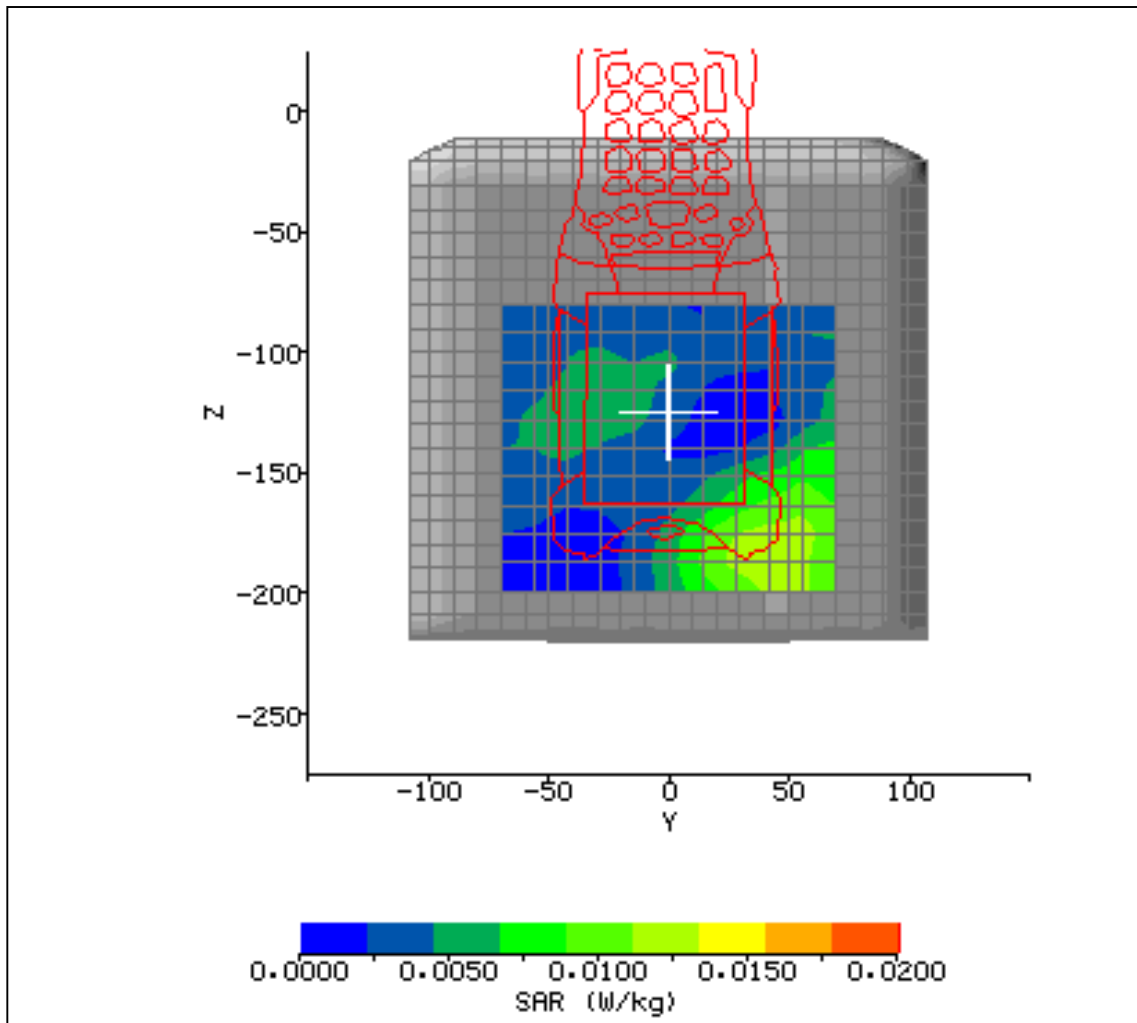

Figure 27



2.8 TEST RESULTS INCLUDING SAR DISTRIBUTIONS (AREA SCANS – 2D)

SYSTEM / SOFTWARE:	SARA2 / 2.1 VPM	INPUT POWER DRIFT:	0.1 dB
DATE / TIME:	16/02/2004 20:15:26	DUT BATTERY MODEL/NO:	21-62960-01
FILENAME:	611524_13.txt	PROBE SERIAL NUMBER:	0084
AMBIENT TEMPERATURE:	22.4°C	LIQUID SIMULANT:	1900 Body
DEVICE UNDER TEST:	Symbol MC9062	RELATIVE PERMITTIVITY:	52.29
RELATIVE HUMIDITY:	29.5%	CONDUCTIVITY:	1.543
PHANTOM S/NO:	HeadBox2mmb.csv	LIQUID TEMPERATURE:	22.4°C
PHANTOM ROTATION:	0°	MAX SAR Y-AXIS LOCATION:	50.4 mm
DUT POSITION:	LCD to phantom in holster	MAX SAR Z-AXIS LOCATION:	-182.0 mm
ANTENNA CONFIGURATION:	Internal	MAX E FIELD:	2.72 V/m
TEST FREQUENCY:	1909.8MHz	SAR 1g:	0.009 W/kg
AIR FACTORS:	500 / 410 / 385	SAR 10g:	0.006 W/kg
CONVERSION FACTORS:	0.405 / 0.405 / 0.405	SAR START:	0.003 W/kg
TYPE OF MODULATION:	GMSK	SAR END:	0.003 W/kg
MODN. DUTY CYCLE:	25%	SAR DRIFT DURING SCAN:	0.00dB
DIODE COMPRESSION FACTORS (V*200):	16.1 / 16.1 / 14.7	PROBE BATTERY LAST CHANGED:	16/02/04
INPUT POWER LEVEL:	0	EXTRAPOLATION:	poly4

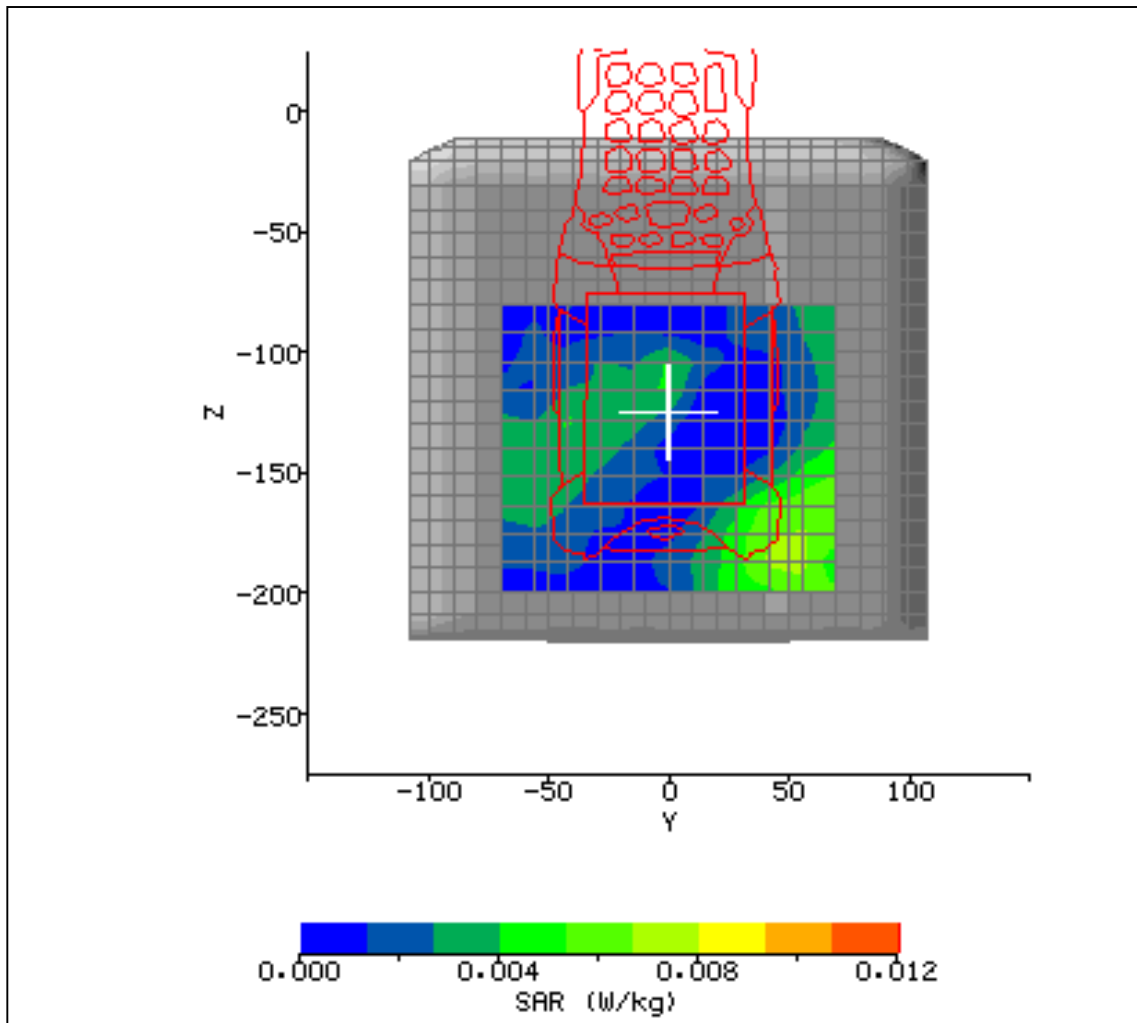

Figure 28



2.8 TEST RESULTS INCLUDING SAR DISTRIBUTIONS (AREA SCANS – 2D)

SYSTEM / SOFTWARE:	SARA2 / 2.1 VPM	INPUT POWER DRIFT:	0.1 dB
DATE / TIME:	16/02/2004 21:12:34	DUT BATTERY MODEL/NO:	21-62960-01
FILENAME:	611524_14.txt	PROBE SERIAL NUMBER:	0084
AMBIENT TEMPERATURE:	24.0°C	LIQUID SIMULANT:	1900 Body
DEVICE UNDER TEST:	Symbol MC9062	RELATIVE PERMITTIVITY:	52.29
RELATIVE HUMIDITY:	26.2%	CONDUCTIVITY:	1.543
PHANTOM S/NO:	HeadBox2mmb.csv	LIQUID TEMPERATURE:	22.2°C
PHANTOM ROTATION:	0°	MAX SAR Y-AXIS LOCATION:	1.4 mm
DUT POSITION:	Rear to phantom in holster	MAX SAR Z-AXIS LOCATION:	-105.2 mm
ANTENNA CONFIGURATION:	Internal	MAX E FIELD:	24.11 V/m
TEST FREQUENCY:	1850.2MHz	SAR 1g:	0.695 W/kg
AIR FACTORS:	500 / 410 / 385	SAR 10g:	0.370 W/kg
CONVERSION FACTORS:	0.405 / 0.405 / 0.405	SAR START:	0.221 W/kg
TYPE OF MODULATION:	GMSK	SAR END:	0.217 W/kg
MODN. DUTY CYCLE:	25%	SAR DRIFT DURING SCAN:	-0.07 dB
DIODE COMPRESSION FACTORS (V*200):	16.1 / 16.1 / 14.7	PROBE BATTERY LAST CHANGED:	16/02/04
INPUT POWER LEVEL:	0	EXTRAPOLATION:	poly4

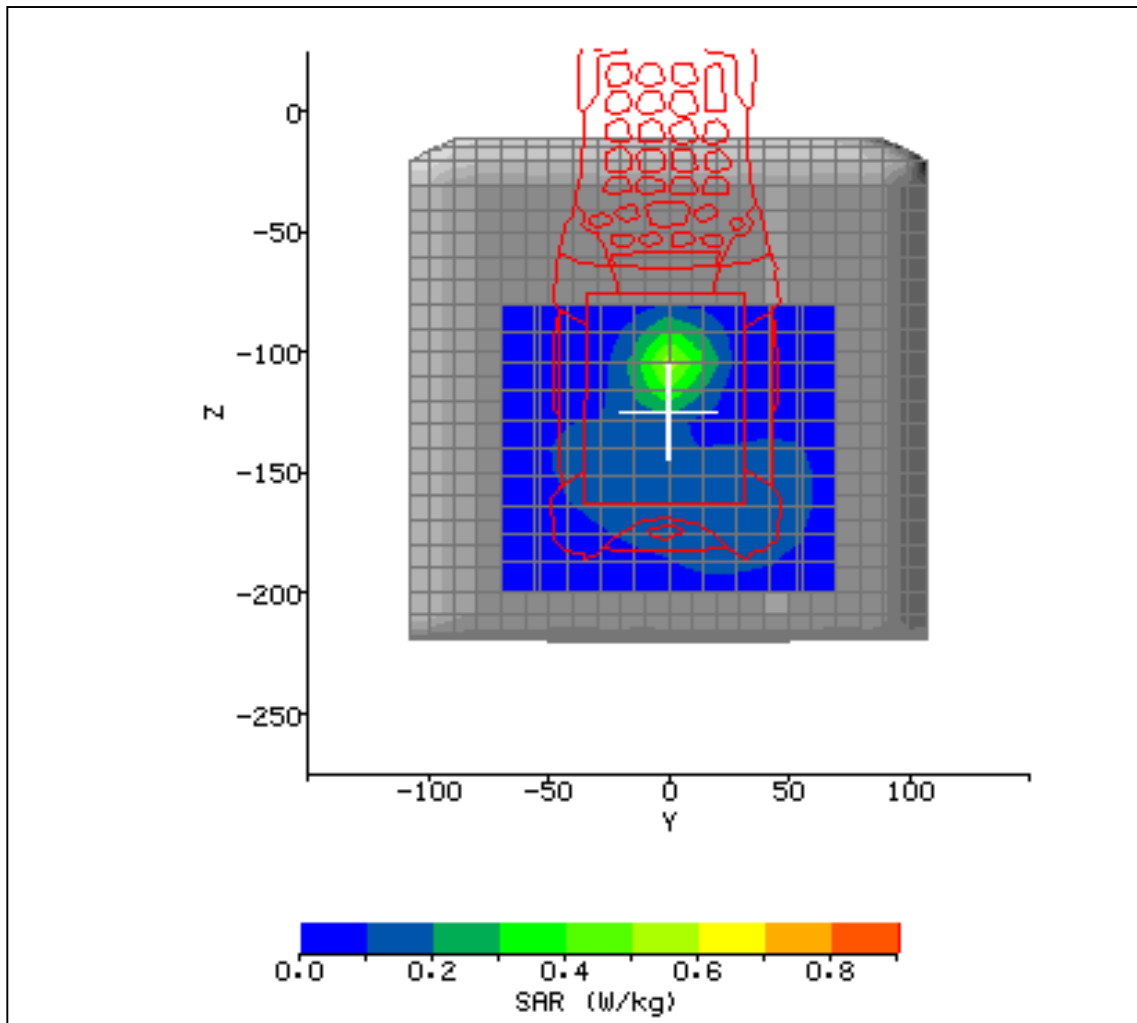

Figure 29



2.8 TEST RESULTS INCLUDING SAR DISTRIBUTIONS (AREA SCANS – 2D)

SYSTEM / SOFTWARE:	SARA2 / 2.1 VPM	INPUT POWER DRIFT:	0.0 dB
DATE / TIME:	20/02/2004 11:12:26	DUT BATTERY MODEL/NO:	21-62960-01
FILENAME:	611524_16.txt	PROBE SERIAL NUMBER:	0084
AMBIENT TEMPERATURE:	22.8°C	LIQUID SIMULANT:	2450 Body
DEVICE UNDER TEST:	Symbol MC9062 short	RELATIVE PERMITTIVITY:	51.29
RELATIVE HUMIDITY:	18.8%	CONDUCTIVITY:	2.031
PHANTOM S/NO:	HeadBox2mmb.csv	LIQUID TEMPERATURE:	22.3°C
PHANTOM ROTATION:	0°	MAX SAR Y-AXIS LOCATION:	-9.0 mm
DUT POSITION:	R side to phantom	MAX SAR Z-AXIS LOCATION:	-133.2 mm
ANTENNA CONFIGURATION:	Internal	MAX E FIELD:	4.00 V/m
TEST FREQUENCY:	2402MHz	SAR 1g:	0.026 W/kg
AIR FACTORS:	500 / 410 / 385	SAR 10g:	0.016 W/kg
CONVERSION FACTORS:	0.468 / 0.468 / 0.468	SAR START:	0.011 W/kg
TYPE OF MODULATION:	CW	SAR END:	0.012 W/kg
MODN. DUTY CYCLE:	100%	SAR DRIFT DURING SCAN:	0.17 dB
DIODE COMPRESSION FACTORS (V*200):	20 / 20 / 20	PROBE BATTERY LAST CHANGED:	16/02/04
INPUT POWER LEVEL:	60	EXTRAPOLATION:	poly4

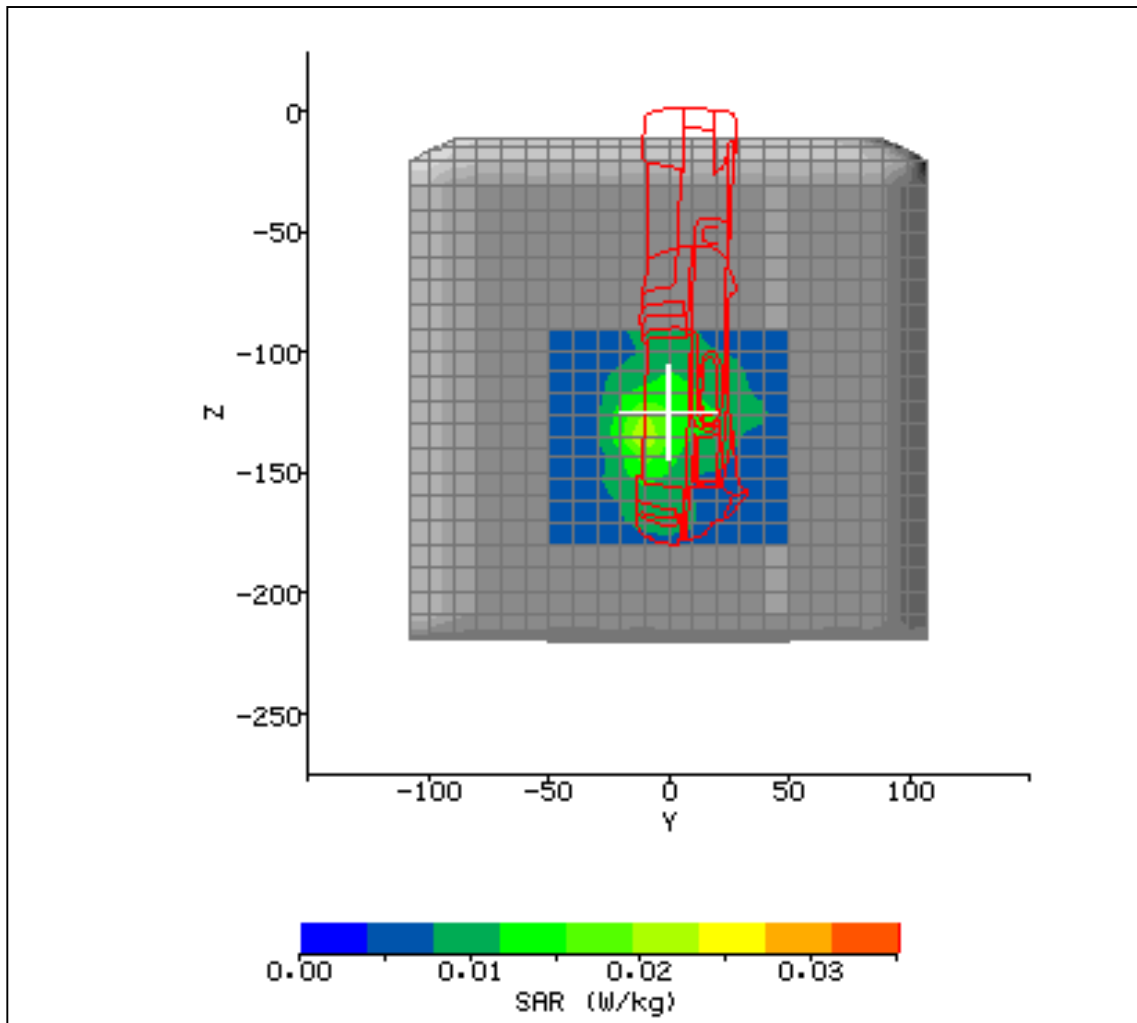

Figure 30



2.8 TEST RESULTS INCLUDING SAR DISTRIBUTIONS (AREA SCANS – 2D)

SYSTEM / SOFTWARE:	SARA2 / 2.1 VPM	INPUT POWER DRIFT:	0.0 dB
DATE / TIME:	20/02/2004 11:42:48	DUT BATTERY MODEL/NO:	21-62960-01
FILENAME:	611524_17.txt	PROBE SERIAL NUMBER:	0084
AMBIENT TEMPERATURE:	22.9°C	LIQUID SIMULANT:	2450 Body
DEVICE UNDER TEST:	Symbol MC9062 short	RELATIVE PERMITTIVITY:	51.29
RELATIVE HUMIDITY:	19.1%	CONDUCTIVITY:	2.031
PHANTOM S/NO:	HeadBox2mmb.csv	LIQUID TEMPERATURE:	22.3°C
PHANTOM ROTATION:	0°	MAX SAR Y-AXIS LOCATION:	-7.0 mm
DUT POSITION:	R side to phantom	MAX SAR Z-AXIS LOCATION:	-135.9 mm
ANTENNA CONFIGURATION:	Internal	MAX E FIELD:	5.55 V/m
TEST FREQUENCY:	2441MHz	SAR 1g:	0.030 W/kg
AIR FACTORS:	500 / 410 / 385	SAR 10g:	0.023 W/kg
CONVERSION FACTORS:	0.468 / 0.468 / 0.468	SAR START:	0.022 W/kg
TYPE OF MODULATION:	CW	SAR END:	0.022 W/kg
MODN. DUTY CYCLE:	100%	SAR DRIFT DURING SCAN:	0.09 dB
DIODE COMPRESSION FACTORS (V*200):	20 / 20 / 20	PROBE BATTERY LAST CHANGED:	16/02/04
INPUT POWER LEVEL:	60	EXTRAPOLATION:	poly4

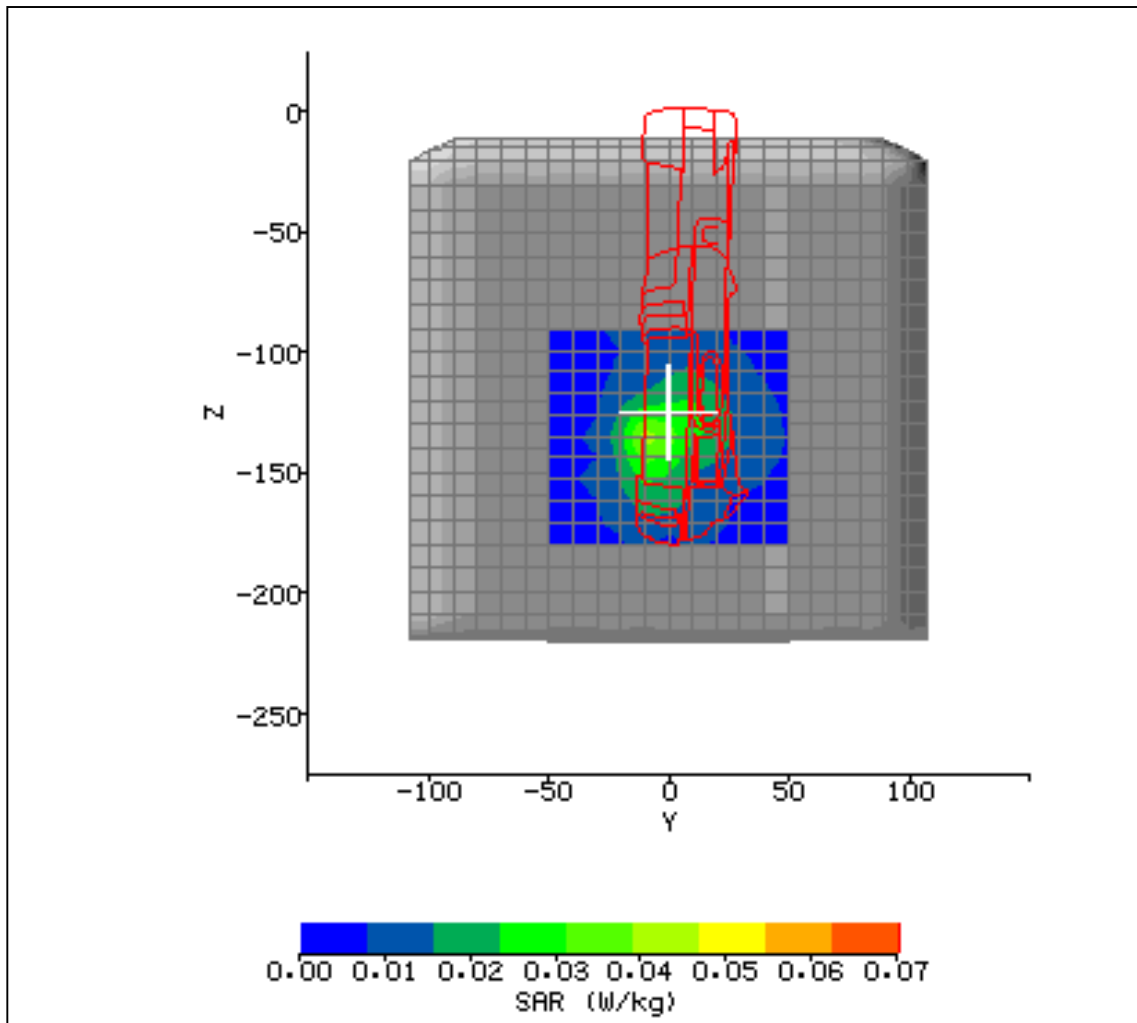

Figure 31



2.8 TEST RESULTS INCLUDING SAR DISTRIBUTIONS (AREA SCANS – 2D)

SYSTEM / SOFTWARE:	SARA2 / 2.1 VPM	INPUT POWER DRIFT:	0.0 dB
DATE / TIME:	20/02/2004 12:42:21	DUT BATTERY MODEL/NO:	21-62960-01
FILENAME:	611524_18.txt	PROBE SERIAL NUMBER:	0084
AMBIENT TEMPERATURE:	23.1°C	LIQUID SIMULANT:	2450 Body
DEVICE UNDER TEST:	Symbol MC9062 short	RELATIVE PERMITTIVITY:	51.29
RELATIVE HUMIDITY:	19.8%	CONDUCTIVITY:	2.031
PHANTOM S/NO:	HeadBox2mmb.csv	LIQUID TEMPERATURE:	22.2°C
PHANTOM ROTATION:	0°	MAX SAR Y-AXIS LOCATION:	-7.0 mm
DUT POSITION:	R side to phantom	MAX SAR Z-AXIS LOCATION:	-135.9 mm
ANTENNA CONFIGURATION:	Internal	MAX E FIELD:	4.23 V/m
TEST FREQUENCY:	2480MHz	SAR 1g:	0.029 W/kg
AIR FACTORS:	500 / 410 / 385	SAR 10g:	0.019 W/kg
CONVERSION FACTORS:	0.468 / 0.468 / 0.468	SAR START:	0.015 W/kg
TYPE OF MODULATION:	CW	SAR END:	0.015 W/kg
MODN. DUTY CYCLE:	100%	SAR DRIFT DURING SCAN:	0.00 dB
DIODE COMPRESSION FACTORS (V*200):	20 / 20 / 20	PROBE BATTERY LAST CHANGED:	16/02/04
INPUT POWER LEVEL:	60	EXTRAPOLATION:	poly4

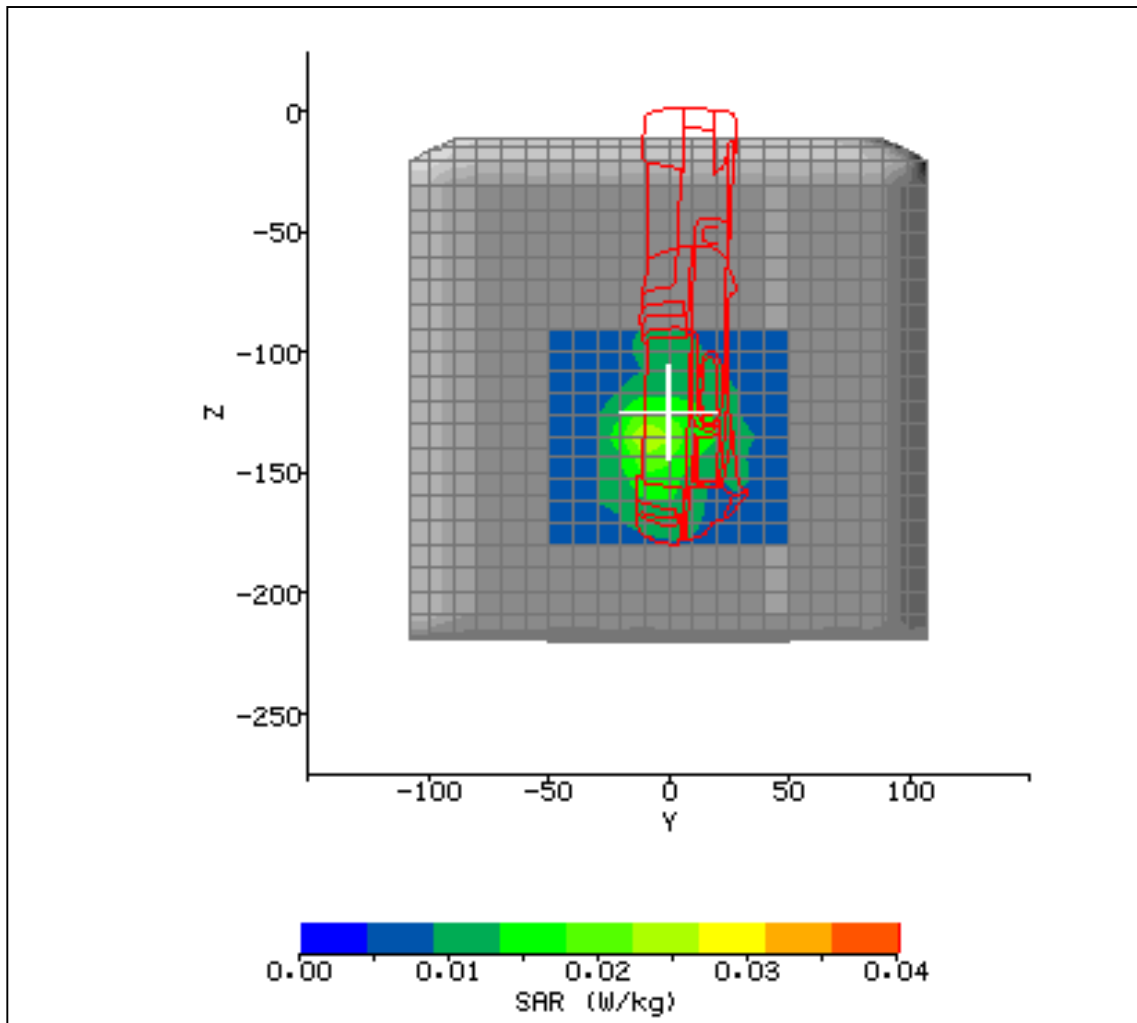

Figure 32



2.8 TEST RESULTS INCLUDING SAR DISTRIBUTIONS (AREA SCANS – 2D)

SYSTEM / SOFTWARE:	SARA2 / 2.1 VPM	INPUT POWER DRIFT:	0.0 dB
DATE / TIME:	20/02/2004 08:23:28	DUT BATTERY MODEL/NO:	21-62960-01
FILENAME:	611524_20.txt	PROBE SERIAL NUMBER:	0084
AMBIENT TEMPERATURE:	23.4°C	LIQUID SIMULANT:	2450 Body
DEVICE UNDER TEST:	Symbol MC9062 short	RELATIVE PERMITTIVITY:	51.29
RELATIVE HUMIDITY:	17.4%	CONDUCTIVITY:	2.031
PHANTOM S/NO:	HeadBox2mmb.csv	LIQUID TEMPERATURE:	23.7°C
PHANTOM ROTATION:	0°	MAX SAR Y-AXIS LOCATION:	7.0mm
DUT POSITION:	L side to phantom	MAX SAR Z-AXIS LOCATION:	-128.7 mm
ANTENNA CONFIGURATION:	Internal	MAX E FIELD:	14.71 V/m
TEST FREQUENCY:	2412MHz (RLAN)	SAR 1g:	0.329 W/kg
AIR FACTORS:	500 / 410 / 385	SAR 10g:	0.161 W/kg
CONVERSION FACTORS:	0.468 / 0.468 / 0.468	SAR START:	0.109 W/kg
TYPE OF MODULATION:	CW	SAR END:	0.99 W/kg
MODN. DUTY CYCLE:	100%	SAR DRIFT DURING SCAN:	-0.418 dB
DIODE COMPRESSION FACTORS (V*200):	20 / 20 / 20	PROBE BATTERY LAST CHANGED:	16/02/04
INPUT POWER LEVEL:	184	EXTRAPOLATION:	poly4

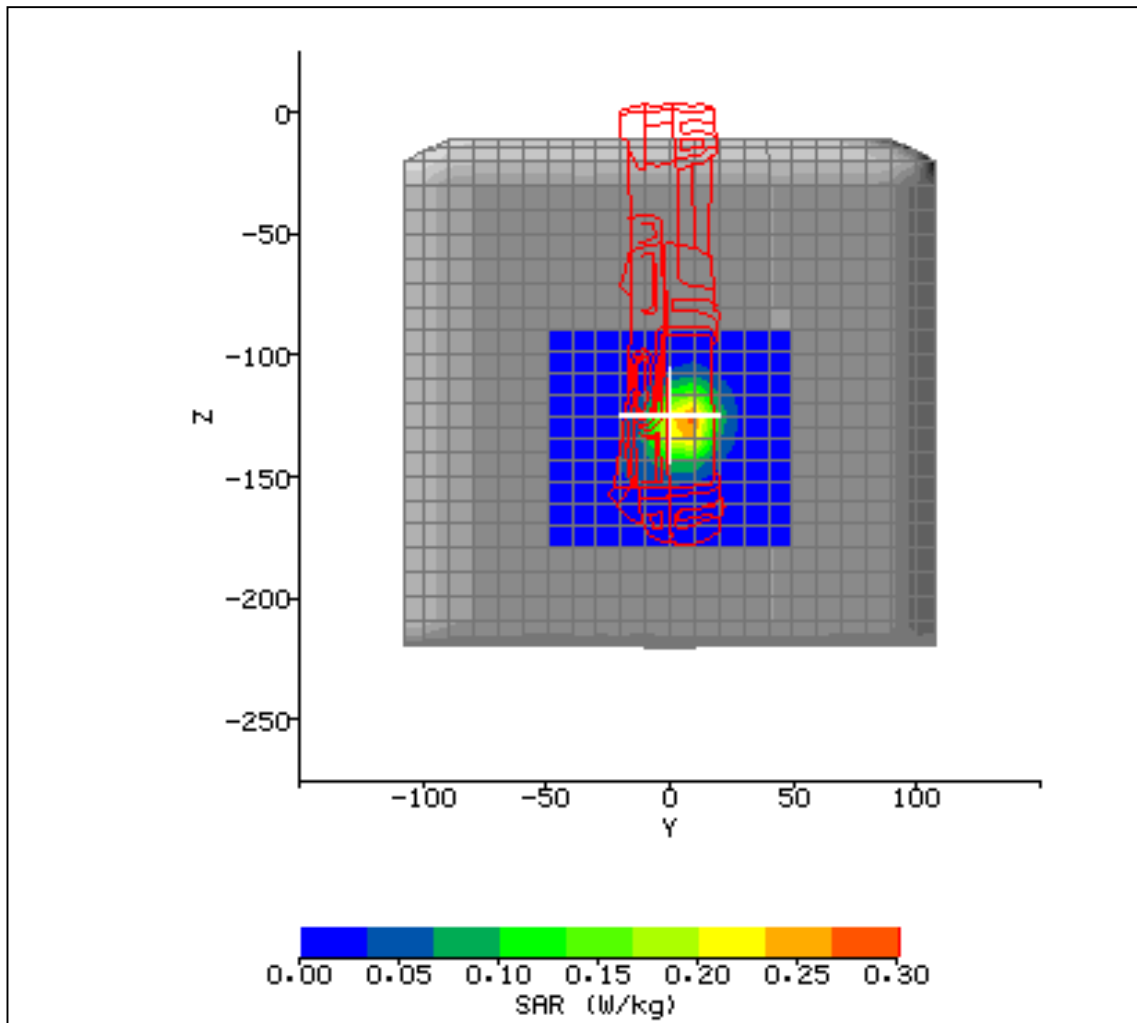

Figure 33



2.8 TEST RESULTS INCLUDING SAR DISTRIBUTIONS (AREA SCANS – 2D)

SYSTEM / SOFTWARE:	SARA2 / 2.1 VPM	INPUT POWER DRIFT:	0.0 dB
DATE / TIME:	20/02/2004 08:23:28	DUT BATTERY MODEL/NO:	21-62960-01
FILENAME:	611524_21.txt	PROBE SERIAL NUMBER:	0084
AMBIENT TEMPERATURE:	24.5°C	LIQUID SIMULANT:	2450 Body
DEVICE UNDER TEST:	Symbol MC9062 short	RELATIVE PERMITTIVITY:	51.29
RELATIVE HUMIDITY:	16.8%	CONDUCTIVITY:	2.031
PHANTOM S/NO:	HeadBox2mmb.csv	LIQUID TEMPERATURE:	23.7°C
PHANTOM ROTATION:	0°	MAX SAR Y-AXIS LOCATION:	10.0 mm
DUT POSITION:	L side to phantom	MAX SAR Z-AXIS LOCATION:	-128.7 mm
ANTENNA CONFIGURATION:	Internal	MAX E FIELD:	15.84 V/m
TEST FREQUENCY:	2437MHz (RLAN)	SAR 1g:	0.380 W/kg
AIR FACTORS:	500 / 410 / 385	SAR 10g:	0.184 W/kg
CONVERSION FACTORS:	0.468 / 0.468 / 0.468	SAR START:	0.117 W/kg
TYPE OF MODULATION:	CW	SAR END:	0.115 W/kg
MODN. DUTY CYCLE:	100%	SAR DRIFT DURING SCAN:	-0.07 dB
DIODE COMPRESSION FACTORS (V*200):	20 / 20 / 20	PROBE BATTERY LAST CHANGED:	16/02/04
INPUT POWER LEVEL:	184	EXTRAPOLATION:	poly4

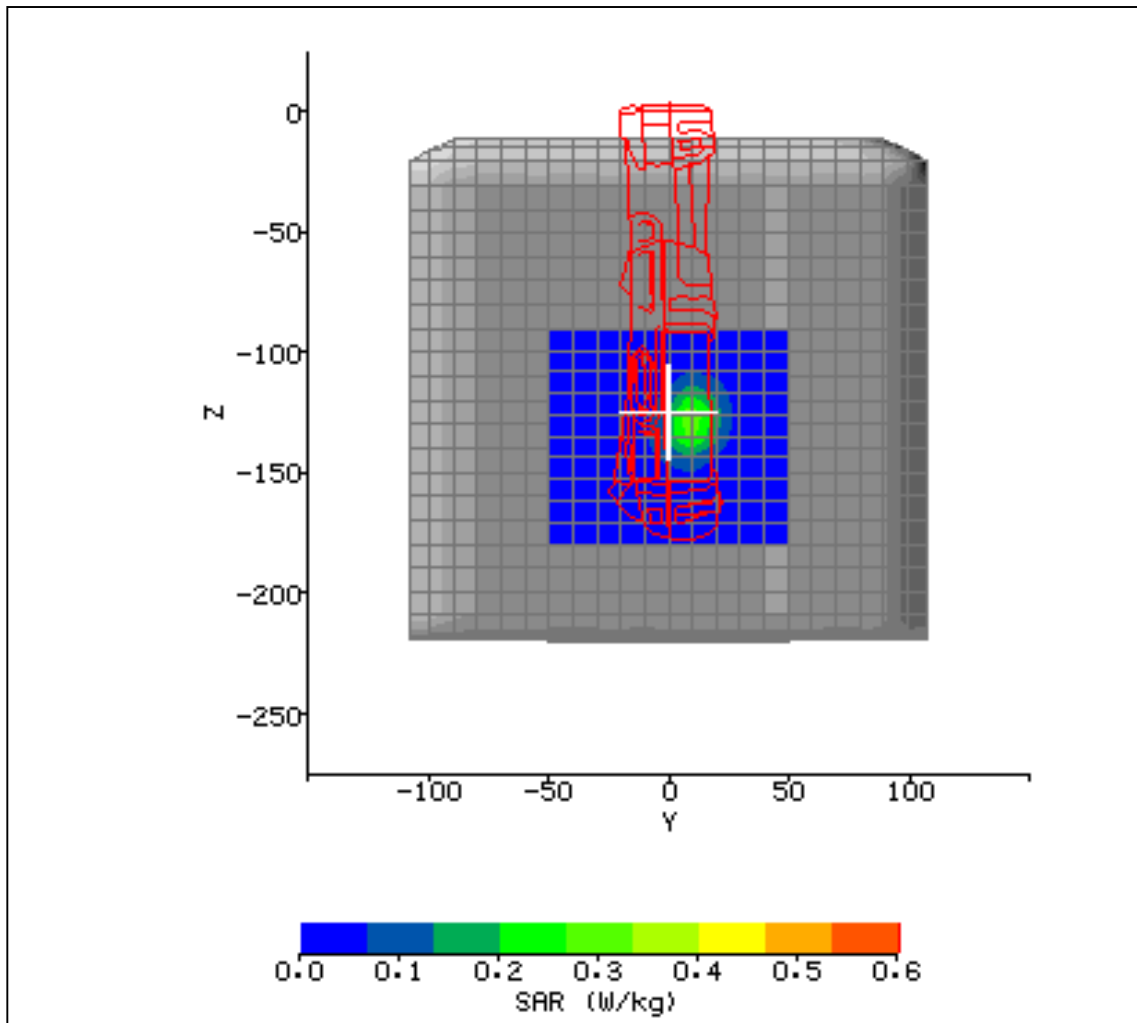

Figure 34



2.8 TEST RESULTS INCLUDING SAR DISTRIBUTIONS (AREA SCANS – 2D)

SYSTEM / SOFTWARE:	SARA2 / 2.1 VPM	INPUT POWER DRIFT:	0.0 dB
DATE / TIME:	20/02/2004 08:55:43	DUT BATTERY MODEL/NO:	21-62960-01
FILENAME:	611524_22.txt	PROBE SERIAL NUMBER:	0084
AMBIENT TEMPERATURE:	23.2°C	LIQUID SIMULANT:	2450 Body
DEVICE UNDER TEST:	Symbol MC9062 short	RELATIVE PERMITTIVITY:	51.29
RELATIVE HUMIDITY:	17.4%	CONDUCTIVITY:	2.031
PHANTOM S/NO:	HeadBox2mmb.csv	LIQUID TEMPERATURE:	23.7°C
PHANTOM ROTATION:	0°	MAX SAR Y-AXIS LOCATION:	10.0 mm
DUT POSITION:	L side to phantom	MAX SAR Z-AXIS LOCATION:	-128.7 mm
ANTENNA CONFIGURATION:	Internal	MAX E FIELD:	17.67 V/m
TEST FREQUENCY:	2462MHz (RLAN)	SAR 1g:	0.471 W/kg
AIR FACTORS:	500 / 410 / 385	SAR 10g:	0.226 W/kg
CONVERSION FACTORS:	0.468 / 0.468 / 0.468	SAR START:	0.140 W/kg
TYPE OF MODULATION:	CW	SAR END:	0.138 W/kg
MODN. DUTY CYCLE:	100%	SAR DRIFT DURING SCAN:	-0.07 dB
DIODE COMPRESSION FACTORS (V*200):	20 / 20 / 20	PROBE BATTERY LAST CHANGED:	16/02/04
INPUT POWER LEVEL:	184	EXTRAPOLATION:	poly4

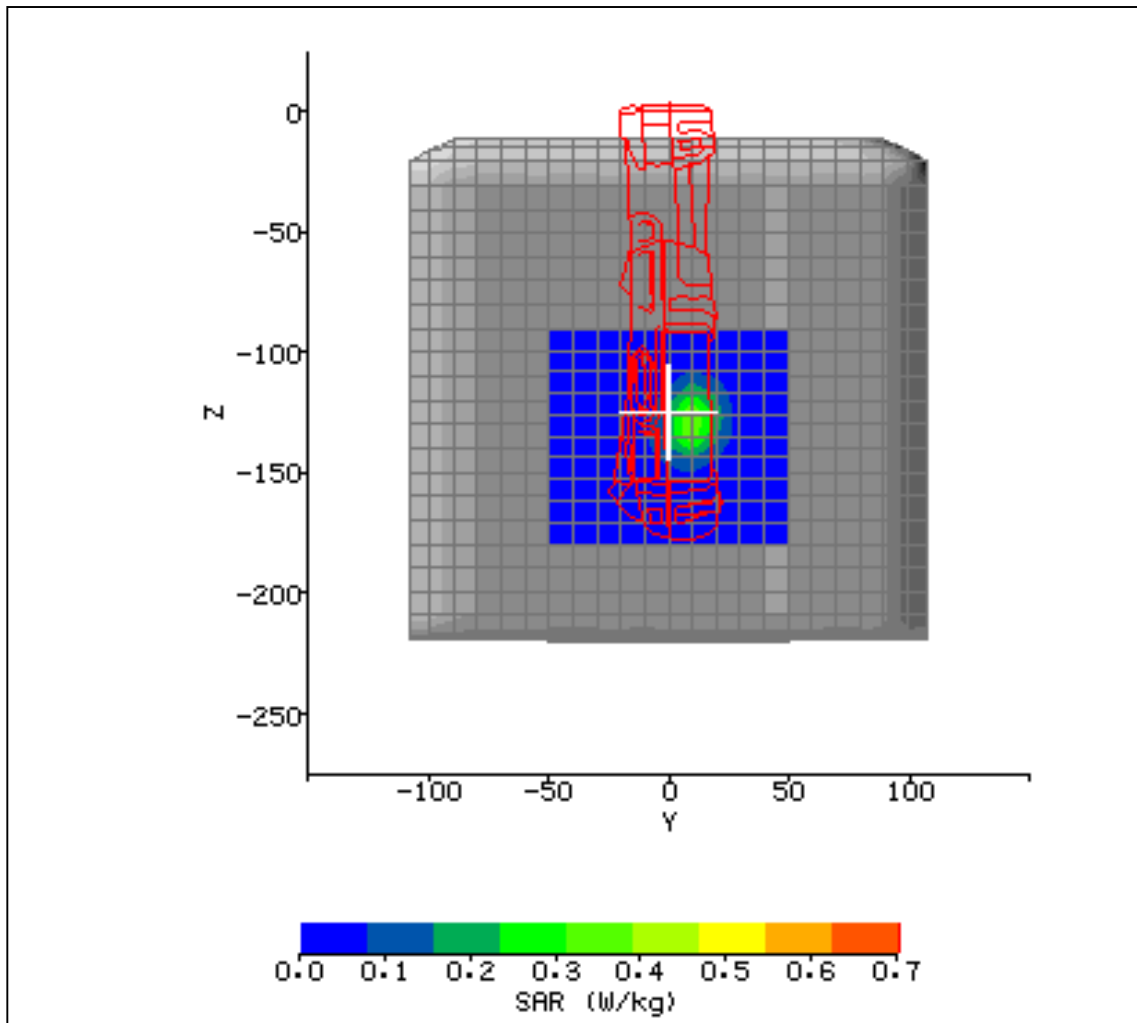

Figure 35



2.8 TEST RESULTS INCLUDING SAR DISTRIBUTIONS (AREA SCANS – 2D)

SYSTEM / SOFTWARE:	SARA2 / 2.1 VPM	INPUT POWER DRIFT:	0.0 dB
DATE / TIME:	20/02/2004 09:28:09	DUT BATTERY MODEL/NO:	21-62960-01
FILENAME:	611524_23.txt	PROBE SERIAL NUMBER:	0084
AMBIENT TEMPERATURE:	22.9°C	LIQUID SIMULANT:	2450 Body
DEVICE UNDER TEST:	Symbol MC9062 short	RELATIVE PERMITTIVITY:	51.29
RELATIVE HUMIDITY:	17.7%	CONDUCTIVITY:	2.031
PHANTOM S/NO:	HeadBox2mmb.csv	LIQUID TEMPERATURE:	23.6°C
PHANTOM ROTATION:	0°	MAX SAR Y-AXIS LOCATION:	10.0 mm
DUT POSITION:	L side to phantom	MAX SAR Z-AXIS LOCATION:	-128.7 mm
ANTENNA CONFIGURATION:	Internal	MAX E FIELD:	18.50 V/m
TEST FREQUENCY:	2472MHz (RLAN)	SAR 1g:	0.516 W/kg
AIR FACTORS:	500 / 410 / 385	SAR 10g:	0.246 W/kg
CONVERSION FACTORS:	0.468 / 0.468 / 0.468	SAR START:	0.151 W/kg
TYPE OF MODULATION:	CW	SAR END:	0.150 W/kg
MODN. DUTY CYCLE:	100%	SAR DRIFT DURING SCAN:	-0.03 dB
DIODE COMPRESSION FACTORS (V*200):	20 / 20 / 20	PROBE BATTERY LAST CHANGED:	16/02/04
INPUT POWER LEVEL:	184	EXTRAPOLATION:	poly4

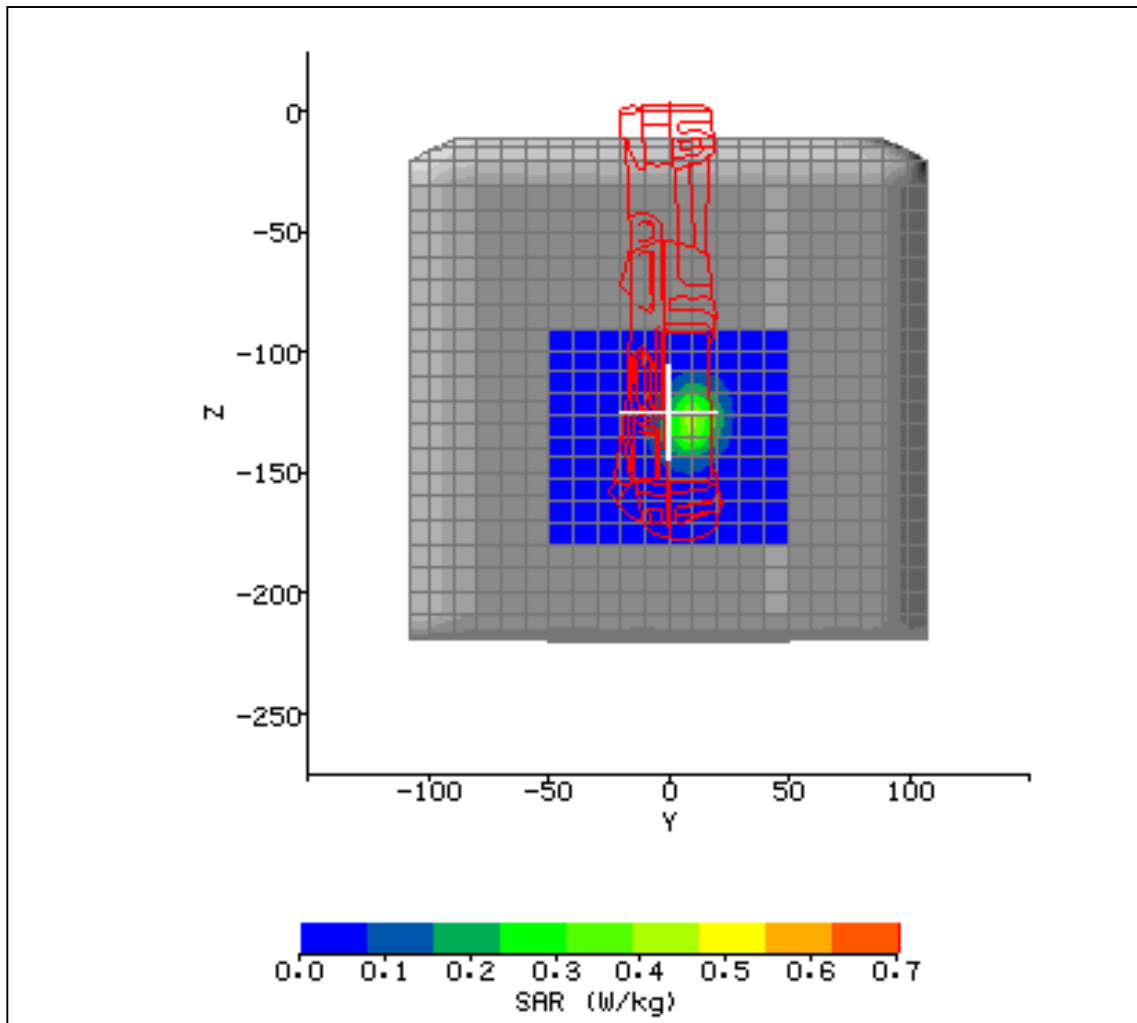

Figure 36



2.9 TEST POSITIONAL PHOTOGRAPHS



Figure 37. Positional photograph of the MC9062 left-hand side at 1.0cm from Phantom side



Figure 38. Positional photograph of the MC9062 Right-hand side at 1.0cm from Phantom side

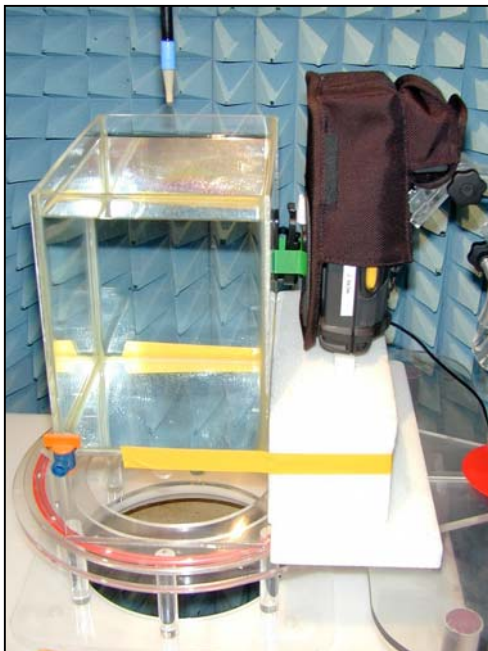

Figure 39. Positional photograph of the MC9062 With the device in a Mobile Computer Holster With the LCD side facing the rear of the Holster and the belt Clip in contact with the flat phantom.



Figure 40. Positional photograph of the MC9062 With the device in a Mobile Computer Holster With the Rear side facing the rear of the Holster and the belt Clip in contact with the flat phantom.

2.10 RECORD PHOTOGRAPHS



Figure 41. Front view

2.10 RECORD PHOTOGRAPHS



Figure 42. Rear view

2.10 RECORD PHOTOGRAPHS



Figure 43. Device placed in correct position with the MC9062 Mobile Computer Holster with LCD facing rear of Holster.

2.10 RECORD PHOTOGRAPHS



Figure 44. Headset

2.10 RECORD PHOTOGRAPHS



Figure 45. Holster Front View

2.10 RECORD PHOTOGRAPHS



Figure 46. Holster Rear View

FCC ID: H9PMC9062A
IC: 1549D-MC9062A



2.11 COPYRIGHT STATEMENT

© 2004 TUV Product Service Limited

This report must not be reproduced without the written permission of TUV Product Service Limited.