



FCC TEST REPORT (BLUETOOTH)

REPORT NO.: RF981022L04-2
MODEL NO.: MC75A8
RECEIVED: Oct. 22, 2009
TESTED: Apr. 16 ~ Apr. 20, 2010
ISSUED: Jun. 17, 2010

APPLICANT: Symbol Technologies, Inc.

ADDRESS: One Motorola Plaza, Holtsville, NY-11742-1300,
U.S.A.

ISSUED BY: Bureau Veritas Consumer Products Services (H.K.)
Ltd., Taoyuan Branch

LAB ADDRESS: No. 47, 14th Ling, Chia Pau Tsuen, Lin Kou Hsiang,
Taipei Hsien 244, Taiwan, R.O.C.

TEST LOCATION: No. 19, Hwa Ya 2nd Rd, Wen Hwa Tsuen, Kwei
Shan Hsiang, Taoyuan Hsien 333, Taiwan, R.O.C.

This test report consists of 62 pages in total. It may be duplicated completely for legal use with the approval of the applicant. It should not be reproduced except in full, without the written approval of our laboratory. The client should not use it to claim product endorsement by TAF or any government agencies. The test results in the report only apply to the tested sample.



Table of Contents

1.	CERTIFICATION.....	4
2.	SUMMARY OF TEST RESULTS	5
2.1	MEASUREMENT UNCERTAINTY	5
3.	GENERAL INFORMATION.....	6
3.1	GENERAL DESCRIPTION OF EUT	6
3.2	DESCRIPTION OF TEST MODES	8
3.2.1	CONFIGURATION OF SYSTEM UNDER TEST	8
3.2.2	TEST MODE APPLICABILITY AND TESTED CHANNEL DETAIL	9
3.3	GENERAL DESCRIPTION OF APPLIED STANDARDS	11
3.4	DESCRIPTION OF SUPPORT UNITS	11
4.	TEST TYPES AND RESULTS	12
4.1	RADIATED EMISSION MEASUREMENT	12
4.1.1	LIMITS OF RADIATED EMISSION MEASUREMENT	12
4.1.2	TEST INSTRUMENTS.....	13
4.1.3	TEST PROCEDURES	14
4.1.4	DEVIATION FROM TEST STANDARD.....	14
4.1.5	TEST SETUP	15
4.1.6	EUT OPERATING CONDITIONS	15
4.1.7	TEST RESULTS	16
4.2	CONDUCTED EMISSION MEASUREMENT	25
4.2.1	LIMITS OF CONDUCTED EMISSION MEASUREMENT	25
4.2.2	TEST INSTRUMENTS.....	25
4.2.3	TEST PROCEDURES	26
4.2.4	DEVIATION FROM TEST STANDARD.....	26
4.2.5	TEST SETUP.....	27
4.2.6	EUT OPERATING CONDITIONS	27
4.2.7	TEST RESULTS	28
4.3	NUMBER OF HOPPING FREQUENCY USED	30
4.3.1	LIMIT OF HOPPING FREQUENCY USED.....	30
4.3.2	TEST INSTRUMENTS.....	30
4.3.3	TEST PROCEDURES	30
4.3.4	DEVIATION FROM TEST STANDARD.....	31
4.3.5	TEST SETUP.....	31
4.3.6	TEST RESULTS	31
4.4	DWELL TIME ON EACH CHANNEL	34
4.4.1	LIMIT OF DWELL TIME USED	34
4.4.2	TEST INSTRUMENTS.....	34



A D T

4.4.3	TEST PROCEDURES	34
4.4.4	DEVIATION FROM TEST STANDARD.....	34
4.4.5	TEST SETUP	35
4.4.6	TEST RESULTS	35
4.5	CHANNEL BANDWIDTH.....	43
4.5.1	LIMITS OF CHANNEL BANDWIDTH	43
4.5.2	TEST INSTRUMENTS.....	43
4.5.3	TEST PROCEDURE.....	43
4.5.4	DEVIATION FROM TEST STANDARD.....	44
4.5.5	TEST SETUP.....	44
4.5.6	EUT OPERATING CONDITION.....	44
4.5.7	TEST RESULTS	45
4.6	HOPPING CHANNEL SEPARATION.....	47
4.6.1	LIMIT OF HOPPING CHANNEL SEPARATION	47
4.6.2	TEST INSTRUMENTS.....	47
4.6.3	TEST PROCEDURES	47
4.6.4	DEVIATION FROM TEST STANDARD.....	47
4.6.5	TEST SETUP.....	47
4.6.6	TEST RESULTS	48
4.7	MAXIMUM OUTPUT POWER	50
4.7.1	LIMITS OF MAXIMUM OUTPUT POWER MEASUREMENT.....	50
4.7.2	TEST INSTRUMENTS.....	50
4.7.3	TEST PROCEDURES	50
4.7.4	DEVIATION FROM TEST STANDARD.....	50
4.7.5	TEST SETUP.....	51
4.7.6	EUT OPERATING CONDITION.....	51
4.7.7	TEST RESULTS	51
4.8	BAND EDGES MEASUREMENT	53
4.8.1	LIMITS OF BAND EDGES MEASUREMENT.....	53
4.8.2	TEST INSTRUMENTS.....	53
4.8.3	TEST PROCEDURE.....	53
4.8.4	DEVIATION FROM TEST STANDARD.....	53
4.8.5	EUT OPERATING CONDITION.....	53
4.8.6	TEST RESULTS	54
5.	PHOTOGRAPHS OF THE TEST CONFIGURATION.....	60
6.	INFORMATION ON THE TESTING LABORATORIES	61
7.	APPENDIX A - MODIFICATIONS RECORDERS FOR ENGINEERING CHANGES TO THE EUT BY THE LAB.....	62

2. SUMMARY OF TEST RESULTS

The EUT has been tested according to the following specifications:

APPLIED STANDARD: FCC Part 15, Subpart C			
STANDARD SECTION	TEST TYPE AND LIMIT	RESULT	REMARK
15.207	AC Power Conducted Emission	PASS	Meet the requirement of limit. Minimum passing margin is -15.34dB at 0.154MHz.
15.247(a)(1)(iii)	Number of Hopping Frequency Used Spec.: At least 15 channels	PASS	Meet the requirement of limit.
15.247(a)(1)(iii)	Dwell Time on Each Channel Spec.: Max. 0.4 second within 31.6 second	PASS	Meet the requirement of limit.
15.247(a)(1)	1. Hopping Channel Separation Spec.: Min. 25 kHz or 20 dB bandwidth, whichever is greater 2. Spectrum Bandwidth of a Frequency Hopping Sequence Spread Spectrum System	PASS	Meet the requirement of limit.
15.247(b)	Maximum Peak Output Power Spec.: max. 21dBm	PASS	Meet the requirement of limit.
15.247(d)	Transmitter Radiated Emissions Spec.: Table 15.209	PASS	Meet the requirement of limit. Minimum passing margin is -6.9dB at 66.84MHz.
15.247(d)	Band Edge Measurement	PASS	Meet the requirement of limit.
15.203	Antenna Requirement	PASS	No antenna connector is used.

NOTE: If The Frequency Hopping System operating in 2400-2483.5MHz band and the output power less than 125mW. The hopping channel carrier frequencies separated by a minimum of 25kHz or two-thirds of the 20dB bandwidth of hopping channel whichever is greater.

2.1 MEASUREMENT UNCERTAINTY

Where relevant, the following measurement uncertainty levels have been estimated for tests performed on the EUT as specified in CISPR 16-4-2:

MEASUREMENT	FREQUENCY	UNCERTAINTY
Conducted emissions	150kHz ~ 30MHz	2.44dB
Radiated emissions	30MHz ~ 200MHz	2.93dB
	200MHz ~ 1000MHz	2.95dB
	1GHz ~ 18GHz	2.26dB
	18GHz ~ 40GHz	1.94dB

This uncertainty represents an expanded uncertainty expressed at approximately the 95% confidence level using a coverage factor of k=2.

3. GENERAL INFORMATION

3.1 GENERAL DESCRIPTION OF EUT

EUT	EDA (Enterprise Digital Assistant)
MODEL NO.	MC75A8
FCC ID	H9PMC75A8
POWER SUPPLY	3.7Vdc (Li-Lon battery) 5.4Vdc (Adapter)
MODULATION TYPE	GFSK, $\pi/4$ -DQPSK, 8DPSK
MODULATION TECHNOLOGY	FHSS
TRANSFER RATE	1/2/3Mbps
OPERATING FREQUENCY	2402 ~ 2480MHz
NUMBER OF CHANNEL	79
OUTPUT POWER	2.3mW
ANTENNA TYPE	Chip antenna
MAX. ANTENNA GAIN	-1.5dBi
ANTENNA CONNECTOR	NA
DATA CABLE	NA
I/O PORTS	Refer to user's manual
ACCESSORY DEVICES	Battery

NOTE:

1. The EUT is an EDA (Enterprise Digital Assistant). The test data are separated into following test reports:

	TEST STANDARD	REFERENCE REPORT
WLAN 802.11b/g	FCC Part 15, Subpart C (Section 15.247)	RF981022L04
WLAN 802.11a (5745~5825 MHz)		
WLAN 802.11a (5180~5320MHz, 5500~5700MHz)	FCC Part 15, Subpart E (Section 15.407)	RF981022L04-1
WLAN 802.11a (For DFS report) (5260~5320MHz, 5500~5700MHz)	FCC Part 15, Subpart E (Section 15.407)	RF981022L04-3
BLUETOOTH	FCC Part 15, Subpart C (Section 15.247)	RF981022L04-2
CDMA 850	FCC Part 22	RF981022L04-4
CDMA 1900	FCC Part 24	RF981022L04-5

2. The models identified as below are identical to each other except of the following options:

- Keypad: Numeric / QWERTY
- Barcode reader: 1D laser scanner / BB Imager

BRAND	MODEL	DESCRIPTION
Symbol	MC75A8	EVDO 1D Numeric
Symbol	MC75A8	EVDO 1D QWERTY
Symbol	MC75A8	EVDO BB Numeric
Symbol	MC75A8	EVDO BB QWERTY

**the worst case had been marked by boldface.

3. The EUT uses the following Li-Lon batteries:

BATTERY 1 (1.5X)	
BRAND:	MOTOROLA
PART NUMBER:	82-71364-05 Rev D
RATING:	3.7Vdc, 3600mAh, 13.3Wh

BATTERY 2 (2.5X)	
BRAND:	MOTOROLA
PART NUMBER:	82-71364-06 Rev C
RATING:	3.7Vdc, 4800mAh, 17.7Wh

*Battery 2 was chosen as the representative for testing.

4. The following accessories are optional to the DUT.

PRODUCT	BRAND	MODEL	DESCRIPTION
RS232 charging cable	Motorola	25-102776-01R	1.2m non-shielded cable with one core
USB charging cable	Motorola	25-102775-01R	1.5m shielded cable with one core
Headset	Motorola	50-11300-050R	VR10 headset 0.8m non-shielded cable with one core
Power Supply Adaptor	Motorola	EADP-16BB A	I/P: 100-240Vac, 50-60Hz, 0.4A O/P: 5.4Vdc, 3A 1.8m non-shielded cable without core

5. The above EUT information was declared by manufacturer and for more detailed features description, please refer to the manufacturer's specifications or user's manual.

3.2 DESCRIPTION OF TEST MODES

79 channels are provided to this EUT:

CHANNEL	FREQ. (MHz)	CHANNEL	FREQ. (MHz)	CHANNEL	FREQ. (MHz)	CHANNEL	FREQ. (MHz)
0	2402	20	2422	40	2442	60	2462
1	2403	21	2423	41	2443	61	2463
2	2404	22	2424	42	2444	62	2464
3	2405	23	2425	43	2445	63	2465
4	2406	24	2426	44	2446	64	2466
5	2407	25	2427	45	2447	65	2467
6	2408	26	2428	46	2448	66	2468
7	2409	27	2429	47	2449	67	2469
8	2410	28	2430	48	2450	68	2470
9	2411	29	2431	49	2451	69	2471
10	2412	30	2432	50	2452	70	2472
11	2413	31	2433	51	2453	71	2473
12	2414	32	2434	52	2454	72	2474
13	2415	33	2435	53	2455	73	2475
14	2416	34	2436	54	2456	74	2476
15	2417	35	2437	55	2457	75	2477
16	2418	36	2438	56	2458	76	2478
17	2419	37	2439	57	2459	77	2479
18	2420	38	2440	58	2460	78	2480
19	2421	39	2441	59	2461		

3.2.1 CONFIGURATION OF SYSTEM UNDER TEST

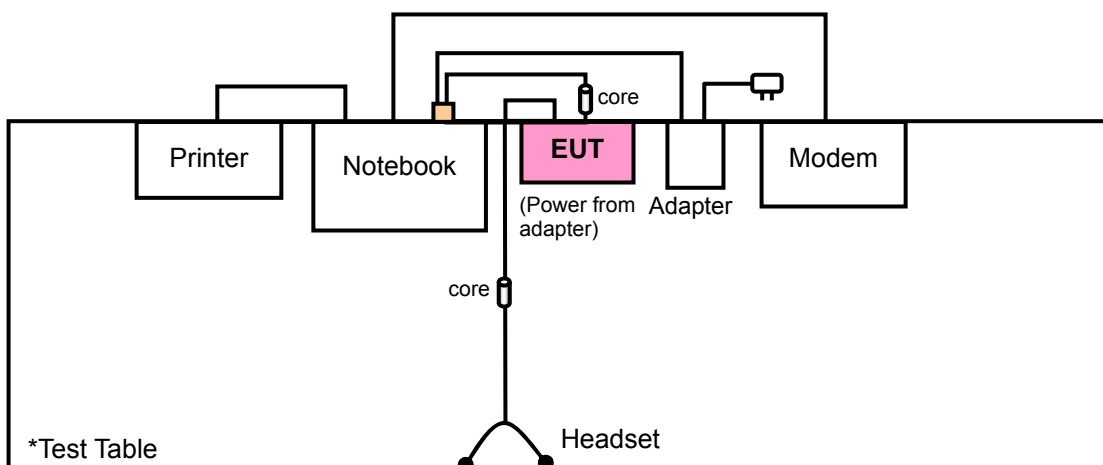

3.2.2 TEST MODE APPLICABILITY AND TESTED CHANNEL DETAIL

EUT CONFIGURE MODE	APPLICABLE TO				DESCRIPTION
	RE \geq 1G	RE<1G	PLC	APCM	
-	√	√	√	√	-

Where **RE \geq 1G**: Radiated Emission above 1GHz **RE<1G**: Radiated Emission below 1GHz
PLC: Power Line Conducted Emission **APCM**: Antenna Port Conducted Measurement

RADIATED EMISSION TEST (ABOVE 1 GHz):

- Pre-Scan has been conducted to determine the worst-case mode from all possible combinations between available modulations, data rates, XYZ axis, antenna ports (if EUT with antenna diversity architecture) and packet type.
- Following channel(s) was (were) selected for the final test as listed below.

AVAILABLE CHANNEL	TESTED CHANNEL	MODULATION TECHNOLOGY	MODULATION TYPE	PACKET TYPE	AXIS
0 to 78	0, 39, 78	FHSS	GFSK	DH5	Y
0 to 78	0, 39, 78	FHSS	8DPSK	DH5	Y

RADIATED EMISSION TEST (BELOW 1 GHz):

- Pre-Scan has been conducted to determine the worst-case mode from all possible combinations between available modulations, data rates, XYZ axis, antenna ports (if EUT with antenna diversity architecture) and packet type.
- Following channel(s) was (were) selected for the final test as listed below.

AVAILABLE CHANNEL	TESTED CHANNEL	MODULATION TECHNOLOGY	MODULATION TYPE	PACKET TYPE	AXIS
0 to 78	0	FHSS	8DPSK	DH5	Y

POWER LINE CONDUCTED EMISSION TEST:

- Pre-Scan has been conducted to determine the worst-case mode from all possible combinations between available modulations, antenna ports (if EUT with antenna diversity architecture), and packet types.
- Following channel(s) was (were) selected for the final test as listed below.

AVAILABLE CHANNEL	TESTED CHANNEL	MODULATION TECHNOLOGY	MODULATION TYPE	PACKET TYPE
0 to 78	0	FHSS	8DPSK	DH5

BANDEDGE MEASUREMENT:

- Pre-Scan has been conducted to determine the worst-case mode from all possible combinations between available modulations, antenna ports (if EUT with antenna diversity architecture), and packet types.
- Following channel(s) was (were) selected for the final test as listed below.

AVAILABLE CHANNEL	TESTED CHANNEL	MODULATION TECHNOLOGY	MODULATION TYPE	PACKET TYPE
0 to 78	0, 78	FHSS	GFSK	DH5
0 to 78	0, 78	FHSS	8DPSK	DH5

ANTENNA PORT CONDUCTED MEASUREMENT:

- This item includes all test value of each mode, but only includes spectrum plot of worst value of each mode.
- Pre-Scan has been conducted to determine the worst-case mode from all possible combinations between available modulations, antenna ports (if EUT with antenna diversity architecture), and packet types.
- Following channel(s) was (were) selected for the final test as listed below.

AVAILABLE CHANNEL	TESTED CHANNEL	MODULATION TECHNOLOGY	MODULATION TYPE	PACKET TYPE
0 to 78	0, 39, 78	FHSS	GFSK	DH5
0 to 78	0, 39, 78	FHSS	8DPSK	DH5

TEST CONDITION:

APPLICABLE TO	ENVIRONMENTAL CONDITIONS	INPUT POWER (SYSTEM)	TESTED BY
RE\geq1G	25deg. C, 70%RH, 1006 hPa	120Vac, 60Hz	Lori Chiu
RE$<$1G	25deg. C, 70%RH, 1006 hPa	120Vac, 60Hz	Lori Chiu
PLC	22deg. C, 66%RH, 1017 hPa	120Vac, 60Hz	Dean Wang
APCM	23deg. C, 65%RH, 1014 hPa	120Vac, 60Hz	Lori Chiu



3.3 GENERAL DESCRIPTION OF APPLIED STANDARDS

The EUT is a RF Product. According to the specifications of the manufacturer, it must comply with the requirements of the following standards:

FCC Part 15, Subpart C. (15.247) **ANSI C63.4-2003**

All test items have been performed and recorded as per the above standards.

NOTE: The EUT is also considered as a kind of computer peripheral, because the connection to computer is necessary for typical use. It has been verified to comply with the requirements of FCC Part 15, Subpart B, Class B (DoC). The test report has been issued separately.

3.4 DESCRIPTION OF SUPPORT UNITS

The EUT has been tested as an independent unit together with other necessary accessories or support units. The following support units or accessories were used to form a representative test configuration during the tests.

NO.	PRODUCT	BRAND	MODEL NO.	SERIAL NO.	FCC ID
1	NOTEBOOK	DELL	PP05L	12130898320	E2K24CLNS
2	PRINTER	EPSON	LQ-300+	DCGY054146	FCC DoC Approved
3	MODEM	ACEEX	1414V/3	0401008260	IFAXDM1414

NO.	SIGNAL CABLE DESCRIPTION OF THE ABOVE SUPPORT UNITS
1	NA
2	1.8m braid shielded wire, DB25 connector, w/o core.
3	1.2m braid shielded wire, DB25 & DB9 connector, w/o core.

NOTE: All power cords of the above support units are non-shielded (1.8m).

4. TEST TYPES AND RESULTS

4.1 RADIATED EMISSION MEASUREMENT

4.1.1 LIMITS OF RADIATED EMISSION MEASUREMENT

Emissions radiated outside of the specified bands, shall be according to the general radiated limits in 15.209 as following:

FREQUENCIES (MHz)	FIELD STRENGTH (microvolts/meter)	MEASUREMENT DISTANCE (meters)
0.009 ~ 0.490	2400/F(kHz)	300
0.490 ~ 1.705	24000/F(kHz)	30
1.705 ~ 30.0	30	30
30 ~ 88	100	3
88 ~ 216	150	3
216 ~ 960	200	3
Above 960	500	3

NOTE:

1. The lower limit shall apply at the transition frequencies.
2. Emission level (dBuV/m) = 20 log Emission level (uV/m).
3. As shown in 15.35(b), for frequencies above 1000MHz, the field strength limits are based on average detector, however, the peak field strength of any emission shall not exceed the maximum permitted average limits, specified above by more than 20dB under any condition of modulation.

4.1.2 TEST INSTRUMENTS

DESCRIPTION & MANUFACTURER	MODEL NO.	SERIAL NO.	DATE OF CALIBRATION	DUE DATE OF CALIBRATION
Test Receiver ROHDE & SCHWARZ	ESIB7	100212	May 25, 2009	May 24, 2010
Spectrum Analyzer ROHDE & SCHWARZ	FSP40	100040	Jul. 07, 2009	Jul. 06, 2010
BILOG Antenna SCHWARZBECK	VULB9168	9168-156	Apr. 30, 2009	Apr. 29, 2010
HORN Antenna SCHWARZBECK	BBHA 9120 D	9120D-563	Aug. 10, 2009	Aug. 09, 2010
HORN Antenna SCHWARZBECK	BBHA 9170	BBHA9170242	Dec. 25, 2009	Dec. 24, 2010
Preamplifier Agilent	8449B	3008A01910	Sep. 11, 2009	Sep. 10, 2010
Preamplifier Agilent	8447D	2944A10638	Dec. 21, 2009	Dec. 20, 2010
RF signal cable HUBER+SUHNNER	SUCOFLEX 104	218190/4 231241/4	May 13, 2009	May 12, 2010
RF signal cable Worken	8D-FB	Cable-HYCH9-01	Aug. 17, 2009	Aug. 16, 2010
Software	ADT_Radiated_ V7.6.15.9.2	NA	NA	NA
Antenna Tower EMCO	2070/2080	512.835.4684	NA	NA
Turn Table EMCO	2087-2.03	NA	NA	NA
Antenna Tower & Turn Table Controller EMCO	2090	NA	NA	NA

- NOTE:**
1. The calibration interval of the above test instruments is 12 months and the calibrations are traceable to NML/ROC and NIST/USA.
 2. The test was performed in HwaYa Chamber 9.
 3. The horn antenna and HP preamplifier (model: 8449B) are used only for the measurement of emission frequency above 1GHz if tested.
 4. The FCC Site Registration No. is 460141.
 5. The IC Site Registration No. is IC 7450F-4.

4.1.3 TEST PROCEDURES

- a. The EUT was placed on the top of a rotating table 0.8 meters above the ground at a 3 meter semi-anechoic chamber. The table was rotated 360 degrees to determine the position of the highest radiation.
- b. The EUT was set 3 meters away from the interference-receiving antenna, which was mounted on the top of a variable-height antenna tower.
- c. The antenna is a broadband antenna, and its height is varied from one meter to four meters above the ground to determine the maximum value of the field strength. Both horizontal and vertical polarizations of the antenna are set to make the measurement.
- d. For each suspected emission, the EUT was arranged to its worst case and then the antenna was tuned to heights from 1 meter to 4 meters and the rotatable table was turned from 0 degrees to 360 degrees to find the maximum reading.
- e. The test-receiver system was set to Peak Detect Function and Specified Bandwidth with Maximum Hold Mode.
- f. If the emission level of the EUT in peak mode was lower than the limit specified, then testing could be stopped and the peak values of the EUT would be reported. Otherwise the emissions would be re-tested one by one using peak, quasi-peak or average method as specified and then reported in a data sheet.

NOTE:

1. The resolution bandwidth and video bandwidth of test receiver/spectrum analyzer is 120kHz for Quasi-peak detection at frequency below 1GHz.
2. The resolution bandwidth of test receiver/spectrum analyzer is 1 MHz and video bandwidth is 3MHz for Peak detection at frequency above 1GHz.
3. All modes of operation were investigated and the worst-case emissions are reported.

4.1.4 DEVIATION FROM TEST STANDARD

No deviation.

4.1.5 TEST SETUP

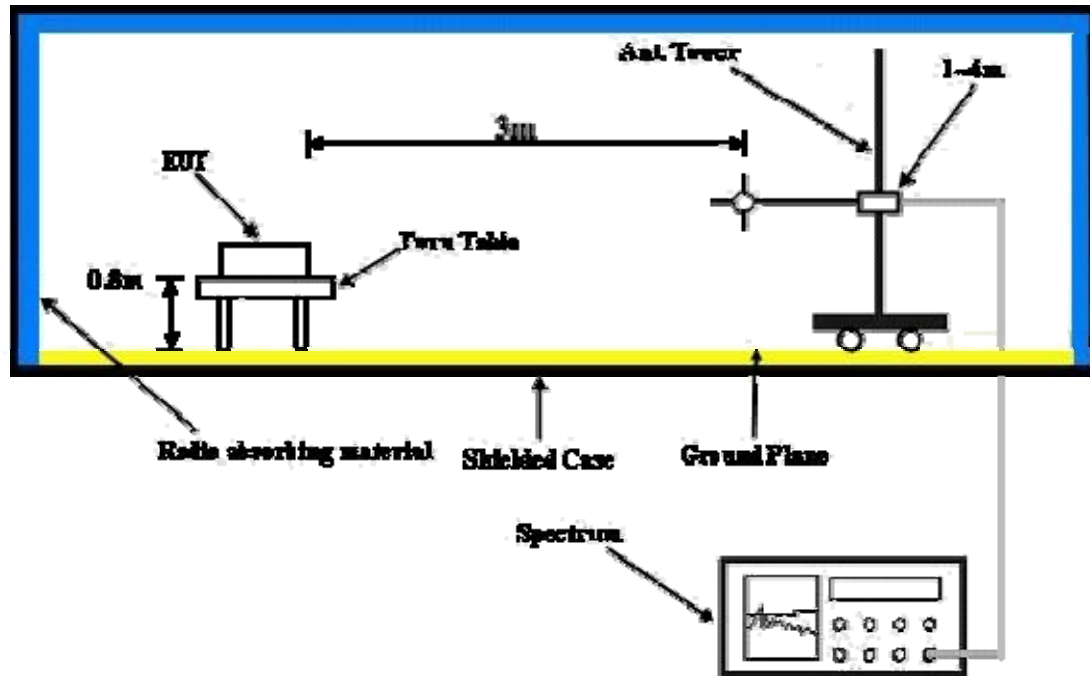

For the actual test configuration, please refer to the attached file (Test Setup Photo).

4.1.6 EUT OPERATING CONDITIONS

- a. Connected the EUT to a notebook via USB cable and placed on a testing table.
- b. The EUT runs a test program (provided by manufacture) to transmit at specific channel.
- c. The necessary accessories enable the system in full functions.



4.1.7 TEST RESULTS

ABOVE 1GHZ WORST-CASE DATA : GFSK

EUT TEST CONDITION		MEASUREMENT DETAIL	
CHANNEL	Channel 0	FREQUENCY RANGE	1 ~ 25GHz
INPUT POWER (SYSTEM)	120Vac, 60 Hz	DETECTOR FUNCTION	Peak (PK) Average (AV)
ENVIRONMENTAL CONDITIONS	25deg. C, 70%RH 1006 hPa	TESTED BY	Lori Chiu

ANTENNA POLARITY & TEST DISTANCE: HORIZONTAL AT 3 M								
NO.	FREQ. (MHz)	EMISSION LEVEL (dBuV/m)	LIMIT (dBuV/m)	MARGIN (dB)	ANTENNA HEIGHT (m)	TABLE ANGLE (Degree)	RAW VALUE (dBuV)	CORRECTION FACTOR (dB/m)
1	2390.00	44.1 PK	74.0	-29.9	1.03 H	116	11.80	32.30
2	2390.00	31.3 AV	54.0	-22.7	1.03 H	116	-1.00	32.30
3	2397.50	47.7 PK	74.0	-26.3	1.03 H	116	15.40	32.30
4	2397.50	37.9 AV	54.0	-16.1	1.03 H	116	5.60	32.30
5	2400.00	39.5 PK	74.0	-34.5	1.03 H	116	7.20	32.30
6	2400.00	9.4 AV	54.0	-44.6	1.03 H	116	-22.90	32.30
7	*2402.00	95.5 PK			1.03 H	116	63.20	32.30
8	*2402.00	65.4 AV			1.03 H	116	33.10	32.30
9	4804.00	47.6 PK	74.0	-26.4	1.15 H	209	9.30	38.30
10	4804.00	17.5 AV	54.0	-36.5	1.15 H	209	-20.80	38.30

- REMARKS:**
1. Emission level (dBuV/m) = Raw Value (dBuV) + Correction Factor (dB/m).
 2. Correction Factor (dB/m) = Antenna Factor (dB/m) + Cable Factor (dB).
 3. The other emission levels were very low against the limit.
 4. Margin value = Emission level – Limit value.
 5. “ * “: Fundamental frequency.
 6. The DH5 packet was the worse case duty cycle for a transmit dwell time on a channel, based upon bluetooth theory the transmitter is on 0.625 * 5 per 296.25 ms per channel. Therefore, the duty cycle correlation factor be equal to: $20\log(3.125 / 100) = -30.1$ dB.
 7. Average value = peak reading + $20\log(\text{duty cycle})$.



A D T

EUT TEST CONDITION		MEASUREMENT DETAIL	
CHANNEL	Channel 0	FREQUENCY RANGE	1 ~ 25GHz
INPUT POWER (SYSTEM)	120Vac, 60 Hz	DETECTOR FUNCTION	Peak (PK) Average (AV)
ENVIRONMENTAL CONDITIONS	25deg. C, 70%RH 1006 hPa	TESTED BY	Lori Chiu

ANTENNA POLARITY & TEST DISTANCE: VERTICAL AT 3 M								
NO.	FREQ. (MHz)	EMISSION LEVEL (dBuV/m)	LIMIT (dBuV/m)	MARGIN (dB)	ANTENNA HEIGHT (m)	TABLE ANGLE (Degree)	RAW VALUE (dBuV)	CORRECTION FACTOR (dB/m)
1	2390.00	43.9 PK	74.0	-30.1	1.00 V	118	11.60	32.30
2	2390.00	31.1 AV	54.0	-22.9	1.00 V	118	-1.20	32.30
3	2397.50	45.2 PK	74.0	-28.8	1.00 V	118	12.90	32.30
4	2397.50	35.7 AV	54.0	-18.3	1.00 V	118	3.40	32.30
5	2400.00	35.2 PK	74.0	-38.8	1.00 V	118	2.90	32.30
6	2400.00	5.1 AV	54.0	-48.9	1.00 V	118	-27.20	32.30
7	*2402.00	91.2 PK			1.00 V	118	58.90	32.30
8	*2402.00	61.1 AV			1.00 V	118	28.80	32.30
9	4804.00	49.3 PK	74.0	-24.7	1.03 V	142	11.00	38.30
10	4804.00	19.2 AV	54.0	-34.8	1.03 V	142	-19.10	38.30

- REMARKS:**
1. Emission level (dBuV/m) = Raw Value (dBuV) + Correction Factor (dB/m).
 2. Correction Factor (dB/m) = Antenna Factor (dB/m) + Cable Factor (dB).
 3. The other emission levels were very low against the limit.
 4. Margin value = Emission level – Limit value.
 5. “ * “: Fundamental frequency.
 6. The DH5 packet was the worse case duty cycle for a transmit dwell time on a channel, based upon bluetooth theory the transmitter is on 0.625 * 5 per 296.25 ms per channel. Therefore, the duty cycle correlation factor be equal to: $20\log(3.125 / 100) = -30.1$ dB.
 7. Average value = peak reading + $20\log(\text{duty cycle})$.



EUT TEST CONDITION		MEASUREMENT DETAIL	
CHANNEL	Channel 39	FREQUENCY RANGE	1 ~ 25GHz
INPUT POWER (SYSTEM)	120Vac, 60 Hz	DETECTOR FUNCTION	Peak (PK) Average (AV)
ENVIRONMENTAL CONDITIONS	25deg. C, 70%RH 1006 hPa	TESTED BY	Lori Chiu

ANTENNA POLARITY & TEST DISTANCE: HORIZONTAL AT 3 M								
NO.	FREQ. (MHz)	EMISSION LEVEL (dBuV/m)	LIMIT (dBuV/m)	MARGIN (dB)	ANTENNA HEIGHT (m)	TABLE ANGLE (Degree)	RAW VALUE (dBuV)	CORRECTION FACTOR (dB/m)
1	*2441.00	94.3 PK			1.00 H	146	61.80	32.50
2	*2441.00	64.2 AV			1.00 H	146	31.70	32.50
3	4882.00	49.1 PK	74.0	-24.9	1.05 H	174	10.60	38.50
4	4882.00	19.0 AV	54.0	-35.0	1.05 H	174	-19.50	38.50
ANTENNA POLARITY & TEST DISTANCE: VERTICAL AT 3 M								
NO.	FREQ. (MHz)	EMISSION LEVEL (dBuV/m)	LIMIT (dBuV/m)	MARGIN (dB)	ANTENNA HEIGHT (m)	TABLE ANGLE (Degree)	RAW VALUE (dBuV)	CORRECTION FACTOR (dB/m)
1	*2441.00	90.2 PK			1.15 V	101	57.70	32.50
2	*2441.00	60.1 AV			1.15 V	101	27.60	32.50
3	4882.00	49.3 PK	74.0	-24.7	1.05 V	21	10.80	38.50
4	4882.00	19.2 AV	54.0	-34.8	1.05 V	21	-19.30	38.50

- REMARKS:**
- Emission level (dBuV/m) = Raw Value (dBuV) + Correction Factor (dB/m).
 - Correction Factor (dB/m) = Antenna Factor (dB/m) + Cable Factor (dB).
 - The other emission levels were very low against the limit.
 - Margin value = Emission level – Limit value.
 - * *: Fundamental frequency.
 - The DH5 packet was the worse case duty cycle for a transmit dwell time on a channel, based upon bluetooth theory the transmitter is on 0.625 * 5 per 296.25 ms per channel. Therefore, the duty cycle correlation factor be equal to: $20\log(3.125 / 100) = -30.1$ dB.
 - Average value = peak reading + 20log(duty cycle).



EUT TEST CONDITION		MEASUREMENT DETAIL	
CHANNEL	Channel 78	FREQUENCY RANGE	1 ~ 25GHz
INPUT POWER (SYSTEM)	120Vac, 60 Hz	DETECTOR FUNCTION	Peak (PK) Average (AV)
ENVIRONMENTAL CONDITIONS	25deg. C, 70%RH 1006 hPa	TESTED BY	Lori Chiu

ANTENNA POLARITY & TEST DISTANCE: HORIZONTAL AT 3 M								
NO.	FREQ. (MHz)	EMISSION LEVEL (dBuV/m)	LIMIT (dBuV/m)	MARGIN (dB)	ANTENNA HEIGHT (m)	TABLE ANGLE (Degree)	RAW VALUE (dBuV)	CORRECTION FACTOR (dB/m)
1	*2480.00	94.4 PK			1.05 H	77	61.80	32.60
2	*2480.00	64.3 AV			1.05 H	77	31.70	32.60
3	2483.50	40.2 PK	74.0	-33.8	1.05 H	77	7.60	32.60
4	2483.50	10.1 AV	54.0	-43.9	1.05 H	77	-22.50	32.60
5	2486.00	42.5 PK	74.0	-31.5	1.05 H	77	9.90	32.60
6	2486.00	31.4 AV	54.0	-22.6	1.05 H	77	-1.20	32.60
7	4960.00	48.7 PK	74.0	-25.3	1.00 H	162	10.00	38.70
8	4960.00	18.6 AV	54.0	-35.4	1.00 H	162	-20.10	38.70

ANTENNA POLARITY & TEST DISTANCE: VERTICAL AT 3 M								
NO.	FREQ. (MHz)	EMISSION LEVEL (dBuV/m)	LIMIT (dBuV/m)	MARGIN (dB)	ANTENNA HEIGHT (m)	TABLE ANGLE (Degree)	RAW VALUE (dBuV)	CORRECTION FACTOR (dB/m)
1	*2480.00	90.1 PK			1.00 V	135	57.50	32.60
2	*2480.00	60.0 AV			1.00 V	135	27.40	32.60
3	2483.50	35.9 PK	74.0	-38.1	1.00 V	135	3.30	32.60
4	2483.50	5.8 AV	54.0	-48.2	1.00 V	135	-26.80	32.60
5	2486.00	40.6 PK	74.0	-33.4	1.00 V	135	8.00	32.60
6	2486.00	29.5 AV	54.0	-24.5	1.00 V	135	-3.10	32.60
7	4960.00	48.5 PK	74.0	-25.5	1.03 V	199	9.80	38.70
8	4960.00	18.4 AV	54.0	-35.6	1.03 V	199	-20.30	38.70

- REMARKS:**
1. Emission level (dBuV/m) = Raw Value (dBuV) + Correction Factor (dB/m).
 2. Correction Factor (dB/m) = Antenna Factor (dB/m) + Cable Factor (dB).
 3. The other emission levels were very low against the limit.
 4. Margin value = Emission level – Limit value.
 5. “ * “: Fundamental frequency.
 6. The DH5 packet was the worse case duty cycle for a transmit dwell time on a channel, based upon bluetooth theory the transmitter is on 0.625 * 5 per 296.25 ms per channel. Therefore, the duty cycle correlation factor be equal to: $20\log(3.125 / 100) = -30.1$ dB.
 7. Average value = peak reading + $20\log(\text{duty cycle})$.



8DPSK

EUT TEST CONDITION		MEASUREMENT DETAIL	
CHANNEL	Channel 0	FREQUENCY RANGE	1 ~ 25GHz
INPUT POWER (SYSTEM)	120Vac, 60 Hz	DETECTOR FUNCTION	Peak (PK) Average (AV)
ENVIRONMENTAL CONDITIONS	25deg. C, 70%RH 1006 hPa	TESTED BY	Lori Chiu

ANTENNA POLARITY & TEST DISTANCE: HORIZONTAL AT 3 M								
NO.	FREQ. (MHz)	EMISSION LEVEL (dBuV/m)	LIMIT (dBuV/m)	MARGIN (dB)	ANTENNA HEIGHT (m)	TABLE ANGLE (Degree)	RAW VALUE (dBuV)	CORRECTION FACTOR (dB/m)
1	2390.00	44.7 PK	74.0	-29.3	1.05 H	166	12.40	32.30
2	2390.00	31.9 AV	54.0	-22.1	1.05 H	166	-0.40	32.30
3	2397.50	49.0 PK	74.0	-25.0	1.05 H	166	16.70	32.30
4	2397.50	39.1 AV	54.0	-14.9	1.05 H	166	6.80	32.30
5	2400.00	43.9 PK	74.0	-30.1	1.05 H	166	11.60	32.30
6	2400.00	13.8 AV	54.0	-40.2	1.05 H	166	-18.50	32.30
7	*2402.00	96.2 PK			1.05 H	166	63.90	32.30
8	*2402.00	66.1 AV			1.05 H	166	33.80	32.30
9	4804.00	48.3 PK	74.0	-25.7	1.16 H	71	10.00	38.30
10	4804.00	18.2 AV	54.0	-35.8	1.16 H	71	-20.10	38.30

- REMARKS:**
1. Emission level (dBuV/m) = Raw Value (dBuV) + Correction Factor (dB/m).
 2. Correction Factor (dB/m) = Antenna Factor (dB/m) + Cable Factor (dB).
 3. The other emission levels were very low against the limit.
 4. Margin value = Emission level – Limit value.
 5. “ * “: Fundamental frequency.
 6. The DH5 packet was the worse case duty cycle for a transmit dwell time on a channel, based upon bluetooth theory the transmitter is on 0.625 * 5 per 296.25 ms per channel. Therefore, the duty cycle correlation factor be equal to: $20\log(3.125 / 100) = -30.1$ dB.
 7. Average value = peak reading + $20\log(\text{duty cycle})$.



A D T

EUT TEST CONDITION		MEASUREMENT DETAIL	
CHANNEL	Channel 0	FREQUENCY RANGE	1 ~ 25GHz
INPUT POWER (SYSTEM)	120Vac, 60 Hz	DETECTOR FUNCTION	Peak (PK) Average (AV)
ENVIRONMENTAL CONDITIONS	25deg. C, 70%RH 1006 hPa	TESTED BY	Lori Chiu

ANTENNA POLARITY & TEST DISTANCE: VERTICAL AT 3 M								
NO.	FREQ. (MHz)	EMISSION LEVEL (dBuV/m)	LIMIT (dBuV/m)	MARGIN (dB)	ANTENNA HEIGHT (m)	TABLE ANGLE (Degree)	RAW VALUE (dBuV)	CORRECTION FACTOR (dB/m)
1	2390.00	44.0 PK	74.0	-30.0	1.02 V	115	11.70	32.30
2	2390.00	31.1 AV	54.0	-22.9	1.02 V	115	-1.20	32.30
3	2397.50	45.6 PK	74.0	-28.4	1.02 V	115	13.30	32.30
4	2397.50	36.1 AV	54.0	-17.9	1.02 V	115	3.80	32.30
5	2400.00	39.3 PK	74.0	-34.7	1.02 V	115	7.00	32.30
6	2400.00	9.2 AV	54.0	-44.8	1.02 V	115	-23.10	32.30
7	*2402.00	91.6 PK			1.02 V	115	59.30	32.30
8	*2402.00	61.4 AV			1.02 V	115	29.10	32.30
9	4804.00	49.3 PK	74.0	-24.7	1.18 V	23	11.00	38.30
10	4804.00	19.2 AV	54.0	-34.8	1.18 V	23	-19.10	38.30

- REMARKS:**
1. Emission level (dBuV/m) = Raw Value (dBuV) + Correction Factor (dB/m).
 2. Correction Factor (dB/m) = Antenna Factor (dB/m) + Cable Factor (dB).
 3. The other emission levels were very low against the limit.
 4. Margin value = Emission level – Limit value.
 5. “ * “: Fundamental frequency.
 6. The DH5 packet was the worse case duty cycle for a transmit dwell time on a channel, based upon bluetooth theory the transmitter is on 0.625 * 5 per 296.25 ms per channel. Therefore, the duty cycle correlation factor be equal to: $20\log(3.125 / 100) = -30.1$ dB.
 7. Average value = peak reading + $20\log(\text{duty cycle})$.



A D T

EUT TEST CONDITION		MEASUREMENT DETAIL	
CHANNEL	Channel 39	FREQUENCY RANGE	1 ~ 25GHz
INPUT POWER (SYSTEM)	120Vac, 60 Hz	DETECTOR FUNCTION	Peak (PK) Average (AV)
ENVIRONMENTAL CONDITIONS	25deg. C, 70%RH 1006 hPa	TESTED BY	Lori Chiu

ANTENNA POLARITY & TEST DISTANCE: HORIZONTAL AT 3 M								
NO.	FREQ. (MHz)	EMISSION LEVEL (dBuV/m)	LIMIT (dBuV/m)	MARGIN (dB)	ANTENNA HEIGHT (m)	TABLE ANGLE (Degree)	RAW VALUE (dBuV)	CORRECTION FACTOR (dB/m)
1	*2441.00	95.9 PK			1.01 H	168	63.40	32.50
2	*2441.00	65.8 AV			1.01 H	168	33.30	32.50
3	4882.00	48.4 PK	74.0	-25.6	1.00 H	97	9.90	38.50
4	4882.00	18.3 AV	54.0	-35.7	1.00 H	97	-20.20	38.50
ANTENNA POLARITY & TEST DISTANCE: VERTICAL AT 3 M								
NO.	FREQ. (MHz)	EMISSION LEVEL (dBuV/m)	LIMIT (dBuV/m)	MARGIN (dB)	ANTENNA HEIGHT (m)	TABLE ANGLE (Degree)	RAW VALUE (dBuV)	CORRECTION FACTOR (dB/m)
1	*2441.00	91.2 PK			1.09 V	218	58.70	32.50
2	*2441.00	61.1 AV			1.09 V	218	28.60	32.50
3	4882.00	49.5 PK	74.0	-24.5	1.06 V	42	11.00	38.50
4	4882.00	19.4 AV	54.0	-34.6	1.06 V	42	-19.10	38.50

- REMARKS:**
- Emission level (dBuV/m) = Raw Value (dBuV) + Correction Factor (dB/m).
 - Correction Factor (dB/m) = Antenna Factor (dB/m) + Cable Factor (dB).
 - The other emission levels were very low against the limit.
 - Margin value = Emission level – Limit value.
 - * *: Fundamental frequency.
 - The DH5 packet was the worse case duty cycle for a transmit dwell time on a channel, based upon bluetooth theory the transmitter is on 0.625 * 5 per 296.25 ms per channel. Therefore, the duty cycle correlation factor be equal to: $20\log(3.125 / 100) = -30.1$ dB.
 - Average value = peak reading + $20\log(\text{duty cycle})$.



A D T

EUT TEST CONDITION		MEASUREMENT DETAIL	
CHANNEL	Channel 78	FREQUENCY RANGE	1 ~ 25GHz
INPUT POWER (SYSTEM)	120Vac, 60 Hz	DETECTOR FUNCTION	Peak (PK) Average (AV)
ENVIRONMENTAL CONDITIONS	25deg. C, 70%RH 1006 hPa	TESTED BY	Lori Chiu

ANTENNA POLARITY & TEST DISTANCE: HORIZONTAL AT 3 M								
NO.	FREQ. (MHz)	EMISSION LEVEL (dBuV/m)	LIMIT (dBuV/m)	MARGIN (dB)	ANTENNA HEIGHT (m)	TABLE ANGLE (Degree)	RAW VALUE (dBuV)	CORRECTION FACTOR (dB/m)
1	*2480.00	94.6 PK			1.07 H	211	62.00	32.60
2	*2480.00	64.5 AV			1.07 H	211	31.90	32.60
3	2483.50	41.0 PK	74.0	-33.0	1.07 H	211	8.40	32.60
4	2483.50	10.9 AV	54.0	-43.1	1.07 H	211	-21.70	32.60
5	2486.00	42.8 PK	74.0	-31.2	1.07 H	211	10.20	32.60
6	2486.00	31.6 AV	54.0	-22.4	1.07 H	211	-1.00	32.60
7	4960.00	49.2 PK	74.0	-24.8	1.07 H	219	10.50	38.70
8	4960.00	19.1 AV	54.0	-34.9	1.07 H	219	-19.60	38.70

ANTENNA POLARITY & TEST DISTANCE: VERTICAL AT 3 M								
NO.	FREQ. (MHz)	EMISSION LEVEL (dBuV/m)	LIMIT (dBuV/m)	MARGIN (dB)	ANTENNA HEIGHT (m)	TABLE ANGLE (Degree)	RAW VALUE (dBuV)	CORRECTION FACTOR (dB/m)
1	*2480.00	90.3 PK			1.13 V	95	57.70	32.60
2	*2480.00	60.2 AV			1.13 V	95	27.60	32.60
3	2483.50	36.7 PK	74.0	-37.3	1.13 V	95	4.10	32.60
4	2483.50	6.6 AV	54.0	-47.4	1.13 V	95	-26.00	32.60
5	2486.00	40.8 PK	74.0	-33.2	1.13 V	95	8.20	32.60
6	2486.00	29.7 AV	54.0	-24.3	1.13 V	95	-2.90	32.60
7	4960.00	49.7 PK	74.0	-24.3	1.12 V	109	11.00	38.70
8	4960.00	19.6 AV	54.0	-34.4	1.12 V	109	-19.10	38.70

- REMARKS:**
- Emission level (dBuV/m) = Raw Value (dBuV) + Correction Factor (dB/m).
 - Correction Factor (dB/m) = Antenna Factor (dB/m) + Cable Factor (dB).
 - The other emission levels were very low against the limit.
 - Margin value = Emission level – Limit value.
 - * * *: Fundamental frequency.
 - The DH5 packet was the worse case duty cycle for a transmit dwell time on a channel, based upon bluetooth theory the transmitter is on 0.625 * 5 per 296.25 ms per channel. Therefore, the duty cycle correlation factor be equal to: $20\log(3.125 / 100) = -30.1$ dB.
 - Average value = peak reading + $20\log(\text{duty cycle})$.

BELOW 1GHz WORST-CASE DATA : 8DPSK

EUT TEST CONDITION		MEASUREMENT DETAIL	
CHANNEL	Channel 0	FREQUENCY RANGE	Below 1000MHz
INPUT POWER (SYSTEM)	120Vac, 60 Hz	DETECTOR FUNCTION	Quasi-Peak
ENVIRONMENTAL CONDITIONS	25deg. C, 70%RH 1006 hPa	TESTED BY	Lori Chiu

ANTENNA POLARITY & TEST DISTANCE: HORIZONTAL AT 3 M								
NO.	FREQ. (MHz)	EMISSION LEVEL (dBuV/m)	LIMIT (dBuV/m)	MARGIN (dB)	ANTENNA HEIGHT (m)	TABLE ANGLE (Degree)	RAW VALUE (dBuV)	CORRECTION FACTOR (dB/m)
1	45.45	27.9 QP	40.0	-12.1	2.00 H	10	15.30	12.60
2	127.11	31.6 QP	43.5	-11.9	2.00 H	130	19.50	12.10
3	150.45	31.9 QP	43.5	-11.6	1.00 H	118	18.00	13.90
4	201.00	36.3 QP	43.5	-7.2	1.00 H	112	25.60	10.70
5	309.88	37.6 QP	46.0	-8.4	1.00 H	148	23.60	14.00
6	949.55	34.3 QP	46.0	-11.7	2.00 H	265	7.80	26.50
ANTENNA POLARITY & TEST DISTANCE: VERTICAL AT 3 M								
NO.	FREQ. (MHz)	EMISSION LEVEL (dBuV/m)	LIMIT (dBuV/m)	MARGIN (dB)	ANTENNA HEIGHT (m)	TABLE ANGLE (Degree)	RAW VALUE (dBuV)	CORRECTION FACTOR (dB/m)
1	66.84	33.1 QP	40.0	-6.9	1.00 V	283	20.90	12.20
2	113.50	31.1 QP	43.5	-12.4	2.00 V	10	20.10	11.00
3	201.00	33.3 QP	43.5	-10.2	1.00 V	70	22.60	10.70
4	465.42	31.2 QP	46.0	-14.8	1.00 V	181	13.00	18.20
5	862.06	33.6 QP	46.0	-12.4	2.00 V	166	7.80	25.80
6	920.38	31.7 QP	46.0	-14.3	1.00 V	85	5.40	26.30

- REMARKS:**
1. Emission level (dBuV/m) = Raw Value (dBuV) + Correction Factor (dB/m).
 2. Correction Factor (dB/m) = Antenna Factor (dB/m) + Cable Factor (dB).
 3. The other emission levels were very low against the limit.
 4. Margin value = Emission level – Limit value.

4.2 CONDUCTED EMISSION MEASUREMENT

4.2.1 LIMITS OF CONDUCTED EMISSION MEASUREMENT

FREQUENCY OF EMISSION (MHz)	CONDUCTED LIMIT (dB μ V)	
	Quasi-peak	Average
0.15 ~ 0.5	66 to 56	56 to 46
0.5 ~ 5	56	46
5 ~ 30	60	50

- NOTE:**
1. The lower limit shall apply at the transition frequencies.
 2. The limit decreases in line with the logarithm of the frequency in the range of 0.15 to 0.50 MHz.
 3. All emanations from a class A/B digital device or system, including any network of conductors and apparatus connected thereto, shall not exceed the level of field strengths specified above.

4.2.2 TEST INSTRUMENTS

DESCRIPTION & MANUFACTURER	MODEL NO.	SERIAL NO.	DATE OF CALIBRATION	DUE DATE OF CALIBRATION
Test Receiver ROHDE & SCHWARZ	ESCS30	100288	Sep. 24, 2009	Sep. 23, 2010
RF signal cable Woken	5D-FB	Cable-HYCO2-01	Dec. 31, 2008	Dec. 30, 2009
LISN ROHDE & SCHWARZ	ESH2-Z5	100100	Dec. 29, 2008	Dec. 28, 2009
LISN ROHDE & SCHWARZ	ESH3-Z5	100311	Jul. 29, 2009	Jul. 28, 2010
Software ADT	ADT_Cond_ V7.3.7	NA	NA	NA

- NOTE:**
1. The calibration interval of the above test instruments is 12 months and the calibrations are traceable to NML/ROC and NIST/USA.
 2. The test was performed in HwaYa Shielded Room 2.
 3. The VCCI Site Registration No. is C-2047.

4.2.3 TEST PROCEDURES

- a. The EUT was placed 0.4 meters from the conducting wall of the shielded room with EUT being connected to the power mains through a line impedance stabilization network (LISN). Other support units were connected to the power mains through another LISN. The two LISNs provide 50 ohm/ 50uH of coupling impedance for the measuring instrument.
- b. Both lines of the power mains connected to the EUT were checked for maximum conducted interference.
- c. The frequency range from 150kHz to 30MHz was searched. Emission levels under (Limit - 20dB) was not recorded.

NOTE: All modes of operation were investigated and the worst-case emissions are reported.

4.2.4 DEVIATION FROM TEST STANDARD

No deviation

4.2.5 TEST SETUP

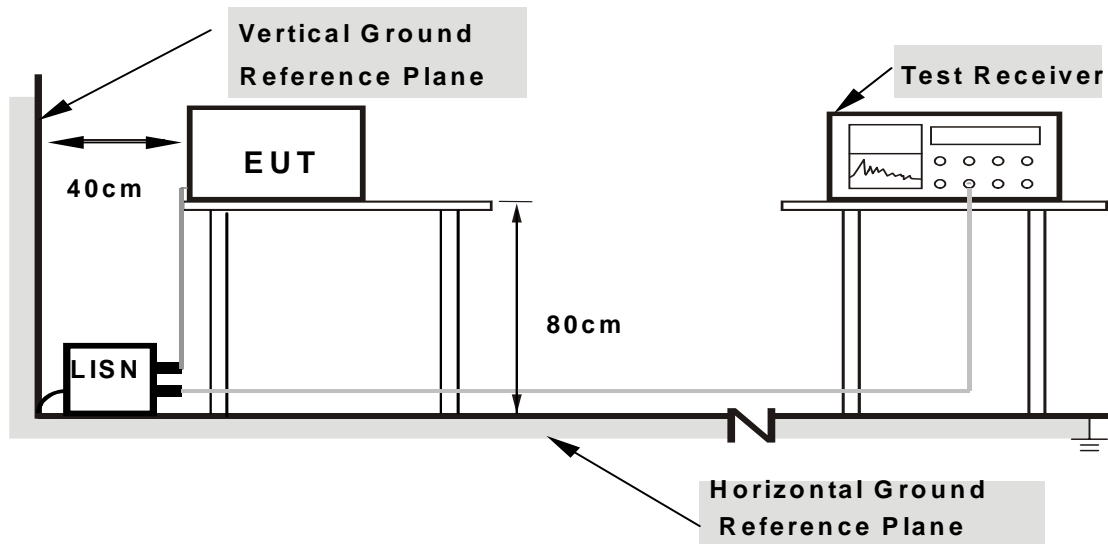

- Note:**
1. Support units were connected to second LISN.
 2. Both of LISNs (AMN) are 80 cm from EUT and at least 80 from other units and other metal planes

For the actual test configuration, please refer to the attached file (Test Setup Photo).

4.2.6 EUT OPERATING CONDITIONS

Same as 4.1.6.

4.2.7 TEST RESULTS

CONDUCTED WORST CASE DATA: 8DPSK

CHANNEL	Channel 0	PHASE	Line 1
----------------	-----------	--------------	--------

No	Freq. [MHz]	Corr. Factor (dB)	Reading Value		Emission Level		Limit		Margin	
			[dB (uV)]		[dB (uV)]		[dB (uV)]		(dB)	
			Q.P.	AV.	Q.P.	AV.	Q.P.	AV.	Q.P.	AV.
1	0.154	0.16	50.18	-	50.34	-	65.79	55.79	-15.45	-
2	0.185	0.16	44.18	-	44.34	-	64.25	54.25	-19.92	-
3	0.214	0.16	41.42	-	41.58	-	63.06	53.06	-21.48	-
4	0.487	0.19	32.48	-	32.67	-	56.21	46.21	-23.55	-
5	1.250	0.25	24.95	-	25.20	-	56.00	46.00	-30.80	-
6	15.738	0.53	36.05	-	36.58	-	60.00	50.00	-23.42	-

- REMARKS:**
1. Q.P. and AV. are abbreviations of quasi-peak and average individually.
 2. "-": The Quasi-peak reading value also meets average limit and measurement with the average detector is unnecessary.
 3. The emission levels of other frequencies were very low against the limit.
 4. Margin value = Emission level - Limit value
 5. Correction factor = Insertion loss + Cable loss
 6. Emission Level = Correction Factor + Reading Value.

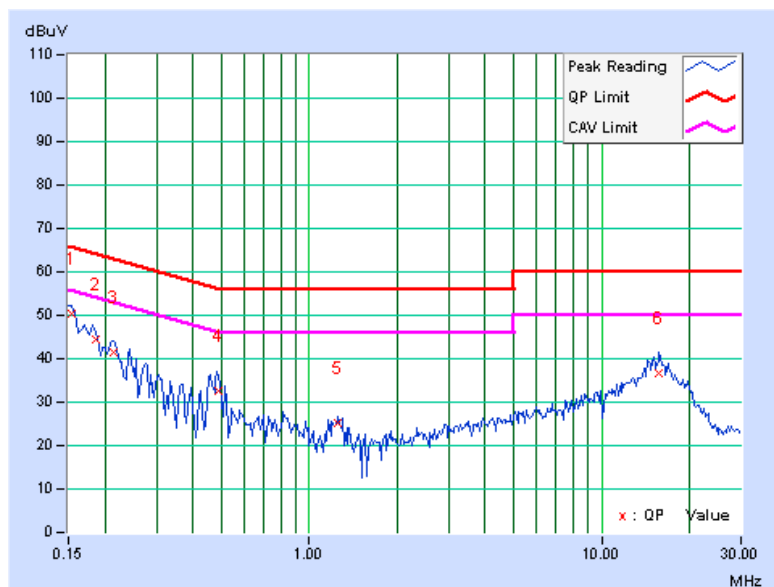

CHANNEL	Channel 0	PHASE	Line 2
----------------	-----------	--------------	--------

No	Freq. [MHz]	Corr. Factor (dB)	Reading Value [dB (uV)]		Emission Level [dB (uV)]		Limit [dB (uV)]		Margin (dB)	
			Q.P.	AV.	Q.P.	AV.	Q.P.	AV.	Q.P.	AV.
1	0.154	0.13	50.32	-	50.45	-	65.79	55.79	-15.34	-
2	0.181	0.13	44.36	-	44.49	-	64.43	54.43	-19.94	-
3	0.427	0.16	34.76	-	34.92	-	57.30	47.30	-22.38	-
4	0.490	0.17	35.58	-	35.75	-	56.17	46.17	-20.42	-
5	1.408	0.25	24.42	-	24.67	-	56.00	46.00	-31.33	-
6	15.246	0.67	35.20	-	35.87	-	60.00	50.00	-24.13	-

- REMARKS:**
1. Q.P. and AV. are abbreviations of quasi-peak and average individually.
 2. "-": The Quasi-peak reading value also meets average limit and measurement with the average detector is unnecessary.
 3. The emission levels of other frequencies were very low against the limit.
 4. Margin value = Emission level - Limit value
 5. Correction factor = Insertion loss + Cable loss
 6. Emission Level = Correction Factor + Reading Value.

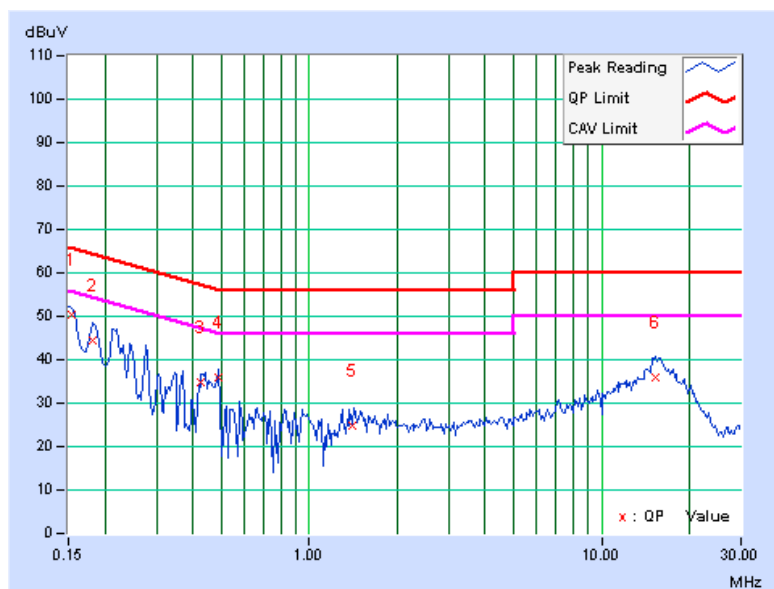

4.3 NUMBER OF HOPPING FREQUENCY USED

4.3.1 LIMIT OF HOPPING FREQUENCY USED

At least 15 channels frequencies, and should be equally spaced.

4.3.2 TEST INSTRUMENTS

DESCRIPTION & MANUFACTURER	MODEL NO.	SERIAL NO.	DATE OF CALIBRATION	DUE DATE OF CALIBRATION
SPECTRUM ANALYZER R&S	FSP40	100040	Jul. 07, 2009	Jul. 06, 2010

NOTE: The calibration interval of the above test instruments is 12 months and the calibrations are traceable to NML/ROC and NIST/USA.

4.3.3 TEST PROCEDURES

- a. Check the calibration of the measuring instrument (SA) using either an internal calibrator or a known signal from an external generator.
- b. Turn on the EUT and connect its antenna terminal to measurement via a low loss cable. Then set it to any one measured frequency within its operating range and make sure the instrument is operated in its linear range.
- c. Set the SA on MaxHold Mode, and then keep the EUT in hopping mode. Record all the signals from each channel until each one has been recorded.
- d. Set the SA on View mode and then plot the result on SA screen.
- e. Repeat above procedures until all frequencies measured were complete.

4.3.4 DEVIATION FROM TEST STANDARD

No deviation.

4.3.5 TEST SETUP

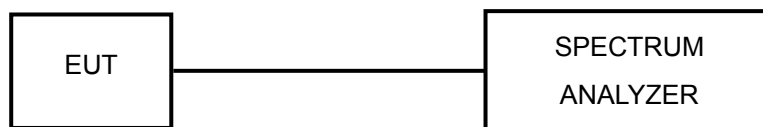

4.3.6 TEST RESULTS

There are 79 hopping frequencies in the hopping mode. Please refer to next two pages for the test result. On the plots, it shows that the hopping frequencies are equally spaced.



A D T

GFSK

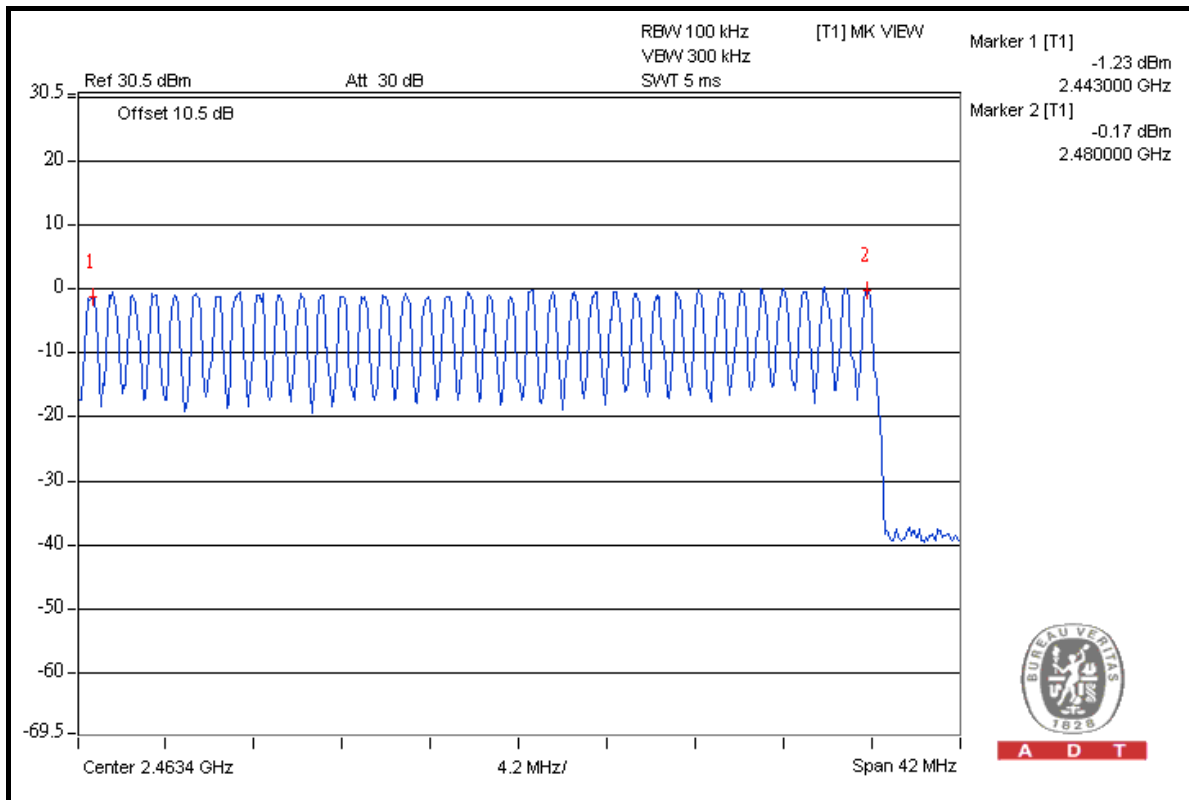
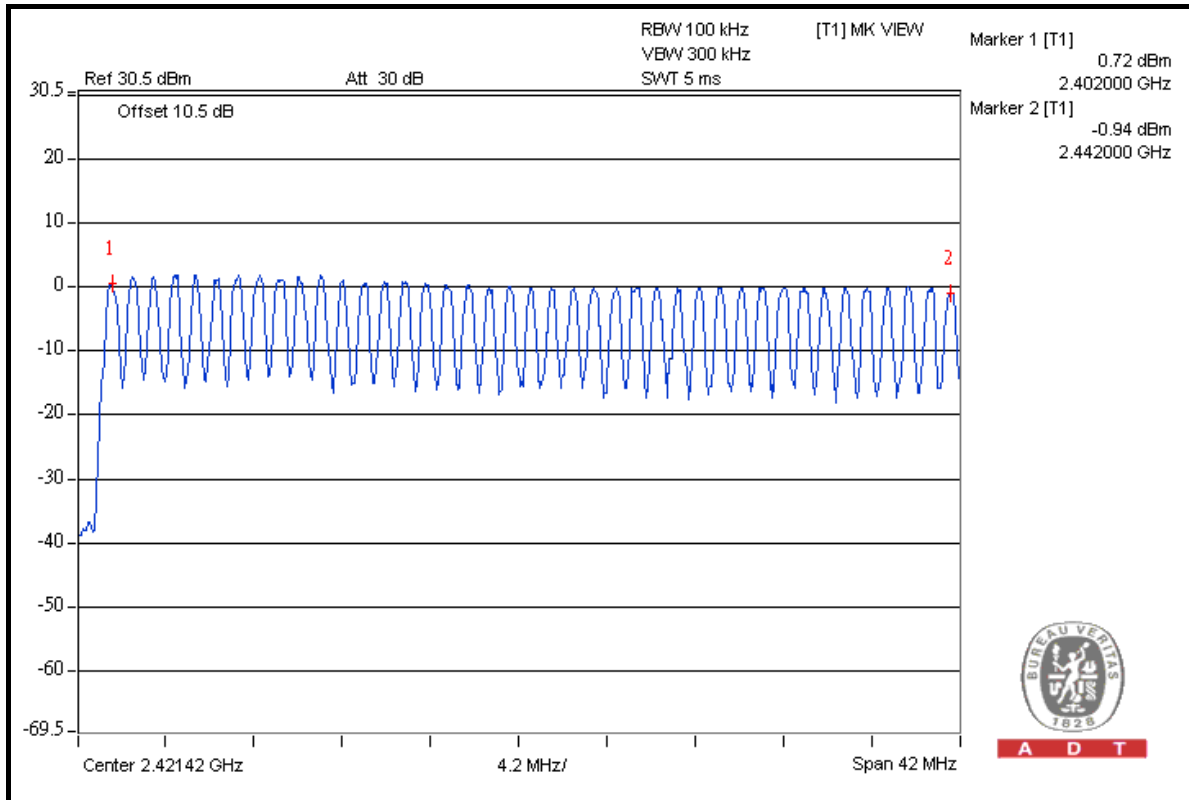



A D T

8DPSK

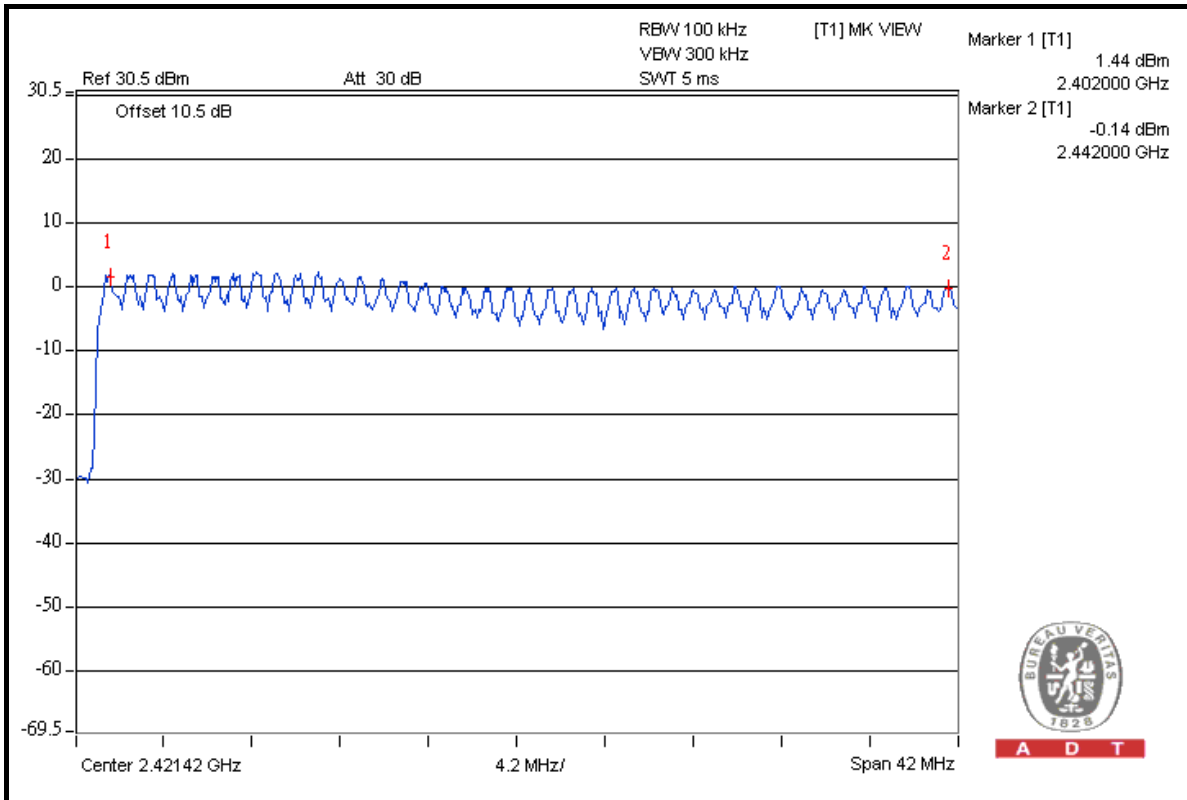

A D T

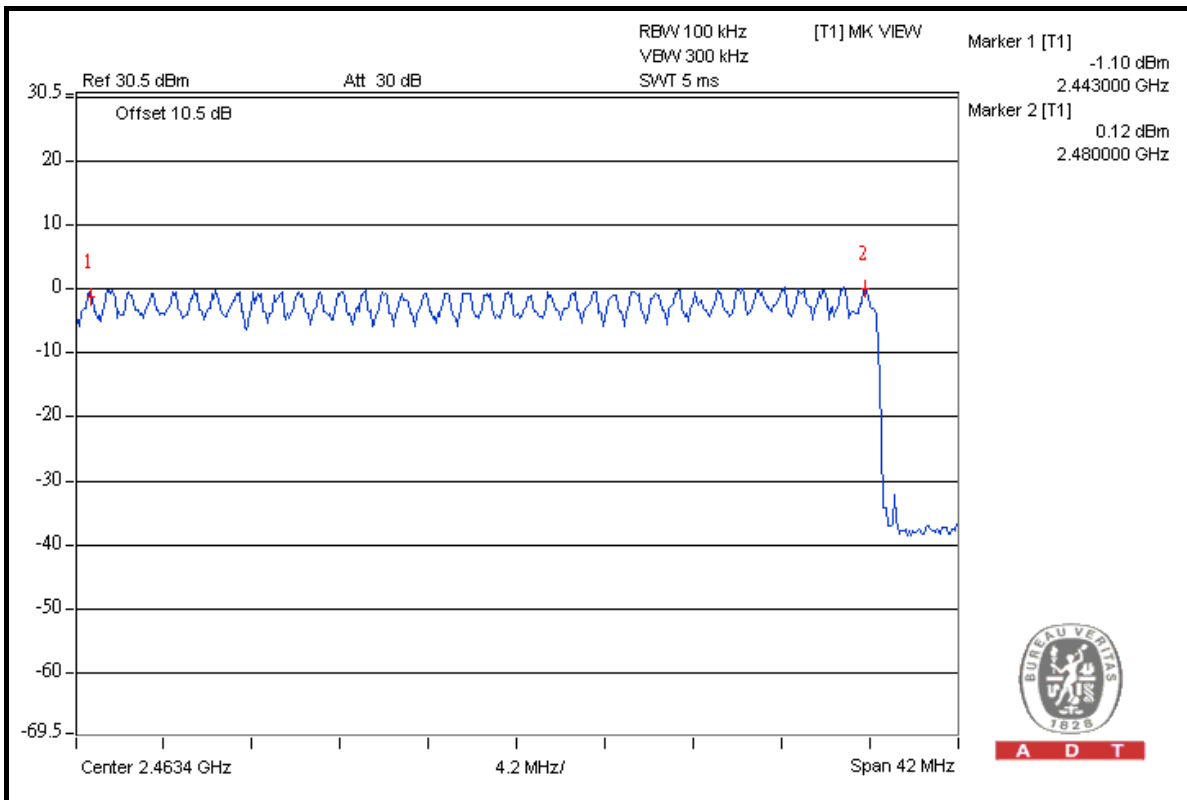

A D T



4.4 DWELL TIME ON EACH CHANNEL

4.4.1 LIMIT OF DWELL TIME USED

The average time of occupancy on any channel shall not be greater than 0.4 seconds within a period of 0.4 seconds multiplied by the number of hopping channels employed.

4.4.2 TEST INSTRUMENTS

DESCRIPTION & MANUFACTURER	MODEL NO.	SERIAL NO.	DATE OF CALIBRATION	DUE DATE OF CALIBRATION
SPECTRUM ANALYZER R&S	FSP40	100040	Jul. 07, 2009	Jul. 06, 2010

NOTE: The calibration interval of the above test instruments is 12 months and the calibrations are traceable to NML/ROC and NIST/USA.

4.4.3 TEST PROCEDURES

- a. Check the calibration of the measuring instrument (SA) using either an internal calibrator or a known signal from an external generator.
- b. Turn on the EUT and connect its antenna terminal to measurement via a low loss cable. Then set it to any one measured frequency within its operating range and make sure the instrument is operated in its linear range.
- c. Adjust the center frequency of SA on any frequency be measured and set SA to zero span mode. And then, set RBW and VBW of spectrum analyzer to proper value.
- d. Measure the time duration of one transmission on the measured frequency. And then plot the result with time difference of this time duration.
- e. Repeat above procedures until all different time-slot modes have been completed.

4.4.4 DEVIATION FROM TEST STANDARD

No deviation.

4.4.5 TEST SETUP

Same as 4.3.5.

4.4.6 TEST RESULTS

GFSK

Mode	Number of transmission in a 31.6 (79Hopping*0.4)	Length of transmission time (msec)	Result (msec)	Limit (msec)
DH1	50 (times / 5 sec) * 6.32 = 316.00 times	0.522	164.952	400
DH3	27 (times / 5 sec) * 6.32 = 170.64 times	1.788	305.104	400
DH5	18 (times / 5 sec) * 6.32 = 113.76 times	3.040	345.830	400

NOTE: Test plots of the transmitting time slot are shown on next 3 pages.



A D T

DH1

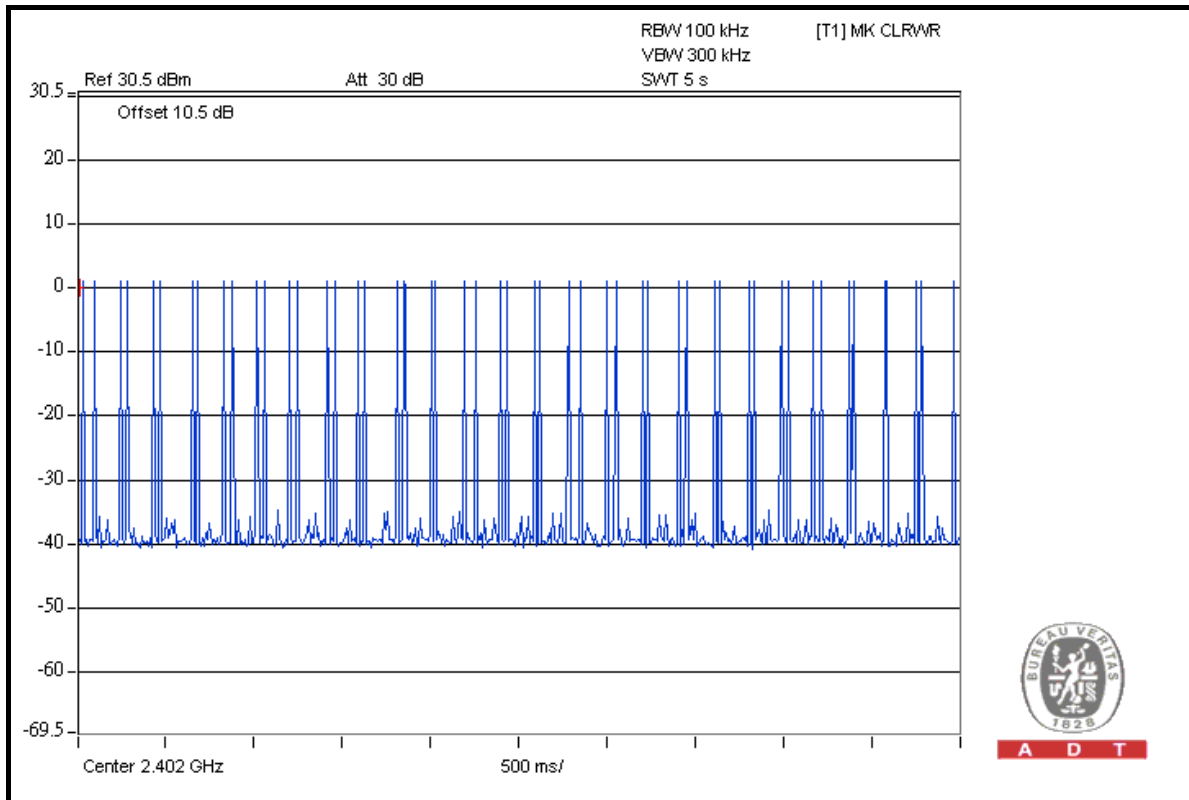

A D T

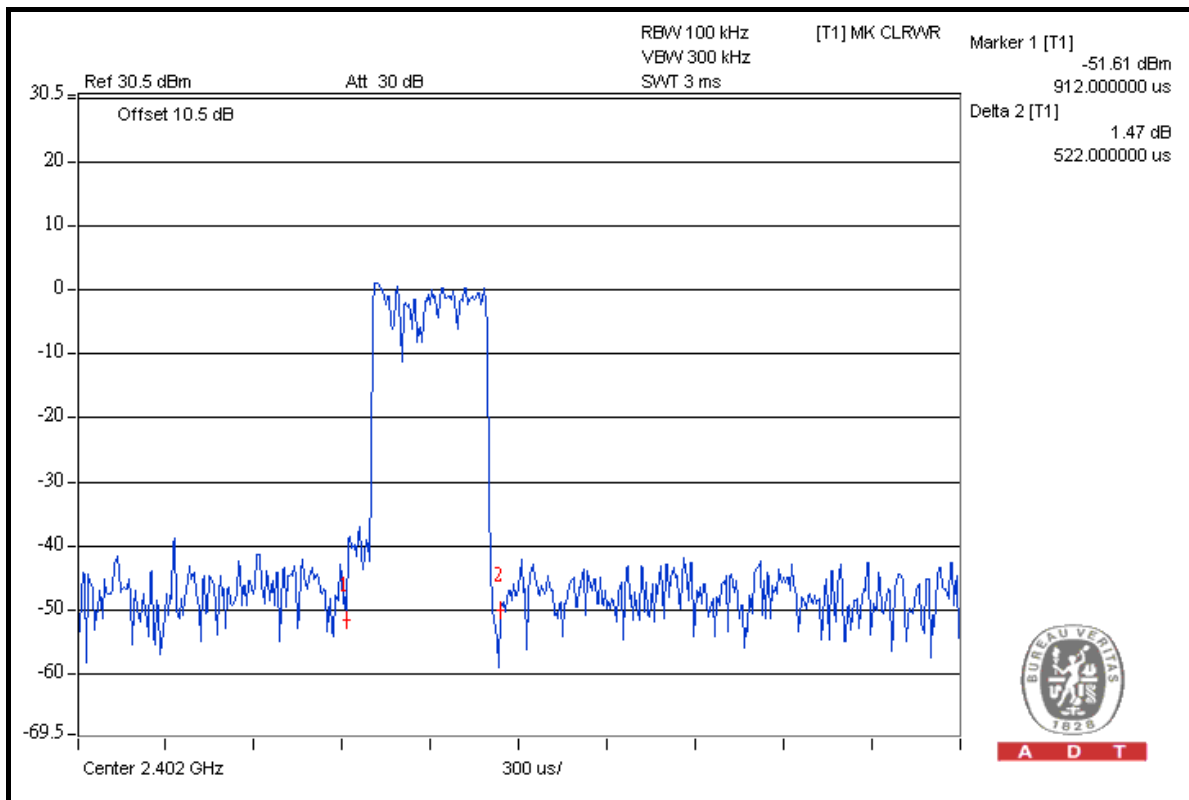

A D T



A D T

DH3

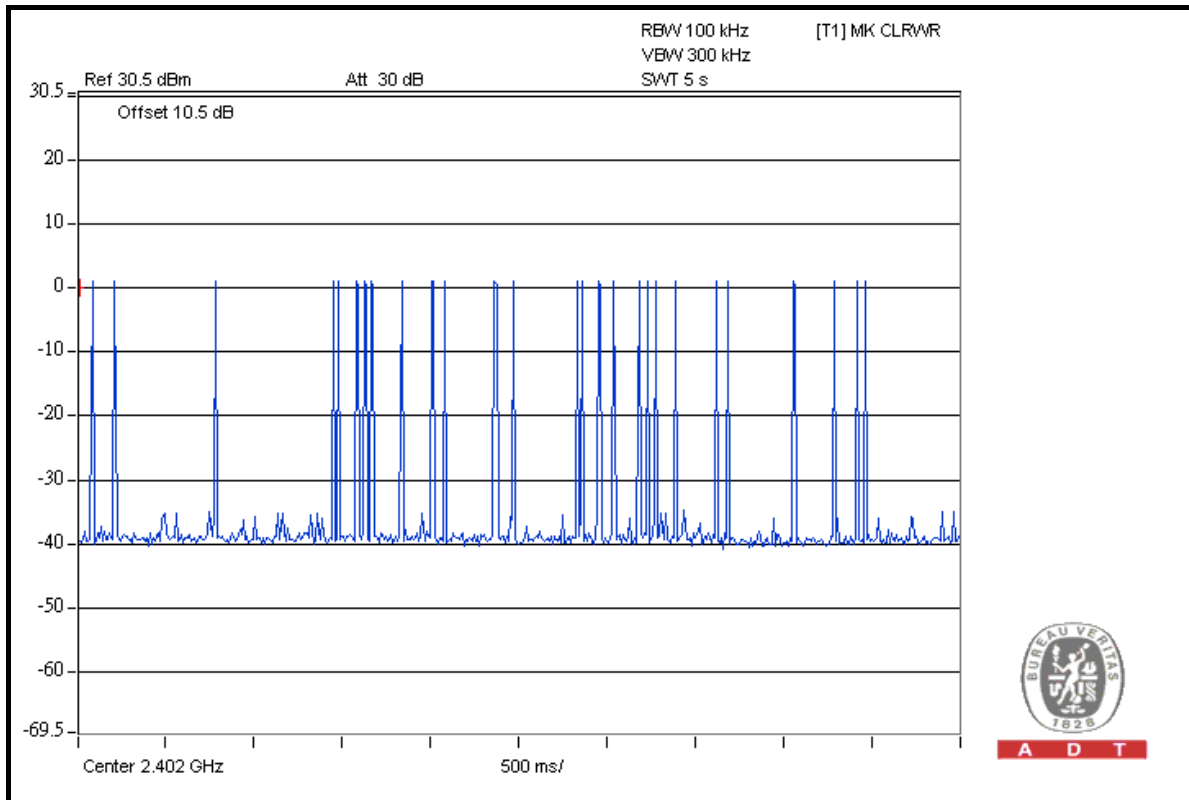

A D T

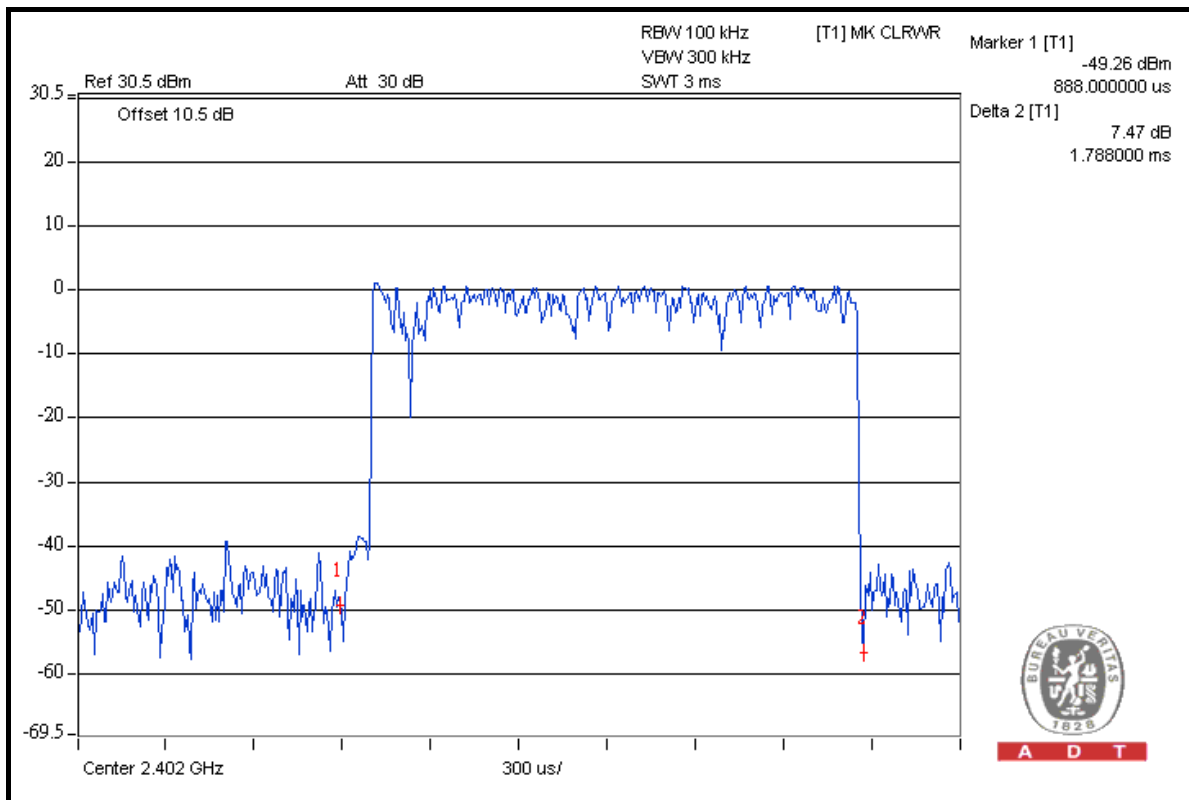

A D T



A D T

DH5

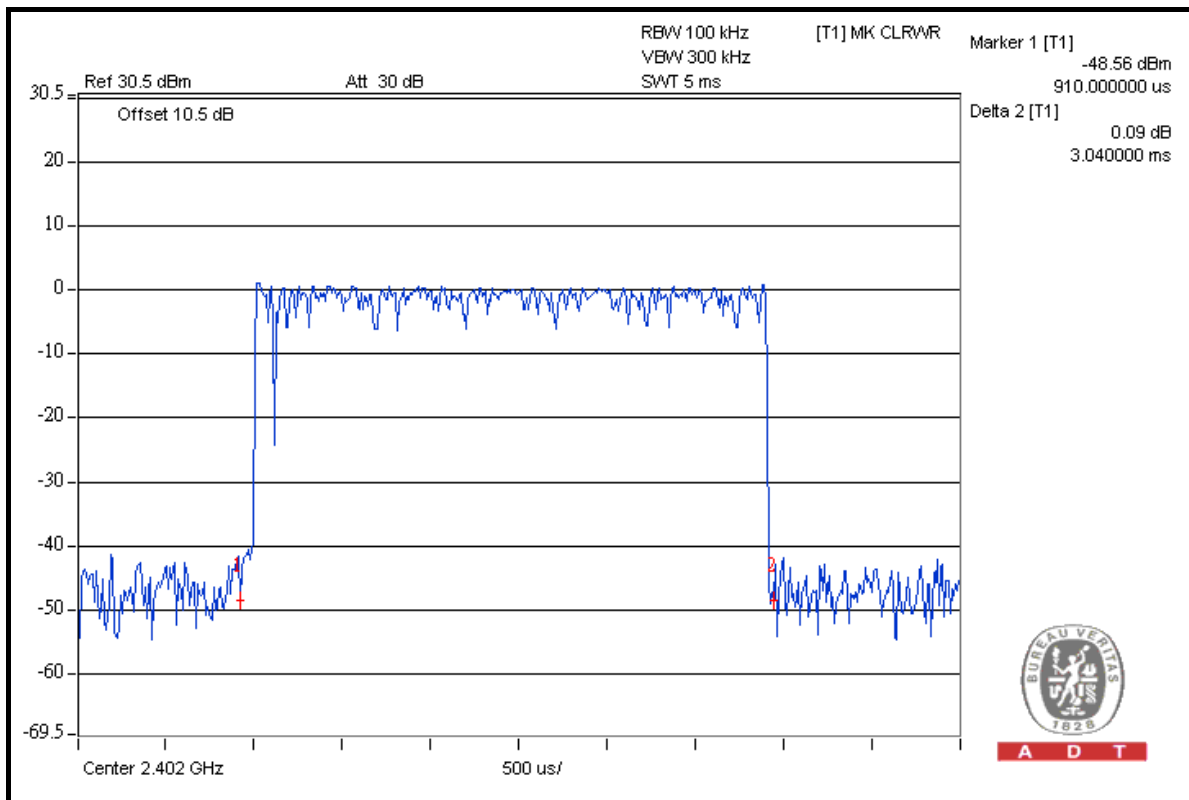
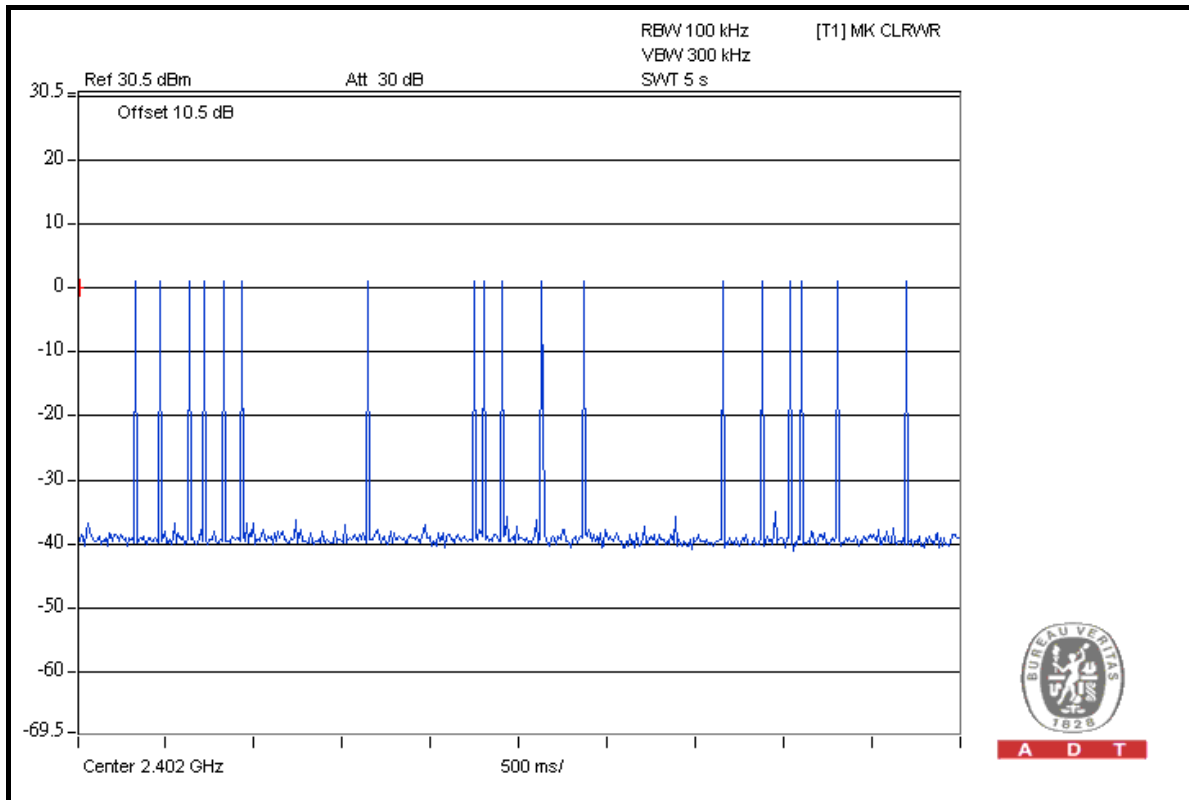

8DPSK

Mode	Number of transmission in a 31.6 (79Hopping*0.4)	Length of transmission time (msec)	Result (msec)	Limit (msec)
DH1	51 (times / 5 sec) * 6.32 = 322.32 times	0.510	164.383	400
DH3	26 (times / 5 sec) * 6.32 = 164.32 times	1.776	291.832	400
DH5	16 (times / 5 sec) * 6.32 = 101.12 times	3.060	309.427	400

NOTE: Test plots of the transmitting time slot are shown on next 3 pages.



A D T

DH1

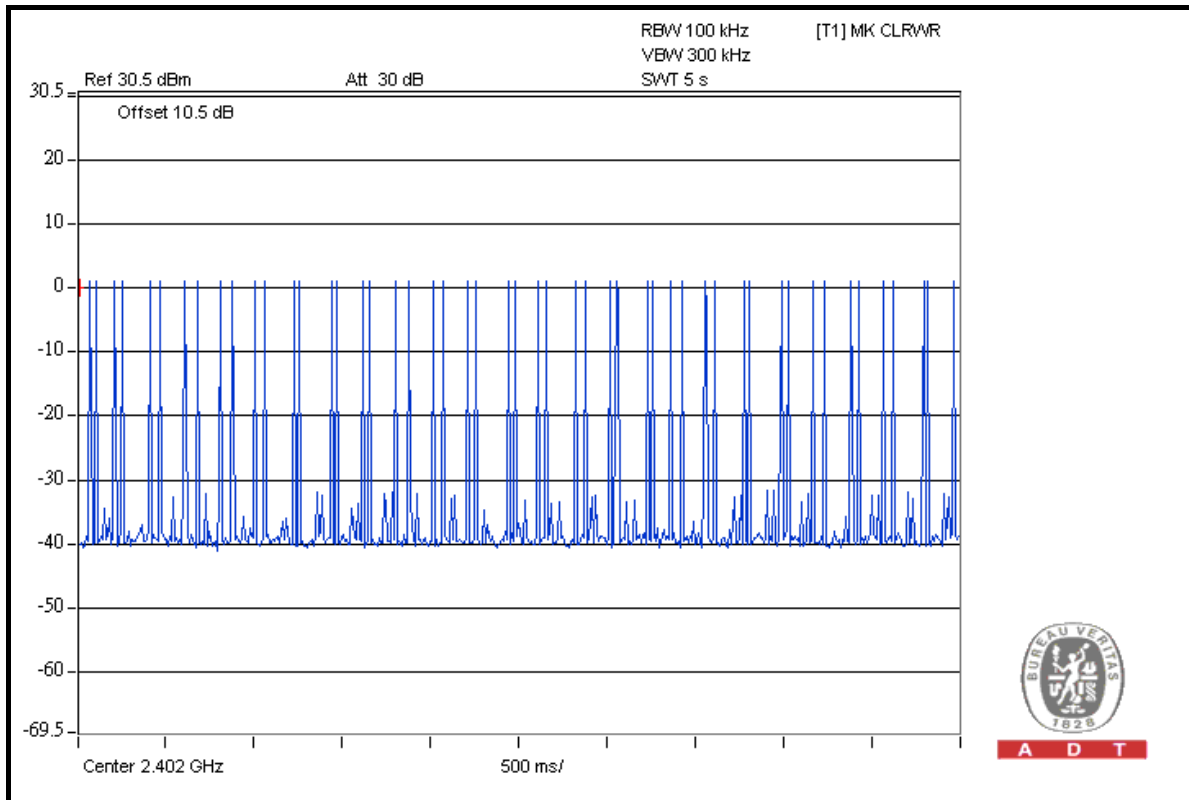

A D T

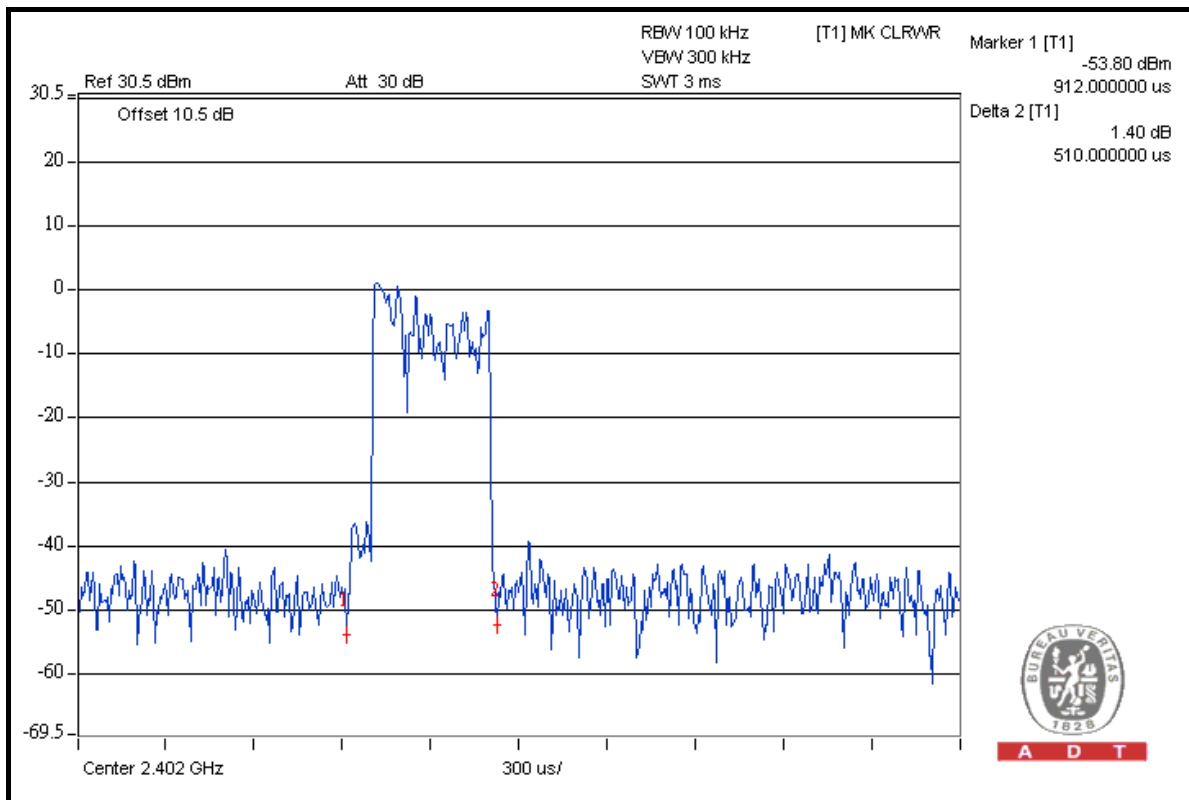

A D T



A D T

DH3

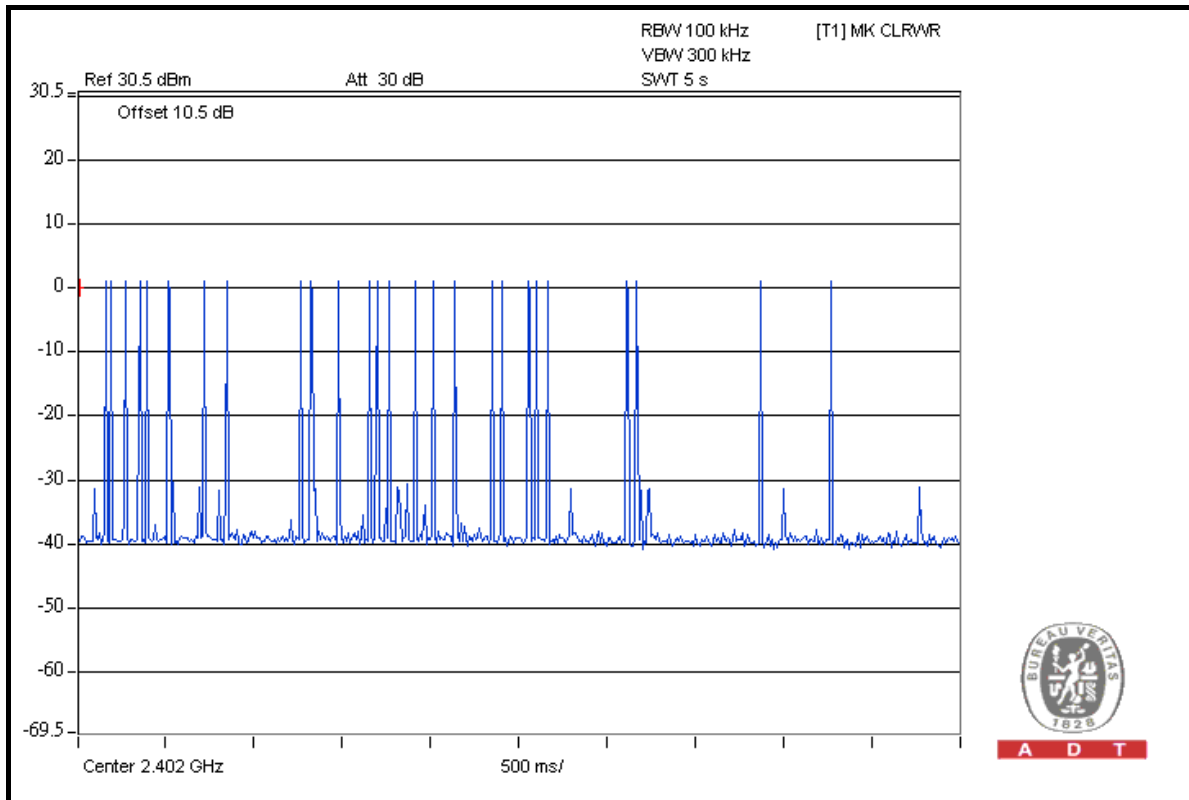

A D T

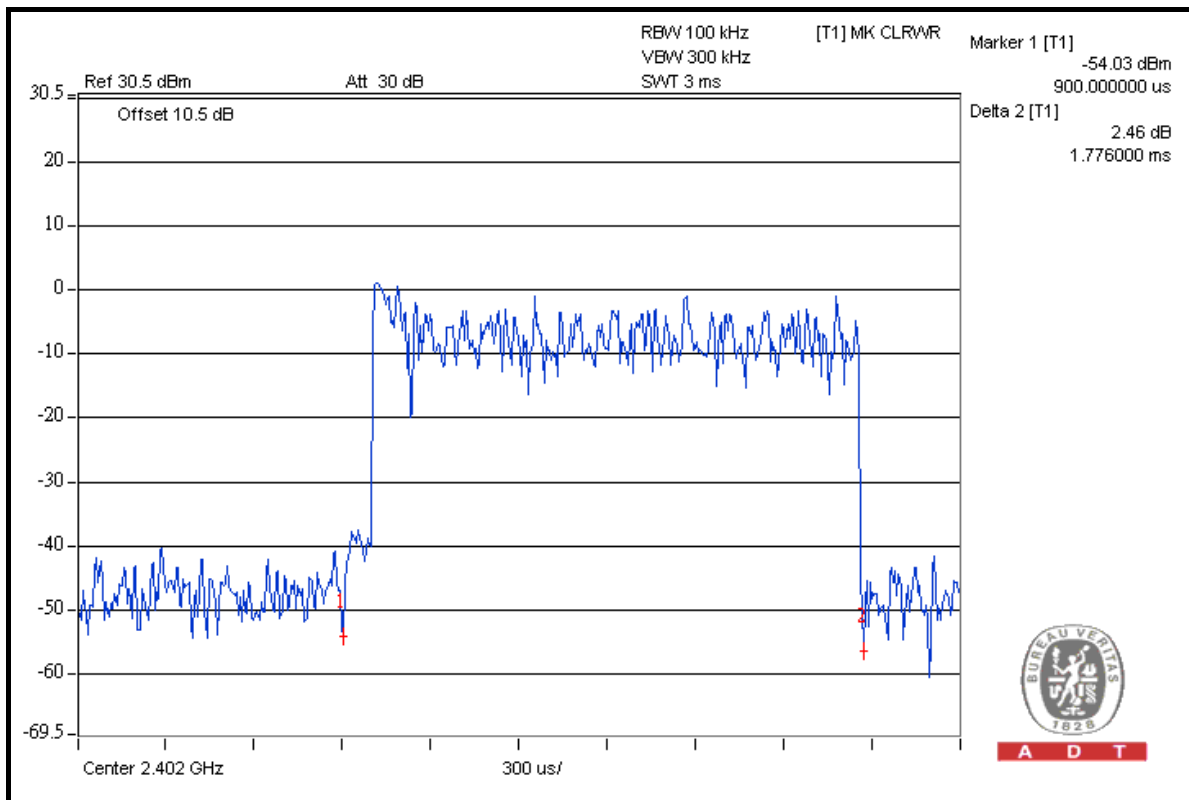

A D T



A D T

DH5

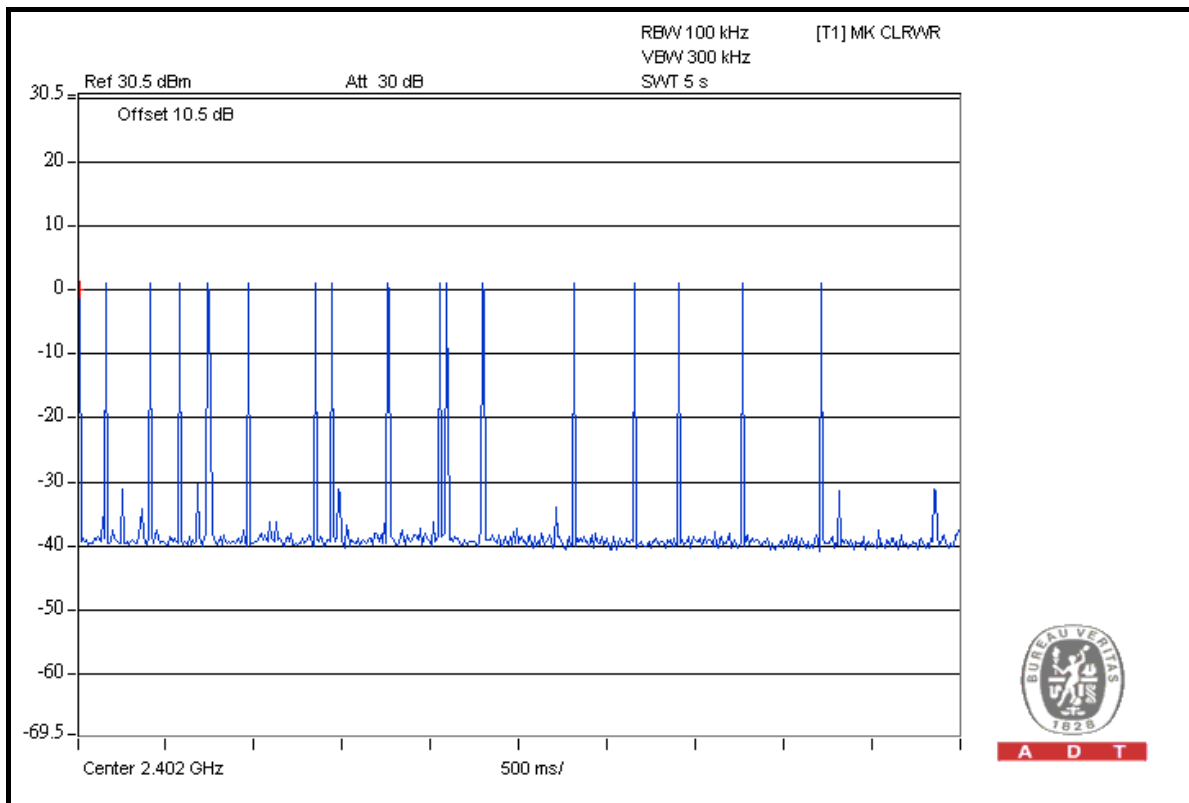

A D T

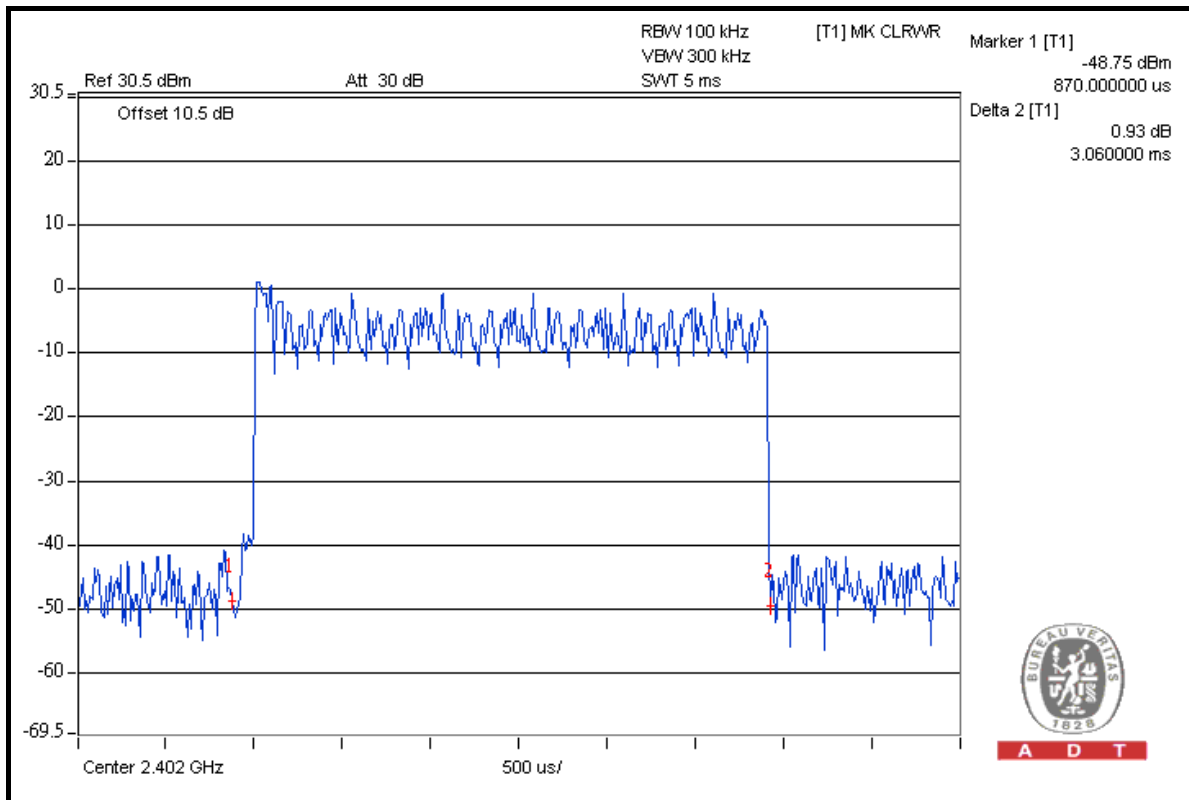

A D T

4.5 CHANNEL BANDWIDTH

4.5.1 LIMITS OF CHANNEL BANDWIDTH

For frequency hopping system operating in the 2400-2483.5MHz, If the 20dB bandwidth of hopping channel is greater than 25kHz, two-thirds 20dB bandwidth of hopping channel shall be a minimum limit for the hopping channel separation.

4.5.2 TEST INSTRUMENTS

DESCRIPTION & MANUFACTURER	MODEL NO.	SERIAL NO.	DATE OF CALIBRATION	DUE DATE OF CALIBRATION
SPECTRUM ANALYZER R&S	FSP40	100040	Jul. 07, 2009	Jul. 06, 2010

NOTE: The calibration interval of the above test instruments is 12 months and the calibrations are traceable to NML/ROC and NIST/USA.

4.5.3 TEST PROCEDURE

- a. Check the calibration of the measuring instrument using either an internal calibrator or a known signal from an external generator.
- b. Turn on the EUT and connect it to measurement instrument. Then set it to any one convenient frequency within its operating range. Set a reference level on the measuring instrument equal to the highest peak value.
- c. Measure the frequency difference of two frequencies that were attenuated 20dB from the reference level. Record the frequency difference as the emission bandwidth.
- d. Repeat above procedures until all frequencies measured were complete.

4.5.4 DEVIATION FROM TEST STANDARD

No deviation.

4.5.5 TEST SETUP

Same as 4.3.5.

4.5.6 EUT OPERATING CONDITION

The software provided by client enabled the EUT to transmit and receive data at lowest, middle and highest channel frequencies individually.



A D T

4.5.7 TEST RESULTS

GFSK

CHANNEL	CHANNEL FREQUENCY (MHz)	20dB BANDWIDTH (MHz)
0	2402	1.02
39	2441	1.02
78	2480	1.01

CH 0

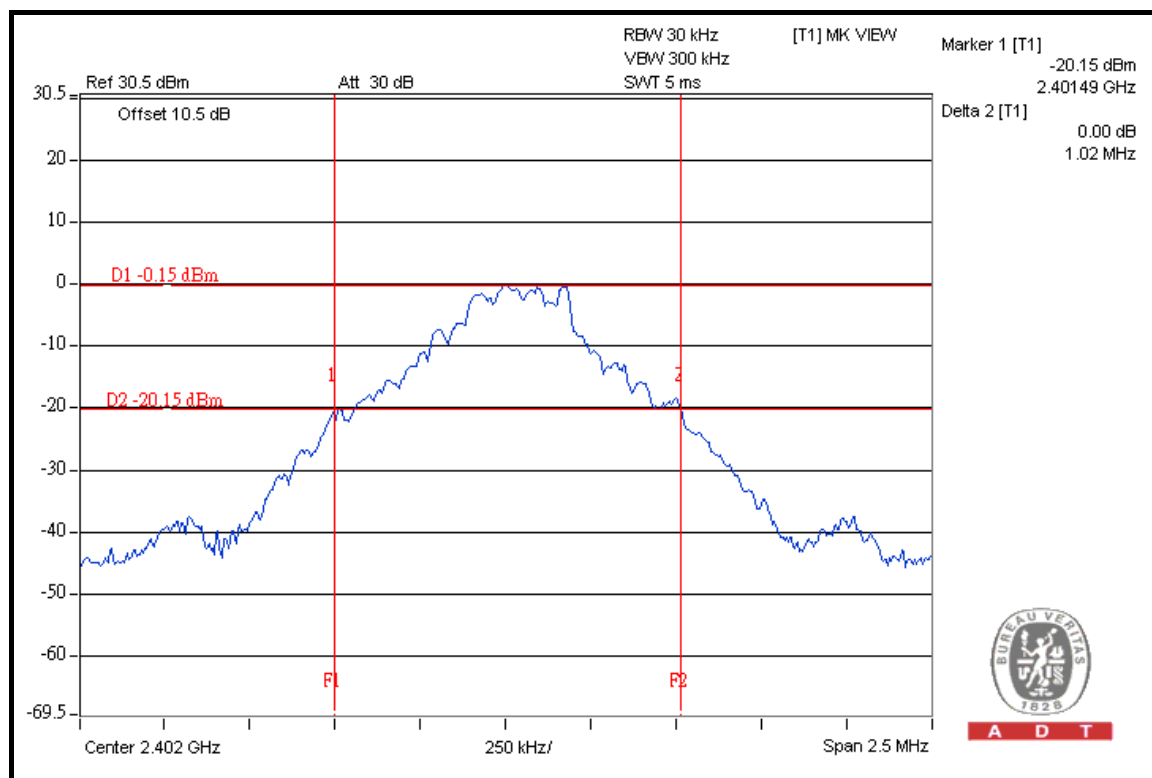

A D T

8DPSK

CHANNEL	CHANNEL FREQUENCY (MHz)	20dB BANDWIDTH (MHz)
0	2402	1.37
39	2441	1.36
78	2480	1.36

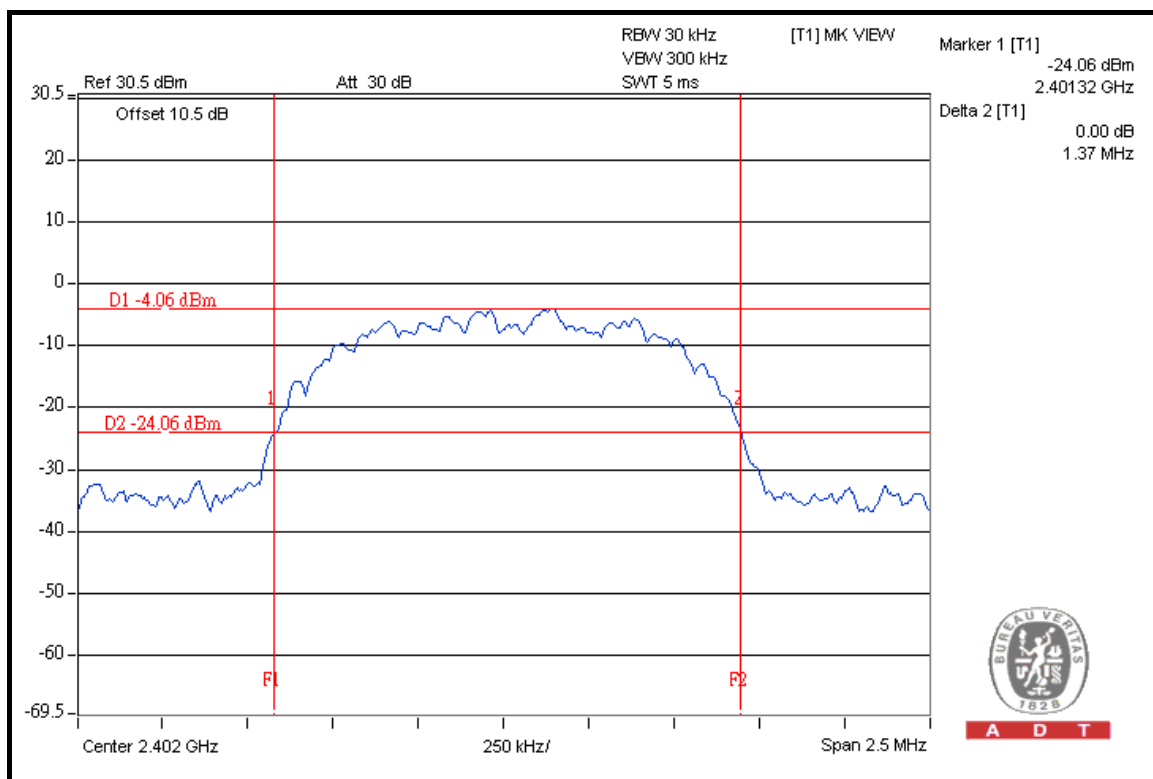
CH 0

4.6 HOPPING CHANNEL SEPARATION

4.6.1 LIMIT OF HOPPING CHANNEL SEPARATION

At least 25kHz or two-third of 20dB hopping channel bandwidth (whichever is greater).

4.6.2 TEST INSTRUMENTS

DESCRIPTION & MANUFACTURER	MODEL NO.	SERIAL NO.	DATE OF CALIBRATION	DUE DATE OF CALIBRATION
SPECTRUM ANALYZER R&S	FSP40	100040	Jul. 07, 2009	Jul. 06, 2010

NOTE: The calibration interval of the above test instruments is 12 months and the calibrations are traceable to NML/ROC and NIST/USA.

4.6.3 TEST PROCEDURES

1. Check the calibration of the measuring instrument using either an internal calibrator or a known signal from an external generator.
2. Turn on the EUT and connect it to measurement instrument. Then set it to any one convenient frequency within its operating range.
3. By using the MaxHold function record the separation of two adjacent channels.
4. Measure the frequency difference of these two adjacent channels by SA MARK function. And then plot the result on SA screen.
5. Repeat above procedures until all frequencies measured were complete.

4.6.4 DEVIATION FROM TEST STANDARD

No deviation.

4.6.5 TEST SETUP

Same as 4.3.5.



A D T

8DPSK

CHANNEL	FREQUENCY (MHz)	ADJACENT CHANNEL SEPARATION (MHz)	20dB BANDWIDTH (MHz)	MINIMUM LIMIT (MHz)	PASS / FAIL
0	2402	1.000	1.37	0.91	PASS
39	2441	1.010	1.36	0.91	PASS
78	2480	1.000	1.36	0.91	PASS

NOTE: The minimum limit is two-third 20dB bandwidth.

CH 39

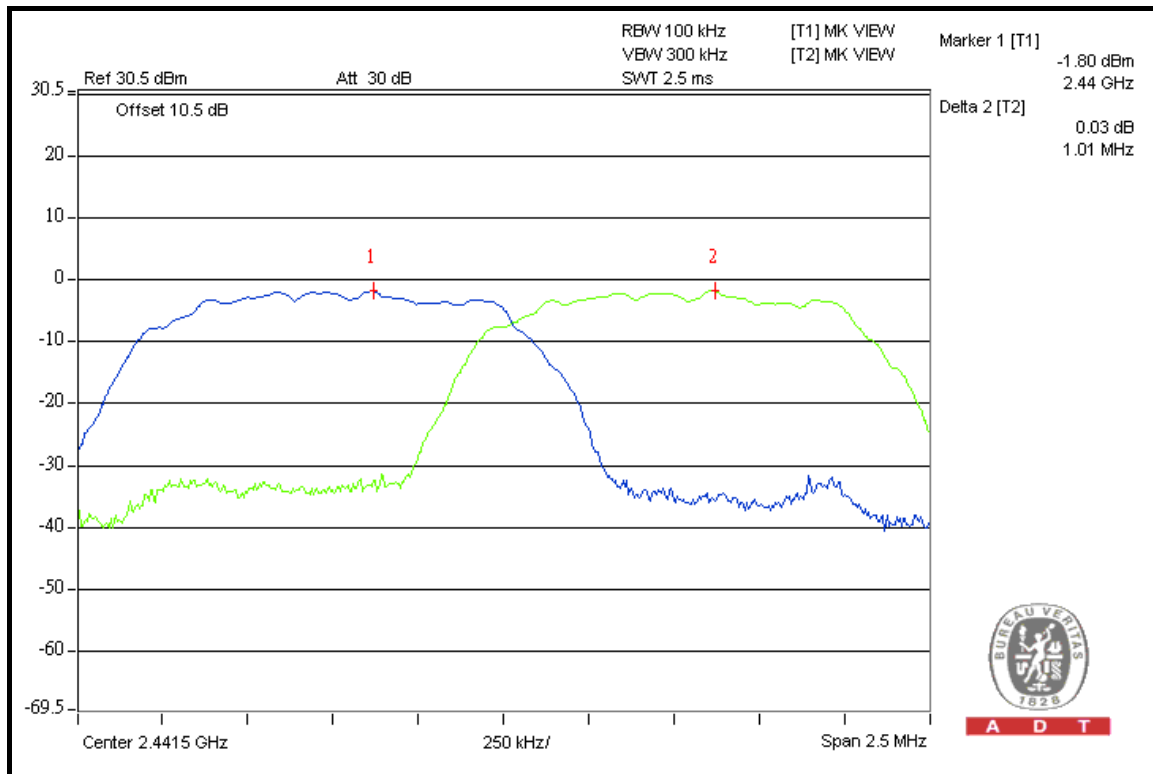



4.7 MAXIMUM OUTPUT POWER

4.7.1 LIMITS OF MAXIMUM OUTPUT POWER MEASUREMENT

The Maximum Output Power Measurement is 125mW.

4.7.2 TEST INSTRUMENTS

DESCRIPTION & MANUFACTURER	MODEL NO.	SERIAL NO.	DATE OF CALIBRATION	DUE DATE OF CALIBRATION
SPECTRUM ANALYZER R&S	FSP40	100040	Jul. 07, 2009	Jul. 06, 2010

NOTE: The calibration interval of the above test instruments is 12 months and the calibrations are traceable to NML/ROC and NIST/USA.

4.7.3 TEST PROCEDURES

- a. Check the calibration of the measuring instrument using either an internal calibrator or a known signal from an external generator.
- b. Turn on the EUT and connect it to measurement instrument. Then set it to any one convenient frequency within its operating range. Set a reference level on the measuring instrument equal to the highest peak value.
- c. The center frequency of the spectrum analyzer is set to the fundamental frequency and using 3MHz RBW and 10 MHz VBW.
- d. Measure the captured power within the band and recording the plot.
- e. Repeat above procedures until all frequencies required were complete.

4.7.4 DEVIATION FROM TEST STANDARD

No deviation.

4.7.5 TEST SETUP

Same as 4.3.5.

4.7.6 EUT OPERATING CONDITION

The software provided by client enabled the EUT to transmit and receive data at lowest, middle and highest channel frequencies individually.

4.7.7 TEST RESULTS

GFSK

CHANNEL	CHANNEL FREQUENCY (MHz)	POWER OUTPUT (mW)	POWER OUTPUT (dBm)	POWER LIMIT (mW)	PASS/FAIL
0	2402	1.6	2.0	125	PASS
39	2441	1.1	0.4	125	PASS
78	2480	1.4	1.4	125	PASS

CH 0

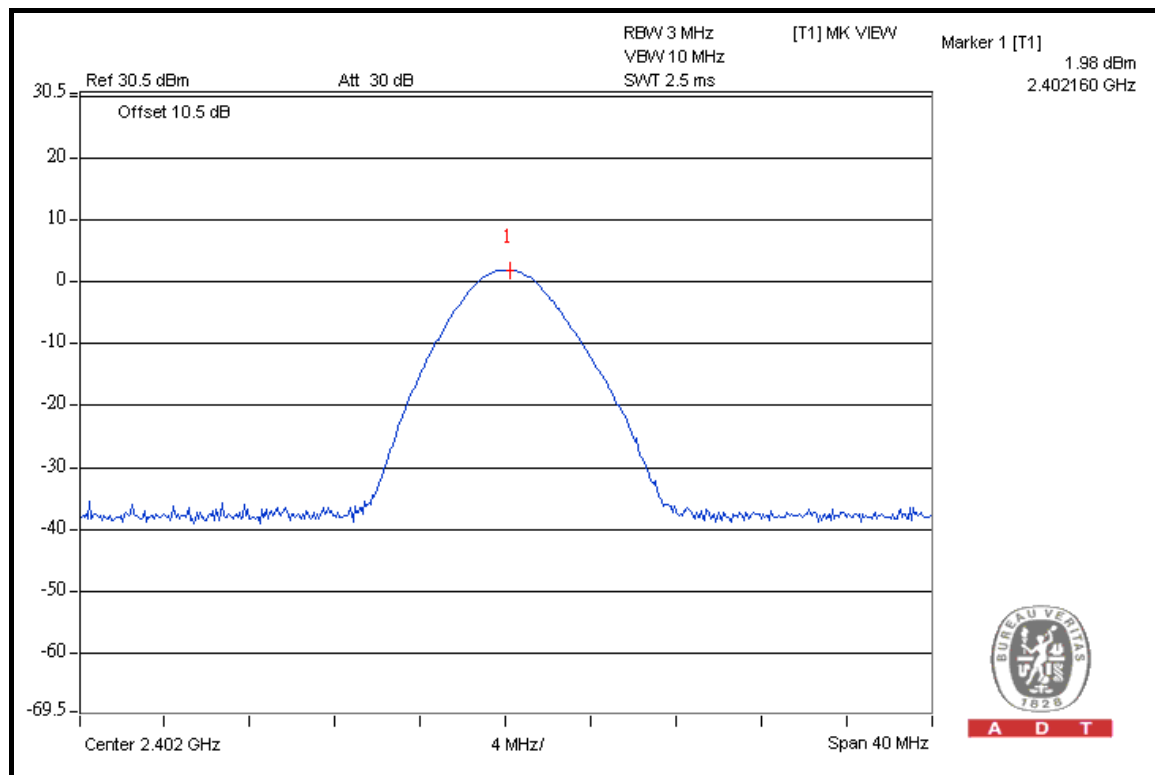



A D T

8DPSK

CHANNEL	CHANNEL FREQUENCY (MHz)	POWER OUTPUT (mW)	POWER OUTPUT (dBm)	POWER LIMIT (mW)	PASS/FAIL
0	2402	2.3	3.7	125	PASS
39	2441	1.8	2.5	125	PASS
78	2480	2.1	3.3	125	PASS

CH 0

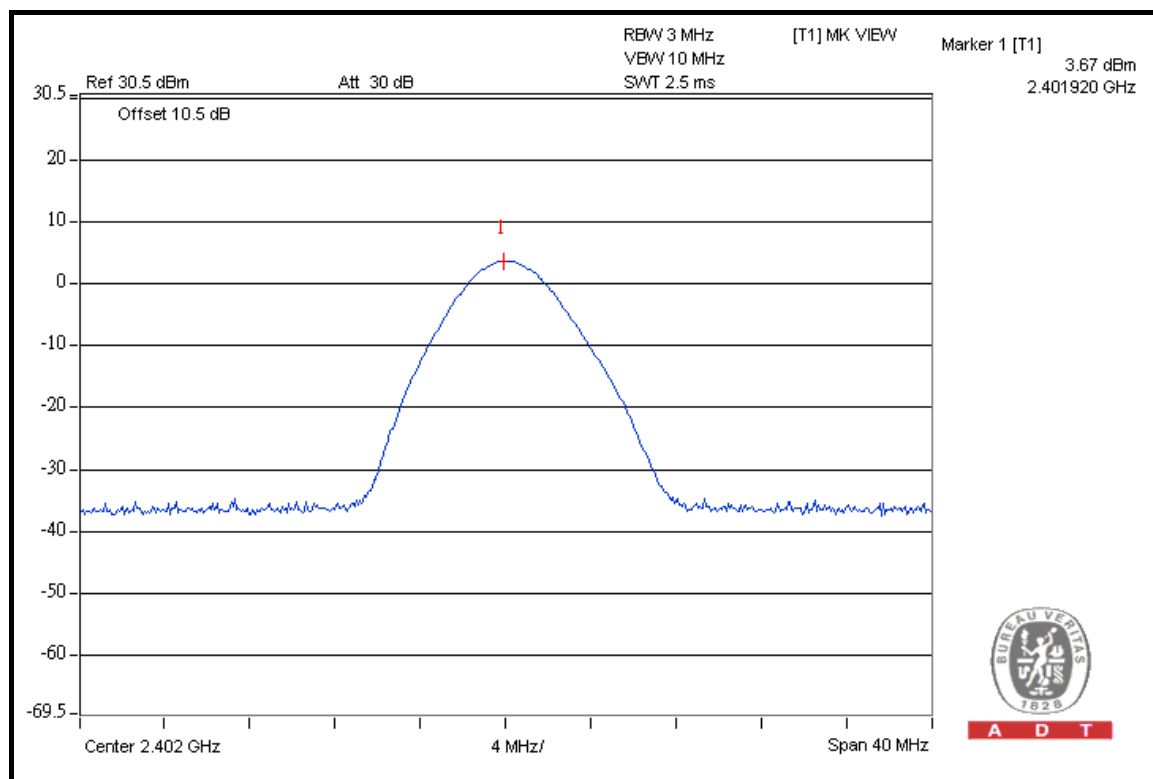

4.8 BAND EDGES MEASUREMENT

4.8.1 LIMITS OF BAND EDGES MEASUREMENT

Below -20dB of the highest emission level of operating band (in 100KHz RBW).

4.8.2 TEST INSTRUMENTS

DESCRIPTION & MANUFACTURER	MODEL NO.	SERIAL NO.	DATE OF CALIBRATION	DUE DATE OF CALIBRATION
SPECTRUM ANALYZER R&S	FSP40	100040	Jul. 07, 2009	Jul. 06, 2010

NOTE: The calibration interval of the above test instruments is 12 months and the calibrations are traceable to NML/ROC and NIST/USA.

4.8.3 TEST PROCEDURE

The transmitter output was connected to the spectrum analyzer via a low lose cable. Set both RBW and VBW of spectrum analyzer to 100 kHz with suitable frequency span including 100 MHz bandwidth from band edge. The band edges was measured and recorded.

4.8.4 DEVIATION FROM TEST STANDARD

No deviation.

4.8.5 EUT OPERATING CONDITION

The software provided by client enabled the EUT to transmit and receive data at lowest, middle and highest channel frequencies individually.

4.8.6 TEST RESULTS

The spectrum plots are attached on the following images. D1 line indicates the highest level, D2 line indicates the 20dB offset below D1. It shows compliance with the requirement in part 15.247(d).

GFSK

RESTRICT BAND (2310 ~ 2390 MHz)

FREQUENCY (MHz)	FUNDAMENTAL EMISSION (dBuV/m)	DELTA (dB)	MAXIMUM FIELD STRENGTH IN RESTRICT BAND (dBuV/m)	LIMIT (dBuV/m)
2402.00 (PK)	95.50	38.66	56.84	74.00
2402.00 (AV)	-	-	26.74	54.00

RESTRICT BAND (2483.5 ~ 2500 MHz)

FREQUENCY (MHz)	FUNDAMENTAL EMISSION (dBuV/m)	DELTA (dB)	MAXIMUM FIELD STRENGTH IN RESTRICT BAND (dBuV/m)	LIMIT (dBuV/m)
2480.00 (PK)	94.40	37.97	56.43	74.00
2480.00 (AV)	-	-	26.33	54.00

NOTE:

1. Delta = Amplitude between the peak of the fundamental and the peak of the band edge emission. Please check following 2 pages.
2. Maximum field strength in restrict band (PK value) = Fundamental emission (PK value) – Delta.
3. Average value = Peak value + 20 Log (duty cycle) = Peak value – 30.1dB.
4. The DH5 packet was the worse case duty cycle for a transmit dwell time on a channel, based upon Bluetooth theory the transmitter is on 0.625 * 5 per 296.25 ms per channel. Therefore, the duty cycle correction factor be equal to: 20log (3.125/100)= -30.1 dB.



A D T

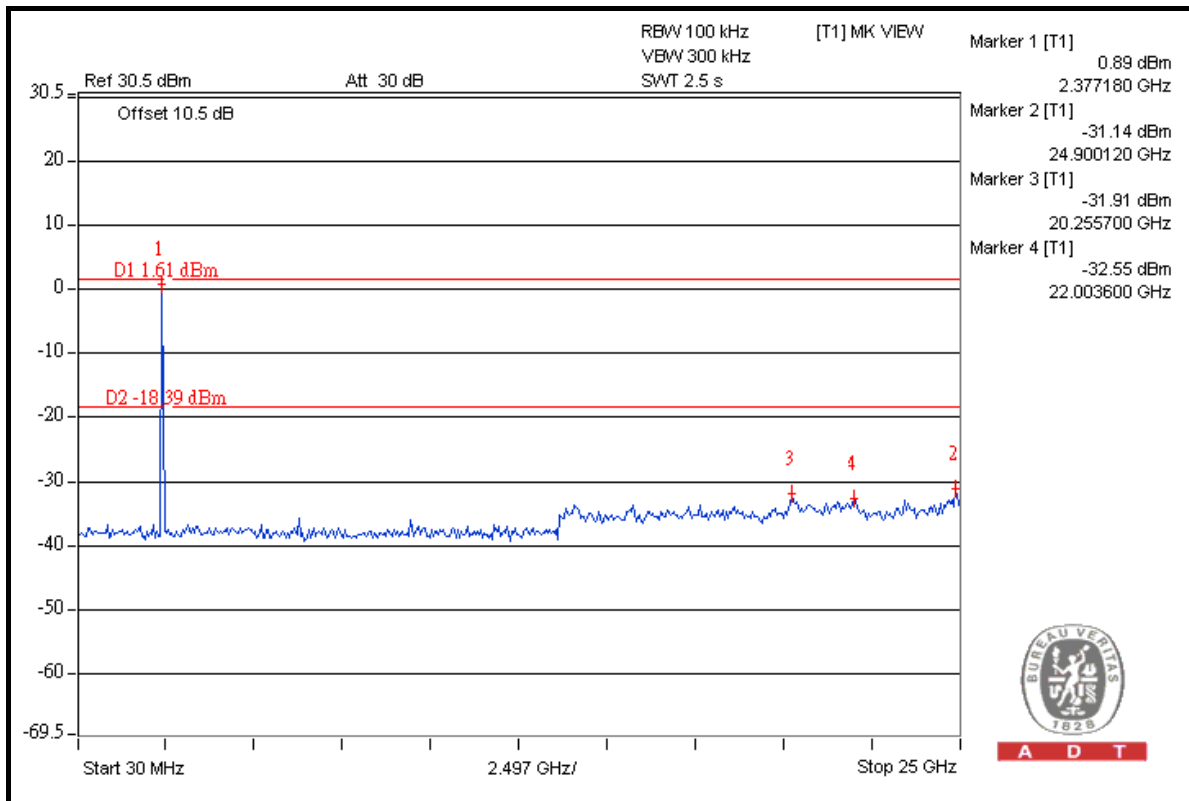
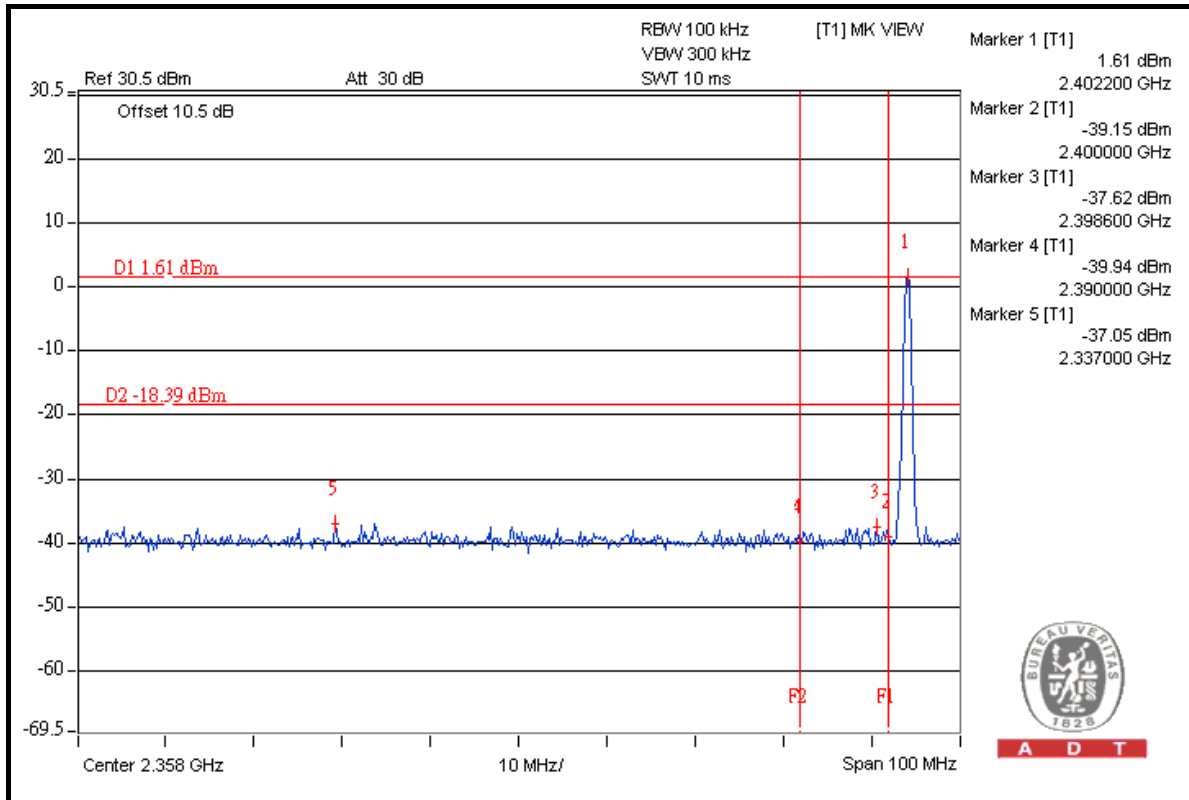



A D T

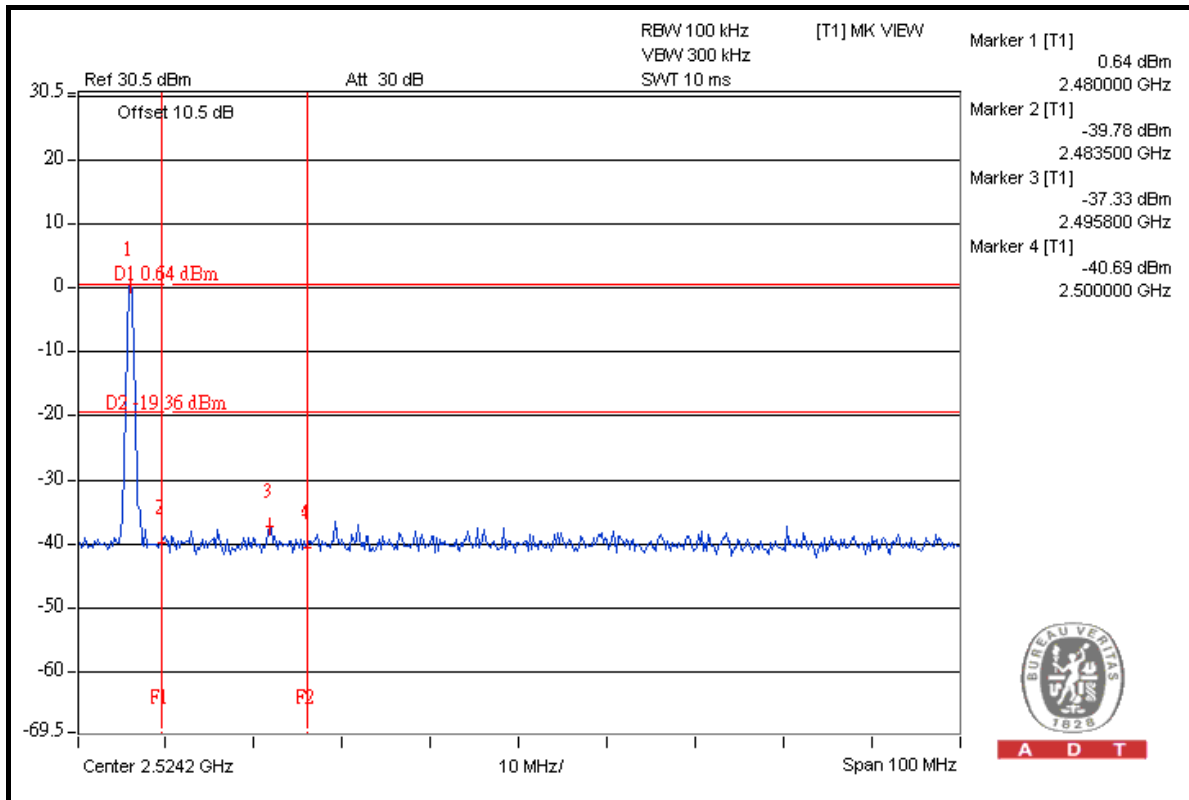

A D T

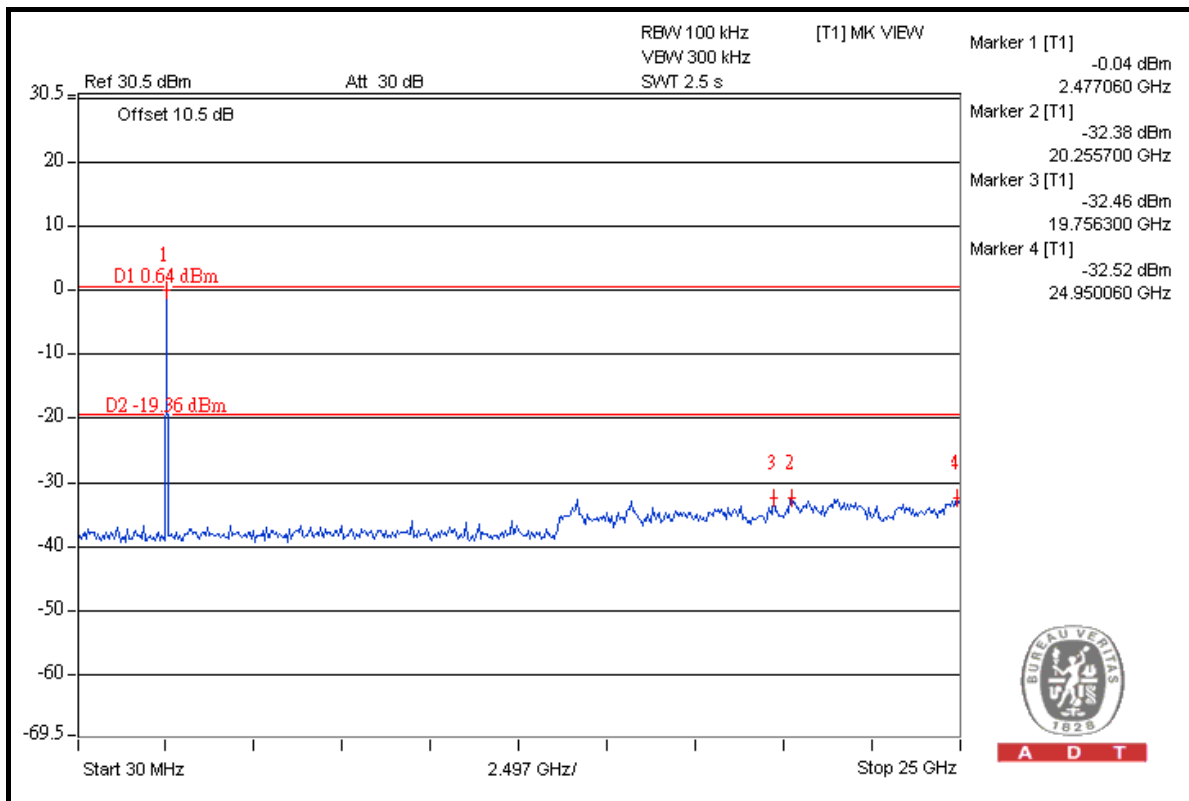

A D T

8DPSK MODULATION

RESTRICT BAND (2310 ~ 2390 MHz)

FREQUENCY (MHz)	FUNDAMENTAL EMISSION (dBuV/m)	DELTA (dB)	MAXIMUM FIELD STRENGTH IN RESTRICT BAND (dBuV/m)	LIMIT (dBuV/m)
2402.00 (PK)	96.20	36.38	59.82	74.00
2402.00 (AV)	-	-	29.72	54.00

RESTRICT BAND (2483.5 ~ 2500 MHz)

FREQUENCY (MHz)	FUNDAMENTAL EMISSION (dBuV/m)	DELTA (dB)	MAXIMUM FIELD STRENGTH IN RESTRICT BAND (dBuV/m)	LIMIT (dBuV/m)
2480.00 (PK)	94.60	36.32	58.28	74.00
2480.00 (AV)	-	-	28.18	54.00

NOTE:

- Delta = Amplitude between the peak of the fundamental and the peak of the band edge emission. Please check following 2 pages.
- Maximum field strength in restrict band (PK value) = Fundamental emission (PK value) – Delta.
- Average value = Peak value + 20 Log (duty cycle) = Peak value – 30.1dB.
- The DH5 packet was the worse case duty cycle for a transmit dwell time on a channel, based upon Bluetooth theory the transmitter is on 0.625 * 5 per 296.25 ms per channel. Therefore, the duty cycle correction factor be equal to: $20\log(3.125/100) = -30.1$ dB.



A D T

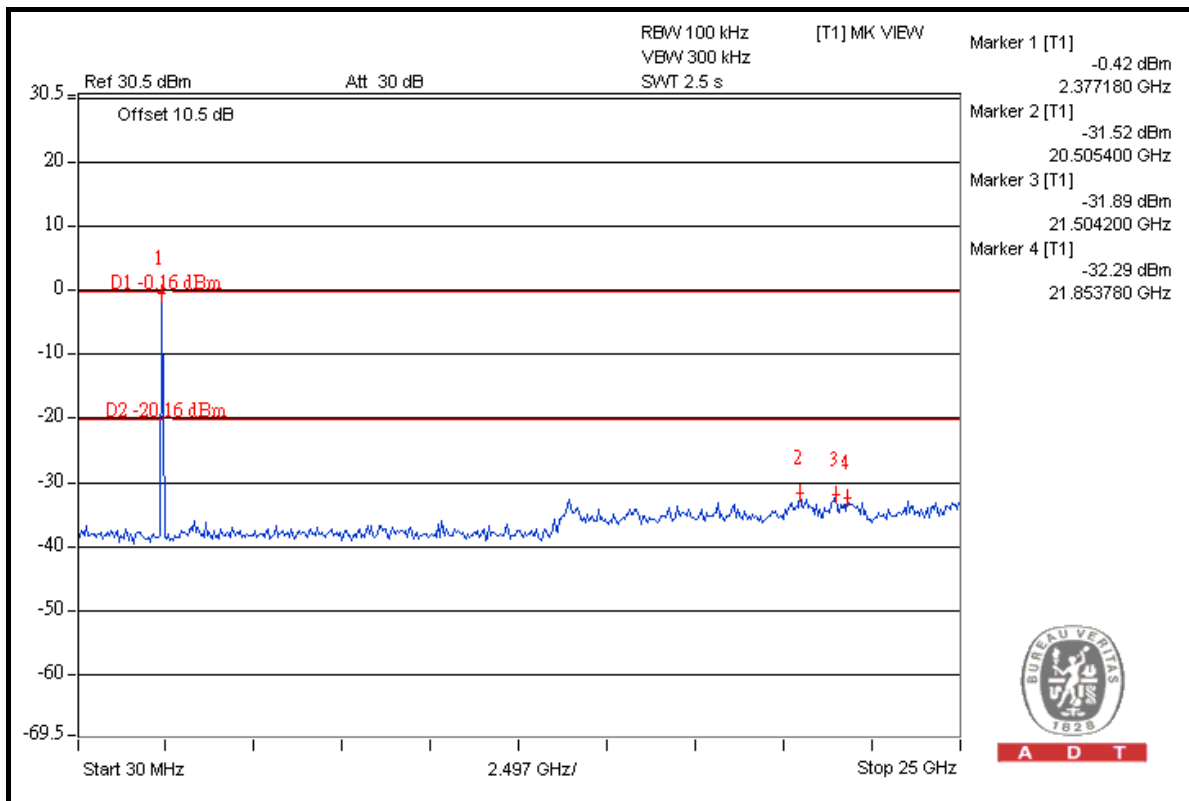
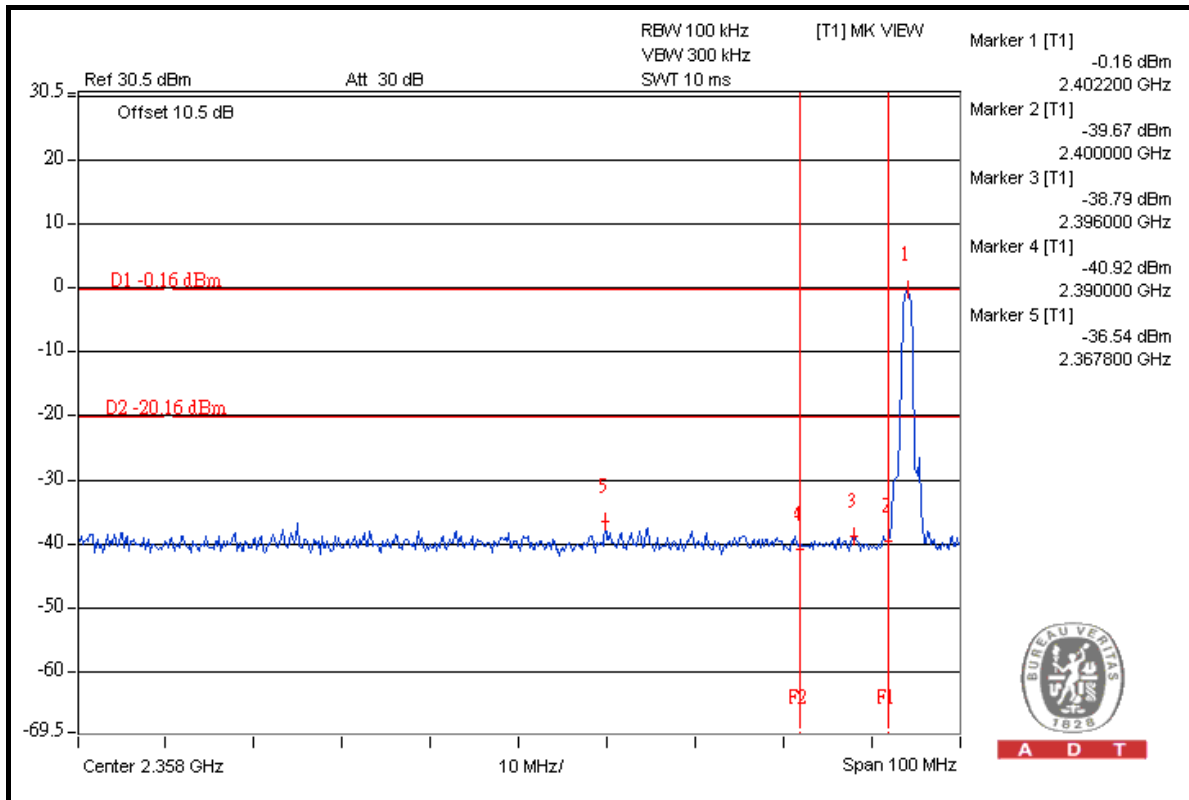



A D T

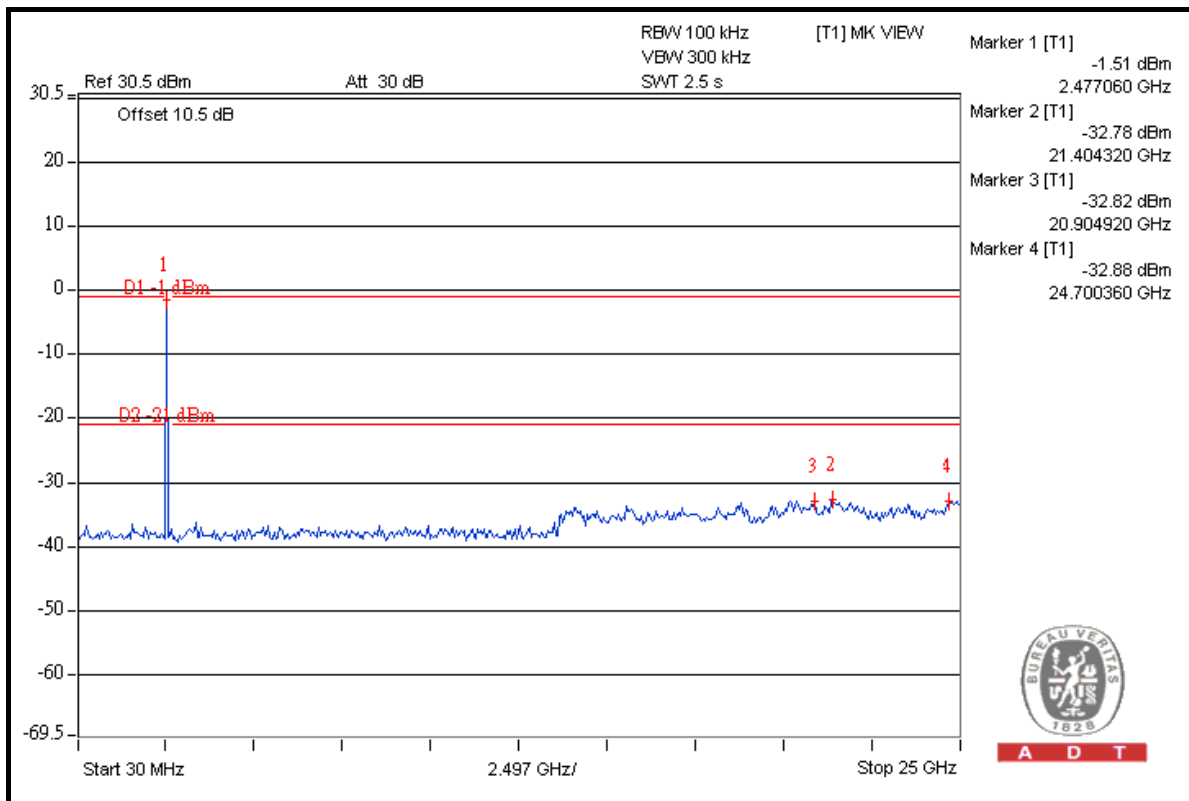
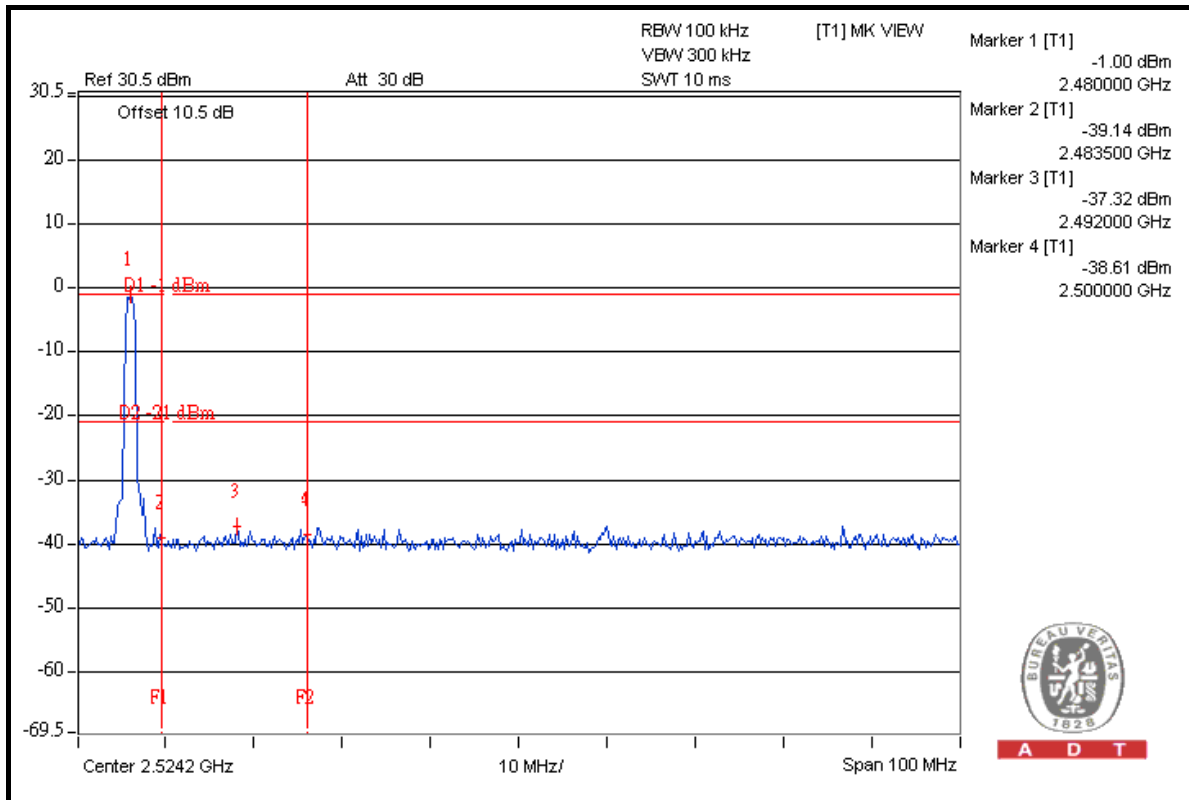

5. PHOTOGRAPHS OF THE TEST CONFIGURATION

Please refer to the attached file (Test Setup Photo).



6. INFORMATION ON THE TESTING LABORATORIES

We, Bureau Veritas Consumer Products Services (H.K.) Ltd., Taoyuan Branch, were founded in 1988 to provide our best service in EMC, Radio, Telecom and Safety consultation. Our laboratories are accredited and approved according to ISO/IEC 17025.

Copies of accreditation certificates of our laboratories obtained from approval agencies can be downloaded from our web site:

www.adt.com.tw/index.5/phtml. If you have any comments, please feel free to contact us at the following:

Linko EMC/RF Lab:

Tel: 886-2-26052180

Fax: 886-2-26051924

Hsin Chu EMC/RF Lab:

Tel: 886-3-5935343

Fax: 886-3-5935342

Hwa Ya EMC/RF/Safety Telecom Lab:

Tel: 886-3-3183232

Fax: 886-3-3185050

Web Site: www.adt.com.tw

The address and road map of all our labs can be found in our web site also.

7. APPENDIX A - MODIFICATIONS RECORDERS FOR ENGINEERING CHANGES TO THE EUT BY THE LAB

No any modifications are made to the EUT by the lab during the test.

--- END ---