Resetting the MC75A

There are two reset functions, warm boot and cold boot. A warm boot restarts the MC75A by closing all running programs. A cold boot also restarts the MC75A, and also resets the clock. Data saved in flash memory or a memory card is not lost.

If the MC75A is not functioning properly, perform a warm boot first. If the MC75A still does not respond, perform a cold boot.

Performing a Warm Boot

Hold down the **Power** button for approximately five seconds. As soon as the MC75A starts to boot release the **Power** button.



Figure 2-16 Warm Boot Splash Screen

Performing a Cold Boot

To perform a cold boot simultaneously press the **Power** button and the **1** and **9** keys.



Figure 2-17 Cold Boot Splash Screen

Waking the MC75A

The wake-up conditions define what actions wake up the mobile computer after it has gone into suspend mode. The mobile computer can go into suspend mode by either pressing the Power button or automatically by Control Panel time-out settings. These settings are configurable and the factory default settings are shown in are subject to change/update.

Table 2-6 Wake-up Default Settings

Condition for Wake-up	Power Button	Automatic Time-out
AC power is applied.	No	Yes
Mobile computer is inserted into a cradle.	No	Yes
Mobile computer is removed from a cradle.	No	Yes
Mobile computer is connected to a USB device.	No	Yes
Mobile computer is disconnected from a USB device.	No	Yes
A key is pressed.	No	Yes
The scan triggered is pressed.	No	Yes
The screen is touched.	No	No
Audio Jack	No	No
Audio Btn	No	No
Bluetooth communication	Yes	Yes
Incoming phone call	Yes	Yes
On motion	No	Yes

Locking the MC75A

Use the Device Lock feature to prevent use of the device. Note that when locked, the MC75A does not respond to screen or keypad input.

To lock the MC75A, tap **Start > Lock**. The **Lock** screen appears.

To unlock the MC75A, side the **Lock** button to the left or right.



Figure 2-18 *Unlock Device Window*

If the MC75A was locked with a password, a prompt appears for the password.

Password Locking

Use the **Password** window to set a password to disable unauthorized access to the MC75A.

- ✓ **NOTE** If the device is configured to connect to a network, use a strong (difficult to figure out) password to help protect network security. Password cracking tools continue to improve and the computers used to crack passwords are more powerful than ever.

1. Tap **Start > Settings > Lock icon > Password** tab.

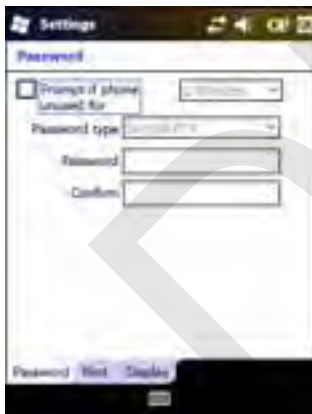

Figure 2-19 *Password Window - Password Tab*

2. Select **Prompt if device unused for** check box to enable password protection.
3. From the drop-down list, select a time value for the protection to take affect after non-use.
4. From the **Password type:** drop-down list, select either **Simple PIN** or **Strong alphanumeric**.
5. For a simple password, enter a four-digit password in the **Password** field.
For a stronger password:
 - a. Enter a seven character password in the **Password:** field. A strong password must contain at least seven characters and contain at least three of the following: uppercase and lowercase letters, numerals, and punctuation.

- b. Re-enter the password in the **Confirm:** field.
6. Tap **OK**.
7. To set a hint to remember the password, tap the **Hint** tab.
8. In the text box, enter a hint for a password reminder.
9. Tap **OK**.

When the MC75A is not used for a period of time and the user tries to access the device, the Password window appears. This also appears when the MC75A is connected to a host computer with either a cradle or communication cable.



Figure 2-20 Enter Password Windows

Enter the password to un-lock the device.

Tap the **Unlock** button to unlock the device and go to the Today screen, or tap the **Contact** button to unlock the device and go to the Contacts window or tap the **Email** button to unlock the device and go to the **Messaging** window.

Function Buttons

- ✓ **NOTE** You can make emergency calls even when the MC75A is locked. See for more information.

The MC75A's buttons perform certain functions.

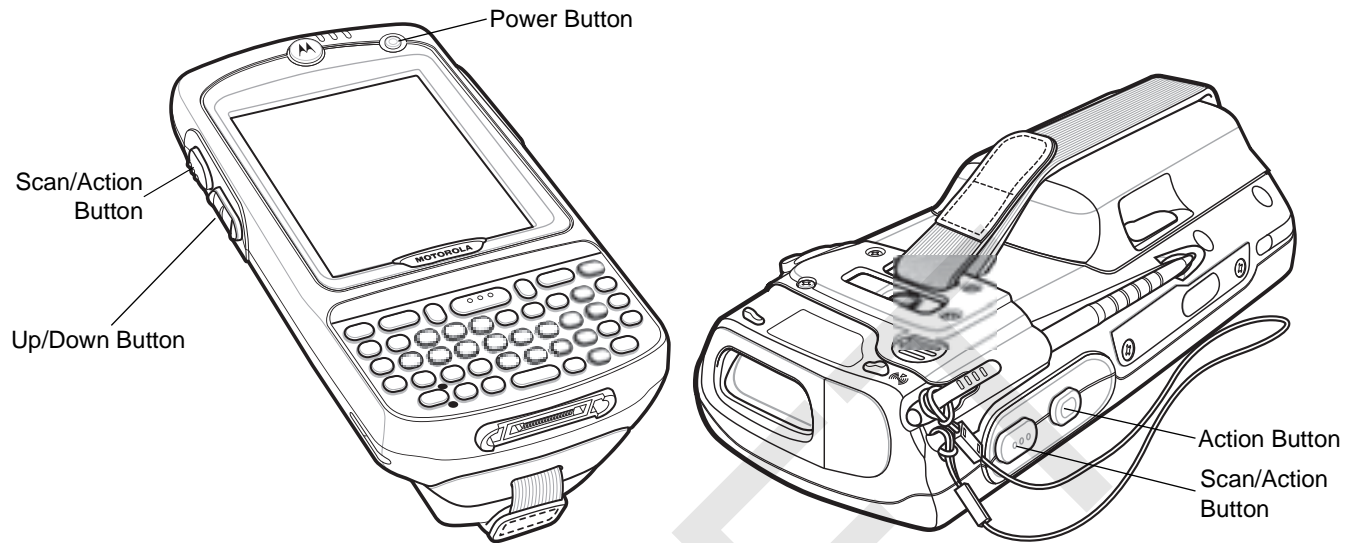

Figure 2-21 Function Buttons

- **Power:** Press the red **Power** button to turn the MC75A screen on and off. The MC75A is in suspend mode when the screen is off. For more information, see [Powering On the MC75A on page 1-7](#). Also use the **Power** button to reset the MC75A by performing a warm or cold boot. See [Resetting the MC75A on page 2-17](#).
- **Scan/Action:** Press to scan bar codes or capture images. See [Chapter 3, Data Capture](#). Or, press to open an application or perform a function. See the *Microsoft® Applications for Mobile 6 User Guide* to set an application to open.
- **Up/Down:** Press to increase or decrease the MC75A's volume.
- **Action:** Press to open an application or perform a function. See the *Microsoft® Applications for Mobile 6 User Guide* to set an application to open.

Stylus

Use the MC75A stylus to select items and enter information. The stylus functions as a mouse.

- **Tap:** Touch the screen once with the stylus to press option buttons and open menu items.
- **Tap and Hold:** Tap and hold the stylus on an item to see a list of actions available for that item. On the pop-up menu that appears, tap the action to perform.
- **Drag:** Hold the stylus on the screen and drag across the screen to select text and images. Drag in a list to select multiple items.



NOTE Motorola recommends using the spring-loaded tip of the stylus to write on the screen, and the back end of the stylus to tap the screen. Use your finger to press the **Power** button and keypad buttons.



CAUTION To prevent damage to the screen, do not use any device other than the Motorola-provided stylus.

Entering Data

When entering data on the keypad, use either the single-hand method or the two-hand method as shown in [Figure 2-22](#).

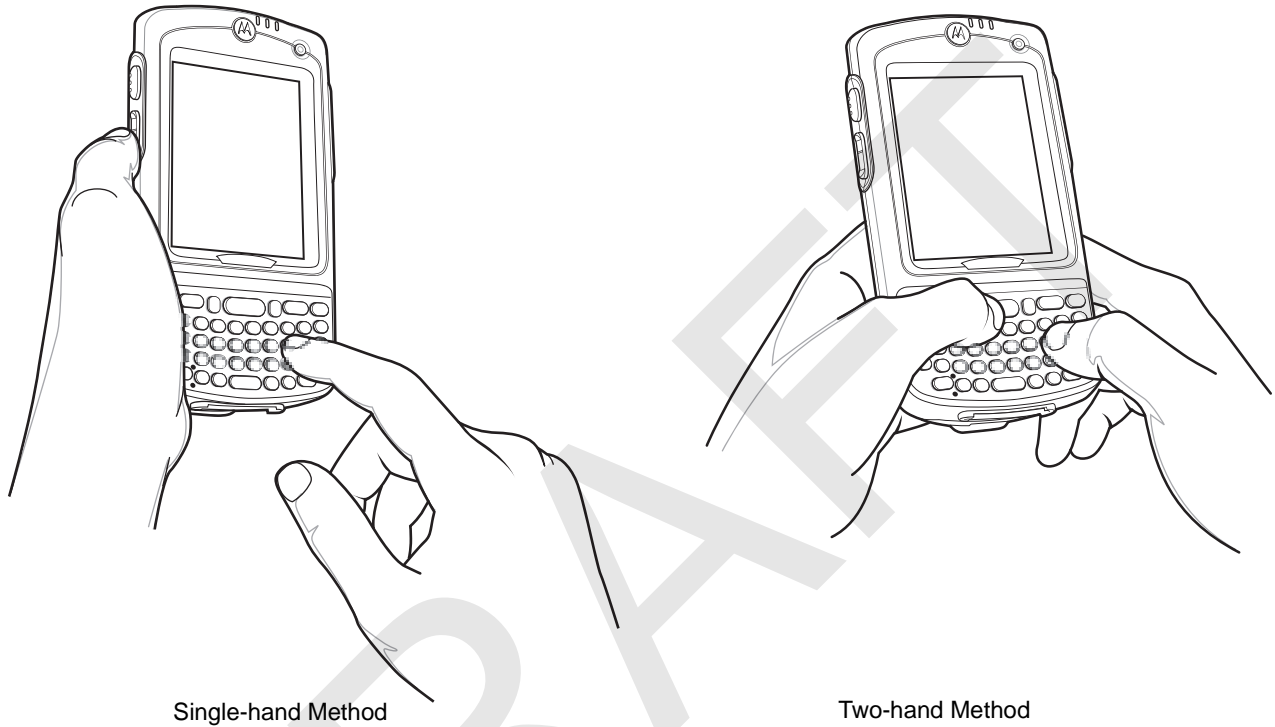

Figure 2-22 *Entering Data on the Keypad*

Interactive Sensor Technology

This section describes the functionality of the Interactive Sensor Technology (IST) feature on the MC75A.

The IST supports the following features.

- Power Management – manage power by configuring IST to control switching on/off the backlight, control suspend mode of the MC75A by monitoring motion and orientation.
- Display Orientation – switch the screen orientation to either landscape or portrait depending on the MC75A orientation.
- Free Fall Detection – monitors free fall duration and records the time and type of the drop event.

Power Management

The MC75A orientation and motion sensitive data can be used as an indicator of MC75A usage and can be used to manage the battery power of the mobile computer. For example, IST can be configured to control the backlight on and off functionality or go into suspend according to a user gesture by placing screen facing down. It can also be used to keep the MC75A active while it is in movement to prevent it from quickly going into suspend mode while in use.

Display Orientation

The screen can be rotated between portrait and landscape modes automatically, depending on the physical orientation of the MC75A. For example, if the MC75A is rotated 90° counterclockwise, IST rotates the display counterclockwise 90° so that the screen display appears correct.

This functionality is achieved by monitoring screen angle and rotating the display to counter any changes. IST only rotates the screen in multiples of 90°.

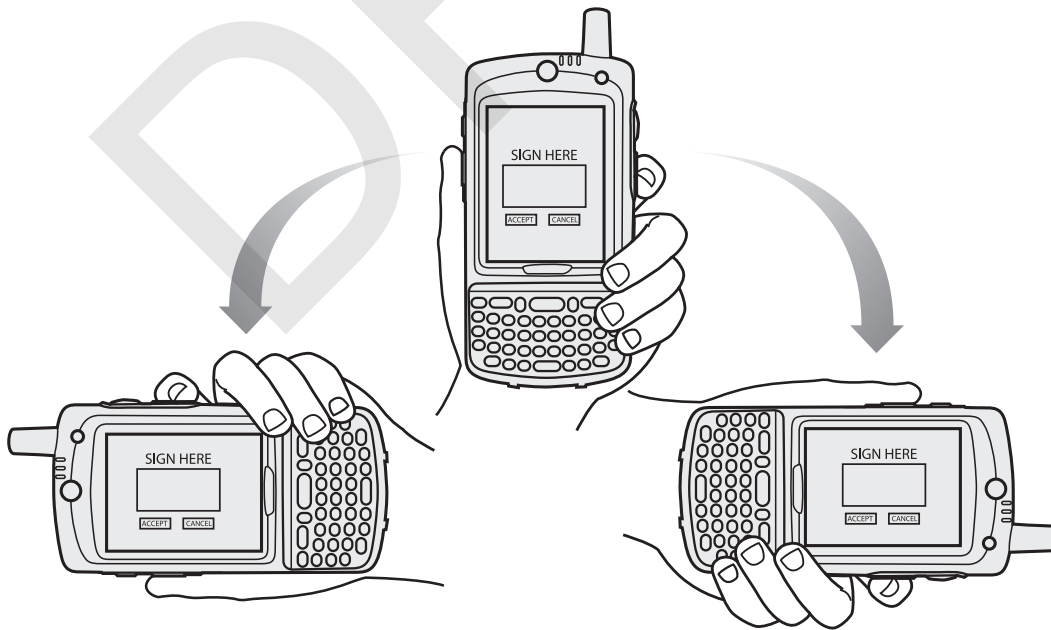

Figure 2-23 Display Orientation

Free Fall Detection

IST continuously monitors gravitational force on the MC75A according to its current position. When the MC75A free falls, IST detects the absence of gravitational force and records the event data if it detects a free fall more than 450 ms, which may indicate nearly a one meter drop. This data can be used as an indicator of potential abuse or misuse.

IST features a log for recording the free fall events. This log records the date, time and the time period of the free fall.

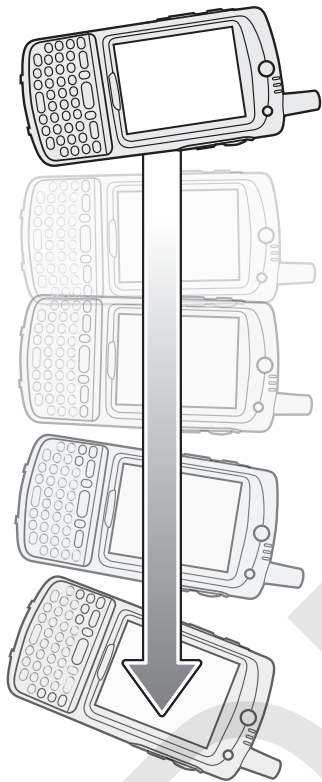

Figure 2-24 Free Fall Detection

Taking Photos

To take a photo:

1. Tap **Start** > **Pictures & Videos** icon.
2. Tap **Camera** on the command bar.
3. Check the image on the view finder, adjust if necessary.
4. Press the **Enter** key to take the picture. Hold the MC75A still until the camera flash occurs or the shutter sound is heard.

Recording Video

To record a video clip:

1. Tap **Start > Pictures & Videos** icon.
2. Tap **Camera** on the command bar.
3. Tap **Menu > Video** to set shooting mode to video.
The available recording time displays on the screen.

✓ **NOTE** By default, the time limit for recording videos is set to 30 seconds.

4. Press the **Enter** key to begin recording.
Recording stops when you press the **Enter** button again.

Viewing Photos and Videos

✓ **NOTE** For detailed information on the Photos and Videos, refer to the *Microsoft Applications User Guide for Mobile 6*, p/n 72E-108299-xx.

To view photos and video clips:

1. Tap **Start > Pictures & Videos** icon.
2. Tap the picture or video clip to view.

Using IrDA

In a Microsoft Windows Mobile program (except Messaging), and Picture & Videos, you can exchange files using either infrared or Bluetooth.

✓ **NOTE** You can also beam files (not folders) from the **File Explorer** window. Tap and hold the item you want to send, then tap **Beam File** from the pop-up menu.

First activate the beam function before exchanging files with another IrDA device.

To activate the Beam function:

1. Tap **Start > Settings > Connections** folder > **Beam** icon.
2. Tap **Receive all incoming beams** check box.



Figure 2-25 *Beam Window*

3. Tap **OK**.

Infrared Connection

Using infrared, you can enable short-range file exchange between your MC75A and another IrDA device.

Exchanging Files using IR Connection

Ensure that the IrDA function on both the MC75A and the other device are enabled.

To send files via IrDA connection:

1. Switch to the program where you created the item you want to send and locate the item in the list.

✓ **NOTE** Do not cover or block the IrDA window.

2. Align the IrDA port of the MC75A with that of the IrDA device so that they are unobstructed and within a close range.

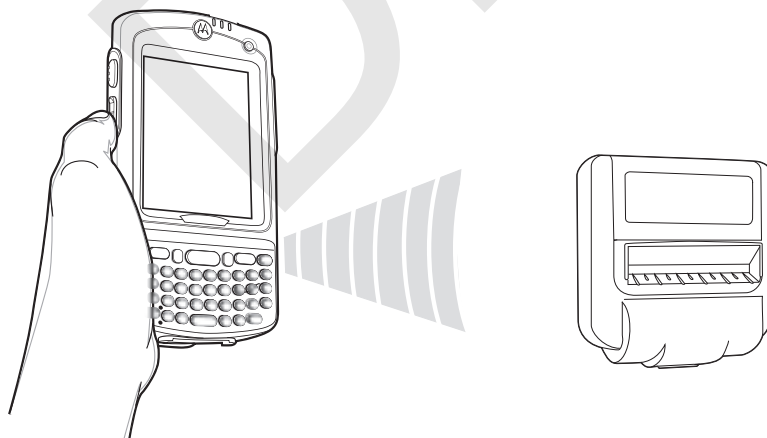

Figure 2-26 *Align MC75A with IrDA Device*

3. Tap and hold the item, then tap **Beam** [type of item] on the pop-up menu.
4. Tap the device that you want to send the file to.



Figure 2-27 Beam Contact

To receive files via IrDA connection:

1. Align the IrDA port of the MC75A with that of the other IrDA device so that they are unobstructed and within a close range.
2. On the other device, send the file to the MC75A.

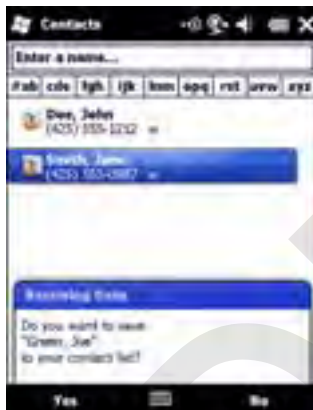

Figure 2-28 Receive File

3. When the **Receiving Data** dialog displays, tap **Yes**.

DRAFT

Chapter 3 Data Capture

Introduction

The MC75A offers three types of data capture options:

- Laser scanning
- Imaging
- Color digital camera.

✓ **NOTE** To perform data capture a scanning enabled application must be installed on the MC75A. A sample scanning application can be downloaded from the Motorola Support site at <http://support.symbol.com>.

Laser Scanning

An MC75A with an integrated laser scanner has the following features:

- Reading of a variety of bar code symbologies, including the most popular 1-D code types.
- Intuitive aiming for easy point-and-shoot operation.

Scanning Considerations

Typically, scanning is a simple matter of aim, scan, and decode and a few quick trial efforts master it. However, consider the following to optimize scanning performance:

- Range
Any scanning device decodes well over a particular working range — minimum and maximum distances from the bar code. This range varies according to bar code density and scanning device optics.
Scanning within range brings quick and dependable decodes; scanning too close or too far away prevents decodes. Move the scanner closer or further away to find the right working range for the bar codes being scanned.
- Angle
Scanning angle is important for promoting quick decodes.

- Hold the MC75A farther away for larger symbols.
- Move the MC75A closer for symbols with bars that are close together.

✓ **NOTE** Scanning procedures depend on the application and MC75A configuration. An application may use different scanning procedures from the one listed above.

Bar Code Scanning

1. Ensure that a scan enabled application is loaded on the MC75A.

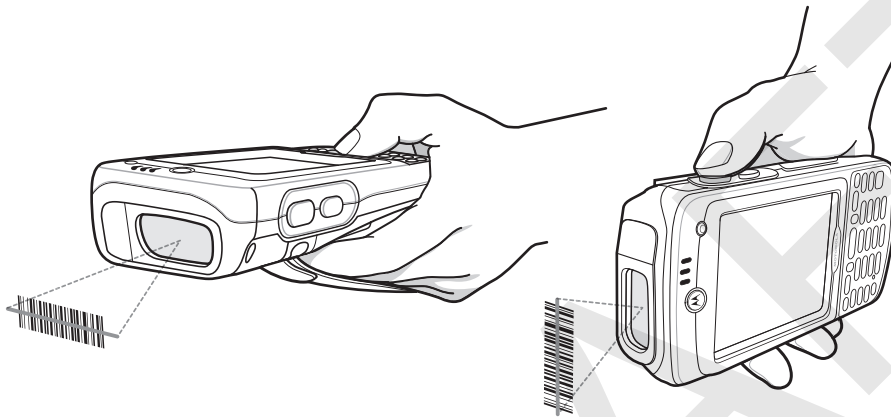

Figure 3-1 Linear Scanning

2. Press and hold the scan button. The laser beam exits from the end of the MC75A. Ensure the red scan beam covers the entire bar code. The Scan/Decode LED lights red to indicate that scanning is in process, then lights green and a beep sounds, by default, to indicate the bar code was decoded successfully.



Figure 3-2 Linear Scanner Aiming Pattern

3. Release the scan button.

Imaging

An MC75A with an integrated imager has the following features:

- Omnidirectional reading of a variety of bar code symbologies, including the most popular linear, postal, PDF417, and 2D matrix code types.
- The ability to capture and download images to a host for a variety of imaging applications.
- Advanced intuitive laser aiming for easy point-and-shoot operation.

The imager uses digital camera technology to take a digital picture of a bar code, stores the resulting image in its memory, and executes state-of-the-art software decoding algorithms to extract the data from the image.

Operational Modes

MC75A with an integrated imager support three modes of operation, listed below. Activate each mode by pulling the trigger or pressing the **Scan** button.

- **Decode Mode:** In this mode, the MC75A attempts to locate and decode enabled bar codes within its field of view. The imager remains in this mode as long as you hold the trigger, or until it decodes a bar code.

✓ **NOTE** To enable Pick List Mode, download the Control Panel applet from the web site at <http://support.symbol.com>. Pick List can also be set in an application using a API command.

- **Pick List Mode:** This mode allows you to selectively decode a bar code when more than one bar code is in the MC75A's field of view. To accomplish this, move the aiming crosshair over the required bar code to decode only this bar code. This feature is ideal for pick lists containing multiple bar codes and manufacturing or transport labels containing more than one bar code type (either 1D or 2D).
- **Image Capture Mode:** Use this mode to capture an image within the MC75A's field of view. This is useful for capturing signatures or images of items like damaged boxes.

Imager Scanning

1. Ensure that a scan-enabled application is loaded on the MC75A.

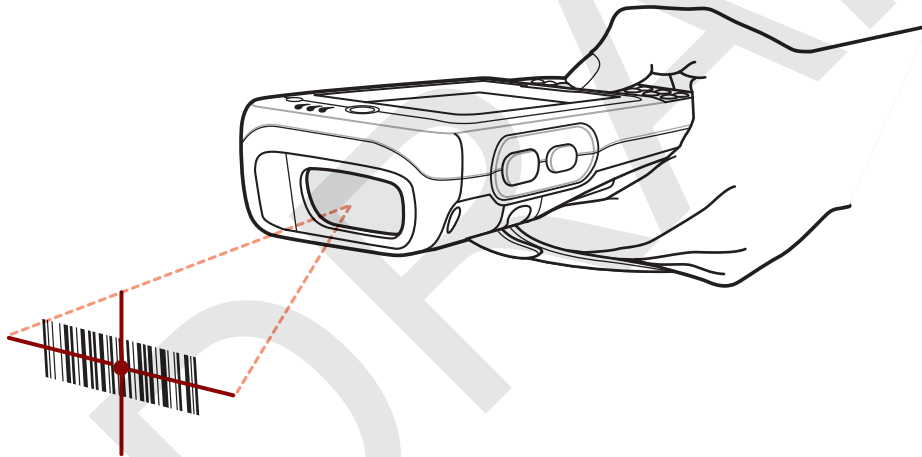

Figure 3-3 *Imager Scanning*

2. Press and hold the scan button. The red laser aiming pattern turns on to assist in aiming. Ensure the bar code is within the area formed by the brackets in the aiming pattern. The Scan/Decode LED lights red to indicate that scanning is in process, then lights green and a beep sounds, by default, to indicate the bar code was decoded successfully. Note that when the MC75A is in Pick List Mode, the imager does not decode the bar code until the crosshair touches the bar code.

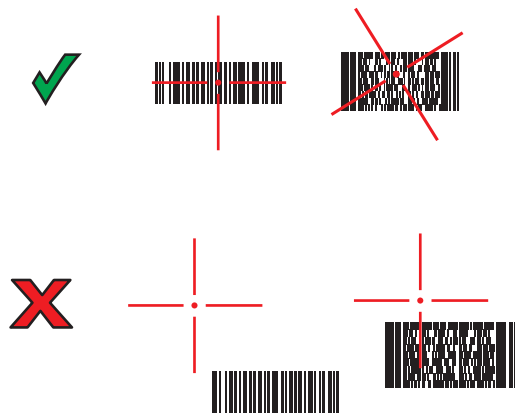

Figure 3-4 Imager Aiming Pattern



Figure 3-5 Pick List Mode with Multiple Bar Codes

3. Release the scan button.

✓ **NOTE** Imager decoding usually occurs instantaneously. The MC75A repeats the steps required to take a digital picture (image) of a poor or difficult bar code as long as the scan button remains pressed.

Color Digital Camera

MC75A with an integrated color digital camera have the following features:

- Omnidirectional reading of a variety of bar code symbologies, including the most popular linear, postal, PDF417, and 2D matrix code types.
- Advanced intuitive aiming for easy point-and-shoot operation.

Digital Camera Scanning

1. Ensure that a scan-enabled application is loaded on the MC75A.
2. Aim the camera lens on the back of the MC75A at a bar code.
3. Press and hold the scan button. A preview window appears on the display window with a red aiming reticle in the center. The Scan/Decode LED lights red to indicate that scanning is in process.

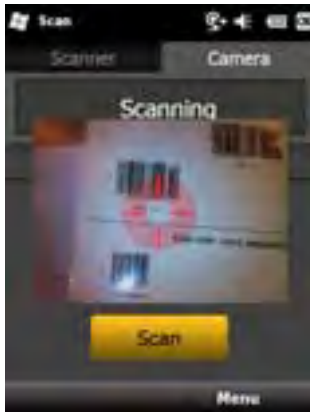

Figure 3-6 Sample Scan Application with Preview Window

4. Move the MC75A until the red aiming reticle is on the bar code to scan. The aiming reticle turns green when the MC75A is able to decode the bar code.

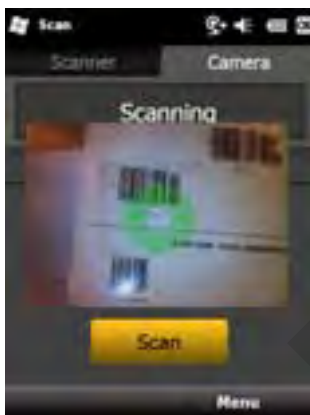

Figure 3-7 Digital Camera Scanning

5. Release the scan button. The Scan/Decode LED lights green and a beep sounds, by default, to indicate the bar code was decoded successfully.

✓ **NOTE** The camera decode feature is set by default to automatically decode the bar code when read. This feature can be programmed to display a green aiming reticle upon good decode indicating that the bar code has been successfully decoded and to that the scan button may be released.

DRAFT

Chapter 4 Using the Phone

Introduction

Use the MC75A to make phone calls, set up speed dials, keep track of calls, and send text messages. Your wireless service provider may also provide other services such as voice mail, call forwarding, and caller ID.

Also use the integrated phone to connect to an ISP or work network in order to browse the Web and read e-mail. Connect to the Internet or work network over High-Speed Downlink Packet Access (HSDPA) (MC75A6) or Evolution Data-Optimized (EvDO) (MC75A8) using Cellular Line, or using the modem specified by the mobile operator. For more information, or to customize the MC75A phone by changing phone settings, see the *MC75A Integrator Guide*.

Accessing the Phone Keypad

- ✓ **NOTE** Keypads vary depending on the carrier, services and the state of the phone. For example, place calls on hold and use **Swap** to switch active calls on hold. (See [Conference Calling on an MC75A6 on page 4-19](#).)

Access the keypad regardless of the program in use. Applications on the MC75A can be in use during a call.



Figure 4-1 Phone Keypads

To access the phone keypad tap **Start** > **Phone** or press the green phone key on the MC75A's keypad.

To receive calls when the MC75A is suspended, leave the phone radio turned on and ensure the MC75A is set to wake with any key.

Turning the Phone On and Off

Windows Mobile 6 devices include **Wireless Manager**, which provides a simple method of enabling and disabling the phone.

To open **Wireless Manager**, tap the **Connectivity** icon.

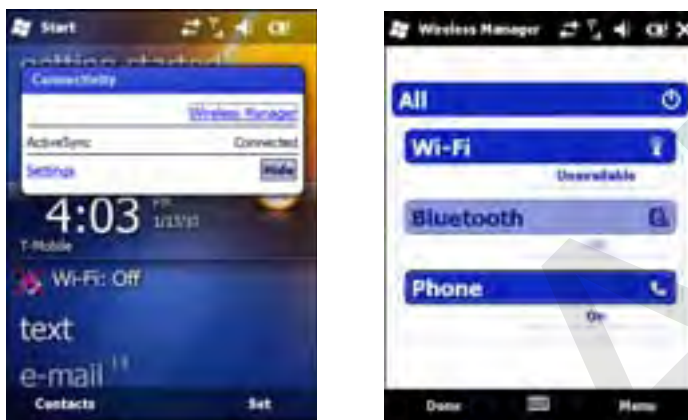

Figure 4-2 Opening Wireless Manager

Select **Wireless Manager**. The **Wireless Manager** window appears.

To toggle on or off the phone, tap blue Phone bar.

To configure settings for a connection, tap **Menu** > **Phone Settings**.

✓ **NOTE** To receive calls when your device is suspended, leave the phone turned on.

Audio Modes

The MC75A offers three audio modes for use during phone calls:

- **Handset Mode:** Switches audio to the speaker at the top front of the MC75, so you can use the MC75A as a handset. This is the default mode.
- **Speaker Mode:** Use the MC75A as if on speaker phone. Tap the **Speaker On** button to activate this mode. Tap the **Speaker Off** button to switch back to handset mode.
- **Headset Mode:** Connect a wired or Bluetooth headset to automatically switch audio to the headset.

The MC75A defaults to handset mode. When a wired headset is plugged into the MC75A audio connector or a Bluetooth headset is configured for use with the MC75, the earpiece and speakerphone are muted and audio is heard through the headset.

✓ **NOTE** While using a Bluetooth headset during a call, the mobile computer will not go into suspend mode.



Figure 4-3 Audio Modes

Using a Wired Headset

You can use a stereo headset for audio communication when using an audio-enabled application. To use a headset, plug the headset jack into the audio connector on the side of the MC75A. Set the MC75A's volume appropriately before putting the headset on. Plugging a headset into the jack mutes the speaker.

For the best audio performance, Motorola recommends a 2.5mm jack headset, see [Chapter 7, Accessories](#).

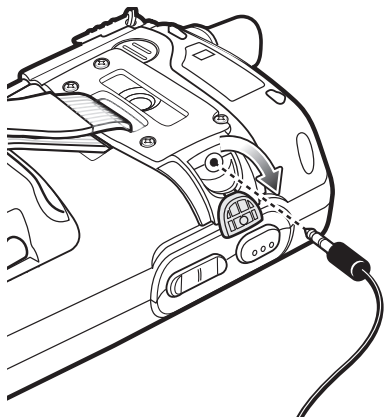

Figure 4-4 Using a Headset

Using a Bluetooth Headset

You can use a Bluetooth headset for audio communication when using an audio-enabled application. See [Chapter 6, Using Bluetooth](#) for information on connecting a Bluetooth headset to the MC75A. Set the MC75A's volume appropriately before putting the headset on. When a Bluetooth headset is connected the speakerphone is muted.

It is recommended for phone conversations to use the Bluetooth Hands-free profile instead of the Headset profile. See [Chapter 6, Using Bluetooth](#) for more information.

- ✓ **NOTE** When using a Bluetooth headset during a call, the MC75A power button is disabled and the MC75A will not go into suspend mode. Once the call is completed, the power button functionality is enabled.

The following dialog box displays when a Bluetooth headset connection is established.

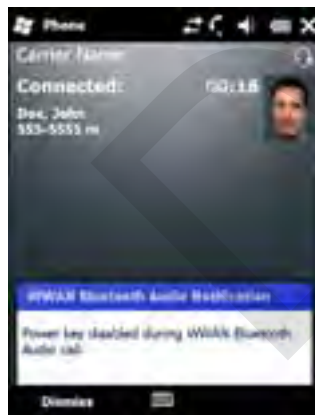

Figure 4-5 WWAN Bluetooth Audio Notification Dialog Box

Adjusting Audio Volume

Use the Volume Control Slider or the keypad keys to adjust the volume of the ringer when not in a call and the audio volume when in a call.



Figure 4-6 Phone Volume Slider

To adjust the volume tap the **Speaker** icon in the **Title** bar. Move the slider up or down to adjust the volume.

- ✓ **NOTE** Adjust the conversation phone volume during a call. Adjusting the volume while not in a call affects the ring and notification sound levels.

Making a Call

- ✓ **NOTE** You can make emergency calls even when the MC75A is locked or when a SIM card is not installed. See [Making an Emergency Call on page 4-7](#) for more information.

With the MC75A, you can make a call from the phone dialer, contacts, speed dial and call history.

Using the Phone Dialer

To make a call using the phone keypad:

1. Tap **Start** > **Phone** or press the green phone key on the MC75A's keypad.
2. From the **Phone** keypad, tap the number to call.
3. Tap **Talk**.
4. Tap **End** to stop dialing or end the call.

- ✓ **NOTE** Alternatively, use the green and red phone keys on the MC75A keypad to dial (green) and end (red) calls.

If you tap a wrong number, tap Delete key to erase each subsequent digit of a number. To erase the entire number, tap and hold the Delete key.

Using Contacts

Use Contacts to make a call without looking up or entering the phone number.

To make a call from Contacts:

1. Tap **Start** > **Contacts**.
2. From the contact list, tap and hold the contact name.



Figure 4-7 Contacts Menu

3. Tap **Call Work**, **Call Home** or **Call Mobile**.

✓ **NOTE** To make a call from an open contact, tap the number to call. See On-Device Help for more information about Contacts.

Using Call History

To make a call using Call History:

1. Tap **Start** > **Phone** or press the green phone key on the MC75A's keypad.
2. From the Phone keypad, tap **Call History**.

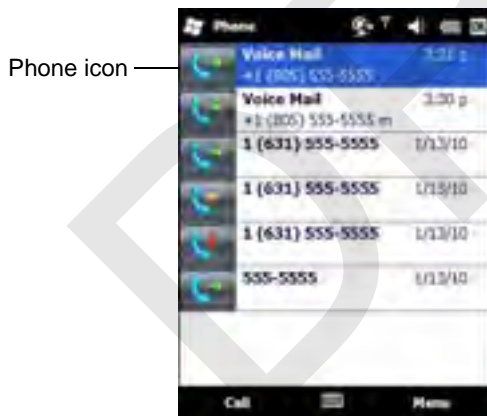

Figure 4-8 Call History Window

3. Tap the phone icon next to the number to begin dialing and return to the phone keypad.
4. Tap **End** or press the red phone key on the MC75A keypad to stop dialing or end the call.

Making a Speed Dial Call

Use Speed Dial to call someone saved in the speed dial directory.

To make a speed dial call:

1. Tap **Start** > **Phone** or press the green phone key on the MC75A's keypad.

- From the Phone keypad, tap and hold the speed dial location number assigned to a contact. (To dial a one-digit speed dial location number, tap and hold the speed dial number. To dial a two-digit speed dial location number, tap the first digit and then tap and hold the second digit.)

or

From the Phone keypad, tap **Speed Dial** and tap the speed dial location number of the desired contact in the list.

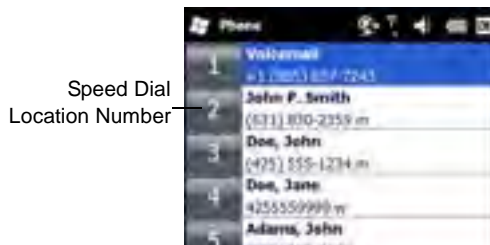

Figure 4-9 Speed Dial Contact List

- To stop dialing or end the call, tap **End** or press the red phone key on the MC75A keypad.

Making an Emergency Call

Your service provider programs one or more emergency phone numbers, such as 911 or 999, that you can call under any circumstances, even when your phone is locked or the SIM card is not inserted (on MC75A6). Your service provider can program additional emergency numbers into your SIM card. However, your SIM card must be inserted in your phone in order to use the numbers stored on it. See your service provider for additional information. See [Installing the SIM Card on page 1-3](#) for SIM card installation procedures.

When the alpha-numeric keypad phone is locked, press the Orange key twice to set the keypad to numeric mode and then enter the emergency number.

- ✓ **NOTE** Emergency numbers vary by country. Your phone's pre-programmed emergency number(s) may not work in all locations, and sometimes an emergency call cannot be placed due to network, environmental, or interference issues.

Answering a Call

A dialog box appears on the MC75A when it receives an incoming call. If the phone is set to ring, a ring tone sounds. Answer or ignore the incoming call.

To answer an incoming call tap **Answer** on the **Phone - Incoming** dialog or press the green phone key on the MC75A keypad.



Figure 4-10 Incoming Call

To ignore the incoming call tap **Ignore**. This may send the caller to voice mail, depending on the service provider. Otherwise, this presents busy signal to the calling party.

To end the call tap **End** or press the red phone key on the MC75A keypad.

Incoming Call Features

- If you receive a call while in a call, tap **Wait** to place the call in call waiting.
- You can use other programs on the MC75A during a call. To switch back to Phone, tap **Talk** or tap **Start > Phone**. Tap **End** to end the call.
- If a caller isn't in your contact list, create a contact during the call or from Call History by tapping **Menu > Save to Contacts**.
- To terminate a call when a second call comes in and answer the waiting call, tap **End** on the Phone keypad to disconnect the active call, then tap **Answer** or press the **Send** key to answer the waiting call.
- To hold the current call and answer a waiting call, tap **Answer** or press the **Send** key to place the current call on hold and answer the incoming call.
- To put a call on hold to call another number or answer an incoming call, tap **Hold** on an MC75A6 or **Talk** on an MC75A8. To move from one call to another, tap **Swap** on an MC75A6 or **Talk** on an MC75A8.

Smart Dialing

Smart Dialing makes it easy to dial a phone number. When you start entering numbers or characters, Smart Dialing automatically searches and sorts the contact entries on the SIM card, in Contacts, and the phone numbers in Call History (including incoming, outgoing, and missed calls). You can then select the desired number or contact from the filtered list to dial.

Open the Phone screen, then tap the keys on the Phone keypad that correspond to the phone number or contact to call. The contact panel lists contacts that match the sequence that you entered.

Smart Dialing starts looking for numbers or contacts that match the sequence entered.

To find a phone number:

- Enter the first one or two digits to find a phone number in Call History.
- Enter the first three digits or more to find a phone number from the saved Contacts and SIM card.

To find a contact name:

- Enter the first letter of a contact's first name or last name. Smart Dialing searches for the letter starting from the first character of a contact name as well as from the character that appears after a space, dash, or underscore in a contact name. For example, if you tap number "2" which is associated with [a, b, c] on the Phone keypad, contact names such as the following will be considered matches: "Smith, Bernard", "Adams, John", "Carlson, Eileen", "Dillon, Albert", "Childs, Larry", "Cooper, Robert" and "Parks, Celine".
- If the matching list is long narrow down the search further by entering another letter. Using the same example above, tap "3" which is associated with (d, e, f), the matching list is narrowed down to the following names: "Smith, Bernard", "Adams, John", and "Parks, Celine".



Figure 4-11 Finding a Contact

To make a call or send a text message using Smart Dialing:

1. Begin entering the first few numbers or characters.
2. In the Smart Dialing panel, use the up and down arrows on the keypad to navigate to the desired contact or phone number.
3. When the correct contact is selected, press **TALK** to make a voice call.
4. To send a text message to the selected contact, tap **Menu > Send Text Message**.
5. To call a different phone number associated with the selected contact, tap the contact name and select the phone number to call.

Muting a Call

During a call, you can mute the microphone so you can hear the person on the line but he or she cannot hear conversation from the microphone. This is useful when there is conversation or background noise on your end.

To mute or unmute a call:

1. Tap **Start > Phone** or press the green phone key on the MC75A's keypad.
2. Make a call.
3. Tap **Mute** on the display to mute the audio. The **Mute** icon appears.

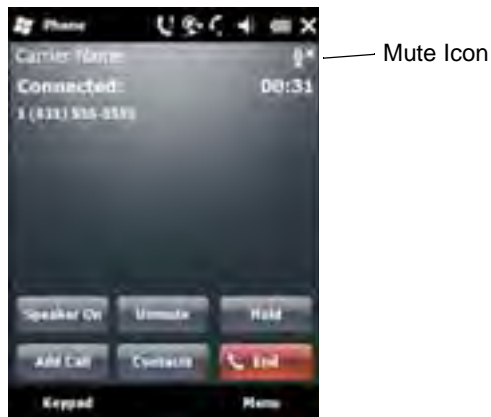

Figure 4-12 Mute Button and Icon

Taking Notes

To create a note during a call, tap **Note** on the display, then enter the note. For more information about creating notes see the Windows On-Device Help.

To access a note created during a call:

1. Tap **Start > Phone** or press the green phone key on the MC75A's keypad.
2. From the Phone keypad, tap **Call History**.
3. Tap and hold the number or the **Note** icon for the phone call entry containing the note.

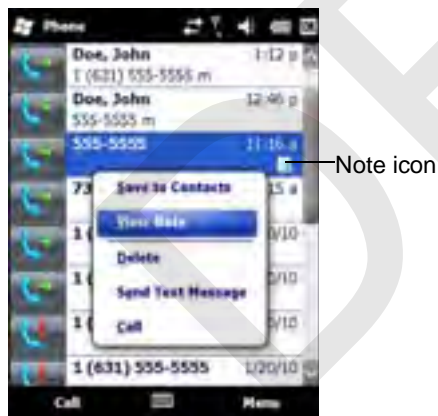

Figure 4-13 Call History - Notes Menu

4. Tap **View Note**.
5. Tap **OK** to exit.

✓ **NOTE** Also access notes directly from the Notes application by tapping **Start > Notes**.

Using Speed Dial

Create speed dial numbers to dial frequently called numbers with a single tap. Before creating a speed dial entry, ensure the phone number exists in Contacts.

Adding a Speed Dial Entry

To add a speed dial entry from the phone keypad:

1. Ensure the contact and phone number are in the Contacts list.
2. Tap **Start > Phone** or press the green phone key on the MC75A's keypad.
3. Tap **Speed Dial** button > **Menu > New**.

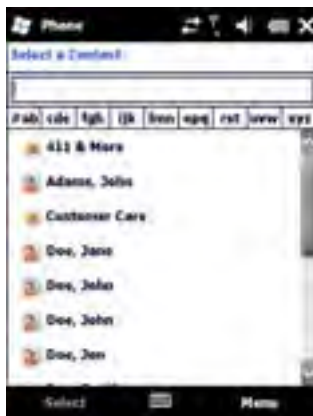

Figure 4-14 Contacts

4. Tap the desired contact name and number in the list.



Figure 4-15 Speed Dial Contact Location

5. In the **Location** field, tap the up/down arrows to select an available location to assign as the new speed dial entry. The first speed dial location is reserved for voice mail.
6. Tap **OK** to add the contact to the speed dial list.



Figure 4-16 Speed Dial Contact List

7. Tap **OK** to exit the **Speed Dial Contact List**.

To add a speed dial entry from the **Contacts** window:

1. Tap **Start > Contacts**.

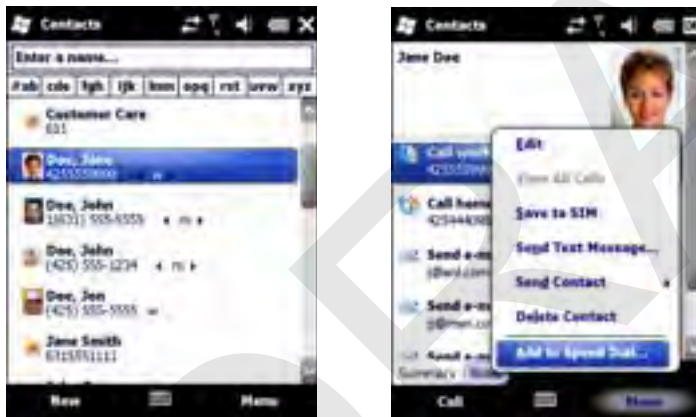

Figure 4-17 Contacts

2. Tap a contact name.

3. Tap **Menu > Add to Speed Dial**.



Figure 4-18 Speed Dial Contact Location

4. Tap the up/down arrows to select an available location to assign as the new speed dial entry. The first speed dial location is reserved for voice mail.
5. Tap **OK**.

Editing a Speed Dial Entry

1. Tap **Start > Phone** or press the green phone key on the MC75A's keypad.
2. Tap **Speed Dial** button.

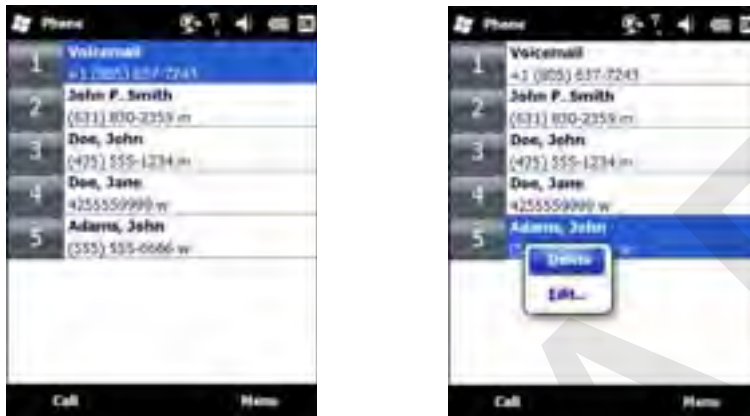

Figure 4-19 Speed Dial Contact List

3. Tap and hold the contact name.
4. Tap **Edit...**
5. Change the name, phone number, or location information.
6. Tap **OK**.

✓ **NOTE** Editing names and phone numbers in **Speed Dial** does not alter contact information in **Contacts (Start > Contacts)**.

Deleting a Speed Dial Entry



1. Tap **Start > Phone** or press the green phone key on the MC75A's keypad.
2. Tap **Speed Dial** button.
3. Tap and hold the contact name.
4. Tap **Delete**.
5. Tap **Yes** to confirm permanently deleting the speed dial entry.

✓ **NOTE** Deleting names and phone numbers in *Speed Dial* does not delete the contact information in **Contacts (Start > Contacts)**.

Using Call History

Use Call History to call someone who was recently called, or recently called in. Call History provides the time and duration of all incoming, outgoing, and missed calls. It also provides a summary of total calls and easy access to notes taken during a call. [Table 4-1](#) lists the call history icons that appear in the **Call History** window.

Table 4-1 *Call History Icons*

Icon	Description
	This icon appears next to the contact information for all outgoing calls.
	This icon appears next to the contact information for all incoming calls.
	This icon appears next to the contact information for all missed calls.

Managing Call History

Change views, reset the call timer, and delete calls to manage the calls stored in Call History.

Changing the Call History View

1. Tap **Start** > **Phone** or press the green phone key on the MC75A's keypad to display the Phone keypad.
2. From the Phone keypad, tap **Call History**.
3. Tap **Menu** > **Filter** to show the menu.

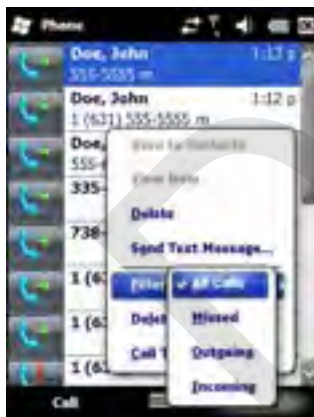

Figure 4-20 *Call History - All Calls/Show Menu*

4. Select a view type from the menu to display only missed calls, outgoing calls, incoming calls, or calls listed alphabetically by caller name.
5. Tap **OK** to exit the **Call History** window.

Resetting the Recent Calls Counter

1. Tap **Start** > **Phone** or press the green phone key on the MC75A's keypad to display the Phone keypad.
2. From the Phone keypad, tap **Call History**.
3. Tap **Menu**.

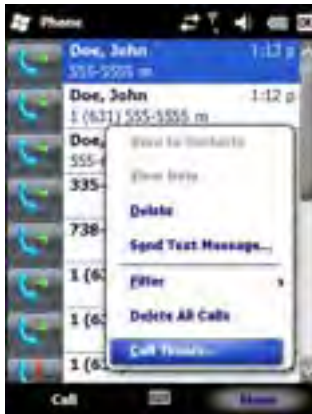

Figure 4-21 Call History - Tools Menu

4. Select **Call Timers...** .



Figure 4-22 Call History - Call Timers

5. Tap **Reset**. (The **All Calls:** counter cannot be reset.)
6. Tap **OK** to exit the **Call Timers** window.

Deleting All Call History Items

1. Tap **Start** > **Phone** or press the green phone key on the MC75A's keypad to display the Phone keypad.
2. From the Phone keypad, tap **Call History**.
3. Tap **Menu**.

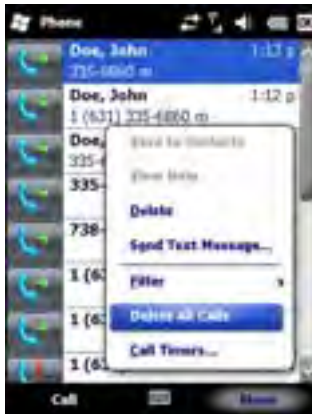

Figure 4-23 Call History - Tools Menu

4. Select *Delete all calls*.



Figure 4-24 Call History - Delete All Dialog

5. Tap **Yes**.
6. Tap **OK** to exit the **Call History** window.

Viewing Call Status

1. Tap **Start** > **Phone** or press the green phone key on the MC75A's keypad to display the Phone keypad.
2. From the Phone keypad, tap **Call History**.
3. Tap an entry. The Call Status window appears.

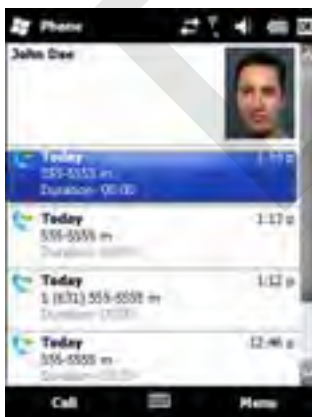

Figure 4-25 Call History - Detail



NOTE When more than one call is on the phone line, only the duration of the first call is recorded.

4. Tap **OK** and then **OK** to exit.

Using the Call History Menu

Use the Call History menu to dial voice mail, access the Activation Wizard, save to contacts, view a note, delete a listing, send a text message, and make a call.

1. Tap **Start** > **Phone** or press the green phone key on the MC75A's keypad to display the Phone keypad.
2. From the Phone keypad, tap **Call History**.
3. Tap and hold an item in the list.

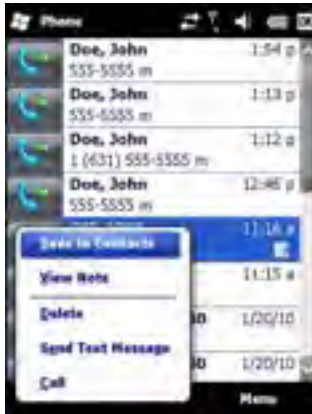

Figure 4-26 Call History - Menu

4. Select an applicable item from the menu, as needed.
5. Depending on the item selected, the appropriate window displays. For example, select **Send Text Message** to display the **Inbox** window.
6. Tap **OK** to exit the **Call History** window.

Swapping Calls on an MC75A6

To move between two phone calls:

1. Tap **Start** > **Phone** or press the green phone key on the MC75A's keypad to display the Phone keypad.
2. Enter the first phone number and press **Talk**. When the call connects, **Hold** appears on the keypad.

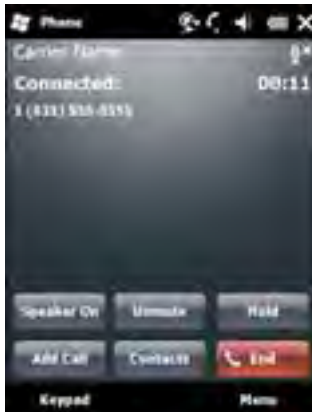

Figure 4-27 Call Swapping - Hold

3. Tap **Hold** on to place the first number on hold.
4. Enter the second number and tap **Talk**.

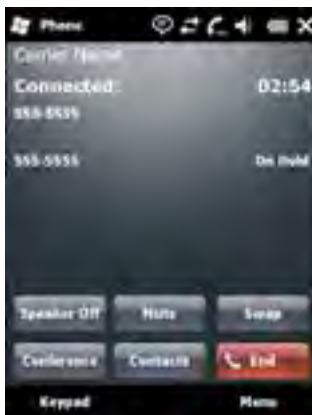

Figure 4-28 Call Conferencing - Conferencing

5. Tap **Swap** to move from one call to the other.
6. Tap **End** or press the red phone key on the MC75A keypad to end each call.

Swapping Calls on an MC75A8

To swap between two incoming phone calls:

1. Tap **Answer** to connect to the first call.

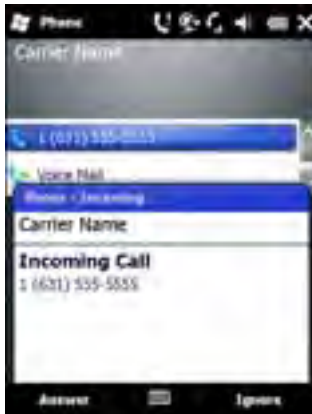

Figure 4-29 Answer a Call

2. When a second call arrives, tap **Answer**. The first call is placed on hold.
3. Tap **Talk** to swap from one call to the other.

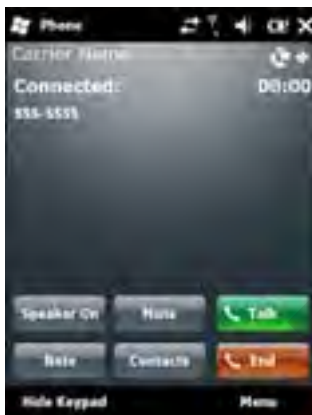

Figure 4-30 Call Swapping

4. Tap **End** or press the red phone key on the MC75A keypad to end active call. The remaining call re-connects, tap **Answer** to connect to the call.
5. Tap **End** or press the red phone key on the MC75A keypad to end the last call.

Conference Calling on an MC75A6

- ✓ **NOTE** Conference Calling and the number of conference calls allowed may not be available on all services. Please check with your service provider for Conference Calling availability.

To create a conference phone session with multiple people:

1. Tap **Start** > **Phone** or press the green phone key on the MC75A's keypad to display the Phone keypad.
2. Enter the first phone number and press **Talk**. When the call connects, **Hold** appears on the keypad.

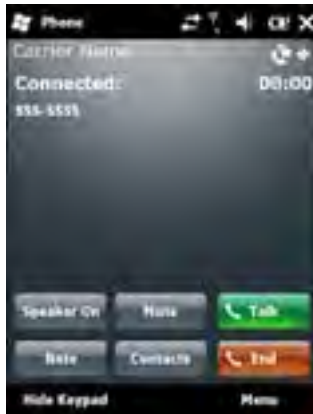

Figure 4-31 Conference Call - Hold

3. Tap **Hold** to place the first call on hold.
4. Enter the second phone number and tap **Talk**.
5. After the call is answered, tap **Menu** > **Conference** to place the calls in conference mode.

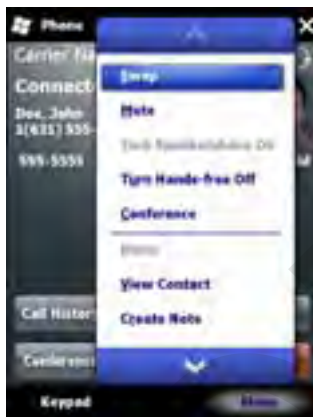

Figure 4-32 Creating a Conference Call

6. Tap **Hold** to place the conference on hold.
7. Enter another phone number and tap **Talk**.
8. After the call is answered, tap **Menu** > **Conference** to place all the calls in conference mode.
9. Repeat steps 6 through 8 for up to six phone numbers.
10. Tap **End** or press the red phone key on the MC75A keypad to end the conference call.

✓ **NOTE** To speak privately with one party during a conference call, tap **Menu** > **Private**. To include all parties again, tap **Menu** > **Conference**.

Three-way Calling on an MC75A8

✓ **NOTE** Three-way Calling may not be available on all services. Please check with your service provider for availability.

To create a three-way phone session with two people and you as the initiator:

1. Tap **Start** > **Phone** or press the green phone key on the MC75A's keypad to display the Phone keypad.
2. Enter the first phone number and press **Talk**.
3. To call a second person, tap **Keypad**. Enter the second number and tap **Talk**.

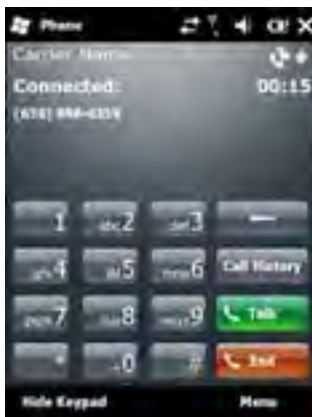

Figure 4-33 Calling Another Person

4. When the second person answers the call, tap **Talk** to create a three-way calling session.
5. Tap **Talk** to drop the last call.
6. Tap **End** to drop the first call.

Text Messaging

Use the **Text Messages** window to send and receive text messages to and from mobile phones. The text can contain words, numbers, or an alphanumeric combination no longer than 160 characters.

Short text messages delivered over mobile networks transmit from the sending MC75A, are stored in a central short message center, then forwarded to the destination mobile device. If the recipient is not available, the message is stored and can be sent later.

Viewing Text Messages

To view a text message:

You can view a text message whether the phone is on or off. When the phone is on, you can view a text message from its notification callout. Tap the **text message notification** icon on the navigation bar to display the message.

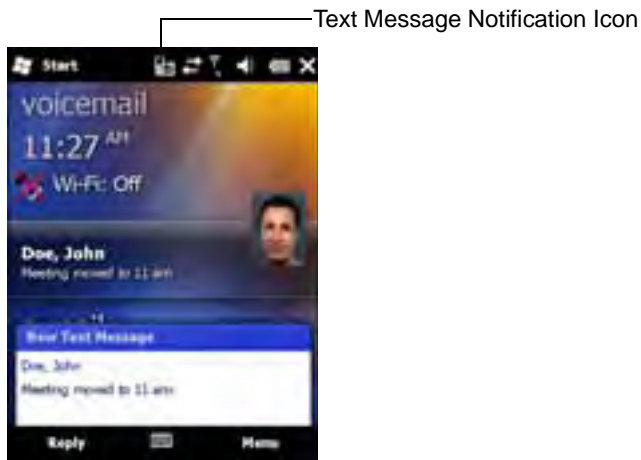

Figure 4-34 *New Text Message Notification*

The Caller Identification feature matches incoming text message numbers with those stored in **Contacts** so you know who is sending you a message. Furthermore, the **New Text Message** dialog box gives you the option to call the sender or save, dismiss, or delete the message.



Figure 4-35 *New Text Message Options*

When the phone function is off, you can still view received text message in Messaging:

1. Tap **Start > Text** or on the Today screen, tap the text message on the Information Bar.

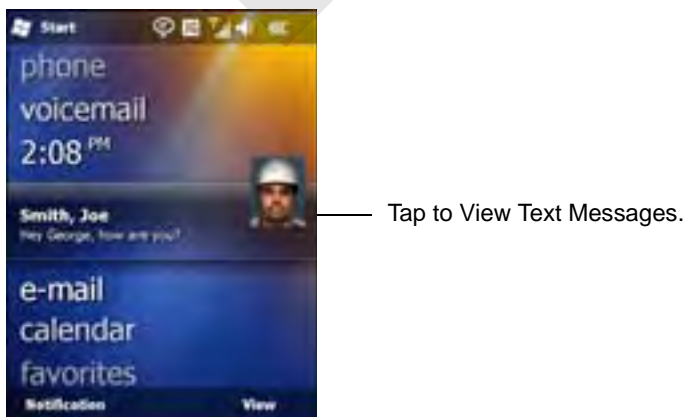

Figure 4-36 *Text Messaging on Today Screen*

2. The **Text Messages** window appears.
3. In the message list, tap the text message.

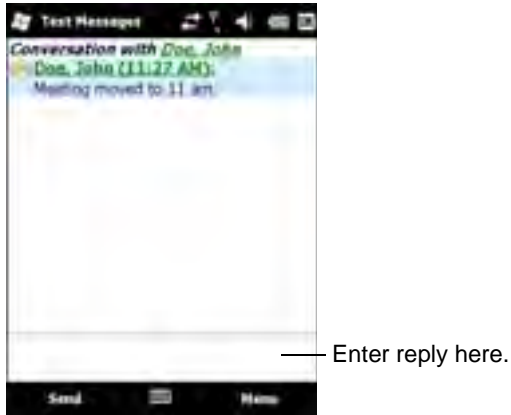

Figure 4-37 Text Messages List

- ✓ **NOTE** If the phone is turned off and you tried to call the sender, send a reply, or forward the message, you are prompted to turn the phone function on.

Sending a Text Message

To create a text message:

1. On the **Phone** screen, select a contact name that you want to send a message to.
2. Tap **Menu > Send Text Message**.

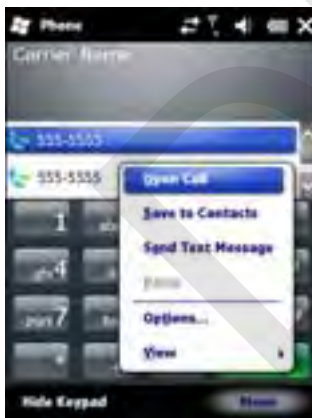

Figure 4-38 Phone Screen Contact List

3. Compose your message.



Figure 4-39 Create Text Message

- The auto-correct feature automatically fixes common spelling errors as you type so your messages are more accurate.
 - The character counter lets you see and control the size of the message as you compose.
 - If you want to know if your text message was received, tap **Menu > Message Options**, then select the **Request message delivery notification** check box.
4. Tap **Send** when you've finished the message.
- If the phone is turned on, your text message is sent. If it's off, you are prompted to turn on the phone. If you do so, the message is sent; otherwise when you tap **OK**, the message is saved in the **Drafts** folder and sent when the phone is turned on.

If you are out of coverage area, the message is saved in the **Drafts** folder and sent when you return to a coverage area.

- ✓ **NOTE** On MC75A6 devices, the message remains in the **Drafts** folder and has to be manually re-sent when you return to a coverage area.

Using a Dual Line SIM

- ✓ **NOTE** Dual Line SIM support is only available on MC75A6 configurations.
Check with your service provider for availability.

Dual line SIM cards allow for two phone lines on a single card. For example, one line can be a business phone line and the other a personal phone line.

To switch between phone lines:

1. Tap **Start > Programs > SIM Toolkit**.



Figure 4-40 SIM UI Window

2. Select **Dual** and then tap **Select**.

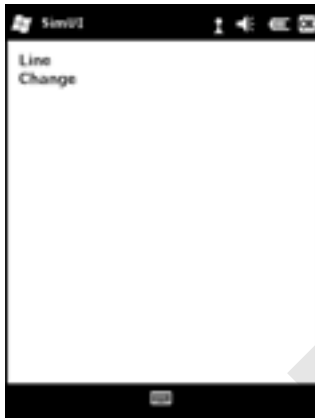

Figure 4-41 Change Phone Line

3. Select **Change** and then tap **Select**.
4. If applicable, sign in with the PIN number for the other line.

DRAFT

Chapter 5 Using GPS Navigation

Introduction

The MC75A includes Global Positioning System (GPS) technology using the SiRF III chipset. GPS technology is based on a worldwide system of GPS satellites orbiting the earth that continuously transmit digital radio signals. These radio signals contain data on the satellites' locations and their exact clock time and are used to determine your location on the earth.



WARNING! When using the MC75A in a vehicle, it is the user's responsibility to place, secure and use in a manner that will not cause accidents, personal injury or property damage or obstruct their view. It is the responsibility of the driver to operate the vehicle in a safe manner, maintain observation of all driving conditions at all times, and not become distracted by the device to the exclusion of safe driving practices. It is unsafe to operate the controls of the device while driving.

Software Installation

Third-party GPS navigation software is required. Evaluation software is available from various suppliers. For example; VisualGPS, visit: <http://www.visualgps.net/VisualGPSce/>

If interested in purchasing GPS navigation software check with the GPS software vendor (before purchasing, downloading, or installing any software) to determine that the application is compatible with the MC75A. Refer to the application's user guide for application installation and setup information.

MC75A GPS Setup

The GPS-enabled MC75A operating system automatically manages access to the GPS receiver to allow multiple programs to simultaneously access GPS data.

By default, the MC75A has the following settings:

1. Tap **Start > Settings > System > External GPS** icon.
2. In the **Programs** tab, the **GPS program port** is set to **COM8**.
3. In the **Hardware** tab, the **GPS hardware port** is set to **GMX1**.

Operation

Acquiring satellite signals may take a few minutes. It is best to be outside and have a clear, unobstructed view of the sky. Without a clear view, acquisition takes much longer and could result in the MC75A being unable to compute the initial position quickly. When operating the device indoors access to the GPS signals may be limited or unavailable.

- ✓ **NOTE** When using a GPS navigation application, ensure that the MC75A does not go into suspend mode. If the MC75A suspends then the power to the GPS radio is removed. Upon resume the GPS receiver must reacquire a valid GPS signal, resulting in a delay of positional information.

GPS Maps on microSD Cards

GPS navigation software vendors may sell maps on microSD cards. If using a microSD card with the GPS navigation software:

1. Remove the Memory Card Cover on the side of the MC75A.
2. Insert the microSD card into the slot.
3. Replace the Memory Card Cover.

Answering a Phone Call While Using GPS

If you receive a phone call while using your GPS navigation software:

1. Answer the phone call by pressing the **Answer** button.
2. Once you end the phone call, press the **End Call** button to resume the audio on the GPS software.

- ✓ **NOTE** Anytime you are using GPS on the MC75A and you receive a phone call, the audio on the GPS navigation software is muted until you finish the call.

Losing the GPS Signal While in a Vehicle

GPS performance on the MC75A may be affected if the vehicle has thermal glass windows and windshields, which can block the MC75A from receiving a GPS signal from satellites. To improve GPS signal strength, place the MC75A where there is a clear view of the sky. A direct line of sight is required between the MC75A and the GPS satellites to access information from the satellites.

The Global Positioning System (GPS) is a system that allows the user to track their position anywhere on the earth.

Assisted GPS

GPS can be used in stand-alone or Assisted GPS (A-GPS) modes. A Stand-alone GPS receiver downloads data from GPS satellites. It can take several minutes to get a fix. By using GPS Location servers, A-GPS dramatically improves the performance of the Time To First Fix (TTFF) of GPS receivers by providing them with data that they would ordinarily have to download from the GPS satellites. With the A-GPS data, GPS receivers can operate faster and more reliably.

A-GPS follows the Secure User Plane Location (SUPL) protocol which allows the MC75A to communicate with a location server.



Figure 5-1 SUPL Setup Tab

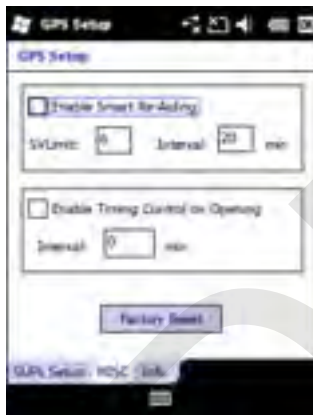

Figure 5-2 MISC Tab

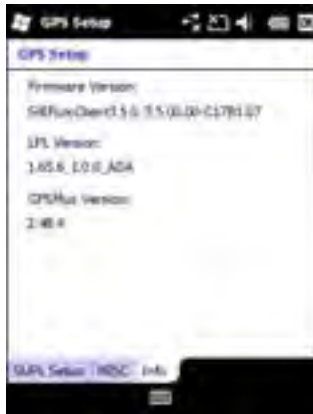

Figure 5-3 Info Tab

DRAFT

Chapter 6 Using Bluetooth

Introduction

Bluetooth-equipped devices can communicate without wires, using frequency-hopping spread spectrum (FHSS) radio frequency (RF) to transmit and receive data in the 2.4 GHz Industry Scientific and Medical (ISM) band (802.15.1). Bluetooth wireless technology is specifically designed for short-range (30 feet/10 meters) communication and low power consumption.

MC75As with Bluetooth capabilities can exchange information (e.g., files, appointments, and tasks) with other Bluetooth enabled devices such as phones, printers, access points, and other mobile computers. To use the MC75A as a modem, create a dial-up modem connection between a computer and MC75A.

The MC75A with Bluetooth technology uses either the StoneStreet Bluetooth stack or the Microsoft Bluetooth stack. To write an application that uses the StoneStreet One Bluetooth stack APIs, refer to the Enterprise Mobility Developer Kit (EMDK) Help.

Adaptive Frequency Hopping

Adaptive Frequency Hopping (AFH) is a method of avoiding fixed frequency interferers, and can be used with Bluetooth voice. All devices in the piconet (Bluetooth network) must be AFH-capable in order for AFH to work. There is no AFH when connecting and discovering devices. Avoid making Bluetooth connections and discoveries during critical 802.11b communications. AFH for Bluetooth consists of four main sections:

- Channel Classification - A method of detecting an interference on a channel-by-channel basis, or pre-defined channel mask.
- Link Management - Coordinates and distributes the AFH information to the rest of the Bluetooth network.
- Hop Sequence Modification - Avoids interference by selectively reducing the number of hopping channels.
- Channel Maintenance - A method for periodically re-evaluating the channels.

When AFH is enabled, the Bluetooth radio “hops around” (instead of through) the 802.11b high-rate channels. AFH coexistence allows Motorola mobile computers to operate in any infrastructure.

The Bluetooth radio in this MC75A operates as a Class 2 device power class. The maximum output power is 2.5mW and the expected range is 32.8 feet (10 meters). A definition of ranges based on power class is difficult to obtain due to power and device differences, and whether one measures open space or closed office space.

- ✓ **NOTE** It is not recommended to perform Bluetooth wireless technology inquiry when high rate 802.11b operation is required.

Security

The current Bluetooth specification defines security at the link level. Application-level security is not specified. This allows application developers to define security mechanisms tailored to their specific need. Link-level security occurs between devices, not users, while application-level security can be implemented on a per-user basis. The Bluetooth specification defines security algorithms and procedures needed to authenticate devices, and if needed, encrypt the data flowing on the link between the devices. Device authentication is a mandatory feature of Bluetooth while link encryption is optional.

Pairing of Bluetooth devices is accomplished by creating an initialization key that is used to authenticate the devices and create a link key for them. Entering a common PIN number in the devices being paired generates the initialization key. The PIN number is never sent over the air. By default, the Bluetooth stack responds with no key when a key is requested (it is up to user to respond to the key request event). Authentication of Bluetooth devices is based-upon a challenge-response transaction. Bluetooth allows for a PIN number or passkey that is used to create other 128-bit keys used for security and encryption. The encryption key is derived from the link key used to authenticate the pairing devices. Also worthy of note is the limited range and fast frequency hopping of the Bluetooth radios that makes long-distance eavesdropping difficult.

Recommendations are:

- Perform pairing in a secure environment
- Keep PIN codes private and don't store the PIN codes in the mobile computer
- Implement application-level security.

The Microsoft stack supports Smart-pairing. For detailed information, refer to the Microsoft MSDN.

The StoneStreet One Bluetooth stack supports Secure Simple Pairing. Secure Simple Pairing improves the pairing experience for Bluetooth devices and increasing the use and strength of security. Both the host and the remote device must support Secure Simple Pairing. If one device does not, standard pairing will be used, as described above.