



SAR TEST REPORT (15.407)

REPORT NO.: SA970216L05A-2

MODEL NO.: MC7598

RECEIVED: Jun. 13, 2008

TESTED: Jul. 04, 2008

ISSUED: Jul. 17, 2008

APPLICANT: Symbol Technologies, Inc.

ADDRESS: One Symbol Plaza, Holtsville, NY 11742-1300
USA

ISSUED BY: Advance Data Technology Corporation

LAB ADDRESS: 47 14th Ling, Chia Pau Tsuen, Lin Kou Hsiang
244, Taipei Hsien, Taiwan, R.O.C.

TEST LOCATION: No. 19, Hwa Ya 2nd Rd., Wen Hwa Tsuen, Kwei
Shan Hsiang, Taoyuan Hsien 333, Taiwan,
R.O.C.

This test report consists of 36 pages in total except Appendix. It may be duplicated completely for legal use with the approval of the applicant. It should not be reproduced except in full, without the written approval of our laboratory. The client should not use it to claim product endorsement by TAF, A2LA or any government agencies. The test results in the report only apply to the tested sample.





TABLE OF CONTENTS

1.	CERTIFICATION	3
2.	GENERAL INFORMATION.....	4
2.1	GENERAL DESCRIPTION OF EUT	4
2.2	GENERAL DESCRIPTION OF APPLIED STANDARDS	6
2.3	GENERAL INFORMATION OF THE SAR SYSTEM	7
2.4	GENERAL DESCRIPTION OF THE SPATIAL PEAK SAR EVALUATION.....	10
3.	DESCRIPTION OF SUPPORT UNITS	13
4.	DESCRIPTION OF TEST MODES AND CONFIGURATIONS	14
4.1.	DESCRIPTION OF TEST MODE	14
4.2.	SUMMARY OF TEST RESULTS	15
5.	TEST RESULTS	16
5.1	TEST PROCEDURES	16
5.2	MEASURED SAR RESULTS.....	18
5.3	SAR LIMITS.....	19
5.4	RECIPES FOR TISSUE SIMULATING LIQUIDS	20
5.5	TEST EQUIPMENT FOR TISSUE PROPERTY	23
6.	SYSTEM VALIDATION	24
6.1	TEST EQUIPMENT	24
6.2	TEST PROCEDURE.....	25
6.3	VALIDATION RESULTS	27
6.4	SYSTEM VALIDATION UNCERTAINTIES	28
7.	MEASUREMENT SAR PROCEDURE UNCERTAINTIES.....	29
7.1.	PROBE CALIBRATION UNCERTAINTY	29
7.2.	ISOTROPY UNCERTAINTY	30
7.3.	BOUNDARY EFFECT UNCERTAINTY	30
7.4.	PROBE LINEARITY UNCERTAINTY	31
7.5.	READOUT ELECTRONICS UNCERTAINTY	31
7.6.	RESPONSE TIME UNCERTAINTY	31
7.7.	INTEGRATION TIME UNCERTAINTY	32
7.8.	PROBE POSITIONER MECHANICAL TOLERANCE	33
7.9.	PROBE POSITIONING	33
7.10.	PHANTOM UNCERTAINTY	34
7.11.	DASY4 UNCERTAINTY BUDGET (FOR 5 ~ 6GHz).....	35
8.	INFORMATION ON THE TESTING LABORATORIES	36
	APPENDIX A: TEST CONFIGURATIONS AND TEST DATA	
	APPENDIX B: ADT SAR MEASUREMENT SYSTEM	
	APPENDIX C: PHOTOGRAPHS OF SYSTEM VALIDATION	
	APPENDIX D: SYSTEM CERTIFICATE & CALIBRATION	



1. CERTIFICATION

PRODUCT: EDA (Enterprise Digital Assistant)
MODEL: MC7598
BRAND: Symbol
APPLICANT: Symbol Technologies, Inc.
TESTED : Jul. 04, 2008
TEST SAMPLE: PROTOTYPE
STANDARDS: **FCC Part 2 (Section 2.1093)**
FCC OET Bulletin 65, Supplement C (01-01)
RSS-102
IEEE 1528-2003

The above equipment (model: MC7598) have been tested by **Advance Data Technology Corporation**, and found compliance with the requirement of the above standards. The test record, data evaluation & Equipment Under Test (EUT) configurations represented herein are true and accurate accounts of the measurements of the sample's EMC characteristics under the conditions specified in this report.

PREPARED BY : Wendy Liao , **DATE:** Jul. 17, 2008
Wendy Liao / Senior Specialist

TECHNICAL ACCEPTANCE : James Fan , **DATE:** Jul. 17, 2008
Responsible for RF
James Fan / Engineer

APPROVED BY : Gary Chang , **DATE:** Jul. 17, 2008
Gary Chang / Assistant Manager

2. GENERAL INFORMATION

2.1 GENERAL DESCRIPTION OF EUT

PRODUCT	EDA (Enterprise Digital Assistant)
MODEL NO.	MC7598
FCC ID	H9PMC7598
POWER SUPPLY	3.7Vdc from rechargeable lithium battery 5.4Vdc from power adapter
CLASSIFICATION	Portable device, production unit
MODULATION TYPE	CCK, DQPSK, DBPSK for DSSS 64QAM, 16QAM, QPSK, BPSK for OFDM
RADIO TECHNOLOGY	DSSS, OFDM
TRANSFER RATE	54, 48, 36, 24, 18, 12, 9, 6Mbps
FREQUENCY RANGE	5150 ~ 5350MHz & 5470 ~ 5725MHz
NUMBER OF CHANNEL	5150 ~ 5350MHz: 8 5470 ~ 5725MHz: 11
CHANNEL FREQUENCIES UNDER TEST AND ITS CONDUCTED OUTPUT POWER	12.94mW / Ch40: 5200MHz 16.41mW / Ch64: 5320MHz 27.10mW / Ch124: 5620MHz
AVERAGE SAR (1g)	Body: 0.058W/kg
ANTENNA TYPE(S)	Inverted F antenna Planar inverted antenna
MAX. ANTENNA GAIN	3.5dBi
DATA CABLE	Refer to NOTE
I/O PORTS	Refer to user's manual
ACCESSORY DEVICES	Battery

NOTE:

1. This report is prepared for FCC class II permissive change. Difference compared with the original report is listed as below, therefore we only re-tested for body part test item in the report.

ITEM	ORIGINAL DESCRIPTION	CLASS II CHANGE DESCRIPTION
1	-	Adding Pouch

2. The models as identified below are identical to each other except of the following options:

- Keypad: Numeric / QWERTY
- Barcode reader: 1D laser scanner / 2D Imager

BRAND	MODEL	DESCRIPTION
Symbol	MC7598	EVDO 1D Numeric
Symbol	MC7598	EVDO 2D QWERTY

**the worst case had been marked by boldface.

3. The EUT is an EDA (Enterprise Digital Assistant). The functions of EUT listed as below:

	REFERENCE REPORT
WLAN 802.11a/b/g (15.247)	SA970216L05A-1
WLAN 802.11a (15.407)	SA970216L05A-2
CDMA 850 + CDMA 1900	SA970216L05A
MOBILE +WLAN + BT (CO-LOCATED)	SA970216L05A-6

4. The communicated functions of EUT listed as below:

		850MHz	1900MHz	With 802.11a/b/g + Bluetooth + GPS functions
3G	CDMA	√	√	
	EVDO	√	√	

5. The EUT has one lithium battery listed as below:

LI-LON BATTERY	
BRAND:	MOTOROLA
MODEL:	82-71364-05 Rev A
RATING:	3.7Vdc, 3600mAh

6. The following accessories are for support units only.

PRODUCT	BRAND	MODEL	DESCRIPTION
RS232 charging cable	Motorola	25-102776-01R	1.2m non-shielded cable with one core
USB charging cable	Motorola	25-102775-01R	1.5m shielded cable with one core
Headset	Motorola	50-11300-050R	VR10 headset 0.8m non-shielded cable with one core
Power Supply Adaptor	Motorola	EADP-16BB A	I/P: 100-240Vac, 50-60Hz, 0.4A O/P: 5.4Vdc, 3A 1.8m non-shielded cable without core
Holster	Motorola	SG-MC7011110-01R	Ridged holster
		11-77969-01R	

7. Hardware version: MV.

8. Software version: BSP16.

9. The above EUT information was declared by manufacturer and for more detailed features description, please refer to the manufacturer's specifications or User's Manual.



2.2 GENERAL DESCRIPTION OF APPLIED STANDARDS

According to the specifications of the manufacturer, this product must comply with the requirements of the following standards:

FCC Part 2 (2.1093)

FCC OET Bulletin 65, Supplement C (01- 01)

RSS-102

IEEE 1528-2003

All test items have been performed and recorded as per the above standards.

2.3 GENERAL INFORMATION OF THE SAR SYSTEM

DASY4 (software 4.7 Build 53) consists of high precision robot, probe alignment sensor, phantom, robot controller, controlled measurement server and near-field probe. The robot includes six axes that can move to the precision position of the DASY4 software defined. The DASY4 software can define the area that is detected by the probe. The robot is connected to controlled box. Controlled measurement server is connected to the controlled robot box. The DAE includes amplifier, signal multiplexing, AD converter, offset measurement and surface detection. It is connected to the Electro-optical coupler (ECO). The ECO performs the conversion from the optical into digital electric signal of the DAE and transfers data to the PC.

EX3DV3 ISOTROPIC E-FIELD PROBE (FREQUENCY BAND 5 ~ 6GHz)

DIMENSIONS

Overall length: 330 mm (Tip Length: 20 mm)
Tip diameter: 2.5 mm (Body diameter: 12 mm)
Distance from probe tip to dipole centers: 1.0 mm

APPLICATION

General dosimetric measurements range 5 ~ 6 GHz.
Fast automatic scanning in arbitrary phantoms (EX3DV3)

NOTE

1. The Probe parameters have been calibrated by the SPEAG. Please reference "APPENDIX D" for the Calibration Certification Report.
2. For frequencies above 800 MHz, calibration in a rectangular wave-guide is used, because wave-guide size is manageable.
3. For frequencies below 800 MHz, temperature transfer calibration is used because the wave-guide size becomes relatively large.



TWIN SAM V4.0

CONSTRUCTION

The shell corresponds to the specifications of the Specific Anthropomorphic Mannequin (SAM) phantom defined in IEEE 1528-2003, EN 62209-1 and IEC 62209. It enables the dosimetric evaluation of left and right hand phone usage as well as body mounted usage at the flat phantom region. A cover prevents evaporation of the liquid. Reference markings on the phantom allow the complete setup of all predefined phantom positions and measurement grids by manually teaching three points with the robot.

SHELL THICKNESS

2 ± 0.2mm

FILLING VOLUME

Approx. 25liters

DIMENSIONS

Height: 810mm; Length: 1000mm; Width: 500mm

SYSTEM VALIDATION KITS:

CONSTRUCTION

Symmetrical dipole with 1/4 balun enables measurement of feedpoint impedance with NWA matched for use near flat phantoms filled with brain simulating solutions. Includes distance holder and tripod adaptor

CALIBRATION

Calibrated SAR value for specified position and input power at the flat phantom in brain simulating solutions

FREQUENCY

5200, 5500, 5800MHz

RETURN LOSS

> 20dB at specified validation position

POWER CAPABILITY

> 100W (f < 1GHz); > 40W (f > 1GHz)

OPTIONS

Dipoles for other frequencies or solutions and other calibration conditions upon request

DEVICE HOLDER FOR SAM TWIN PHANTOM

CONSTRUCTION

The device holder for the mobile phone device is designed to cope with different positions given in the standard. It has two scales for the device rotation (with respect to the body axis) and the device inclination (with respect to the line between the ear reference points). The rotation centers for both scales is the ear reference point (ERP). Thus the device needs no repositioning when changing the angles. The holder has been made out of low-loss POM material having the following dielectric parameters: relative permittivity $\epsilon = 3$ and loss tangent $\delta = 0.02$. The amount of dielectric material has been reduced in the closest vicinity of the device, since measurements have suggested that the influence of the clamp on the test results could thus be lowered. The device holder for the portable device makes up of the polyethylene foam. The dielectric parameters of material close to the dielectric parameters of the air.

DATA ACQUISITION ELECTRONICS

CONSTRUCTION

The data acquisition electronics (DAE3) consists of a highly sensitive electrometer grade preamplifier with auto-zeroing, a channel and gain-switching multiplex, a fast 16 bit AD converter and a command decoder and control logic unit. Transmission to the measurement server is accomplished through an optical downlink for data and status information as well as an optical uplink for commands and the clock. The mechanical probe is mounting device includes two different sensor systems for frontal and sideways probe contacts. They are used for mechanical surface detection and probe collision detection. The input impedance of the DAE3 box is 200M Ω ; the inputs are symmetrical and floating. Common mode rejection is above 80 dB.

2.4 GENERAL DESCRIPTION OF THE SPATIAL PEAK SAR EVALUATION

The DASY4 post-processing software (SEMCAD) automatically executes the following procedures to calculate the field units from the micro-volt readings at the probe connector. The parameters used in the evaluation are stored in the configuration modules of the software:

Probe parameters:	- Sensitivity	Norm _i , a _{i0} , a _{i1} , a _{i2}
	- Conversion factor	ConvF _i
	- Diode compression point	dcp _i
Device parameters:	- Frequency	F
	- Crest factor	Cf
Media parameters:	- Conductivity	σ
	- Density	ρ

The first step of the evaluation is a linearization of the filtered input signal to account for the compression characteristics of the detector diode. The compensation depends on the input signal, the diode type and the DC-transmission factor from the diode to the evaluation electronics. If the exciting field is pulsed, the crest factor of the signal must be known to correctly compensate for peak power. The formula for each channel can be given as:

$$V_i = U_i + U_i^2 \cdot \frac{cf}{dcp_i}$$

V _i	=compensated signal of channel i	(i = x, y, z)
U _i	=input signal of channel I	(i = x, y, z)
Cf	=crest factor of exciting field	(DASY parameter)
dcp _i	=diode compression point	(DASY parameter)

From the compensated input signals the primary field data for each channel can be evaluated:

$$\text{E-field probes: } E_i = \sqrt{\frac{V_i}{\text{Norm}_i \cdot \text{ConvF}}}$$

$$\text{H-field probes: } H_i = \sqrt{V_i} \cdot \frac{a_{i0} + a_{i1}f + a_{i2}f^2}{f}$$

- V_i = compensated signal of channel I (i = x, y, z)
- Norm_i = sensor sensitivity of channel i $\mu\text{V}/(\text{V/m})^2$ for E-field Probes (i = x, y, z)
- ConvF = sensitivity enhancement in solution
- a_{ij} = sensor sensitivity factors for H-field probes
- f = carrier frequency [GHz]
- E_i = electric field strength of channel i in V/m
- H_i = magnetic field strength of channel i in A/m

The RSS value of the field components gives the total field strength (Hermitian magnitude):

$$E_{tot} = \sqrt{E_x^2 + E_y^2 + E_z^2}$$

The primary field data are used to calculate the derived field units.

$$SAR = E_{tot}^2 \cdot \frac{\sigma}{\rho \cdot 1'000}$$

- SAR = local specific absorption rate in mW/g
- E_{tot} = total field strength in V/m
- σ = conductivity in [mho/m] or [Siemens/m]
- ρ = equivalent tissue density in g/cm³



Note that the density is set to 1, to account for actual head tissue density rather than the density of the tissue simulating liquid. The entire evaluation of the spatial peak values is performed within the Post-processing engine (SEMCAD). The system always gives the maximum values for the 1g and 10g cubes. The algorithm to find the cube with highest averaged SAR is divided into the following stages:

1. The extraction of the measured data (grid and values) from the Zoom Scan
2. The calculation of the SAR value at every measurement point based on all stored data (A/D values and measurement parameters)
3. The generation of a high-resolution mesh within the measured volume
4. The interpolation of all measured values from the measurement grid to the high-resolution grid
5. The extrapolation of the entire 3-D field distribution to the phantom surface over the distance from sensor to surface
6. The calculation of the averaged SAR within masses of 1g and 10g.

The probe is calibrated at the center of the dipole sensors that is located 1 to 2.7mm away from the probe tip. During measurements, the probe stops shortly above the phantom surface, depending on the probe and the surface detecting system. Both distances are included as parameters in the probe configuration file. The software always knows exactly how far away the measured point is from the surface. As the probe cannot directly measure at the surface, the values between the deepest measured point and the surface must be extrapolated. The angle between the probe axis and the surface normal line is less than 30 degree.

In the Area Scan, the gradient of the interpolation function is evaluated to find all the extreme of the SAR distribution. The uncertainty on the locations of the extreme is less than 1/20 of the grid size. Only local maximum within -2dB of the global maximum are searched and passed for the Cube Scan measurement. In the Cube Scan, the interpolation function is used to extrapolate the Peak SAR from the lowest measurement points to the inner phantom surface (the extrapolation distance). The uncertainty increases with the extrapolation distance. To keep the uncertainty within 1% for the 1g and 10g cubes, the extrapolation distance should not be larger than 5mm.

The maximum search is automatically performed after each area scan measurement. It is based on splines in two or three dimensions. The procedure can find the maximum for most SAR distributions even with relatively large grid spacing. After the area scanning measurement, the probe is automatically moved to a position at the interpolated maximum. The following scan can directly use this position for reference, e.g., for a finer resolution grid or the cube evaluations. The 1g and 10g peak evaluations are only available for the predefined cube 7 x 7 x 7 scans. The routines are verified and optimized for the grid dimensions used in these cube measurements. The measured volume of 30 x 30 x 30mm contains about 30g of tissue. The first procedure is an extrapolation (incl. boundary correction) to get the points between the lowest measured plane and the surface. The next step uses 3D interpolation to get all points within the measured volume in a 1mm grid (42875 points). In the last step, a 1g cube is placed numerically into the volume and its averaged SAR is calculated. This cube is moved around until the highest averaged SAR is found. If the highest SAR is found at the edge of the measured volume, the system will issue a warning: higher SAR values might be found outside of the measured volume. In that case the cube measurement can be repeated, using the new interpolated maximum as the center.

3. DESCRIPTION OF SUPPORT UNITS

The EUT has been tested as an independent unit.

4. DESCRIPTION OF TEST MODES AND CONFIGURATIONS

4.1. DESCRIPTION OF TEST MODE

TEST MODE	COMMUNICATION MODE	MODULATION TYPE	ASSESSMENT POSITION	TESTED CHANNEL
1	802.11a	BPSK	Body / Bottom	40, 64, 124

4.2. SUMMARY OF TEST RESULTS

ITEM		1
PART OF ASSESSMENT		BODY POSITION
TEST MODE		802.11a
CHAN.	FREQ. (MHz)	MEASURED VALUE OF 1g SAR (W/kg)
40	5200	0.049
64	5320	0.058
124	5620	0.051

NOTE: The worst value has been marked by boldface.

5. TEST RESULTS

5.1 TEST PROCEDURES

Use the software to control the EUT channel and transmission power. Then record the conducted power before the testing. Place the EUT to the specific test location. After the testing, must writing down the conducted power of the EUT into the report. The SAR value was calculated via the 3D spline interpolation algorithm that has been implemented in the software of DASY4 SAR measurement system manufactured and calibrated by SPEAG. According to the IEEE 1528 standards, the recommended procedure for assessing the peak spatial-average SAR value consists of the following steps:

- Power reference measurement
- Verification of the power reference measurement
- Area scan
- Zoom scan
- Power reference measurement

The area scan was performed for the highest spatial SAR location. The zoom scan with 30mm x 30mm x 30mm volume was performed for SAR value averaged over 1g and 10g spatial volumes.

In the zoom scan, the distance between the measurement point at the probe sensor location (geometric center behind the probe tip) and the phantom surface is 4.0mm and maintained at a constant distance of ± 1.0 mm during a zoom scan to determine peak SAR locations. The distance is 4mm between the first measurement point and the bottom surface of the phantom. The secondary measurement point to the bottom surface of the phantom is with 9mm separation distance. The cube size is 7 x 7 x 7 points consist of 343 points and the grid space is 5mm.

The measurement time is 0.5s at each point of the zoom scan. The probe boundary effect compensation shall be applied during the SAR test. Because of the tip of the probe to the Phantom surface separated distances are longer than half a tip probe diameter.

In the area scan, the separation distance is 4mm between the each measurement point and the phantom surface. The scan size shall be included the transmission portion of the EUT. The measurement time is the same as the zoom scan. At last the reference power drift shall be less than $\pm 5\%$.

5.2 MEASURED SAR RESULTS

BODY POSITION

ENVIRONMENTAL CONDITION		Air Temperature : 23.9°C, Liquid Temperature : 22.6°C Humidity : 60%RH					
TESTED BY		Sam Onn			DATE		Jul. 04, 2008
CHAN.	FREQ. (MHz)	TEST MODE	CONDUCTED POWER (mW)		POWER DRIFT (%)	DEVICE TEST POSITION MODE	MEASURED 1g SAR (W/kg)
			BEGIN TEST	AFTER TEST			
40	5200	802.11a	12.94	12.76	-1.39	1	0.049
64	5320	802.11a	16.41	16.16	-1.52	1	0.058
124	5620	802.11a	27.10	26.68	-1.55	1	0.051

NOTE:

1. Test configuration of each mode is described in section 3.
2. In this testing, the limit for General Population Spatial Peak averaged over 1g, **1.6 W/kg**, is applied.
3. Please see the Appendix A for the data.
4. The variation of the EUT conducted power measured before and after SAR testing should not over 5%.

5.3 SAR LIMITS

HUMAN EXPOSURE	SAR (W/kg)	
	(GENERAL POPULATION / UNCONTROLLED EXPOSURE ENVIRONMENT)	(OCCUPATIONAL / CONTROLLED EXPOSURE ENVIRONMENT)
Spatial Average (whole body)	0.08	0.4
Spatial Peak (averaged over 1 g)	1.6	8.0
Spatial Peak (hands / wrists / feet / ankles averaged over 10 g)	4.0	20.0

NOTE:

1. This limits accord to 47 CFR 2.1093 – Safety Limit.
2. The EUT property been complied with the partial body exposure limit under the general population environment.

5.4 RECIPES FOR TISSUE SIMULATING LIQUIDS

For the measurement of the field distribution inside the SAM phantom, the phantom must be filled with 25 liters of tissue simulation liquid.

The following ingredients are used :

- **WATER-** Deionized water (pure H₂O), resistivity ≥ 16 M - as basis for the liquid
- **SUGAR-** Refined sugar in crystals, as available in food shops - to reduce relative permittivity
- **SALT-** Pure NaCl - to increase conductivity
- **CELLULOSE-** Hydroxyethyl-cellulose, medium viscosity (75-125mPa.s, 2% in water, 20°C),
CAS # 54290 - to increase viscosity and to keep sugar in solution
- **PRESERVATIVE-** Preventol D-7 Bayer AG, D-51368 Leverkusen, CAS # 55965-84-9 - to prevent the spread of bacteria and molds
- **DGMBE-** Diethylenglycol-monobuthyl ether (DGMBE), Fluka Chemie GmbH, CAS # 112-34-5 - to reduce relative permittivity

THE INFORMATION FOR 5GHz SIMULATING LIQUID

The 5GHz liquids was purchased from SPEAG.

Body liquid model: HSL 5800, P/N: SL AAH 5800 AA

Head liquid model: M 5800, P/N: SL AAM 580 AD

5GHz liquids contain the following ingredients:

Water 64 - 78%

Mineral Oil 11 - 18%

Emulsifiers 9 - 15%

Additives and Salt 2 - 3%

Testing the liquids using the Agilent Network Analyzer E8358A and Agilent Dielectric Probe Kit 85070D. The testing procedure is following as

1. Turn Network Analyzer on and allow at least 30min. warm up.
2. Mount dielectric probe kit so that interconnecting cable to Network Analyzer will not be moved during measurements or calibration.
3. Pour de-ionized water and measure water temperature ($\pm 1^\circ$).
4. Set water temperature in Agilent-Software (Calibration Setup).
5. Perform calibration.
6. Validate calibration with dielectric material of known properties (e.g. polished ceramic slab with $>8\text{mm}$ thickness $\epsilon' = 10.0$, $\epsilon'' = 0.0$). If measured parameters do not fit within tolerance, repeat calibration (± 0.2 for ϵ' : ± 0.1 for ϵ'').
7. Conductivity can be calculated from ϵ'' by $\sigma = \omega \epsilon_0 \epsilon'' = \epsilon'' f [\text{GHz}] / 18$.
8. Measure liquid shortly after calibration. Repeat calibration every hour.
9. Stir the liquid to be measured. Take a sample ($\sim 50\text{ml}$) with a syringe from the center of the liquid container.
10. Pour the liquid into a small glass flask. Hold the syringe at the bottom of the flask to avoid air bubbles.
11. Put the dielectric probe in the glass flask. Check that there are no air bubbles in front of the opening in the dielectric probe kit.
12. Perform measurements.
13. Adjust medium parameters in DASY4 for the frequencies necessary for the measurements ('Setup Config', select medium (e.g. Brain 900MHz) and press 'Option'-button.
14. Select the current medium for the frequency of the validation (e.g. Setup Medium Brain 900MHz).



FOR WLAN 5GHz BAND SIMULATING LIQUID

LIQUID TYPE		HSL-5800		MSL-5800	
SIMULATING LIQUID TEMP.		NA		22.60	
TEST DATE		NA		Jul. 04, 2008	
TESTED BY		NA		Sam Onn	
FREQ. (MHz)	LIQUID PARAMETER	STANDARD VALUE	MEASUREMENT VALUE	STANDARD VALUE	MEASUREMENT VALUE
5180	Permittivity (ϵ)	NA	NA	49.00	50.00
5200		NA	NA	49.00	50.00
5240		NA	NA	49.00	49.90
5260		NA	NA	48.90	49.80
5300		NA	NA	48.90	49.80
5320		NA	NA	48.90	49.70
5500		NA	NA	48.60	49.30
5620		NA	NA	48.40	49.10
5700		NA	NA	48.30	48.90
5180		Conductivity (σ) S/m	NA	NA	5.28
5200	NA		NA	5.30	5.15
5240	NA		NA	5.35	5.21
5260	NA		NA	5.37	5.24
5300	NA		NA	5.42	5.30
5320	NA		NA	5.44	5.32
5500	NA		NA	5.65	5.58
5620	NA		NA	5.79	5.75
5700	NA		NA	5.88	5.87
Dielectric Parameters Required at 22°C					

5.5 TEST EQUIPMENT FOR TISSUE PROPERTY

ITEM	NAME	BAND	TYPE	SERIES NO.	CALIBRATED UNTIL
1	Network Analyzer	Agilent	E8358A	US41480538	Nov. 11, 2008
2	Dielectric Probe	Agilent	85070D	US01440176	NA

NOTE:

1. Before starting, all test equipment shall be warmed up for 30min.
2. The tolerance (k=1) specified by Agilent for general dielectric measurements, deriving from inaccuracies in the calibration data, analyzer drift, and random errors, are usually $\pm 2.5\%$ and $\pm 5\%$ for measured permittivity and conductivity, respectively. However, the tolerances for the conductivity is smaller for material with large loss tangents, i.e., less than $\pm 2.5\%$ (k=1). It can be substantially smaller if more accurate methods are applied.

6. SYSTEM VALIDATION

The system validation was performed in the flat phantom with equipment listed in the following table. Since the SAR value is calculated from the measured electric field, dielectric constant and conductivity of the body tissue, and the SAR is proportional to the square of the electric field. So, the SAR value will be also proportional to the RF power input to the system validation dipole under the same test environment. In our system validation test, 250mW RF input power was used.

6.1 TEST EQUIPMENT

ITEM	NAME	BAND	TYPE	SERIES NO.	CALIBRATED UNTIL
1	SAM Phantom	S & P	QD000 P40 CA	TP-1150	NA
2	Signal Generator	Anritsu	68247B	984703	May 26, 2009
3	E-Field Probe	Speaq	EX3DV3	3504	Aug. 29, 2008
4	E-Field Probe	Speaq	ET3DV6	1790	Nov. 19, 2008
5	DAE	S & P	DAE	510	Aug. 28, 2008
6	Robot Positioner	Staubli Unimation	NA	NA	NA
7	Validation Dipole	Speaq	D5GHzV2	1019	Jul. 10, 2008

NOTE: Before starting the measurement, all test equipment shall be warmed up for 30min.

6.2 TEST PROCEDURE

Before the system performance check, we need only to tell the system which components (probe, medium, and device) are used for the system performance check; the system will take care of all parameters. The dipole must be placed beneath the flat section of the SAM Twin Phantom with the correct distance holder in place. The distance holder should touch the phantom surface with a light pressure at the reference marking (little cross) and be oriented parallel to the long side of the phantom. Accurate positioning is not necessary, since the system will search for the peak SAR location, except that the dipole arms should be parallel to the surface. The device holder for mobile phones can be left in place but should be rotated away from the dipole.

The "Power Reference Measurement" and "Power Drift Measurement" jobs are located at the beginning and end of the batch process. They measure the field drift at one single point in the liquid over the complete procedure. The indicated drift is mainly the variation of the amplifier output power. If it is too high (above ± 0.1 dB), the system performance check should be repeated; some amplifiers have very high drift during warm-up. A stable amplifier gives drift results in the DASY system below ± 0.02 dB.

The "Surface Check" job tests the optical surface detection system of the DASY system by repeatedly detecting the surface with the optical and mechanical surface detector and comparing the results. The output gives the detecting heights of both systems, the difference between the two systems and the standard deviation of the detection repeatability. Air bubbles or refraction in the liquid due to separation of the sugar-water mixture gives poor repeatability (above ± 0.1 mm). In that case it is better to abort the system performance check and stir the liquid. The difference between the optical surface detection and the actual surface depends on the probe and is specified with each probe. (It does not depend on the surface reflectivity or the probe angle to the surface within $\pm 30^\circ$.) However, varying breaking indices of different liquid compositions might also influence the distance. If the indicated difference varies from the actual setting, the probe parameter "optical surface

The "Area Scan" job measures the SAR above the dipole on a plane parallel to the surface. It is used to locate the approximate location of the peak SAR. The proposed scan uses large grid spacing for faster measurement; due to the symmetric field, the peak detection is reliable. If a finer graphic is desired, the grid spacing can be reduced. Grid spacing and orientation have no influence on the SAR result.

The "Zoom Scan" job measures the field in a volume around the peak SAR value assessed in the previous "Area Scan" job (for more information see the application note on SAR evaluation).

About the validation dipole positioning uncertainty, the constant and low loss dielectric spacer is used to establish the correct distance between the top surface of the dipole and the bottom surface of the phantom, the error component introduced by the uncertainty of the distance between the liquid (i.e., phantom shell) and the validation dipole in the DASY4 system is less than ± 0.1 mm.

$$SAR_{tolerance} [\%] = 100 \times \left(\frac{(a + d)^2}{a^2} - 1 \right)$$

As the closest distance is 10mm, the resulting tolerance $SAR_{tolerance} [\%]$ is <2%.

6.3 VALIDATION RESULTS

VALIDATION TEST IN THE MUSCLE SIMULATING LIQUID					
TEST FREQUENCY (MHz)	REQUIRED SAR (mW/g)	MEASURED SAR (mW/g)	DEVIATION (%)	SEPARATION DISTANCE	TEST DATE
MSL5200	19.50 (1g)	18.80	-3.59	10mm	Jul. 04, 2008
MSL5500	19.80 (1g)	18.90	-4.55	10mm	Jul. 04, 2008
TESTED BY	Sam Onn				

NOTE: Please see Appendix for the photo of system validation test.

6.4 SYSTEM VALIDATION UNCERTAINTIES

In the table below, the system validation uncertainty with respect to the analytically assessed SAR value of a dipole source as given in the IEEE 1528 standard is given. This uncertainty is smaller than the expected uncertainty for mobile phone measurements due to the simplified setup and the symmetric field distribution.

Error Description	Tolerance (±%)	Probability Distribution	Divisor	(C _i)		Standard Uncertainty (±%)		(v _i)
				(1g)	(10g)	(1g)	(10g)	
Measurement System								
Probe Calibration	4.8	Normal	1	1	1	4.8	4.8	∞
Axial Isotropy	4.7	Rectangular	$\sqrt{3}$	1	1	2.7	2.7	∞
Hemispherical Isotropy	0	Rectangular	$\sqrt{3}$	1	1	0	0	∞
Boundary effect	1.0	Rectangular	$\sqrt{3}$	1	1	0.6	0.6	∞
Linearity	4.7	Rectangular	$\sqrt{3}$	1	1	2.7	2.7	∞
System Detection Limit	1.0	Rectangular	$\sqrt{3}$	1	1	0.6	0.6	∞
Readout Electronics	1.0	Normal	1	1	1	1.0	1.0	∞
Response Time	0	Rectangular	$\sqrt{3}$	1	1	0	0	∞
Integration Time	0	Rectangular	$\sqrt{3}$	1	1	0	0	∞
RF Ambient Conditions	3.0	Rectangular	$\sqrt{3}$	1	1	1.7	1.7	∞
Probe Positioner	0.4	Rectangular	$\sqrt{3}$	1	1	0.2	0.2	∞
Probe positioning	2.9	Rectangular	$\sqrt{3}$	1	1	1.7	1.7	∞
Algorithms for Max. SAR Evaluation	1.0	Rectangular	$\sqrt{3}$	1	1	0.6	0.6	∞
Dipole								
Dipole Axis to Liquid Distance	2.0	Rectangular	$\sqrt{3}$	1	1	1.2	1.2	∞
Input power and SAR drift measurement	4.7	Rectangular	$\sqrt{3}$	1	1	2.7	2.7	∞
Phantom and Tissue Parameters								
Phantom Uncertainty	4.0	Rectangular	$\sqrt{3}$	1	1	2.3	2.3	∞
Liquid Conductivity (target)	5.0	Rectangular	$\sqrt{3}$	0.64	0.43	1.8	1.2	∞
Liquid Conductivity (measurement)	2.5	Normal	1	0.64	0.43	1.6	1.1	∞
Liquid Permittivity (target)	5.0	Rectangular	$\sqrt{3}$	0.6	0.49	1.7	1.4	∞
Liquid Permittivity (measurement)	2.5	Normal	1	0.6	0.49	1.5	1.2	∞
Combined Standard Uncertainty						8.4	8.1	∞
Coverage Factor for 95%						k _p =2		
Expanded Uncertainty (K=2)						16.8	16.2	

NOTE: About the system validation uncertainty assessment, please reference the section 7.

7. MEASUREMENT SAR PROCEDURE UNCERTAINTIES

The assessment of spatial peak SAR of the hand held devices is according to IEEE 1528. All testing situation shall be met below these requirements.

- The system is used by an experienced engineer who follows the manual and the guidelines taught during the training provided by SPEAG.
- The probe has been calibrated within the requested period and the stated uncertainty for the relevant frequency bands does not exceed 4.8% (k=1).
- The validation dipole has been calibrated within the requested period and the system performance check has been successful.
- The DAE unit has been calibrated within the within the requested period.
- The minimum distance between the probe sensor and inner phantom shell is selected to be between 4 and 5mm.
- The operational mode of the DUT is CW, CDMA, FDMA or TDMA (GSM, DCS, PCS, IS136 and PDC) and the measurement/integration time per point is >500 ms.
- The dielectric parameters of the liquid have been assessed using Agilent 85070D dielectric probe kit or a more accurate method.
- The dielectric parameters are within 5% of the target values.
- The DUT has been positioned as described in section 3.

7.1. PROBE CALIBRATION UNCERTAINTY

SPEAG conducts the probe calibration in compliance with international and national standards (e.g. IEEE 1528, EN 62209-1, IEC 62209, etc.) under ISO17025. The uncertainties are stated on the calibration certificate. For the most relevant frequency bands, these values do not exceed 4.8% (k=1). If evaluations of other bands are performed for which the uncertainty exceeds these values, the uncertainty tables given in the summary have to be revised accordingly.

7.2. ISOTROPY UNCERTAINTY

The axial isotropy tolerance accounts for probe rotation around its axis while the hemispherical isotropy error includes all probe orientations and field polarizations. These parameters are assessed by SPEAG during initial calibration. In 2001, SPEAG further tightened its quality controls and warrants that the maximal deviation from axial isotropy is $\pm 0.20\text{dB}$, while the maximum deviation of hemispherical isotropy is $\pm 0.40\text{dB}$, corresponding to $\pm 4.7\%$ and $\pm 9.6\%$, respectively. A weighting factor of c_p equal to 0.5 can be applied, since the axis of the probe deviates less than 30 degrees from the normal surface orientation.

7.3. BOUNDARY EFFECT UNCERTAINTY

The effect can be estimated according to the following error approximation formula

$$SAR_{tolerance} [\%] = SAR_{be} [\%] \times \frac{(d_{be} + d_{step})^2}{2d_{step}} e^{-\frac{d_{be}}{\delta/2}}$$

$$d_{be} + d_{step} < 10\text{mm}$$

The parameter d_{be} is the distance in mm between the surface and the closest measurement point used in the averaging process; d_{step} is the separation distance in mm between the first and second measurement points; δ is the minimum penetration depth in mm within the head tissue equivalent liquids (i.e., $\delta = 13.95\text{mm}$ at 3GHz); SAR_{be} is the deviation between the measured SAR value at the distance d_{be} from the boundary and the wave-guide analytical value SAR_{ref} . DASY4 applies a boundary effect compensation algorithm according to IEEE 1528, which is possible since the axis of the probe never deviates more than 30 degrees from the normal surface orientation. $SAR_{be}[\%]$ is assessed during the calibration process and SPEAG warrants that the uncertainty at distances larger than 4mm is always less than 1%. In summary, the worst case boundary effect SAR tolerance[%] for scanning distances larger than 4mm is $< \pm 0.8\%$.

7.4. PROBE LINEARITY UNCERTAINTY

Field probe linearity uncertainty includes errors from the assessment and compensation of the diode compression effects for CW and pulsed signals with known duty cycles. This error is assessed using the procedure described in IEEE 1528. For SPEAG field probes, the measured difference between CW and pulsed signals, with pulse frequencies between 10Hz and 1kHz and duty cycles between 1 and 100, is $< \pm 0.20\text{dB}$ ($< \pm 4.7\%$).

7.5. READOUT ELECTRONICS UNCERTAINTY

All uncertainties related to the probe readout electronics (DAE unit), including the gain and linearity of the instrumentation amplifier, its loading effect on the probe, and accuracy of the signal conversion algorithm, have been assessed accordingly to IEEE 1528. The combination (root-sum-square RSS method) of these components results in an overall maximum error of $\pm 1.0\%$.

7.6. RESPONSE TIME UNCERTAINTY

The time response of the field probes is assessed by exposing the probe to a well-controlled electric field producing SAR larger than 2.0W/kg at the tissue medium surface. The signal response time is evaluated as the time required by the system to reach 90% of the expected final value after an on/of switch of the power source. Analytically, it can be expressed as:

$$SAR_{tolerance} [\%] = 100 \times \left(\frac{T_m}{T_m + \tau e^{-T_m/\tau} - \tau} - 1 \right)$$

where T_m is 500 ms, i.e., the time between measurement samples, and τ the time constant. The response time τ of SPEAG's probes is $< 5\text{ms}$. In the current implementation, DASY4 waits longer than 100 ms after having reached the grid point before starting a measurement, i.e., the response time uncertainty is negligible.

7.7. INTEGRATION TIME UNCERTAINTY

If the device under test does not emit a CW signal, the integration time applied to measure the electric field at a specific point may introduce additional uncertainties due to the discretization and can be assessed as follows

$$SAR_{tolerance} [\%] = 100 \times \sum_{all\ sub-frames} \frac{t_{frame}}{t_{integration}} \frac{slot_{idle}}{slot_{total}}$$

The tolerances for the different systems are given in Table 7.1, whereby the worst-case $SAR_{tolerance}$ is 2.6%.

System	$SAR_{tolerance} \%$
CW	0
CDMA*	0
WCDMA*	0
FDMA	0
IS-136	2.6
PDC	2.6
GSM/DCS/PCS	1.7
DECT	1.9
Worst-Case	2.6

TABLE 7.1

7.8. PROBE POSITIONER MECHANICAL TOLERANCE

The mechanical tolerance of the field probe positioner can introduce probe positioning uncertainties. The resulting SAR uncertainty is assessed by comparing the SAR obtained according to the specifications of the probe positioner with respect to the actual position defined by the geometric center of the probe sensors. The tolerance is determined as:

$$SAR_{tolerance} [\%] = 100 \times \frac{d_{ph}}{\delta/2}$$

The specified repeatability of the RX robot family used in DASY4 systems is $\pm 25\mu\text{m}$. The absolute accuracy for short distance movements is better than $\pm 0.1\text{mm}$, i.e., the $SAR_{tolerance} [\%]$ is better than 1.5% (rectangular).

7.9. PROBE POSITIONING

The probe positioning procedures affect the tolerance of the separation distance between the probe tip and the phantom surface as:

$$SAR_{tolerance} [\%] = 100 \times \frac{d_{ph}}{\delta/2}$$

where d_{ph} is the maximum deviation of the distance between the probe tip and the phantom surface. The optical surface detection has a precision of better than 0.2mm, resulting in an $SAR_{tolerance} [\%]$ of <2.9% (rectangular distribution). Since the mechanical detection provides better accuracy, 2.9% is a worst-case figure for DASY4 system.

7.10. PHANTOM UNCERTAINTY

The SAR measurement uncertainty due to SPEAG phantom shell production tolerances has been evaluated using

$$SAR_{tolerance} [\%] \cong 100 \times \frac{2d}{a}, \quad d \ll a$$

For a maximum deviation d of the inner and outer shell of the phantom from that specified in the CAD file of $\pm 0.2\text{mm}$, and a 10mm spacing a between source and tissue liquid, the calculated phantom uncertainty is $\pm 4.0\%$.

7.11. DASY4 UNCERTAINTY BUDGET (FOR 5 ~ 6GHz)

Error Description	Tolerance (±%)	Probability Distribution	Divisor	(C _i)		Standard Uncertainty (±%)		(v _i)
				(1g)	(10g)	(1g)	(10g)	
Measurement System								
Probe Calibration	6.8	Normal	1	1	1	6.8	6.8	∞
Axial Isotropy	4.7	Rectangular	$\sqrt{3}$	0.7	0.7	1.9	1.9	∞
Hemispherical Isotropy	9.6	Rectangular	$\sqrt{3}$	0.7	0.7	3.9	3.9	∞
Boundary effect	2.0	Rectangular	$\sqrt{3}$	1	1	1.2	1.2	∞
Linearity	4.7	Rectangular	$\sqrt{3}$	1	1	2.7	2.7	∞
System Detection Limit	1.0	Rectangular	$\sqrt{3}$	1	1	0.6	0.6	∞
Readout Electronics	1.0	Normal	1	1	1	1.0	1.0	∞
Response Time	0.8	Rectangular	$\sqrt{3}$	1	1	0.5	0.5	∞
Integration Time	2.6	Rectangular	$\sqrt{3}$	1	1	1.5	1.5	∞
RF Ambient Conditions	3.0	Rectangular	$\sqrt{3}$	1	1	1.7	1.7	∞
Probe Positioner	0.8	Rectangular	$\sqrt{3}$	1	1	0.5	0.5	∞
Probe positioning	5.7	Normal	1	1	1	5.7	5.7	∞
Algorithms for Max. SAR Evaluation	4.0	Rectangular	$\sqrt{3}$	1	1	2.3	2.3	∞
Test EUT Related								
Device Positioning	2.9	Normal	1	1	1	2.9	2.9	145
Device Holder	3.6	Normal	1	1	1	3.6	3.6	5
Power Drift	5.0	Rectangular	$\sqrt{3}$	1	1	2.9	2.9	∞
Phantom and Tissue Parameters								
Phantom Uncertainty	4.0	Rectangular	$\sqrt{3}$	1	1	2.3	2.3	∞
Liquid Conductivity (target)	5.0	Rectangular	$\sqrt{3}$	0.64	0.43	1.8	1.2	∞
Liquid Conductivity (measurement)	2.5	Normal	1	0.64	0.43	1.6	1.1	∞
Liquid Permittivity (target)	5.0	Rectangular	$\sqrt{3}$	0.60	0.49	1.7	1.4	∞
Liquid Permittivity (measurement)	2.5	Normal	1	0.60	0.49	1.5	1.2	∞
Combined Standard Uncertainty						12.8	12.7	330
Expanded STD Uncertainty						25.7	25.3	

TABLE 7.3

The table 7.3: Worst-Case uncertainty budget for DASY4 valid for the frequency range 5 ~ 6 GHz. Probe calibration error reflects uncertainty of the narrow-bandwidth EX3DV3 probe conversion factor (±50 MHz).



8. INFORMATION ON THE TESTING LABORATORIES

We, ADT Corp., were founded in 1988 to provide our best service in EMC, Radio, Telecom and Safety consultation. Our laboratories are accredited and approved by the following approval agencies according to ISO/IEC 17025.

USA	FCC, UL, A2LA
GERMANY	TUV Rheinland
JAPAN	VCCI
NORWAY	NEMKO
CANADA	INDUSTRY CANADA, CSA
R.O.C.	TAF, BSMI, NCC
NETHERLANDS	Telefication
SINGAPORE	GOST-ASIA (MOU)
RUSSIA	CERTIS (MOU)

Copies of accreditation certificates of our laboratories obtained from approval agencies can be downloaded from our web site:

www.adt.com.tw/index.5/phtml. If you have any comments, please feel free to contact us at the following:

Linko EMC/RF Lab:

Tel: 886-2-26052180

Fax: 886-2-26051924

Hsin Chu EMC/RF Lab:

Tel: 886-3-5935343

Fax: 886-3-5935342

Hwa Ya EMC/RF/Safety/Telecom Lab:

Tel: 886-3-3183232

Fax: 886-3-3185050

Web Site: www.adt.com.tw

The address and road map of all our labs can be found in our web site also.

---END---

APPENDIX A: TEST DATA

Liquid Level Photo

MSL 5800MHz D=150mm



Test Laboratory: Advance Data Technology

M01-Body Worn-11a-Ch40

DUT: EDA ; Type: MC7598 ; Test Frequency: 5200 MHz

Communication System: 802.11a ; Frequency: 5200 MHz ; Duty Cycle: 1:1

Medium: MSL5800 Medium parameters used: $f = 5200$ MHz; $\sigma = 5.15$ mho/m; $\epsilon_r = 50$; $\rho = 1000$ kg/m³ ; Liquid Level : 150 mm

Phantom section: Flat Section ; DUT test position : Body ; Modulation Type: BPSK

Separation Distance : 0 mm (The bottom side of the EUT to the Phantom)

Antenna Type : PIFA Antenna ; Air Temp. : 23.9 degrees ; Liquid Temp. : 22.6 degrees

DASY4 Configuration:

- Probe: EX3DV3 - SN3504 ; ConvF(4.34, 4.34, 4.34) ; Calibrated: 2007/8/30
- Sensor-Surface: 3mm (Mechanical Surface Detection)
- Electronics: DAE3 Sn510 ; Calibrated: 2007/8/29
- Phantom: SAM 12 ; Type: SAM V4.0; Serial: TP 1202
- Measurement SW: DASY4, V4.7 Build 53 ; Postprocessing SW: SEMCAD, V1.8 Build 172

Mid Channel 40/Area Scan (9x19x1): Measurement grid: dx=10mm, dy=10mm

Maximum value of SAR (measured) = 0.062 mW/g

Mid Channel 40/Zoom Scan (7x7x7) (8x8x8)/Cube 0: Measurement grid: dx=4.3mm, dy=4.3mm, dz=3mm

Reference Value = 2.95 V/m

Peak SAR (extrapolated) = 0.072 W/kg

SAR(1 g) = 0.048 mW/g; SAR(10 g) = 0.044 mW/g

Maximum value of SAR (measured) = 0.072 mW/g

Mid Channel 40/Zoom Scan (7x7x7) (8x8x8)/Cube 1: Measurement grid: dx=4.3mm, dy=4.3mm, dz=3mm

Reference Value = 2.95 V/m

Peak SAR (extrapolated) = 0.078 W/kg

SAR(1 g) = 0.049 mW/g; SAR(10 g) = 0.045 mW/g

Maximum value of SAR (measured) = 0.068 mW/g

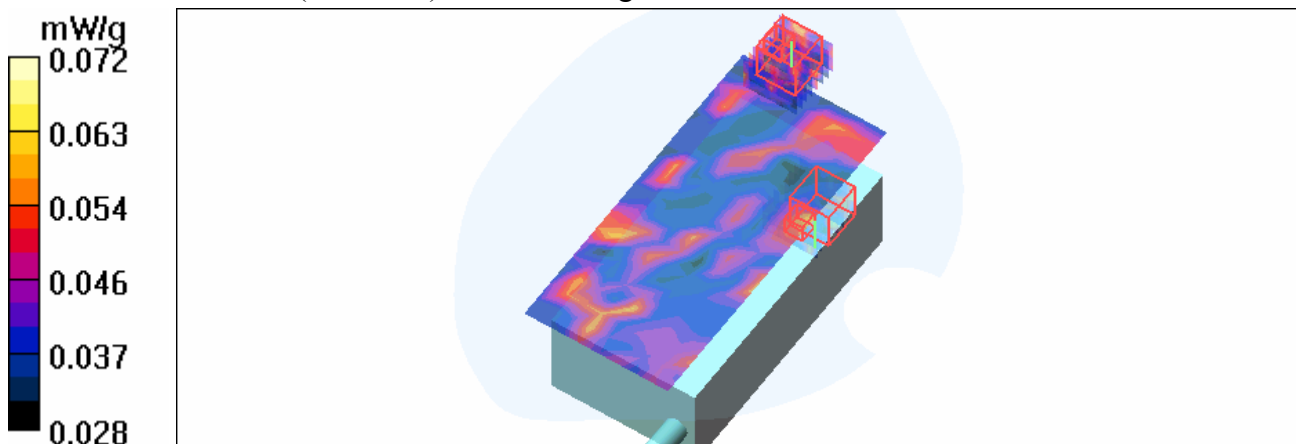

Test Laboratory: Advance Data Technology

M01-Body Worn-11a-Ch64

DUT: EDA ; Type: MC7598 ; Test Frequency: 5320 MHz

Communication System: 802.11a ; Frequency: 5320 MHz ; Duty Cycle: 1:1

Medium: MSL5800 Medium parameters used: $f = 5320$ MHz; $\sigma = 5.32$ mho/m; $\epsilon_r = 49.7$; $\rho = 1000$ kg/m³ ; Liquid Level : 150 mm

Phantom section: Flat Section ; DUT test position : Body ; Modulation Type: BPSK

Separation Distance : 0 mm (The bottom side of the EUT to the Phantom)

Antenna Type : PIFA Antenna ; Air Temp. : 23.9 degrees ; Liquid Temp. : 22.6 degrees

DASY4 Configuration:

- Probe: EX3DV3 - SN3504 ; ConvF(4.08, 4.08, 4.08) ; Calibrated: 2007/8/30
- Sensor-Surface: 3mm (Mechanical Surface Detection)
- Electronics: DAE3 Sn510 ; Calibrated: 2007/8/29
- Phantom: SAM 12 ; Type: SAM V4.0; Serial: TP 1202
- Measurement SW: DASY4, V4.7 Build 53 ; Postprocessing SW: SEMCAD, V1.8 Build 172

Mid Channel 64/Area Scan (9x19x1): Measurement grid: dx=10mm, dy=10mm

Maximum value of SAR (measured) = 0.060 mW/g

Mid Channel 64/Zoom Scan (7x7x7) (8x8x8)/Cube 0: Measurement grid: dx=4.3mm, dy=4.3mm, dz=3mm

Reference Value = 2.85 V/m

Peak SAR (extrapolated) = 0.088 W/kg

SAR(1 g) = 0.058 mW/g; SAR(10 g) = 0.048 mW/g

Maximum value of SAR (measured) = 0.088 mW/g

Mid Channel 64/Zoom Scan (7x7x7) (8x8x8)/Cube 1: Measurement grid: dx=4.3mm, dy=4.3mm, dz=3mm

Reference Value = 2.85 V/m

Peak SAR (extrapolated) = 0.101 W/kg

SAR(1 g) = 0.055 mW/g; SAR(10 g) = 0.046 mW/g

Maximum value of SAR (measured) = 0.068 mW/g

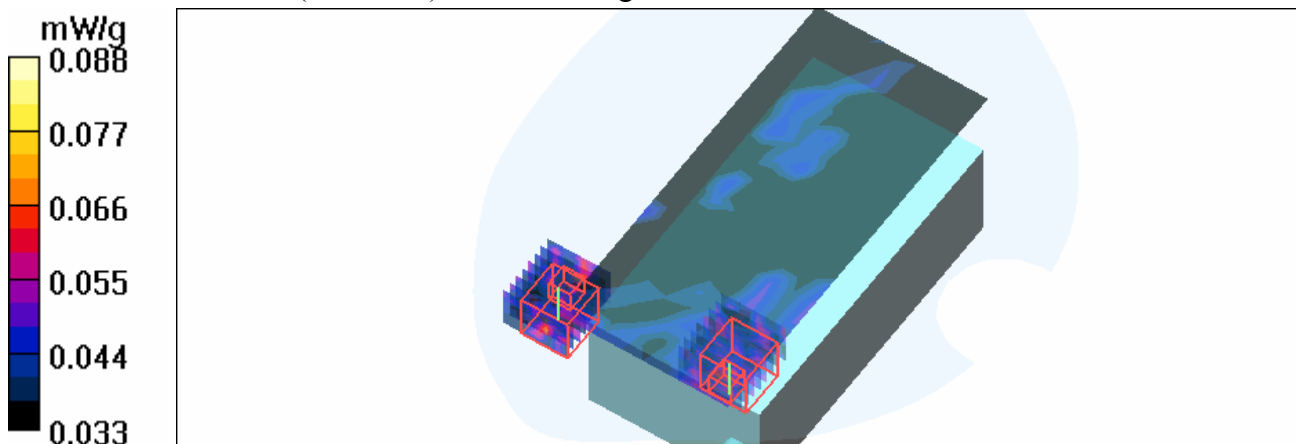

Test Laboratory: Advance Data Technology

M01-Body Worn-11a-Ch124

DUT: EDA ; Type: MC7598 ; Test Frequency: 5620 MHz

Communication System: 802.11a ; Frequency: 5620 MHz ; Duty Cycle: 1:1

Medium: MSL5800 Medium parameters used: $f = 5620$ MHz; $\sigma = 5.75$ mho/m; $\epsilon_r = 49.1$; $\rho = 1000$ kg/m³ ; Liquid Level : 150 mm

Phantom section: Flat Section ; DUT test position : Body ; Modulation Type: BPSK

Separation Distance : 0 mm (The bottom side of the EUT to the Phantom)

Antenna Type : PIFA Antenna ; Air Temp. : 23.9 degrees ; Liquid Temp. : 22.6 degrees

DASY4 Configuration:

- Probe: EX3DV3 - SN3504 ; ConvF(4.09, 4.09, 4.09) ; Calibrated: 2007/8/30
- Sensor-Surface: 3mm (Mechanical Surface Detection)
- Electronics: DAE3 Sn510 ; Calibrated: 2007/8/29
- Phantom: SAM 12 ; Type: SAM V4.0; Serial: TP 1202
- Measurement SW: DASY4, V4.7 Build 53 ; Postprocessing SW: SEMCAD, V1.8 Build 172

Mid Channel 124/Area Scan (9x19x1): Measurement grid: dx=10mm, dy=10mm

Maximum value of SAR (measured) = 0.063 mW/g

Mid Channel 124/Zoom Scan (7x7x7) (8x8x8)/Cube 0: Measurement grid: dx=4.3mm, dy=4.3mm, dz=3mm

Reference Value = 2.40 V/m

Peak SAR (extrapolated) = 0.080 W/kg

SAR(1 g) = 0.051 mW/g; SAR(10 g) = 0.045 mW/g

Maximum value of SAR (measured) = 0.071 mW/g

Mid Channel 124/Zoom Scan (7x7x7) (8x8x8)/Cube 1: Measurement grid: dx=4.3mm, dy=4.3mm, dz=3mm

Reference Value = 2.40 V/m

Peak SAR (extrapolated) = 0.081 W/kg

SAR(1 g) = 0.046 mW/g; SAR(10 g) = 0.041 mW/g

Maximum value of SAR (measured) = 0.061 mW/g

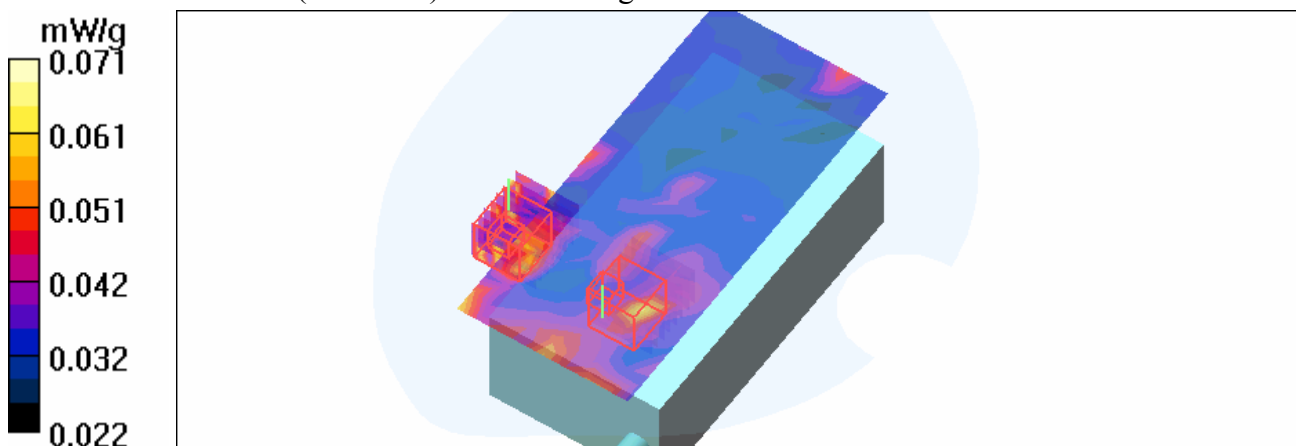

Test Laboratory: Advance Data Technology

System Validation Check-MSL 5GHz

DUT: Dipole 5 GHz ; Type: D5GHzV2 ; Serial: 1019 ; Test Frequency: 5200 MHz

Communication System: CW ; Frequency: 5200 MHz; Duty Cycle: 1:1; Modulation type: CW
 Medium: MSL5800; Medium parameters used: $f = 5200$ MHz; $\sigma = 5.15$ mho/m; $\epsilon_r = 50$; $\rho = 1000$ kg/m³ ;
 Liquid level : 150 mm
 Phantom section: Flat Section ; Separation distance : 10 mm (The feetpoint of the dipole to the Phantom)
 Air temp. : 23.9 degrees ; Liquid temp. : 22.6 degrees

DASY4 Configuration:

- Probe: EX3DV3 - SN3504 ; ConvF(4.34, 4.34, 4.34) ; Calibrated: 2007/8/30
- Sensor-Surface: 3mm (Mechanical Surface Detection)
- Electronics: DAE3 Sn510; Calibrated: 2007/8/29
- Phantom: SAM 12; Type: SAM V4.0; Serial: TP 1202
- Measurement SW: DASY4, V4.7 Build 53; Postprocessing SW: SEMCAD, V1.8 Build 172

f=5200, d=10mm, Pin=250mW/Area Scan (6x6x1): Measurement grid: dx=10mm, dy=10mm
 Maximum value of SAR (measured) = 17.8 mW/g

f=5200, d=10mm, Pin=250mW/Zoom Scan (8x8x8)/Cube 0: Measurement grid: dx=4.3mm, dy=4.3mm, dz=3mm

Reference Value = 77.9 V/m; Power Drift = -0.158 dB

Peak SAR (extrapolated) = 71.9 W/kg

SAR(1 g) = 18.8 mW/g; SAR(10 g) = 5.24 mW/g

Maximum value of SAR (measured) = 27.3 mW/g

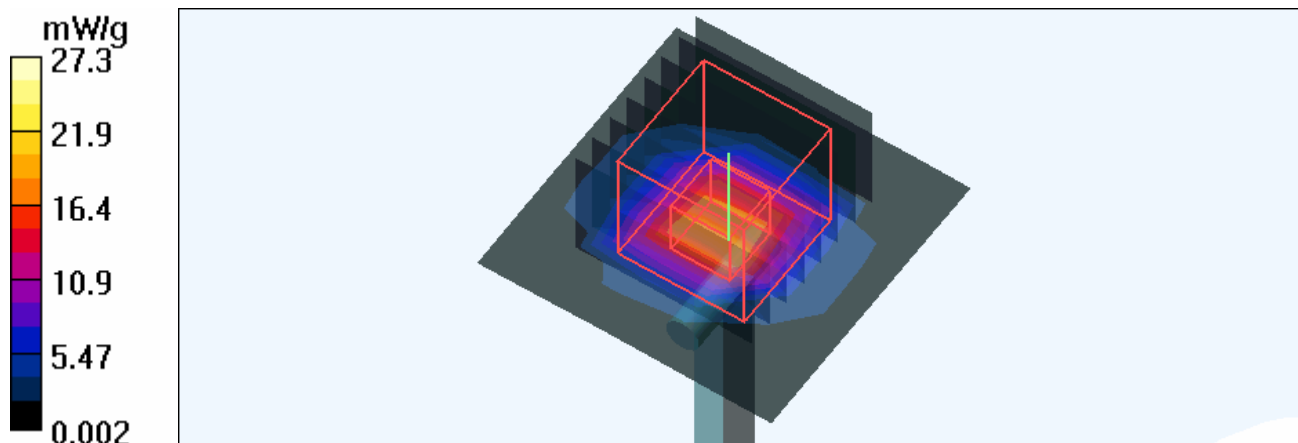

Test Laboratory: Advance Data Technology

System Validation Check-MSL 5GHz

DUT: Dipole 5 GHz ; Type: D5GHzV2 ; Serial: 1019 ; Test Frequency: 5500 MHz

Communication System: CW ; Frequency: 5500 MHz; Duty Cycle: 1:1; Modulation type: CW
 Medium: MSL5800; Medium parameters used: $f = 5500$ MHz; $\sigma = 5.58$ mho/m; $\epsilon_r = 49.3$; $\rho = 1000$ kg/m³ ; Liquid level : 150 mm
 Phantom section: Flat Section ; Separation distance : 10 mm (The feetpoint of the dipole to the Phantom) Air temp. : 23.9 degrees ; Liquid temp. : 22.6 degrees

DASY4 Configuration:

- Probe: EX3DV3 - SN3504 ; ConvF(3.99, 3.99, 3.99) ; Calibrated: 2007/8/30
- Sensor-Surface: 3mm (Mechanical Surface Detection)
- Electronics: DAE3 Sn510; Calibrated: 2007/8/29
- Phantom: SAM 12; Type: SAM V4.0; Serial: TP 1202
- Measurement SW: DASY4, V4.7 Build 53; Postprocessing SW: SEMCAD, V1.8 Build 172

f=5500, d=10mm, Pin=250mW/Area Scan (7x7x1): Measurement grid: dx=10mm, dy=10mm
 Maximum value of SAR (measured) = 29.5 mW/g

f=5500, d=10mm, Pin=250mW/Zoom Scan (8x8x8)/Cube 0: Measurement grid: dx=4.3mm, dy=4.3mm, dz=3mm

Reference Value = 73.8 V/m; Power Drift = -0.104 dB

Peak SAR (extrapolated) = 83.5 W/kg

SAR(1 g) = 18.9 mW/g; SAR(10 g) = 5.27 mW/g

Maximum value of SAR (measured) = 26.6 mW/g

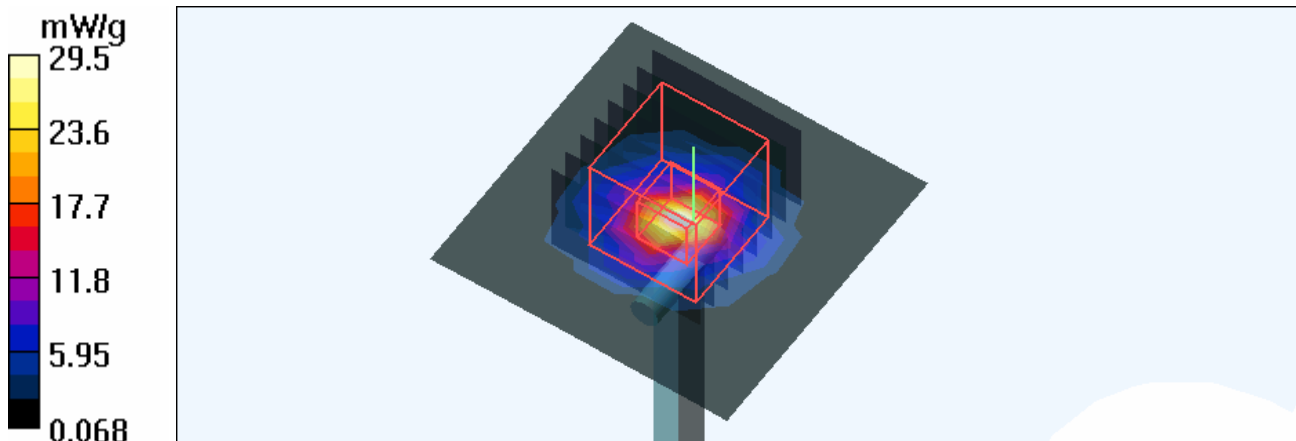

APPENDIX B: ADT SAR MEASUREMENT SYSTEM



APPENDIX C: PHOTOGRAPHS OF SYSTEM VALIDATION





APPENDIX D: SYSTEM CERTIFICATE & CALIBRATION

D1: SAM PHANTOM

Schmid & Partner Engineering AG

Zeughausstrasse 43, 8004 Zurich, Switzerland, Phone +41 1 245 97 00, Fax +41 1 245 97 79

Certificate of conformity / First Article Inspection

Item	SAM Twin Phantom V4.0
Type No	QD 000 P40 CA
Series No	TP-1150 and higher
Manufacturer / Origin	Untersee Composites Hauptstr. 69 CH-8559 Fruthwilen Switzerland

Tests

The series production process used allows the limitation to test of first articles. Complete tests were made on the pre-series Type No. QD 000 P40 AA, Serial No. TP-1001 and on the series first article Type No. QD 000 P40 BA, Serial No. TP-1006. Certain parameters have been retested using further series units (called samples).

Test	Requirement	Details	Units tested
Shape	Compliance with the geometry according to the CAD model.	IT'IS CAD File (*)	First article, Samples
Material thickness	Compliant with the requirements according to the standards	2mm +/- 0.2mm in specific areas	First article, Samples
Material parameters	Dielectric parameters for required frequencies	200 MHz – 3 GHz Relative permittivity < 5 Loss tangent < 0.05.	Material sample TP 104-5
Material resistivity	The material has been tested to be compatible with the liquids defined in the standards	Liquid type HSL 1800 and others according to the standard.	Pre-series, First article

Standards

- [1] CENELEC EN 50361
- [2] IEEE P1528-200x draft 6.5
- [3] IEC PT 62209 draft 0.9

(*) The IT'IS CAD file is derived from [2] and is also within the tolerance requirements of the shapes of [1] and [3].

Conformity

Based on the sample tests above, we certify that this item is in compliance with the uncertainty requirements of SAR measurements specified in standard [1] and draft standards [2] and [3].

Date 28.02.2002

Signature / Stamp

F. Bombault

**Schmid & Partner
Engineering AG**

Zeughausstrasse 43, CH-8004 Zurich
Tel. +41 1 245 97 00, Fax +41 1 245 97 79

Johannes Kofler



Accredited by the Swiss Federal Office of Metrology and Accreditation
The Swiss Accreditation Service is one of the signatories to the EA
Multilateral Agreement for the recognition of calibration certificates

Accreditation No.: **SCS 108**

Client **ADT (Auden)**

Certificate No: **EX3-3504_Aug07**

CALIBRATION CERTIFICATE

Object: **EX3DV3 - SN:3504**

Calibration procedure(s): **QA-CAL-01 v6 and QA-CAL-14 v3
Calibration procedure for dosimetric E-field probes**

Calibration date: **August 30, 2007**

Condition of the calibrated item: **In Tolerance**

This calibration certificate documents the traceability to national standards, which realize the physical units of measurements (SI).
The measurements and the uncertainties with confidence probability are given on the following pages and are part of the certificate.

All calibrations have been conducted in the closed laboratory facility: environment temperature (22 ± 3)°C and humidity < 70%.

Calibration Equipment used (M&TE critical for calibration)

Primary Standards	ID #	Cal Date (Calibrated by, Certificate No.)	Scheduled Calibration
Power meter E4419B	GB41293874	29-Mar-07 (METAS, No. 217-00670)	Mar-08
Power sensor E4412A	MY41495277	29-Mar-07 (METAS, No. 217-00670)	Mar-08
Power sensor E4412A	MY41498087	29-Mar-07 (METAS, No. 217-00670)	Mar-08
Reference 3 dB Attenuator	SN: S5054 (3c)	8-Aug-07 (METAS, No. 217-00719)	Aug-08
Reference 20 dB Attenuator	SN: S5086 (20b)	29-Mar-07 (METAS, No. 217-00671)	Mar-08
Reference 30 dB Attenuator	SN: S5129 (30b)	8-Aug-07 (METAS, No. 217-00720)	Aug-08
Reference Probe ES3DV2	SN: 3013	4-Jan-07 (SPEAG, No. ES3-3013_Jan07)	Jan-08
DAE4	SN: 654	20-Apr-07 (SPEAG, No. DAE4-654_Apr07)	Apr-08
Secondary Standards	ID #	Check Date (in house)	Scheduled Check
RF generator HP 8648C	US3642U01700	4-Aug-99 (SPEAG, in house check Nov-05)	In house check: Nov-07
Network Analyzer HP 8753E	US37390585	18-Oct-01 (SPEAG, in house check Oct-06)	In house check: Oct-07

	Name	Function	Signature
Calibrated by:	Katja Pokovic	Technical Manager	
Approved by:	Niels Kuster	Quality Manager	

Issued: August 30, 2007

This calibration certificate shall not be reproduced except in full without written approval of the laboratory.



Accredited by the Swiss Federal Office of Metrology and Accreditation
The Swiss Accreditation Service is one of the signatories to the EA
Multilateral Agreement for the recognition of calibration certificates

Accreditation No.: **SCS 108**

Glossary:

TSL	tissue simulating liquid
NORM _{x,y,z}	sensitivity in free space
ConvF	sensitivity in TSL / NORM _{x,y,z}
DCP	diode compression point
Polarization ϕ	ϕ rotation around probe axis
Polarization ϑ	ϑ rotation around an axis that is in the plane normal to probe axis (at measurement center), i.e., $\vartheta = 0$ is normal to probe axis

Calibration is Performed According to the Following Standards:

- IEEE Std 1528-2003, "IEEE Recommended Practice for Determining the Peak Spatial-Averaged Specific Absorption Rate (SAR) in the Human Head from Wireless Communications Devices: Measurement Techniques", December 2003
- IEC 62209-1, "Procedure to measure the Specific Absorption Rate (SAR) for hand-held devices used in close proximity to the ear (frequency range of 300 MHz to 3 GHz)", February 2005

Methods Applied and Interpretation of Parameters:

- NORM_{x,y,z}**: Assessed for E-field polarization $\vartheta = 0$ ($f \leq 900$ MHz in TEM-cell; $f > 1800$ MHz: R22 waveguide). NORM_{x,y,z} are only intermediate values, i.e., the uncertainties of NORM_{x,y,z} does not effect the E²-field uncertainty inside TSL (see below *ConvF*).
- NORM(f)_{x,y,z}** = NORM_{x,y,z} * *frequency_response* (see Frequency Response Chart). This linearization is implemented in DASY4 software versions later than 4.2. The uncertainty of the frequency response is included in the stated uncertainty of *ConvF*.
- DCP_{x,y,z}**: DCP are numerical linearization parameters assessed based on the data of power sweep (no uncertainty required). DCP does not depend on frequency nor media.
- ConvF and Boundary Effect Parameters**: Assessed in flat phantom using E-field (or Temperature Transfer Standard for $f \leq 800$ MHz) and inside waveguide using analytical field distributions based on power measurements for $f > 800$ MHz. The same setups are used for assessment of the parameters applied for boundary compensation (alpha, depth) of which typical uncertainty values are given. These parameters are used in DASY4 software to improve probe accuracy close to the boundary. The sensitivity in TSL corresponds to NORM_{x,y,z} * *ConvF* whereby the uncertainty corresponds to that given for *ConvF*. A frequency dependent *ConvF* is used in DASY version 4.4 and higher which allows extending the validity from ± 50 MHz to ± 100 MHz.
- Spherical isotropy (3D deviation from isotropy)**: in a field of low gradients realized using a flat phantom exposed by a patch antenna.
- Sensor Offset**: The sensor offset corresponds to the offset of virtual measurement center from the probe tip (on probe axis). No tolerance required.

Probe EX3DV3

SN:3504

Manufactured:	December 15, 2003
Last calibrated:	November 23, 2006
Recalibrated:	August 30, 2007

Calibrated for DASY Systems

(Note: non-compatible with DASY2 system!)

DASY - Parameters of Probe: EX3DV3 SN:3504

Sensitivity in Free Space ^A			Diode Compression ^B	
NormX	0.610 ± 10.1%	$\mu\text{V}/(\text{V}/\text{m})^2$	DCP X	95 mV
NormY	0.610 ± 10.1%	$\mu\text{V}/(\text{V}/\text{m})^2$	DCP Y	97 mV
NormZ	0.630 ± 10.1%	$\mu\text{V}/(\text{V}/\text{m})^2$	DCP Z	94 mV

Sensitivity in Tissue Simulating Liquid (Conversion Factors)

Please see Page 8.

Boundary Effect

TSL	2300 MHz	Typical SAR gradient: 10 % per mm	
	Sensor Center to Phantom Surface Distance	2.0 mm	3.0 mm
	SAR _{be} [%] Without Correction Algorithm	3.4	1.2
	SAR _{be} [%] With Correction Algorithm	0.2	0.1
TSL	3500 MHz	Typical SAR gradient: 18 % per mm	
	Sensor Center to Phantom Surface Distance	2.0 mm	3.0 mm
	SAR _{be} [%] Without Correction Algorithm	5.4	2.6
	SAR _{be} [%] With Correction Algorithm	0.0	0.0

Sensor OffsetProbe Tip to Sensor Center **1.0 mm**

The reported uncertainty of measurement is stated as the standard uncertainty of measurement multiplied by the coverage factor k=2, which for a normal distribution corresponds to a coverage probability of approximately 95%.

^A The uncertainties of NormX,Y,Z do not affect the E²-field uncertainty inside TSL (see Page 8).^B Numerical linearization parameter: uncertainty not required.

Frequency Response of E-Field

(TEM-Cell:ifi110 EXX, Waveguide: R22)

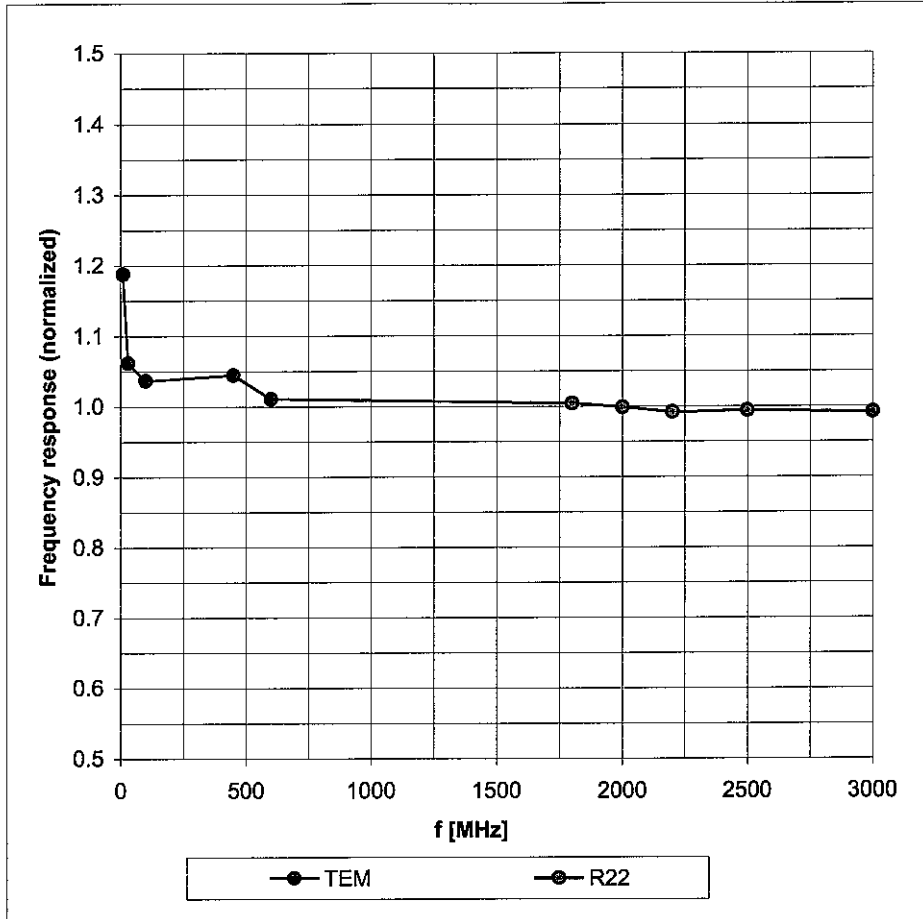

Uncertainty of Frequency Response of E-field: $\pm 6.3\%$ ($k=2$)

Receiving Pattern (ϕ), $\vartheta = 0^\circ$

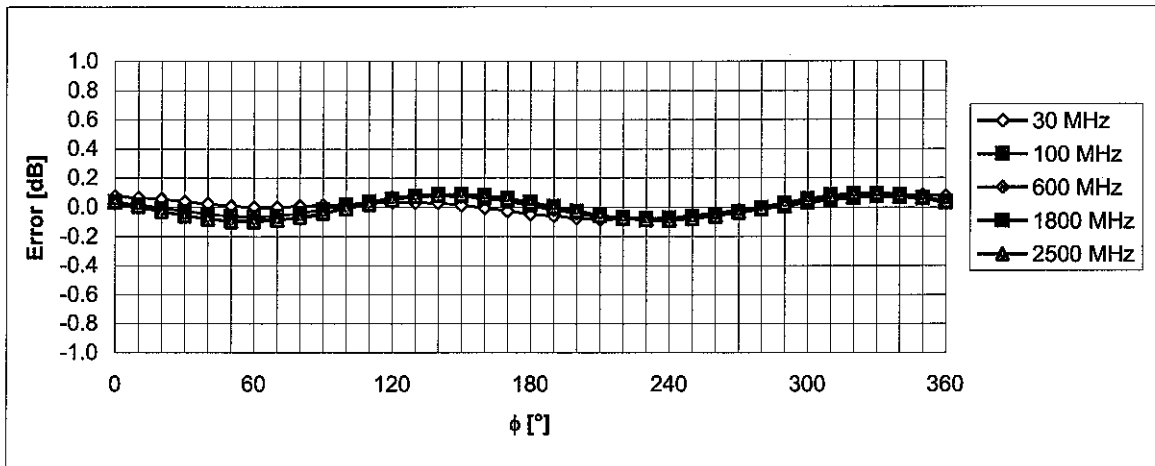
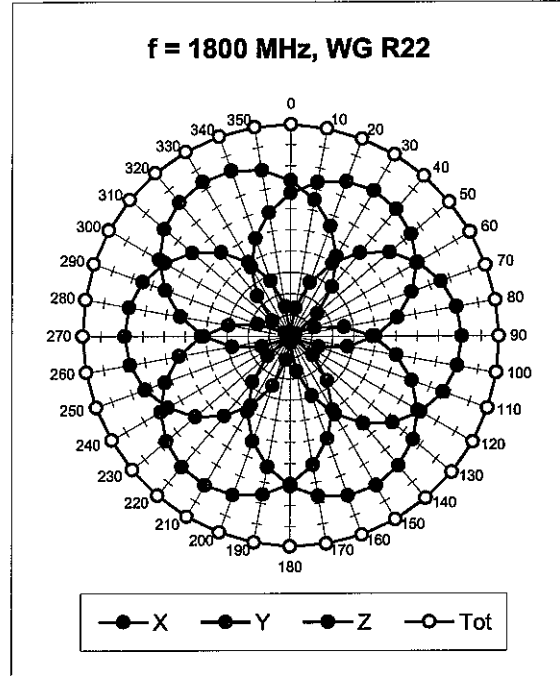
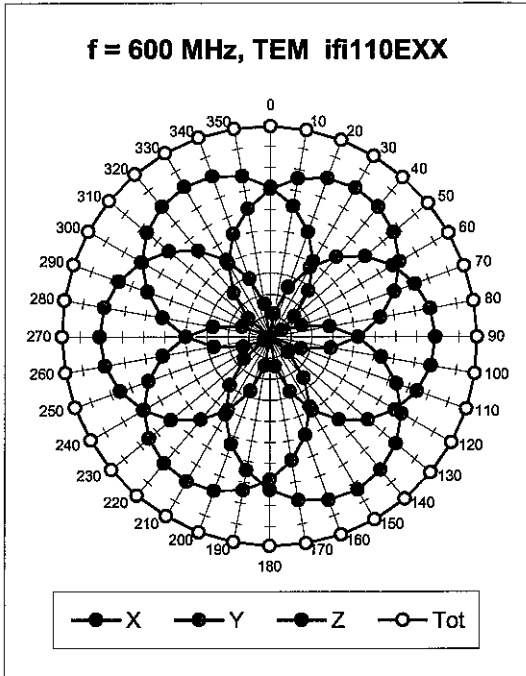

Uncertainty of Axial Isotropy Assessment: $\pm 0.5\%$ ($k=2$)

Dynamic Range $f(\text{SAR}_{\text{head}})$ (Waveguide R22, $f = 1800 \text{ MHz}$)

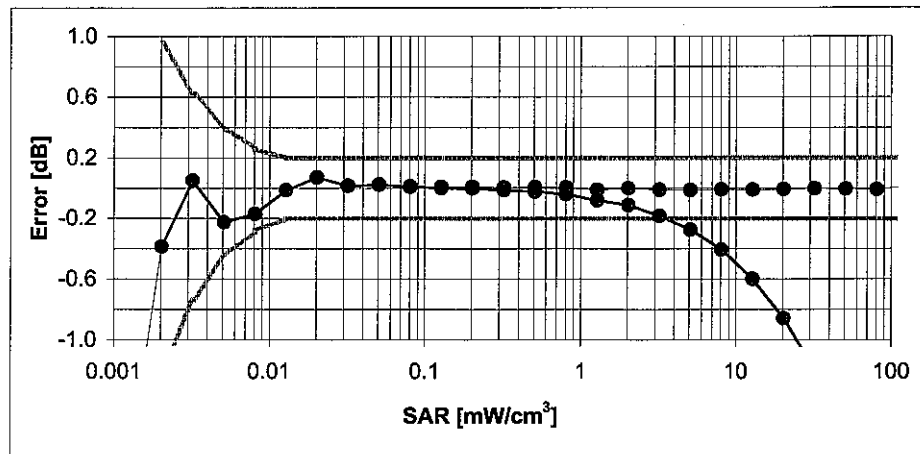
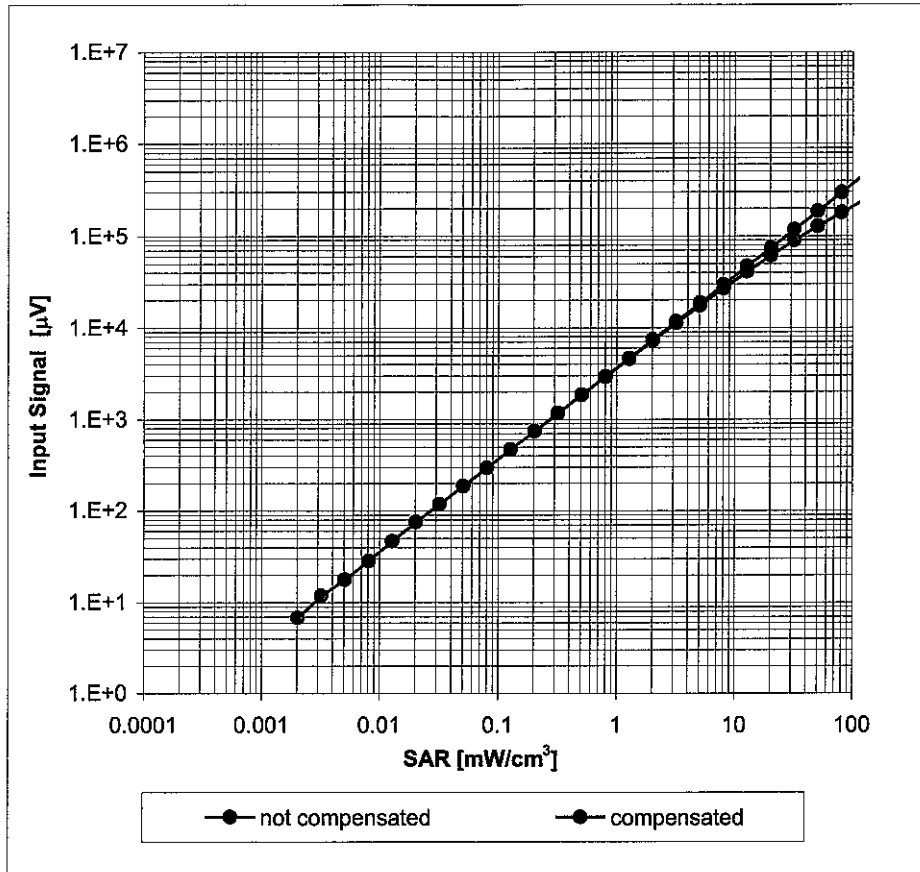

Uncertainty of Linearity Assessment: $\pm 0.6\%$ ($k=2$)

Conversion Factor Assessment

f [MHz]	Validity [MHz] ^c	TSL	Permittivity	Conductivity	Alpha	Depth	ConvF Uncertainty
2300	± 50 / ± 100	Head	39.4 ± 5%	1.71 ± 5%	0.32	1.00	7.88 ± 11.8% (k=2)
2600	± 50 / ± 100	Head	39.0 ± 5%	1.96 ± 5%	0.36	1.00	7.39 ± 11.8% (k=2)
3500	± 50 / ± 100	Head	37.9 ± 5%	2.91 ± 5%	0.26	1.24	7.24 ± 13.1% (k=2)
4950	± 50 / ± 100	Head	36.3 ± 5%	4.40 ± 5%	0.33	1.70	5.56 ± 13.1% (k=2)
5200	± 50 / ± 100	Head	36.0 ± 5%	4.66 ± 5%	0.34	1.70	5.13 ± 13.1% (k=2)
5300	± 50 / ± 100	Head	35.9 ± 5%	4.76 ± 5%	0.32	1.70	4.80 ± 13.1% (k=2)
5500	± 50 / ± 100	Head	35.6 ± 5%	4.96 ± 5%	0.33	1.70	4.79 ± 13.1% (k=2)
5600	± 50 / ± 100	Head	35.5 ± 5%	5.07 ± 5%	0.35	1.70	4.55 ± 13.1% (k=2)
5800	± 50 / ± 100	Head	35.3 ± 5%	5.27 ± 5%	0.33	1.70	4.59 ± 13.1% (k=2)
2300	± 50 / ± 100	Body	52.8 ± 5%	1.85 ± 5%	0.37	1.00	7.84 ± 11.8% (k=2)
2600	± 50 / ± 100	Body	52.5 ± 5%	2.16 ± 5%	0.37	1.00	7.09 ± 11.8% (k=2)
3500	± 50 / ± 100	Body	51.3 ± 5%	3.31 ± 5%	0.29	1.37	6.61 ± 13.1% (k=2)
4950	± 50 / ± 100	Body	49.4 ± 5%	5.01 ± 5%	0.35	1.65	4.77 ± 13.1% (k=2)
5200	± 50 / ± 100	Body	49.0 ± 5%	5.30 ± 5%	0.38	1.65	4.34 ± 13.1% (k=2)
5300	± 50 / ± 100	Body	48.9 ± 5%	5.42 ± 5%	0.35	1.65	4.08 ± 13.1% (k=2)
5500	± 50 / ± 100	Body	48.6 ± 5%	5.65 ± 5%	0.32	1.65	3.99 ± 13.1% (k=2)
5600	± 50 / ± 100	Body	48.5 ± 5%	5.77 ± 5%	0.34	1.65	4.09 ± 13.1% (k=2)
5800	± 50 / ± 100	Body	48.2 ± 5%	6.00 ± 5%	0.30	1.65	4.10 ± 13.1% (k=2)

^c The validity of ± 100 MHz only applies for DASY v4.4 and higher (see Page 2). The uncertainty is the RSS of the ConvF uncertainty at calibration frequency and the uncertainty for the indicated frequency band.

Deviation from Isotropy in HSL

Error (ϕ , θ), $f = 900$ MHz

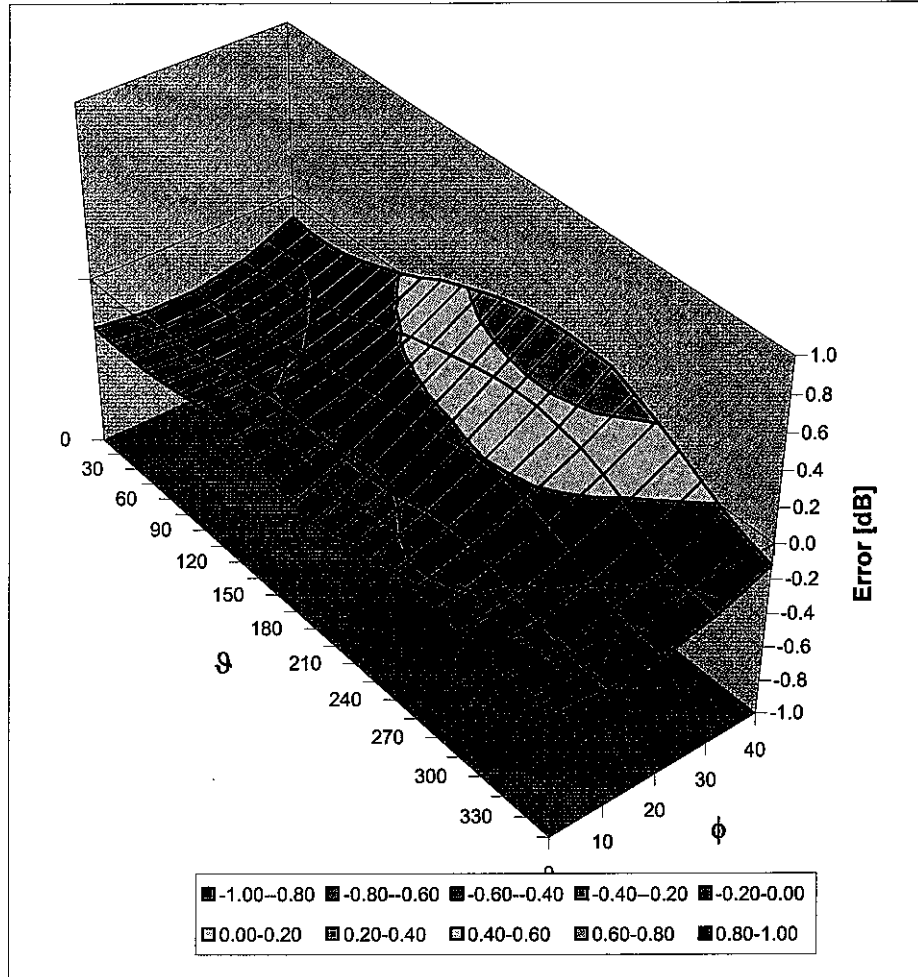

Uncertainty of Spherical Isotropy Assessment: $\pm 2.6\%$ ($k=2$)



Accredited by the Swiss Accreditation Service (SAS)
The Swiss Accreditation Service is one of the signatories to the EA
Multilateral Agreement for the recognition of calibration certificates

Accreditation No.: **SCS 108**

Client **ADT (Auden)**

Certificate No. **ET3-1790_Nov07**

CALIBRATION CERTIFICATE

Object **ET3DV6 - SN 1790**

Calibration procedure(s) **QA CAL-01 v6
Calibration procedure for dosimetric E-field probes**

Calibration date: **November 20, 2007**

Condition of the calibrated item **In Tolerance**

This calibration certificate documents the traceability to national standards, which realize the physical units of measurements (SI).
The measurements and the uncertainties with confidence probability are given on the following pages and are part of the certificate.

All calibrations have been conducted in the closed laboratory facility: environment temperature (22 ± 3)°C and humidity < 70%.

Calibration Equipment used (M&TE critical for calibration)

Primary Standards	ID #	Cal Date (Calibrated by, Certificate No.)	Scheduled Calibration
Power meter E4419B	GB41293874	29-Mar-07 (METAS, No. 217-00670)	Mar-08
Power sensor E4412A	MY41495277	29-Mar-07 (METAS, No. 217-00670)	Mar-08
Power sensor E4412A	MY41498087	29-Mar-07 (METAS, No. 217-00670)	Mar-08
Reference 3 dB Attenuator	SN: S5054 (3c)	8-Aug-07 (METAS, No. 217-00719)	Aug-08
Reference 20 dB Attenuator	SN: S5086 (20b)	29-Mar-07 (METAS, No. 217-00671)	Mar-08
Reference 30 dB Attenuator	SN: S5129 (30b)	8-Aug-07 (METAS, No. 217-00720)	Aug-08
Reference Probe ES3DV2	SN: 3013	4-Jan-07 (SPEAG, No. ES3-3013_Jan07)	Jan-08
DAE4	SN: 654	20-Apr-07 (SPEAG, No. DAE4-654_Apr07)	Apr-08
Secondary Standards	ID #	Check Date (in house)	Scheduled Check
RF generator HP 8648C	US3642U01700	4-Aug-99 (SPEAG, in house check Oct-07)	In house check: Oct-09
Network Analyzer HP 8753E	US37390585	18-Oct-01 (SPEAG, in house check Oct-07)	In house check: Oct-08

	Name	Function	Signature
Calibrated by:	Katja Pokovic	Technical Manager	
Approved by:	Niels Kusler	Quality Manager	

Issued: November 20, 2007

This calibration certificate shall not be reproduced except in full without written approval of the laboratory.



Accredited by the Swiss Accreditation Service (SAS)
The Swiss Accreditation Service is one of the signatories to the EA
Multilateral Agreement for the recognition of calibration certificates

Accreditation No.: **SCS 108**

Glossary:

TSL	tissue simulating liquid
NORM _{x,y,z}	sensitivity in free space
ConvF	sensitivity in TSL / NORM _{x,y,z}
DCP	diode compression point
Polarization ϕ	ϕ rotation around probe axis
Polarization ϑ	ϑ rotation around an axis that is in the plane normal to probe axis (at measurement center), i.e., $\vartheta = 0$ is normal to probe axis

Calibration is Performed According to the Following Standards:

- IEEE Std 1528-2003, "IEEE Recommended Practice for Determining the Peak Spatial-Averaged Specific Absorption Rate (SAR) in the Human Head from Wireless Communications Devices: Measurement Techniques", December 2003
- IEC 62209-1, "Procedure to measure the Specific Absorption Rate (SAR) for hand-held devices used in close proximity to the ear (frequency range of 300 MHz to 3 GHz)", February 2005

Methods Applied and Interpretation of Parameters:

- NORM_{x,y,z}**: Assessed for E-field polarization $\vartheta = 0$ ($f \leq 900$ MHz in TEM-cell; $f > 1800$ MHz: R22 waveguide). NORM_{x,y,z} are only intermediate values, i.e., the uncertainties of NORM_{x,y,z} does not effect the E²-field uncertainty inside TSL (see below *ConvF*).
- NORM(f)_{x,y,z} = NORM_{x,y,z} * frequency_response** (see Frequency Response Chart). This linearization is implemented in DASY4 software versions later than 4.2. The uncertainty of the frequency response is included in the stated uncertainty of *ConvF*.
- DCP_{x,y,z}**: DCP are numerical linearization parameters assessed based on the data of power sweep (no uncertainty required). DCP does not depend on frequency nor media.
- ConvF and Boundary Effect Parameters**: Assessed in flat phantom using E-field (or Temperature Transfer Standard for $f \leq 800$ MHz) and inside waveguide using analytical field distributions based on power measurements for $f > 800$ MHz. The same setups are used for assessment of the parameters applied for boundary compensation (alpha, depth) of which typical uncertainty values are given. These parameters are used in DASY4 software to improve probe accuracy close to the boundary. The sensitivity in TSL corresponds to NORM_{x,y,z} * ConvF whereby the uncertainty corresponds to that given for ConvF. A frequency dependent ConvF is used in DASY version 4.4 and higher which allows extending the validity from ± 50 MHz to ± 100 MHz.
- Spherical isotropy (3D deviation from isotropy)**: in a field of low gradients realized using a flat phantom exposed by a patch antenna.
- Sensor Offset**: The sensor offset corresponds to the offset of virtual measurement center from the probe tip (on probe axis). No tolerance required.

Probe ET3DV6

SN:1790

Manufactured:	May 28, 2003
Last calibrated:	November 23, 2006
Recalibrated:	November 20, 2007

Calibrated for DASY Systems

(Note: non-compatible with DASY2 system!)

DASY - Parameters of Probe: ET3DV6 SN:1790**Sensitivity in Free Space^A**

NormX	2.10 ± 10.1%	$\mu\text{V}/(\text{V}/\text{m})^2$
NormY	2.11 ± 10.1%	$\mu\text{V}/(\text{V}/\text{m})^2$
NormZ	1.77 ± 10.1%	$\mu\text{V}/(\text{V}/\text{m})^2$

Diode Compression^B

DCP X	92 mV
DCP Y	92 mV
DCP Z	92 mV

Sensitivity in Tissue Simulating Liquid (Conversion Factors)

Please see Page 8.

Boundary Effect**TSL 900 MHz Typical SAR gradient: 5 % per mm**

Sensor Center to Phantom Surface Distance		3.7 mm	4.7 mm
SAR _{be} [%]	Without Correction Algorithm	6.2	3.3
SAR _{be} [%]	With Correction Algorithm	0.8	0.5

TSL 1750 MHz Typical SAR gradient: 10 % per mm

Sensor Center to Phantom Surface Distance		3.7 mm	4.7 mm
SAR _{be} [%]	Without Correction Algorithm	12.2	8.1
SAR _{be} [%]	With Correction Algorithm	0.9	0.0

Sensor Offset

Probe Tip to Sensor Center	2.7 mm
----------------------------	---------------

The reported uncertainty of measurement is stated as the standard uncertainty of measurement multiplied by the coverage factor k=2, which for a normal distribution corresponds to a coverage probability of approximately 95%.

^A The uncertainties of NormX,Y,Z do not affect the E²-field uncertainty inside TSL (see Page 8).

^B Numerical linearization parameter: uncertainty not required.

Frequency Response of E-Field

(TEM-Cell:ifi110 EXX, Waveguide: R22)

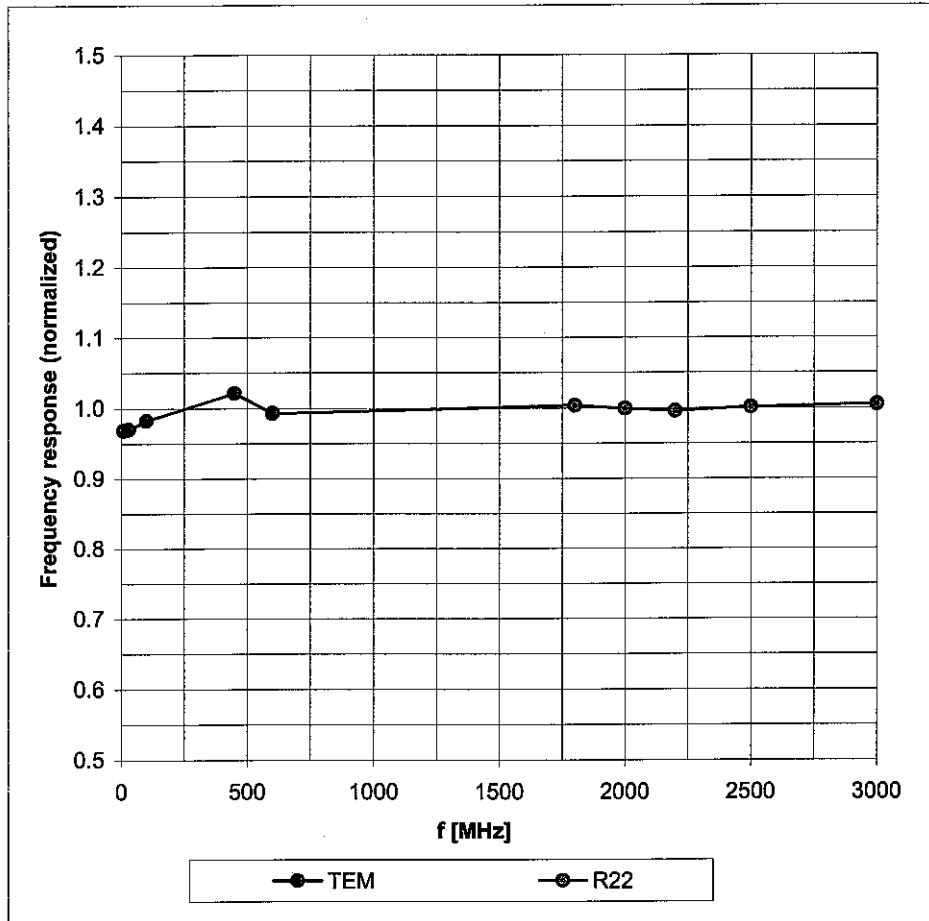

Uncertainty of Frequency Response of E-field: $\pm 6.3\%$ (k=2)

Receiving Pattern (ϕ), $\vartheta = 0^\circ$

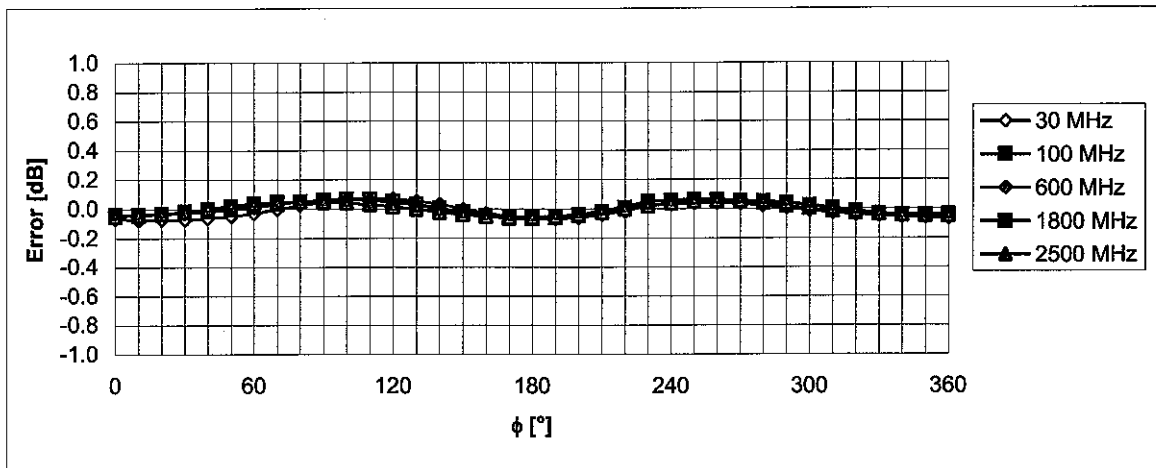
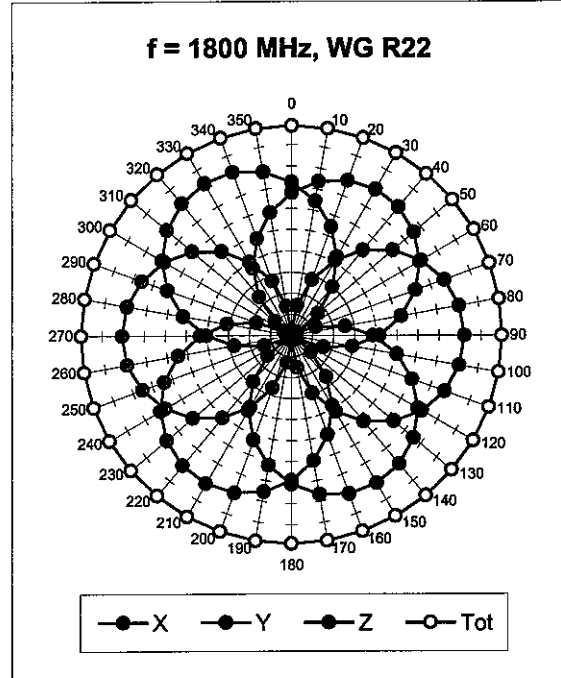
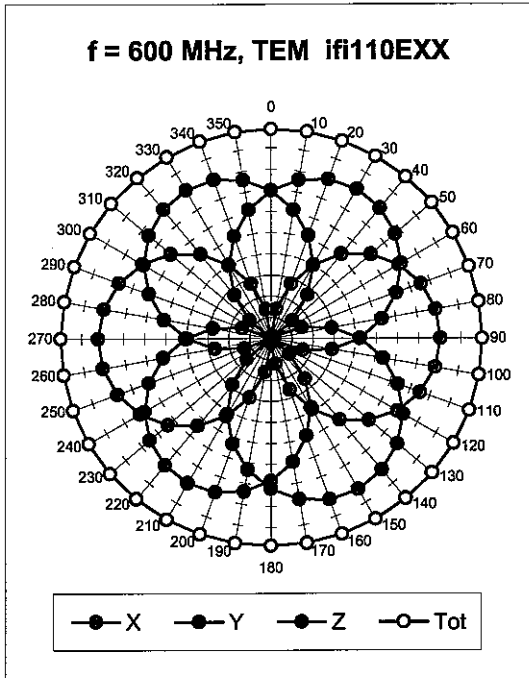

Uncertainty of Axial Isotropy Assessment: $\pm 0.5\%$ ($k=2$)

Dynamic Range f(SAR_{head}) (Waveguide R22, f = 1800 MHz)

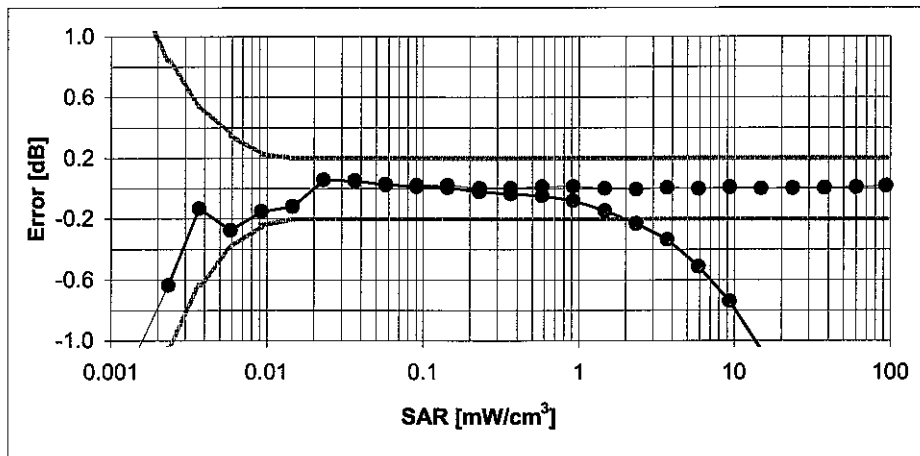
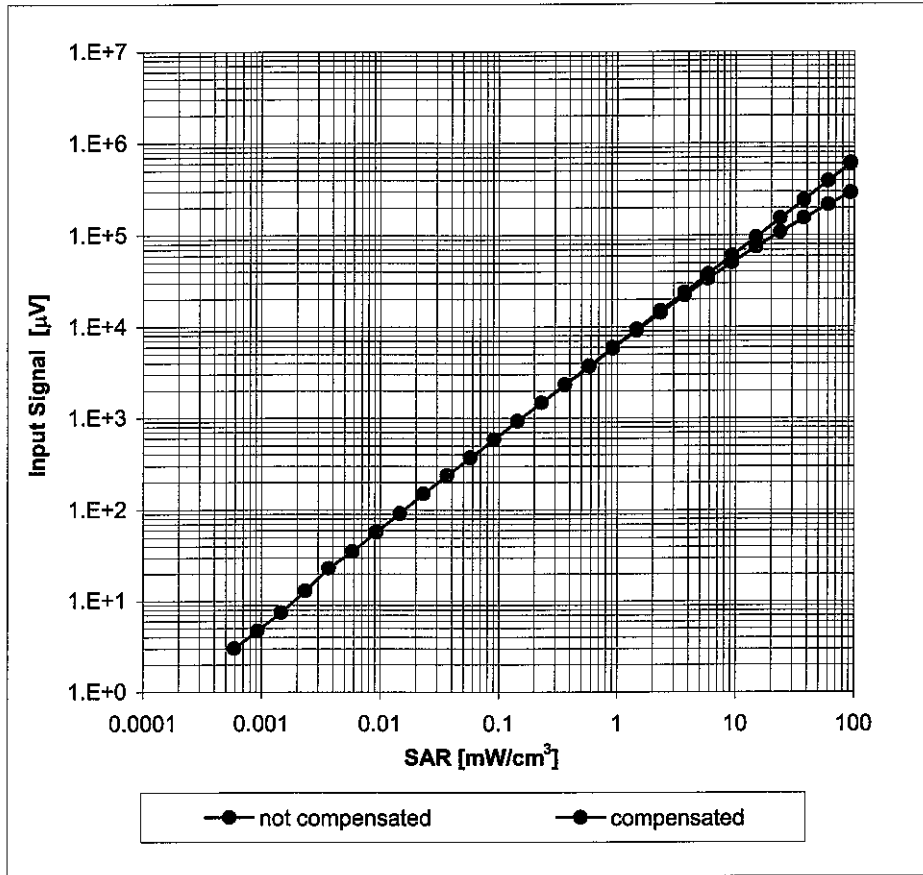

Uncertainty of Linearity Assessment: $\pm 0.6\%$ (k=2)

Conversion Factor Assessment

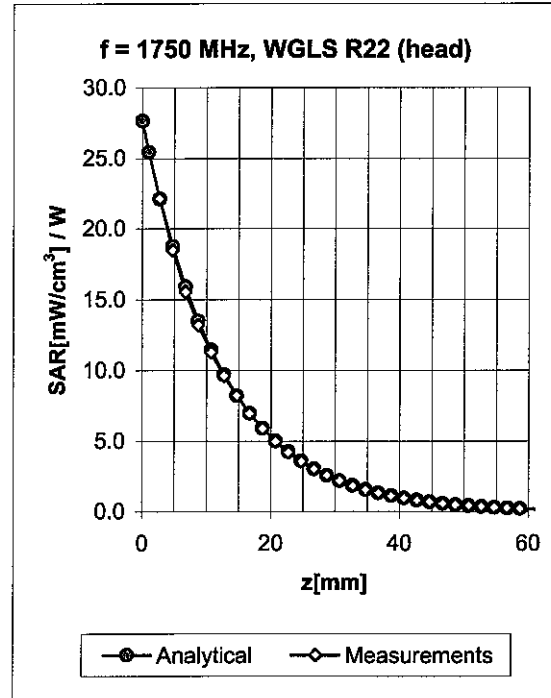
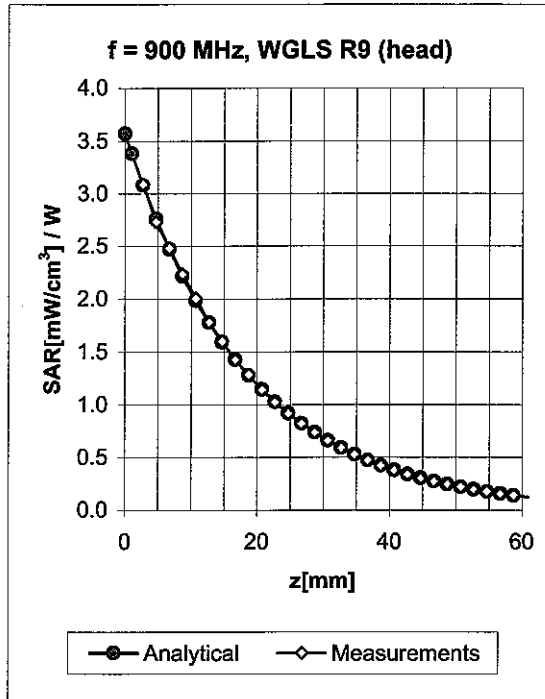

f [MHz]	Validity [MHz] ^c	TSL	Permittivity	Conductivity	Alpha	Depth	ConvF Uncertainty
900	± 50 / ± 100	Head	41.5 ± 5%	0.97 ± 5%	0.59	2.17	6.65 ± 11.0% (k=2)
1750	± 50 / ± 100	Head	40.1 ± 5%	1.37 ± 5%	0.59	2.28	5.42 ± 11.0% (k=2)
1950	± 50 / ± 100	Head	40.0 ± 5%	1.40 ± 5%	0.63	2.14	5.10 ± 11.0% (k=2)
2450	± 50 / ± 100	Head	39.2 ± 5%	1.80 ± 5%	0.74	1.94	4.74 ± 11.8% (k=2)
900	± 50 / ± 100	Body	55.0 ± 5%	1.05 ± 5%	0.67	2.06	6.15 ± 11.0% (k=2)
1750	± 50 / ± 100	Body	53.4 ± 5%	1.49 ± 5%	0.57	2.54	4.98 ± 11.0% (k=2)
1950	± 50 / ± 100	Body	53.3 ± 5%	1.52 ± 5%	0.60	2.49	4.58 ± 11.0% (k=2)
2450	± 50 / ± 100	Body	52.7 ± 5%	1.95 ± 5%	0.66	2.27	4.16 ± 11.8% (k=2)

^c The validity of ± 100 MHz only applies for DASY v4.4 and higher (see Page 2). The uncertainty is the RSS of the ConvF uncertainty at calibration frequency and the uncertainty for the indicated frequency band.

Deviation from Isotropy in HSL

Error (ϕ , θ), $f = 900$ MHz

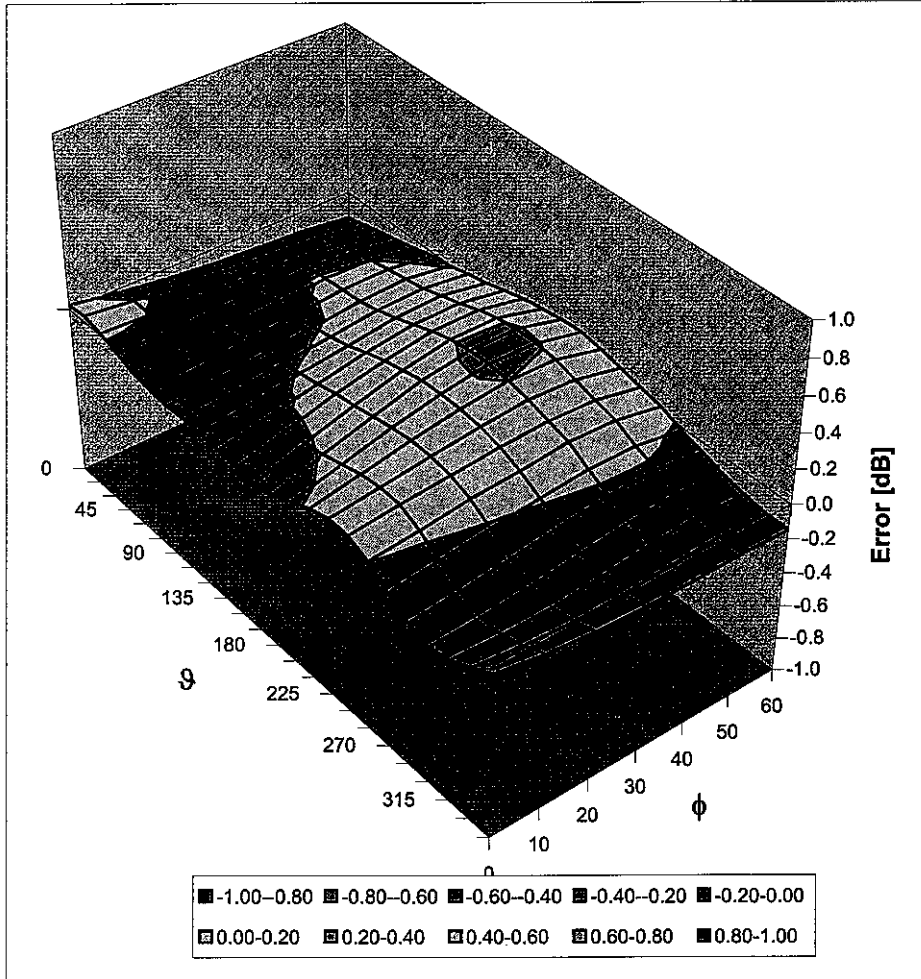

Uncertainty of Spherical Isotropy Assessment: $\pm 2.6\%$ ($k=2$)



Accredited by the Swiss Federal Office of Metrology and Accreditation
The Swiss Accreditation Service is one of the signatories to the EA
Multilateral Agreement for the recognition of calibration certificates

Accreditation No.: **SCS 108**

Client **ADT (Auden)**

Certificate No: **DAE3-510_Aug07**

CALIBRATION CERTIFICATE

Object **DAE3 - SD.000 D03 AA - SN: 510**

Calibration procedure(s) **QA CAL-06 v12
Calibration procedure for the data acquisition electronics (DAE)**

Calibration date: **August 29, 2007**

Condition of the calibrated item **In Tolerance**

This calibration certificate documents the traceability to national standards, which realize the physical units of measurements (SI).
The measurements and the uncertainties with confidence probability are given on the following pages and are part of the certificate.

All calibrations have been conducted in the closed laboratory facility: environment temperature (22 ± 3)°C and humidity < 70%.

Calibration Equipment used (M&TE critical for calibration)

Primary Standards	ID #	Cal Date (Calibrated by, Certificate No.)	Scheduled Calibration
Fluke Process Calibrator Type 702	SN: 6295803	13-Oct-06 (Elcal AG, No: 5492)	Oct-07
Keithley Multimeter Type 2001	SN: 0810278	03-Oct-06 (Elcal AG, No: 5478)	Oct-07
Secondary Standards	ID #	Check Date (in house)	Scheduled Check
Calibrator Box V1.1	SE UMS 006 AB 1004	25-Jun-07 (SPEAG, in house check)	In house check Jun-08

	Name	Function	Signature
Calibrated by:	Dominique Steffen	Technician	

	Name	Function	Signature
Approved by:	Fin Bornholt	R&D Director	

Issued: August 29, 2007

This calibration certificate shall not be reproduced except in full without written approval of the laboratory.



Glossary

DAE	data acquisition electronics
Connector angle	information used in DASY system to align probe sensor X to the robot coordinate system.

Methods Applied and Interpretation of Parameters

- *DC Voltage Measurement:* Calibration Factor assessed for use in DASY system by comparison with a calibrated instrument traceable to national standards. The figure given corresponds to the full scale range of the voltmeter in the respective range.
- *Connector angle:* The angle of the connector is assessed measuring the angle mechanically by a tool inserted. Uncertainty is not required.
- The following parameters contain technical information as a result from the performance test and require no uncertainty.
- *DC Voltage Measurement Linearity:* Verification of the Linearity at +10% and -10% of the nominal calibration voltage. Influence of offset voltage is included in this measurement.
- *Common mode sensitivity:* Influence of a positive or negative common mode voltage on the differential measurement.
- *Channel separation:* Influence of a voltage on the neighbor channels not subject to an input voltage.
- *AD Converter Values with inputs shorted:* Values on the internal AD converter corresponding to zero input voltage
- *Input Offset Measurement:* Output voltage and statistical results over a large number of zero voltage measurements.
- *Input Offset Current:* Typical value for information; Maximum channel input offset current, not considering the input resistance.
- *Input resistance:* DAE input resistance at the connector, during internal auto-zeroing and during measurement.
- *Low Battery Alarm Voltage:* Typical value for information. Below this voltage, a battery alarm signal is generated.
- *Power consumption:* Typical value for information. Supply currents in various operating modes.

DC Voltage Measurement

A/D - Converter Resolution nominal

High Range: 1LSB = 6.1 μ V, full range = -100...+300 mV

Low Range: 1LSB = 61nV, full range = -1.....+3mV

DASY measurement parameters: Auto Zero Time: 3 sec; Measuring time: 3 sec

Calibration Factors	X	Y	Z
High Range	404.150 \pm 0.1% (k=2)	404.218 \pm 0.1% (k=2)	404.585 \pm 0.1% (k=2)
Low Range	3.98817 \pm 0.7% (k=2)	3.97339 \pm 0.7% (k=2)	3.96897 \pm 0.7% (k=2)

Connector Angle

Connector Angle to be used in DASY system	42 $^{\circ}$ \pm 1 $^{\circ}$
---	----------------------------------

Appendix

1. DC Voltage Linearity

High Range	Input (μV)	Reading (μV)	Error (%)
Channel X + Input	200000	200000.7	0.00
Channel X + Input	20000	20006.63	0.03
Channel X - Input	20000	-19999.14	0.00
Channel Y + Input	200000	199999.5	0.00
Channel Y + Input	20000	20005.23	0.03
Channel Y - Input	20000	-20002.04	0.01
Channel Z + Input	200000	199999.6	0.00
Channel Z + Input	20000	20006.53	0.03
Channel Z - Input	20000	-20001.38	0.01

Low Range	Input (μV)	Reading (μV)	Error (%)
Channel X + Input	2000	2000	0.00
Channel X + Input	200	199.97	-0.01
Channel X - Input	200	-199.90	-0.05
Channel Y + Input	2000	2000.1	0.00
Channel Y + Input	200	199.64	-0.18
Channel Y - Input	200	-200.58	0.29
Channel Z + Input	2000	2000	0.00
Channel Z + Input	200	199.20	-0.40
Channel Z - Input	200	-200.81	0.41

2. Common mode sensitivity

DASY measurement parameters: Auto Zero Time: 3 sec; Measuring time: 3 sec

	Common mode Input Voltage (mV)	High Range Average Reading (μV)	Low Range Average Reading (μV)
Channel X	200	17.82	16.82
	- 200	-16.18	-16.83
Channel Y	200	14.68	14.20
	- 200	-15.70	-16.05
Channel Z	200	-8.25	-8.73
	- 200	8.01	8.08

3. Channel separation

DASY measurement parameters: Auto Zero Time: 3 sec; Measuring time: 3 sec

	Input Voltage (mV)	Channel X (μV)	Channel Y (μV)	Channel Z (μV)
Channel X	200	-	0.75	1.74
Channel Y	200	2.34	-	2.77
Channel Z	200	-1.43	0.25	-

4. AD-Converter Values with inputs shorted

DASY measurement parameters: Auto Zero Time: 3 sec; Measuring time: 3 sec

	High Range (LSB)	Low Range (LSB)
Channel X	15893	16120
Channel Y	16114	16051
Channel Z	16081	16196

5. Input Offset Measurement

DASY measurement parameters: Auto Zero Time: 3 sec; Measuring time: 3 sec

Input 10M Ω

	Average (μ V)	min. Offset (μ V)	max. Offset (μ V)	Std. Deviation (μ V)
Channel X	-0.67	-1.71	-0.06	0.26
Channel Y	-1.04	-3.37	0.35	0.34
Channel Z	-1.26	-3.29	0.15	0.35

6. Input Offset Current

Nominal Input circuitry offset current on all channels: <25fA

7. Input Resistance

	Zeroing (MOhm)	Measuring (MOhm)
Channel X	0.2001	198.5
Channel Y	0.2001	199.2
Channel Z	0.2000	200.3

8. Low Battery Alarm Voltage (verified during pre test)

Typical values	Alarm Level (VDC)
Supply (+ Vcc)	+7.9
Supply (- Vcc)	-7.6

9. Power Consumption (verified during pre test)

Typical values	Switched off (mA)	Stand by (mA)	Transmitting (mA)
Supply (+ Vcc)	+0.0	+6	+14
Supply (- Vcc)	-0.01	-8	-9



Accredited by the Swiss Federal Office of Metrology and Accreditation
The Swiss Accreditation Service is one of the signatories to the EA
Multilateral Agreement for the recognition of calibration certificates

Accreditation No.: **SCS 108**

Client **ADT (Auden)**

Certificate No: **D5GHzV2-1019_Jul07**

CALIBRATION CERTIFICATE

Object: **D5GHzV2 - SN 1019**

Calibration procedure(s): **QA CAL-22 v1
Calibration procedure for dipole validation kits between 3-6 GHz**

Calibration date: **July 11, 2007**

Condition of the calibrated item: **In Tolerance**

This calibration certificate documents the traceability to national standards, which realize the physical units of measurements (SI).
The measurements and the uncertainties with confidence probability are given on the following pages and are part of the certificate.

All calibrations have been conducted in the closed laboratory facility: environment temperature (22 ± 3)°C and humidity < 70%.

Calibration Equipment used (M&TE critical for calibration)

Primary Standards	ID #	Cal Date (Calibrated by, Certificate No.)	Scheduled Calibration
Power meter E4419B	GB41293874	29-Mar-07 (METAS, No. 217-00670)	Mar-08
Power sensor E4412A	MY41495277	29-Mar-07 (METAS, No. 217-00670)	Mar-08
Power sensor E4412A	MY41498087	29-Mar-07 (METAS, No. 217-00670)	Mar-08
Reference 20 dB Attenuator	SN: S5086 (20b)	29-Mar-07 (METAS, No. 217-00671)	Mar-08
Reference 10 dB Attenuator	SN: 5047.2 (10r)	10-Aug-06 (METAS, No 217-00591)	Aug-07
Reference Probe EX3DV4	SN: 3503	9-Mar-07 (SPEAG, No. EX3-3503_Mar07)	Mar-08
DAE4	SN 601	30-Jan-07 (SPEAG, No. DAE4-601_Jan07)	Jan-08

Secondary Standards	ID #	Check Date (in house)	Scheduled Check
RF generator R&S SMT-06	100005	4-Aug-99 (SPEAG, in house check Nov-05)	In house check: Nov-07
Network Analyzer HP 8753E	US37390585 S4206	18-Oct-01 (SPEAG, in house check Oct-06)	In house check: Oct-07

Calibrated by: **Claudio Leubler** (Name), **Laboratory Technician** (Function), *[Signature]* (Signature)

Approved by: **Katja Pokovic** (Name), **Technical Manager** (Function), *[Signature]* (Signature)

Issued: July 17, 2007

This calibration certificate shall not be reproduced except in full without written approval of the laboratory.



Accredited by the Swiss Federal Office of Metrology and Accreditation
The Swiss Accreditation Service is one of the signatories to the EA
Multilateral Agreement for the recognition of calibration certificates

Accreditation No.: **SCS 108**

Glossary:

TSL	tissue simulating liquid
ConvF	sensitivity in TSL / NORM x,y,z
N/A	not applicable or not measured

Calibration is Performed According to the Following Standards:

- a) IEC Std 62209 Part 2, "Evaluation of Human Exposure to Radio Frequency Fields from Handheld and Body-Mounted Wireless Communication Devices in the Frequency Range of 30 MHz to 6 GHz: Human models, Instrumentation, and Procedures"; Part 2: "Procedure to determine the Specific Absorption Rate (SAR) for including accessories and multiple transmitters", Draft Version 0.9, December 2004
- b) Federal Communications Commission Office of Engineering & Technology (FCC OET), "Evaluating Compliance with FCC Guidelines for Human Exposure to Radiofrequency Electromagnetic Fields; Additional Information for Evaluating Compliance of Mobile and Portable Devices with FCC Limits for Human Exposure to Radiofrequency Emissions", Supplement C (Edition 01-01) to Bulletin 65

Additional Documentation:

- c) DASy4 System Handbook

Methods Applied and Interpretation of Parameters:

- *Measurement Conditions:* Further details are available from the Validation Report at the end of the certificate. All figures stated in the certificate are valid at the frequency indicated.
- *Antenna Parameters with TSL:* The dipole is mounted with the spacer to position its feed point exactly below the center marking of the flat phantom section, with the arms oriented parallel to the body axis.
- *Feed Point Impedance and Return Loss:* These parameters are measured with the dipole positioned under the liquid filled phantom. The impedance stated is transformed from the measurement at the SMA connector to the feed point. The Return Loss ensures low reflected power. No uncertainty required.
- *Electrical Delay:* One-way delay between the SMA connector and the antenna feed point. No uncertainty required.
- *SAR measured:* SAR measured at the stated antenna input power.
- *SAR normalized:* SAR as measured, normalized to an input power of 1 W at the antenna connector.
- *SAR for nominal TSL parameters:* The measured TSL parameters are used to calculate the nominal SAR result.

Measurement Conditions

DASY system configuration, as far as not given on page 1.

DASY Version	DASY4	V4.7
Extrapolation	Advanced Extrapolation	
Phantom	Modular Flat Phantom V5.0	
Distance Dipole Center - TSL	10 mm	with Spacer
Area Scan resolution	dx, dy = 10 mm	
Zoom Scan Resolution	dx, dy = 4. mm, dz = 2.5 mm	
Frequency	5000 MHz ± 1 MHz 5200 MHz ± 1 MHz 5500 MHz ± 1 MHz 5800 MHz ± 1 MHz	

Head TSL parameters at 5000 MHz

The following parameters and calculations were applied.

	Temperature	Permittivity	Conductivity
Nominal Head TSL parameters	22.0 °C	36.2	4.45 mho/m
Measured Head TSL parameters	(22.0 ± 0.2) °C	35.6 ± 6 %	4.30 mho/m ± 6 %
Head TSL temperature during test	(22.0 ± 0.2) °C	---	---

SAR result with Head TSL at 5000 MHz

SAR averaged over 1 cm³ (1 g) of Head TSL	condition	
SAR measured	250 mW input power	19.5 mW / g
SAR normalized	normalized to 1W	78.0 mW / g
SAR for nominal Head TSL parameters ¹	normalized to 1W	77.6 mW / g ± 19.9 % (k=2)

SAR averaged over 10 cm³ (10 g) of Head TSL	condition	
SAR measured	250 mW input power	5.62 mW / g
SAR normalized	normalized to 1W	22.5 mW / g
SAR for nominal Head TSL parameters ¹	normalized to 1W	22.3 mW / g ± 19.5 % (k=2)

Head TSL parameters at 5200 MHz

The following parameters and calculations were applied.

	Temperature	Permittivity	Conductivity
Nominal Head TSL parameters	22.0 °C	36.0	4.66 mho/m
Measured Head TSL parameters	(22.0 ± 0.2) °C	35.2 ± 6 %	4.50 mho/m ± 6 %
Head TSL temperature during test	(22.0 ± 0.2) °C	---	---

¹ Correction to nominal TSL parameters according to c), chapter "SAR Sensitivities"

SAR result with Head TSL at 5200 MHz

SAR averaged over 1 cm ³ (1 g) of Head TSL	condition	
SAR measured	250 mW input power	19.6 mW / g
SAR normalized	normalized to 1W	78.4 mW / g
SAR for nominal Head TSL parameters ²	normalized to 1W	77.9 mW / g ± 19.9 % (k=2)

SAR averaged over 10 cm ³ (10 g) of Head TSL	condition	
SAR measured	250 mW input power	5.55 mW / g
SAR normalized	normalized to 1W	22.2 mW / g
SAR for nominal Head TSL parameters ¹	normalized to 1W	22.0 mW / g ± 19.5 % (k=2)

Head TSL parameters at 5500 MHz

The following parameters and calculations were applied.

	Temperature	Permittivity	Conductivity
Nominal Head TSL parameters	22.0 °C	35.6	4.96 mho/m
Measured Head TSL parameters	(22.0 ± 0.2) °C	34.6 ± 6 %	4.76 mho/m ± 6 %
Head TSL temperature during test	(22.0 ± 0.2) °C	---	---

SAR result with Head TSL at 5500 MHz

SAR averaged over 1 cm ³ (1 g) of Head TSL	condition	
SAR measured	250 mW input power	19.4 mW / g
SAR normalized	normalized to 1W	77.6 mW / g
SAR for nominal Head TSL parameters ¹	normalized to 1W	76.8 mW / g ± 19.9 % (k=2)

SAR averaged over 10 cm ³ (10 g) of Head TSL	condition	
SAR measured	250 mW input power	5.50 mW / g
SAR normalized	normalized to 1W	22.0 mW / g
SAR for nominal Head TSL parameters ¹	normalized to 1W	21.7 mW / g ± 19.5 % (k=2)

Head TSL parameters at 5800 MHz

The following parameters and calculations were applied.

	Temperature	Permittivity	Conductivity
Nominal Head TSL parameters	22.0 °C	35.3	5.27 mho/m
Measured Head TSL parameters	(22.0 ± 0.2) °C	34.1 ± 6 %	5.02 mho/m ± 6 %
Head TSL temperature during test	(22.0 ± 0.2) °C	---	---

² Correction to nominal TSL parameters according to c), chapter "SAR Sensitivities"

SAR result with Head TSL at 5800 MHz

SAR averaged over 1 cm ³ (1 g) of Head TSL	condition	
SAR measured	250 mW input power	18.7 mW / g
SAR normalized	normalized to 1W	77.6 mW / g
SAR for nominal Head TSL parameters ¹	normalized to 1W	76.6mW / g ± 19.9 % (k=2)

SAR averaged over 10 cm ³ (10 g) of Head TSL	condition	
SAR measured	250 mW input power	5.26W / g
SAR normalized	normalized to 1W	22.0 mW / g
SAR for nominal Head TSL parameters ¹	normalized to 1W	21.7 mW / g ± 19.5 % (k=2)

Body TSL parameters at 5000 MHz

The following parameters and calculations were applied.

	Temperature	Permittivity	Conductivity
Nominal Body TSL parameters	22.0 °C	49.3	5.07 mho/m
Measured Body TSL parameters	(22.0 ± 0.2) °C	48.5 ± 6 %	5.20 mho/m ± 6 %
Body TSL temperature during test	(21.4 ± 0.2) °C	---	---

SAR result with Body TSL at 5000 MHz

SAR averaged over 1 cm ³ (1 g) of Body TSL	condition	
SAR measured	250 mW input power	19.8 mW / g
SAR normalized	normalized to 1W	79.2 mW / g
SAR for nominal Body TSL parameters ¹	normalized to 1W	78.8 mW / g ± 19.9 % (k=2)

SAR averaged over 10 cm ³ (10 g) of Body TSL	condition	
SAR measured	250 mW input power	5.64 mW / g
SAR normalized	normalized to 1W	22.6 mW / g
SAR for nominal Body TSL parameters ¹	normalized to 1W	22.5 mW / g ± 19.5 % (k=2)

¹ Correction to nominal TSL parameters according to c), chapter "SAR Sensitivities"

Body TSL parameters at 5200 MHz

The following parameters and calculations were applied.

	Temperature	Permittivity	Conductivity
Nominal Body TSL parameters	22.0 °C	49.0	5.30 mho/m
Measured Body TSL parameters	(22.0 ± 0.2) °C	47.9 ± 6 %	5.47 mho/m ± 6 %
Body TSL temperature during test	(21.4 ± 0.2) °C	---	---

SAR result with Body TSL at 5200 MHz

SAR averaged over 1 cm ³ (1 g) of Body TSL	condition	
SAR measured	250 mW input power	19.5 mW / g
SAR normalized	normalized to 1W	78.0 mW / g
SAR for nominal Body TSL parameters ¹	normalized to 1W	77.4 mW / g ± 19.9 % (k=2)

SAR averaged over 10 cm ³ (10 g) of Body TSL	condition	
SAR measured	250 mW input power	5.49 mW / g
SAR normalized	normalized to 1W	22.0 mW / g
SAR for nominal Body TSL parameters ¹	normalized to 1W	21.9 mW / g ± 19.5 % (k=2)

Body TSL parameters at 5500 MHz

The following parameters and calculations were applied.

	Temperature	Permittivity	Conductivity
Nominal Body TSL parameters	22.0 °C	48.6	5.65 mho/m
Measured Body TSL parameters	(22.0 ± 0.2) °C	47.3 ± 6 %	5.87 mho/m ± 6 %
Body TSL temperature during test	(21.4 ± 0.2) °C	---	---

SAR result with Body TSL at 5500 MHz

SAR averaged over 1 cm ³ (1 g) of Body TSL	condition	
SAR measured	250 mW input power	19.8 mW / g
SAR normalized	normalized to 1W	79.2 mW / g
SAR for nominal Body TSL parameters ¹	normalized to 1W	78.6 mW / g ± 19.9 % (k=2)

SAR averaged over 10 cm ³ (10 g) of Body TSL	condition	
SAR measured	250 mW input power	5.58 mW / g
SAR normalized	normalized to 1W	22.3 mW / g
SAR for nominal Body TSL parameters ¹	normalized to 1W	22.2 mW / g ± 19.5 % (k=2)

¹ Correction to nominal TSL parameters according to c), chapter "SAR Sensitivities"

Body TSL parameters at 5800 MHz

The following parameters and calculations were applied.

	Temperature	Permittivity	Conductivity
Nominal Body TSL parameters	22.0 °C	48.2	6.00 mho/m
Measured Body TSL parameters	(22.0 ± 0.2) °C	46.7 ± 6 %	6.24 mho/m ± 6 %
Body TSL temperature during test	(21.4 ± 0.2) °C	---	---

SAR result with Body TSL at 5800 MHz

SAR averaged over 1 cm ³ (1 g) of Body TSL	condition	
SAR measured	250 mW input power	18.1 mW / g
SAR normalized	normalized to 1W	72.4mW / g
SAR for nominal Body TSL parameters ¹	normalized to 1W	71.8 mW / g ± 19.9 % (k=2)

SAR averaged over 10 cm ³ (10 g) of Body TSL	condition	
SAR measured	250 mW input power	5.08 mW / g
SAR normalized	normalized to 1W	20.3 mW / g
SAR for nominal Body TSL parameters ¹	normalized to 1W	20.2 mW / g ± 19.5 % (k=2)

¹ Correction to nominal TSL parameters according to c), chapter "SAR Sensitivities"

Appendix

Antenna Parameters with Head TSL at 5000 MHz

Impedance, transformed to feed point	50.8 Ω - 11.4 j Ω
Return Loss	-18.9 dB

Antenna Parameters with Head TSL at 5200 MHz

Impedance, transformed to feed point	52.9 Ω - 6.7 j Ω
Return Loss	-23.0 dB

Antenna Parameters with Head TSL at 5500 MHz

Impedance, transformed to feed point	51.6 Ω - 1.4 j Ω
Return Loss	-33.5 dB

Antenna Parameters with Head TSL at 5800 MHz

Impedance, transformed to feed point	57.0 Ω + 2.8 j Ω
Return Loss	-23.1 dB

Antenna Parameters with Body TSL at 5000 MHz

Impedance, transformed to feed point	49.7 Ω - 10.4 j Ω
Return Loss	-19.7 dB

Antenna Parameters with Body TSL at 5200 MHz

Impedance, transformed to feed point	52.6 Ω - 5.7 j Ω
Return Loss	-24.3 dB

Antenna Parameters with Body TSL at 5500 MHz

Impedance, transformed to feed point	51.7 Ω - 0.3 j Ω
Return Loss	-35.4 dB

Antenna Parameters with Body TSL at 5800 MHz

Impedance, transformed to feed point	57.5 Ω + 4.3 j Ω
Return Loss	-21.9 dB

General Antenna Parameters and Design

Electrical Delay (one direction)	1.205 ns
----------------------------------	----------

After long term use with 40 W radiated power, only a slight warming of the dipole near the feedpoint can be measured.

The dipole is made of standard semirigid coaxial cable. The center conductor of the feeding line is directly connected to the second arm of the dipole. The antenna is therefore short-circuited for DC-signals.

No excessive force must be applied to the dipole arms, because they might bend or the soldered connections near the feedpoint may be damaged.

Additional EUT Data

Manufactured by	SPEAG
Manufactured on	February 05, 2004

DASY4 Validation Report for Head TSL

Date/Time: 11.07.2007 12:24:27

Test Laboratory: SPEAG, Zurich, Switzerland

DUT: Dipole 5GHz; Type: D5GHz; Serial: D5GHzV2 - SN:1019

Communication System: CW-5GHz; Frequency: 5000 MHz Frequency: 5200 MHz

Frequency: 5500 MHz Frequency: 5800 MHz; Duty Cycle: 1:1

Medium: HSL 5800 MHz;

Medium parameters used: $f = 5000$ MHz; $\sigma = 4.3$ mho/m; $\epsilon_r = 35.6$; $\rho = 1000$ kg/m³

Medium parameters used: $f = 5200$ MHz; $\sigma = 4.5$ mho/m; $\epsilon_r = 35.2$; $\rho = 1000$ kg/m³

Medium parameters used: $f = 5500$ MHz; $\sigma = 4.76$ mho/m; $\epsilon_r = 34.6$; $\rho = 1000$ kg/m³

Medium parameters used: $f = 5800$ MHz; $\sigma = 5.02$ mho/m; $\epsilon_r = 34.1$; $\rho = 1000$ kg/m³

Phantom section: Flat Section

Measurement Standard: DASY4 (High Precision Assessment)

DASY4 Configuration:

- Probe: EX3DV4 - SN3503; ConvF(5.98, 5.98, 5.98)ConvF(5.56, 5.56, 5.56)ConvF(5.2, 5.2, 5.2)ConvF(4.97, 4.97, 4.97); Calibrated: 09.03.2007
- Sensor-Surface: 2mm (Mechanical Surface Detection)
- Electronics: DAE4 Sn601; Calibrated: 30.01.2007
- Phantom: Flat Phantom 5.0 (front); Type: QD000P50AA; ;
- Measurement SW: DASY4, V4.7 Build 53; Postprocessing SW: SEMCAD, V1.8 Build 172

d=10mm, Pin=250mW, f=5000 MHz/Zoom Scan (8x8x8), dist=2mm (8x8x8)/Cube 0:

Measurement grid: dx=4.0mm, dy=4.0mm, dz=2.5mm

Reference Value = 77.8 V/m; Power Drift = 0.105 dB

Peak SAR (extrapolated) = 70.5 W/kg

SAR(1 g) = 19.5 mW/g; SAR(10 g) = 5.62 mW/g

Maximum value of SAR (measured) = 36.9 mW/g

d=10mm, Pin=250mW, f=5200 MHz/Zoom Scan (8x8x8), dist=2mm (8x8x8)/Cube 0:

Measurement grid: dx=4.0mm, dy=4.0mm, dz=2.5mm

Reference Value = 76.2 V/m; Power Drift = 0.107 dB

Peak SAR (extrapolated) = 73.1 W/kg

SAR(1 g) = 19.6 mW/g; SAR(10 g) = 5.55 mW/g

Maximum value of SAR (measured) = 38.2 mW/g

d=10mm, Pin=250mW, f=5500 MHz/Zoom Scan (8x8x10), dist=2mm 2 (8x8x10)/Cube 0:

Measurement grid: dx=4mm, dy=4mm, dz=2.5mm

Reference Value = 74.4 V/m; Power Drift = 0.040 dB

Peak SAR (extrapolated) = 75.7 W/kg

SAR(1 g) = 19.4 mW/g; SAR(10 g) = 5.5 mW/g

Maximum value of SAR (measured) = 40.6 mW/g

d=10mm, Pin=250mW, f=5800 MHz/Zoom Scan (8x8x10), dist=2mm (8x8x10)/Cube 0:
Measurement grid: dx=4mm, dy=4mm, dz=2.5mm
Reference Value = 70.9 V/m; Power Drift = 0.042 dB
Peak SAR (extrapolated) = 78.6 W/kg
SAR(1 g) = 18.7 mW/g; SAR(10 g) = 5.26 mW/g

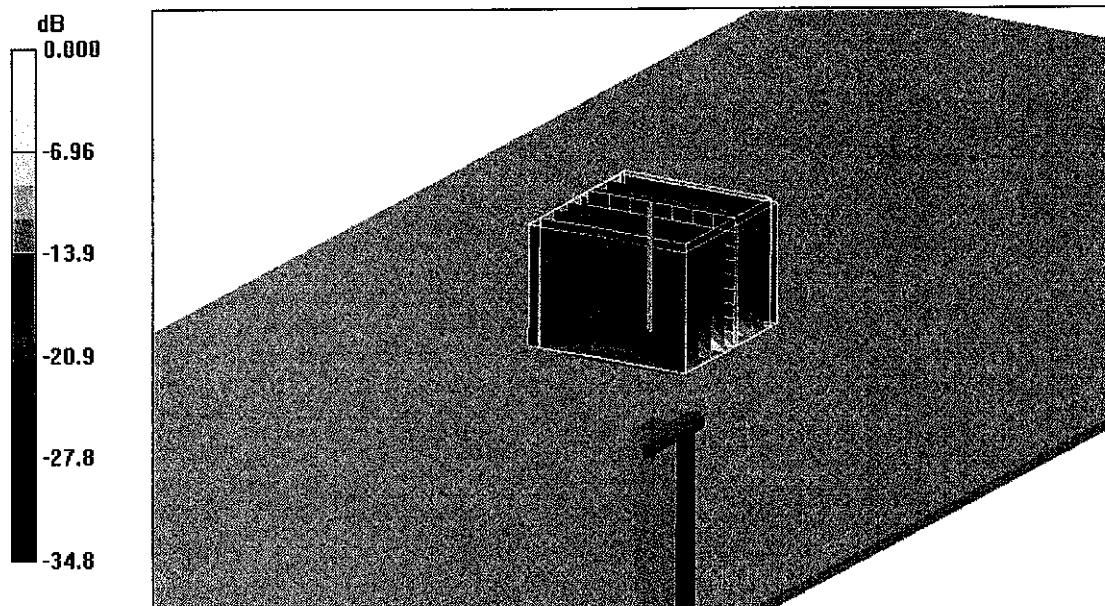

0 dB = 40.6mW/g

Impedance Measurement Plot for Head TSL

11 JUN 2007 09:13:42
 1: 50.787 Ω -11.432 nF 2.7845 pF 5 000.000 000 MHz

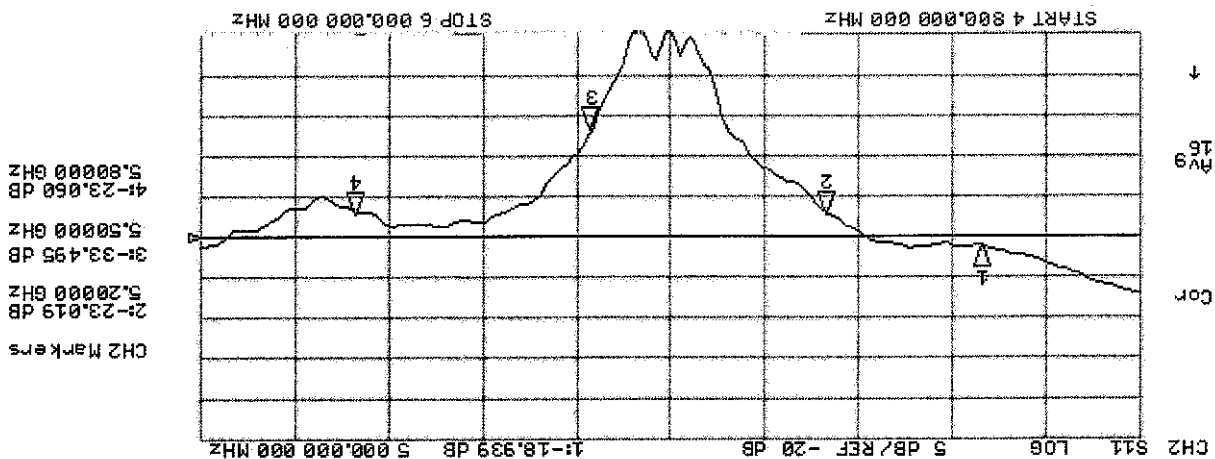
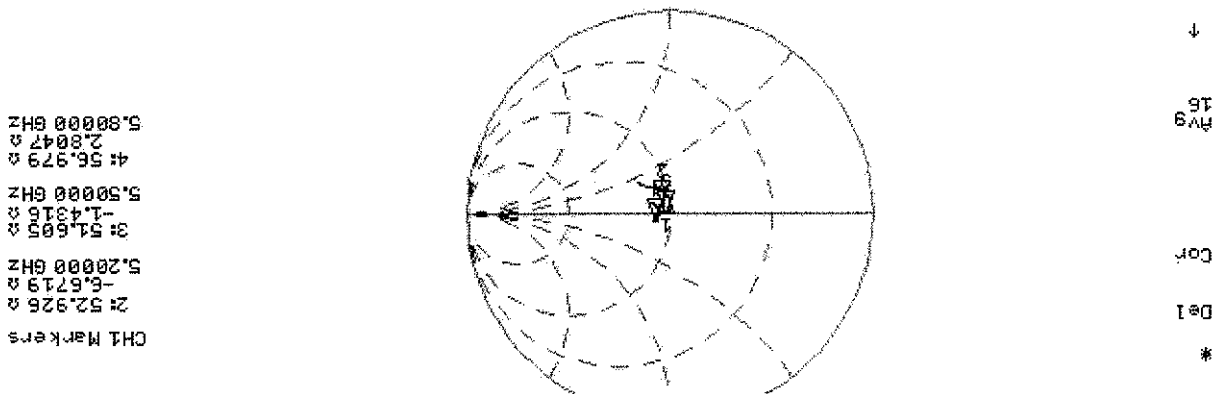

DASY4 Validation Report for Body TSL

Date/Time: 11.07.2007 16:58:40

Test Laboratory: SPEAG, Zurich, Switzerland

DUT: Dipole 5GHz; Type: D5GHz; Serial: D5GHzV2 - SN:1019

Communication System: CW-5GHz; Frequency: 5200 MHz Frequency: 5000 MHz Frequency: 5500 MHz
Frequency: 5800 MHz; Duty Cycle: 1:1

Medium: MSL 5800 MHz;

Medium parameters used: $f = 5200$ MHz; $\sigma = 5.52$ mho/m; $\epsilon_r = 47.9$; $\rho = 1000$ kg/m³

Medium parameters used: $f = 5000$ MHz; $\sigma = 5.2$ mho/m; $\epsilon_r = 48.5$; $\rho = 1000$ kg/m³

Medium parameters used: $f = 5500$ MHz; $\sigma = 5.92$ mho/m; $\epsilon_r = 47.3$; $\rho = 1000$ kg/m³

Medium parameters used: $f = 5800$ MHz; $\sigma = 6.29$ mho/m; $\epsilon_r = 46.7$; $\rho = 1000$ kg/m³

Phantom section: Flat Section

Measurement Standard: DASY4 (High Precision Assessment)

DASY4 Configuration:

- Probe: EX3DV4 - SN3503; ConvF(4.96, 4.96, 4.96)ConvF(5.13, 5.13, 5.13)ConvF(4.63, 4.63, 4.63)ConvF(4.76, 4.76, 4.76);
Calibrated: 09.03.2007
- Sensor-Surface: 2mm (Mechanical Surface Detection)
- Electronics: DAE4 Sn601; Calibrated: 30.01.2007
- Phantom: Flat Phantom 5.0 (back); Type: QD000P50AA; ;
- Measurement SW: DASY4, V4.7 Build 53; Postprocessing SW: SEMCAD, V1.8 Build 171

d=10mm, Pin=250mW, f=5000 MHz/Zoom Scan (8x8x10), dist=2mm (8x8x10)/Cube 0:

Measurement grid: dx=4mm, dy=4mm, dz=2.5mm

Reference Value = 79.0 V/m; Power Drift = -0.097 dB

Peak SAR (extrapolated) = 68.4 W/kg

SAR(1 g) = 19.8 mW/g; SAR(10 g) = 5.64 mW/g

Maximum value of SAR (measured) = 37.7 mW/g

d=10mm, Pin=250mW, f=5200 MHz,Zoom Scan (8x8x10), dist=2mm (8x8x10)/Cube 0:

Measurement grid: dx=4mm, dy=4mm, dz=2.5mm

Reference Value = 75.9 V/m; Power Drift = -0.041 dB

Peak SAR (extrapolated) = 69.5 W/kg

SAR(1 g) = 19.5 mW/g; SAR(10 g) = 5.49 mW/g

Maximum value of SAR (measured) = 38.0 mW/g

d=10mm, Pin=250mW, f=5500 MHz/Zoom Scan (8x8x10), dist=2mm 2 (8x8x10)/Cube 0:

Measurement grid: dx=4mm, dy=4mm, dz=2.5mm

Reference Value = 73.5 V/m; Power Drift = -0.055 dB

Peak SAR (extrapolated) = 76.3 W/kg

SAR(1 g) = 19.8 mW/g; SAR(10 g) = 5.58 mW/g

Maximum value of SAR (measured) = 39.1 mW/g

d=10mm, Pin=250mW, f=5800 MHz/Zoom Scan (8x8x10), dist=2mm (8x8x10)/Cube 0:
Measurement grid: dx=4mm, dy=4mm, dz=2.5mm
Reference Value = 68.1 V/m; Power Drift = -0.096 dB
Peak SAR (extrapolated) = 72.3 W/kg
SAR(1 g) = 18.1 mW/g; SAR(10 g) = 5.08 mW/g
Maximum value of SAR (measured) = 36.1 mW/g

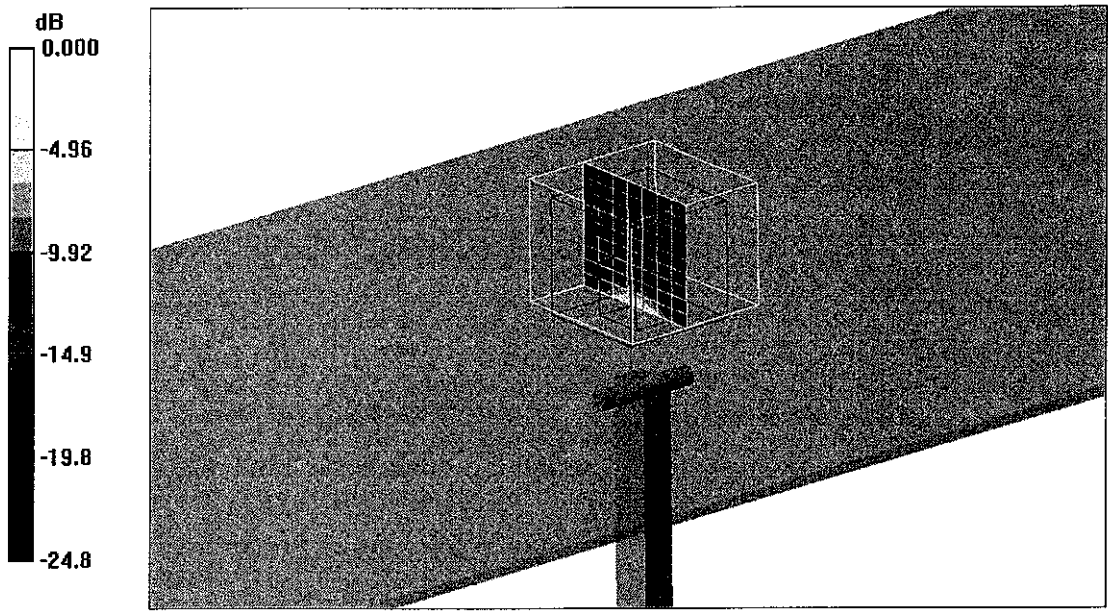

0 dB = 95.6mW/g

Impedance Measurement Plot for Body TSL

11 Jul 2007 09:16:50

CH1 S11 1 U FS 1: 49.668 Ω -10.422 Ω 3.0542 pF 5 000.000 000 MHz

*
Del
Cor
Avg
16
↑

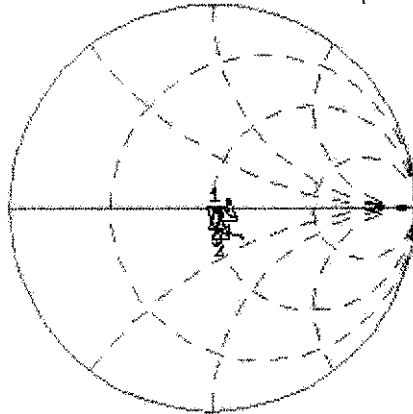

CH1 Markers

2: 52.648 Ω
-5.7090 Ω
5.20000 GHz
3: 51.721 Ω
-259.77 m Ω
5.50000 GHz
4: 57.482 Ω
4.3398 Ω
5.80000 GHz

CH2 S11 LOG 5 dB/REF -20 dB 1: -19.654 dB 5 000.000 000 MHz

Cor
Avg
16
↑

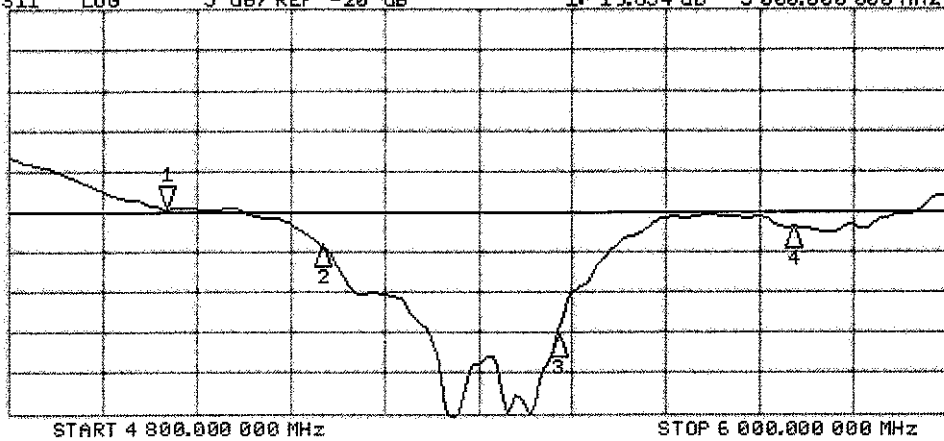

CH2 Markers

2: -24.251 dB
5.20000 GHz
3: -35.388 dB
5.50000 GHz
4: -21.892 dB
5.80000 GHz