



SAR TEST REPORT (15.407)

REPORT NO.: SA970216L05-3

MODEL NO.: MC7598

RECEIVED: Feb. 17, 2008

TESTED: Feb. 21, ~ Feb. 23, 2008

ISSUED: Mar. 03, 2008

APPLICANT: Symbol Technologies, Inc.

ADDRESS: One Symbol Plaza, Holtsville, NY 11742-1300
USA

ISSUED BY: Advance Data Technology Corporation

LAB ADDRESS: 47 14th Ling, Chia Pau Tsuen, Lin Kou Hsiang
244, Taipei Hsien, Taiwan, R.O.C.

TEST LOCATION: No. 19, Hwa Ya 2nd Rd., Wen Hwa Tsuen, Kwei
Shan Hsiang, Taoyuan Hsien 333, Taiwan,
R.O.C.

This test report consists of 45 pages in total except Appendix. It may be duplicated completely for legal use with the approval of the applicant. It should not be reproduced except in full, without the written approval of our laboratory. The client should not use it to claim product endorsement by TAF, A2LA or any government agencies. The test results in the report only apply to the tested sample.





TABLE OF CONTENTS

1.	CERTIFICATION	3
2.	GENERAL INFORMATION.....	4
2.1	GENERAL DESCRIPTION OF EUT	4
2.2	GENERAL DESCRIPTION OF APPLIED STANDARDS	6
2.3	GENERAL INFORMATION OF THE SAR SYSTEM	7
2.4	GENERAL DESCRIPTION OF THE SPATIAL PEAK SAR EVALUATION.....	10
3.	DESCRIPTION OF SUPPORT UNITS	13
4.	DESCRIPTION OF TEST MODES AND CONFIGURATIONS	14
4.1.	DESCRIPTION OF TEST MODE	14
4.2.	SUMMARY OF TEST RESULTS	15
5.	TEST RESULTS	17
5.1	TEST PROCEDURES	17
5.2	MEASURED SAR RESULTS.....	19
5.3	SAR LIMITS.....	27
5.4	RECIPES FOR TISSUE SIMULATING LIQUIDS	28
5.5	TEST EQUIPMENT FOR TISSUE PROPERTY	32
6.	SYSTEM VALIDATION	33
6.1	TEST EQUIPMENT	33
6.2	TEST PROCEDURE.....	34
6.3	VALIDATION RESULTS	36
6.4	SYSTEM VALIDATION UNCERTAINTIES	37
7.	MEASUREMENT SAR PROCEDURE UNCERTAINTIES.....	38
7.1.	PROBE CALIBRATION UNCERTAINTY	38
7.2.	ISOTROPY UNCERTAINTY	39
7.3.	BOUNDARY EFFECT UNCERTAINTY.....	39
7.4.	PROBE LINEARITY UNCERTAINTY	40
7.5.	READOUT ELECTRONICS UNCERTAINTY	40
7.6.	RESPONSE TIME UNCERTAINTY	40
7.7.	INTEGRATION TIME UNCERTAINTY	41
7.8.	PROBE POSITIONER MECHANICAL TOLERANCE	42
7.9.	PROBE POSITIONING	42
7.10.	PHANTOM UNCERTAINTY	43
7.11.	DASY4 UNCERTAINTY BUDGET (FOR 5 ~ 6GHz)	44
8.	INFORMATION ON THE TESTING LABORATORIES	45
	APPENDIX A: TEST CONFIGURATIONS AND TEST DATA	
	APPENDIX B: ADT SAR MEASUREMENT SYSTEM	
	APPENDIX C: PHOTOGRAPHS OF SYSTEM VALIDATION	
	APPENDIX D: SYSTEM CERTIFICATE & CALIBRATION	



1. CERTIFICATION

PRODUCT: EDA (Enterprise Digital Assistant)
MODEL: MC7598
BRAND: Symbol
APPLICANT: Symbol Technologies, Inc.
TESTED : Feb. 21, ~ Feb. 23, 2008
TEST SAMPLE: PROTOTYPE
STANDARDS: **FCC Part 2 (Section 2.1093)**
FCC OET Bulletin 65, Supplement C (01-01)
RSS-102
IEEE 1528-2003

The above equipment (model: MC7598) have been tested by **Advance Data Technology Corporation**, and found compliance with the requirement of the above standards. The test record, data evaluation & Equipment Under Test (EUT) configurations represented herein are true and accurate accounts of the measurements of the sample's EMC characteristics under the conditions specified in this report.

PREPARED BY :  , **DATE:** Mar. 03, 2008
Joanna Wang / Senior Specialist

TECHNICAL ACCEPTANCE :  , **DATE:** Mar. 03, 2008
Responsible for RF James Fan / Engineer

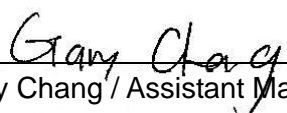
APPROVED BY :  , **DATE:** Mar. 03, 2008
Gary Chang / Assistant Manager

2. GENERAL INFORMATION

2.1 GENERAL DESCRIPTION OF EUT

PRODUCT	EDA (Enterprise Digital Assistant)
MODEL NO.	MC7598
FCC ID	H9PMC7598
POWER SUPPLY	3.7Vdc from rechargeable lithium battery 5.4Vdc from power adapter
CLASSIFICATION	Portable device, production unit
MODULATION TYPE	CCK, DQPSK, DBPSK for DSSS 64QAM, 16QAM, QPSK, BPSK for OFDM
RADIO TECHNOLOGY	DSSS, OFDM
TRANSFER RATE	54, 48, 36, 24, 18, 12, 9, 6Mbps
FREQUENCY RANGE	5150 ~ 5350MHz & 5470 ~ 5725MHz
NUMBER OF CHANNEL	5150 ~ 5350MHz: 8 5470 ~ 5725MHz: 11
CHANNEL FREQUENCIES UNDER TEST AND ITS CONDUCTED OUTPUT POWER	12.94mW / Ch36: 5180MHz 12.94mW / Ch40: 5200MHz 12.79mW / Ch48: 5240MHz 13.34mW / Ch52: 5260MHz 15.14mW / Ch60: 5300MHz 16.41mW / Ch64: 5320MHz 17.74mW / Ch100: 5500MHz 26.36mW / Ch104: 5520MHz 26.55mW / Ch116: 5580MHz 26.55mW / Ch120: 5600MHz 27.10mW / Ch124: 5620MHz 26.85mW / Ch136: 5680MHz 8.09mW / Ch140: 5700MHz
AVERAGE SAR (1g)	Head: 1.080W/kg Body: 0.101W/kg
ANTENNA TYPE(S)	Inverted F antenna Planar inverted antenna
MAX. ANTENNA GAIN	3.5dBi
DATA CABLE	Refer to NOTE
I/O PORTS	Refer to user's manual
ACCESSORY DEVICES	Battery

NOTE:

1. The models as identified below are identical to each other except of the following options:
 - Keypad: Numeric / QWERTY
 - Barcode reader: 1D laser scanner / 2D Imager

BRAND	MODEL	DESCRIPTION
Symbol	MC7598	EVDO 1D Numeric
Symbol	MC7598	EVDO 2D QWERTY
**the worst case had been marked by boldface.		

2. The EUT is an EDA (Enterprise Digital Assistant). The functions of EUT listed as below:

	REFERENCE REPORT
WLAN 802.11a/b/g (15.247) + BLUETOOTH	SA970216L05-2
WLAN 802.11a (15.407)	SA970216L05-3
CDMA 850 + CDMA 1900	SA970216L05
MOBILE + WLAN + BLUETOOTH (CO-LOCATED)	SA970216L05-1

3. The communicated functions of EUT listed as below:

		850MHz	1900MHz	With 802.11a/b/g + Bluetooth + GPS functions
3G	CDMA	√	√	
	EVDO	√	√	

4. The EUT has one lithium battery listed as below:

LI-LON BATTERY	
BRAND:	MOTOROLA
MODEL:	82-71364-05 Rev A
RATING:	3.7Vdc, 3600mAh

5. The following accessories are for support units only.

PRODUCT	BRAND	MODEL	DESCRIPTION
RS232 charging cable	Motorola	25-102776-01R	1.2m non-shielded cable with one core
USB charging cable	Motorola	25-102775-01R	1.5m shielded cable with one core
Headset	Motorola	50-11300-050R	VR10 headset 0.8m non-shielded cable with one core
Power Supply Adaptor	Motorola	EADP-16BB A	I/P: 100-240Vac, 50-60Hz, 0.4A O/P: 5.4Vdc, 3A 1.8m non-shielded cable without core
Holster	Motorola	SG-MC7011110-01R	Ridged holster

6. Hardware version: 1c.
7. Software version: BSP16.
8. Output power of aux path is lower than main path, we test max power channel of 5GHz to confirm sar value of aux antenna comply with limit.
9. The above EUT information was declared by manufacturer and for more detailed features description, please refer to the manufacturer's specifications or User's Manual.



2.2 GENERAL DESCRIPTION OF APPLIED STANDARDS

According to the specifications of the manufacturer, this product must comply with the requirements of the following standards:

FCC Part 2 (2.1093)

FCC OET Bulletin 65, Supplement C (01- 01)

RSS-102

IEEE 1528-2003

All test items have been performed and recorded as per the above standards.



2.3 GENERAL INFORMATION OF THE SAR SYSTEM

DASY4 (software 4.7 Build 53) consists of high precision robot, probe alignment sensor, phantom, robot controller, controlled measurement server and near-field probe. The robot includes six axes that can move to the precision position of the DASY4 software defined. The DASY4 software can define the area that is detected by the probe. The robot is connected to controlled box. Controlled measurement server is connected to the controlled robot box. The DAE includes amplifier, signal multiplexing, AD converter, offset measurement and surface detection. It is connected to the Electro-optical coupler (ECO). The ECO performs the conversion from the optical into digital electric signal of the DAE and transfers data to the PC.

EX3DV3 ISOTROPIC E-FIELD PROBE (FREQUENCY BAND 5 ~ 6GHz)

DIMENSIONS

Overall length: 330 mm (Tip Length: 20 mm)
Tip diameter: 2.5 mm (Body diameter: 12 mm)
Distance from probe tip to dipole centers: 1.0 mm

APPLICATION

General dosimetric measurements range 5 ~ 6 GHz.
Fast automatic scanning in arbitrary phantoms (EX3DV3)

NOTE

1. The Probe parameters have been calibrated by the SPEAG. Please reference "APPENDIX D" for the Calibration Certification Report.
2. For frequencies above 800 MHz, calibration in a rectangular wave-guide is used, because wave-guide size is manageable.
3. For frequencies below 800 MHz, temperature transfer calibration is used because the wave-guide size becomes relatively large.



TWIN SAM V4.0

CONSTRUCTION

The shell corresponds to the specifications of the Specific Anthropomorphic Mannequin (SAM) phantom defined in IEEE 1528-2003, CENELEC 50361 and IEC 62209. It enables the dosimetric evaluation of left and right hand phone usage as well as body mounted usage at the flat phantom region. A cover prevents evaporation of the liquid. Reference markings on the phantom allow the complete setup of all predefined phantom positions and measurement grids by manually teaching three points with the robot.

SHELL THICKNESS

2 ± 0.2mm

FILLING VOLUME

Approx. 25liters

DIMENSIONS

Height: 810mm; Length: 1000mm; Width: 500mm

SYSTEM VALIDATION KITS:

CONSTRUCTION

Symmetrical dipole with 1/4 balun enables measurement of feedpoint impedance with NWA matched for use near flat phantoms filled with brain simulating solutions. Includes distance holder and tripod adaptor

CALIBRATION

Calibrated SAR value for specified position and input power at the flat phantom in brain simulating solutions

FREQUENCY

5200, 5500, 5800MHz

RETURN LOSS

> 20dB at specified validation position

POWER CAPABILITY

> 100W (f < 1GHz); > 40W (f > 1GHz)

OPTIONS

Dipoles for other frequencies or solutions and other calibration conditions upon request

DEVICE HOLDER FOR SAM TWIN PHANTOM

CONSTRUCTION

The device holder for the mobile phone device is designed to cope with different positions given in the standard. It has two scales for the device rotation (with respect to the body axis) and the device inclination (with respect to the line between the ear reference points). The rotation centers for both scales is the ear reference point (ERP). Thus the device needs no repositioning when changing the angles. The holder has been made out of low-loss POM material having the following dielectric parameters: relative permittivity $\epsilon = 3$ and loss tangent $\delta = 0.02$. The amount of dielectric material has been reduced in the closest vicinity of the device, since measurements have suggested that the influence of the clamp on the test results could thus be lowered. The device holder for the portable device makes up of the polyethylene foam. The dielectric parameters of material close to the dielectric parameters of the air.

DATA ACQUISITION ELECTRONICS

CONSTRUCTION

The data acquisition electronics (DAE3) consists of a highly sensitive electrometer grade preamplifier with auto-zeroing, a channel and gain-switching multiplex, a fast 16 bit AD converter and a command decoder and control logic unit. Transmission to the measurement server is accomplished through an optical downlink for data and status information as well as an optical uplink for commands and the clock. The mechanical probe is mounting device includes two different sensor systems for frontal and sideways probe contacts. They are used for mechanical surface detection and probe collision detection. The input impedance of the DAE3 box is 200M Ω ; the inputs are symmetrical and floating. Common mode rejection is above 80 dB.

2.4 GENERAL DESCRIPTION OF THE SPATIAL PEAK SAR EVALUATION

The DASY4 post-processing software (SEMCAD) automatically executes the following procedures to calculate the field units from the micro-volt readings at the probe connector. The parameters used in the evaluation are stored in the configuration modules of the software:

Probe parameters:	- Sensitivity	Norm _i , a _{i0} , a _{i1} , a _{i2}
	- Conversion factor	ConvF _i
	- Diode compression point	dcp _i
Device parameters:	- Frequency	F
	- Crest factor	Cf
Media parameters:	- Conductivity	σ
	- Density	ρ

The first step of the evaluation is a linearization of the filtered input signal to account for the compression characteristics of the detector diode. The compensation depends on the input signal, the diode type and the DC-transmission factor from the diode to the evaluation electronics. If the exciting field is pulsed, the crest factor of the signal must be known to correctly compensate for peak power. The formula for each channel can be given as:

$$V_i = U_i + U_i^2 \cdot \frac{cf}{dcp_i}$$

V _i	=compensated signal of channel i	(i = x, y, z)
U _i	=input signal of channel I	(i = x, y, z)
Cf	=crest factor of exciting field	(DASY parameter)
dcp _i	=diode compression point	(DASY parameter)

From the compensated input signals the primary field data for each channel can be evaluated:

$$\text{E-field probes: } E_i = \sqrt{\frac{V_i}{\text{Norm}_i \cdot \text{ConvF}}}$$

$$\text{H-field probes: } H_i = \sqrt{V_i} \cdot \frac{a_{i0} + a_{i1}f + a_{i2}f^2}{f}$$

- V_i = compensated signal of channel I (i = x, y, z)
- Norm_i = sensor sensitivity of channel i $\mu\text{V}/(\text{V/m})^2$ for E-field Probes (i = x, y, z)
- ConvF = sensitivity enhancement in solution
- a_{ij} = sensor sensitivity factors for H-field probes
- f = carrier frequency [GHz]
- E_i = electric field strength of channel i in V/m
- H_i = magnetic field strength of channel i in A/m

The RSS value of the field components gives the total field strength (Hermitian magnitude):

$$E_{tot} = \sqrt{E_x^2 + E_y^2 + E_z^2}$$

The primary field data are used to calculate the derived field units.

$$SAR = E_{tot}^2 \cdot \frac{\sigma}{\rho \cdot 1'000}$$

- SAR = local specific absorption rate in mW/g
- E_{tot} = total field strength in V/m
- σ = conductivity in [mho/m] or [Siemens/m]
- ρ = equivalent tissue density in g/cm³



Note that the density is set to 1, to account for actual head tissue density rather than the density of the tissue simulating liquid. The entire evaluation of the spatial peak values is performed within the Post-processing engine (SEMCAD). The system always gives the maximum values for the 1g and 10g cubes. The algorithm to find the cube with highest averaged SAR is divided into the following stages:

1. The extraction of the measured data (grid and values) from the Zoom Scan
2. The calculation of the SAR value at every measurement point based on all stored data (A/D values and measurement parameters)
3. The generation of a high-resolution mesh within the measured volume
4. The interpolation of all measured values from the measurement grid to the high-resolution grid
5. The extrapolation of the entire 3-D field distribution to the phantom surface over the distance from sensor to surface
6. The calculation of the averaged SAR within masses of 1g and 10g.

The probe is calibrated at the center of the dipole sensors that is located 1 to 2.7mm away from the probe tip. During measurements, the probe stops shortly above the phantom surface, depending on the probe and the surface detecting system. Both distances are included as parameters in the probe configuration file. The software always knows exactly how far away the measured point is from the surface. As the probe cannot directly measure at the surface, the values between the deepest measured point and the surface must be extrapolated. The angle between the probe axis and the surface normal line is less than 30 degree.

In the Area Scan, the gradient of the interpolation function is evaluated to find all the extreme of the SAR distribution. The uncertainty on the locations of the extreme is less than 1/20 of the grid size. Only local maximum within -2dB of the global maximum are searched and passed for the Cube Scan measurement. In the Cube Scan, the interpolation function is used to extrapolate the Peak SAR from the lowest measurement points to the inner phantom surface (the extrapolation distance). The uncertainty increases with the extrapolation distance. To keep the uncertainty within 1% for the 1g and 10g cubes, the extrapolation distance should not be larger than 5mm.



The maximum search is automatically performed after each area scan measurement. It is based on splines in two or three dimensions. The procedure can find the maximum for most SAR distributions even with relatively large grid spacing. After the area scanning measurement, the probe is automatically moved to a position at the interpolated maximum. The following scan can directly use this position for reference, e.g., for a finer resolution grid or the cube evaluations. The 1g and 10g peak evaluations are only available for the predefined cube 7 x 7 x 7 scans. The routines are verified and optimized for the grid dimensions used in these cube measurements. The measured volume of 30 x 30 x 30mm contains about 30g of tissue. The first procedure is an extrapolation (incl. boundary correction) to get the points between the lowest measured plane and the surface. The next step uses 3D interpolation to get all points within the measured volume in a 1mm grid (42875 points). In the last step, a 1g cube is placed numerically into the volume and its averaged SAR is calculated. This cube is the moved around until the highest averaged SAR is found. If the highest SAR is found at the edge of the measured volume, the system will issue a warning: higher SAR values might be found outside of the measured volume. In that case the cube measurement can be repeated, using the new interpolated maximum as the center.

3. DESCRIPTION OF SUPPORT UNITS

The EUT has been tested as an independent unit.

4. DESCRIPTION OF TEST MODES AND CONFIGURATIONS

4.1. DESCRIPTION OF TEST MODE

TEST MODE	COMMUNICATION MODE	MODULATION TYPE	ASSESSMENT POSITION	TESTED CHANNEL	REMARK
1	802.11a	BPSK	A / Cheek	36, 40, 48, 52, 60, 64, 100, 104, 116, 120, 124, 136, 140	For model: EVDO 2D QWERTY with Main antenna
2		BPSK	A / Tilt		
3		BPSK	B / Cheek		
4		BPSK	B / Tilt		
5		BPSK	C : Body / Front		
6		BPSK	A / Tilt	36, 52, 136	For model: EVDO 1D Numeric with Main antenna
7		BPSK	A / Cheek	120	For model: EVDO 2D QWERTY with Aux. antenna
8		BPSK	B / Cheek	120	

NOTE: Assessment position A: Right head position, B: Left head position, C: Body position, please refer to appendix E for the photo.

4.2. SUMMARY OF TEST RESULTS

THE EUT OF THIS MODE IS WITH MODEL **EVDO 2D QWERTY**, MAIN ANTENNA:

ITEM		1	2	3	4	5
PART OF ASSESSMENT		HEAD POSITION				BODY POSITION
TEST MODE		802.11a				
CHAN.	FREQ. (MHz)	MEASURED VALUE OF 1g SAR (W/kg)				
36	5180	1.010	0.936	0.955	0.963	0.078
40	5200	0.919	1.080	0.937	0.984	0.086
48	5240	0.871	0.975	0.908	0.820	0.094
52	5260	0.886	0.989	0.832	0.811	0.101
60	5300	0.833	0.835	0.778	0.789	0.094
64	5320	0.786	0.839	0.783	0.739	0.084
100	5500	0.444	0.435	0.370	0.369	0.059
104	5520	0.714	0.608	0.564	0.561	0.071
116	5580	0.621	0.542	0.544	0.590	0.078
120	5600	0.635	0.475	0.423	0.520	0.085
124	5620	0.593	0.515	0.577	0.515	0.085
136	5680	0.773	0.716	0.738	0.716	0.074
140	5700	0.268	0.187	0.216	0.187	0.032

THE EUT OF THIS MODE IS WITH MODEL **EVDO 1D Numeric**, MAIN ANTENNA:

ITEM		6
PART OF ASSESSMENT		HEAD POSITION
TEST MODE		802.11a
CHAN.	FREQ. (MHz)	MEASURED VALUE OF 1g SAR (W/kg)
36	1580	0.979
52	5260	0.890
136	5680	0.634

NOTE: The worst value has been marked by boldface.



THE EUT OF THIS MODE IS WITH MODEL EVDO 2D QWERTY, AUX. ANTENNA:

ITEM		7	8
PART OF ASSESSMENT		HEAD POSITION	
TEST MODE		802.11a	
CHAN.	FREQ. (MHz)	MEASURED VALUE OF 1g SAR (W/kg)	
120	5600	0.091	0.099

NOTE: The worst value has been marked by boldface.

5. TEST RESULTS

5.1 TEST PROCEDURES

Use the software to control the EUT channel and transmission power. Then record the conducted power before the testing. Place the EUT to the specific test location. After the testing, must writing down the conducted power of the EUT into the report. The SAR value was calculated via the 3D spline interpolation algorithm that has been implemented in the software of DASY4 SAR measurement system manufactured and calibrated by SPEAG. According to the IEEE 1528 standards, the recommended procedure for assessing the peak spatial-average SAR value consists of the following steps:

- Power reference measurement
- Verification of the power reference measurement
- Area scan
- Zoom scan
- Power reference measurement

The area scan was performed for the highest spatial SAR location. The zoom scan with 30mm x 30mm x 30mm volume was performed for SAR value averaged over 1g and 10g spatial volumes.



In the zoom scan, the distance between the measurement point at the probe sensor location (geometric center behind the probe tip) and the phantom surface is 4.0mm and maintained at a constant distance of ± 1.0 mm during a zoom scan to determine peak SAR locations. The distance is 4mm between the first measurement point and the bottom surface of the phantom. The secondary measurement point to the bottom surface of the phantom is with 9mm separation distance. The cube size is 7 x 7 x 7 points consist of 343 points and the grid space is 5mm.

The measurement time is 0.5s at each point of the zoom scan. The probe boundary effect compensation shall be applied during the SAR test. Because of the tip of the probe to the Phantom surface separated distances are longer than half a tip probe diameter.

In the area scan, the separation distance is 4mm between the each measurement point and the phantom surface. The scan size shall be included the transmission portion of the EUT. The measurement time is the same as the zoom scan. At last the reference power drift shall be less than $\pm 5\%$.

5.2 MEASURED SAR RESULTS

RIGHT / CHEEK HEAD POSITION

ENVIRONMENTAL CONDITION		Air Temperature : 22.2°C, Liquid Temperature : 21.0°C Humidity : 55%RH						
TESTED BY		Sam Onn			DATE		Feb. 21, 2008	
CHAN.	FREQ. (MHz)	TEST MODE	CONDUCTED POWER (mW)		POWER DRIFT (%)	DEVICE TEST POSITION MODE	MEASURED 1g SAR (W/kg)	
			BEGIN TEST	AFTER TEST				
36	5180	802.11a	12.94	12.79	-1.16	1	1.010	
40	5200	802.11a	12.94	12.77	-1.31	1	0.919	
48	5240	802.11a	12.79	12.60	-1.49	1	0.871	
52	5260	802.11a	13.34	13.20	-1.05	1	0.886	
60	5300	802.11a	15.14	14.96	-1.19	1	0.833	
64	5320	802.11a	16.41	16.25	-0.98	1	0.786	
100	5500	802.11a	17.74	17.45	-1.63	1	0.444	
104	5520	802.11a	26.36	26.02	-1.29	1	0.714	
116	5580	802.11a	26.55	26.14	-1.54	1	0.621	
120	5600	802.11a	26.55	26.20	-1.32	1	0.635	
124	5620	802.11a	27.10	26.71	-1.44	1	0.593	
136	5680	802.11a	26.85	26.42	-1.60	1	0.773	
140	5700	802.11a	8.09	7.97	-1.48	1	0.268	

NOTE:

1. Test configuration of each mode is described in section 3.
2. In this testing, the limit for General Population Spatial Peak averaged over 1g, **1.6 W/kg**, is applied.
3. Please see the Appendix A for the data.
4. The variation of the EUT conducted power measured before and after SAR testing should not over 5%.

RIGHT / TILT HEAD POSITION

ENVIRONMENTAL CONDITION		Air Temperature : 22.2°C, Liquid Temperature : 21.0°C Humidity : 55%RH					
TESTED BY		Sam Onn			DATE		Feb. 21, 2008
CHAN.	FREQ. (MHz)	TEST MODE	CONDUCTED POWER (mW)		POWER DRIFT (%)	DEVICE TEST POSITION MODE	MEASURED 1g SAR (W/kg)
			BEGIN TEST	AFTER TEST			
36	5180	802.11a	12.94	12.79	-1.16	2	0.936
40	5200	802.11a	12.94	12.77	-1.31	2	1.080
48	5240	802.11a	12.79	12.60	-1.49	2	0.975
52	5260	802.11a	13.34	13.16	-1.35	2	0.989
60	5300	802.11a	15.14	14.91	-1.52	2	0.835
64	5320	802.11a	16.41	16.23	-1.10	2	0.839
100	5500	802.11a	17.74	17.38	-2.03	2	0.435
104	5520	802.11a	26.36	26.02	-1.29	2	0.608
116	5580	802.11a	26.55	26.01	-2.03	2	0.542
120	5600	802.11a	26.55	26.04	-1.92	2	0.475
124	5620	802.11a	27.10	26.55	-2.03	2	0.515
136	5680	802.11a	26.85	26.25	-2.23	2	0.716
140	5700	802.11a	8.09	7.95	-1.73	2	0.187

NOTE:

1. Test configuration of each mode is described in section 3.
2. In this testing, the limit for General Population Spatial Peak averaged over 1g, **1.6 W/kg**, is applied.
3. Please see the Appendix A for the data.
4. The variation of the EUT conducted power measured before and after SAR testing should not over 5%.



LEFT / CHEEK HEAD POSITION

ENVIRONMENTAL CONDITION			Air Temperature : 22.4°C, Liquid Temperature : 21.3°C Humidity : 55%RH				
TESTED BY			Sam Onn		DATE		Feb. 22, 2008
CHAN.	FREQ. (MHz)	TEST MODE	CONDUCTED POWER (mW)		POWER DRIFT (%)	DEVICE TEST POSITION MODE	MEASURED 1g SAR (W/kg)
			BEGIN TEST	AFTER TEST			
36	5180	802.11a	12.94	12.77	-1.31	3	0.955
40	5200	802.11a	12.94	12.72	-1.70	3	0.937
48	5240	802.11a	12.79	12.57	-1.72	3	0.908
52	5260	802.11a	13.34	13.17	-1.27	3	0.832
60	5300	802.11a	15.14	14.93	-1.39	3	0.778
64	5320	802.11a	16.41	16.15	-1.58	3	0.783
100	5500	802.11a	17.74	17.45	-1.63	3	0.370
104	5520	802.11a	26.36	25.90	-1.75	3	0.564
116	5580	802.11a	26.55	26.06	-1.85	3	0.544
120	5600	802.11a	26.55	26.04	-1.92	3	0.423
124	5620	802.11a	27.10	26.70	-1.48	3	0.577
136	5680	802.11a	26.85	26.39	-1.71	3	0.738
140	5700	802.11a	8.09	7.95	-1.73	3	0.216

NOTE:

1. Test configuration of each mode is described in section 3.
2. In this testing, the limit for General Population Spatial Peak averaged over 1g, **1.6 W/kg**, is applied.
3. Please see the Appendix A for the data.
4. The variation of the EUT conducted power measured before and after SAR testing should not over 5%.

LEFT / TILT HEAD POSITION

ENVIRONMENTAL CONDITION		Air Temperature : 22.4°C, Liquid Temperature : 21.3°C Humidity : 55%RH						
TESTED BY		Sam Onn			DATE		Feb. 22, 2008	
CHAN.	FREQ. (MHz)	TEST MODE	CONDUCTED POWER (mW)		POWER DRIFT (%)	DEVICE TEST POSITION MODE	MEASURED 1g SAR (W/kg)	
			BEGIN TEST	AFTER TEST				
36	5180	802.11a	12.94	12.69	-1.93	4	0.963	
40	5200	802.11a	12.94	12.68	-2.01	4	0.984	
48	5240	802.11a	12.79	12.53	-2.03	4	0.820	
52	5260	802.11a	13.34	13.17	-1.27	4	0.811	
60	5300	802.11a	15.14	14.93	-1.39	4	0.789	
64	5320	802.11a	16.41	16.15	-1.58	4	0.739	
100	5500	802.11a	17.74	17.43	-1.75	4	0.369	
104	5520	802.11a	26.36	25.71	-2.47	4	0.561	
116	5580	802.11a	26.55	25.83	-2.71	4	0.590	
120	5600	802.11a	26.55	25.99	-2.11	4	0.520	
124	5620	802.11a	27.10	26.48	-2.29	4	0.515	
136	5680	802.11a	26.85	26.26	-2.20	4	0.716	
140	5700	802.11a	8.09	7.92	-2.10	4	0.187	

NOTE:

1. Test configuration of each mode is described in section 3.
2. In this testing, the limit for General Population Spatial Peak averaged over 1g, **1.6 W/kg**, is applied.
3. Please see the Appendix A for the data.
4. The variation of the EUT conducted power measured before and after SAR testing should not over 5%.

BODY POSITION

ENVIRONMENTAL CONDITION		Air Temperature : 22.3°C, Liquid Temperature : 21.4°C Humidity : 59%RH					
TESTED BY		Sam Onn			DATE		Feb. 23, 2008
CHAN.	FREQ. (MHz)	TEST MODE	CONDUCTED POWER (mW)		POWER DRIFT (%)	DEVICE TEST POSITION MODE	MEASURED 1g SAR (W/kg)
			BEGIN TEST	AFTER TEST			
36	5180	802.11a	12.94	12.71	-1.78	5	0.078
40	5200	802.11a	12.94	12.76	-1.39	5	0.086
48	5240	802.11a	12.79	12.65	-1.09	5	0.094
52	5260	802.11a	13.34	13.15	-1.42	5	0.101
60	5300	802.11a	15.14	15.01	-0.86	5	0.094
64	5320	802.11a	16.41	16.20	-1.28	5	0.084
100	5500	802.11a	17.74	17.56	-1.01	5	0.059
104	5520	802.11a	26.36	26.02	-1.29	5	0.071
116	5580	802.11a	26.55	26.28	-1.02	5	0.078
120	5600	802.11a	26.55	26.14	-1.54	5	0.085
124	5620	802.11a	27.1	26.59	-1.88	5	0.085
136	5680	802.11a	26.85	26.57	-1.04	5	0.074
140	5700	802.11a	8.09	7.93	-1.98	5	0.032

NOTE:

1. Test configuration of each mode is described in section 3.
2. In this testing, the limit for General Population Spatial Peak averaged over 1g, **1.6 W/kg**, is applied.
3. Please see the Appendix A for the data.
4. The variation of the EUT conducted power measured before and after SAR testing should not over 5%.

RIGHT / TILT HEAD POSITION

ENVIRONMENTAL CONDITION		Air Temperature : 22.2°C, Liquid Temperature : 21.0°C Humidity : 55%RH					
TESTED BY		Sam Onn			DATE		Feb. 21, 2008
CHAN.	FREQ. (MHz)	TEST MODE	CONDUCTED POWER (mW)		POWER DRIFT (%)	DEVICE TEST POSITION MODE	MEASURED 1g SAR (W/kg)
			BEGIN TEST	AFTER TEST			
40	5200	802.11a	12.94	12.81	-1.00	6	0.979
52	5260	802.11a	13.34	13.20	-1.05	6	0.890
136	5680	802.11a	26.85	26.55	-1.12	6	0.634

NOTE:

1. Test configuration of each mode is described in section 3.
2. In this testing, the limit for General Population Spatial Peak averaged over 1g, **1.6 W/kg**, is applied.
3. Please see the Appendix A for the data.
4. The variation of the EUT conducted power measured before and after SAR testing should not over 5%.



RIGHT / CHEEK HEAD POSITION

ENVIRONMENTAL CONDITION		Air Temperature : 22.4°C, Liquid Temperature : 21.3°C Humidity : 55%RH					
TESTED BY		Sam Onn			DATE		Feb. 22, 2008
CHAN.	FREQ. (MHz)	TEST MODE	CONDUCTED POWER (mW)		POWER DRIFT (%)	DEVICE TEST POSITION MODE	MEASURED 1g SAR (W/kg)
			BEGIN TEST	AFTER TEST			
120	5600	802.11a	23.77	23.50	-1.14	7	0.091

NOTE:

1. Test configuration of each mode is described in section 3.
2. In this testing, the limit for General Population Spatial Peak averaged over 1g, **1.6 W/kg**, is applied.
3. Please see the Appendix A for the data.
4. The variation of the EUT conducted power measured before and after SAR testing should not over 5%.



LEFT / CHEEK HEAD POSITION

ENVIRONMENTAL CONDITION		Air Temperature : 22.4°C, Liquid Temperature : 21.3°C Humidity : 55%RH					
TESTED BY		Sam Onn			DATE		Feb. 22, 2008
CHAN.	FREQ. (MHz)	TEST MODE	CONDUCTED POWER (mW)		POWER DRIFT (%)	DEVICE TEST POSITION MODE	MEASURED 1g SAR (W/kg)
			BEGIN TEST	AFTER TEST			
120	5600	802.11a	23.77	23.39	-1.60	8	0.099

NOTE:

1. Test configuration of each mode is described in section 3.
2. In this testing, the limit for General Population Spatial Peak averaged over 1g, **1.6 W/kg**, is applied.
3. Please see the Appendix A for the data.
4. The variation of the EUT conducted power measured before and after SAR testing should not over 5%.

5.3 SAR LIMITS

HUMAN EXPOSURE	SAR (W/kg)	
	(GENERAL POPULATION / UNCONTROLLED EXPOSURE ENVIRONMENT)	(OCCUPATIONAL / CONTROLLED EXPOSURE ENVIRONMENT)
Spatial Average (whole body)	0.08	0.4
Spatial Peak (averaged over 1 g)	1.6	8.0
Spatial Peak (hands / wrists / feet / ankles averaged over 10 g)	4.0	20.0

NOTE:

1. This limits accord to 47 CFR 2.1093 – Safety Limit.
2. The EUT property been complied with the partial body exposure limit under the general population environment.

5.4 RECIPES FOR TISSUE SIMULATING LIQUIDS

For the measurement of the field distribution inside the SAM phantom, the phantom must be filled with 25 liters of tissue simulation liquid.

The following ingredients are used :

- **WATER-** Deionized water (pure H₂O), resistivity ≈ 16 M - as basis for the liquid
- **SUGAR-** Refined sugar in crystals, as available in food shops - to reduce relative permittivity
- **SALT-** Pure NaCl - to increase conductivity
- **CELLULOSE-** Hydroxyethyl-cellulose, medium viscosity (75-125mPa.s, 2% in water, 20°C),
CAS # 54290 - to increase viscosity and to keep sugar in solution
- **PRESERVATIVE-** Preventol D-7 Bayer AG, D-51368 Leverkusen, CAS # 55965-84-9 - to prevent the spread of bacteria and molds
- **DGMBE-** Diethylenglycol-monobuthyl ether (DGMBE), Fluka Chemie GmbH, CAS # 112-34-5 - to reduce relative permittivity

THE INFORMATION FOR 5GHz SIMULATING LIQUID

The 5GHz liquids was purchased from SPEAG.

Body liquid model: HSL 5800, P/N: SL AAH 5800 AA

Head liquid model: M 5800, P/N: SL AAM 580 AD

5GHz liquids contain the following ingredients:

Water 64 - 78%

Mineral Oil 11 - 18%

Emulsifiers 9 - 15%

Additives and Salt 2 - 3%



Testing the liquids using the Agilent Network Analyzer E8358A and Agilent Dielectric Probe Kit 85070D. The testing procedure is following as

1. Turn Network Analyzer on and allow at least 30min. warm up.
2. Mount dielectric probe kit so that interconnecting cable to Network Analyzer will not be moved during measurements or calibration.
3. Pour de-ionized water and measure water temperature ($\pm 1^\circ$).
4. Set water temperature in Agilent-Software (Calibration Setup).
5. Perform calibration.
6. Validate calibration with dielectric material of known properties (e.g. polished ceramic slab with $>8\text{mm}$ thickness $\epsilon' = 10.0$, $\epsilon'' = 0.0$). If measured parameters do not fit within tolerance, repeat calibration (± 0.2 for ϵ' : ± 0.1 for ϵ'').
7. Conductivity can be calculated from ϵ'' by $\sigma = \omega \epsilon_0 \epsilon'' = \epsilon'' f [\text{GHz}] / 18$.
8. Measure liquid shortly after calibration. Repeat calibration every hour.
9. Stir the liquid to be measured. Take a sample ($\sim 50\text{ml}$) with a syringe from the center of the liquid container.
10. Pour the liquid into a small glass flask. Hold the syringe at the bottom of the flask to avoid air bubbles.
11. Put the dielectric probe in the glass flask. Check that there are no air bubbles in front of the opening in the dielectric probe kit.
12. Perform measurements.
13. Adjust medium parameters in DASY4 for the frequencies necessary for the measurements ('Setup Config', select medium (e.g. Brain 900MHz) and press 'Option'-button.
14. Select the current medium for the frequency of the validation (e.g. Setup Medium Brain 900MHz).



FOR WLAN 5GHz BAND SIMULATING LIQUID

LIQUID TYPE		HSL-5800		MSL-5800	
SIMULATING LIQUID TEMP.		21.0		21.4	
TEST DATE		Feb. 21, 2008		Feb. 23, 2008	
TESTED BY		Sam Onn		Sam Onn	
FREQ. (MHz)	LIQUID PARAMETER	STANDARD VALUE	MEASUREMENT VALUE	STANDARD VALUE	MEASUREMENT VALUE
5180	Permittivity (ϵ)	36.00	36.80	49.00	49.60
5200		36.00	36.70	49.00	49.50
5240		35.90	36.70	49.00	49.40
5260		35.90	36.60	48.90	49.40
5300		35.90	36.60	48.90	49.40
5320		35.80	36.60	48.90	49.30
5500		35.60	36.30	48.60	48.90
5520		35.60	36.20	48.60	48.90
5580		35.60	36.10	48.50	48.70
5600		35.50	36.10	48.50	48.70
5620		35.50	36.00	48.40	48.70
5680		35.40	35.90	48.40	48.60
5700		35.40	35.90	48.30	48.50
5800		35.30	35.70	48.20	48.30
5180		Conductivity (σ) S/m	4.63	4.61	5.28
5200	4.66		4.63	5.30	5.27
5240	4.70		4.68	5.35	5.33
5260	4.72		4.71	5.37	5.36
5300	4.76		4.75	5.42	5.42
5320	4.78		4.78	5.44	5.45
5500	4.96		4.99	5.65	5.71
5520	4.98		5.01	5.67	5.74
5580	5.04		5.09	5.74	5.82
5600	5.07		5.11	5.77	5.85
5620	5.09		5.14	5.79	5.88
5680	5.15		5.21	5.86	5.97
5700	5.17		5.23	5.88	6.00
5800	5.27		5.36	6.00	6.15
Dielectric Parameters Required at 22°C					



FOR WLAN 5GHz BAND SIMULATING LIQUID

LIQUID TYPE		HSL-5800		MSL-5800	
SIMULATING LIQUID TEMP.		21.3		NA	
TEST DATE		Feb. 22, 2008		NA	
TESTED BY		Sam Onn		NA	
FREQ. (MHz)	LIQUID PARAMETER	STANDARD VALUE	MEASUREMENT VALUE	STANDARD VALUE	MEASUREMENT VALUE
5180	Permittivity (ϵ)	36.00	36.30	NA	NA
5200		36.00	36.30	NA	NA
5240		35.90	36.20	NA	NA
5260		35.90	36.20	NA	NA
5300		35.90	36.10	NA	NA
5320		35.80	36.10	NA	NA
5500		35.60	35.80	NA	NA
5520		35.60	35.80	NA	NA
5580		35.60	35.60	NA	NA
5600		35.50	35.60	NA	NA
5620		35.50	35.60	NA	NA
5680		35.40	35.50	NA	NA
5700		35.40	35.40	NA	NA
5800		35.30	35.30	NA	NA
5180		Conductivity (σ) S/m	4.63	4.64	NA
5200	4.66		4.66	NA	NA
5240	4.70		4.71	NA	NA
5260	4.72		4.74	NA	NA
5300	4.76		4.77	NA	NA
5320	4.78		4.81	NA	NA
5500	4.96		5.02	NA	NA
5520	4.98		5.04	NA	NA
5580	5.04		5.12	NA	NA
5600	5.07		5.15	NA	NA
5620	5.09		5.17	NA	NA
5680	5.15		5.24	NA	NA
5700	5.17		5.27	NA	NA
5800	5.27		5.40	NA	NA
Dielectric Parameters Required at 22°C					



5.5 TEST EQUIPMENT FOR TISSUE PROPERTY

ITEM	NAME	BAND	TYPE	SERIES NO.	CALIBRATED UNTIL
1	Network Analyzer	Agilent	E8358A	US41480538	Nov. 11, 2008
2	Dielectric Probe	Agilent	85070D	US01440176	NA

NOTE:

1. Before starting, all test equipment shall be warmed up for 30min.
2. The tolerance ($k=1$) specified by Agilent for general dielectric measurements, deriving from inaccuracies in the calibration data, analyzer drift, and random errors, are usually $\pm 2.5\%$ and $\pm 5\%$ for measured permittivity and conductivity, respectively. However, the tolerances for the conductivity is smaller for material with large loss tangents, i.e., less than $\pm 2.5\%$ ($k=1$). It can be substantially smaller if more accurate methods are applied.

6. SYSTEM VALIDATION

The system validation was performed in the flat phantom with equipment listed in the following table. Since the SAR value is calculated from the measured electric field, dielectric constant and conductivity of the body tissue, and the SAR is proportional to the square of the electric field. So, the SAR value will be also proportional to the RF power input to the system validation dipole under the same test environment. In our system validation test, 250mW RF input power was used.

6.1 TEST EQUIPMENT

ITEM	NAME	BAND	TYPE	SERIES NO.	CALIBRATED UNTIL
1	SAM Phantom	S & P	QD000 P40 CA	PT-1150	NA
2	Signal Generator	Anritsu	68247B	984703	May 18, 2008
3	E-Field Probe	Speaq	EX3DV3	3506	Mar. 19, 2008
4	DAE	S & P	DAE	579	Mar. 22, 2008
5	Robot Positioner	Staubli Unimation	NA	NA	NA
6	Validation Dipole	Speaq	D5GHzV2	1018	Apr. 18, 2008
7	Power Meter	Agilent	E4416A	GB41291763	May 27, 2008
8	Peak and Average Power Sensor	Agilent	E9327A	US40441181	May 27, 2008

NOTE: Before starting the measurement, all test equipment shall be warmed up for 30min.

6.2 TEST PROCEDURE

Before the system performance check, we need only to tell the system which components (probe, medium, and device) are used for the system performance check; the system will take care of all parameters. The dipole must be placed beneath the flat section of the SAM Twin Phantom with the correct distance holder in place. The distance holder should touch the phantom surface with a light pressure at the reference marking (little cross) and be oriented parallel to the long side of the phantom. Accurate positioning is not necessary, since the system will search for the peak SAR location, except that the dipole arms should be parallel to the surface. The device holder for mobile phones can be left in place but should be rotated away from the dipole.

The "Power Reference Measurement" and "Power Drift Measurement" jobs are located at the beginning and end of the batch process. They measure the field drift at one single point in the liquid over the complete procedure. The indicated drift is mainly the variation of the amplifier output power. If it is too high (above ± 0.1 dB), the system performance check should be repeated; some amplifiers have very high drift during warm-up. A stable amplifier gives drift results in the DASY system below ± 0.02 dB.

The "Surface Check" job tests the optical surface detection system of the DASY system by repeatedly detecting the surface with the optical and mechanical surface detector and comparing the results. The output gives the detecting heights of both systems, the difference between the two systems and the standard deviation of the detection repeatability. Air bubbles or refraction in the liquid due to separation of the sugar-water mixture gives poor repeatability (above ± 0.1 mm). In that case it is better to abort the system performance check and stir the liquid. The difference between the optical surface detection and the actual surface depends on the probe and is specified with each probe. (It does not depend on the surface reflectivity or the probe angle to the surface within $\pm 30^\circ$.) However, varying breaking indices of different liquid compositions might also influence the distance. If the indicated difference varies from the actual setting, the probe parameter "optical surface



The "Area Scan" job measures the SAR above the dipole on a plane parallel to the surface. It is used to locate the approximate location of the peak SAR. The proposed scan uses large grid spacing for faster measurement; due to the symmetric field, the peak detection is reliable. If a finer graphic is desired, the grid spacing can be reduced. Grid spacing and orientation have no influence on the SAR result.

The "Zoom Scan" job measures the field in a volume around the peak SAR value assessed in the previous "Area Scan" job (for more information see the application note on SAR evaluation).

About the validation dipole positioning uncertainty, the constant and low loss dielectric spacer is used to establish the correct distance between the top surface of the dipole and the bottom surface of the phantom, the error component introduced by the uncertainty of the distance between the liquid (i.e., phantom shell) and the validation dipole in the DAS4 system is less than ± 0.1 mm.

$$SAR_{tolerance} [\%] = 100 \times \left(\frac{(a + d)^2}{a^2} - 1 \right)$$

As the closest distance is 10mm, the resulting tolerance $SAR_{tolerance} [\%]$ is <2%.

6.3 VALIDATION RESULTS

VALIDATION TEST IN THE MUSCLE SIMULATING LIQUID					
TEST FREQUENCY (MHz)	REQUIRED SAR (mW/g)	MEASURED SAR (mW/g)	DEVIATION (%)	SEPARATION DISTANCE	TEST DATE
HSL5200	20.10 (1g)	19.50	-2.99	10mm	Feb. 21, 2008
HSL5500	19.20 (1g)	18.60	-3.12	10mm	Feb. 21, 2008
HSL5800	19.30 (1g)	18.40	-4.66	10mm	Feb. 21, 2008
HSL5200	20.10 (1g)	19.20	-4.48	10mm	Feb. 22, 2008
HSL5500	19.20 (1g)	18.20	-5.21	10mm	Feb. 22, 2008
HSL5800	19.30 (1g)	18.70	-3.11	10mm	Feb. 22, 2008
MSL5200	19.50 (1g)	18.90	-3.08	10mm	Feb. 23, 2008
MSL5500	19.60 (1g)	18.80	-4.08	10mm	Feb. 23, 2008
MSL5800	17.60 (1g)	16.90	-3.98	10mm	Feb. 23, 2008
TESTED BY	Sam Onn				

NOTE: Please see Appendix for the photo of system validation test.

6.4 SYSTEM VALIDATION UNCERTAINTIES

In the table below, the system validation uncertainty with respect to the analytically assessed SAR value of a dipole source as given in the IEEE 1528 standard is given. This uncertainty is smaller than the expected uncertainty for mobile phone measurements due to the simplified setup and the symmetric field distribution.

Error Description	Tolerance (±%)	Probability Distribution	Divisor	(C _i)		Standard Uncertainty (±%)		(v _i)
				(1g)	(10g)	(1g)	(10g)	
Measurement System								
Probe Calibration	4.8	Normal	1	1	1	4.8	4.8	∞
Axial Isotropy	4.7	Rectangular	$\sqrt{3}$	1	1	2.7	2.7	∞
Hemispherical Isotropy	0	Rectangular	$\sqrt{3}$	1	1	0	0	∞
Boundary effect	1.0	Rectangular	$\sqrt{3}$	1	1	0.6	0.6	∞
Linearity	4.7	Rectangular	$\sqrt{3}$	1	1	2.7	2.7	∞
System Detection Limit	1.0	Rectangular	$\sqrt{3}$	1	1	0.6	0.6	∞
Readout Electronics	1.0	Normal	1	1	1	1.0	1.0	∞
Response Time	0	Rectangular	$\sqrt{3}$	1	1	0	0	∞
Integration Time	0	Rectangular	$\sqrt{3}$	1	1	0	0	∞
RF Ambient Conditions	3.0	Rectangular	$\sqrt{3}$	1	1	1.7	1.7	∞
Probe Positioner	0.4	Rectangular	$\sqrt{3}$	1	1	0.2	0.2	∞
Probe positioning	2.9	Rectangular	$\sqrt{3}$	1	1	1.7	1.7	∞
Algorithms for Max. SAR Evaluation	1.0	Rectangular	$\sqrt{3}$	1	1	0.6	0.6	∞
Dipole								
Dipole Axis to Liquid Distance	2.0	Rectangular	$\sqrt{3}$	1	1	1.2	1.2	∞
Input power and SAR drift measurement	4.7	Rectangular	$\sqrt{3}$	1	1	2.7	2.7	∞
Phantom and Tissue Parameters								
Phantom Uncertainty	4.0	Rectangular	$\sqrt{3}$	1	1	2.3	2.3	∞
Liquid Conductivity (target)	5.0	Rectangular	$\sqrt{3}$	0.64	0.43	1.8	1.2	∞
Liquid Conductivity (measurement)	2.5	Normal	1	0.64	0.43	1.6	1.1	∞
Liquid Permittivity (target)	5.0	Rectangular	$\sqrt{3}$	0.6	0.49	1.7	1.4	∞
Liquid Permittivity (measurement)	2.5	Normal	1	0.6	0.49	1.5	1.2	∞
Combined Standard Uncertainty						8.4	8.1	∞
Coverage Factor for 95%						k _p =2		
Expanded Uncertainty (K=2)						16.8	16.2	

NOTE: About the system validation uncertainty assessment, please reference the section 7.

7. MEASUREMENT SAR PROCEDURE UNCERTAINTIES

The assessment of spatial peak SAR of the hand held devices is according to IEEE 1528. All testing situation shall be met below these requirements.

- The system is used by an experienced engineer who follows the manual and the guidelines taught during the training provided by SPEAG.
- The probe has been calibrated within the requested period and the stated uncertainty for the relevant frequency bands does not exceed 4.8% (k=1).
- The validation dipole has been calibrated within the requested period and the system performance check has been successful.
- The DAE unit has been calibrated within the within the requested period.
- The minimum distance between the probe sensor and inner phantom shell is selected to be between 4 and 5mm.
- The operational mode of the DUT is CW, CDMA, FDMA or TDMA (GSM, DCS, PCS, IS136 and PDC) and the measurement/integration time per point is >500 ms.
- The dielectric parameters of the liquid have been assessed using Agilent 85070D dielectric probe kit or a more accurate method.
- The dielectric parameters are within 5% of the target values.
- The DUT has been positioned as described in section 3.

7.1. PROBE CALIBRATION UNCERTAINTY

SPEAG conducts the probe calibration in compliance with international and national standards (e.g. IEEE 1528, EN50361, IEC 62209, etc.) under ISO17025. The uncertainties are stated on the calibration certificate. For the most relevant frequency bands, these values do not exceed 4.8% (k=1). If evaluations of other bands are performed for which the uncertainty exceeds these values, the uncertainty tables given in the summary have to be revised accordingly.

7.2. ISOTROPY UNCERTAINTY

The axial isotropy tolerance accounts for probe rotation around its axis while the hemispherical isotropy error includes all probe orientations and field polarizations. These parameters are assessed by SPEAG during initial calibration. In 2001, SPEAG further tightened its quality controls and warrants that the maximal deviation from axial isotropy is $\pm 0.20\text{dB}$, while the maximum deviation of hemispherical isotropy is $\pm 0.40\text{dB}$, corresponding to $\pm 4.7\%$ and $\pm 9.6\%$, respectively. A weighting factor of c_p equal to 0.5 can be applied, since the axis of the probe deviates less than 30 degrees from the normal surface orientation.

7.3. BOUNDARY EFFECT UNCERTAINTY

The effect can be estimated according to the following error approximation formula

$$SAR_{tolerance} [\%] = SAR_{be} [\%] \times \frac{(d_{be} + d_{step})^2}{2d_{step}} e^{-\frac{d_{be}}{\delta/2}}$$

$$d_{be} + d_{step} < 10\text{mm}$$

The parameter d_{be} is the distance in mm between the surface and the closest measurement point used in the averaging process; d_{step} is the separation distance in mm between the first and second measurement points; δ is the minimum penetration depth in mm within the head tissue equivalent liquids (i.e., $\delta = 13.95\text{mm}$ at 3GHz); SAR_{be} is the deviation between the measured SAR value at the distance d_{be} from the boundary and the wave-guide analytical value SAR_{ref} . DASY4 applies a boundary effect compensation algorithm according to IEEE 1528, which is possible since the axis of the probe never deviates more than 30 degrees from the normal surface orientation. $SAR_{be}[\%]$ is assessed during the calibration process and SPEAG warrants that the uncertainty at distances larger than 4mm is always less than 1%. In summary, the worst case boundary effect SAR tolerance[%] for scanning distances larger than 4mm is $< \pm 0.8\%$.

7.4. PROBE LINEARITY UNCERTAINTY

Field probe linearity uncertainty includes errors from the assessment and compensation of the diode compression effects for CW and pulsed signals with known duty cycles. This error is assessed using the procedure described in IEEE 1528. For SPEAG field probes, the measured difference between CW and pulsed signals, with pulse frequencies between 10Hz and 1kHz and duty cycles between 1 and 100, is $< \pm 0.20\text{dB}$ ($< \pm 4.7\%$).

7.5. READOUT ELECTRONICS UNCERTAINTY

All uncertainties related to the probe readout electronics (DAE unit), including the gain and linearity of the instrumentation amplifier, its loading effect on the probe, and accuracy of the signal conversion algorithm, have been assessed accordingly to IEEE 1528. The combination (root-sum-square RSS method) of these components results in an overall maximum error of $\pm 1.0\%$.

7.6. RESPONSE TIME UNCERTAINTY

The time response of the field probes is assessed by exposing the probe to a well-controlled electric field producing SAR larger than 2.0W/kg at the tissue medium surface. The signal response time is evaluated as the time required by the system to reach 90% of the expected final value after an on/of switch of the power source. Analytically, it can be expressed as:

$$SAR_{tolerance} [\%] = 100 \times \left(\frac{T_m}{T_m + \tau e^{-T_m/\tau} - \tau} - 1 \right)$$

where T_m is 500 ms, i.e., the time between measurement samples, and τ the time constant. The response time τ of SPEAG's probes is $< 5\text{ms}$. In the current implementation, DASY4 waits longer than 100 ms after having reached the grid point before starting a measurement, i.e., the response time uncertainty is negligible.

7.7. INTEGRATION TIME UNCERTAINTY

If the device under test does not emit a CW signal, the integration time applied to measure the electric field at a specific point may introduce additional uncertainties due to the discretization and can be assessed as follows

$$SAR_{tolerance} [\%] = 100 \times \sum_{all\ sub-frames} \frac{t_{frame}}{t_{integration}} \frac{slot_{idle}}{slot_{total}}$$

The tolerances for the different systems are given in Table 7.1, whereby the worst-case $SAR_{tolerance}$ is 2.6%.

System	$SAR_{tolerance} \%$
CW	0
CDMA*	0
WCDMA*	0
FDMA	0
IS-136	2.6
PDC	2.6
GSM/DCS/PCS	1.7
DECT	1.9
Worst-Case	2.6

TABLE 7.1

7.8. PROBE POSITIONER MECHANICAL TOLERANCE

The mechanical tolerance of the field probe positioner can introduce probe positioning uncertainties. The resulting SAR uncertainty is assessed by comparing the SAR obtained according to the specifications of the probe positioner with respect to the actual position defined by the geometric center of the probe sensors. The tolerance is determined as:

$$SAR_{tolerance} [\%] = 100 \times \frac{d_{ph}}{\delta/2}$$

The specified repeatability of the RX robot family used in DASY4 systems is $\pm 25\mu\text{m}$. The absolute accuracy for short distance movements is better than $\pm 0.1\text{mm}$, i.e., the $SAR_{tolerance} [\%]$ is better than 1.5% (rectangular).

7.9. PROBE POSITIONING

The probe positioning procedures affect the tolerance of the separation distance between the probe tip and the phantom surface as:

$$SAR_{tolerance} [\%] = 100 \times \frac{d_{ph}}{\delta/2}$$

where d_{ph} is the maximum deviation of the distance between the probe tip and the phantom surface. The optical surface detection has a precision of better than 0.2mm, resulting in an $SAR_{tolerance} [\%]$ of <2.9% (rectangular distribution). Since the mechanical detection provides better accuracy, 2.9% is a worst-case figure for DASY4 system.

7.10. PHANTOM UNCERTAINTY

The SAR measurement uncertainty due to SPEAG phantom shell production tolerances has been evaluated using

$$SAR_{tolerance} [\%] \cong 100 \times \frac{2d}{a}, \quad d \ll a$$

For a maximum deviation d of the inner and outer shell of the phantom from that specified in the CAD file of $\pm 0.2\text{mm}$, and a 10mm spacing a between source and tissue liquid, the calculated phantom uncertainty is $\pm 4.0\%$.

7.11. DASY4 UNCERTAINTY BUDGET (FOR 5 ~ 6GHz)

Error Description	Tolerance (±%)	Probability Distribution	Divisor	(C _i)		Standard Uncertainty (±%)		(v _i)
				(1g)	(10g)	(1g)	(10g)	
Measurement System								
Probe Calibration	6.8	Normal	1	1	1	6.8	6.8	∞
Axial Isotropy	4.7	Rectangular	$\sqrt{3}$	0.7	0.7	1.9	1.9	∞
Hemispherical Isotropy	9.6	Rectangular	$\sqrt{3}$	0.7	0.7	3.9	3.9	∞
Boundary effect	2.0	Rectangular	$\sqrt{3}$	1	1	1.2	1.2	∞
Linearity	4.7	Rectangular	$\sqrt{3}$	1	1	2.7	2.7	∞
System Detection Limit	1.0	Rectangular	$\sqrt{3}$	1	1	0.6	0.6	∞
Readout Electronics	1.0	Normal	1	1	1	1.0	1.0	∞
Response Time	0.8	Rectangular	$\sqrt{3}$	1	1	0.5	0.5	∞
Integration Time	2.6	Rectangular	$\sqrt{3}$	1	1	1.5	1.5	∞
RF Ambient Conditions	3.0	Rectangular	$\sqrt{3}$	1	1	1.7	1.7	∞
Probe Positioner	0.8	Rectangular	$\sqrt{3}$	1	1	0.5	0.5	∞
Probe positioning	5.7	Normal	1	1	1	5.7	5.7	∞
Algorithms for Max. SAR Evaluation	4.0	Rectangular	$\sqrt{3}$	1	1	2.3	2.3	∞
Test EUT Related								
Device Positioning	2.9	Normal	1	1	1	2.9	2.9	145
Device Holder	3.6	Normal	1	1	1	3.6	3.6	5
Power Drift	5.0	Rectangular	$\sqrt{3}$	1	1	2.9	2.9	∞
Phantom and Tissue Parameters								
Phantom Uncertainty	4.0	Rectangular	$\sqrt{3}$	1	1	2.3	2.3	∞
Liquid Conductivity (target)	5.0	Rectangular	$\sqrt{3}$	0.64	0.43	1.8	1.2	∞
Liquid Conductivity (measurement)	2.5	Normal	1	0.64	0.43	1.6	1.1	∞
Liquid Permittivity (target)	5.0	Rectangular	$\sqrt{3}$	0.60	0.49	1.7	1.4	∞
Liquid Permittivity (measurement)	2.5	Normal	1	0.60	0.49	1.5	1.2	∞
Combined Standard Uncertainty						12.8	12.7	330
Expanded STD Uncertainty						25.7	25.3	

TABLE 7.3

The table 7.3: Worst-Case uncertainty budget for DASY4 valid for the frequency range 5 ~ 6 GHz. Probe calibration error reflects uncertainty of the narrow-bandwidth EX3DV3 probe conversion factor (±50 MHz).



8. INFORMATION ON THE TESTING LABORATORIES

We, ADT Corp., were founded in 1988 to provide our best service in EMC, Radio, Telecom and Safety consultation. Our laboratories are accredited and approved by the following approval agencies according to ISO/IEC 17025.

USA	FCC, UL, A2LA
GERMANY	TUV Rheinland
JAPAN	VCCI
NORWAY	NEMKO
CANADA	INDUSTRY CANADA, CSA
R.O.C.	TAF, BSMI, NCC
NETHERLANDS	Telefication
SINGAPORE	GOST-ASIA (MOU)
RUSSIA	CERTIS (MOU)

Copies of accreditation certificates of our laboratories obtained from approval agencies can be downloaded from our web site:

www.adt.com.tw/index.5/phtml. If you have any comments, please feel free to contact us at the following:

Linko EMC/RF Lab:

Tel: 886-2-26052180

Fax: 886-2-26051924

Hsin Chu EMC/RF Lab:

Tel: 886-3-5935343

Fax: 886-3-5935342

Hwa Ya EMC/RF/Safety/Telecom Lab:

Tel: 886-3-3183232

Fax: 886-3-3185050

Web Site: www.adt.com.tw

The address and road map of all our labs can be found in our web site also.

APPENDIX A: TEST DATA

Liquid Level Photo

Tissue HSL5800MHz D=151mm

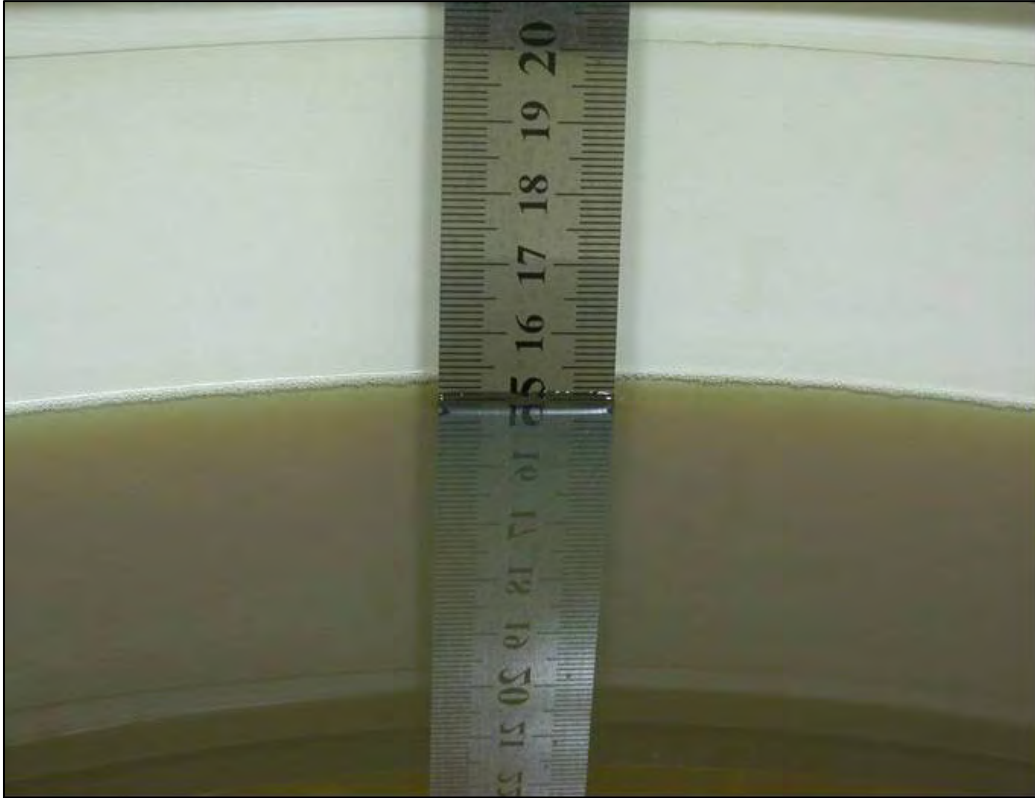

Tissue MSL5800MHz D=150mm

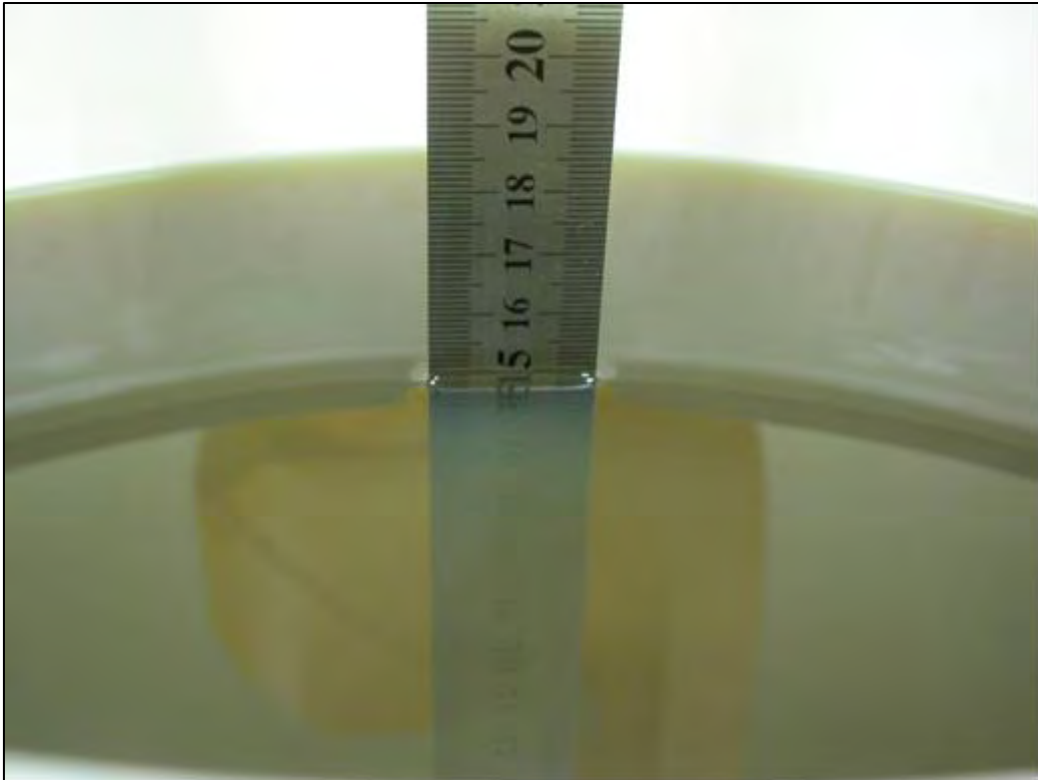

Test Laboratory: Advance Data Technology

M01-Right Head-Cheek-11a-Ch36

DUT: EDA ; Type: MC7598 ; Test Frequency: 5180 MHz

Communication System: 802.11a ; Frequency: 5180 MHz ; Duty Cycle: 1:1

Medium: HSL5800 Medium parameters used: $f = 5180$ MHz; $\sigma = 4.61$ mho/m; $\epsilon_r = 36.8$; $\rho = 1000$ kg/m³ ;

Liquid level: 151 mm

Phantom section: Right Section ; DUT test position : Cheek ; Modulation type: BPSK

Antenna type : PIFA Antenna ; Air temp. : 22.2 degrees ; Liquid temp. : 21.0 degrees

DASY4 Configuration:

- Probe: EX3DV3 - SN3506 ; ConvF(4.92, 4.92, 4.92) ; Calibrated: 2007/3/20

- Sensor-Surface: 3mm (Mechanical Surface Detection)

- Electronics: DAE3 Sn579; Calibrated: 2007/3/23

- Phantom: SAM 12; Type: SAM V4.0; Serial: TP 1202

- Measurement SW: DASY4, V4.7 Build 53; Postprocessing SW: SEMCAD, V1.8 Build 172

Touch Position - Low Channel 36/Area Scan (9x19x1): Measurement grid: dx=10mm, dy=10mm

Maximum value of SAR (measured) = 1.10 mW/g

Touch Position - Low Channel 36/Zoom Scan (8x8x8)/Cube 0: Measurement grid: dx=4.3mm, dy=4.3mm, dz=3mm

Reference Value = 8.17 V/m

Peak SAR (extrapolated) = 3.30 W/kg

SAR(1 g) = 1.01 mW/g; SAR(10 g) = 0.378 mW/g

Maximum value of SAR (measured) = 1.24 mW/g



Test Laboratory: Advance Data Technology

M01-Right Head-Cheek-11a-Ch40

DUT: EDA ; Type: MC7598 ; Test Frequency: 5200 MHz

Communication System: 802.11a ; Frequency: 5200 MHz ; Duty Cycle: 1:1

Medium: HSL5800 Medium parameters used: $f = 5200$ MHz; $\sigma = 4.63$ mho/m; $\epsilon_r = 36.7$; $\rho = 1000$ kg/m³ ;

Liquid level: 151 mm

Phantom section: Right Section ; DUT test position : Cheek ; Modulation type: BPSK

Antenna type : PIFA Antenna ; Air temp. : 22.2 degrees ; Liquid temp. : 21.0 degrees

DASY4 Configuration:

- Probe: EX3DV3 - SN3506 ; ConvF(4.92, 4.92, 4.92) ; Calibrated: 2007/3/20

- Sensor-Surface: 3mm (Mechanical Surface Detection)

- Electronics: DAE3 Sn579; Calibrated: 2007/3/23

- Phantom: SAM 12; Type: SAM V4.0; Serial: TP 1202

- Measurement SW: DASY4, V4.7 Build 53; Postprocessing SW: SEMCAD, V1.8 Build 172

Touch Position - Mid Channel 40/Area Scan (9x19x1): Measurement grid: dx=10mm, dy=10mm

Maximum value of SAR (measured) = 1.06 mW/g

Touch Position - Mid Channel 40/Zoom Scan (8x8x8)/Cube 0: Measurement grid: dx=4.3mm, dy=4.3mm, dz=3mm

Reference Value = 8.03 V/m

Peak SAR (extrapolated) = 2.94 W/kg

SAR(1 g) = 0.919 mW/g; SAR(10 g) = 0.353 mW/g

Maximum value of SAR (measured) = 1.19 mW/g



Test Laboratory: Advance Data Technology

M01-Right Head-Cheek-11a-Ch48

DUT: EDA ; Type: MC7598 ; Test Frequency: 5240 MHz

Communication System: 802.11a ; Frequency: 5240 MHz ; Duty Cycle: 1:1

Medium: HSL5800 Medium parameters used: $f = 5240$ MHz; $\sigma = 4.68$ mho/m; $\epsilon_r = 36.7$; $\rho = 1000$ kg/m³ ;

Liquid level: 151 mm

Phantom section: Right Section ; DUT test position : Cheek ; Modulation type: BPSK

Antenna type : PIFA Antenna ; Air temp. : 22.2 degrees ; Liquid temp. : 21.0 degrees

DASY4 Configuration:

- Probe: EX3DV3 - SN3506 ; ConvF(4.92, 4.92, 4.92) ; Calibrated: 2007/3/20

- Sensor-Surface: 3mm (Mechanical Surface Detection)

- Electronics: DAE3 Sn579; Calibrated: 2007/3/23

- Phantom: SAM 12; Type: SAM V4.0; Serial: TP 1202

- Measurement SW: DASY4, V4.7 Build 53; Postprocessing SW: SEMCAD, V1.8 Build 172

Touch Position - Mid Channel 48/Area Scan (9x19x1): Measurement grid: dx=10mm, dy=10mm

Maximum value of SAR (measured) = 1.08 mW/g

Touch Position - Mid Channel 48/Zoom Scan (8x8x8)/Cube 0: Measurement grid: dx=4.3mm, dy=4.3mm, dz=3mm

Reference Value = 7.64 V/m

Peak SAR (extrapolated) = 2.92 W/kg

SAR(1 g) = 0.871 mW/g; SAR(10 g) = 0.329 mW/g

Maximum value of SAR (measured) = 1.14 mW/g

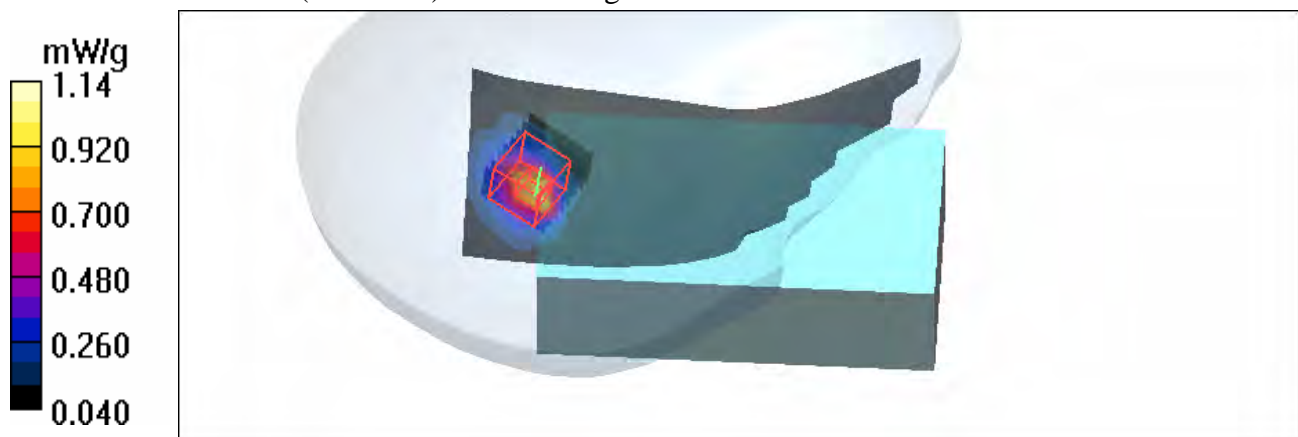

Test Laboratory: Advance Data Technology

M01-Right Head-Cheek-11a-Ch52

DUT: EDA ; Type: MC7598 ; Test Frequency: 5260 MHz

Communication System: 802.11a ; Frequency: 5260 MHz ; Duty Cycle: 1:1

Medium: HSL5800 Medium parameters used: $f = 5260$ MHz; $\sigma = 4.71$ mho/m; $\epsilon_r = 36.6$; $\rho = 1000$ kg/m³ ;

Liquid level: 151 mm

Phantom section: Right Section ; DUT test position : Cheek ; Modulation type: BPSK

Antenna type : PIFA Antenna ; Air temp. : 22.2 degrees ; Liquid temp. : 21.0 degrees

DASY4 Configuration:

- Probe: EX3DV3 - SN3506 ; ConvF(4.77, 4.77, 4.77) ; Calibrated: 2007/3/20

- Sensor-Surface: 3mm (Mechanical Surface Detection)

- Electronics: DAE3 Sn579; Calibrated: 2007/3/23

- Phantom: SAM 12; Type: SAM V4.0; Serial: TP 1202

- Measurement SW: DASY4, V4.7 Build 53; Postprocessing SW: SEMCAD, V1.8 Build 172

Touch Position - Mid Channel 52/Area Scan (9x19x1): Measurement grid: dx=10mm, dy=10mm

Maximum value of SAR (measured) = 1.08 mW/g

Touch Position - Mid Channel 52/Zoom Scan (8x8x8)/Cube 0: Measurement grid: dx=4.3mm, dy=4.3mm, dz=3mm

Reference Value = 7.87 V/m

Peak SAR (extrapolated) = 2.99 W/kg

SAR(1 g) = 0.886 mW/g; SAR(10 g) = 0.336 mW/g

Maximum value of SAR (measured) = 1.18 mW/g

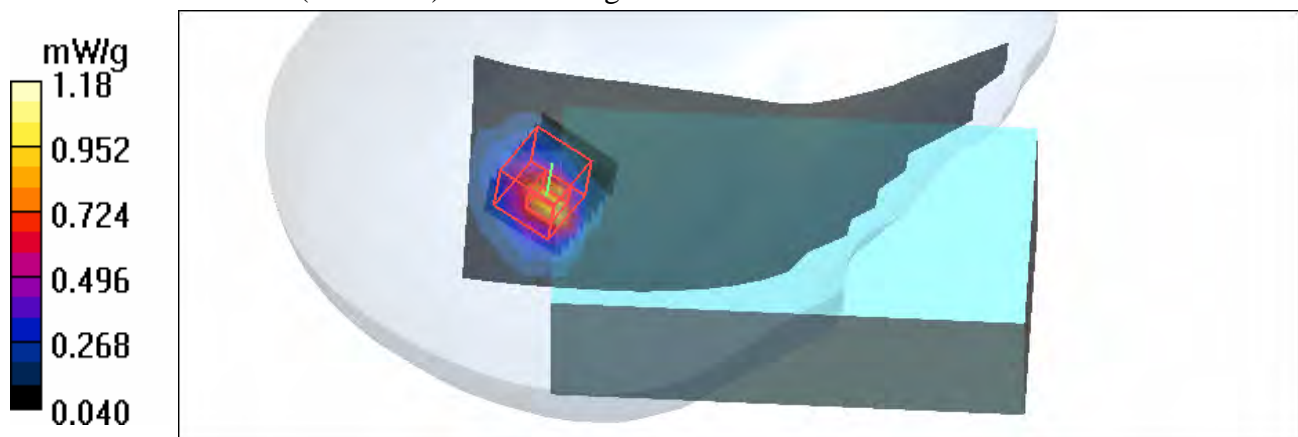

Test Laboratory: Advance Data Technology

M01-Right Head-Cheek-11a-Ch60

DUT: EDA ; Type: MC7598 ; Test Frequency: 5300 MHz

Communication System: 802.11a ; Frequency: 5300 MHz ; Duty Cycle: 1:1

Medium: HSL5800 Medium parameters used: $f = 5300$ MHz; $\sigma = 4.75$ mho/m; $\epsilon_r = 36.6$; $\rho = 1000$ kg/m³ ;

Liquid level: 151 mm

Phantom section: Right Section ; DUT test position : Cheek ; Modulation type: BPSK

Antenna type : PIFA Antenna ; Air temp. : 22.2 degrees ; Liquid temp. : 21.0 degrees

DASY4 Configuration:

- Probe: EX3DV3 - SN3506 ; ConvF(4.77, 4.77, 4.77) ; Calibrated: 2007/3/20

- Sensor-Surface: 3mm (Mechanical Surface Detection)

- Electronics: DAE3 Sn579; Calibrated: 2007/3/23

- Phantom: SAM 12; Type: SAM V4.0; Serial: TP 1202

- Measurement SW: DASY4, V4.7 Build 53; Postprocessing SW: SEMCAD, V1.8 Build 172

Touch Position - Mid Channel 60/Area Scan (9x19x1): Measurement grid: dx=10mm, dy=10mm

Maximum value of SAR (measured) = 0.92 mW/g

Touch Position - Mid Channel 60/Zoom Scan (8x8x8)/Cube 0: Measurement grid: dx=4.3mm, dy=4.3mm, dz=3mm

Reference Value = 7.28 V/m

Peak SAR (extrapolated) = 2.81 W/kg

SAR(1 g) = 0.833 mW/g; SAR(10 g) = 0.315 mW/g

Maximum value of SAR (measured) = 1.08 mW/g

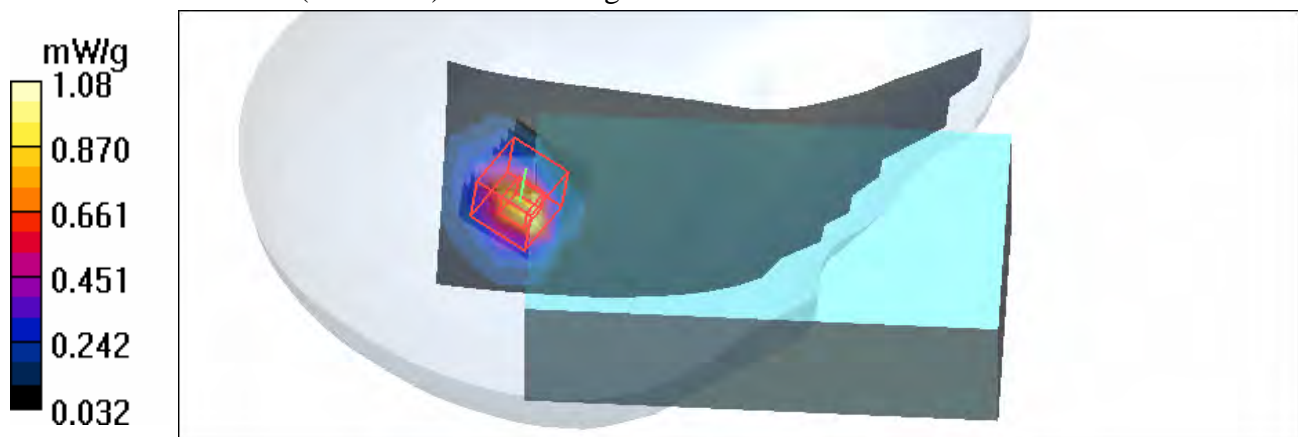

Test Laboratory: Advance Data Technology

M01-Right Head-Cheek-11a-Ch64

DUT: EDA ; Type: MC7598 ; Test Frequency: 5320 MHz

Communication System: 802.11a ; Frequency: 5320 MHz ; Duty Cycle: 1:1

Medium: HSL5800 Medium parameters used: $f = 5320$ MHz; $\sigma = 4.78$ mho/m; $\epsilon_r = 36.6$; $\rho = 1000$ kg/m³ ;

Liquid level: 151 mm

Phantom section: Right Section ; DUT test position : Cheek ; Modulation type: BPSK

Antenna type : PIFA Antenna ; Air temp. : 22.2 degrees ; Liquid temp. : 21.0 degrees

DASY4 Configuration:

- Probe: EX3DV3 - SN3506 ; ConvF(4.77, 4.77, 4.77) ; Calibrated: 2007/3/20

- Sensor-Surface: 3mm (Mechanical Surface Detection)

- Electronics: DAE3 Sn579; Calibrated: 2007/3/23

- Phantom: SAM 12; Type: SAM V4.0; Serial: TP 1202

- Measurement SW: DASY4, V4.7 Build 53; Postprocessing SW: SEMCAD, V1.8 Build 172

Touch Position - Mid Channel 64/Area Scan (9x19x1): Measurement grid: dx=10mm, dy=10mm

Maximum value of SAR (measured) = 0.87 mW/g

Touch Position - Mid Channel 64/Zoom Scan (8x8x8)/Cube 0: Measurement grid: dx=4.3mm, dy=4.3mm, dz=3mm

Reference Value = 6.81 V/m

Peak SAR (extrapolated) = 2.63 W/kg

SAR(1 g) = 0.786 mW/g; SAR(10 g) = 0.299 mW/g

Maximum value of SAR (measured) = 0.95 mW/g

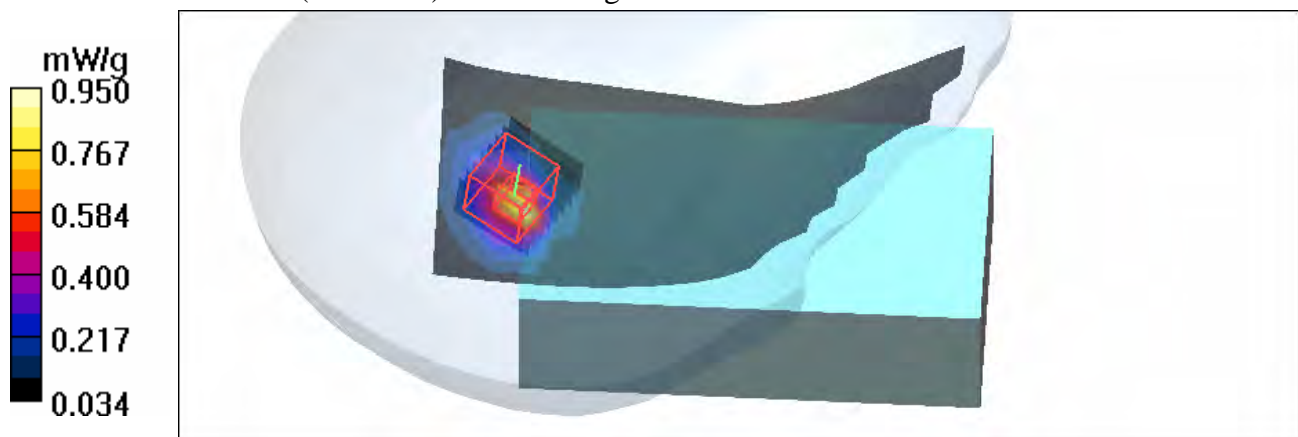

Test Laboratory: Advance Data Technology

M01-Right Head-Cheek-11a-Ch100

DUT: EDA ; Type: MC7598 ; Test Frequency: 5500 MHz

Communication System: 802.11a ; Frequency: 5500 MHz ; Duty Cycle: 1:1

Medium: HSL5800 Medium parameters used: $f = 5500$ MHz; $\sigma = 4.99$ mho/m; $\epsilon_r = 36.3$; $\rho = 1000$ kg/m³ ;

Liquid level: 151 mm

Phantom section: Right Section ; DUT test position : Cheek ; Modulation type: BPSK

Antenna type : PIFA Antenna ; Air temp. : 22.2 degrees ; Liquid temp. : 21.0 degrees

DASY4 Configuration:

- Probe: EX3DV3 - SN3506 ; ConvF(4.55, 4.55, 4.55) ; Calibrated: 2007/3/20
- Sensor-Surface: 3mm (Mechanical Surface Detection)
- Electronics: DAE3 Sn579; Calibrated: 2007/3/23
- Phantom: SAM 12; Type: SAM V4.0; Serial: TP 1202
- Measurement SW: DASY4, V4.7 Build 53; Postprocessing SW: SEMCAD, V1.8 Build 172

Touch Position - Mid Channel 100/Area Scan (9x19x1): Measurement grid: dx=10mm, dy=10mm

Maximum value of SAR (measured) = 0.570 mW/g

Touch Position - Mid Channel 100/Zoom Scan (8x8x8)/Cube 0: Measurement grid: dx=4.3mm, dy=4.3mm, dz=3mm

Reference Value = 4.16 V/m

Peak SAR (extrapolated) = 1.57 W/kg

SAR(1 g) = 0.444 mW/g; SAR(10 g) = 0.183 mW/g

Maximum value of SAR (measured) = 0.607 mW/g

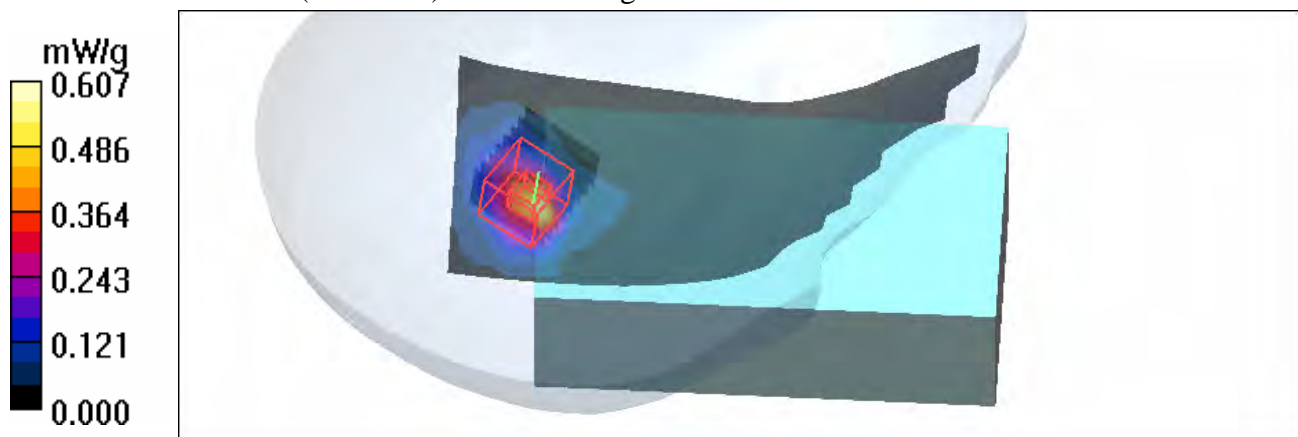

Test Laboratory: Advance Data Technology

M01-Right Head-Cheek-11a-Ch104

DUT: EDA ; Type: MC7598 ; Test Frequency: 5520 MHz

Communication System: 802.11a ; Frequency: 5520 MHz ; Duty Cycle: 1:1

Medium: HSL5800 Medium parameters used: $f = 5520$ MHz; $\sigma = 5.01$ mho/m; $\epsilon_r = 36.2$; $\rho = 1000$ kg/m³ ;

Liquid level: 151 mm

Phantom section: Right Section ; DUT test position : Cheek ; Modulation type: BPSK

Antenna type : PIFA Antenna ; Air temp. : 22.2 degrees ; Liquid temp. : 21.0 degrees

DASY4 Configuration:

- Probe: EX3DV3 - SN3506 ; ConvF(4.55, 4.55, 4.55) ; Calibrated: 2007/3/20

- Sensor-Surface: 3mm (Mechanical Surface Detection)

- Electronics: DAE3 Sn579; Calibrated: 2007/3/23

- Phantom: SAM 12; Type: SAM V4.0; Serial: TP 1202

- Measurement SW: DASY4, V4.7 Build 53; Postprocessing SW: SEMCAD, V1.8 Build 172

Touch Position - Mid Channel 104/Area Scan (9x19x1): Measurement grid: dx=10mm, dy=10mm

Maximum value of SAR (measured) = 0.725 mW/g

Touch Position - Mid Channel 104/Zoom Scan (8x8x8)/Cube 0: Measurement grid: dx=4.3mm, dy=4.3mm, dz=3mm

Reference Value = 6.34 V/m

Peak SAR (extrapolated) = 2.58 W/kg

SAR(1 g) = 0.714 mW/g; SAR(10 g) = 0.296 mW/g

Maximum value of SAR (measured) = 0.863 mW/g

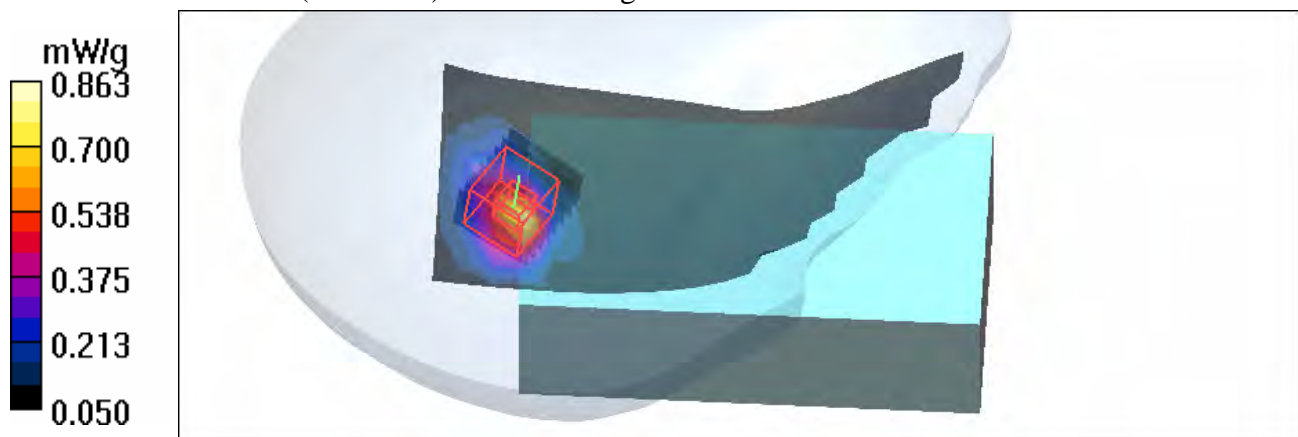

Test Laboratory: Advance Data Technology

M01-Right Head-Cheek-11a-Ch116

DUT: EDA ; Type: MC7598 ; Test Frequency: 5580 MHz

Communication System: 802.11a ; Frequency: 5580 MHz ; Duty Cycle: 1:1

Medium: HSL5800 Medium parameters used: $f = 5580$ MHz; $\sigma = 5.09$ mho/m; $\epsilon_r = 36.1$; $\rho = 1000$ kg/m³ ;

Liquid level: 151 mm

Phantom section: Right Section ; DUT test position : Cheek ; Modulation type: BPSK

Antenna type : PIFA Antenna ; Air temp. : 22.2 degrees ; Liquid temp. : 21.0 degrees

DASY4 Configuration:

- Probe: EX3DV3 - SN3506 ; ConvF(4.55, 4.55, 4.55) ; Calibrated: 2007/3/20

- Sensor-Surface: 3mm (Mechanical Surface Detection)

- Electronics: DAE3 Sn579; Calibrated: 2007/3/23

- Phantom: SAM 12; Type: SAM V4.0; Serial: TP 1202

- Measurement SW: DASY4, V4.7 Build 53; Postprocessing SW: SEMCAD, V1.8 Build 172

Touch Position - Mid Channel 116/Area Scan (9x19x1): Measurement grid: dx=10mm, dy=10mm

Maximum value of SAR (measured) = 0.803 mW/g

Touch Position - Mid Channel 116/Zoom Scan (8x8x8)/Cube 0: Measurement grid: dx=4.3mm, dy=4.3mm, dz=3mm

Reference Value = 6.69 V/m

Peak SAR (extrapolated) = 2.30 W/kg

SAR(1 g) = 0.621 mW/g; SAR(10 g) = 0.240 mW/g

Maximum value of SAR (measured) = 0.882 mW/g

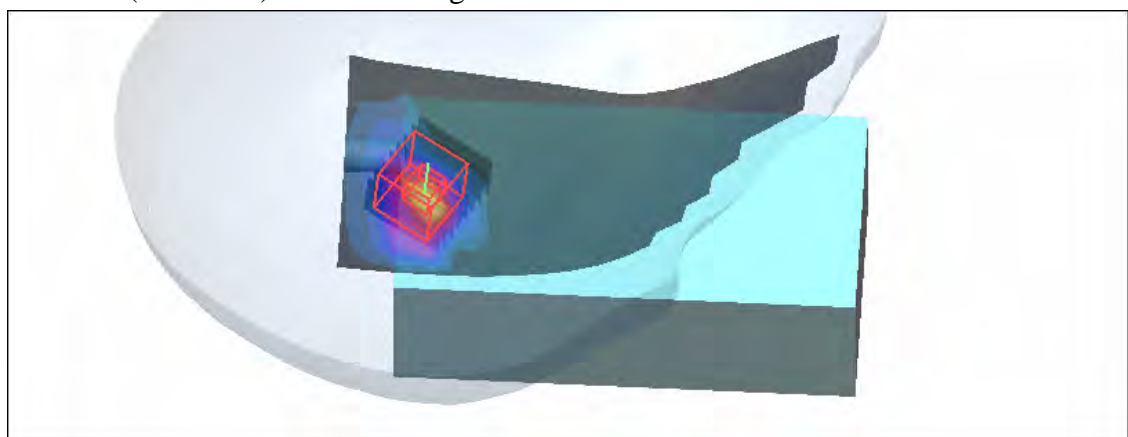
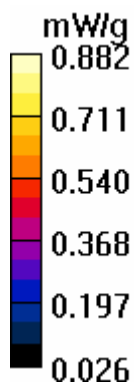

Test Laboratory: Advance Data Technology

M01-Right Head-Cheek-11a-Ch120

DUT: EDA ; Type: MC7598 ; Test Frequency: 5600 MHz

Communication System: 802.11a ; Frequency: 5600 MHz ; Duty Cycle: 1:1

Medium: HSL5800 Medium parameters used: $f = 5600$ MHz; $\sigma = 5.11$ mho/m; $\epsilon_r = 36.1$; $\rho = 1000$ kg/m³ ;

Liquid level: 151 mm

Phantom section: Right Section ; DUT test position : Cheek ; Modulation type: BPSK

Antenna type : PIFA Antenna ; Air temp. : 22.2 degrees ; Liquid temp. : 21.0 degrees

DASY4 Configuration:

- Probe: EX3DV3 - SN3506 ; ConvF(4.55, 4.55, 4.55) ; Calibrated: 2007/3/20

- Sensor-Surface: 3mm (Mechanical Surface Detection)

- Electronics: DAE3 Sn579; Calibrated: 2007/3/23

- Phantom: SAM 12; Type: SAM V4.0; Serial: TP 1202

- Measurement SW: DASY4, V4.7 Build 53; Postprocessing SW: SEMCAD, V1.8 Build 172

Touch Position - Mid Channel 120/Area Scan (9x19x1): Measurement grid: dx=10mm, dy=10mm

Maximum value of SAR (measured) = 0.838 mW/g

Touch Position - Mid Channel 120/Zoom Scan (8x8x8)/Cube 0: Measurement grid: dx=4.3mm, dy=4.3mm, dz=3mm

Reference Value = 6.61 V/m

Peak SAR (extrapolated) = 2.51 W/kg

SAR(1 g) = 0.635 mW/g; SAR(10 g) = 0.242 mW/g

Maximum value of SAR (measured) = 0.874 mW/g

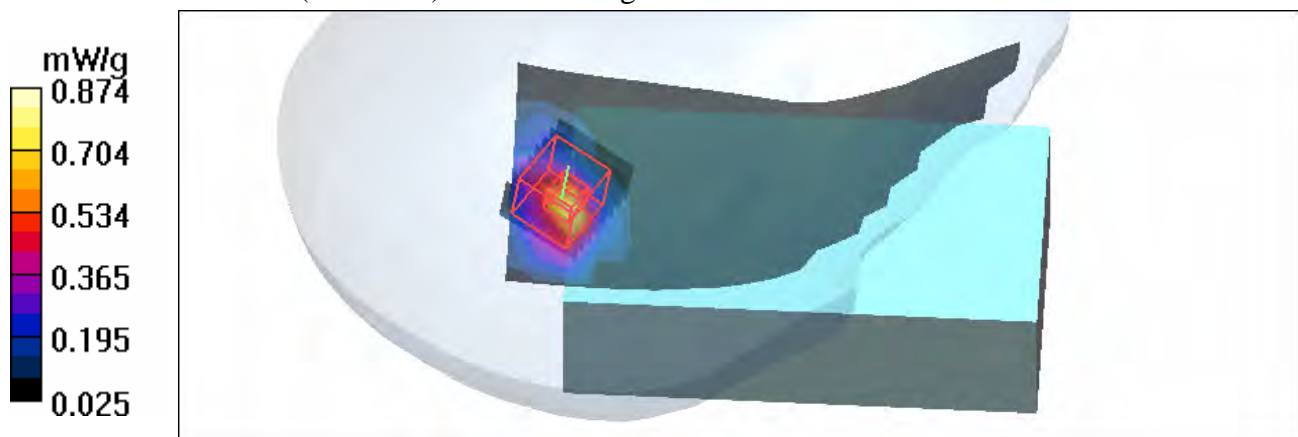

Test Laboratory: Advance Data Technology

M01-Right Head-Cheek-11a-Ch124**DUT: EDA ; Type: MC7598 ; Test Frequency: 5620 MHz**

Communication System: 802.11a ; Frequency: 5620 MHz ; Duty Cycle: 1:1

Medium: HSL5800 Medium parameters used: $f = 5620$ MHz; $\sigma = 5.14$ mho/m; $\epsilon_r = 36$; $\rho = 1000$ kg/m³ ;

Liquid level: 151 mm

Phantom section: Right Section ; DUT test position : Cheek ; Modulation type: BPSK

Antenna type : PIFA Antenna ; Air temp. : 22.2 degrees ; Liquid temp. : 21.0 degrees

DASY4 Configuration:

- Probe: EX3DV3 - SN3506 ; ConvF(4.55, 4.55, 4.55) ; Calibrated: 2007/3/20
- Sensor-Surface: 3mm (Mechanical Surface Detection)
- Electronics: DAE3 Sn579; Calibrated: 2007/3/23
- Phantom: SAM 12; Type: SAM V4.0; Serial: TP 1202
- Measurement SW: DASY4, V4.7 Build 53; Postprocessing SW: SEMCAD, V1.8 Build 172

Touch Position - Mid Channel 124/Area Scan (9x19x1): Measurement grid: dx=10mm, dy=10mm

Maximum value of SAR (measured) = 0.732 mW/g

Touch Position - Mid Channel 124/Zoom Scan (8x8x8)/Cube 0: Measurement grid: dx=4.3mm, dy=4.3mm, dz=3mm

Reference Value = 5.47 V/m

Peak SAR (extrapolated) = 2.36 W/kg

SAR(1 g) = 0.593 mW/g; SAR(10 g) = 0.222 mW/g

Maximum value of SAR (measured) = 0.829 mW/g

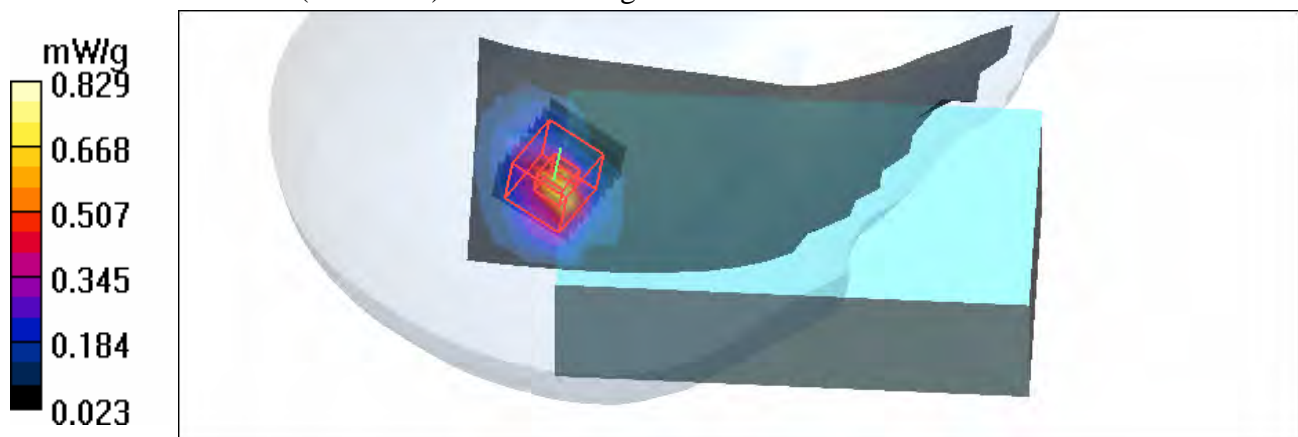

Test Laboratory: Advance Data Technology

M01-Right Head-Cheek-11a-Ch136

DUT: EDA ; Type: MC7598 ; Test Frequency: 5680 MHz

Communication System: 802.11a ; Frequency: 5680 MHz ; Duty Cycle: 1:1

Medium: HSL5800 Medium parameters used: $f = 5680$ MHz; $\sigma = 5.21$ mho/m; $\epsilon_r = 35.9$; $\rho = 1000$ kg/m³ ;

Liquid level: 151 mm

Phantom section: Right Section ; DUT test position : Cheek ; Modulation type: BPSK

Antenna type : PIFA Antenna ; Air temp. : 22.2 degrees ; Liquid temp. : 21.0 degrees

DASY4 Configuration:

- Probe: EX3DV3 - SN3506 ; ConvF(4.4, 4.4, 4.4) ; Calibrated: 2007/3/20

- Sensor-Surface: 3mm (Mechanical Surface Detection)

- Electronics: DAE3 Sn579; Calibrated: 2007/3/23

- Phantom: SAM 12; Type: SAM V4.0; Serial: TP 1202

- Measurement SW: DASY4, V4.7 Build 53; Postprocessing SW: SEMCAD, V1.8 Build 172

Touch Position - Mid Channel 136/Area Scan (9x19x1): Measurement grid: dx=10mm, dy=10mm

Maximum value of SAR (measured) = 0.91 mW/g

Touch Position - Mid Channel 136/Zoom Scan (8x8x8)/Cube 0: Measurement grid: dx=4.3mm, dy=4.3mm, dz=3mm

Reference Value = 7.02 V/m

Peak SAR (extrapolated) = 2.95 W/kg

SAR(1 g) = 0.773 mW/g; SAR(10 g) = 0.280 mW/g

Maximum value of SAR (measured) = 1.01 mW/g

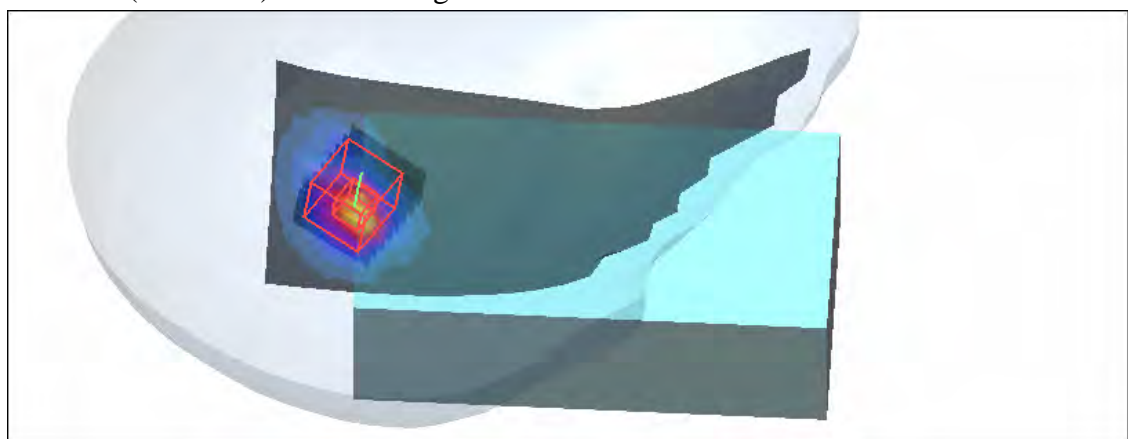
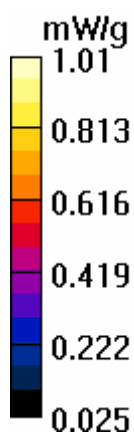

Test Laboratory: Advance Data Technology

M01-Right Head-Cheek-11a-Ch140

DUT: EDA ; Type: MC7598 ; Test Frequency: 5700 MHz

Communication System: 802.11a ; Frequency: 5700 MHz ; Duty Cycle: 1:1

Medium: HSL5800 Medium parameters used: $f = 5700$ MHz; $\sigma = 5.23$ mho/m; $\epsilon_r = 35.9$; $\rho = 1000$ kg/m³ ;

Liquid level: 151 mm

Phantom section: Right Section ; DUT test position : Cheek ; Modulation type: BPSK

Antenna type : PIFA Antenna ; Air temp. : 22.2 degrees ; Liquid temp. : 21.0 degrees

DASY4 Configuration:

- Probe: EX3DV3 - SN3506 ; ConvF(4.4, 4.4, 4.4) ; Calibrated: 2007/3/20

- Sensor-Surface: 3mm (Mechanical Surface Detection)

- Electronics: DAE3 Sn579; Calibrated: 2007/3/23

- Phantom: SAM 12; Type: SAM V4.0; Serial: TP 1202

- Measurement SW: DASY4, V4.7 Build 53; Postprocessing SW: SEMCAD, V1.8 Build 172

Touch Position - Mid Channel 140/Area Scan (9x19x1): Measurement grid: dx=10mm, dy=10mm

Maximum value of SAR (measured) = 0.326 mW/g

Touch Position - Mid Channel 140/Zoom Scan (8x8x8)/Cube 0: Measurement grid: dx=4.3mm, dy=4.3mm, dz=3mm

Reference Value = 4.78 V/m

Peak SAR (extrapolated) = 1.19 W/kg

SAR(1 g) = 0.268 mW/g; SAR(10 g) = 0.108 mW/g

Maximum value of SAR (measured) = 0.334 mW/g

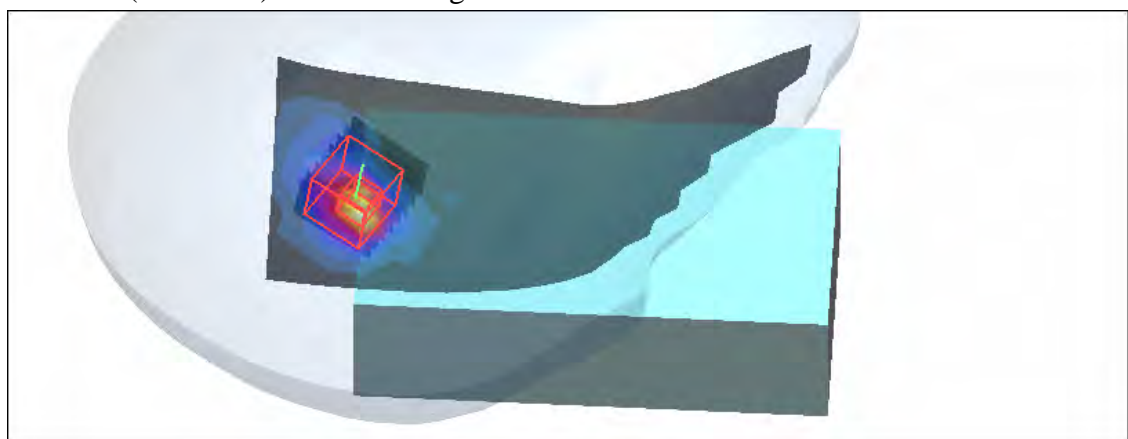
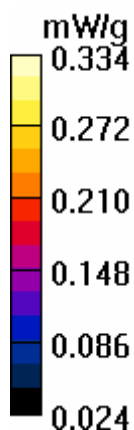

Test Laboratory: Advance Data Technology

M02-Right Head-Tilt-11a-Ch36

DUT: EDA ; Type: MC7598 ; Test Frequency: 5180 MHz

Communication System: 802.11a ; Frequency: 5180 MHz; Duty Cycle: 1:1

Medium: HSL5800 Medium parameters used: $f = 5180$ MHz; $\sigma = 4.61$ mho/m; $\epsilon_r = 36.8$; $\rho = 1000$ kg/m³ ;

Liquid level: 151 mm

Phantom section: Right Section ; DUT test position : Tilt ; Modulation type: BPSK

Antenna type : PIFA Antenna ; Air temp. : 22.2 degrees ; Liquid temp. : 21.0 degrees

DASY4 Configuration:

- Probe: EX3DV3 - SN3506 ; ConvF(4.92, 4.92, 4.92) ; Calibrated: 2007/3/20

- Sensor-Surface: 3mm (Mechanical Surface Detection)

- Electronics: DAE3 Sn579; Calibrated: 2007/3/23

- Phantom: SAM 12; Type: SAM V4.0; Serial: TP 1202

- Measurement SW: DASY4, V4.7 Build 53; Postprocessing SW: SEMCAD, V1.8 Build 172

Tilt Position - Low Channel 36/Area Scan (9x19x1): Measurement grid: dx=10mm, dy=10mm

Maximum value of SAR (measured) = 1.02 mW/g

Tilt Position - Low Channel 36/Zoom Scan (8x8x8)/Cube 0: Measurement grid: dx=4.3mm,

dy=4.3mm, dz=3mm

Reference Value = 10.3 V/m

Peak SAR (extrapolated) = 3.35 W/kg

SAR(1 g) = 0.936 mW/g; SAR(10 g) = 0.317 mW/g

Maximum value of SAR (measured) = 1.16 mW/g

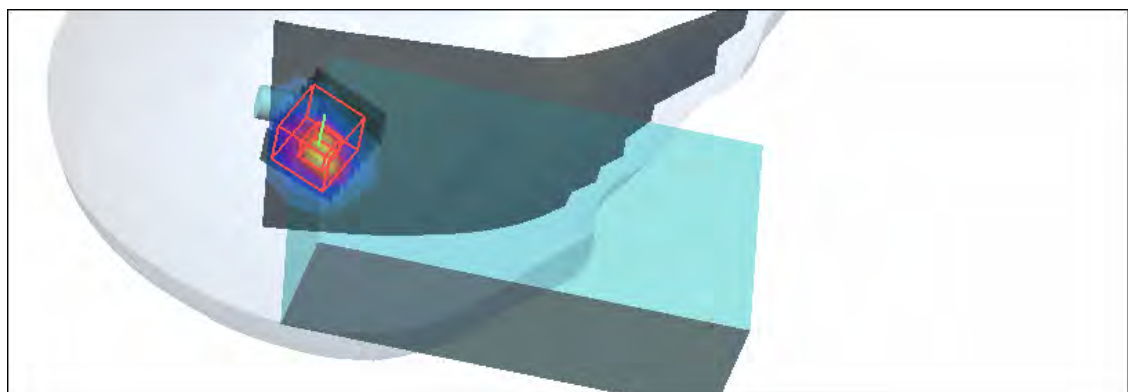
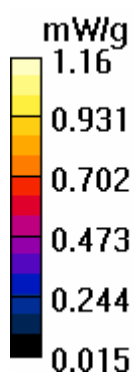

Test Laboratory: Advance Data Technology

M02-Right Head-Tilt-11a-Ch40

DUT: EDA ; Type: MC7598 ; Test Frequency: 5200 MHz

Communication System: 802.11a ; Frequency: 5200 MHz; Duty Cycle: 1:1

Medium: HSL5800 Medium parameters used: $f = 5200$ MHz; $\sigma = 4.63$ mho/m; $\epsilon_r = 36.7$; $\rho = 1000$ kg/m³ ;

Liquid level: 151 mm

Phantom section: Right Section ; DUT test position : Tilt ; Modulation type: BPSK

Antenna type : PIFA Antenna ; Air temp. : 22.2 degrees ; Liquid temp. : 21.0 degrees

DASY4 Configuration:

- Probe: EX3DV3 - SN3506 ; ConvF(4.92, 4.92, 4.92) ; Calibrated: 2007/3/20

- Sensor-Surface: 3mm (Mechanical Surface Detection)

- Electronics: DAE3 Sn579; Calibrated: 2007/3/23

- Phantom: SAM 12; Type: SAM V4.0; Serial: TP 1202

- Measurement SW: DASY4, V4.7 Build 53; Postprocessing SW: SEMCAD, V1.8 Build 172

Tilt Position - Mid Channel 40/Area Scan (9x19x1): Measurement grid: dx=10mm, dy=10mm

Maximum value of SAR (measured) = 1.14 mW/g

Tilt Position - Mid Channel 40/Zoom Scan (8x8x8)/Cube 0: Measurement grid: dx=4.3mm,

dy=4.3mm, dz=3mm

Reference Value = 10.6 V/m

Peak SAR (extrapolated) = 3.70 W/kg

SAR(1 g) = 1.08 mW/g; SAR(10 g) = 0.366 mW/g

Maximum value of SAR (measured) = 1.23 mW/g

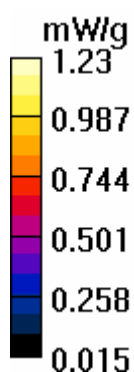

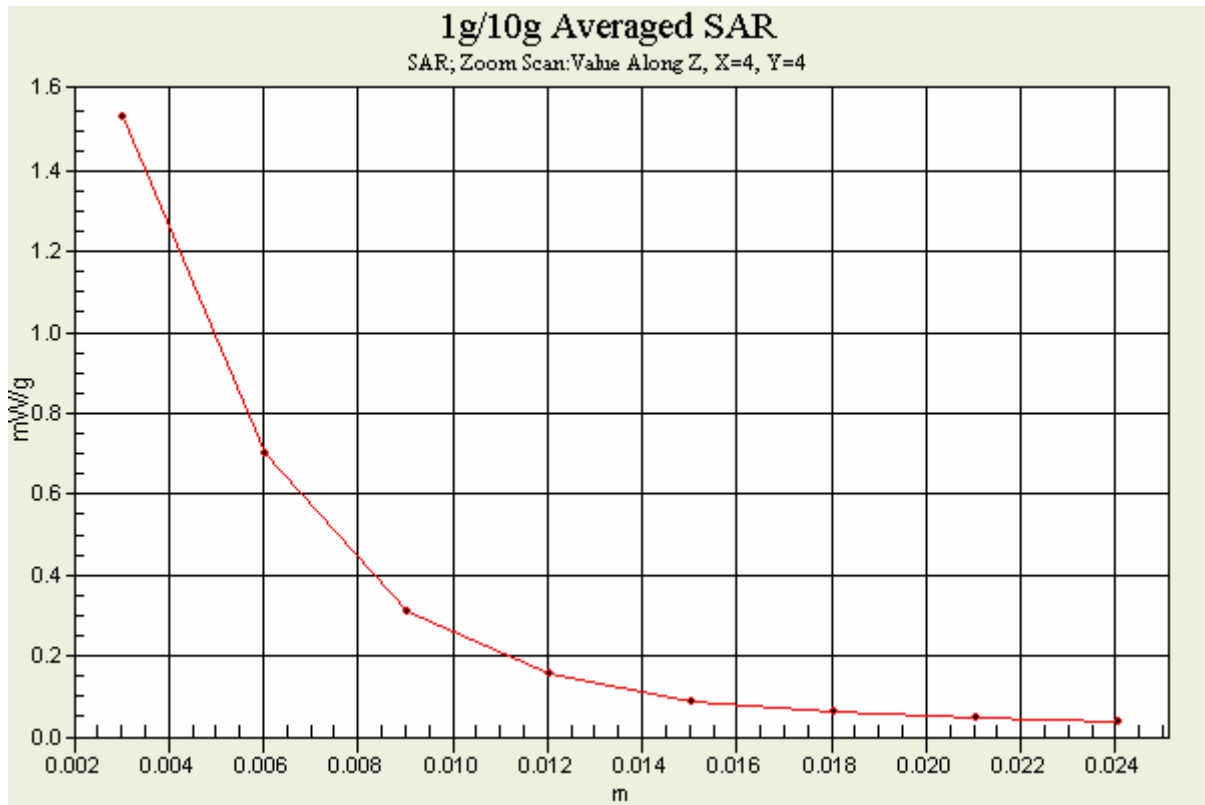

Test Laboratory: Advance Data Technology

M02-Right Head-Tilt-11a-Ch48

DUT: EDA ; Type: MC7598 ; Test Frequency: 5240 MHz

Communication System: 802.11a ; Frequency: 5240 MHz; Duty Cycle: 1:1

Medium: HSL5800 Medium parameters used: $f = 5240$ MHz; $\sigma = 4.68$ mho/m; $\epsilon_r = 36.7$; $\rho = 1000$ kg/m³ ;

Liquid level: 151 mm

Phantom section: Right Section ; DUT test position : Tilt ; Modulation type: BPSK

Antenna type : PIFA Antenna ; Air temp. : 22.2 degrees ; Liquid temp. : 21.0 degrees

DASY4 Configuration:

- Probe: EX3DV3 - SN3506 ; ConvF(4.92, 4.92, 4.92) ; Calibrated: 2007/3/20

- Sensor-Surface: 3mm (Mechanical Surface Detection)

- Electronics: DAE3 Sn579; Calibrated: 2007/3/23

- Phantom: SAM 12; Type: SAM V4.0; Serial: TP 1202

- Measurement SW: DASY4, V4.7 Build 53; Postprocessing SW: SEMCAD, V1.8 Build 172

Tilt Position - Mid Channel 48/Area Scan (9x19x1): Measurement grid: dx=10mm, dy=10mm

Maximum value of SAR (measured) = 1.01 mW/g

Tilt Position - Mid Channel 48/Zoom Scan (8x8x8)/Cube 0: Measurement grid: dx=4.3mm,

dy=4.3mm, dz=3mm

Reference Value = 9.71 V/m

Peak SAR (extrapolated) = 3.35 W/kg

SAR(1 g) = 0.975 mW/g; SAR(10 g) = 0.337 mW/g

Maximum value of SAR (measured) = 1.18 mW/g

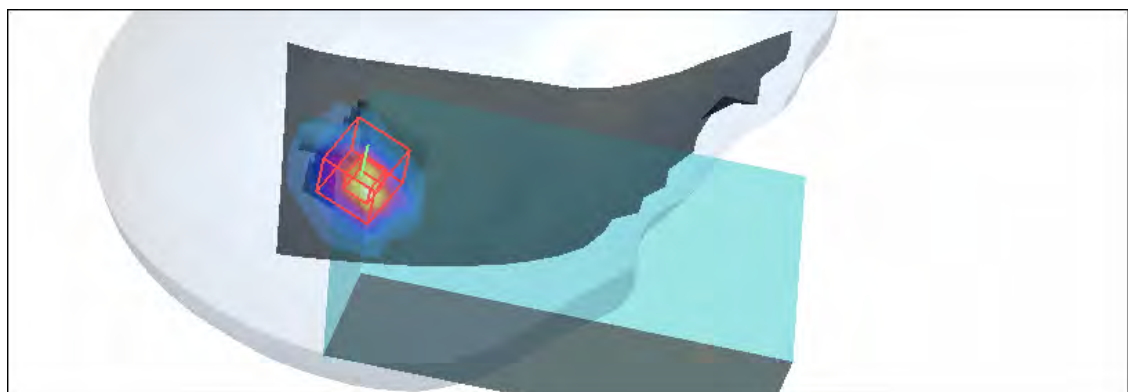
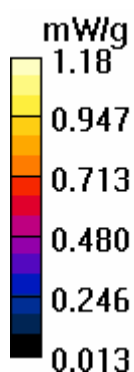

Test Laboratory: Advance Data Technology

M02-Right Head-Tilt-11a-Ch52

DUT: EDA ; Type: MC7598 ; Test Frequency: 5260 MHz

Communication System: 802.11a ; Frequency: 5260 MHz; Duty Cycle: 1:1

Medium: HSL5800 Medium parameters used: $f = 5260$ MHz; $\sigma = 4.71$ mho/m; $\epsilon_r = 36.6$; $\rho = 1000$ kg/m³ ;

Liquid level: 151 mm

Phantom section: Right Section ; DUT test position : Tilt ; Modulation type: BPSK

Antenna type : PIFA Antenna ; Air temp. : 22.2 degrees ; Liquid temp. : 21.0 degrees

DASY4 Configuration:

- Probe: EX3DV3 - SN3506 ; ConvF(4.77, 4.77, 4.77) ; Calibrated: 2007/3/20

- Sensor-Surface: 3mm (Mechanical Surface Detection)

- Electronics: DAE3 Sn579; Calibrated: 2007/3/23

- Phantom: SAM 12; Type: SAM V4.0; Serial: TP 1202

- Measurement SW: DASY4, V4.7 Build 53; Postprocessing SW: SEMCAD, V1.8 Build 172

Tilt Position - Mid Channel 52/Area Scan (9x19x1): Measurement grid: dx=10mm, dy=10mm

Maximum value of SAR (measured) = 1.03 mW/g

Tilt Position - Mid Channel 52/Zoom Scan (8x8x8)/Cube 0: Measurement grid: dx=4.3mm,

dy=4.3mm, dz=3mm

Reference Value = 10.1 V/m

Peak SAR (extrapolated) = 3.37 W/kg

SAR(1 g) = 0.989 mW/g; SAR(10 g) = 0.347 mW/g

Maximum value of SAR (measured) = 1.19 mW/g

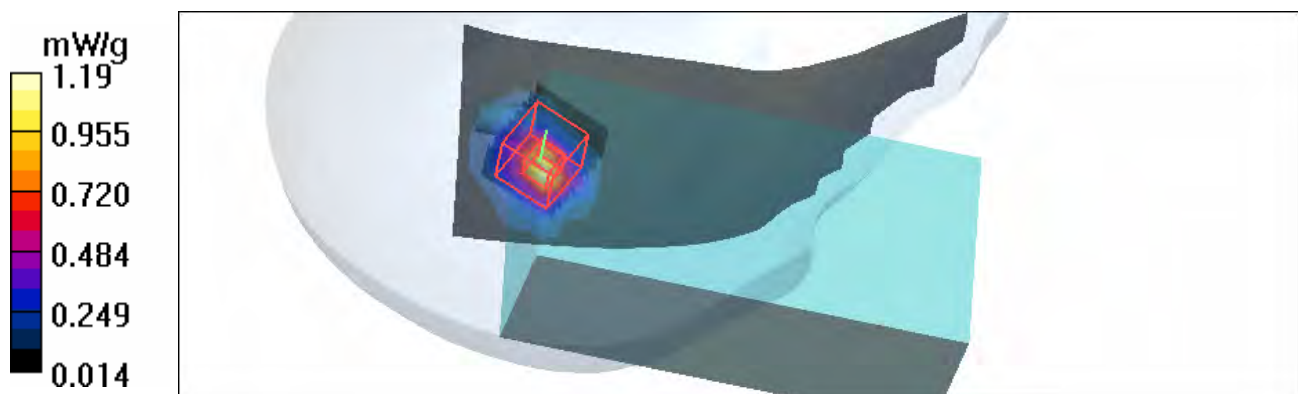

Test Laboratory: Advance Data Technology

M02-Right Head-Tilt-11a-Ch60

DUT: EDA ; Type: MC7598 ; Test Frequency: 5300 MHz

Communication System: 802.11a ; Frequency: 5300 MHz; Duty Cycle: 1:1

Medium: HSL5800 Medium parameters used: $f = 5300$ MHz; $\sigma = 4.75$ mho/m; $\epsilon_r = 36.6$; $\rho = 1000$ kg/m³ ;

Liquid level: 151 mm

Phantom section: Right Section ; DUT test position : Tilt ; Modulation type: BPSK

Antenna type : PIFA Antenna ; Air temp. : 22.2 degrees ; Liquid temp. : 21.0 degrees

DASY4 Configuration:

- Probe: EX3DV3 - SN3506 ; ConvF(4.77, 4.77, 4.77) ; Calibrated: 2007/3/20

- Sensor-Surface: 3mm (Mechanical Surface Detection)

- Electronics: DAE3 Sn579; Calibrated: 2007/3/23

- Phantom: SAM 12; Type: SAM V4.0; Serial: TP 1202

- Measurement SW: DASY4, V4.7 Build 53; Postprocessing SW: SEMCAD, V1.8 Build 172

Tilt Position - Mid Channel 60/Area Scan (9x19x1): Measurement grid: dx=10mm, dy=10mm

Maximum value of SAR (measured) = 0.94 mW/g

Tilt Position - Mid Channel 60/Zoom Scan (8x8x8)/Cube 0: Measurement grid: dx=4.3mm,

dy=4.3mm, dz=3mm

Reference Value = 9.58 V/m

Peak SAR (extrapolated) = 2.87 W/kg

SAR(1 g) = 0.835 mW/g; SAR(10 g) = 0.302 mW/g

Maximum value of SAR (measured) = 1.05 mW/g

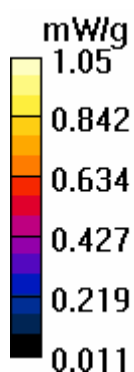

Test Laboratory: Advance Data Technology

M02-Right Head-Tilt-11a-Ch64

DUT: EDA ; Type: MC7598 ; Test Frequency: 5320 MHz

Communication System: 802.11a ; Frequency: 5320 MHz; Duty Cycle: 1:1

Medium: HSL5800 Medium parameters used: $f = 5320$ MHz; $\sigma = 4.78$ mho/m; $\epsilon_r = 36.6$; $\rho = 1000$ kg/m³ ;

Liquid level: 151 mm

Phantom section: Right Section ; DUT test position : Tilt ; Modulation type: BPSK

Antenna type : PIFA Antenna ; Air temp. : 22.2 degrees ; Liquid temp. : 21.0 degrees

DASY4 Configuration:

- Probe: EX3DV3 - SN3506 ; ConvF(4.77, 4.77, 4.77) ; Calibrated: 2007/3/20

- Sensor-Surface: 3mm (Mechanical Surface Detection)

- Electronics: DAE3 Sn579; Calibrated: 2007/3/23

- Phantom: SAM 12; Type: SAM V4.0; Serial: TP 1202

- Measurement SW: DASY4, V4.7 Build 53; Postprocessing SW: SEMCAD, V1.8 Build 172

Tilt Position - Mid Channel 64/Area Scan (9x19x1): Measurement grid: dx=10mm, dy=10mm

Maximum value of SAR (measured) = 1.04 mW/g

Tilt Position - Mid Channel 64/Zoom Scan (8x8x8)/Cube 0: Measurement grid: dx=4.3mm,

dy=4.3mm, dz=3mm

Reference Value = 8.90 V/m

Peak SAR (extrapolated) = 2.77 W/kg

SAR(1 g) = 0.839 mW/g; SAR(10 g) = 0.306 mW/g

Maximum value of SAR (measured) = 1.19 mW/g

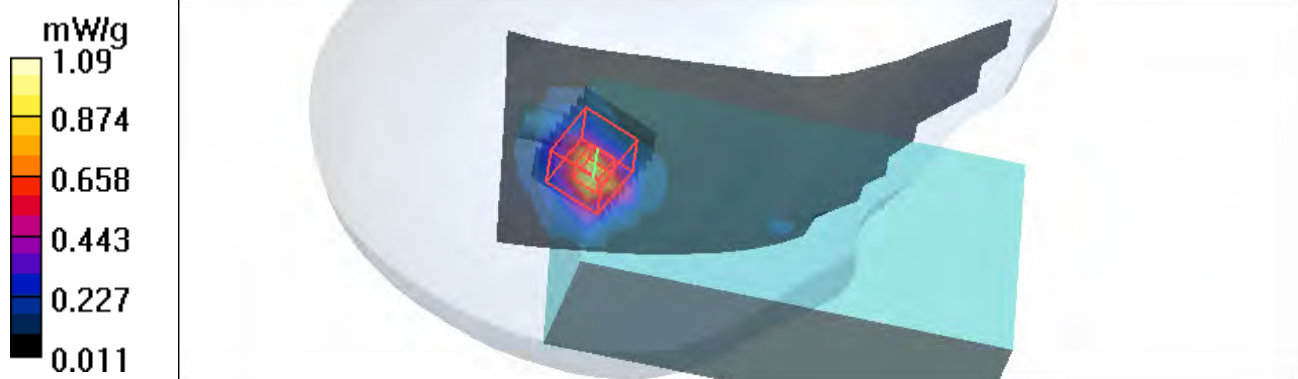

Test Laboratory: Advance Data Technology

M02-Right Head-Tilt-11a-Ch100

DUT: EDA ; Type: MC7598 ; Test Frequency: 5500 MHz

Communication System: 802.11a ; Frequency: 5500 MHz; Duty Cycle: 1:1

Medium: HSL5800 Medium parameters used: $f = 5500$ MHz; $\sigma = 4.99$ mho/m; $\epsilon_r = 36.3$; $\rho = 1000$ kg/m³ ;

Liquid level: 151 mm

Phantom section: Right Section ; DUT test position : Tilt ; Modulation type: BPSK

Antenna type : PIFA Antenna ; Air temp. : 22.2 degrees ; Liquid temp. : 21.0 degrees

DASY4 Configuration:

- Probe: EX3DV3 - SN3506 ; ConvF(4.55, 4.55, 4.55) ; Calibrated: 2007/3/20

- Sensor-Surface: 3mm (Mechanical Surface Detection)

- Electronics: DAE3 Sn579; Calibrated: 2007/3/23

- Phantom: SAM 12; Type: SAM V4.0; Serial: TP 1202

- Measurement SW: DASY4, V4.7 Build 53; Postprocessing SW: SEMCAD, V1.8 Build 172

Tilt Position - Mid Channel 100/Area Scan (9x19x1): Measurement grid: dx=10mm, dy=10mm

Maximum value of SAR (measured) = 0.453 mW/g

Tilt Position - Mid Channel 100/Zoom Scan (8x8x8)/Cube 0: Measurement grid: dx=4.3mm,

dy=4.3mm, dz=3mm

Reference Value = 6.38 V/m

Peak SAR (extrapolated) = 1.47 W/kg

SAR(1 g) = 0.435 mW/g; SAR(10 g) = 0.167 mW/g

Maximum value of SAR (measured) = 0.526 mW/g

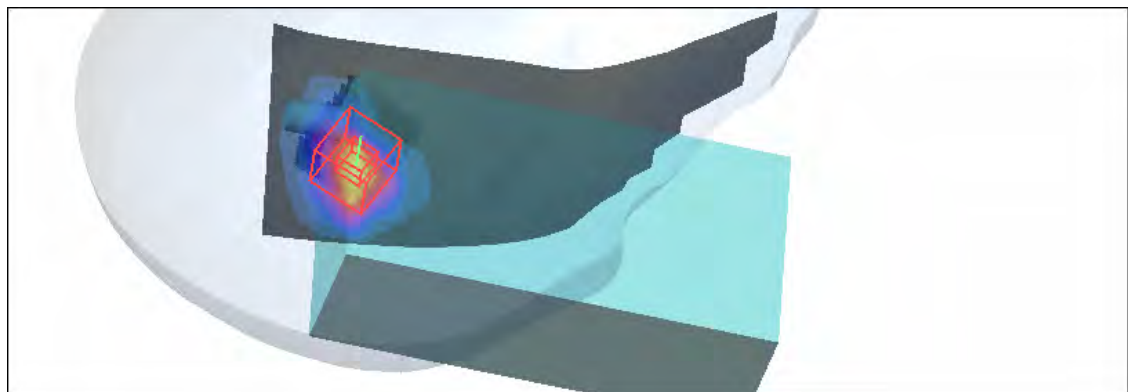
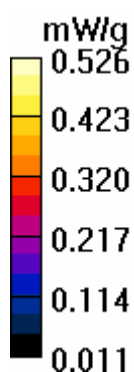

Test Laboratory: Advance Data Technology

M02-Right Head-Tilt-11a-Ch104

DUT: EDA ; Type: MC7598 ; Test Frequency: 5520 MHz

Communication System: 802.11a ; Frequency: 5520 MHz; Duty Cycle: 1:1

Medium: HSL5800 Medium parameters used: $f = 5520$ MHz; $\sigma = 5.01$ mho/m; $\epsilon_r = 36.2$; $\rho = 1000$ kg/m³ ;

Liquid level: 151 mm

Phantom section: Right Section ; DUT test position : Tilt ; Modulation type: BPSK

Antenna type : PIFA Antenna ; Air temp. : 22.2 degrees ; Liquid temp. : 21.0 degrees

DASY4 Configuration:

- Probe: EX3DV3 - SN3506 ; ConvF(4.55, 4.55, 4.55) ; Calibrated: 2007/3/20

- Sensor-Surface: 3mm (Mechanical Surface Detection)

- Electronics: DAE3 Sn579; Calibrated: 2007/3/23

- Phantom: SAM 12; Type: SAM V4.0; Serial: TP 1202

- Measurement SW: DASY4, V4.7 Build 53; Postprocessing SW: SEMCAD, V1.8 Build 172

Tilt Position - Mid Channel 104/Area Scan (9x19x1): Measurement grid: dx=10mm, dy=10mm

Maximum value of SAR (measured) = 0.736 mW/g

Tilt Position - Mid Channel 104/Zoom Scan (8x8x8)/Cube 0: Measurement grid: dx=4.3mm,

dy=4.3mm, dz=3mm

Reference Value = 5.27 V/m

Peak SAR (extrapolated) = 2.26 W/kg

SAR(1 g) = 0.608 mW/g; SAR(10 g) = 0.236 mW/g

Maximum value of SAR (measured) = 0.801 mW/g

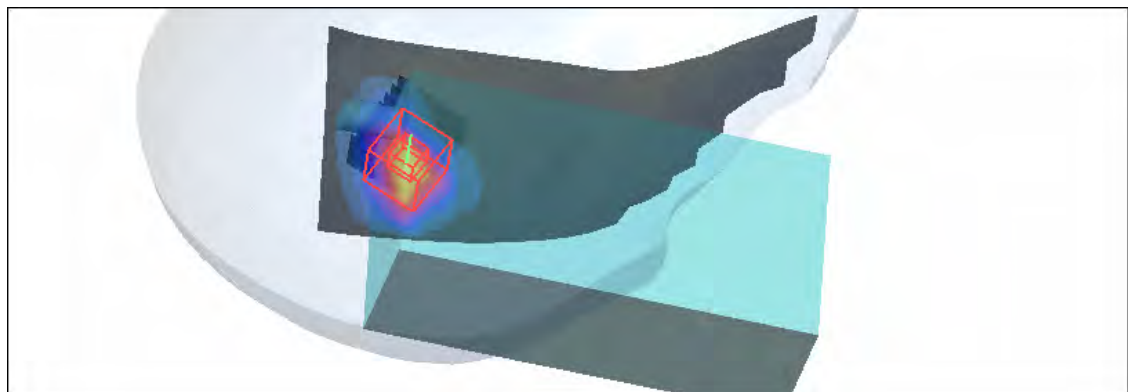
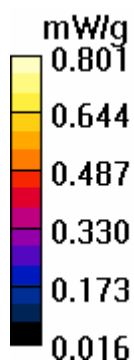

Test Laboratory: Advance Data Technology

M02-Right Head-Tilt-11a-Ch116

DUT: EDA ; Type: MC7598 ; Test Frequency: 5580 MHz

Communication System: 802.11a ; Frequency: 5580 MHz; Duty Cycle: 1:1

Medium: HSL5800 Medium parameters used: $f = 5580$ MHz; $\sigma = 5.09$ mho/m; $\epsilon_r = 36.1$; $\rho = 1000$ kg/m³ ;
Liquid level: 151 mm

Phantom section: Right Section ; DUT test position : Tilt ; Modulation type: BPSK

Antenna type : PIFA Antenna ; Air temp. : 22.2 degrees ; Liquid temp. : 21.0 degrees

DASY4 Configuration:

- Probe: EX3DV3 - SN3506 ; ConvF(4.55, 4.55, 4.55) ; Calibrated: 2007/3/20
- Sensor-Surface: 3mm (Mechanical Surface Detection)
- Electronics: DAE3 Sn579; Calibrated: 2007/3/23
- Phantom: SAM 12; Type: SAM V4.0; Serial: TP 1202
- Measurement SW: DASY4, V4.7 Build 53; Postprocessing SW: SEMCAD, V1.8 Build 172

Tilt Position - Mid Channel 116/Area Scan (9x19x1): Measurement grid: dx=10mm, dy=10mm
Maximum value of SAR (measured) = 0.636 mW/g

Tilt Position - Mid Channel 116/Zoom Scan (8x8x8)/Cube 0: Measurement grid: dx=4.3mm, dy=4.3mm, dz=3mm

Reference Value = 5.85 V/m

Peak SAR (extrapolated) = 1.90 W/kg

SAR(1 g) = 0.542 mW/g; SAR(10 g) = 0.205 mW/g

Maximum value of SAR (measured) = 0.752 mW/g

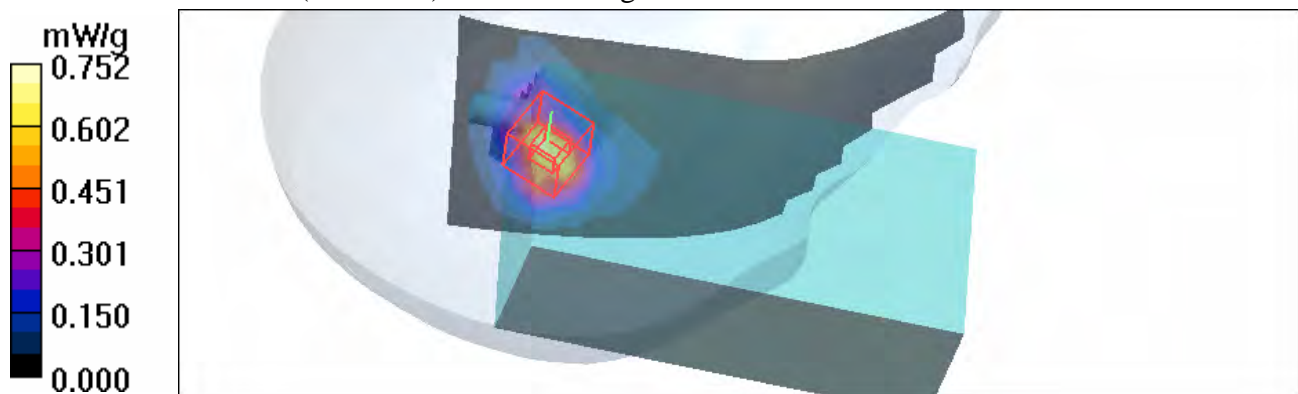

Test Laboratory: Advance Data Technology

M02-Right Head-Tilt-11a-Ch120

DUT: EDA ; Type: MC7598 ; Test Frequency: 5600 MHz

Communication System: 802.11a ; Frequency: 5600 MHz; Duty Cycle: 1:1

Medium: HSL5800 Medium parameters used: $f = 5600$ MHz; $\sigma = 5.11$ mho/m; $\epsilon_r = 36.1$; $\rho = 1000$ kg/m³ ;

Liquid level: 151 mm

Phantom section: Right Section ; DUT test position : Tilt ; Modulation type: BPSK

Antenna type : PIFA Antenna ; Air temp. : 22.2 degrees ; Liquid temp. : 21.0 degrees

DASY4 Configuration:

- Probe: EX3DV3 - SN3506 ; ConvF(4.55, 4.55, 4.55) ; Calibrated: 2007/3/20

- Sensor-Surface: 3mm (Mechanical Surface Detection)

- Electronics: DAE3 Sn579; Calibrated: 2007/3/23

- Phantom: SAM 12; Type: SAM V4.0; Serial: TP 1202

- Measurement SW: DASY4, V4.7 Build 53; Postprocessing SW: SEMCAD, V1.8 Build 172

Tilt Position - Mid Channel 120/Area Scan (9x19x1): Measurement grid: dx=10mm, dy=10mm

Maximum value of SAR (measured) = 0.584 mW/g

Tilt Position - Mid Channel 120/Zoom Scan (8x8x8)/Cube 0: Measurement grid: dx=4.3mm,

dy=4.3mm, dz=3mm

Reference Value = 5.42 V/m

Peak SAR (extrapolated) = 1.71 W/kg

SAR(1 g) = 0.475 mW/g; SAR(10 g) = 0.177 mW/g

Maximum value of SAR (measured) = 0.654 mW/g

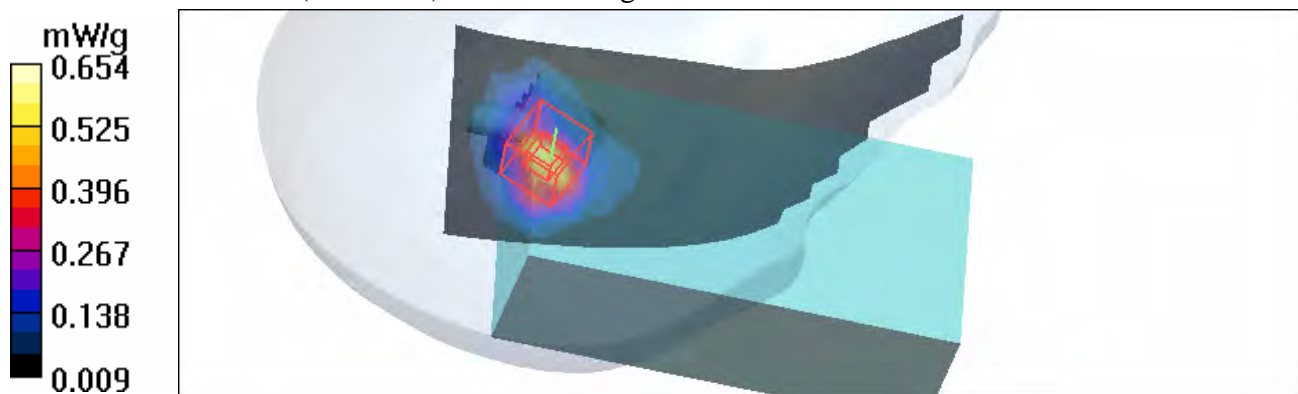

Test Laboratory: Advance Data Technology

M02-Right Head-Tilt-11a-Ch124

DUT: EDA ; Type: MC7598 ; Test Frequency: 5620 MHz

Communication System: 802.11a ; Frequency: 5620 MHz; Duty Cycle: 1:1

Medium: HSL5800 Medium parameters used: $f = 5620$ MHz; $\sigma = 5.14$ mho/m; $\epsilon_r = 36$; $\rho = 1000$ kg/m³ ;

Liquid level: 151 mm

Phantom section: Right Section ; DUT test position : Tilt ; Modulation type: BPSK

Antenna type : PIFA Antenna ; Air temp. : 22.2 degrees ; Liquid temp. : 21.0 degrees

DASY4 Configuration:

- Probe: EX3DV3 - SN3506 ; ConvF(4.55, 4.55, 4.55) ; Calibrated: 2007/3/20

- Sensor-Surface: 3mm (Mechanical Surface Detection)

- Electronics: DAE3 Sn579; Calibrated: 2007/3/23

- Phantom: SAM 12; Type: SAM V4.0; Serial: TP 1202

- Measurement SW: DASY4, V4.7 Build 53; Postprocessing SW: SEMCAD, V1.8 Build 172

Tilt Position - Mid Channel 124/Area Scan (9x19x1): Measurement grid: dx=10mm, dy=10mm

Maximum value of SAR (measured) = 0.607 mW/g

Tilt Position - Mid Channel 124/Zoom Scan (8x8x8)/Cube 0: Measurement grid: dx=4.3mm,

dy=4.3mm, dz=3mm

Reference Value = 6.2 V/m

Peak SAR (extrapolated) = 1.94 W/kg

SAR(1 g) = 0.515 mW/g; SAR(10 g) = 0.190 mW/g

Maximum value of SAR (measured) = 0.699 mW/g

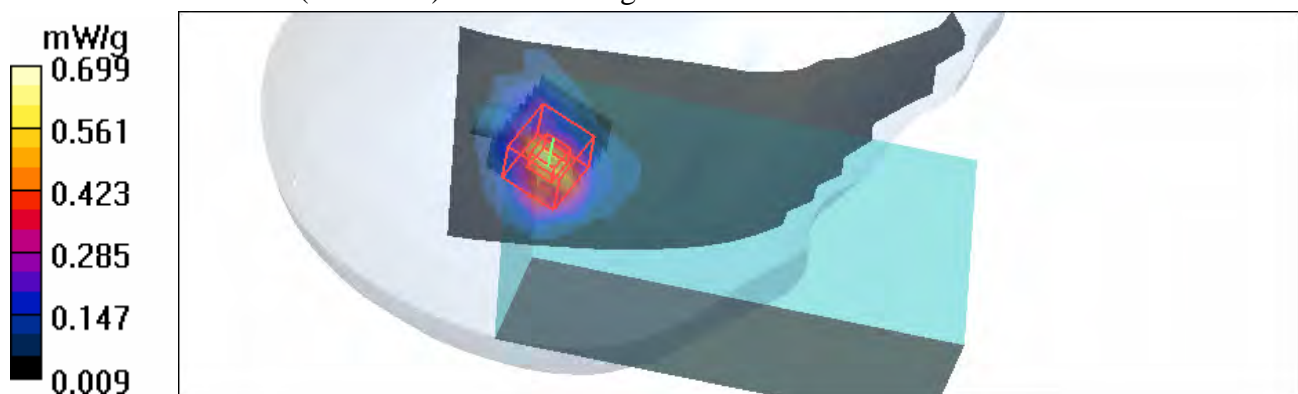

Test Laboratory: Advance Data Technology

M02-Right Head-Tilt-11a-Ch136

DUT: EDA ; Type: MC7598 ; Test Frequency: 5680 MHz

Communication System: 802.11a ; Frequency: 5680 MHz; Duty Cycle: 1:1

Medium: HSL5800 Medium parameters used: $f = 5680$ MHz; $\sigma = 5.21$ mho/m; $\epsilon_r = 35.9$; $\rho = 1000$ kg/m³ ;
Liquid level: 151 mm

Phantom section: Right Section ; DUT test position : Tilt ; Modulation type: BPSK

Antenna type : PIFA Antenna ; Air temp. : 22.2 degrees ; Liquid temp. : 21.0 degrees

DASY4 Configuration:

- Probe: EX3DV3 - SN3506 ; ConvF(4.4, 4.4, 4.4) ; Calibrated: 2007/3/20

- Sensor-Surface: 3mm (Mechanical Surface Detection)

- Electronics: DAE3 Sn579; Calibrated: 2007/3/23

- Phantom: SAM 12; Type: SAM V4.0; Serial: TP 1202

- Measurement SW: DASY4, V4.7 Build 53; Postprocessing SW: SEMCAD, V1.8 Build 172

Tilt Position - Mid Channel 136/Area Scan (9x19x1): Measurement grid: dx=10mm, dy=10mm

Maximum value of SAR (measured) = 0.876 mW/g

Tilt Position - Mid Channel 136/Zoom Scan (8x8x8)/Cube 0: Measurement grid: dx=4.3mm, dy=4.3mm, dz=3mm

Reference Value = 8.4 V/m

Peak SAR (extrapolated) = 2.68 W/kg

SAR(1 g) = **0.716** mW/g; SAR(10 g) = 0.269 mW/g

Maximum value of SAR (measured) = 0.974 mW/g

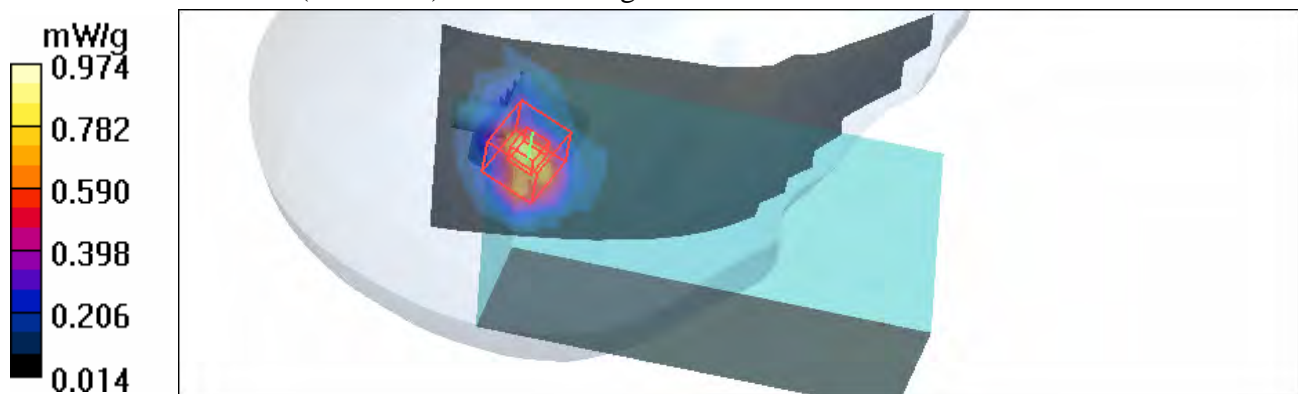

Test Laboratory: Advance Data Technology

M02-Right Head-Tilt-11a-Ch140

DUT: EDA ; Type: MC7598 ; Test Frequency: 5700 MHz

Communication System: 802.11a ; Frequency: 5700 MHz; Duty Cycle: 1:1

Medium: HSL5800 Medium parameters used: $f = 5700$ MHz; $\sigma = 5.23$ mho/m; $\epsilon_r = 35.9$; $\rho = 1000$ kg/m³ ;

Liquid level: 151 mm

Phantom section: Right Section ; DUT test position : Tilt ; Modulation type: BPSK

Antenna type : PIFA Antenna ; Air temp. : 22.2 degrees ; Liquid temp. : 21.0 degrees

DASY4 Configuration:

- Probe: EX3DV3 - SN3506 ; ConvF(4.4, 4.4, 4.4) ; Calibrated: 2007/3/20

- Sensor-Surface: 3mm (Mechanical Surface Detection)

- Electronics: DAE3 Sn579; Calibrated: 2007/3/23

- Phantom: SAM 12; Type: SAM V4.0; Serial: TP 1202

- Measurement SW: DASY4, V4.7 Build 53; Postprocessing SW: SEMCAD, V1.8 Build 172

Tilt Position - Mid Channel 140/Area Scan (9x19x1): Measurement grid: dx=10mm, dy=10mm

Maximum value of SAR (measured) = 0.223 mW/g

Tilt Position - Mid Channel 140/Zoom Scan (8x8x8)/Cube 0: Measurement grid: dx=4.3mm,

dy=4.3mm, dz=3mm

Reference Value = 3.92 V/m

Peak SAR (extrapolated) = 0.738 W/kg

SAR(1 g) = 0.187 mW/g; SAR(10 g) = 0.073 mW/g

Maximum value of SAR (measured) = 0.255 mW/g

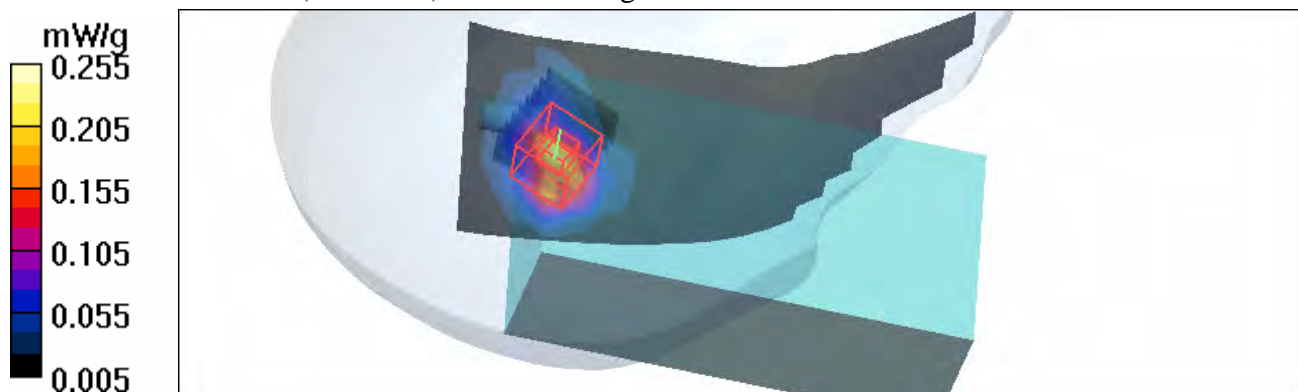

Test Laboratory: Advance Data Technology

M03-Left Head-Cheek-11a-Ch36

DUT: EDA ; Type: MC7598 ; Test Frequency: 5180 MHz

Communication System: 802.11a ; Frequency: 5180 MHz ; Duty Cycle: 1:1

Medium: HSL5800 Medium parameters used: $f = 5180$ MHz; $\sigma = 4.64$ mho/m; $\epsilon_r = 36.3$; $\rho = 1000$ kg/m³ ;

Liquid level: 151 mm

Phantom section: Left Section ; DUT test position : Cheek ; Modulation type: BPSK

Antenna type : PIFA Antenna ; Air temp. : 22.4 degrees ; Liquid temp. : 21.3 degrees

DASY4 Configuration:

- Probe: EX3DV3 - SN3506 ; ConvF(4.92, 4.92, 4.92) ; Calibrated: 2007/3/20

- Sensor-Surface: 3mm (Mechanical Surface Detection)

- Electronics: DAE3 Sn579; Calibrated: 2007/3/23

- Phantom: SAM 12; Type: SAM V4.0; Serial: TP 1202

- Measurement SW: DASY4, V4.7 Build 53; Postprocessing SW: SEMCAD, V1.8 Build 172

Touch Position - Low Channel 36/Area Scan (9x19x1): Measurement grid: dx=10mm, dy=10mm

Maximum value of SAR (measured) = 1.05 mW/g

Touch Position - Low Channel 36/Zoom Scan (8x8x8)/Cube 0: Measurement grid: dx=4.3mm, dy=4.3mm, dz=3mm

Reference Value = 10.5 V/m

Peak SAR (extrapolated) = 3.03 W/kg

SAR(1 g) = 0.955 mW/g; SAR(10 g) = 0.353 mW/g

Maximum value of SAR (measured) = 1.21 mW/g

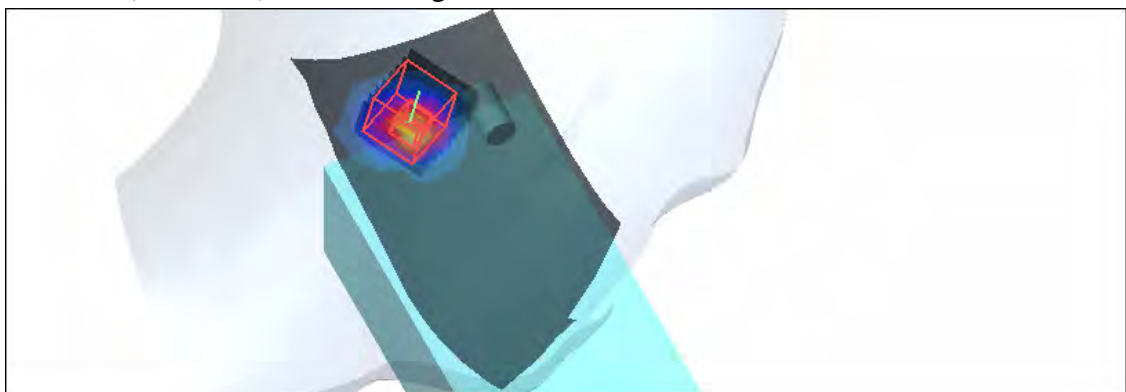
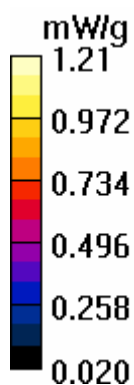

Test Laboratory: Advance Data Technology

M03-Left Head-Cheek-11a-Ch40

DUT: EDA ; Type: MC7598 ; Test Frequency: 5200 MHz

Communication System: 802.11a ; Frequency: 5200 MHz ; Duty Cycle: 1:1

Medium: HSL5800 Medium parameters used: $f = 5200$ MHz; $\sigma = 4.66$ mho/m; $\epsilon_r = 36.3$; $\rho = 1000$ kg/m³ ;

Liquid level: 151 mm

Phantom section: Left Section ; DUT test position : Cheek ; Modulation type: BPSK

Antenna type : PIFA Antenna ; Air temp. : 22.4 degrees ; Liquid temp. : 21.3 degrees

DASY4 Configuration:

- Probe: EX3DV3 - SN3506 ; ConvF(4.92, 4.92, 4.92) ; Calibrated: 2007/3/20

- Sensor-Surface: 3mm (Mechanical Surface Detection)

- Electronics: DAE3 Sn579; Calibrated: 2007/3/23

- Phantom: SAM 12; Type: SAM V4.0; Serial: TP 1202

- Measurement SW: DASY4, V4.7 Build 53; Postprocessing SW: SEMCAD, V1.8 Build 172

Touch Position - Mid Channel 40/Area Scan (9x19x1): Measurement grid: dx=10mm, dy=10mm

Maximum value of SAR (measured) = 0.95 mW/g

Touch Position - Mid Channel 40/Zoom Scan (8x8x8)/Cube 0: Measurement grid: dx=4.3mm, dy=4.3mm, dz=3mm

Reference Value = 9.82 V/m

Peak SAR (extrapolated) = 2.99 W/kg

SAR(1 g) = 0.937 mW/g; SAR(10 g) = 0.352 mW/g

Maximum value of SAR (measured) = 1.12 mW/g

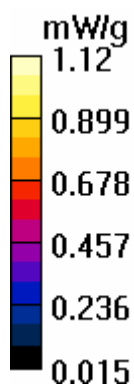

Test Laboratory: Advance Data Technology

M03-Left Head-Cheek-11a-Ch48

DUT: EDA ; Type: MC7598 ; Test Frequency: 5240 MHz

Communication System: 802.11a ; Frequency: 5240 MHz ; Duty Cycle: 1:1

Medium: HSL5800 Medium parameters used: $f = 5240$ MHz; $\sigma = 4.71$ mho/m; $\epsilon_r = 36.2$; $\rho = 1000$ kg/m³ ;

Liquid level: 151 mm

Phantom section: Left Section ; DUT test position : Cheek ; Modulation type: BPSK

Antenna type : PIFA Antenna ; Air temp. : 22.4 degrees ; Liquid temp. : 21.3 degrees

DASY4 Configuration:

- Probe: EX3DV3 - SN3506 ; ConvF(4.92, 4.92, 4.92) ; Calibrated: 2007/3/20

- Sensor-Surface: 3mm (Mechanical Surface Detection)

- Electronics: DAE3 Sn579; Calibrated: 2007/3/23

- Phantom: SAM 12; Type: SAM V4.0; Serial: TP 1202

- Measurement SW: DASY4, V4.7 Build 53; Postprocessing SW: SEMCAD, V1.8 Build 172

Touch Position - Mid Channel 48/Area Scan (9x19x1): Measurement grid: dx=10mm, dy=10mm

Maximum value of SAR (measured) = 0.96 mW/g

Touch Position - Mid Channel 48/Zoom Scan (8x8x8)/Cube 0: Measurement grid: dx=4.3mm, dy=4.3mm, dz=3mm

Reference Value = 9.77 V/m

Peak SAR (extrapolated) = 2.92 W/kg

SAR(1 g) = 0.908 mW/g; SAR(10 g) = 0.340 mW/g

Maximum value of SAR (measured) = 1.19 mW/g

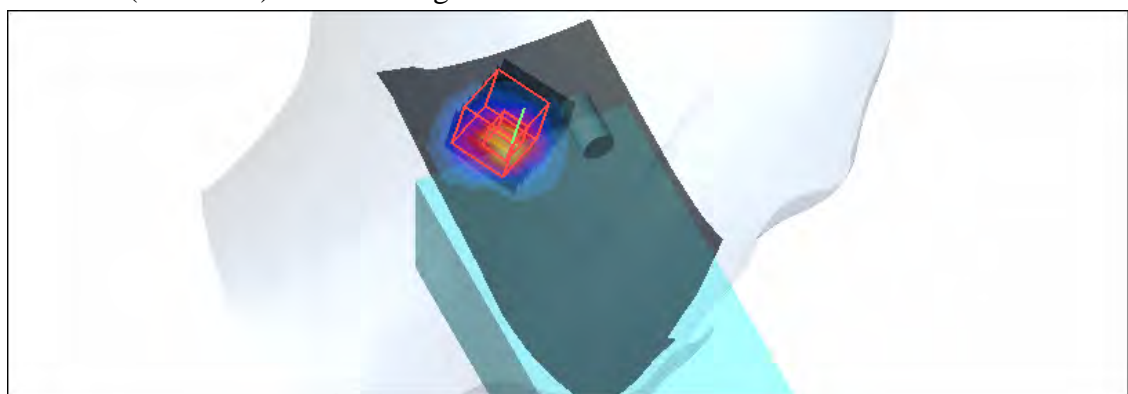
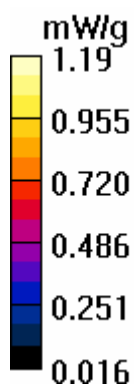

Test Laboratory: Advance Data Technology

M03-Left Head-Cheek-11a-Ch52

DUT: EDA ; Type: MC7598 ; Test Frequency: 5260 MHz

Communication System: 802.11a ; Frequency: 5260 MHz ; Duty Cycle: 1:1

Medium: HSL5800 Medium parameters used: $f = 5260$ MHz; $\sigma = 4.74$ mho/m; $\epsilon_r = 36.2$; $\rho = 1000$ kg/m³ ;

Liquid level: 151 mm

Phantom section: Left Section ; DUT test position : Cheek ; Modulation type: BPSK

Antenna type : PIFA Antenna ; Air temp. : 22.4 degrees ; Liquid temp. : 21.3 degrees

DASY4 Configuration:

- Probe: EX3DV3 - SN3506 ; ConvF(4.77, 4.77, 4.77) ; Calibrated: 2007/3/20

- Sensor-Surface: 3mm (Mechanical Surface Detection)

- Electronics: DAE3 Sn579; Calibrated: 2007/3/23

- Phantom: SAM 12; Type: SAM V4.0; Serial: TP 1202

- Measurement SW: DASY4, V4.7 Build 53; Postprocessing SW: SEMCAD, V1.8 Build 172

Touch Position - Mid Channel 52/Area Scan (9x19x1): Measurement grid: dx=10mm, dy=10mm

Maximum value of SAR (measured) = 0.991 mW/g

Touch Position - Mid Channel 52/Zoom Scan (8x8x8)/Cube 0: Measurement grid: dx=4.3mm, dy=4.3mm, dz=3mm

Reference Value = 9.17 V/m

Peak SAR (extrapolated) = 2.82 W/kg

SAR(1 g) = 0.832 mW/g; SAR(10 g) = 0.315 mW/g

Maximum value of SAR (measured) = 1.13 mW/g



Test Laboratory: Advance Data Technology

M03-Left Head-Cheek-11a-Ch60

DUT: EDA ; Type: MC7598 ; Test Frequency: 5300 MHz

Communication System: 802.11a ; Frequency: 5300 MHz ; Duty Cycle: 1:1

Medium: HSL5800 Medium parameters used: $f = 5300$ MHz; $\sigma = 4.77$ mho/m; $\epsilon_r = 36.1$; $\rho = 1000$ kg/m³ ;

Liquid level: 151 mm

Phantom section: Left Section ; DUT test position : Cheek ; Modulation type: BPSK

Antenna type : PIFA Antenna ; Air temp. : 22.4 degrees ; Liquid temp. : 21.3 degrees

DASY4 Configuration:

- Probe: EX3DV3 - SN3506 ; ConvF(4.77, 4.77, 4.77) ; Calibrated: 2007/3/20

- Sensor-Surface: 3mm (Mechanical Surface Detection)

- Electronics: DAE3 Sn579; Calibrated: 2007/3/23

- Phantom: SAM 12; Type: SAM V4.0; Serial: TP 1202

- Measurement SW: DASY4, V4.7 Build 53; Postprocessing SW: SEMCAD, V1.8 Build 172

Touch Position - Mid Channel 60/Area Scan (9x19x1): Measurement grid: dx=10mm, dy=10mm

Maximum value of SAR (measured) = 0.842 mW/g

Touch Position - Mid Channel 60/Zoom Scan (8x8x8)/Cube 0: Measurement grid: dx=4.3mm, dy=4.3mm, dz=3mm

Reference Value = 9.56 V/m

Peak SAR (extrapolated) = 2.54 W/kg

SAR(1 g) = 0.778 mW/g; SAR(10 g) = 0.302 mW/g

Maximum value of SAR (measured) = 0.98 mW/g

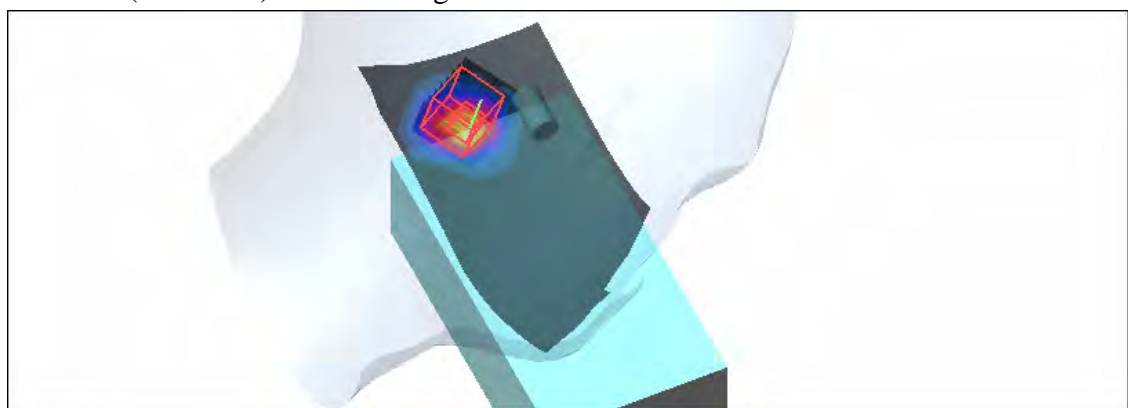
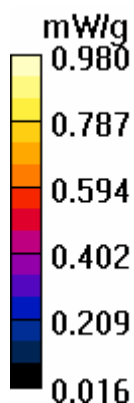

Test Laboratory: Advance Data Technology

M03-Left Head-Cheek-11a-Ch64

DUT: EDA ; Type: MC7598 ; Test Frequency: 5320 MHz

Communication System: 802.11a ; Frequency: 5320 MHz ; Duty Cycle: 1:1

Medium: HSL5800 Medium parameters used: $f = 5320$ MHz; $\sigma = 4.81$ mho/m; $\epsilon_r = 36.1$; $\rho = 1000$ kg/m³ ;

Liquid level: 151 mm

Phantom section: Left Section ; DUT test position : Cheek ; Modulation type: BPSK

Antenna type : PIFA Antenna ; Air temp. : 22.4 degrees ; Liquid temp. : 21.3 degrees

DASY4 Configuration:

- Probe: EX3DV3 - SN3506 ; ConvF(4.77, 4.77, 4.77) ; Calibrated: 2007/3/20

- Sensor-Surface: 3mm (Mechanical Surface Detection)

- Electronics: DAE3 Sn579; Calibrated: 2007/3/23

- Phantom: SAM 12; Type: SAM V4.0; Serial: TP 1202

- Measurement SW: DASY4, V4.7 Build 53; Postprocessing SW: SEMCAD, V1.8 Build 172

Touch Position - Mid Channel 64/Area Scan (9x19x1): Measurement grid: dx=10mm, dy=10mm

Maximum value of SAR (measured) = 0.851 mW/g

Touch Position - Mid Channel 64/Zoom Scan (8x8x8)/Cube 0: Measurement grid: dx=4.3mm, dy=4.3mm, dz=3mm

Reference Value = 9.82 V/m

Peak SAR (extrapolated) = 2.58 W/kg

SAR(1 g) = 0.783 mW/g; SAR(10 g) = 0.307 mW/g

Maximum value of SAR (measured) = 0.930 mW/g

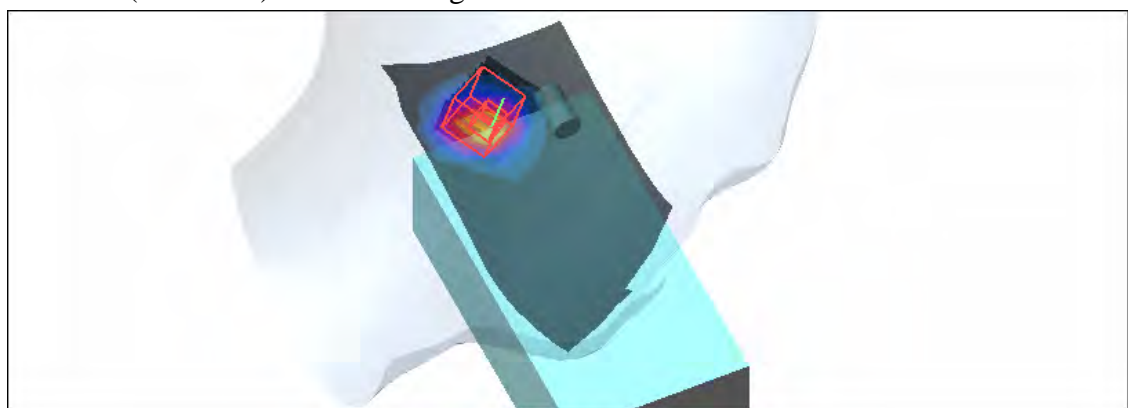
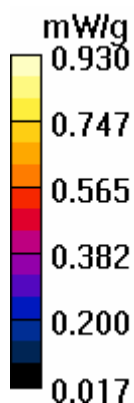

Test Laboratory: Advance Data Technology

M03-Left Head-Cheek-11a-Ch100

DUT: EDA ; Type: MC7598 ; Test Frequency: 5500 MHz

Communication System: 802.11a ; Frequency: 5500 MHz ; Duty Cycle: 1:1

Medium: HSL5800 Medium parameters used: $f = 5500$ MHz; $\sigma = 5.02$ mho/m; $\epsilon_r = 35.8$; $\rho = 1000$ kg/m³ ;

Liquid level: 151 mm

Phantom section: Left Section ; DUT test position : Cheek ; Modulation type: BPSK

Antenna type : PIFA Antenna ; Air temp. : 22.4 degrees ; Liquid temp. : 21.3 degrees

DASY4 Configuration:

- Probe: EX3DV3 - SN3506 ; ConvF(4.55, 4.55, 4.55) ; Calibrated: 2007/3/20

- Sensor-Surface: 3mm (Mechanical Surface Detection)

- Electronics: DAE3 Sn579; Calibrated: 2007/3/23

- Phantom: SAM 12; Type: SAM V4.0; Serial: TP 1202

- Measurement SW: DASY4, V4.7 Build 53; Postprocessing SW: SEMCAD, V1.8 Build 172

Touch Position - Mid Channel 100/Area Scan (9x19x1): Measurement grid: dx=10mm, dy=10mm

Maximum value of SAR (measured) = 0.415 mW/g

Touch Position - Mid Channel 100/Zoom Scan (8x8x8)/Cube 0: Measurement grid:

dx=4.3mm, dy=4.3mm, dz=3mm

Reference Value = 3.61 V/m

Peak SAR (extrapolated) = 1.17 W/kg

SAR(1 g) = 0.370 mW/g; SAR(10 g) = 0.163 mW/g

Maximum value of SAR (measured) = 0.499 mW/g

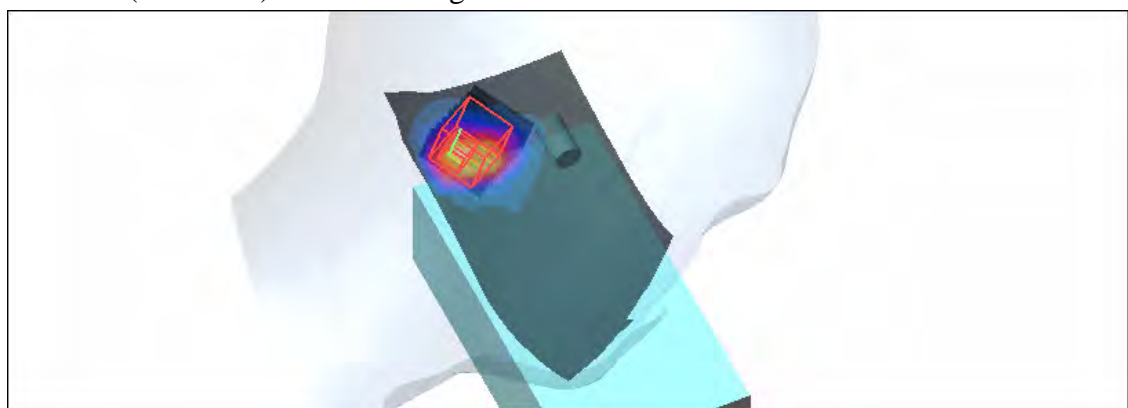
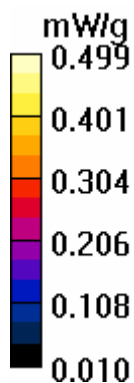

Test Laboratory: Advance Data Technology

M03-Left Head-Cheek-11a-Ch104

DUT: EDA ; Type: MC7598 ; Test Frequency: 5520 MHz

Communication System: 802.11a ; Frequency: 5520 MHz ; Duty Cycle: 1:1

Medium: HSL5800 Medium parameters used: $f = 5520$ MHz; $\sigma = 5.04$ mho/m; $\epsilon_r = 35.8$; $\rho = 1000$ kg/m³ ;

Liquid level: 151 mm

Phantom section: Left Section ; DUT test position : Cheek ; Modulation type: BPSK

Antenna type : PIFA Antenna ; Air temp. : 22.4 degrees ; Liquid temp. : 21.3 degrees

DASY4 Configuration:

- Probe: EX3DV3 - SN3506 ; ConvF(4.55, 4.55, 4.55) ; Calibrated: 2007/3/20

- Sensor-Surface: 3mm (Mechanical Surface Detection)

- Electronics: DAE3 Sn579; Calibrated: 2007/3/23

- Phantom: SAM 12; Type: SAM V4.0; Serial: TP 1202

- Measurement SW: DASY4, V4.7 Build 53; Postprocessing SW: SEMCAD, V1.8 Build 172

Touch Position - Mid Channel 104/Area Scan (9x19x1): Measurement grid: dx=10mm, dy=10mm

Maximum value of SAR (measured) = 0.685 mW/g

Touch Position - Mid Channel 104/Zoom Scan (8x8x8)/Cube 0: Measurement grid:

dx=4.3mm, dy=4.3mm, dz=3mm

Reference Value = 6.40 V/m

Peak SAR (extrapolated) = 1.90 W/kg

SAR(1 g) = 0.564 mW/g; SAR(10 g) = 0.240 mW/g

Maximum value of SAR (measured) = 0.723 mW/g

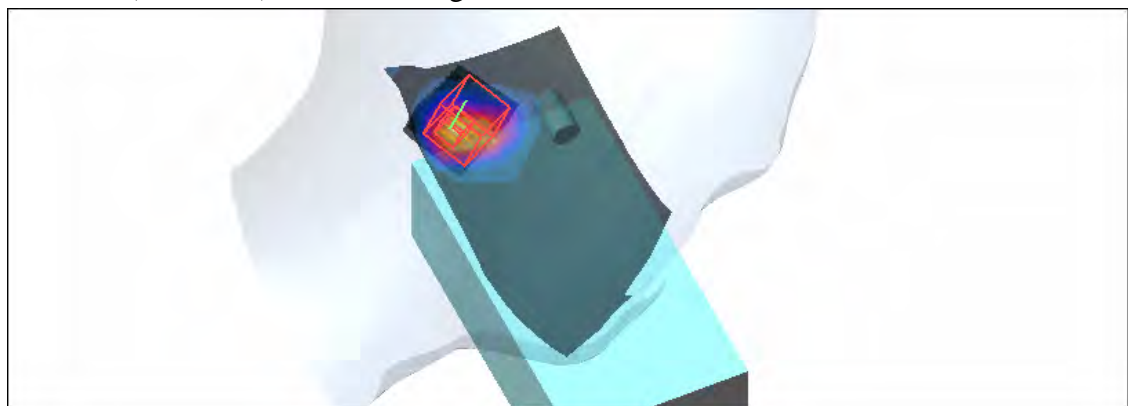
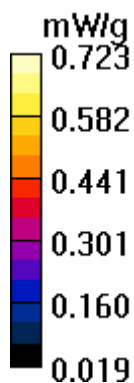

Test Laboratory: Advance Data Technology

M03-Left Head-Cheek-11a-Ch116

DUT: EDA ; Type: MC7598 ; Test Frequency: 5580 MHz

Communication System: 802.11a ; Frequency: 5580 MHz ; Duty Cycle: 1:1

Medium: HSL5800 Medium parameters used: $f = 5580$ MHz; $\sigma = 5.12$ mho/m; $\epsilon_r = 35.6$; $\rho = 1000$ kg/m³ ;

Liquid level: 151 mm

Phantom section: Left Section ; DUT test position : Cheek ; Modulation type: BPSK

Antenna type : PIFA Antenna ; Air temp. : 22.4 degrees ; Liquid temp. : 21.3 degrees

DASY4 Configuration:

- Probe: EX3DV3 - SN3506 ; ConvF(4.55, 4.55, 4.55) ; Calibrated: 2007/3/20

- Sensor-Surface: 3mm (Mechanical Surface Detection)

- Electronics: DAE3 Sn579; Calibrated: 2007/3/23

- Phantom: SAM 12; Type: SAM V4.0; Serial: TP 1202

- Measurement SW: DASY4, V4.7 Build 53; Postprocessing SW: SEMCAD, V1.8 Build 172

Touch Position - Mid Channel 116/Area Scan (9x19x1): Measurement grid: dx=10mm, dy=10mm

Maximum value of SAR (measured) = 0.660 mW/g

Touch Position - Mid Channel 116/Zoom Scan (8x8x8)/Cube 0: Measurement grid:

dx=4.3mm, dy=4.3mm, dz=3mm

Reference Value = 6.21 V/m

Peak SAR (extrapolated) = 1.94 W/kg

SAR(1 g) = 0.544 mW/g; SAR(10 g) = 0.241 mW/g

Maximum value of SAR (measured) = 0.750 mW/g

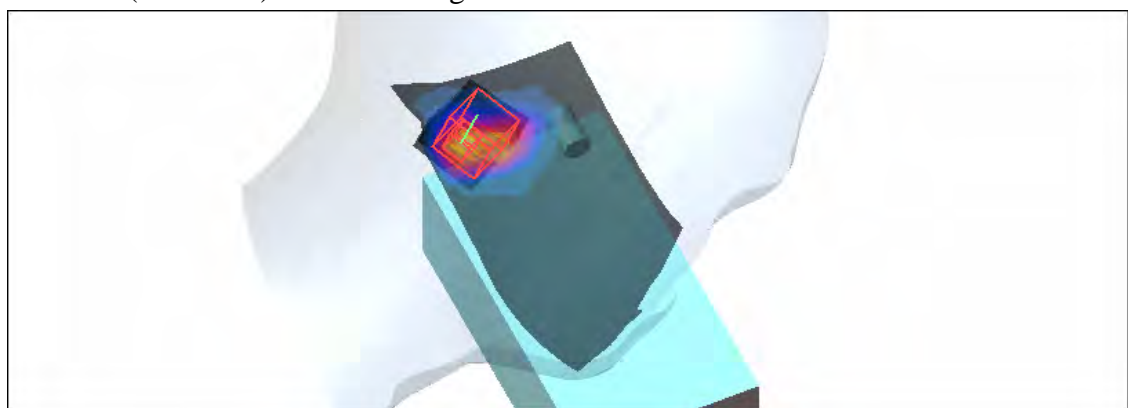
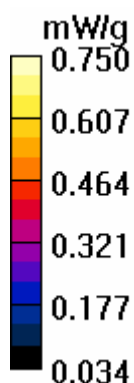

Test Laboratory: Advance Data Technology

M03-Left Head-Cheek-11a-Ch120

DUT: EDA ; Type: MC7598 ; Test Frequency: 5600 MHz

Communication System: 802.11a ; Frequency: 5600 MHz ; Duty Cycle: 1:1

Medium: HSL5800 Medium parameters used: $f = 5600$ MHz; $\sigma = 5.15$ mho/m; $\epsilon_r = 35.6$; $\rho = 1000$ kg/m³ ;

Liquid level: 151 mm

Phantom section: Left Section ; DUT test position : Cheek ; Modulation type: BPSK

Antenna type : PIFA Antenna ; Air temp. : 22.4 degrees ; Liquid temp. : 21.3 degrees

DASY4 Configuration:

- Probe: EX3DV3 - SN3506 ; ConvF(4.55, 4.55, 4.55) ; Calibrated: 2007/3/20

- Sensor-Surface: 3mm (Mechanical Surface Detection)

- Electronics: DAE3 Sn579; Calibrated: 2007/3/23

- Phantom: SAM 12; Type: SAM V4.0; Serial: TP 1202

- Measurement SW: DASY4, V4.7 Build 53; Postprocessing SW: SEMCAD, V1.8 Build 172

Touch Position - Low Channel 120/Area Scan (9x19x1): Measurement grid: dx=10mm, dy=10mm

Maximum value of SAR (measured) = 0.509 mW/g

Touch Position - Low Channel 120/Zoom Scan (8x8x8)/Cube 0: Measurement grid:

dx=4.3mm, dy=4.3mm, dz=3mm

Reference Value = 7.16 V/m

Peak SAR (extrapolated) = 1.54 W/kg

SAR(1 g) = 0.423 mW/g; SAR(10 g) = 0.188 mW/g

Maximum value of SAR (measured) = 0.591 mW/g

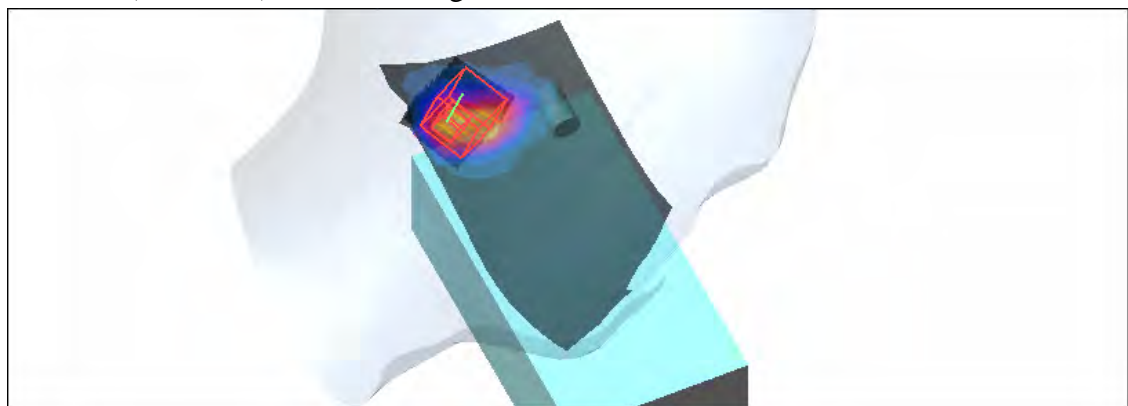
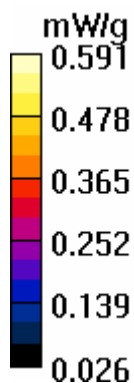

Test Laboratory: Advance Data Technology

M03-Left Head-Cheek-11a-Ch124

DUT: EDA ; Type: MC7598 ; Test Frequency: 5620 MHz

Communication System: 802.11a ; Frequency: 5620 MHz ; Duty Cycle: 1:1

Medium: HSL5800 Medium parameters used: $f = 5620$ MHz; $\sigma = 5.17$ mho/m; $\epsilon_r = 35.6$; $\rho = 1000$ kg/m³ ;

Liquid level: 151 mm

Phantom section: Left Section ; DUT test position : Cheek ; Modulation type: BPSK

Antenna type : PIFA Antenna ; Air temp. : 22.4 degrees ; Liquid temp. : 21.3 degrees

DASY4 Configuration:

- Probe: EX3DV3 - SN3506 ; ConvF(4.55, 4.55, 4.55) ; Calibrated: 2007/3/20

- Sensor-Surface: 3mm (Mechanical Surface Detection)

- Electronics: DAE3 Sn579; Calibrated: 2007/3/23

- Phantom: SAM 12; Type: SAM V4.0; Serial: TP 1202

- Measurement SW: DASY4, V4.7 Build 53; Postprocessing SW: SEMCAD, V1.8 Build 172

Touch Position - Mid Channel 124/Area Scan (9x19x1): Measurement grid: dx=10mm, dy=10mm

Maximum value of SAR (measured) = 0.641 mW/g

Touch Position - Mid Channel 124/Zoom Scan (8x8x8)/Cube 0: Measurement grid:

dx=4.3mm, dy=4.3mm, dz=3mm

Reference Value = 7.19 V/m

Peak SAR (extrapolated) = 2.42 W/kg

SAR(1 g) = 0.577 mW/g; SAR(10 g) = 0.256 mW/g

Maximum value of SAR (measured) = 0.767 mW/g

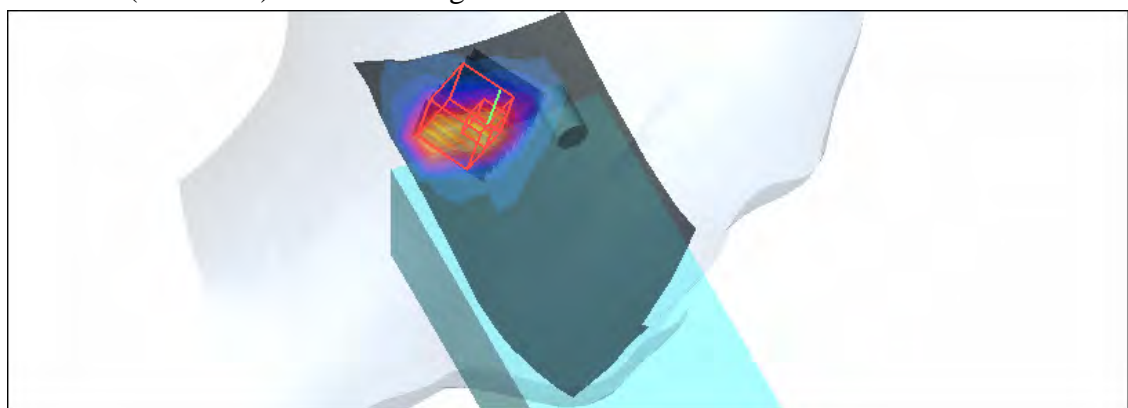
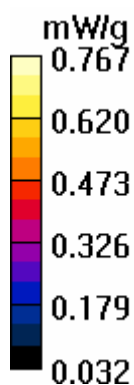

Test Laboratory: Advance Data Technology

M03-Left Head-Cheek-11a-Ch136

DUT: EDA ; Type: MC7598 ; Test Frequency: 5680 MHz

Communication System: 802.11a ; Frequency: 5680 MHz ; Duty Cycle: 1:1

Medium: HSL5800 Medium parameters used: $f = 5680$ MHz; $\sigma = 5.24$ mho/m; $\epsilon_r = 35.5$; $\rho = 1000$ kg/m³ ;

Liquid level: 151 mm

Phantom section: Left Section ; DUT test position : Cheek ; Modulation type: BPSK

Antenna type : PIFA Antenna ; Air temp. : 22.4 degrees ; Liquid temp. : 21.3 degrees

DASY4 Configuration:

- Probe: EX3DV3 - SN3506 ; ConvF(4.4, 4.4, 4.4) ; Calibrated: 2007/3/20

- Sensor-Surface: 3mm (Mechanical Surface Detection)

- Electronics: DAE3 Sn579; Calibrated: 2007/3/23

- Phantom: SAM 12; Type: SAM V4.0; Serial: TP 1202

- Measurement SW: DASY4, V4.7 Build 53; Postprocessing SW: SEMCAD, V1.8 Build 172

Touch Position - Mid Channel 136/Area Scan (9x19x1): Measurement grid: dx=10mm, dy=10mm

Maximum value of SAR (measured) = 0.796 mW/g

Touch Position - Mid Channel 136/Zoom Scan (8x8x8)/Cube 0: Measurement grid:

dx=4.3mm, dy=4.3mm, dz=3mm

Reference Value = 9.15 V/m

Peak SAR (extrapolated) = 2.86 W/kg

SAR(1 g) = 0.738 mW/g; SAR(10 g) = 0.290 mW/g

Maximum value of SAR (measured) = 1.02 mW/g

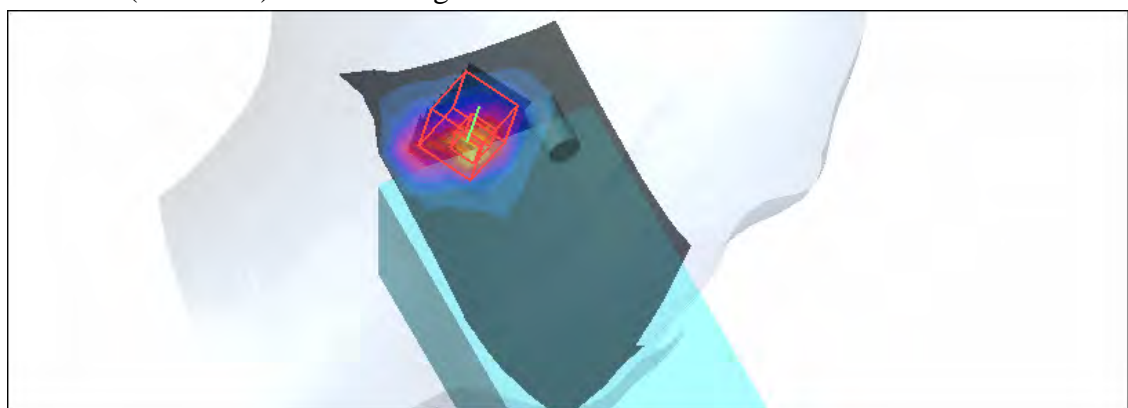
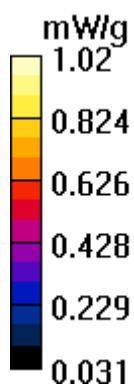

Test Laboratory: Advance Data Technology

M03-Left Head-Cheek-11a-Ch140

DUT: EDA ; Type: MC7598 ; Test Frequency: 5700 MHz

Communication System: 802.11a ; Frequency: 5700 MHz ; Duty Cycle: 1:1

Medium: HSL5800 Medium parameters used: $f = 5700$ MHz; $\sigma = 5.27$ mho/m; $\epsilon_r = 35.4$; $\rho = 1000$ kg/m³ ;

Liquid level: 151 mm

Phantom section: Left Section ; DUT test position : Cheek ; Modulation type: BPSK

Antenna type : PIFA Antenna ; Air temp. : 22.4 degrees ; Liquid temp. : 21.3 degrees

DASY4 Configuration:

- Probe: EX3DV3 - SN3506 ; ConvF(4.4, 4.4, 4.4) ; Calibrated: 2007/3/20

- Sensor-Surface: 3mm (Mechanical Surface Detection)

- Electronics: DAE3 Sn579; Calibrated: 2007/3/23

- Phantom: SAM 12; Type: SAM V4.0; Serial: TP 1202

- Measurement SW: DASY4, V4.7 Build 53; Postprocessing SW: SEMCAD, V1.8 Build 172

Touch Position - Mid Channel 140/Area Scan (9x19x1): Measurement grid: dx=10mm, dy=10mm

Maximum value of SAR (measured) = 0.214 mW/g

Touch Position - Mid Channel 140/Zoom Scan (8x8x8)/Cube 0: Measurement grid:

dx=4.3mm, dy=4.3mm, dz=3mm

Reference Value = 3.19 V/m

Peak SAR (extrapolated) = 0.967 W/kg

SAR(1 g) = 0.216 mW/g; SAR(10 g) = 0.098 mW/g

Maximum value of SAR (measured) = 0.293 mW/g

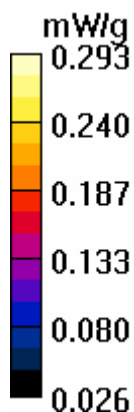

Test Laboratory: Advance Data Technology

M04-Left Head-Tilt-11a-Ch36

DUT: EDA ; Type: MC7598 ; Test Frequency: 5180 MHz

Communication System: 802.11a ; Frequency: 5180 MHz; Duty Cycle: 1:1

Medium: HSL5800 Medium parameters used: $f = 5180$ MHz; $\sigma = 4.64$ mho/m; $\epsilon_r = 36.3$; $\rho = 1000$ kg/m³ ;

Liquid level: 151 mm

Phantom section: Left Section ; DUT test position : Tilt ; Modulation type: BPSK

Antenna type : PIFA Antenna ; Air temp. : 22.4 degrees ; Liquid temp. : 21.3 degrees

DASY4 Configuration:

- Probe: EX3DV3 - SN3506 ; ConvF(4.92, 4.92, 4.92) ; Calibrated: 2007/3/20

- Sensor-Surface: 3mm (Mechanical Surface Detection)

- Electronics: DAE3 Sn579; Calibrated: 2007/3/23

- Phantom: SAM 12; Type: SAM V4.0; Serial: TP 1202

- Measurement SW: DASY4, V4.7 Build 53; Postprocessing SW: SEMCAD, V1.8 Build 172

Tilt Position - Low Channel 36/Area Scan (9x19x1): Measurement grid: dx=10mm, dy=10mm

Maximum value of SAR (measured) = 1.06 mW/g

Tilt Position - Low Channel 36/Zoom Scan (8x8x8)/Cube 0: Measurement grid: dx=4.3mm,

dy=4.3mm, dz=3mm

Reference Value = 10.2 V/m

Peak SAR (extrapolated) = 3.06 W/kg

SAR(1 g) = 0.963 mW/g; SAR(10 g) = 0.365 mW/g

Maximum value of SAR (measured) = 1.14 mW/g

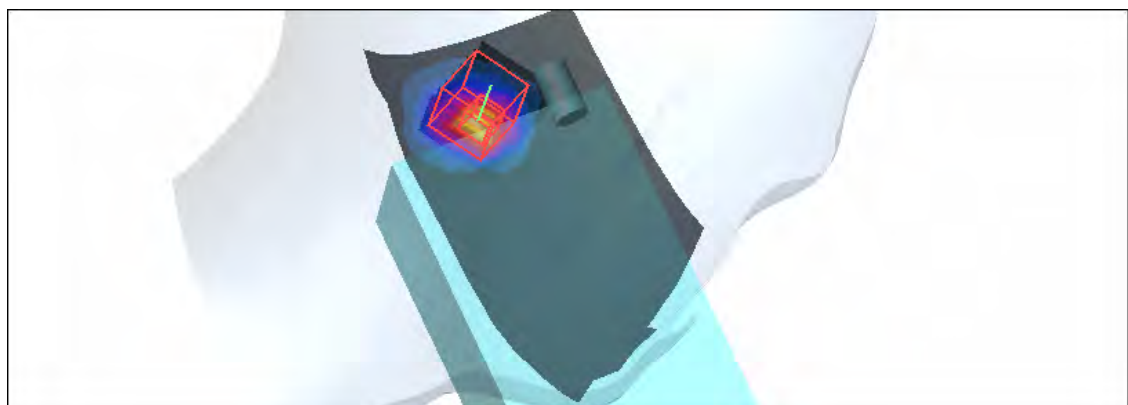
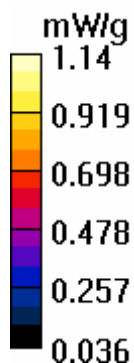

Test Laboratory: Advance Data Technology

M04-Left Head-Tilt-11a-Ch40

DUT: EDA ; Type: MC7598 ; Test Frequency: 5200 MHz

Communication System: 802.11a ; Frequency: 5200 MHz; Duty Cycle: 1:1

Medium: HSL5800 Medium parameters used: $f = 5200$ MHz; $\sigma = 4.66$ mho/m; $\epsilon_r = 36.3$; $\rho = 1000$ kg/m³ ;

Liquid level: 151 mm

Phantom section: Left Section ; DUT test position : Tilt ; Modulation type: BPSK

Antenna type : PIFA Antenna ; Air temp. : 22.4 degrees ; Liquid temp. : 21.3 degrees

DASY4 Configuration:

- Probe: EX3DV3 - SN3506 ; ConvF(4.92, 4.92, 4.92) ; Calibrated: 2007/3/20

- Sensor-Surface: 3mm (Mechanical Surface Detection)

- Electronics: DAE3 Sn579; Calibrated: 2007/3/23

- Phantom: SAM 12; Type: SAM V4.0; Serial: TP 1202

- Measurement SW: DASY4, V4.7 Build 53; Postprocessing SW: SEMCAD, V1.8 Build 172

Tilt Position - Mid Channel 40/Area Scan (9x19x1): Measurement grid: dx=10mm, dy=10mm

Maximum value of SAR (measured) = 1.25 mW/g

Tilt Position - Mid Channel 40/Zoom Scan (8x8x8)/Cube 0: Measurement grid: dx=4.3mm,

dy=4.3mm, dz=3mm

Reference Value = 10.2 V/m

Peak SAR (extrapolated) = 3.33 W/kg

SAR(1 g) = 0.984 mW/g; SAR(10 g) = 0.371 mW/g

Maximum value of SAR (measured) = 1.37 mW/g

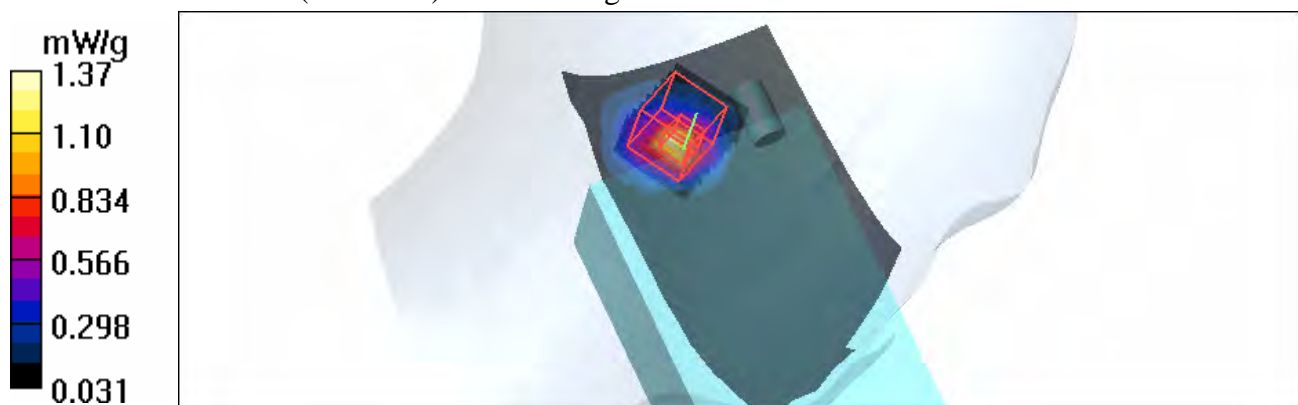

Test Laboratory: Advance Data Technology

M04-Left Head-Tilt-11a-Ch48

DUT: EDA ; Type: MC7598 ; Test Frequency: 5240 MHz

Communication System: 802.11a ; Frequency: 5240 MHz; Duty Cycle: 1:1

Medium: HSL5800 Medium parameters used: $f = 5240$ MHz; $\sigma = 4.71$ mho/m; $\epsilon_r = 36.2$; $\rho = 1000$ kg/m³ ;

Liquid level: 151 mm

Phantom section: Left Section ; DUT test position : Tilt ; Modulation type: BPSK

Antenna type : PIFA Antenna ; Air temp. : 22.4 degrees ; Liquid temp. : 21.3 degrees

DASY4 Configuration:

- Probe: EX3DV3 - SN3506 ; ConvF(4.92, 4.92, 4.92) ; Calibrated: 2007/3/20

- Sensor-Surface: 3mm (Mechanical Surface Detection)

- Electronics: DAE3 Sn579; Calibrated: 2007/3/23

- Phantom: SAM 12; Type: SAM V4.0; Serial: TP 1202

- Measurement SW: DASY4, V4.7 Build 53; Postprocessing SW: SEMCAD, V1.8 Build 172

Tilt Position - Mid Channel 48/Area Scan (9x19x1): Measurement grid: dx=10mm, dy=10mm

Maximum value of SAR (measured) = 0.968 mW/g

Tilt Position - Mid Channel 48/Zoom Scan (8x8x8)/Cube 0: Measurement grid: dx=4.3mm,

dy=4.3mm, dz=3mm

Reference Value = 9.61 V/m

Peak SAR (extrapolated) = 2.80 W/kg

SAR(1 g) = 0.820 mW/g; SAR(10 g) = 0.317 mW/g

Maximum value of SAR (measured) = 1.15 mW/g

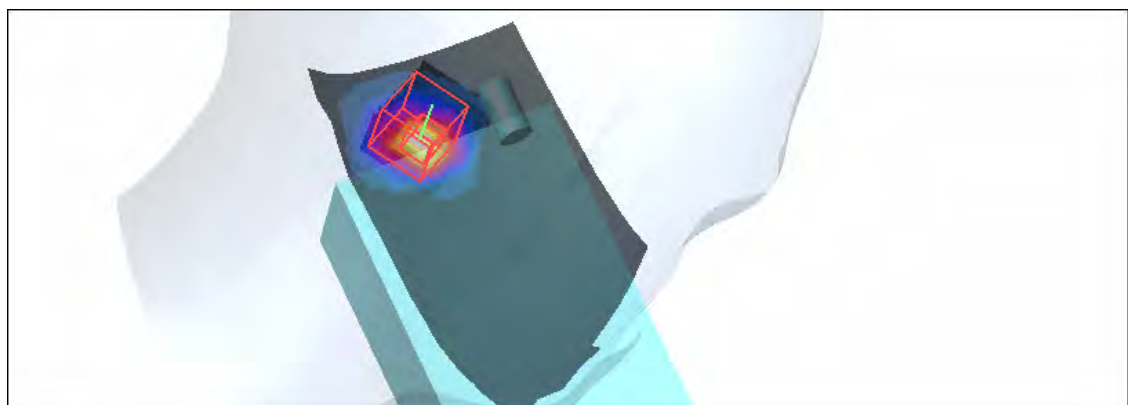
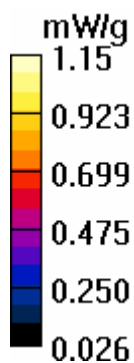

Test Laboratory: Advance Data Technology

M04-Left Head-Tilt-11a-Ch52

DUT: EDA ; Type: MC7598 ; Test Frequency: 5260 MHz

Communication System: 802.11a ; Frequency: 5260 MHz; Duty Cycle: 1:1

Medium: HSL5800 Medium parameters used: $f = 5260$ MHz; $\sigma = 4.74$ mho/m; $\epsilon_r = 36.2$; $\rho = 1000$ kg/m³ ;

Liquid level: 151 mm

Phantom section: Left Section ; DUT test position : Tilt ; Modulation type: BPSK

Antenna type : PIFA Antenna ; Air temp. : 22.4 degrees ; Liquid temp. : 21.3 degrees

DASY4 Configuration:

- Probe: EX3DV3 - SN3506 ; ConvF(4.77, 4.77, 4.77) ; Calibrated: 2007/3/20

- Sensor-Surface: 3mm (Mechanical Surface Detection)

- Electronics: DAE3 Sn579; Calibrated: 2007/3/23

- Phantom: SAM 12; Type: SAM V4.0; Serial: TP 1202

- Measurement SW: DASY4, V4.7 Build 53; Postprocessing SW: SEMCAD, V1.8 Build 172

Tilt Position - Mid Channel 52/Area Scan (9x19x1): Measurement grid: dx=10mm, dy=10mm

Maximum value of SAR (measured) = 0.959 mW/g

Tilt Position - Mid Channel 52/Zoom Scan (8x8x8)/Cube 0: Measurement grid: dx=4.3mm,

dy=4.3mm, dz=3mm

Reference Value = 9.15 V/m

Peak SAR (extrapolated) = 2.71 W/kg

SAR(1 g) = 0.811 mW/g; SAR(10 g) = 0.317 mW/g

Maximum value of SAR (measured) = 1.16 mW/g

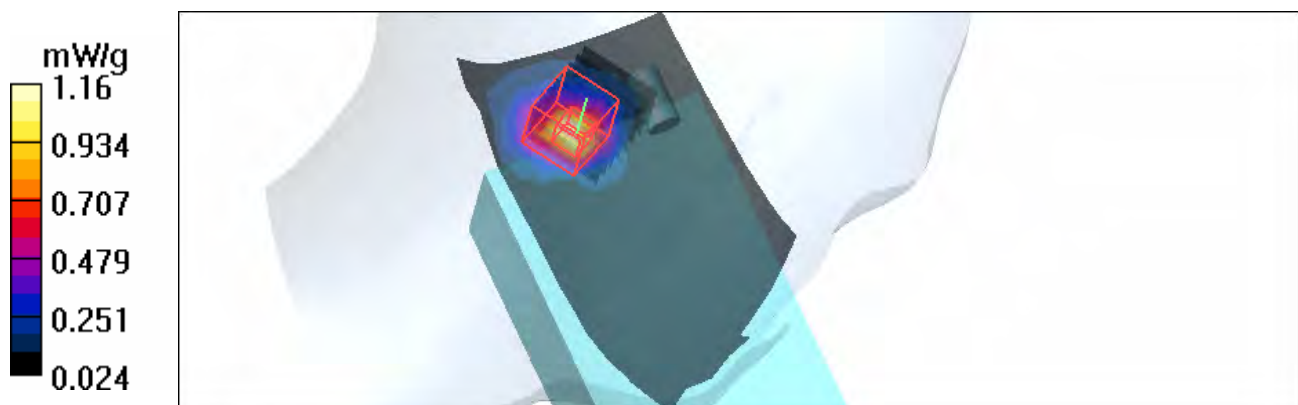

Test Laboratory: Advance Data Technology

M04-Left Head-Tilt-11a-Ch60

DUT: EDA ; Type: MC7598 ; Test Frequency: 5300 MHz

Communication System: 802.11a ; Frequency: 5300 MHz; Duty Cycle: 1:1

Medium: HSL5800 Medium parameters used: $f = 5300$ MHz; $\sigma = 4.77$ mho/m; $\epsilon_r = 36.1$; $\rho = 1000$ kg/m³ ;

Liquid level: 151 mm

Phantom section: Left Section ; DUT test position : Tilt ; Modulation type: BPSK

Antenna type : PIFA Antenna ; Air temp. : 22.4 degrees ; Liquid temp. : 21.3 degrees

DASY4 Configuration:

- Probe: EX3DV3 - SN3506 ; ConvF(4.77, 4.77, 4.77) ; Calibrated: 2007/3/20

- Sensor-Surface: 3mm (Mechanical Surface Detection)

- Electronics: DAE3 Sn579; Calibrated: 2007/3/23

- Phantom: SAM 12; Type: SAM V4.0; Serial: TP 1202

- Measurement SW: DASY4, V4.7 Build 53; Postprocessing SW: SEMCAD, V1.8 Build 172

Tilt Position - Mid Channel 60/Area Scan (9x19x1): Measurement grid: dx=10mm, dy=10mm

Maximum value of SAR (measured) = 0.905 mW/g

Tilt Position - Mid Channel 60/Zoom Scan (8x8x8)/Cube 0: Measurement grid: dx=4.3mm,

dy=4.3mm, dz=3mm

Reference Value = 8.78 V/m

Peak SAR (extrapolated) = 2.61 W/kg

SAR(1 g) = 0.789 mW/g; SAR(10 g) = 0.316 mW/g

Maximum value of SAR (measured) = 1.11 mW/g

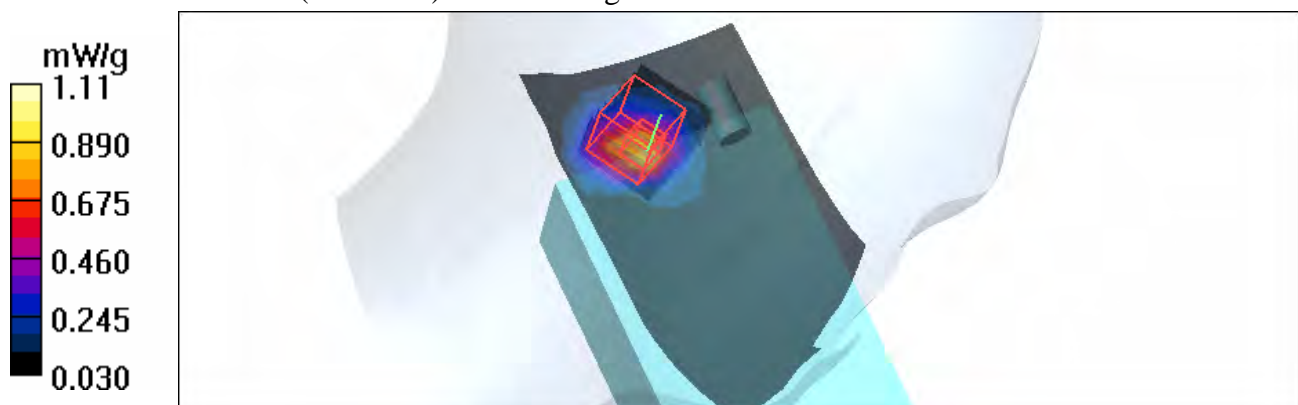

Test Laboratory: Advance Data Technology

M04-Left Head-Tilt-11a-Ch64

DUT: EDA ; Type: MC7598 ; Test Frequency: 5320 MHz

Communication System: 802.11a ; Frequency: 5320 MHz; Duty Cycle: 1:1

Medium: HSL5800 Medium parameters used: $f = 5320$ MHz; $\sigma = 4.81$ mho/m; $\epsilon_r = 36.1$; $\rho = 1000$ kg/m³ ;

Liquid level: 151 mm

Phantom section: Left Section ; DUT test position : Tilt ; Modulation type: BPSK

Antenna type : PIFA Antenna ; Air temp. : 22.4 degrees ; Liquid temp. : 21.3 degrees

DASY4 Configuration:

- Probe: EX3DV3 - SN3506 ; ConvF(4.77, 4.77, 4.77) ; Calibrated: 2007/3/20

- Sensor-Surface: 3mm (Mechanical Surface Detection)

- Electronics: DAE3 Sn579; Calibrated: 2007/3/23

- Phantom: SAM 12; Type: SAM V4.0; Serial: TP 1202

- Measurement SW: DASY4, V4.7 Build 53; Postprocessing SW: SEMCAD, V1.8 Build 172

Tilt Position - Mid Channel 64/Area Scan (9x19x1): Measurement grid: dx=10mm, dy=10mm

Maximum value of SAR (measured) = 0.849 mW/g

Tilt Position - Mid Channel 64/Zoom Scan (8x8x8)/Cube 0: Measurement grid: dx=4.3mm,

dy=4.3mm, dz=3mm

Reference Value = 8.19 V/m

Peak SAR (extrapolated) = 2.34 W/kg

SAR(1 g) = 0.739 mW/g; SAR(10 g) = 0.306 mW/g

Maximum value of SAR (measured) = 0.990 mW/g

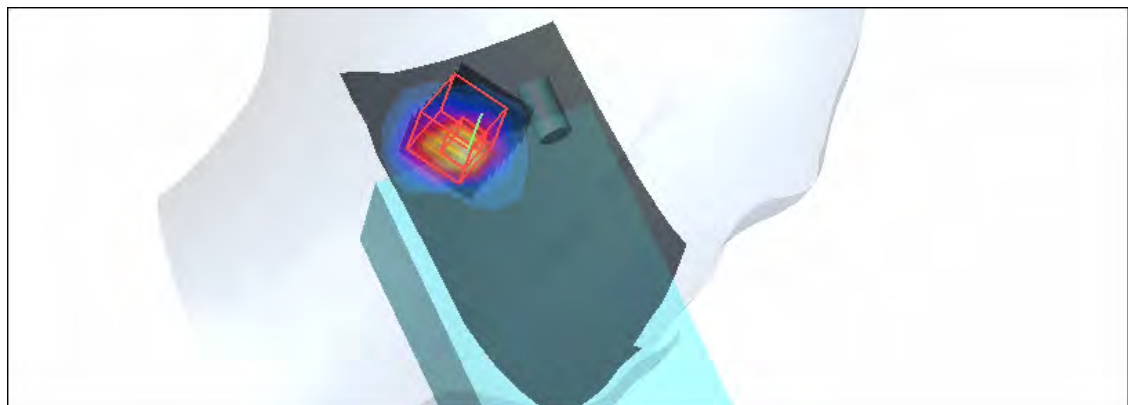
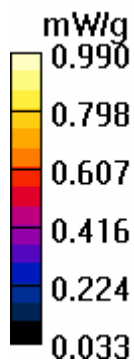

Test Laboratory: Advance Data Technology

M04-Left Head-Tilt-11a-Ch100

DUT: EDA ; Type: MC7598 ; Test Frequency: 5500 MHz

Communication System: 802.11a ; Frequency: 5500 MHz; Duty Cycle: 1:1

Medium: HSL5800 Medium parameters used: $f = 5500$ MHz; $\sigma = 5.02$ mho/m; $\epsilon_r = 35.8$; $\rho = 1000$ kg/m³ ;

Liquid level: 151 mm

Phantom section: Left Section ; DUT test position : Tilt ; Modulation type: BPSK

Antenna type : PIFA Antenna ; Air temp. : 22.4 degrees ; Liquid temp. : 21.3 degrees

DASY4 Configuration:

- Probe: EX3DV3 - SN3506 ; ConvF(4.55, 4.55, 4.55) ; Calibrated: 2007/3/20

- Sensor-Surface: 3mm (Mechanical Surface Detection)

- Electronics: DAE3 Sn579; Calibrated: 2007/3/23

- Phantom: SAM 12; Type: SAM V4.0; Serial: TP 1202

- Measurement SW: DASY4, V4.7 Build 53; Postprocessing SW: SEMCAD, V1.8 Build 172

Tilt Position - Mid Channel 100/Area Scan (9x19x1): Measurement grid: dx=10mm, dy=10mm

Maximum value of SAR (measured) = 0.467 mW/g

Tilt Position - Mid Channel 100/Zoom Scan (8x8x8)/Cube 0: Measurement grid: dx=4.3mm,

dy=4.3mm, dz=3mm

Reference Value = 3.95 V/m

Peak SAR (extrapolated) = 1.24 W/kg

SAR(1 g) = 0.369 mW/g; SAR(10 g) = 0.172 mW/g

Maximum value of SAR (measured) = 0.508 mW/g

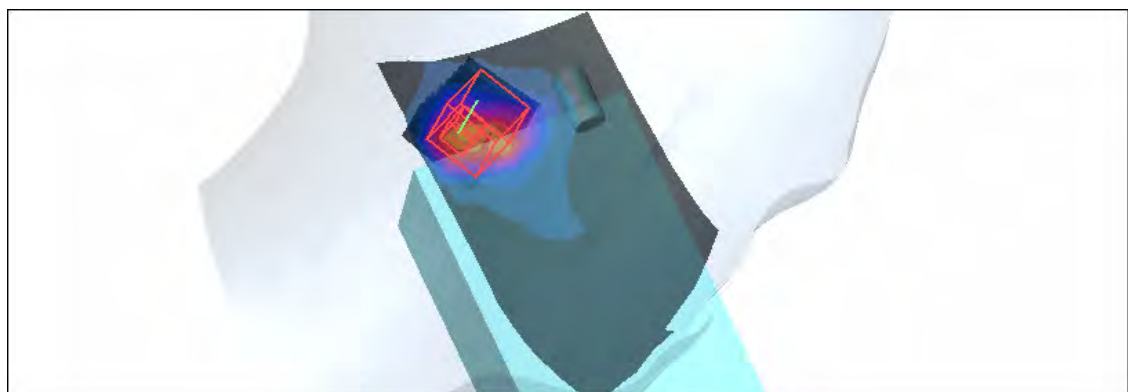
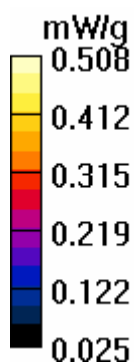

Test Laboratory: Advance Data Technology

M04-Left Head-Tilt-11a-Ch104

DUT: EDA ; Type: MC7598 ; Test Frequency: 5520 MHz

Communication System: 802.11a ; Frequency: 5520 MHz; Duty Cycle: 1:1

Medium: HSL5800 Medium parameters used: $f = 5520$ MHz; $\sigma = 5.04$ mho/m; $\epsilon_r = 35.8$; $\rho = 1000$ kg/m³ ;

Liquid level: 151 mm

Phantom section: Left Section ; DUT test position : Tilt ; Modulation type: BPSK

Antenna type : PIFA Antenna ; Air temp. : 22.4 degrees ; Liquid temp. : 21.3 degrees

DASY4 Configuration:

- Probe: EX3DV3 - SN3506 ; ConvF(4.55, 4.55, 4.55) ; Calibrated: 2007/3/20

- Sensor-Surface: 3mm (Mechanical Surface Detection)

- Electronics: DAE3 Sn579; Calibrated: 2007/3/23

- Phantom: SAM 12; Type: SAM V4.0; Serial: TP 1202

- Measurement SW: DASY4, V4.7 Build 53; Postprocessing SW: SEMCAD, V1.8 Build 172

Tilt Position - Mid Channel 104/Area Scan (9x19x1): Measurement grid: dx=10mm, dy=10mm

Maximum value of SAR (measured) = 0.666 mW/g

Tilt Position - Mid Channel 104/Zoom Scan (8x8x8)/Cube 0: Measurement grid: dx=4.3mm,

dy=4.3mm, dz=3mm

Reference Value = 6.37 V/m

Peak SAR (extrapolated) = 1.98 W/kg

SAR(1 g) = 0.561 mW/g; SAR(10 g) = 0.248 mW/g

Maximum value of SAR (measured) = 0.765 mW/g

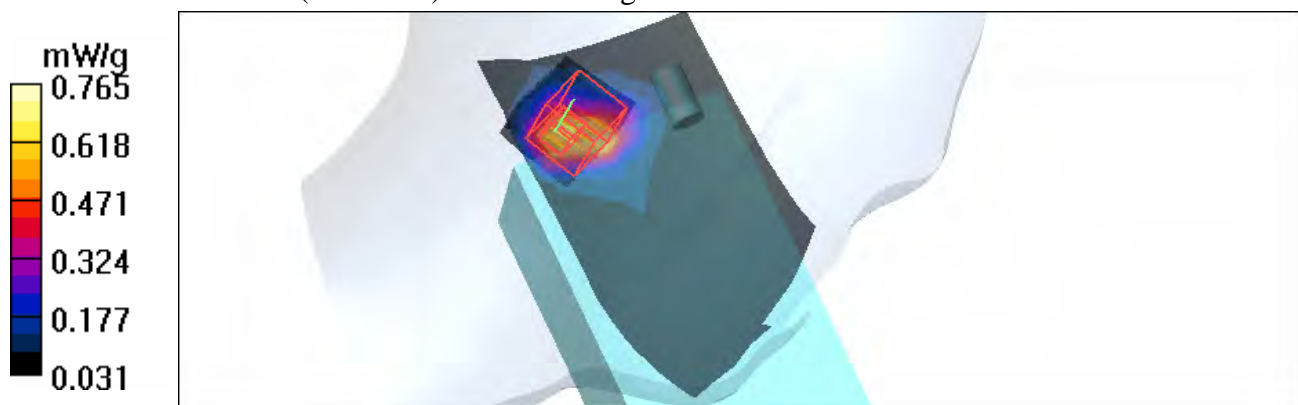

Test Laboratory: Advance Data Technology

M04-Left Head-Tilt-11a-Ch116

DUT: EDA ; Type: MC7598 ; Test Frequency: 5580 MHz

Communication System: 802.11a ; Frequency: 5580 MHz; Duty Cycle: 1:1

Medium: HSL5800 Medium parameters used: $f = 5580$ MHz; $\sigma = 5.12$ mho/m; $\epsilon_r = 35.6$; $\rho = 1000$ kg/m³ ;

Liquid level: 151 mm

Phantom section: Left Section ; DUT test position : Tilt ; Modulation type: BPSK

Antenna type : PIFA Antenna ; Air temp. : 22.4 degrees ; Liquid temp. : 21.3 degrees

DASY4 Configuration:

- Probe: EX3DV3 - SN3506 ; ConvF(4.55, 4.55, 4.55) ; Calibrated: 2007/3/20

- Sensor-Surface: 3mm (Mechanical Surface Detection)

- Electronics: DAE3 Sn579; Calibrated: 2007/3/23

- Phantom: SAM 12; Type: SAM V4.0; Serial: TP 1202

- Measurement SW: DASY4, V4.7 Build 53; Postprocessing SW: SEMCAD, V1.8 Build 172

Tilt Position - Mid Channel 116/Area Scan (9x19x1): Measurement grid: dx=10mm, dy=10mm

Maximum value of SAR (measured) = 0.726 mW/g

Tilt Position - Mid Channel 116/Zoom Scan (8x8x8)/Cube 0: Measurement grid: dx=4.3mm,

dy=4.3mm, dz=3mm

Reference Value = 5.29 V/m

Peak SAR (extrapolated) = 1.97 W/kg

SAR(1 g) = 0.590 mW/g; SAR(10 g) = 0.248 mW/g

Maximum value of SAR (measured) = 0.833 mW/g

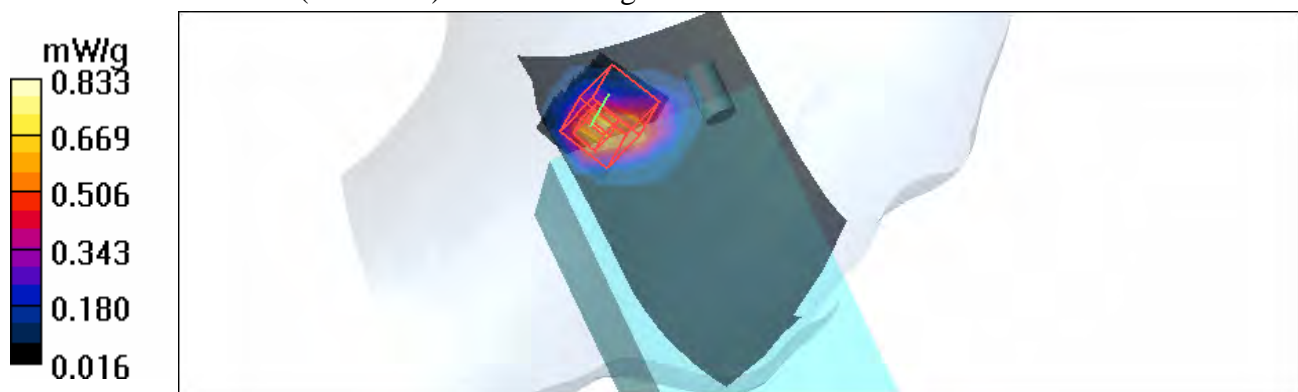

Test Laboratory: Advance Data Technology

M04-Left Head-Tilt-11a-Ch120

DUT: EDA ; Type: MC7598 ; Test Frequency: 5600 MHz

Communication System: 802.11a ; Frequency: 5600 MHz; Duty Cycle: 1:1

Medium: HSL5800 Medium parameters used: $f = 5600$ MHz; $\sigma = 5.15$ mho/m; $\epsilon_r = 35.6$; $\rho = 1000$ kg/m³ ;

Liquid level: 151 mm

Phantom section: Left Section ; DUT test position : Tilt ; Modulation type: BPSK

Antenna type : PIFA Antenna ; Air temp. : 22.4 degrees ; Liquid temp. : 21.3 degrees

DASY4 Configuration:

- Probe: EX3DV3 - SN3506 ; ConvF(4.55, 4.55, 4.55) ; Calibrated: 2007/3/20

- Sensor-Surface: 3mm (Mechanical Surface Detection)

- Electronics: DAE3 Sn579; Calibrated: 2007/3/23

- Phantom: SAM 12; Type: SAM V4.0; Serial: TP 1202

- Measurement SW: DASY4, V4.7 Build 53; Postprocessing SW: SEMCAD, V1.8 Build 172

Tilt Position - Mid Channel 120/Area Scan (9x19x1): Measurement grid: dx=10mm, dy=10mm

Maximum value of SAR (measured) = 0.671 mW/g

Tilt Position - Mid Channel 120/Zoom Scan (8x8x8)/Cube 0: Measurement grid: dx=4.3mm,

dy=4.3mm, dz=3mm

Reference Value = 5.72 V/m

Peak SAR (extrapolated) = 1.82 W/kg

SAR(1 g) = 0.520 mW/g; SAR(10 g) = 0.217 mW/g

Maximum value of SAR (measured) = 0.783 mW/g

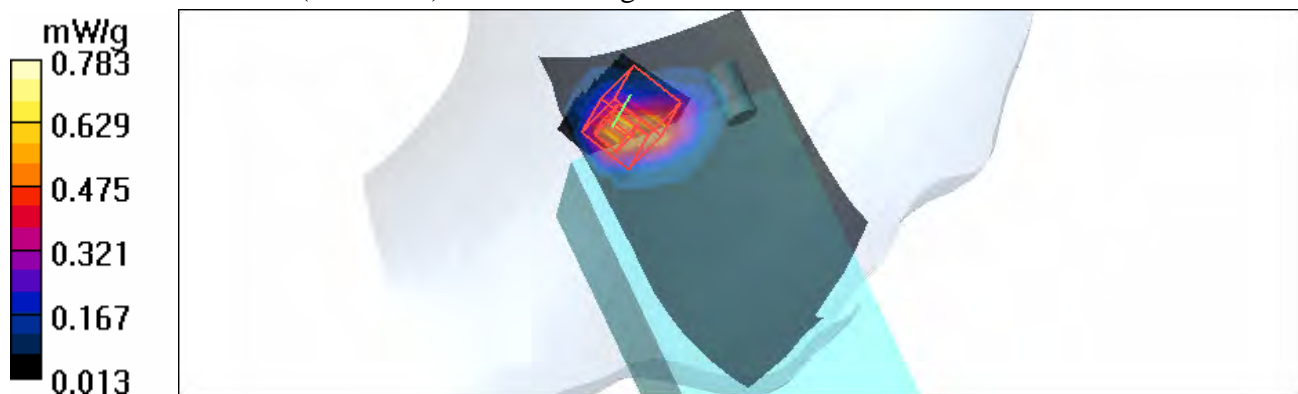

Test Laboratory: Advance Data Technology

M04-Left Head-Tilt-11a-Ch124

DUT: EDA ; Type: MC7598 ; Test Frequency: 5620 MHz

Communication System: 802.11a ; Frequency: 5620 MHz; Duty Cycle: 1:1

Medium: HSL5800 Medium parameters used: $f = 5620$ MHz; $\sigma = 5.17$ mho/m; $\epsilon_r = 35.6$; $\rho = 1000$ kg/m³ ;

Liquid level: 151 mm

Phantom section: Left Section ; DUT test position : Tilt ; Modulation type: BPSK

Antenna type : PIFA Antenna ; Air temp. : 22.4 degrees ; Liquid temp. : 21.3 degrees

DASY4 Configuration:

- Probe: EX3DV3 - SN3506 ; ConvF(4.55, 4.55, 4.55) ; Calibrated: 2007/3/20

- Sensor-Surface: 3mm (Mechanical Surface Detection)

- Electronics: DAE3 Sn579; Calibrated: 2007/3/23

- Phantom: SAM 12; Type: SAM V4.0; Serial: TP 1202

- Measurement SW: DASY4, V4.7 Build 53; Postprocessing SW: SEMCAD, V1.8 Build 172

Tilt Position - Mid Channel 124/Area Scan (9x19x1): Measurement grid: dx=10mm, dy=10mm

Maximum value of SAR (measured) = 0.607 mW/g

Tilt Position - Mid Channel 124/Zoom Scan (8x8x8)/Cube 0: Measurement grid: dx=4.3mm,

dy=4.3mm, dz=3mm

Reference Value = 6.2 V/m

Peak SAR (extrapolated) = 1.94 W/kg

SAR(1 g) = 0.515 mW/g; SAR(10 g) = 0.190 mW/g

Maximum value of SAR (measured) = 0.699 mW/g

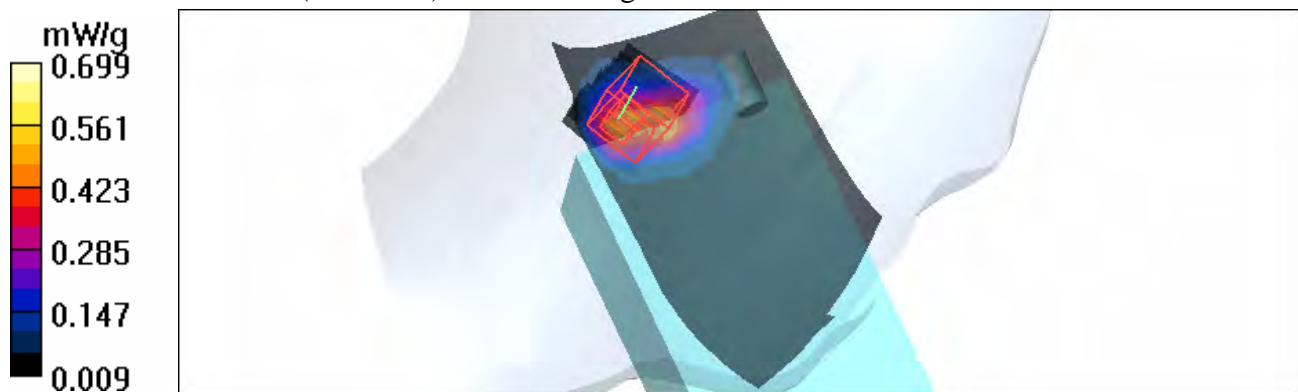

Test Laboratory: Advance Data Technology

M04-Left Head-Tilt-11a-Ch136

DUT: EDA ; Type: MC7598 ; Test Frequency: 5680 MHz

Communication System: 802.11a ; Frequency: 5680 MHz; Duty Cycle: 1:1

Medium: HSL5800 Medium parameters used: $f = 5680$ MHz; $\sigma = 5.24$ mho/m; $\epsilon_r = 35.5$; $\rho = 1000$ kg/m³ ;

Liquid level: 151 mm

Phantom section: Left Section ; DUT test position : Tilt ; Modulation type: BPSK

Antenna type : PIFA Antenna ; Air temp. : 22.4 degrees ; Liquid temp. : 21.3 degrees

DASY4 Configuration:

- Probe: EX3DV3 - SN3506 ; ConvF(4.4, 4.4, 4.4) ; Calibrated: 2007/3/20

- Sensor-Surface: 3mm (Mechanical Surface Detection)

- Electronics: DAE3 Sn579; Calibrated: 2007/3/23

- Phantom: SAM 12; Type: SAM V4.0; Serial: TP 1202

- Measurement SW: DASY4, V4.7 Build 53; Postprocessing SW: SEMCAD, V1.8 Build 172

Tilt Position - Mid Channel 136/Area Scan (9x19x1): Measurement grid: dx=10mm, dy=10mm

Maximum value of SAR (measured) = 0.876 mW/g

Tilt Position - Mid Channel 136/Zoom Scan (8x8x8)/Cube 0: Measurement grid: dx=4.3mm,

dy=4.3mm, dz=3mm

Reference Value = 8.4 V/m

Peak SAR (extrapolated) = 2.68 W/kg

SAR(1 g) = 0.716 mW/g; SAR(10 g) = 0.269 mW/g

Maximum value of SAR (measured) = 0.974 mW/g

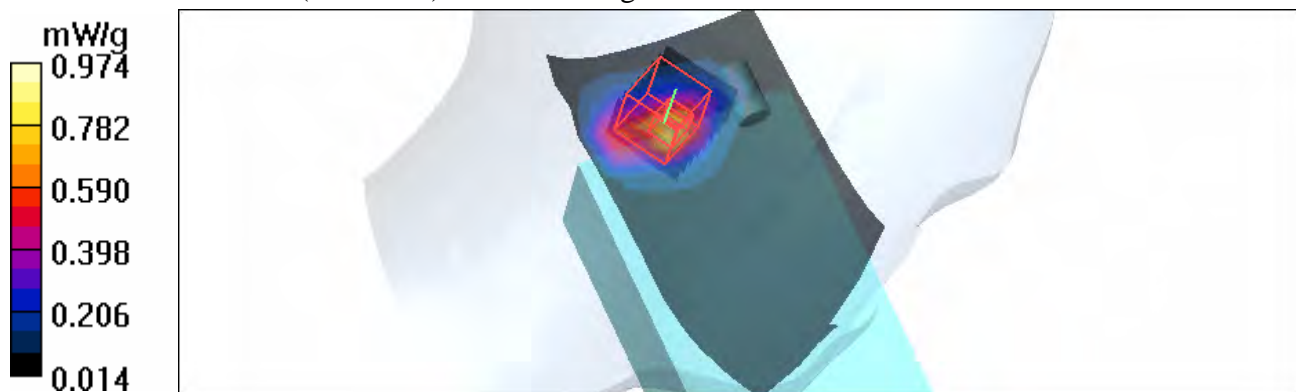

Test Laboratory: Advance Data Technology

M04-Left Head-Tilt-11a-Ch140

DUT: EDA ; Type: MC7598 ; Test Frequency: 5700 MHz

Communication System: 802.11a ; Frequency: 5700 MHz; Duty Cycle: 1:1

Medium: HSL5800 Medium parameters used: $f = 5700$ MHz; $\sigma = 5.27$ mho/m; $\epsilon_r = 35.4$; $\rho = 1000$ kg/m³ ;

Liquid level: 151 mm

Phantom section: Left Section ; DUT test position : Tilt ; Modulation type: BPSK

Antenna type : PIFA Antenna ; Air temp. : 22.4 degrees ; Liquid temp. : 21.3 degrees

DASY4 Configuration:

- Probe: EX3DV3 - SN3506 ; ConvF(4.4, 4.4, 4.4) ; Calibrated: 2007/3/20

- Sensor-Surface: 3mm (Mechanical Surface Detection)

- Electronics: DAE3 Sn579; Calibrated: 2007/3/23

- Phantom: SAM 12; Type: SAM V4.0; Serial: TP 1202

- Measurement SW: DASY4, V4.7 Build 53; Postprocessing SW: SEMCAD, V1.8 Build 172

Tilt Position - Mid Channel 140/Area Scan (9x19x1): Measurement grid: dx=10mm, dy=10mm

Maximum value of SAR (measured) = 0.223 mW/g

Tilt Position - Mid Channel 140/Zoom Scan (8x8x8)/Cube 0: Measurement grid: dx=4.3mm,

dy=4.3mm, dz=3mm

Reference Value = 3.92 V/m

Peak SAR (extrapolated) = 0.738 W/kg

SAR(1 g) = 0.187 mW/g; SAR(10 g) = 0.073 mW/g

Maximum value of SAR (measured) = 0.255 mW/g



Test Laboratory: Advance Data Technology

M05-BodyWorn-11a-Ch36

DUT: EDA ; Type: MC7598 ; Test Frequency: 5180 MHz

Communication System: 802.11a ; Frequency: 5180 MHz ; Duty Cycle: 1:1

Medium: MSL5800 Medium parameters used: $f = 5180$ MHz; $\sigma = 5.24$ mho/m; $\epsilon_r = 49.6$; $\rho = 1000$ kg/m³ ; Liquid Level : 151 mm

Phantom section: Flat Section ; DUT test position : Body ; Modulation Type: BPSK

Separation Distance : 0 mm (The front side of the EUT to the Phantom)

Antenna Type : PIFA Antenna ; Air Temp. : 22.3 degrees ; Liquid Temp. : 21.4 degrees

DASY4 Configuration:

- Probe: EX3DV3 - SN3506 ; ConvF(4.48, 4.48, 4.48) ; Calibrated: 2007/3/20

- Sensor-Surface: 3mm (Mechanical Surface Detection)

- Electronics: DAE3 Sn579 ; Calibrated: 2007/3/23

- Phantom: SAM 12 ; Type: SAM V4.0; Serial: TP 1202

- Measurement SW: DASY4, V4.7 Build 53 ; Postprocessing SW: SEMCAD, V1.8 Build 172

Low Channel 36/Area Scan (9x19x1): Measurement grid: dx=10mm, dy=10mm

Maximum value of SAR (measured) = 0.098 mW/g

Low Channel 36/Zoom Scan (8x8x8)/Cube 0: Measurement grid: dx=4.3mm, dy=4.3mm, dz=3mm

Reference Value = 1.25 V/m

Peak SAR (extrapolated) = 0.236 W/kg

SAR(1 g) = 0.078 mW/g; SAR(10 g) = 0.045 mW/g

Maximum value of SAR (measured) = 0.101 mW/g

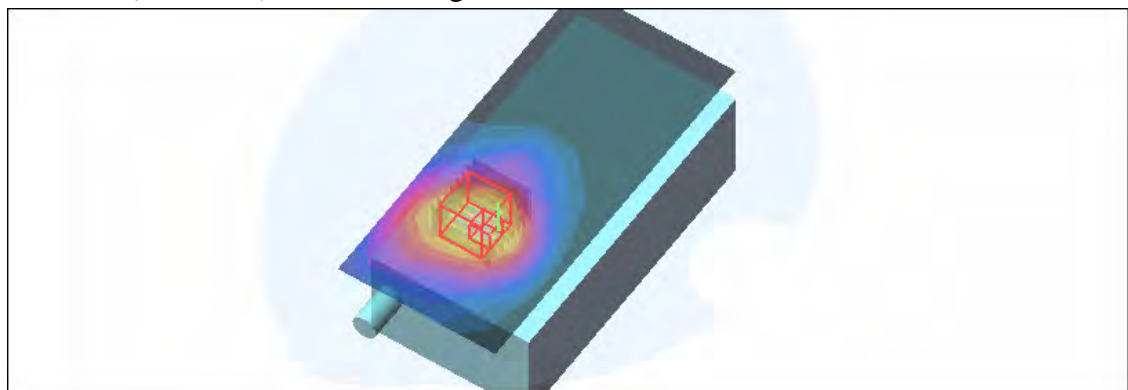
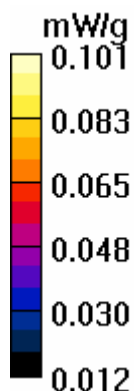

Test Laboratory: Advance Data Technology

M05-BodyWorn-11a-Ch40

DUT: EDA ; Type: MC7598 ; Test Frequency: 5200 MHz

Communication System: 802.11a ; Frequency: 5200 MHz ; Duty Cycle: 1:1

Medium: MSL5800 Medium parameters used: $f = 5200$ MHz; $\sigma = 5.27$ mho/m; $\epsilon_r = 49.5$; $\rho = 1000$ kg/m³ ; Liquid Level : 151 mm

Phantom section: Flat Section ; DUT test position : Body ; Modulation Type: BPSK

Separation Distance : 0 mm (The front side of the EUT to the Phantom)

Antenna Type : PIFA Antenna ; Air Temp. : 22.3 degrees ; Liquid Temp. : 21.4 degrees

DASY4 Configuration:

- Probe: EX3DV3 - SN3506 ; ConvF(4.48, 4.48, 4.48) ; Calibrated: 2007/3/20

- Sensor-Surface: 3mm (Mechanical Surface Detection)

- Electronics: DAE3 Sn579 ; Calibrated: 2007/3/23

- Phantom: SAM 12 ; Type: SAM V4.0; Serial: TP 1202

- Measurement SW: DASY4, V4.7 Build 53 ; Postprocessing SW: SEMCAD, V1.8 Build 172

Mid Channel 40/Area Scan (9x19x1): Measurement grid: dx=10mm, dy=10mm

Maximum value of SAR (measured) = 0.110 mW/g

Mid Channel 40/Zoom Scan (8x8x8)/Cube 0: Measurement grid: dx=4.3mm, dy=4.3mm, dz=3mm

Reference Value = 2.41 V/m

Peak SAR (extrapolated) = 0.257 W/kg

SAR(1 g) = 0.086 mW/g; SAR(10 g) = 0.049 mW/g

Maximum value of SAR (measured) = 0.109 mW/g

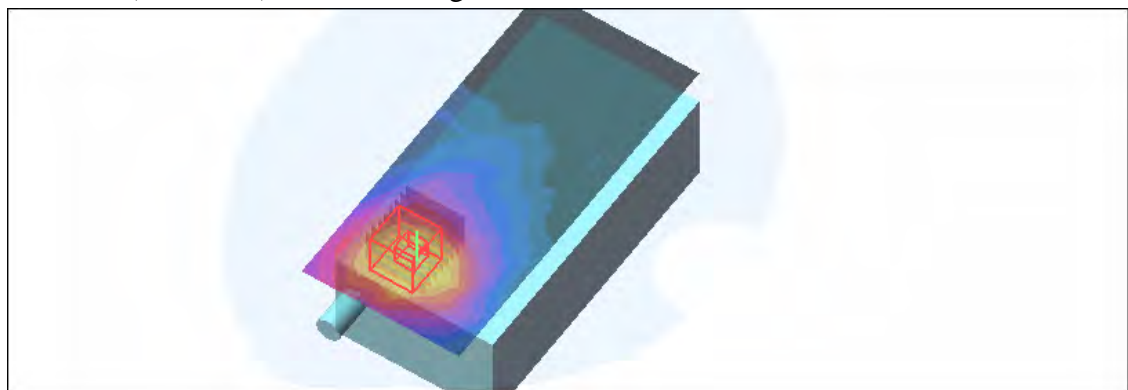
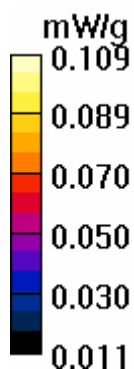

Test Laboratory: Advance Data Technology

M05-BodyWorn-11a-Ch48

DUT: EDA ; Type: MC7598 ; Test Frequency: 5240 MHz

Communication System: 802.11a ; Frequency: 5240 MHz ; Duty Cycle: 1:1

Medium: MSL5800 Medium parameters used: $f = 5240$ MHz; $\sigma = 5.33$ mho/m; $\epsilon_r = 49.4$; $\rho = 1000$ kg/m³ ; Liquid Level : 151 mm

Phantom section: Flat Section ; DUT test position : Body ; Modulation Type: BPSK

Separation Distance : 0 mm (The front side of the EUT to the Phantom)

Antenna Type : PIFA Antenna ; Air Temp. : 22.3 degrees ; Liquid Temp. : 21.4 degrees

DASY4 Configuration:

- Probe: EX3DV3 - SN3506 ; ConvF(4.48, 4.48, 4.48) ; Calibrated: 2007/3/20

- Sensor-Surface: 3mm (Mechanical Surface Detection)

- Electronics: DAE3 Sn579 ; Calibrated: 2007/3/23

- Phantom: SAM 12 ; Type: SAM V4.0; Serial: TP 1202

- Measurement SW: DASY4, V4.7 Build 53 ; Postprocessing SW: SEMCAD, V1.8 Build 172

Mid Channel 48/Area Scan (9x19x1): Measurement grid: dx=10mm, dy=10mm

Maximum value of SAR (measured) = 0.122 mW/g

Mid Channel 48/Zoom Scan (8x8x8)/Cube 0: Measurement grid: dx=4.3mm, dy=4.3mm, dz=3mm

Reference Value = 2.63 V/m

Peak SAR (extrapolated) = 0.302 W/kg

SAR(1 g) = 0.094 mW/g; SAR(10 g) = 0.051 mW/g

Maximum value of SAR (measured) = 0.119 mW/g

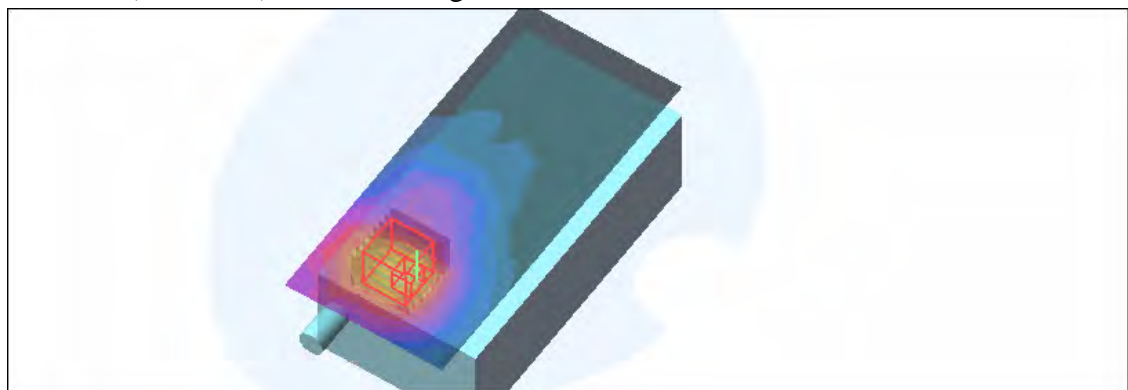
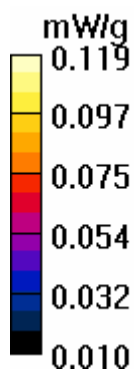

Test Laboratory: Advance Data Technology

M05-BodyWorn-11a-Ch52

DUT: EDA ; Type: MC7598 ; Test Frequency: 5260 MHz

Communication System: 802.11a ; Frequency: 5260 MHz ; Duty Cycle: 1:1

Medium: MSL5800 Medium parameters used: $f = 5260$ MHz; $\sigma = 5.36$ mho/m; $\epsilon_r = 49.4$; $\rho = 1000$ kg/m³ ; Liquid Level : 151 mm

Phantom section: Flat Section ; DUT test position : Body ; Modulation Type: BPSK

Separation Distance : 0 mm (The front side of the EUT to the Phantom)

Antenna Type : PIFA Antenna ; Air Temp. : 22.3 degrees ; Liquid Temp. : 21.4 degrees

DASY4 Configuration:

- Probe: EX3DV3 - SN3506 ; ConvF(4.14, 4.14, 4.14) ; Calibrated: 2007/3/20

- Sensor-Surface: 3mm (Mechanical Surface Detection)

- Electronics: DAE3 Sn579 ; Calibrated: 2007/3/23

- Phantom: SAM 12 ; Type: SAM V4.0; Serial: TP 1202

- Measurement SW: DASY4, V4.7 Build 53 ; Postprocessing SW: SEMCAD, V1.8 Build 172

Mid Channel 52/Area Scan (9x19x1): Measurement grid: dx=10mm, dy=10mm

Maximum value of SAR (measured) = 0.125 mW/g

Mid Channel 52/Zoom Scan (8x8x8)/Cube 0: Measurement grid: dx=4.3mm, dy=4.3mm, dz=3mm

Reference Value = 2.42 V/m

Peak SAR (extrapolated) = 0.347 W/kg

SAR(1 g) = 0.101 mW/g; SAR(10 g) = 0.054 mW/g

Maximum value of SAR (measured) = 0.127 mW/g

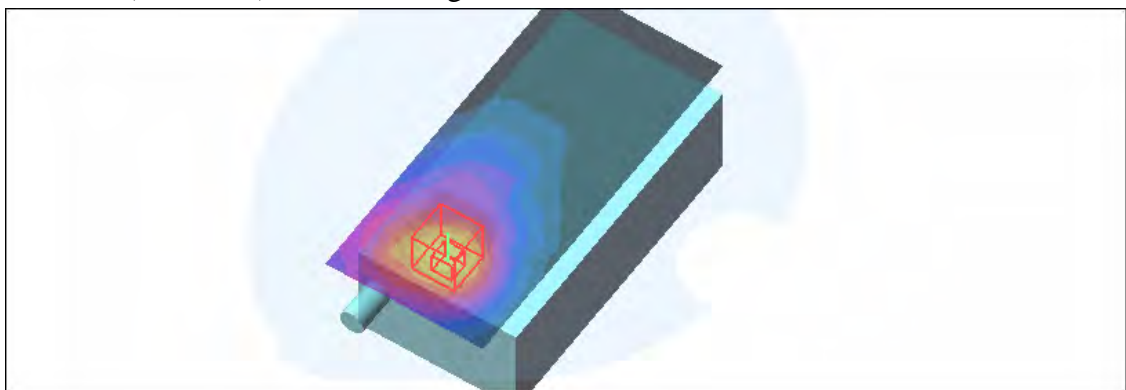
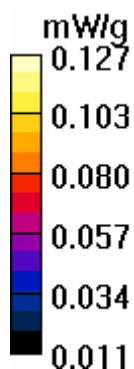

Test Laboratory: Advance Data Technology

M05-BodyWorn-11a-Ch60

DUT: EDA ; Type: MC7598 ; Test Frequency: 5300 MHz

Communication System: 802.11a ; Frequency: 5300 MHz ; Duty Cycle: 1:1

Medium: MSL5800 Medium parameters used: $f = 5300$ MHz; $\sigma = 5.42$ mho/m; $\epsilon_r = 49.4$; $\rho = 1000$ kg/m³ ; Liquid Level : 151 mm

Phantom section: Flat Section ; DUT test position : Body ; Modulation Type: BPSK

Separation Distance : 0 mm (The front side of the EUT to the Phantom)

Antenna Type : PIFA Antenna ; Air Temp. : 22.3 degrees ; Liquid Temp. : 21.4 degrees

DASY4 Configuration:

- Probe: EX3DV3 - SN3506 ; ConvF(4.14, 4.14, 4.14) ; Calibrated: 2007/3/20

- Sensor-Surface: 3mm (Mechanical Surface Detection)

- Electronics: DAE3 Sn579 ; Calibrated: 2007/3/23

- Phantom: SAM 12 ; Type: SAM V4.0; Serial: TP 1202

- Measurement SW: DASY4, V4.7 Build 53 ; Postprocessing SW: SEMCAD, V1.8 Build 172

Mid Channel 60/Area Scan (9x19x1): Measurement grid: dx=10mm, dy=10mm

Maximum value of SAR (measured) = 0.123 mW/g

Mid Channel 60/Zoom Scan (8x8x8)/Cube 0: Measurement grid: dx=4.3mm, dy=4.3mm, dz=3mm

Reference Value = 2.82 V/m

Peak SAR (extrapolated) = 0.311 W/kg

SAR(1 g) = 0.094 mW/g; SAR(10 g) = 0.050 mW/g

Maximum value of SAR (measured) = 0.119 mW/g

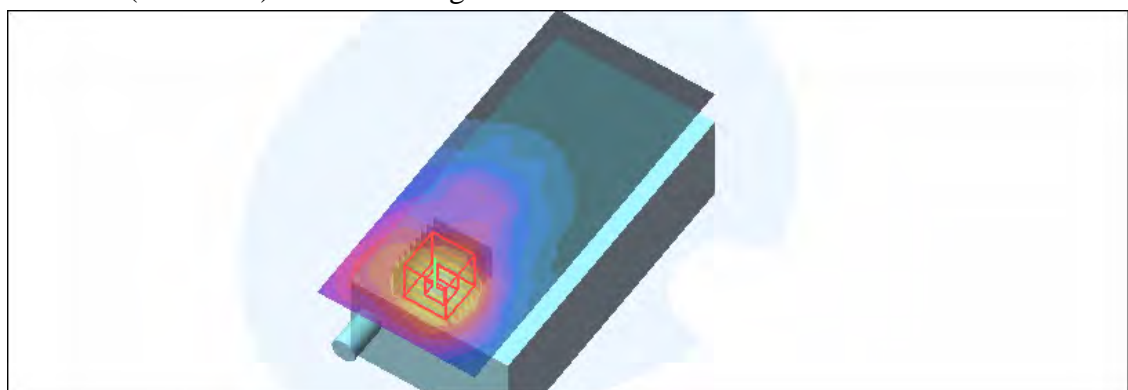
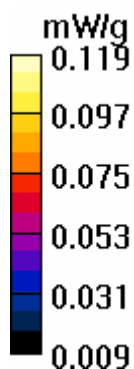

Test Laboratory: Advance Data Technology

M05-BodyWorn-11a-Ch64

DUT: EDA ; Type: MC7598 ; Test Frequency: 5320 MHz

Communication System: 802.11a ; Frequency: 5320 MHz ; Duty Cycle: 1:1

Medium: MSL5800 Medium parameters used: $f = 5320$ MHz; $\sigma = 5.45$ mho/m; $\epsilon_r = 49.3$; $\rho = 1000$ kg/m³ ; Liquid Level : 151 mm

Phantom section: Flat Section ; DUT test position : Body ; Modulation Type: BPSK

Separation Distance : 0 mm (The front side of the EUT to the Phantom)

Antenna Type : PIFA Antenna ; Air Temp. : 22.3 degrees ; Liquid Temp. : 21.4 degrees

DASY4 Configuration:

- Probe: EX3DV3 - SN3506 ; ConvF(4.14, 4.14, 4.14) ; Calibrated: 2007/3/20

- Sensor-Surface: 3mm (Mechanical Surface Detection)

- Electronics: DAE3 Sn579 ; Calibrated: 2007/3/23

- Phantom: SAM 12 ; Type: SAM V4.0; Serial: TP 1202

- Measurement SW: DASY4, V4.7 Build 53 ; Postprocessing SW: SEMCAD, V1.8 Build 172

Mid Channel 64/Area Scan (9x19x1): Measurement grid: dx=10mm, dy=10mm

Maximum value of SAR (measured) = 0.106 mW/g

Mid Channel 64/Zoom Scan (8x8x8)/Cube 0: Measurement grid: dx=4.3mm, dy=4.3mm, dz=3mm

Reference Value = 2.63 V/m

Peak SAR (extrapolated) = 0.265 W/kg

SAR(1 g) = 0.084 mW/g; SAR(10 g) = 0.046 mW/g

Maximum value of SAR (measured) = 0.107 mW/g

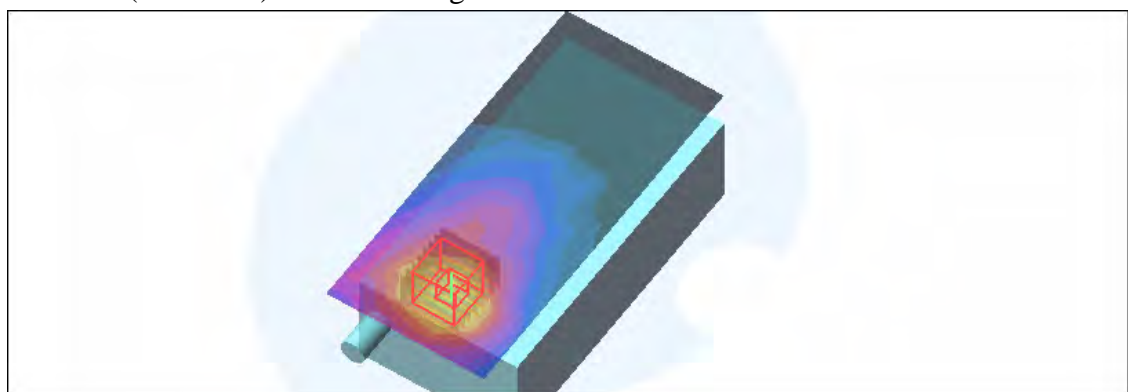
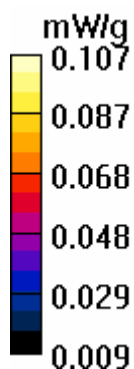

Test Laboratory: Advance Data Technology

M05-BodyWorn-11a-Ch100

DUT: EDA ; Type: MC7598 ; Test Frequency: 5500 MHz

Communication System: 802.11a ; Frequency: 5500 MHz ; Duty Cycle: 1:1

Medium: MSL5800 Medium parameters used: $f = 5500$ MHz; $\sigma = 5.71$ mho/m; $\epsilon_r = 48.9$; $\rho = 1000$ kg/m³ ; Liquid Level : 151 mm

Phantom section: Flat Section ; DUT test position : Body ; Modulation Type: BPSK

Separation Distance : 0 mm (The front side of the EUT to the Phantom)

Antenna Type : PIFA Antenna ; Air Temp. : 22.3 degrees ; Liquid Temp. : 21.4 degrees

DASY4 Configuration:

- Probe: EX3DV3 - SN3506 ; ConvF(4.11, 4.11, 4.11) ; Calibrated: 2007/3/20

- Sensor-Surface: 3mm (Mechanical Surface Detection)

- Electronics: DAE3 Sn579 ; Calibrated: 2007/3/23

- Phantom: SAM 12 ; Type: SAM V4.0; Serial: TP 1202

- Measurement SW: DASY4, V4.7 Build 53 ; Postprocessing SW: SEMCAD, V1.8 Build 172

Mid Channel 100/Area Scan (9x19x1): Measurement grid: dx=10mm, dy=10mm

Maximum value of SAR (measured) = 0.074 mW/g

Mid Channel 100/Zoom Scan (8x8x8)/Cube 0: Measurement grid: dx=4.3mm, dy=4.3mm, dz=3mm

Reference Value = 1.73 V/m

Peak SAR (extrapolated) = 0.180 W/kg

SAR(1 g) = 0.059 mW/g; SAR(10 g) = 0.034 mW/g

Maximum value of SAR (measured) = 0.076 mW/g

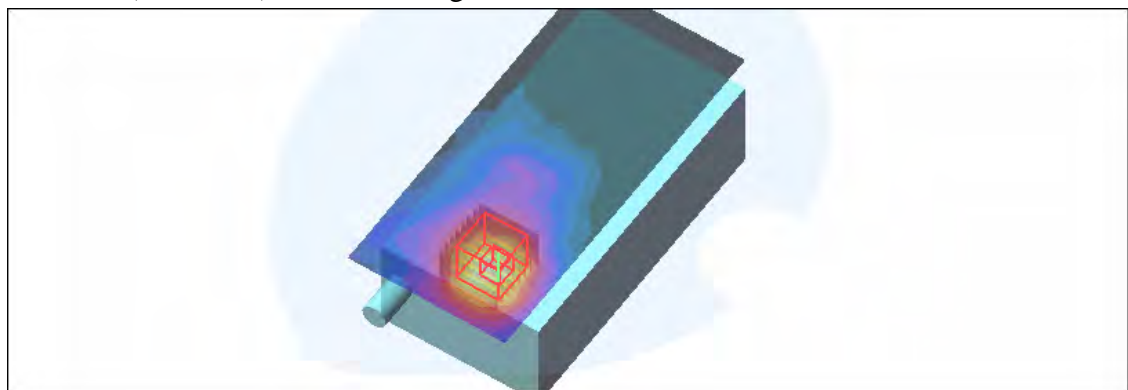
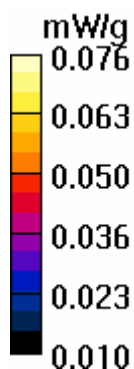

Test Laboratory: Advance Data Technology

M05-BodyWorn-11a-Ch104

DUT: EDA ; Type: MC7598 ; Test Frequency: 5520 MHz

Communication System: 802.11a ; Frequency: 5520 MHz ; Duty Cycle: 1:1

Medium: MSL5800 Medium parameters used: $f = 5520$ MHz; $\sigma = 5.74$ mho/m; $\epsilon_r = 48.9$; $\rho = 1000$ kg/m³ ; Liquid Level : 151 mm

Phantom section: Flat Section ; DUT test position : Body ; Modulation Type: BPSK

Separation Distance : 0 mm (The front side of the EUT to the Phantom)

Antenna Type : PIFA Antenna ; Air Temp. : 22.3 degrees ; Liquid Temp. : 21.4 degrees

DASY4 Configuration:

- Probe: EX3DV3 - SN3506 ; ConvF(4.11, 4.11, 4.11) ; Calibrated: 2007/3/20

- Sensor-Surface: 3mm (Mechanical Surface Detection)

- Electronics: DAE3 Sn579 ; Calibrated: 2007/3/23

- Phantom: SAM 12 ; Type: SAM V4.0; Serial: TP 1202

- Measurement SW: DASY4, V4.7 Build 53 ; Postprocessing SW: SEMCAD, V1.8 Build 172

Mid Channel 104/Area Scan (9x19x1): Measurement grid: dx=10mm, dy=10mm

Maximum value of SAR (measured) = 0.088 mW/g

Mid Channel 104/Zoom Scan (8x8x8)/Cube 0: Measurement grid: dx=4.3mm, dy=4.3mm, dz=3mm

Reference Value = 2.54 V/m

Peak SAR (extrapolated) = 0.225 W/kg

SAR(1 g) = 0.071 mW/g; SAR(10 g) = 0.041 mW/g

Maximum value of SAR (measured) = 0.092 mW/g

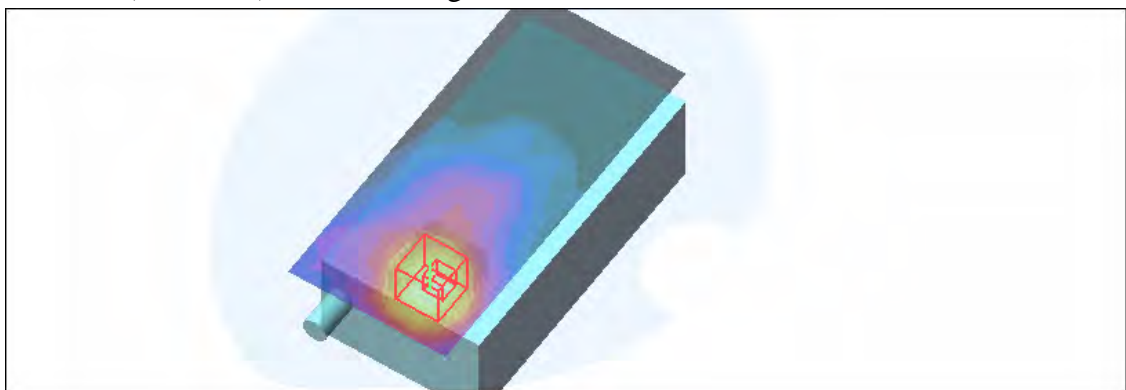
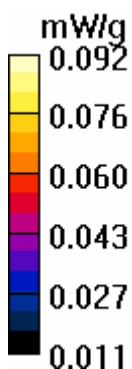

Test Laboratory: Advance Data Technology

M05-BodyWorn-11a-Ch116

DUT: EDA ; Type: MC7598 ; Test Frequency: 5580 MHz

Communication System: 802.11a ; Frequency: 5580 MHz ; Duty Cycle: 1:1

Medium: MSL5800 Medium parameters used: $f = 5580$ MHz; $\sigma = 5.82$ mho/m; $\epsilon_r = 48.7$; $\rho = 1000$ kg/m³ ; Liquid Level : 151 mm

Phantom section: Flat Section ; DUT test position : Body ; Modulation Type: BPSK

Separation Distance : 0 mm (The front side of the EUT to the Phantom)

Antenna Type : PIFA Antenna ; Air Temp. : 22.3 degrees ; Liquid Temp. : 21.4 degrees

DASY4 Configuration:

- Probe: EX3DV3 - SN3506 ; ConvF(4.11, 4.11, 4.11) ; Calibrated: 2007/3/20

- Sensor-Surface: 3mm (Mechanical Surface Detection)

- Electronics: DAE3 Sn579 ; Calibrated: 2007/3/23

- Phantom: SAM 12 ; Type: SAM V4.0; Serial: TP 1202

- Measurement SW: DASY4, V4.7 Build 53 ; Postprocessing SW: SEMCAD, V1.8 Build 172

Mid Channel 116/Area Scan (9x19x1): Measurement grid: dx=10mm, dy=10mm

Maximum value of SAR (measured) = 0.094 mW/g

Mid Channel 116/Zoom Scan (8x8x8)/Cube 0: Measurement grid: dx=4.3mm, dy=4.3mm, dz=3mm

Reference Value = 2.52 V/m

Peak SAR (extrapolated) = 0.226 W/kg

SAR(1 g) = 0.078 mW/g; SAR(10 g) = 0.043 mW/g

Maximum value of SAR (measured) = 0.100 mW/g

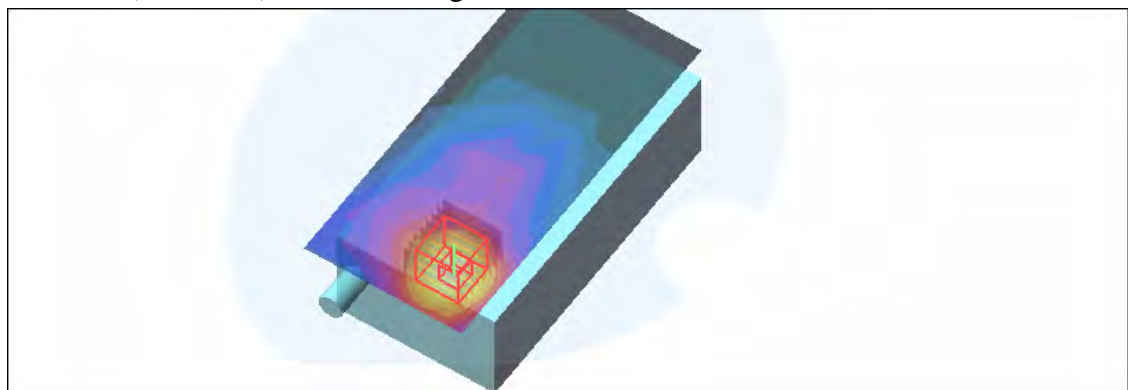
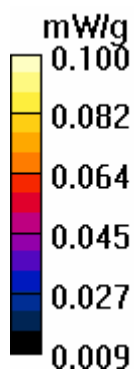

Test Laboratory: Advance Data Technology

M05-BodyWorn-11a-Ch120

DUT: EDA ; Type: MC7598 ; Test Frequency: 5600 MHz

Communication System: 802.11a ; Frequency: 5600 MHz ; Duty Cycle: 1:1

Medium: MSL5800 Medium parameters used: $f = 5600$ MHz; $\sigma = 5.85$ mho/m; $\epsilon_r = 48.7$; $\rho = 1000$ kg/m³ ; Liquid Level : 151 mm

Phantom section: Flat Section ; DUT test position : Body ; Modulation Type: BPSK

Separation Distance : 0 mm (The front side of the EUT to the Phantom)

Antenna Type : PIFA Antenna ; Air Temp. : 22.3 degrees ; Liquid Temp. : 21.4 degrees

DASY4 Configuration:

- Probe: EX3DV3 - SN3506 ; ConvF(4.11, 4.11, 4.11) ; Calibrated: 2007/3/20

- Sensor-Surface: 3mm (Mechanical Surface Detection)

- Electronics: DAE3 Sn579 ; Calibrated: 2007/3/23

- Phantom: SAM 12 ; Type: SAM V4.0; Serial: TP 1202

- Measurement SW: DASY4, V4.7 Build 53 ; Postprocessing SW: SEMCAD, V1.8 Build 172

Mid Channel 120/Area Scan (9x19x1): Measurement grid: dx=10mm, dy=10mm

Maximum value of SAR (measured) = 0.104 mW/g

Mid Channel 120/Zoom Scan (8x8x8)/Cube 0: Measurement grid: dx=4.3mm, dy=4.3mm, dz=3mm

Reference Value = 2.81 V/m

Peak SAR (extrapolated) = 0.249 W/kg

SAR(1 g) = 0.085 mW/g; SAR(10 g) = 0.045 mW/g

Maximum value of SAR (measured) = 0.108 mW/g

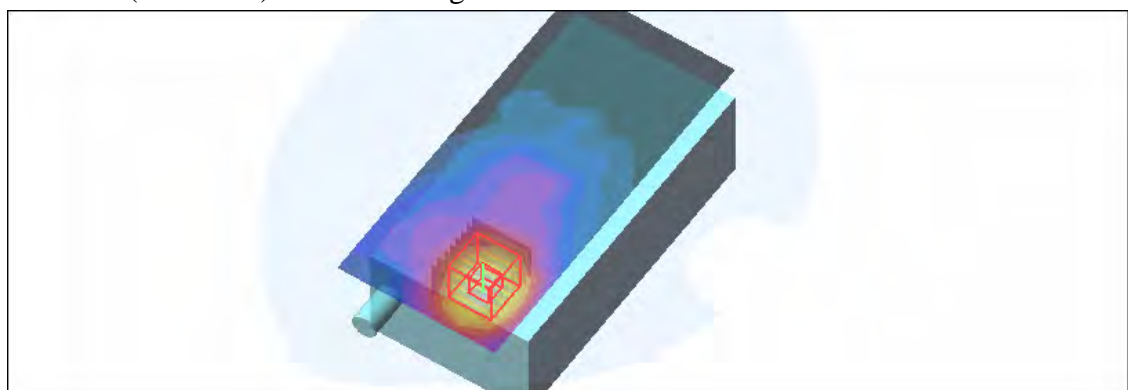
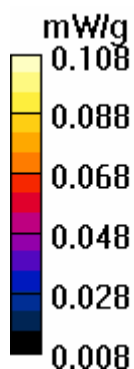

Test Laboratory: Advance Data Technology

M05-BodyWorn-11a-Ch124

DUT: EDA ; Type: MC7598 ; Test Frequency: 5620 MHz

Communication System: 802.11a ; Frequency: 5620 MHz ; Duty Cycle: 1:1

Medium: MSL5800 Medium parameters used: $f = 5620$ MHz; $\sigma = 5.88$ mho/m; $\epsilon_r = 48.7$; $\rho = 1000$ kg/m³ ; Liquid Level : 151 mm

Phantom section: Flat Section ; DUT test position : Body ; Modulation Type: BPSK

Separation Distance : 0 mm (The front side of the EUT to the Phantom)

Antenna Type : PIFA Antenna ; Air Temp. : 22.3 degrees ; Liquid Temp. : 21.4 degrees

DASY4 Configuration:

- Probe: EX3DV3 - SN3506 ; ConvF(4.11, 4.11, 4.11) ; Calibrated: 2007/3/20

- Sensor-Surface: 3mm (Mechanical Surface Detection)

- Electronics: DAE3 Sn579 ; Calibrated: 2007/3/23

- Phantom: SAM 12 ; Type: SAM V4.0; Serial: TP 1202

- Measurement SW: DASY4, V4.7 Build 53 ; Postprocessing SW: SEMCAD, V1.8 Build 172

Mid Channel 124/Area Scan (9x19x1): Measurement grid: dx=10mm, dy=10mm

Maximum value of SAR (measured) = 0.110 mW/g

Mid Channel 124/Zoom Scan (8x8x8)/Cube 0: Measurement grid: dx=4.3mm, dy=4.3mm, dz=3mm

Reference Value = 2.65 V/m

Peak SAR (extrapolated) = 0.272 W/kg

SAR(1 g) = 0.085 mW/g; SAR(10 g) = 0.046 mW/g

Maximum value of SAR (measured) = 0.111 mW/g

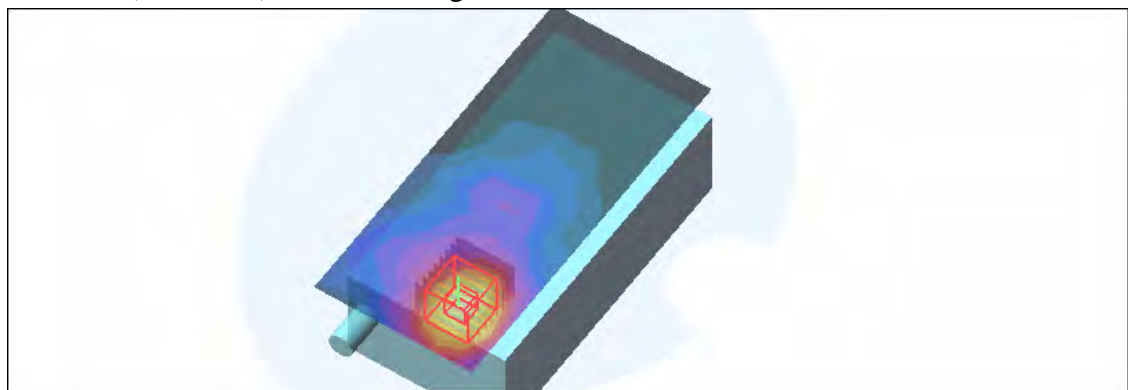
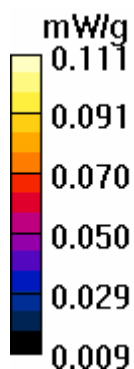

Test Laboratory: Advance Data Technology

M05-BodyWorn-11a-Ch136

DUT: EDA ; Type: MC7598 ; Test Frequency: 5680 MHz

Communication System: 802.11a ; Frequency: 5680 MHz ; Duty Cycle: 1:1

Medium: MSL5800 Medium parameters used: $f = 5680$ MHz; $\sigma = 5.97$ mho/m; $\epsilon_r = 48.6$; $\rho = 1000$ kg/m³ ; Liquid Level : 151 mm

Phantom section: Flat Section ; DUT test position : Body ; Modulation Type: BPSK

Separation Distance : 0 mm (The front side of the EUT to the Phantom)

Antenna Type : PIFA Antenna ; Air Temp. : 22.3 degrees ; Liquid Temp. : 21.4 degrees

DASY4 Configuration:

- Probe: EX3DV3 - SN3506 ; ConvF(4.11, 4.11, 4.11) ; Calibrated: 2007/3/20

- Sensor-Surface: 3mm (Mechanical Surface Detection)

- Electronics: DAE3 Sn579 ; Calibrated: 2007/3/23

- Phantom: SAM 12 ; Type: SAM V4.0; Serial: TP 1202

- Measurement SW: DASY4, V4.7 Build 53 ; Postprocessing SW: SEMCAD, V1.8 Build 172

Mid Channel 136/Area Scan (9x19x1): Measurement grid: dx=10mm, dy=10mm

Maximum value of SAR (measured) = 0.095 mW/g

Mid Channel 136/Zoom Scan (8x8x8)/Cube 0: Measurement grid: dx=4.3mm, dy=4.3mm, dz=3mm

Reference Value = 2.07 V/m

Peak SAR (extrapolated) = 0.241 W/kg

SAR(1 g) = 0.074 mW/g; SAR(10 g) = 0.041 mW/g

Maximum value of SAR (measured) = 0.094 mW/g

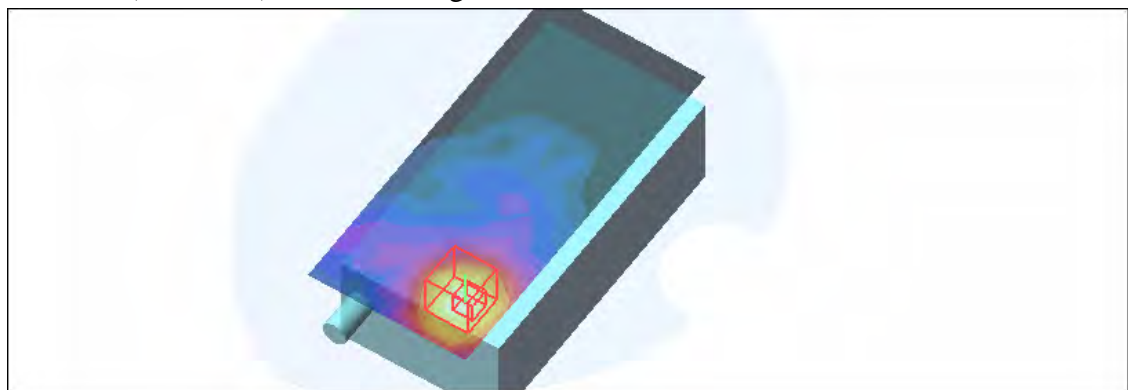
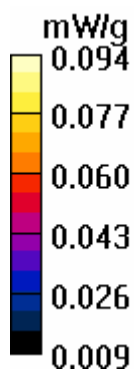

Test Laboratory: Advance Data Technology

M05-BodyWorn-11a-Ch140

DUT: EDA ; Type: MC75 Series ; Test Frequency: 5700 MHz

Communication System: 802.11a ; Frequency: 5700 MHz ; Duty Cycle: 1:1

Medium: MSL5800 Medium parameters used: $f = 5700$ MHz; $\sigma = 6$ mho/m; $\epsilon_r = 48.5$; $\rho = 1000$ kg/m³ ; Liquid Level : 151 mm

Phantom section: Flat Section ; DUT test position : Body ; Modulation Type: BPSK

Separation Distance : 0 mm (The front side of the EUT to the Phantom)

Antenna Type : PIFA Antenna ; Air Temp. : 22.3 degrees ; Liquid Temp. : 21.4 degrees

DASY4 Configuration:

- Probe: EX3DV3 - SN3506 ; ConvF(4.20, 4.20, 4.20) ; Calibrated: 2007/3/20

- Sensor-Surface: 3mm (Mechanical Surface Detection)

- Electronics: DAE3 Sn579 ; Calibrated: 2007/3/23

- Phantom: SAM 12 ; Type: SAM V4.0; Serial: TP 1202

- Measurement SW: DASY4, V4.7 Build 53 ; Postprocessing SW: SEMCAD, V1.8 Build 172

Mid Channel 140/Area Scan (9x19x1): Measurement grid: dx=10mm, dy=10mm

Maximum value of SAR (measured) = 0.037 mW/g

Mid Channel 140/Zoom Scan (8x8x8)/Cube 0: Measurement grid: dx=4.3mm, dy=4.3mm, dz=3mm

Reference Value = 1.62 V/m

Peak SAR (extrapolated) = 0.121 W/kg

SAR(1 g) = 0.032 mW/g; SAR(10 g) = 0.021 mW/g

Maximum value of SAR (measured) = 0.038 mW/g

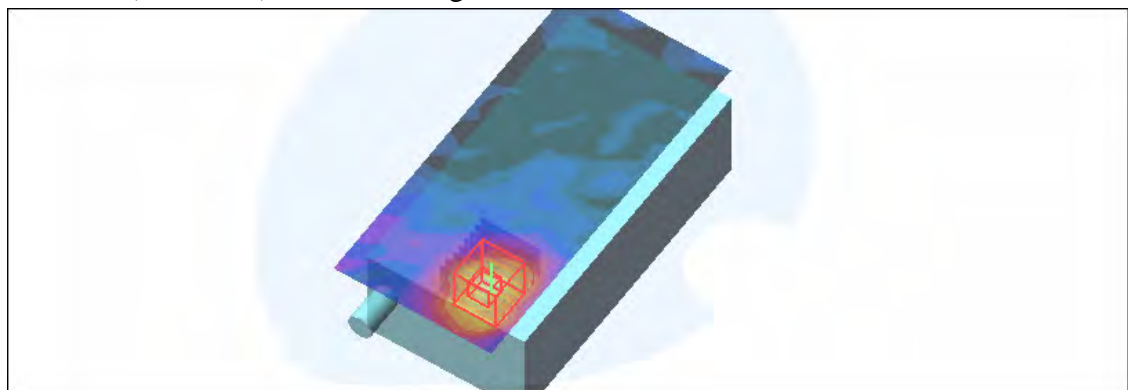
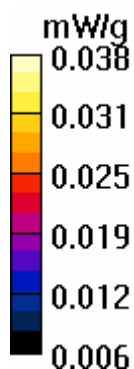

Test Laboratory: Advance Data Technology

M06-Right Head-Tilt-11a-Ch40 (1D)

DUT: EDA ; Type: MC7598 ; Test Frequency: 5200 MHz

Communication System: 802.11a ; Frequency: 5200 MHz; Duty Cycle: 1:1

Medium: HSL5800 Medium parameters used: $f = 5200$ MHz; $\sigma = 4.63$ mho/m; $\epsilon_r = 36.7$; $\rho = 1000$ kg/m³ ;

Liquid level: 151 mm

Phantom section: Right Section ; DUT test position : Tilt ; Modulation type: BPSK

Antenna type : PIFA Antenna ; Air temp. : 22.2 degrees ; Liquid temp. : 21.0 degrees

DASY4 Configuration:

- Probe: EX3DV3 - SN3506 ; ConvF(4.92, 4.92, 4.92) ; Calibrated: 2007/3/20

- Sensor-Surface: 3mm (Mechanical Surface Detection)

- Electronics: DAE3 Sn579; Calibrated: 2007/3/23

- Phantom: SAM 12; Type: SAM V4.0; Serial: TP 1202

- Measurement SW: DASY4, V4.7 Build 53; Postprocessing SW: SEMCAD, V1.8 Build 172

Tilt Position - Mid Channel 40/Area Scan (9x19x1): Measurement grid: dx=10mm, dy=10mm

Maximum value of SAR (measured) = 0.93 mW/g

Tilt Position - Mid Channel 40/Zoom Scan (8x8x8)/Cube 0: Measurement grid: dx=4.3mm,

dy=4.3mm, dz=3mm

Reference Value = 9.23 V/m

Peak SAR (extrapolated) = 3.37 W/kg

SAR(1 g) = 0.979 mW/g; SAR(10 g) = 0.333 mW/g

Maximum value of SAR (measured) = 1.10 mW/g

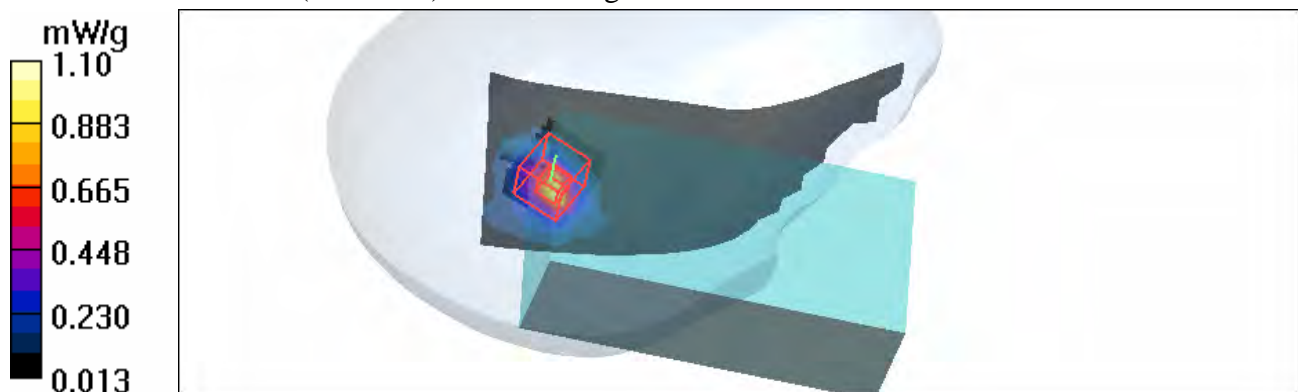

Test Laboratory: Advance Data Technology

M06-Right Head-Tilt-11a-Ch52 (1D)

DUT: EDA ; Type: MC7598 ; Test Frequency: 5260 MHz

Communication System: 802.11a ; Frequency: 5260 MHz; Duty Cycle: 1:1

Medium: HSL5800 Medium parameters used: $f = 5260$ MHz; $\sigma = 4.71$ mho/m; $\epsilon_r = 36.6$; $\rho = 1000$ kg/m³ ;

Liquid level: 151 mm

Phantom section: Right Section ; DUT test position : Tilt ; Modulation type: BPSK

Antenna type : PIFA Antenna ; Air temp. : 22.2 degrees ; Liquid temp. : 21.0 degrees

DASY4 Configuration:

- Probe: EX3DV3 - SN3506 ; ConvF(4.77, 4.77, 4.77) ; Calibrated: 2007/3/20

- Sensor-Surface: 3mm (Mechanical Surface Detection)

- Electronics: DAE3 Sn579; Calibrated: 2007/3/23

- Phantom: SAM 12; Type: SAM V4.0; Serial: TP 1202

- Measurement SW: DASY4, V4.7 Build 53; Postprocessing SW: SEMCAD, V1.8 Build 172

Tilt Position - Mid Channel 52/Area Scan (9x19x1): Measurement grid: dx=10mm, dy=10mm

Maximum value of SAR (measured) = 1.02 mW/g

Tilt Position - Mid Channel 52/Zoom Scan (8x8x8)/Cube 0: Measurement grid: dx=4.3mm,

dy=4.3mm, dz=3mm

Reference Value = 9.17 V/m

Peak SAR (extrapolated) = 3.03 W/kg

SAR(1 g) = 0.890 mW/g; SAR(10 g) = 0.313 mW/g

Maximum value of SAR (measured) = 1.12 mW/g

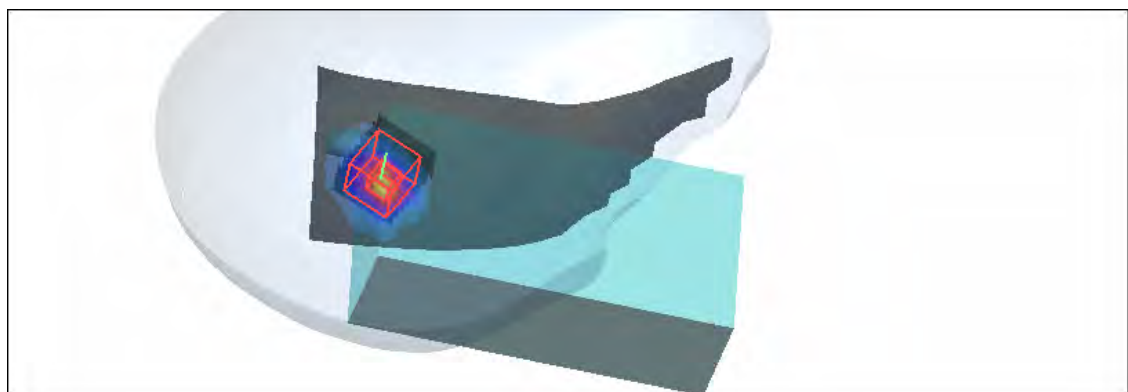
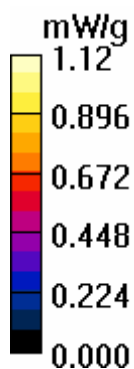

Test Laboratory: Advance Data Technology

M06-Right Head-Tilt-11a-Ch136 (1D)

DUT: EDA ; Type: MC7598 ; Test Frequency: 5680 MHz

Communication System: 802.11a ; Frequency: 5680 MHz; Duty Cycle: 1:1

Medium: HSL5800 Medium parameters used: $f = 5680$ MHz; $\sigma = 5.21$ mho/m; $\epsilon_r = 35.9$; $\rho = 1000$ kg/m³ ;
Liquid level: 151 mm

Phantom section: Right Section ; DUT test position : Tilt ; Modulation type: BPSK

Antenna type : PIFA Antenna ; Air temp. : 22.2 degrees ; Liquid temp. : 21.0 degrees

DASY4 Configuration:

- Probe: EX3DV3 - SN3506 ; ConvF(4.4, 4.4, 4.4) ; Calibrated: 2007/3/20

- Sensor-Surface: 3mm (Mechanical Surface Detection)

- Electronics: DAE3 Sn579; Calibrated: 2007/3/23

- Phantom: SAM 12; Type: SAM V4.0; Serial: TP 1202

- Measurement SW: DASY4, V4.7 Build 53; Postprocessing SW: SEMCAD, V1.8 Build 172

Tilt Position - Mid Channel 136/Area Scan (9x19x1): Measurement grid: dx=10mm, dy=10mm

Maximum value of SAR (measured) = 0.775 mW/g

Tilt Position - Mid Channel 136/Zoom Scan (8x8x8)/Cube 0: Measurement grid: dx=4.3mm, dy=4.3mm, dz=3mm

Reference Value = 8.1 V/m

Peak SAR (extrapolated) = 2.37 W/kg

SAR(1 g) = 0.634 mW/g; SAR(10 g) = 0.238 mW/g

Maximum value of SAR (measured) = 0.862 mW/g

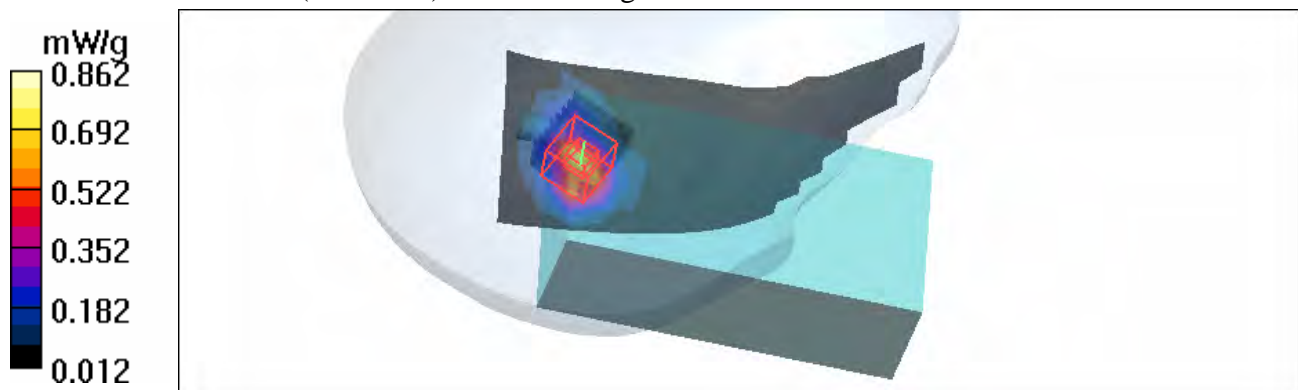

Test Laboratory: Advance Data Technology

M07-Right Head- Cheek-11a-Ch120 (Aux ant)

DUT: EDA ; Type: MC7598 ; Test Frequency: 5600 MHz

Communication System: 802.11a ; Frequency: 5600 MHz; Duty Cycle: 1:1

Medium: HSL5800 Medium parameters used: $f = 5600$ MHz; $\sigma = 5.15$ mho/m; $\epsilon_r = 35.6$; $\rho = 1000$ kg/m³ ;
Liquid level: 151 mm

Phantom section: Right Section ; DUT test position : Cheek ; Modulation type: BPSK

Antenna type : PIFA Antenna ; Air temp. : 22.4 degrees ; Liquid temp. : 21.3 degrees

DASY4 Configuration:

- Probe: EX3DV3 - SN3506 ; ConvF(4.55, 4.55, 4.55) ; Calibrated: 2007/3/20

- Sensor-Surface: 3mm (Mechanical Surface Detection)

- Electronics: DAE3 Sn579; Calibrated: 2007/3/23

- Phantom: SAM 12; Type: SAM V4.0; Serial: TP 1202

- Measurement SW: DASY4, V4.7 Build 53; Postprocessing SW: SEMCAD, V1.8 Build 172

Touch Position - Mid Channel 120/Area Scan (14x19x1): Measurement grid: dx=10mm, dy=10mm

Maximum value of SAR (measured) = 0.125 mW/g

Touch Position - Mid Channel 120/Zoom Scan (8x8x8)/Cube 0: Measurement grid:

dx=4.3mm, dy=4.3mm, dz=3mm

Reference Value = 2.89 V/m

Peak SAR (extrapolated) = 0.601 W/kg

SAR(1 g) = 0.091 mW/g; SAR(10 g) = 0.035 mW/g

Maximum value of SAR (measured) = 0.152 mW/g

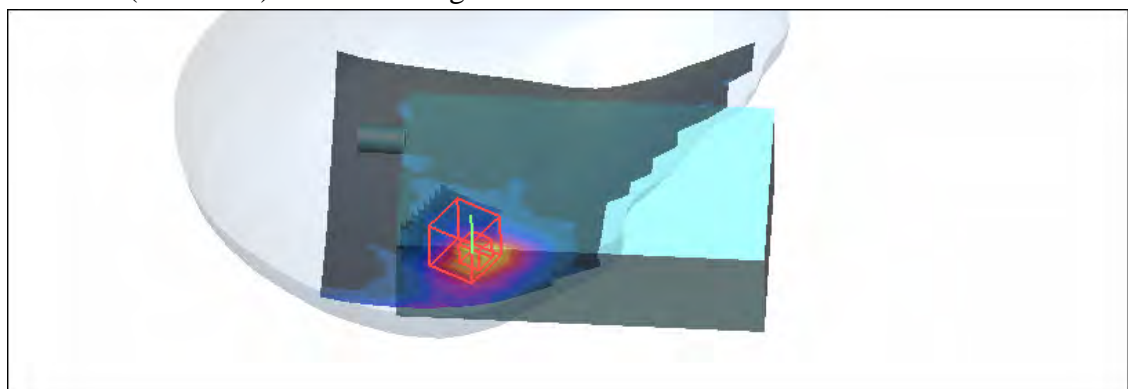
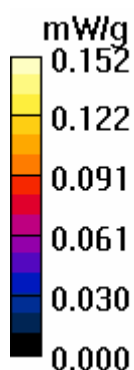

Test Laboratory: Advance Data Technology

M08-Left Head-Cheek-11a-Ch120 (Aux ant)

DUT: EDA ; Type: MC7598 ; Test Frequency: 5600 MHz

Communication System: 802.11a ; Frequency: 5600 MHz; Duty Cycle: 1:1

Medium: HSL5800 Medium parameters used: $f = 5600$ MHz; $\sigma = 5.15$ mho/m; $\epsilon_r = 35.6$; $\rho = 1000$ kg/m³ ;

Liquid level: 151 mm

Phantom section: Left Section ; DUT test position : Cheek ; Modulation type: BPSK

Antenna type : PIFA Antenna ; Air temp. : 22.4 degrees ; Liquid temp. : 21.3 degrees

DASY4 Configuration:

- Probe: EX3DV3 - SN3506 ; ConvF(4.55, 4.55, 4.55) ; Calibrated: 2007/3/20

- Sensor-Surface: 3mm (Mechanical Surface Detection)

- Electronics: DAE3 Sn579; Calibrated: 2007/3/23

- Phantom: SAM 12; Type: SAM V4.0; Serial: TP 1202

- Measurement SW: DASY4, V4.7 Build 53; Postprocessing SW: SEMCAD, V1.8 Build 172

Touch Position - Mid Channel 120/Area Scan (14x19x1): Measurement grid: dx=10mm, dy=10mm

Maximum value of SAR (measured) = 0.108 mW/g

Touch Position - Mid Channel 120/Zoom Scan (8x8x8)/Cube 0: Measurement grid:

dx=4.3mm, dy=4.3mm, dz=3mm

Reference Value = 2.59 V/m

Peak SAR (extrapolated) = 0.365 W/kg

SAR(1 g) = 0.099 mW/g; SAR(10 g) = 0.053 mW/g

Maximum value of SAR (measured) = 0.155 mW/g

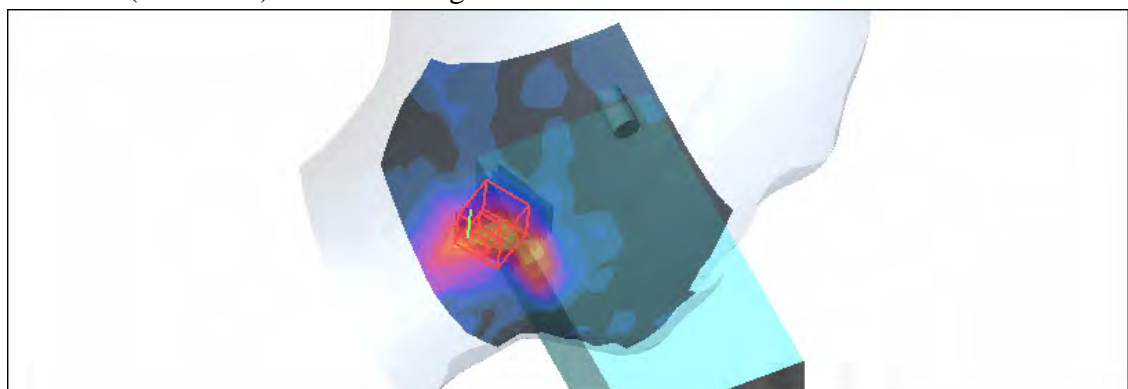
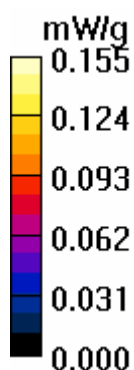

Test Laboratory: Advance Data Technology

System Validation Check-HSL 5200MHz

DUT: Dipole 5 GHz ; Type: D5GHzV2 ; Serial: 1018 ; Test Frequency: 5200 MHz

Communication System: CW ; Frequency: 5200 MHz; Duty Cycle: 1:1; Modulation type: CW
Medium: HSL5800; Medium parameters used: $f = 5200$ MHz; $\sigma = 4.63$ mho/m; $\epsilon_r = 36.7$; $\rho = 1000$ kg/m³ ;
Liquid level : 151 mm
Phantom section: Flat Section ; Separation distance : 10 mm (The feetpoint of the dipole to the Phantom)
Air temp. : 22.2 degrees ; Liquid temp. : 21.0 degrees

DASY4 Configuration:

- Probe: EX3DV3 - SN3506 ; ConvF(4.92, 4.92, 4.92) ; Calibrated: 2007/3/20
- Sensor-Surface: 3mm (Mechanical Surface Detection)
- Electronics: DAE3 Sn579; Calibrated: 2007/3/23
- Phantom: SAM 12; Type: SAM V4.0; Serial: TP 1202
- Measurement SW: DASY4, V4.7 Build 53; Postprocessing SW: SEMCAD, V1.8 Build 172

f=5200, d=10mm , Pin=250mW/Area Scan (7x7x1): Measurement grid: dx=10mm, dy=10mm
Maximum value of SAR (measured) = 33.8 mW/g

f=5200, d=10mm , Pin=250mW/Zoom Scan (8x8x8)/Cube 0: Measurement grid: dx=4.3mm, dy=4.3mm, dz=3mm

Reference Value = 63.5 V/m; Power Drift = -0.110 dB

Peak SAR (extrapolated) = 71.0 W/kg

SAR(1 g) = 19.5 mW/g; SAR(10 g) = 5.37 mW/g

Maximum value of SAR (measured) = 32.6 mW/g

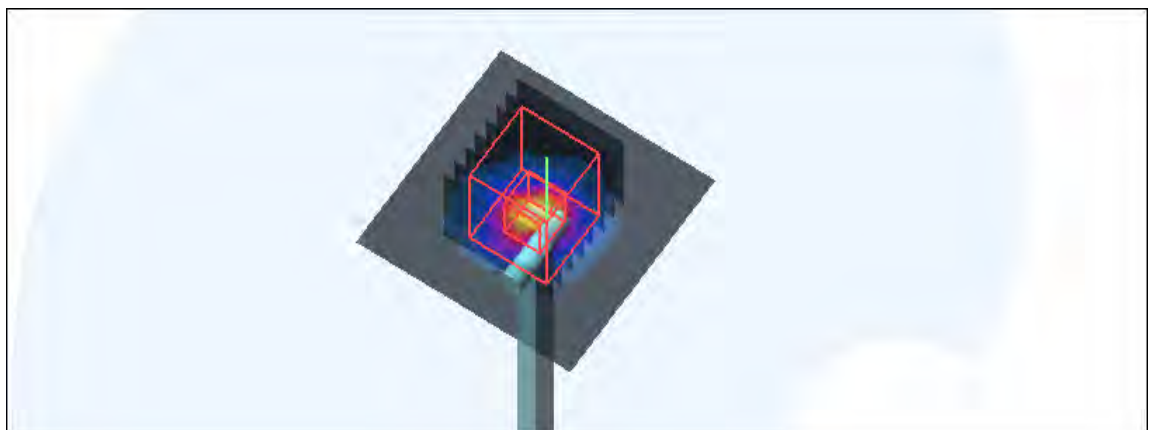
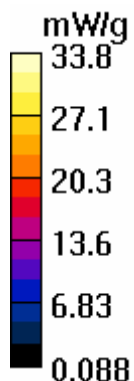

Test Laboratory: Advance Data Technology

System Validation Check-HSL 5500MHz

DUT: Dipole 5 GHz ; Type: D5GHzV2 ; Serial: 1018 ; Test Frequency: 5500 MHz

Communication System: CW ; Frequency: 5500 MHz; Duty Cycle: 1:1; Modulation type: CW
Medium: HSL5800; Medium parameters used: $f = 5500$ MHz; $\sigma = 4.99$ mho/m; $\epsilon_r = 36.3$; $\rho = 1000$ kg/m³ ;
Liquid level : 151 mm
Phantom section: Flat Section ; Separation distance : 10 mm (The feetpoint of the dipole to the Phantom)
Air temp. : 22.2 degrees ; Liquid temp. : 21.0 degrees

DASY4 Configuration:

- Probe: EX3DV3 - SN3506 ; ConvF(4.55, 4.55, 4.55) ; Calibrated: 2007/3/20
- Sensor-Surface: 3mm (Mechanical Surface Detection)
- Electronics: DAE3 Sn579; Calibrated: 2007/3/23
- Phantom: SAM 12; Type: SAM V4.0; Serial: TP 1202
- Measurement SW: DASY4, V4.7 Build 53; Postprocessing SW: SEMCAD, V1.8 Build 172

f=5500, d=10mm, Pin=250mW/Area Scan (7x7x1): Measurement grid: dx=10mm, dy=10mm
Maximum value of SAR (measured) = 32.6 mW/g

f=5500, d=10mm, Pin=250mW/Zoom Scan (8x8x8)/Cube 0: Measurement grid: dx=4.3mm, dy=4.3mm, dz=3mm

Reference Value = 64.7 V/m; Power Drift = -0.186 dB

Peak SAR (extrapolated) = 52.7 W/kg

SAR(1 g) = 18.6 mW/g; SAR(10 g) = 5.15 mW/g

Maximum value of SAR (measured) = 29.8 mW/g

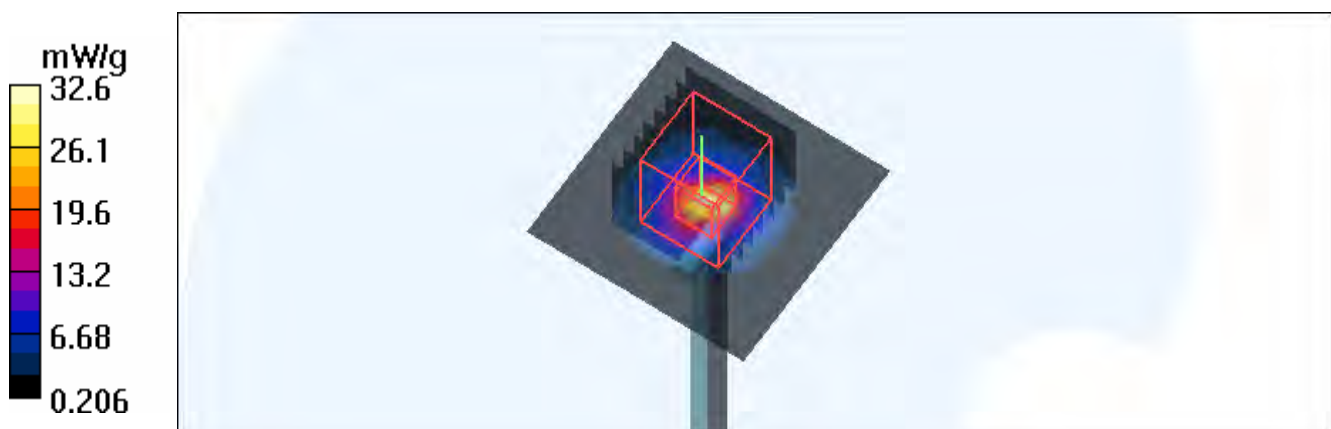

Test Laboratory: Advance Data Technology

System Validation Check-HSL 5800MHz

DUT: Dipole 5 GHz ; Type: D5GHzV2 ; Serial: 1018 ; Test Frequency: 5800 MHz

Communication System: CW ; Frequency: 5800 MHz; Duty Cycle: 1:1; Modulation type: CW
Medium: HSL5800; Medium parameters used: $f = 5800$ MHz; $\sigma = 5.36$ mho/m; $\epsilon_r = 35.7$; $\rho = 1000$ kg/m³ ;
Liquid level : 151 mm
Phantom section: Flat Section ; Separation distance : 10 mm (The feetpoint of the dipole to the Phantom)
Air temp. : 22.2 degrees ; Liquid temp. : 21.0 degrees

DASY4 Configuration:

- Probe: EX3DV3 - SN3506 ; ConvF(4.40, 4.40, 4.40) ; Calibrated: 2007/3/20
- Sensor-Surface: 3mm (Mechanical Surface Detection)
- Electronics: DAE3 Sn579; Calibrated: 2007/3/23
- Phantom: SAM 12; Type: SAM V4.0; Serial: TP 1202
- Measurement SW: DASY4, V4.7 Build 53; Postprocessing SW: SEMCAD, V1.8 Build 172

f=5800, d=10mm, Pin=250mW/Area Scan (6x6x1): Measurement grid: dx=10mm, dy=10mm
Maximum value of SAR (measured) = 21.7 mW/g

f=5800, d=10mm, Pin=250mW/Zoom Scan (8x8x8)/Cube 0: Measurement grid: dx=4.3mm, dy=4.3mm, dz=3mm

Reference Value = 61.9 V/m; Power Drift = -0.235 dB

Peak SAR (extrapolated) = 81.7 W/kg

SAR(1 g) = 18.4 mW/g; SAR(10 g) = 5.14 mW/g

Maximum value of SAR (measured) = 31.1 mW/g

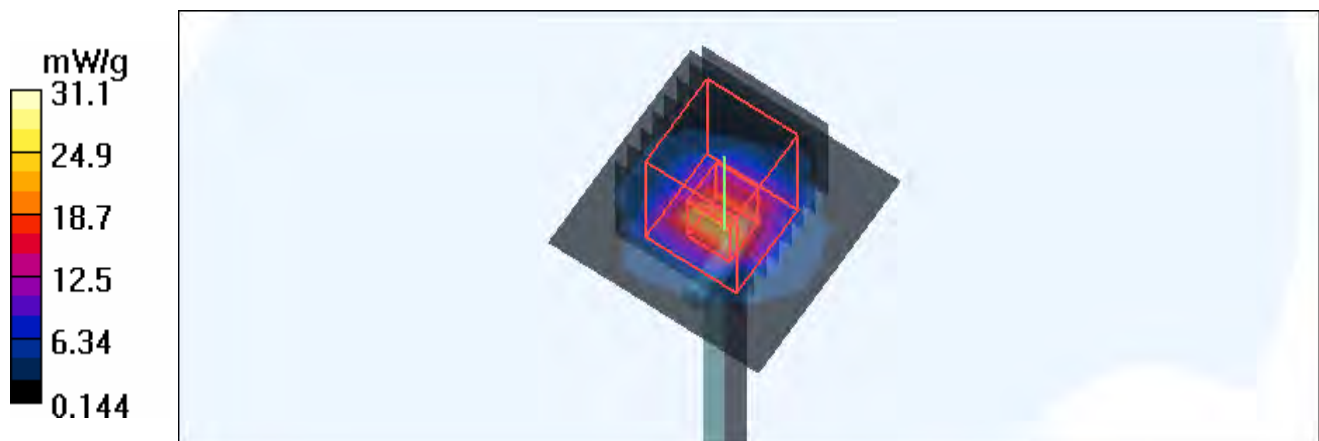

Test Laboratory: Advance Data Technology

System Validation Check-HSL 5200MHz

DUT: Dipole 5 GHz ; Type: D5GHzV2 ; Serial: 1018 ; Test Frequency: 5200 MHz

Communication System: CW ; Frequency: 5200 MHz; Duty Cycle: 1:1; Modulation type: CW
Medium: HSL5800; Medium parameters used: $f = 5200$ MHz; $\sigma = 4.66$ mho/m; $\epsilon_r = 36.3$; $\rho = 1000$ kg/m³ ;
Liquid level : 151 mm
Phantom section: Flat Section ; Separation distance : 10 mm (The feetpoint of the dipole to the Phantom)
Air temp. : 22.4 degrees ; Liquid temp. : 21.3 degrees

DASY4 Configuration:

- Probe: EX3DV3 - SN3506 ; ConvF(4.92, 4.92, 4.92) ; Calibrated: 2007/3/20
- Sensor-Surface: 3mm (Mechanical Surface Detection)
- Electronics: DAE3 Sn579; Calibrated: 2007/3/23
- Phantom: SAM 12; Type: SAM V4.0; Serial: TP 1202
- Measurement SW: DASY4, V4.7 Build 53; Postprocessing SW: SEMCAD, V1.8 Build 172

f=5200, d=10mm, Pin=250mW/Area Scan (6x6x1): Measurement grid: dx=10mm, dy=10mm
Maximum value of SAR (measured) = 20.8 mW/g

f=5200, d=10mm, Pin=250mW/Zoom Scan (8x8x8)/Cube 0: Measurement grid: dx=4.3mm, dy=4.3mm, dz=3mm

Reference Value = 65.5 V/m; Power Drift = -0.232 dB

Peak SAR (extrapolated) = 59.1 W/kg

SAR(1 g) = 19.2 mW/g; SAR(10 g) = 5.3 mW/g

Maximum value of SAR (measured) = 32.0 mW/g

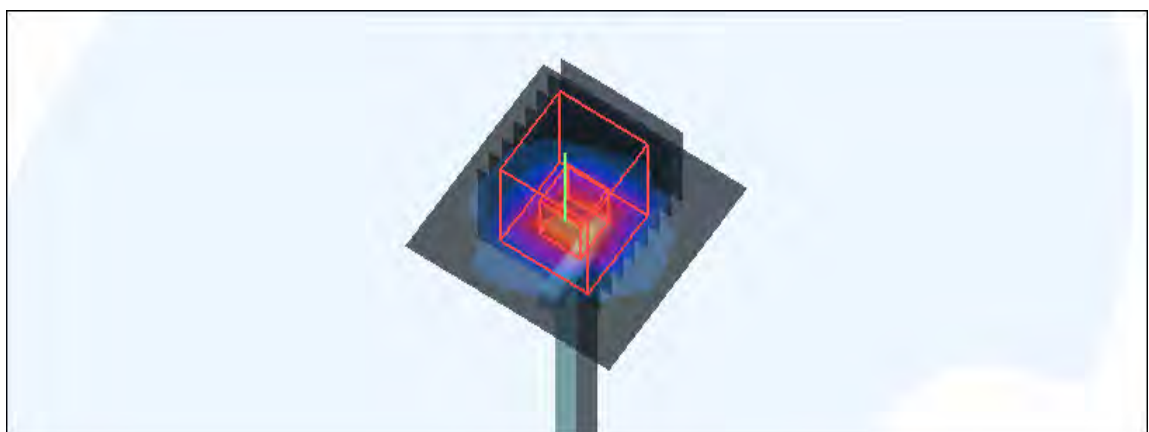
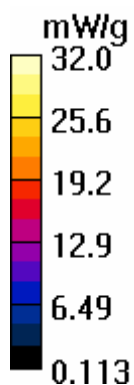

Test Laboratory: Advance Data Technology

System Validation Check-HSL 5500MHz

DUT: Dipole 5 GHz ; Type: D5GHzV2 ; Serial: 1018 ; Test Frequency: 5500 MHz

Communication System: CW ; Frequency: 5500 MHz; Duty Cycle: 1:1; Modulation type: CW
Medium: HSL5800; Medium parameters used: $f = 5500$ MHz; $\sigma = 5.02$ mho/m; $\epsilon_r = 35.8$; $\rho = 1000$ kg/m³ ;
Liquid level : 151 mm
Phantom section: Flat Section ; Separation distance : 10 mm (The feetpoint of the dipole to the Phantom)
Air temp. : 22.4 degrees ; Liquid temp. : 21.3 degrees

DASY4 Configuration:

- Probe: EX3DV3 - SN3506 ; ConvF(4.55, 4.55, 4.55) ; Calibrated: 2007/3/20
- Sensor-Surface: 3mm (Mechanical Surface Detection)
- Electronics: DAE3 Sn579; Calibrated: 2007/3/23
- Phantom: SAM 12; Type: SAM V4.0; Serial: TP 1202
- Measurement SW: DASY4, V4.7 Build 53; Postprocessing SW: SEMCAD, V1.8 Build 172

f=5500, d=10mm, Pin=250mW/Area Scan (7x7x1): Measurement grid: dx=10mm, dy=10mm
Maximum value of SAR (measured) = 31.9 mW/g

f=5500, d=10mm, Pin=250mW/Zoom Scan (8x8x8)/Cube 0: Measurement grid: dx=4.3mm, dy=4.3mm, dz=3mm

Reference Value = 64.2 V/m; Power Drift = -0.208 dB

Peak SAR (extrapolated) = 51.6 W/kg

SAR(1 g) = 18.2 mW/g; SAR(10 g) = 5.07 mW/g

Maximum value of SAR (measured) = 29.2 mW/g

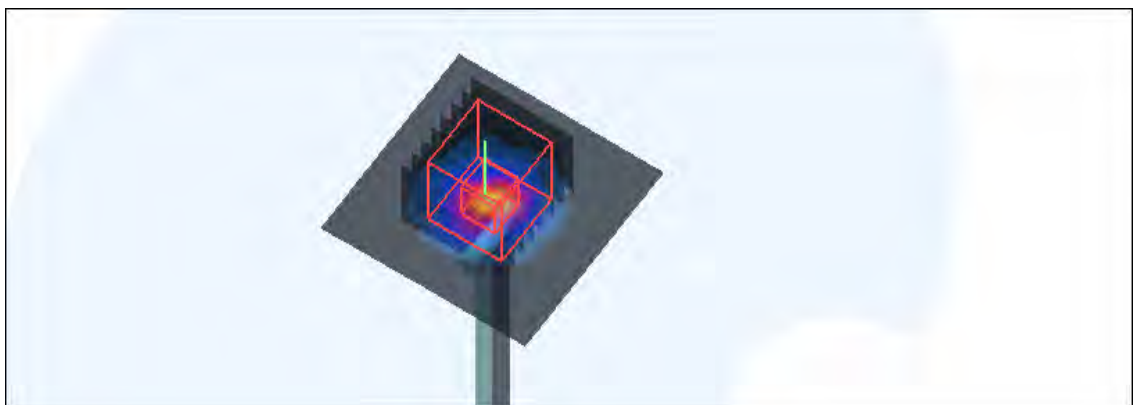
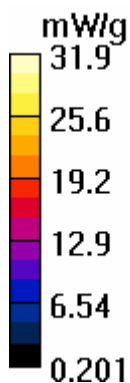

Test Laboratory: Advance Data Technology

System Validation Check-HSL 5800MHz

DUT: Dipole 5 GHz ; Type: D5GHzV2 ; Serial: 1018 ; Test Frequency: 5800 MHz

Communication System: CW ; Frequency: 5800 MHz; Duty Cycle: 1:1; Modulation type: CW
Medium: HSL5800; Medium parameters used: $f = 5800$ MHz; $\sigma = 5.4$ mho/m; $\epsilon_r = 35.3$; $\rho = 1000$ kg/m³ ;
Liquid level : 151 mm
Phantom section: Flat Section ; Separation distance : 10 mm (The feetpoint of the dipole to the Phantom)
Air temp. : 22.4 degrees ; Liquid temp. : 21.3 degrees

DASY4 Configuration:

- Probe: EX3DV3 - SN3506 ; ConvF(4.40, 4.40, 4.40) ; Calibrated: 2007/3/20
- Sensor-Surface: 3mm (Mechanical Surface Detection)
- Electronics: DAE3 Sn579; Calibrated: 2007/3/23
- Phantom: SAM 12; Type: SAM V4.0; Serial: TP 1202
- Measurement SW: DASY4, V4.7 Build 53; Postprocessing SW: SEMCAD, V1.8 Build 172

f=5800, d=10mm , Pin=250mW/Area Scan (7x7x1): Measurement grid: dx=10mm, dy=10mm
Maximum value of SAR (measured) = 32.4 mW/g

f=5800, d=10mm , Pin=250mW/Zoom Scan (8x8x8)/Cube 0: Measurement grid: dx=4.3mm, dy=4.3mm, dz=3mm

Reference Value = 63.1 V/m; Power Drift = -0.139 dB

Peak SAR (extrapolated) = 82.2 W/kg

SAR(1 g) = 18.7 mW/g; SAR(10 g) = 5.11 mW/g

Maximum value of SAR (measured) = 31.2 mW/g

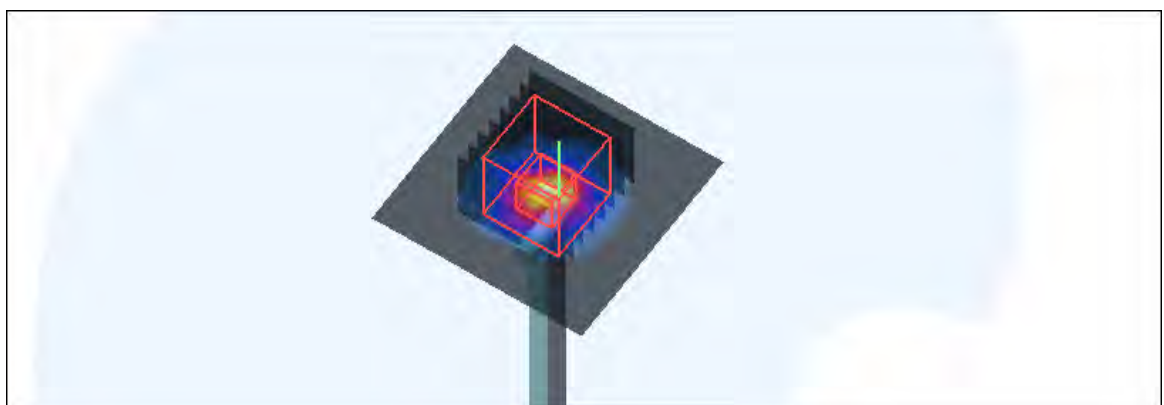
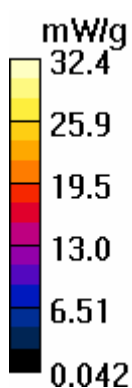

Test Laboratory: Advance Data Technology

System Validation Check-MSL 5200MHz

DUT: Dipole 5 GHz ; Type: D5GHzV2 ; Serial: 1018 ; Test Frequency: 5200 MHz

Communication System: CW ; Frequency: 5200 MHz; Duty Cycle: 1:1; Modulation type: CW
Medium: MSL5800; Medium parameters used: $f = 5200$ MHz; $\sigma = 5.27$ mho/m; $\epsilon_r = 49.5$; $\rho = 1000$ kg/m³ ; Liquid level : 150 mm

Phantom section: Flat Section ; Separation distance : 10 mm (The feetpoint of the dipole to the Phantom) Air temp. : 22.5 degrees ; Liquid temp. : 21.3 degrees

DASY4 Configuration:

- Probe: EX3DV3 - SN3506 ; ConvF(4.48, 4.48, 4.48) ; Calibrated: 2007/3/20
- Sensor-Surface: 3mm (Mechanical Surface Detection)
- Electronics: DAE3 Sn579; Calibrated: 2007/3/23
- Phantom: SAM 12; Type: SAM V4.0; Serial: TP 1202
- Measurement SW: DASY4, V4.7 Build 53; Postprocessing SW: SEMCAD, V1.8 Build 172

f=5200, d=10mm, Pin=250mW/Area Scan (6x6x1): Measurement grid: dx=10mm, dy=10mm
Maximum value of SAR (measured) = 22.3 mW/g

f=5200, d=10mm, Pin=250mW/Zoom Scan (8x8x8)/Cube 0: Measurement grid: dx=4.3mm, dy=4.3mm, dz=3mm

Reference Value = 77.3 V/m; Power Drift = -0.207 dB

Peak SAR (extrapolated) = 53.4 W/kg

SAR(1 g) = 18.9 mW/g; SAR(10 g) = 5.21 mW/g

Maximum value of SAR (measured) = 30.6 mW/g

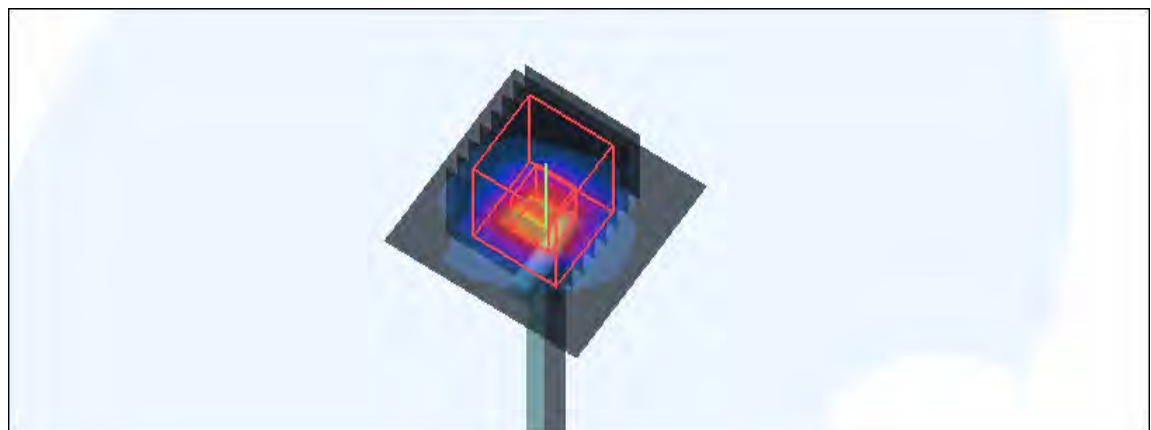
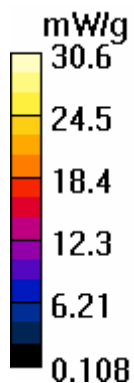

Test Laboratory: Advance Data Technology

System Validation Check-MSL 5500MHz

DUT: Dipole 5 GHz ; Type: D5GHzV2 ; Serial: 1018 ; Test Frequency: 5500 MHz

Communication System: CW ; Frequency: 5500 MHz; Duty Cycle: 1:1; Modulation type: CW
Medium: MSL5800; Medium parameters used: $f = 5500$ MHz; $\sigma = 5.71$ mho/m; $\epsilon_r = 48.9$; $\rho = 1000$ kg/m³ ; Liquid level : 150 mm
Phantom section: Flat Section ; Separation distance : 10 mm (The feetpoint of the dipole to the Phantom) Air temp. : 22.5 degrees ; Liquid temp. : 21.3 degrees

DASY4 Configuration:

- Probe: EX3DV3 - SN3506 ; ConvF(4.11, 4.11, 4.11) ; Calibrated: 2007/3/20
- Sensor-Surface: 3mm (Mechanical Surface Detection)
- Electronics: DAE3 Sn579; Calibrated: 2007/3/23
- Phantom: SAM 12; Type: SAM V4.0; Serial: TP 1202
- Measurement SW: DASY4, V4.7 Build 53; Postprocessing SW: SEMCAD, V1.8 Build 172

f=5500, d=10mm, Pin=250mW/Area Scan (7x7x1): Measurement grid: dx=10mm, dy=10mm
Maximum value of SAR (measured) = 31.9 mW/g

f=5500, d=10mm, Pin=250mW/Zoom Scan (8x8x8)/Cube 0: Measurement grid: dx=4.3mm, dy=4.3mm, dz=3mm

Reference Value = 79.6 V/m; Power Drift = -0.219 dB

Peak SAR (extrapolated) = 61.5 W/kg

SAR(1 g) = 18.8 mW/g; SAR(10 g) = 5.19 mW/g

Maximum value of SAR (measured) = 31.6 mW/g

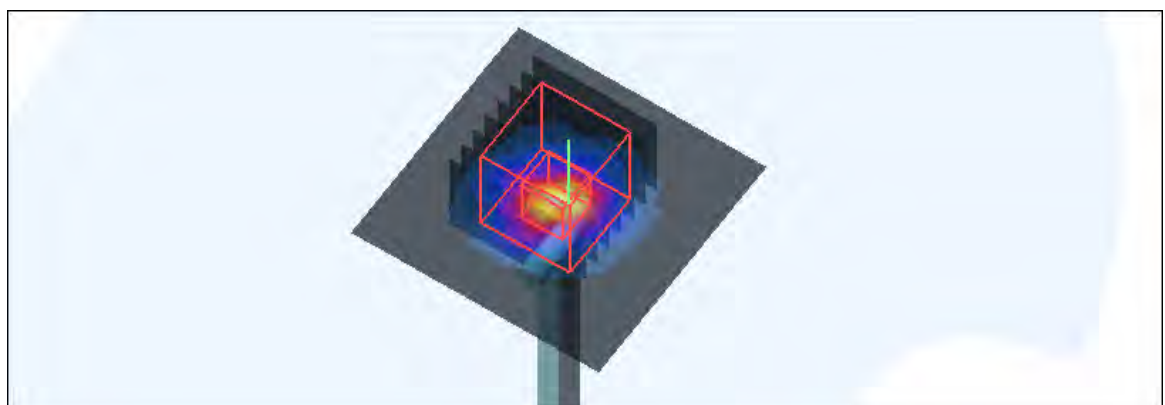
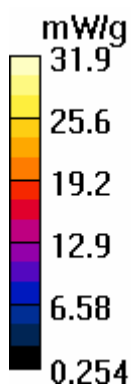

Test Laboratory: Advance Data Technology

System Validation Check-MSL 5800MHz

DUT: Dipole 5 GHz ; Type: D5GHzV2 ; Serial: 1018 ; Test Frequency: 5800 MHz

Communication System: CW ; Frequency: 5800 MHz; Duty Cycle: 1:1; Modulation type: CW
Medium: MSL5800; Medium parameters used: $f = 5800$ MHz; $\sigma = 6.15$ mho/m; $\epsilon_r = 48.3$; $\rho = 1000$ kg/m³ ; Liquid level : 150 mm

Phantom section: Flat Section ; Separation distance : 10 mm (The feetpoint of the dipole to the Phantom) Air temp. : 22.5 degrees ; Liquid temp. : 21.3 degrees

DASY4 Configuration:

- Probe: EX3DV3 - SN3506 ; ConvF(4.2, 4.2, 4.2) ; Calibrated: 2007/3/20
- Sensor-Surface: 3mm (Mechanical Surface Detection)
- Electronics: DAE3 Sn579; Calibrated: 2007/3/23
- Phantom: SAM 12; Type: SAM V4.0; Serial: TP 1202
- Measurement SW: DASY4, V4.7 Build 53; Postprocessing SW: SEMCAD, V1.8 Build 172

f=5800, d=10mm, Pin=250mW/Area Scan (6x6x1): Measurement grid: dx=10mm, dy=10mm
Maximum value of SAR (measured) = 19.2 mW/g

f=5800, d=10mm, Pin=250mW/Zoom Scan (8x8x8)/Cube 0: Measurement grid: dx=4.3mm, dy=4.3mm, dz=3mm

Reference Value = 71.3 V/m; Power Drift = -0.210 dB

Peak SAR (extrapolated) = 64.7 W/kg

SAR(1 g) = 16.9 mW/g; SAR(10 g) = 4.64 mW/g

Maximum value of SAR (measured) = 26.8 mW/g

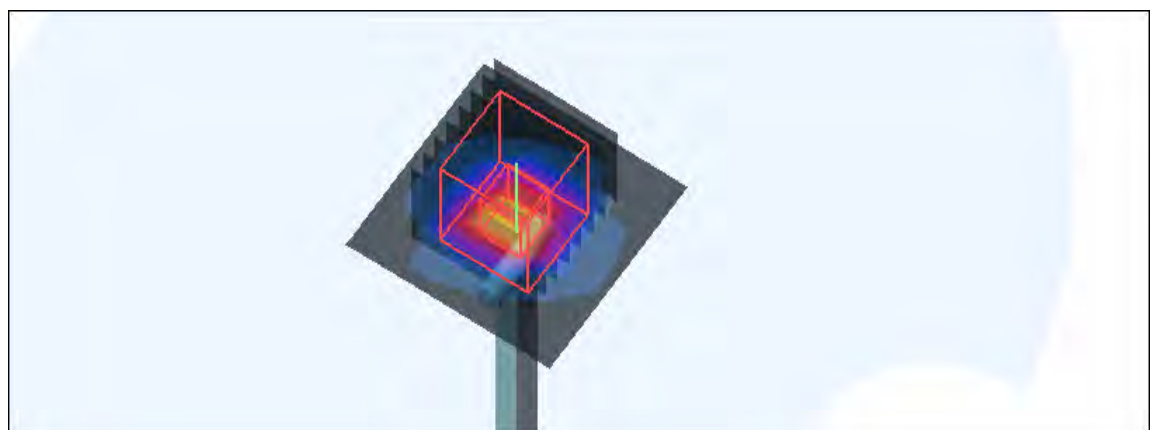
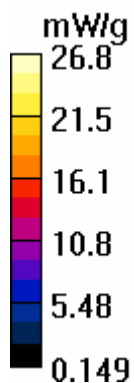

APPENDIX B: ADT SAR MEASUREMENT SYSTEM



APPENDIX C: PHOTOGRAPHS OF SYSTEM VALIDATION

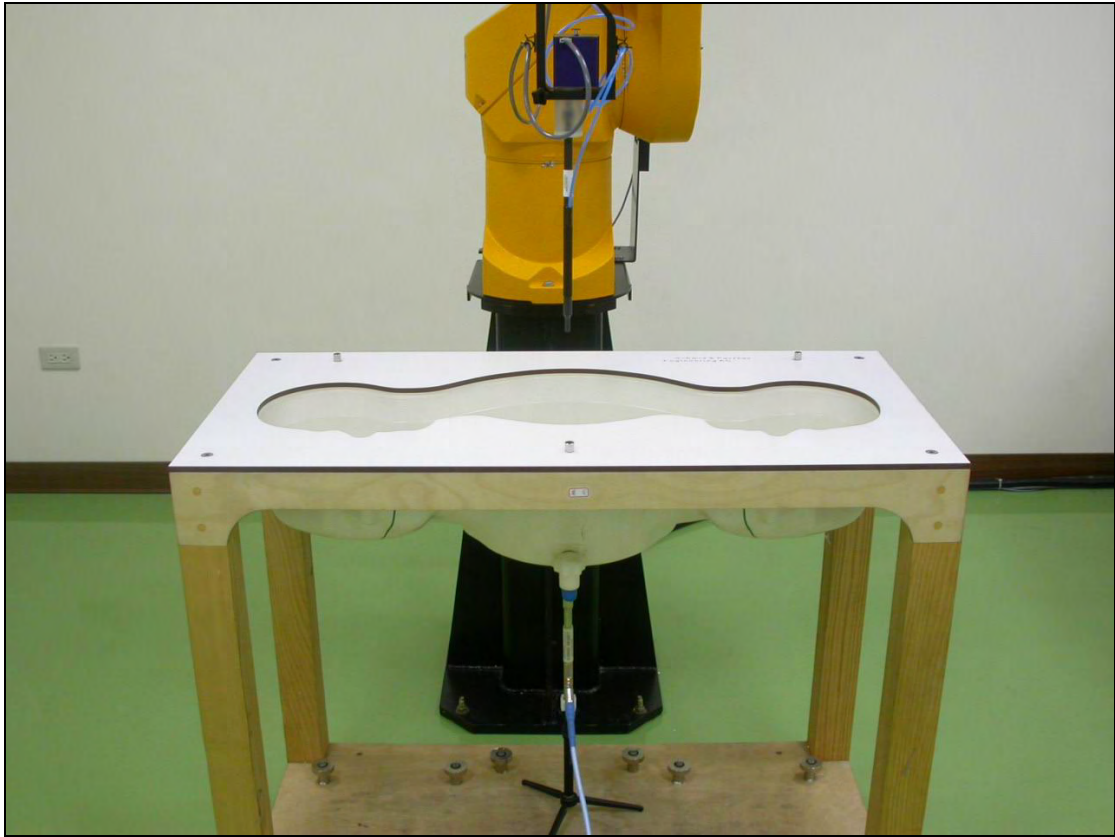



APPENDIX D: SYSTEM CERTIFICATE & CALIBRATION

D1: SAM PHANTOM

Schmid & Partner Engineering AG

Zeughausstrasse 43, 8004 Zurich, Switzerland, Phone +41 1 245 97 00, Fax +41 1 245 97 79

Certificate of conformity / First Article Inspection

Item	SAM Twin Phantom V4.0
Type No	QD 000 P40 CA
Series No	TP-1150 and higher
Manufacturer / Origin	Untersee Composites Hauptstr. 69 CH-8559 Fruthwilen Switzerland

Tests

The series production process used allows the limitation to test of first articles. Complete tests were made on the pre-series Type No. QD 000 P40 AA, Serial No. TP-1001 and on the series first article Type No. QD 000 P40 BA, Serial No. TP-1006. Certain parameters have been retested using further series units (called samples).

Test	Requirement	Details	Units tested
Shape	Compliance with the geometry according to the CAD model.	IT'IS CAD File (*)	First article, Samples
Material thickness	Compliant with the requirements according to the standards	2mm +/- 0.2mm in specific areas	First article, Samples
Material parameters	Dielectric parameters for required frequencies	200 MHz – 3 GHz Relative permittivity < 5 Loss tangent < 0.05.	Material sample TP 104-5
Material resistivity	The material has been tested to be compatible with the liquids defined in the standards	Liquid type HSL 1800 and others according to the standard.	Pre-series, First article

Standards

- [1] CENELEC EN 50361
- [2] IEEE P1528-200x draft 6.5
- [3] IEC PT 62209 draft 0.9

(*) The IT'IS CAD file is derived from [2] and is also within the tolerance requirements of the shapes of [1] and [3].

Conformity

Based on the sample tests above, we certify that this item is in compliance with the uncertainty requirements of SAR measurements specified in standard [1] and draft standards [2] and [3].

Date 28.02.2002

Signature / Stamp

F. Bombault

**Schmid & Partner
Engineering AG**

Zeughausstrasse 43, CH-8004 Zurich
Tel. +41 1 245 97 00, Fax +41 1 245 97 79

Johannes Kofler



D2: DOSIMETRIC E-FIELD PROBE



Accredited by the Swiss Federal Office of Metrology and Accreditation
The Swiss Accreditation Service is one of the signatories to the EA
Multilateral Agreement for the recognition of calibration certificates

Accreditation No.: **SCS 108**

Client **ADT (Auden)**

Certificate No: **EX3-3506_Mar07**

CALIBRATION CERTIFICATE

Object **EX3DV3 - SN:3506**

Calibration procedure(s) **QA CAL-01.v5 and QA CAL-14.v3
Calibration procedure for dosimetric E-field probes**

Calibration date: **March 20, 2007**

Condition of the calibrated item **In Tolerance**

This calibration certificate documents the traceability to national standards, which realize the physical units of measurements (SI).
The measurements and the uncertainties with confidence probability are given on the following pages and are part of the certificate.

All calibrations have been conducted in the closed laboratory facility: environment temperature (22 ± 3)°C and humidity < 70%.

Calibration Equipment used (M&TE critical for calibration)

Primary Standards	ID #	Cal Date (Calibrated by, Certificate No.)	Scheduled Calibration
Power meter E4419B	GB41293874	5-Apr-06 (METAS, No. 251-00557)	Apr-07
Power sensor E4412A	MY41495277	5-Apr-06 (METAS, No. 251-00557)	Apr-07
Power sensor E4412A	MY41498087	5-Apr-06 (METAS, No. 251-00557)	Apr-07
Reference 3 dB Attenuator	SN: S5054 (3c)	10-Aug-06 (METAS, No. 217-00592)	Aug-07
Reference 20 dB Attenuator	SN: S5086 (20b)	4-Apr-06 (METAS, No. 251-00558)	Apr-07
Reference 30 dB Attenuator	SN: S5129 (30b)	10-Aug-06 (METAS, No. 217-00593)	Aug-07
Reference Probe ES3DV2	SN: 3013	4-Jan-07 (SPEAG, No. ES3-3013_Jan07)	Jan-08
DAE4	SN: 654	21-Jun-06 (SPEAG, No. DAE4-654_Jun06)	Jun-07
Secondary Standards	ID #	Check Date (in house)	Scheduled Check
RF generator HP 8648C	US3642U01700	4-Aug-99 (SPEAG, in house check Nov-05)	In house check: Nov-07
Network Analyzer HP 8753E	US37390585	18-Oct-01 (SPEAG, in house check Oct-06)	In house check: Oct-07

	Name	Function	Signature
Calibrated by:	Katja Pokovic	Technical Manager	
Approved by:	Fin Bomholt	R&D Director	

Issued: March 21, 2007

This calibration certificate shall not be reproduced except in full without written approval of the laboratory.



Accredited by the Swiss Federal Office of Metrology and Accreditation
The Swiss Accreditation Service is one of the signatories to the EA
Multilateral Agreement for the recognition of calibration certificates

Accreditation No.: **SCS 108**

Glossary:

TSL	tissue simulating liquid
NORM _{x,y,z}	sensitivity in free space
ConF	sensitivity in TSL / NORM _{x,y,z}
DCP	diode compression point
Polarization ϕ	ϕ rotation around probe axis
Polarization ϑ	ϑ rotation around an axis that is in the plane normal to probe axis (at measurement center), i.e., $\vartheta = 0$ is normal to probe axis

Calibration is Performed According to the Following Standards:

- IEEE Std 1528-2003, "IEEE Recommended Practice for Determining the Peak Spatial-Averaged Specific Absorption Rate (SAR) in the Human Head from Wireless Communications Devices: Measurement Techniques", December 2003
- IEC 62209-1, "Procedure to measure the Specific Absorption Rate (SAR) for hand-held devices used in close proximity to the ear (frequency range of 300 MHz to 3 GHz)", February 2005

Methods Applied and Interpretation of Parameters:

- NORM_{x,y,z}**: Assessed for E-field polarization $\vartheta = 0$ ($f \leq 900$ MHz in TEM-cell; $f > 1800$ MHz: R22 waveguide). NORM_{x,y,z} are only intermediate values, i.e., the uncertainties of NORM_{x,y,z} does not effect the E²-field uncertainty inside TSL (see below *ConvF*).
- NORM(f)_{x,y,z} = NORM_{x,y,z} * frequency_response** (see Frequency Response Chart). This linearization is implemented in DASY4 software versions later than 4.2. The uncertainty of the frequency response is included in the stated uncertainty of *ConvF*.
- DCP_{x,y,z}**: DCP are numerical linearization parameters assessed based on the data of power sweep (no uncertainty required). DCP does not depend on frequency nor media.
- ConvF and Boundary Effect Parameters**: Assessed in flat phantom using E-field (or Temperature Transfer Standard for $f \leq 800$ MHz) and inside waveguide using analytical field distributions based on power measurements for $f > 800$ MHz. The same setups are used for assessment of the parameters applied for boundary compensation (alpha, depth) of which typical uncertainty values are given. These parameters are used in DASY4 software to improve probe accuracy close to the boundary. The sensitivity in TSL corresponds to NORM_{x,y,z} * *ConvF* whereby the uncertainty corresponds to that given for *ConvF*. A frequency dependent *ConvF* is used in DASY version 4.4 and higher which allows extending the validity from ± 50 MHz to ± 100 MHz.
- Spherical isotropy (3D deviation from isotropy)**: in a field of low gradients realized using a flat phantom exposed by a patch antenna.
- Sensor Offset**: The sensor offset corresponds to the offset of virtual measurement center from the probe tip (on probe axis). No tolerance required.

Probe EX3DV3

SN:3506

Manufactured:	February 18, 2004
Last calibrated:	April 20, 2006
Recalibrated:	March 20, 2007

Calibrated for DASY Systems

(Note: non-compatible with DASY2 system!)

DASY - Parameters of Probe: EX3DV3 SN:3506**Sensitivity in Free Space^A****Diode Compression^B**

NormX	0.810 ± 10.1%	$\mu\text{V}/(\text{V}/\text{m})^2$	DCP X	97 mV
NormY	0.880 ± 10.1%	$\mu\text{V}/(\text{V}/\text{m})^2$	DCP Y	94 mV
NormZ	0.810 ± 10.1%	$\mu\text{V}/(\text{V}/\text{m})^2$	DCP Z	92 mV

Sensitivity in Tissue Simulating Liquid (Conversion Factors)

Please see Page 8.

Boundary Effect**TSL 900 MHz Typical SAR gradient: 5 % per mm**

Sensor Center to Phantom Surface Distance		2.0 mm	3.0 mm
SAR _{be} [%]	Without Correction Algorithm	3.4	1.1
SAR _{be} [%]	With Correction Algorithm	0.0	0.1

TSL 1750 MHz Typical SAR gradient: 10 % per mm

Sensor Center to Phantom Surface Distance		2.0 mm	3.0 mm
SAR _{be} [%]	Without Correction Algorithm	4.6	2.7
SAR _{be} [%]	With Correction Algorithm	0.2	0.4

Sensor OffsetProbe Tip to Sensor Center **1.0 mm**

The reported uncertainty of measurement is stated as the standard uncertainty of measurement multiplied by the coverage factor k=2, which for a normal distribution corresponds to a coverage probability of approximately 95%.

^A The uncertainties of NormX,Y,Z do not affect the E²-field uncertainty inside TSL (see Page 8).^B Numerical linearization parameter: uncertainty not required.

Frequency Response of E-Field

(TEM-Cell:ifi110 EXX, Waveguide: R22)

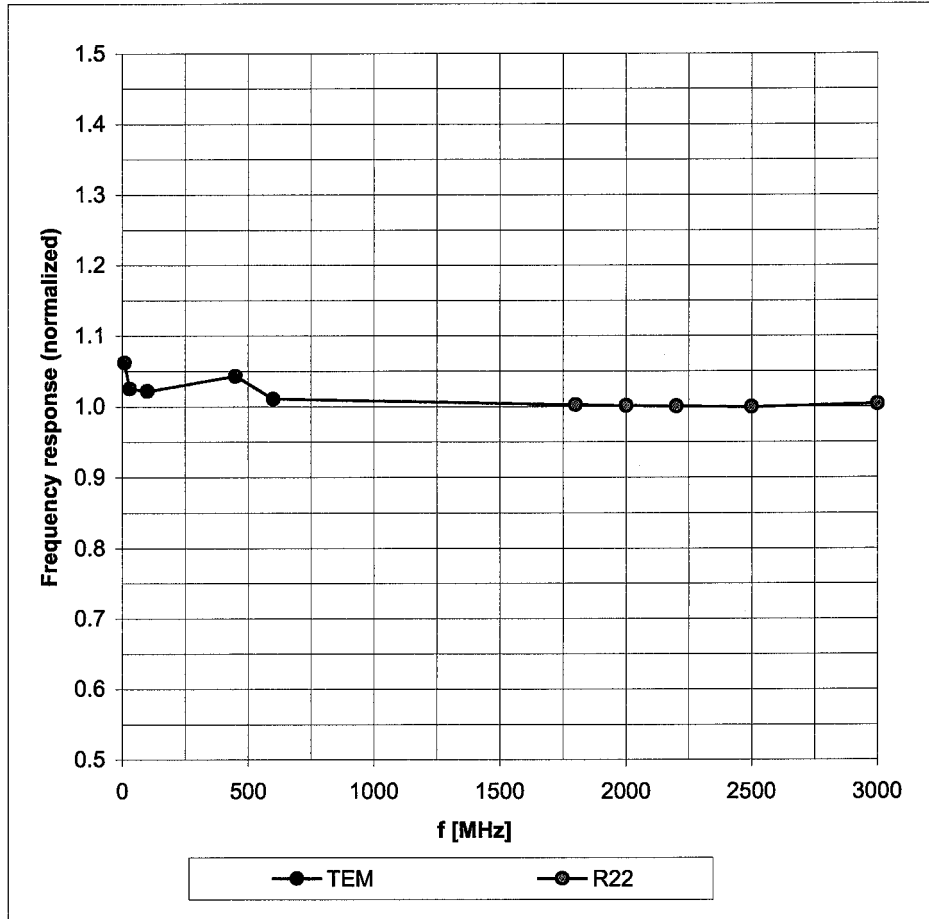

Uncertainty of Frequency Response of E-field: $\pm 6.3\%$ (k=2)

Receiving Pattern (ϕ), $\vartheta = 0^\circ$

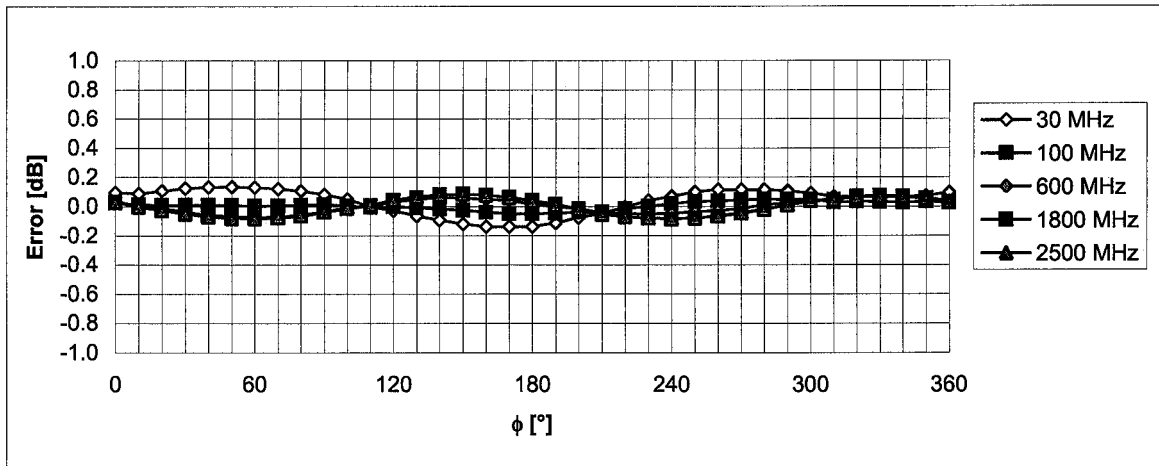
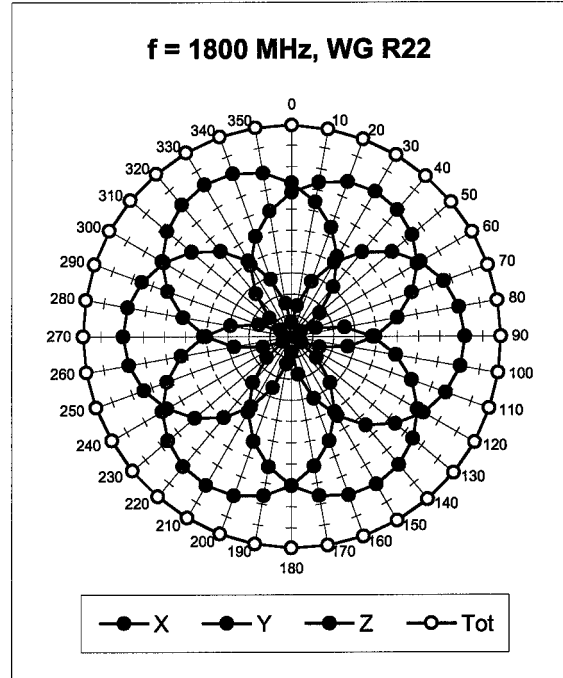
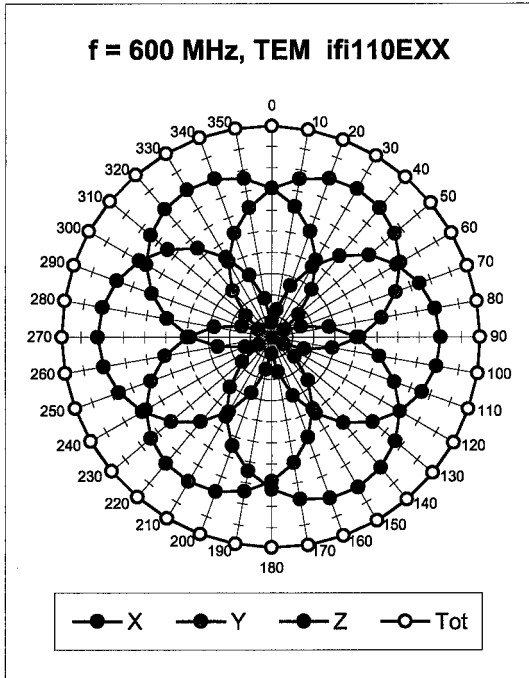

Uncertainty of Axial Isotropy Assessment: $\pm 0.5\%$ ($k=2$)

Dynamic Range $f(\text{SAR}_{\text{head}})$ (Waveguide R22, $f = 1800 \text{ MHz}$)

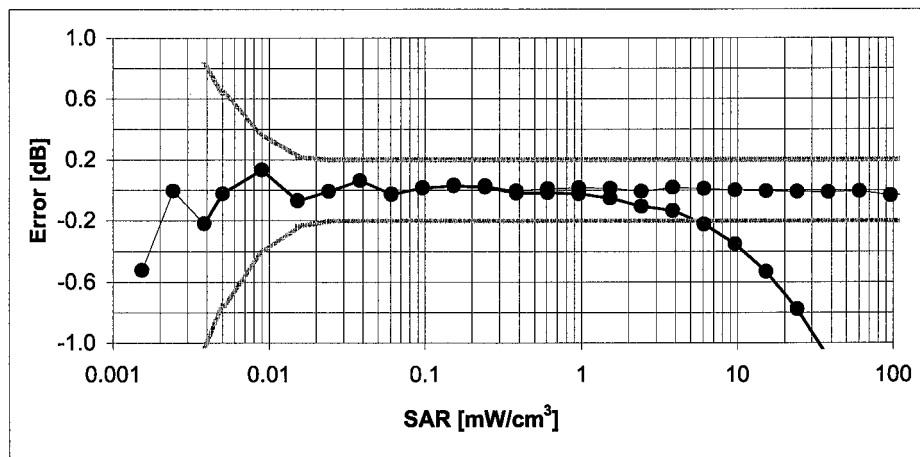
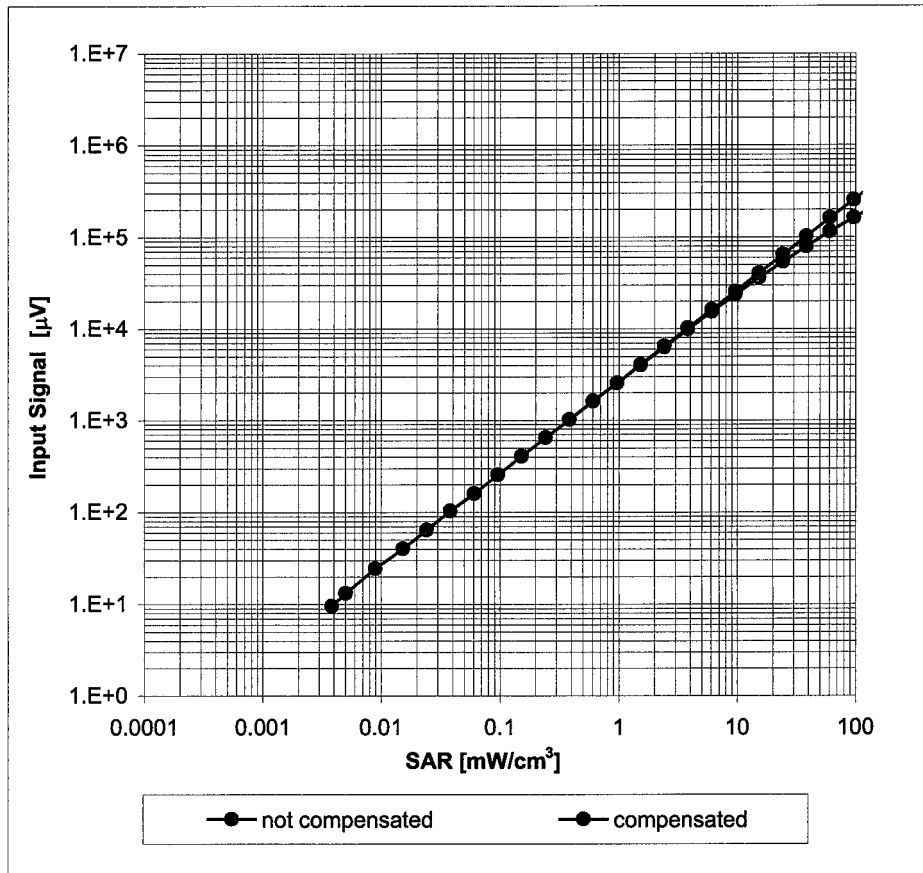

Uncertainty of Linearity Assessment: $\pm 0.6\%$ ($k=2$)

Conversion Factor Assessment

f [MHz]	Validity [MHz] ^c	TSL	Permittivity	Conductivity	Alpha	Depth	ConvF Uncertainty
900	± 50 / ± 100	Head	41.5 ± 5%	0.97 ± 5%	0.45	0.80	9.77 ± 11.0% (k=2)
1750	± 50 / ± 100	Head	40.1 ± 5%	1.37 ± 5%	0.19	1.20	8.48 ± 11.0% (k=2)
1950	± 50 / ± 100	Head	40.0 ± 5%	1.40 ± 5%	0.18	1.29	8.12 ± 11.0% (k=2)
2450	± 50 / ± 100	Head	39.2 ± 5%	1.80 ± 5%	0.39	1.00	7.80 ± 11.8% (k=2)
4950	± 50 / ± 100	Head	36.3 ± 5%	4.40 ± 5%	0.35	1.75	5.54 ± 13.1% (k=2)
5200	± 50 / ± 100	Head	36.0 ± 5%	4.66 ± 5%	0.35	1.75	4.92 ± 13.1% (k=2)
5300	± 50 / ± 100	Head	35.9 ± 5%	4.76 ± 5%	0.33	1.75	4.77 ± 13.1% (k=2)
5500	± 50 / ± 100	Head	35.6 ± 5%	4.96 ± 5%	0.35	1.75	4.55 ± 13.1% (k=2)
5800	± 50 / ± 100	Head	35.3 ± 5%	5.27 ± 5%	0.35	1.75	4.40 ± 13.1% (k=2)
900	± 50 / ± 100	Body	55.0 ± 5%	1.05 ± 5%	0.50	0.80	9.89 ± 11.0% (k=2)
1750	± 50 / ± 100	Body	53.4 ± 5%	1.49 ± 5%	0.18	1.16	8.72 ± 11.0% (k=2)
1950	± 50 / ± 100	Body	53.3 ± 5%	1.52 ± 5%	0.14	1.45	8.09 ± 11.0% (k=2)
2300	± 50 / ± 100	Body	52.8 ± 5%	1.85 ± 5%	0.42	1.00	7.92 ± 11.8% (k=2)
2450	± 50 / ± 100	Body	52.7 ± 5%	1.95 ± 5%	0.42	1.00	7.67 ± 11.8% (k=2)
2600	± 50 / ± 100	Body	52.5 ± 5%	2.16 ± 5%	0.42	1.00	7.28 ± 11.8% (k=2)
3500	± 50 / ± 100	Body	51.3 ± 5%	3.31 ± 5%	0.49	0.88	6.80 ± 13.1% (k=2)
4950	± 50 / ± 100	Body	49.4 ± 5%	5.01 ± 5%	0.37	1.80	4.66 ± 13.1% (k=2)
5200	± 50 / ± 100	Body	49.0 ± 5%	5.30 ± 5%	0.37	1.80	4.48 ± 13.1% (k=2)
5300	± 50 / ± 100	Body	48.5 ± 5%	5.42 ± 5%	0.35	1.80	4.14 ± 13.1% (k=2)
5500	± 50 / ± 100	Body	48.6 ± 5%	5.65 ± 5%	0.33	1.80	4.11 ± 13.1% (k=2)
5800	± 50 / ± 100	Body	48.2 ± 5%	6.00 ± 5%	0.30	1.80	4.20 ± 13.1% (k=2)

^c The validity of ± 100 MHz only applies for DASY v4.4 and higher (see Page 2). The uncertainty is the RSS of the ConvF uncertainty at calibration frequency and the uncertainty for the indicated frequency band.

Deviation from Isotropy in HSL

Error (ϕ , ϑ), $f = 900$ MHz

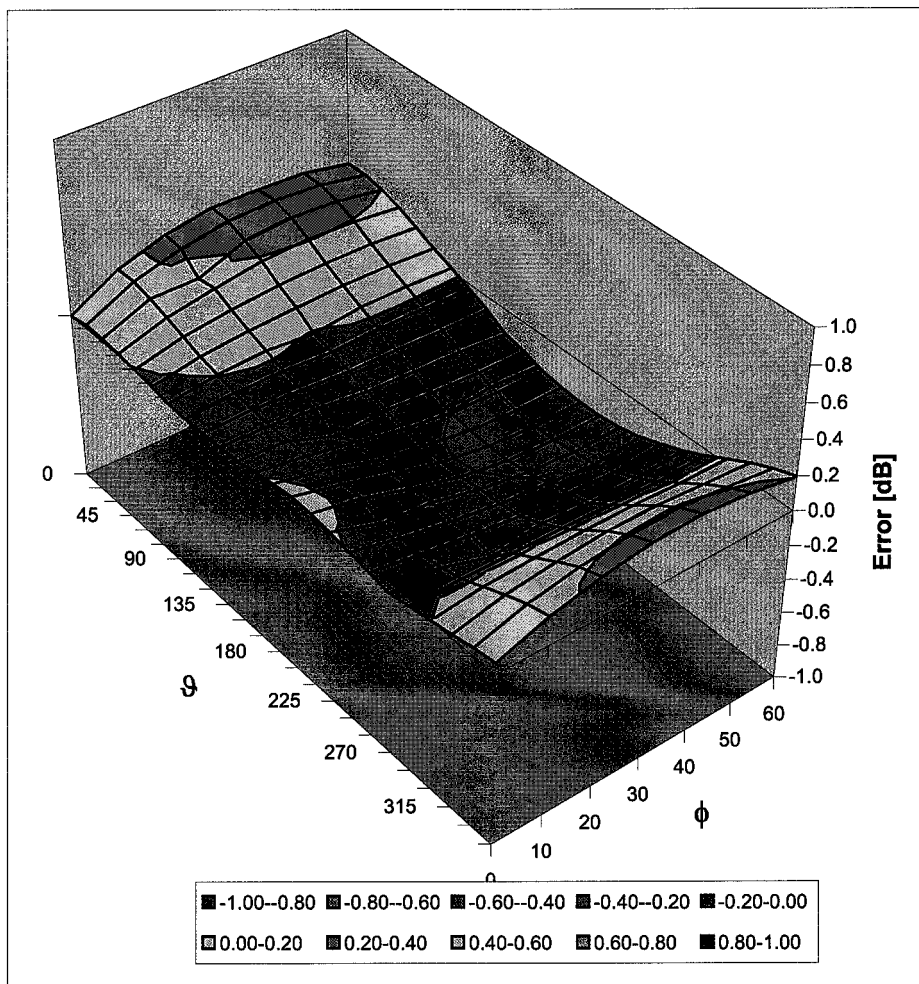

Uncertainty of Spherical Isotropy Assessment: $\pm 2.6\%$ ($k=2$)



D3: DAE



Accredited by the Swiss Federal Office of Metrology and Accreditation
The Swiss Accreditation Service is one of the signatories to the EA
Multilateral Agreement for the recognition of calibration certificates

Accreditation No.: **SCS 108**

Client **ADT (Auden)**

Certificate No: **DAE3-579_Mar07**

CALIBRATION CERTIFICATE

Object **DAE3 - SD 000 D03 AA - SN: 579**

Calibration procedure(s) **QA CAL-06.v12
Calibration procedure for the data acquisition electronics (DAE)**

Calibration date: **March 23, 2007**

Condition of the calibrated item **In Tolerance**

This calibration certificate documents the traceability to national standards, which realize the physical units of measurements (SI).
The measurements and the uncertainties with confidence probability are given on the following pages and are part of the certificate.

All calibrations have been conducted in the closed laboratory facility: environment temperature $(22 \pm 3)^\circ\text{C}$ and humidity $< 70\%$.

Calibration Equipment used (M&TE critical for calibration)

Primary Standards	ID #	Cal Date (Calibrated by, Certificate No.)	Scheduled Calibration
Fluke Process Calibrator Type 702	SN: 6295803	13-Oct-06 (Elcal AG, No: 5492)	Oct-07
Keithley Multimeter Type 2001	SN: 0810278	03-Oct-06 (Elcal AG, No: 5478)	Oct-07
Secondary Standards	ID #	Check Date (in house)	Scheduled Check
Calibrator Box V1.1	SE UMS 006 AB 1002	15-Jun-06 (SPEAG, in house check)	In house check Jun-07

Calibrated by: **Name** Eric Hainfeld **Function** Technician **Signature**

Approved by: **Name** Fin Bornholt **Function** R&D Director

Issued: March 23, 2007

This calibration certificate shall not be reproduced except in full without written approval of the laboratory.



Accredited by the Swiss Federal Office of Metrology and Accreditation
The Swiss Accreditation Service is one of the signatories to the EA
Multilateral Agreement for the recognition of calibration certificates

Accreditation No.: **SCS 108**

Glossary

DAE data acquisition electronics
Connector angle information used in DASY system to align probe sensor X to the robot coordinate system.

Methods Applied and Interpretation of Parameters

- **DC Voltage Measurement:** Calibration Factor assessed for use in DASY system by comparison with a calibrated instrument traceable to national standards. The figure given corresponds to the full scale range of the voltmeter in the respective range.
- **Connector angle:** The angle of the connector is assessed measuring the angle mechanically by a tool inserted. Uncertainty is not required.
- The following parameters contain technical information as a result from the performance test and require no uncertainty.
- **DC Voltage Measurement Linearity:** Verification of the Linearity at +10% and -10% of the nominal calibration voltage. Influence of offset voltage is included in this measurement.
- **Common mode sensitivity:** Influence of a positive or negative common mode voltage on the differential measurement.
- **Channel separation:** Influence of a voltage on the neighbor channels not subject to an input voltage.
- **AD Converter Values with inputs shorted:** Values on the internal AD converter corresponding to zero input voltage
- **Input Offset Measurement:** Output voltage and statistical results over a large number of zero voltage measurements.
- **Input Offset Current:** Typical value for information; Maximum channel input offset current, not considering the input resistance.
- **Input resistance:** DAE input resistance at the connector, during internal auto-zeroing and during measurement.
- **Low Battery Alarm Voltage:** Typical value for information. Below this voltage, a battery alarm signal is generated.
- **Power consumption:** Typical value for information. Supply currents in various operating modes.

DC Voltage Measurement

A/D - Converter Resolution nominal

High Range: 1LSB = 6.1 μ V, full range = -100...+300 mV
Low Range: 1LSB = 61nV, full range = -1.....+3mV

DASY measurement parameters: Auto Zero Time: 3 sec; Measuring time: 3 sec

Calibration Factors	X	Y	Z
High Range	404.413 \pm 0.1% (k=2)	404.494 \pm 0.1% (k=2)	404.245 \pm 0.1% (k=2)
Low Range	3.95259 \pm 0.7% (k=2)	3.97903 \pm 0.7% (k=2)	3.93943 \pm 0.7% (k=2)

Connector Angle

Connector Angle to be used in DASY system	0 $^{\circ}$ \pm 1 $^{\circ}$
---	---------------------------------

Appendix

1. DC Voltage Linearity

High Range	Input (μV)	Reading (μV)	Error (%)
Channel X + Input	200000	200000.1	0.00
Channel X + Input	20000	20006.33	0.03
Channel X - Input	20000	-19997.11	-0.01
Channel Y + Input	200000	200000.5	0.00
Channel Y + Input	20000	20004.32	0.02
Channel Y - Input	20000	-20000.97	0.00
Channel Z + Input	200000	199999.9	0.00
Channel Z + Input	20000	20004.59	0.02
Channel Z - Input	20000	-19999.75	0.00

Low Range	Input (μV)	Reading (μV)	Error (%)
Channel X + Input	2000	2000	0.00
Channel X + Input	200	199.93	-0.03
Channel X - Input	200	-200.74	0.37
Channel Y + Input	2000	2000	0.00
Channel Y + Input	200	199.24	-0.38
Channel Y - Input	200	-200.94	0.47
Channel Z + Input	2000	2000	0.00
Channel Z + Input	200	199.04	-0.48
Channel Z - Input	200	-201.32	0.66

2. Common mode sensitivity

DASY measurement parameters: Auto Zero Time: 3 sec; Measuring time: 3 sec

	Common mode Input Voltage (mV)	High Range Average Reading (μV)	Low Range Average Reading (μV)
Channel X	200	6.88	6.91
	- 200	-5.38	-6.84
Channel Y	200	4.74	6.33
	- 200	-2.86	-7.65
Channel Z	200	8.17	8.22
	- 200	-9.67	-10.56

3. Channel separation

DASY measurement parameters: Auto Zero Time: 3 sec; Measuring time: 3 sec

	Input Voltage (mV)	Channel X (μV)	Channel Y (μV)	Channel Z (μV)
Channel X	200	-	0.28	0.44
Channel Y	200	1.03	-	2.52
Channel Z	200	-2.54	0.78	-

4. AD-Converter Values with inputs shorted

DASY measurement parameters: Auto Zero Time: 3 sec; Measuring time: 3 sec

	High Range (LSB)	Low Range (LSB)
Channel X	16336	17367
Channel Y	16187	16706
Channel Z	15808	16822

5. Input Offset Measurement

DASY measurement parameters: Auto Zero Time: 3 sec; Measuring time: 3 sec

Input 10M Ω

	Average (μ V)	min. Offset (μ V)	max. Offset (μ V)	Std. Deviation (μ V)
Channel X	-1.09	-2.34	-0.23	0.35
Channel Y	-2.38	-3.71	-1.13	0.33
Channel Z	0.31	-1.04	1.49	0.37

6. Input Offset Current

Nominal Input circuitry offset current on all channels: <25fA

7. Input Resistance

	Zeroing (MOhm)	Measuring (MOhm)
Channel X	0.2001	201.8
Channel Y	0.2001	204.8
Channel Z	0.2001	206.1

8. Low Battery Alarm Voltage (verified during pre test)

Typical values	Alarm Level (VDC)
Supply (+ Vcc)	+7.9
Supply (- Vcc)	-7.6

9. Power Consumption (verified during pre test)

Typical values	Switched off (mA)	Stand by (mA)	Transmitting (mA)
Supply (+ Vcc)	+0.0	+6	+14
Supply (- Vcc)	-0.01	-8	-9



D4: SYSTEM VALIDATION DIPOLE



Accredited by the Swiss Federal Office of Metrology and Accreditation
The Swiss Accreditation Service is one of the signatories to the EA
Multilateral Agreement for the recognition of calibration certificates

Accreditation No.: **SCS 108**

Client **ADT (Auden)**

Certificate No. **D5GHzV2-1018_Apr07**

CALIBRATION CERTIFICATE

Object **D5GHzV2 - SN: 1018**

Calibration procedure(s) **QA CAL-22.v1
Calibration procedure for dipole validation kits between 3-6 GHz**

Calibration date: **April 19, 2007**

Condition of the calibrated item **In Tolerance**

This calibration certificate documents the traceability to national standards, which realize the physical units of measurements (SI).
The measurements and the uncertainties with confidence probability are given on the following pages and are part of the certificate.

All calibrations have been conducted in the closed laboratory facility: environment temperature (22 ± 3)°C and humidity < 70%.

Calibration Equipment used (M&TE critical for calibration)

Primary Standards	ID #	Cal Date (Calibrated by, Certificate No.)	Scheduled Calibration
Power meter E4419B	GB41293874	29-Mar-07 (METAS, No. 217-00670)	Mar-08
Power sensor E4412A	MY41495277	29-Mar-07 (METAS, No. 217-00670)	Mar-08
Power sensor E4412A	MY41498087	29-Mar-07 (METAS, No. 217-00670)	Mar-08
Reference 20 dB Attenuator	SN: S5086 (20b)	29-Mar-07 (METAS, No. 217-00671)	Mar-08
Reference 10 dB Attenuator	SN: 5047.2 (10r)	10-Aug-06 (METAS, No 217-00591)	Aug-07
Reference Probe EX3DV4	SN: 3503	9-Mar-07 (SPEAG, No. EX3-3503_Mar07)	Mar-08
DAE4	SN 601	30-Jan-07 (SPEAG, No. DAE4-601_Jan07)	Jan-08

Secondary Standards	ID #	Check Date (in house)	Scheduled Check
RF generator R&S SMT-06	100005	4-Aug-99 (SPEAG, in house check Nov-05)	In house check: Nov-07
Network Analyzer HP 8753E	US37390585 S4206	18-Oct-01 (SPEAG, in house check Oct-06)	In house check: Oct-07

Calibrated by: **Claudio Leubier** (Name), **Laboratory Technician** (Function), *[Signature]* (Signature)

Approved by: **Katja Pokovic** (Name), **Technical Manager** (Function), *[Signature]* (Signature)

Issued: April 25, 2007

This calibration certificate shall not be reproduced except in full without written approval of the laboratory.



Accredited by the Swiss Federal Office of Metrology and Accreditation
The Swiss Accreditation Service is one of the signatories to the EA
Multilateral Agreement for the recognition of calibration certificates

Accreditation No.: **SCS 108**

Glossary:

TSL	tissue simulating liquid
ConvF	sensitivity in TSL / NORM x,y,z
N/A	not applicable or not measured

Calibration is Performed According to the Following Standards:

- a) IEC Std 62209 Part 2, "Evaluation of Human Exposure to Radio Frequency Fields from Handheld and Body-Mounted Wireless Communication Devices in the Frequency Range of 30 MHz to 6 GHz: Human models, Instrumentation, and Procedures"; Part 2: "Procedure to determine the Specific Absorption Rate (SAR) for including accessories and multiple transmitters", Draft Version 0.9, December 2004
- b) Federal Communications Commission Office of Engineering & Technology (FCC OET), "Evaluating Compliance with FCC Guidelines for Human Exposure to Radiofrequency Electromagnetic Fields; Additional Information for Evaluating Compliance of Mobile and Portable Devices with FCC Limits for Human Exposure to Radiofrequency Emissions", Supplement C (Edition 01-01) to Bulletin 65

Additional Documentation:

- c) DASY4 System Handbook

Methods Applied and Interpretation of Parameters:

- *Measurement Conditions:* Further details are available from the Validation Report at the end of the certificate. All figures stated in the certificate are valid at the frequency indicated.
- *Antenna Parameters with TSL:* The dipole is mounted with the spacer to position its feed point exactly below the center marking of the flat phantom section, with the arms oriented parallel to the body axis.
- *Feed Point Impedance and Return Loss:* These parameters are measured with the dipole positioned under the liquid filled phantom. The impedance stated is transformed from the measurement at the SMA connector to the feed point. The Return Loss ensures low reflected power. No uncertainty required.
- *Electrical Delay:* One-way delay between the SMA connector and the antenna feed point. No uncertainty required.
- *SAR measured:* SAR measured at the stated antenna input power.
- *SAR normalized:* SAR as measured, normalized to an input power of 1 W at the antenna connector.
- *SAR for nominal TSL parameters:* The measured TSL parameters are used to calculate the nominal SAR result.

Measurement Conditions

DASY system configuration, as far as not given on page 1.

DASY Version	DASY4	V4.7
Extrapolation	Advanced Extrapolation	
Phantom	Modular Flat Phantom V5.0	
Distance Dipole Center - TSL	10 mm	with Spacer
Area Scan resolution	dx, dy = 10 mm	
Zoom Scan Resolution	dx, dy = 4. mm, dz = 2.5 mm	
Frequency	5200 MHz ± 1 MHz 5500 MHz ± 1 MHz 5800 MHz ± 1 MHz	

Head TSL parameters at 5200 MHz

The following parameters and calculations were applied.

	Temperature	Permittivity	Conductivity
Nominal Head TSL parameters	22.0 °C	36.0	4.66 mho/m
Measured Head TSL parameters	(22.0 ± 0.2) °C	35.5 ± 6 %	4.57 mho/m ± 6 %
Head TSL temperature during test	(22.0 ± 0.2) °C	---	---

SAR result with Head TSL at 5200 MHz

SAR averaged over 1 cm³ (1 g) of Head TSL	condition	
SAR measured	250 mW input power	20.1 mW / g
SAR normalized	normalized to 1W	80.4 mW / g
SAR for nominal Head TSL parameters ¹	normalized to 1W	80.1 mW / g ± 19.9 % (k=2)

SAR averaged over 10 cm³ (10 g) of Head TSL	condition	
SAR measured	250 mW input power	5.68 mW / g
SAR normalized	normalized to 1W	22.7 mW / g
SAR for nominal Head TSL parameters ¹	normalized to 1W	22.6 mW / g ± 19.5 % (k=2)

¹ Correction to nominal TSL parameters according to c), chapter "SAR Sensitivities"

Head TSL parameters at 5500 MHz

The following parameters and calculations were applied.

	Temperature	Permittivity	Conductivity
Nominal Head TSL parameters	22.0 °C	35.6	4.96 mho/m
Measured Head TSL parameters	(22.0 ± 0.2) °C	34.9 ± 6 %	4.87 mho/m ± 6 %
Head TSL temperature during test	(22.0 ± 0.2) °C	---	---

SAR result with Head TSL at 5500 MHz

SAR averaged over 1 cm ³ (1 g) of Head TSL	condition	
SAR measured	250 mW input power	19.2 mW / g
SAR normalized	normalized to 1W	76.8 mW / g
SAR for nominal Head TSL parameters ¹	normalized to 1W	76.3 mW / g ± 19.9 % (k=2)

SAR averaged over 10 cm ³ (10 g) of Head TSL	condition	
SAR measured	250 mW input power	5.44 mW / g
SAR normalized	normalized to 1W	21.8 mW / g
SAR for nominal Head TSL parameters ¹	normalized to 1W	21.6 mW / g ± 19.5 % (k=2)

Head TSL parameters at 5800 MHz

The following parameters and calculations were applied.

	Temperature	Permittivity	Conductivity
Nominal Head TSL parameters	22.0 °C	35.3	5.27 mho/m
Measured Head TSL parameters	(22.0 ± 0.2) °C	34.4 ± 6 %	5.12 mho/m ± 6 %
Head TSL temperature during test	(22.0 ± 0.2) °C	---	---

SAR result with Head TSL at 5800 MHz

SAR averaged over 1 cm ³ (1 g) of Head TSL	condition	
SAR measured	250 mW input power	19.3 mW / g
SAR normalized	normalized to 1W	77.2 mW / g
SAR for nominal Head TSL parameters ¹	normalized to 1W	76.5 mW / g ± 19.9 % (k=2)

SAR averaged over 10 cm ³ (10 g) of Head TSL	condition	
SAR measured	250 mW input power	5.43 mW / g
SAR normalized	normalized to 1W	21.7 mW / g
SAR for nominal Head TSL parameters ¹	normalized to 1W	21.5 mW / g ± 19.5 % (k=2)

¹ Correction to nominal TSL parameters according to c), chapter "SAR Sensitivities"

Body TSL parameters at 5200 MHz

The following parameters and calculations were applied.

	Temperature	Permittivity	Conductivity
Nominal Body TSL parameters	22.0 °C	49.0	5.30 mho/m
Measured Body TSL parameters	(22.0 ± 0.2) °C	47.3 ± 6 %	5.31 mho/m ± 6 %
Body TSL temperature during test	(22.0 ± 0.2) °C	---	---

SAR result with Body TSL at 5200 MHz

SAR averaged over 1 cm ³ (1 g) of Body TSL	condition	
SAR measured	250 mW input power	19.5 mW / g
SAR normalized	normalized to 1W	78.0 mW / g
SAR for nominal Body TSL parameters ¹	normalized to 1W	77.1 mW / g ± 19.9 % (k=2)

SAR averaged over 10 cm ³ (10 g) of Body TSL	condition	
SAR measured	250 mW input power	5.48 mW / g
SAR normalized	normalized to 1W	21.9 mW / g
SAR for nominal Body TSL parameters ¹	normalized to 1W	21.7 mW / g ± 19.5 % (k=2)

Body TSL parameters at 5500 MHz

The following parameters and calculations were applied.

	Temperature	Permittivity	Conductivity
Nominal Body TSL parameters	22.0 °C	48.6	5.56 mho/m
Measured Body TSL parameters	(22.0 ± 0.2) °C	46.6 ± 6 %	5.68 mho/m ± 6 %
Body TSL temperature during test	(22.0 ± 0.2) °C	---	---

SAR result with Body TSL at 5500 MHz

SAR averaged over 1 cm ³ (1 g) of Body TSL	condition	
SAR measured	250 mW input power	19.6 mW / g
SAR normalized	normalized to 1W	78.4 mW / g
SAR for nominal Body TSL parameters ¹	normalized to 1W	77.4 mW / g ± 19.9 % (k=2)

SAR averaged over 10 cm ³ (10 g) of Body TSL	condition	
SAR measured	250 mW input power	5.47 mW / g
SAR normalized	normalized to 1W	21.9 mW / g
SAR for nominal Body TSL parameters ¹	normalized to 1W	21.6 mW / g ± 19.5 % (k=2)

¹ Correction to nominal TSL parameters according to c), chapter "SAR Sensitivities"

Body TSL parameters at 5800 MHz

The following parameters and calculations were applied.

	Temperature	Permittivity	Conductivity
Nominal Body TSL parameters	22.0 °C	48.2	6.00 mho/m
Measured Body TSL parameters	(22.0 ± 0.2) °C	46.0 ± 6 %	6.04 mho/m ± 6 %
Body TSL temperature during test	(22.0 ± 0.2) °C	---	---

SAR result with Body TSL at 5800 MHz

SAR averaged over 1 cm ³ (1 g) of Body TSL	condition	
SAR measured	250 mW input power	17.6 mW / g
SAR normalized	normalized to 1W	70.4 mW / g
SAR for nominal Body TSL parameters ¹	normalized to 1W	69.4 mW / g ± 19.9 % (k=2)

SAR averaged over 10 cm ³ (10 g) of Body TSL	condition	
SAR measured	250 mW input power	4.92 mW / g
SAR normalized	normalized to 1W	19.7 mW / g
SAR for nominal Body TSL parameters ¹	normalized to 1W	19.4 mW / g ± 19.5 % (k=2)

¹ Correction to nominal TSL parameters according to c), chapter "SAR Sensitivities"

Appendix

Antenna Parameters with Head TSL at 5200 MHz

Impedance, transformed to feed point	51.6 Ω - 10.3 j Ω
Return Loss	-19.8 dB

Antenna Parameters with Head TSL at 5500 MHz

Impedance, transformed to feed point	48.9 Ω - 2.0 j Ω
Return Loss	-32.5 dB

Antenna Parameters with Head TSL at 5800 MHz

Impedance, transformed to feed point	56.4 Ω + 3.8 j Ω
Return Loss	-23.1 dB

Antenna Parameters with Body TSL at 5200 MHz

Impedance, transformed to feed point	51.3 Ω - 9.0 j Ω
Return Loss	-20.9 dB

Antenna Parameters with Body TSL at 5500 MHz

Impedance, transformed to feed point	49.0 Ω - 1.6 j Ω
Return Loss	-34.3 dB

Antenna Parameters with Body TSL at 5800 MHz

Impedance, transformed to feed point	57.3 Ω + 5.3 j Ω
Return Loss	-21.5 dB

General Antenna Parameters and Design

Electrical Delay (one direction)	1.201 ns
----------------------------------	----------

After long term use with 40 W radiated power, only a slight warming of the dipole near the feedpoint can be measured.

The dipole is made of standard semirigid coaxial cable. The center conductor of the feeding line is directly connected to the second arm of the dipole. The antenna is therefore short-circuited for DC-signals.

No excessive force must be applied to the dipole arms, because they might bend or the soldered connections near the feedpoint may be damaged.

Additional EUT Data

Manufactured by	SPEAG
Manufactured on	February 05, 2004

DASY4 Validation Report for Head TSL

Date/Time: 19.04.2007 20:55:27

Test Laboratory: SPEAG, Zurich, Switzerland

DUT: Dipole 5GHz; Type: D5GHz; Serial: D5GHzV2 - SN:1018

Communication System: CW-5GHz; Frequency: 5200 MHz Frequency: 5500 MHz Frequency: 5800 MHz; Duty Cycle: 1:1

Medium: HSL 5800 MHz;

Medium parameters used: $f = 5200$ MHz; $\sigma = 4.57$ mho/m; $\epsilon_r = 35.5$; $\rho = 1000$ kg/m³

Medium parameters used: $f = 5500$ MHz; $\sigma = 4.87$ mho/m; $\epsilon_r = 34.9$; $\rho = 1000$ kg/m³

Medium parameters used: $f = 5800$ MHz; $\sigma = 5.12$ mho/m; $\epsilon_r = 34.4$; $\rho = 1000$ kg/m³

Phantom section: Flat Section

Measurement Standard: DASY4 (High Precision Assessment)

DASY4 Configuration:

- Probe: EX3DV4 - SN3503; ConvF(5.56, 5.56, 5.56)ConvF(5.2, 5.2, 5.2)ConvF(4.97, 4.97, 4.97); Calibrated: 09.03.2007
- Sensor-Surface: 2mm (Mechanical Surface Detection)
- Electronics: DAE4 Sn601; Calibrated: 30.01.2007
- Phantom: Flat Phantom 5.0 (front); Type: QD000P50AA; ;
- Measurement SW: DASY4, V4.7 Build 53; Postprocessing SW: SEMCAD, V1.8 Build 172

d=10mm, Pin=250mW, f=5200 MHz/Zoom Scan (8x8x10), dist=2mm (8x8x10):

Measurement grid: dx=4mm, dy=4mm, dz=2.5mm

Reference Value = 63.1 V/m; Power Drift = 0.069 dB

Peak SAR (extrapolated) = 75.3 W/kg

SAR(1 g) = 20.1 mW/g; SAR(10 g) = 5.68 mW/g

Maximum value of SAR (measured) = 41.5 mW/g

d=10mm, Pin=250mW, f=5500 MHz/Zoom Scan (8x8x10), dist=2mm (8x8x10):

Measurement grid: dx=4mm, dy=4mm, dz=2.5mm

Reference Value = 62.5 V/m; Power Drift = 0.108 dB

Peak SAR (extrapolated) = 75.4 W/kg

SAR(1 g) = 19.2 mW/g; SAR(10 g) = 5.44 mW/g

Maximum value of SAR (measured) = 40.2 mW/g

d=10mm, Pin=250mW, f=5800 MHz/Zoom Scan (8x8x10), dist=2mm (8x8x10):

Measurement grid: dx=4mm, dy=4mm, dz=2.5mm

Reference Value = 62.1 V/m; Power Drift = 0.013 dB

Peak SAR (extrapolated) = 79.9 W/kg

SAR(1 g) = 19.3 mW/g; SAR(10 g) = 5.43 mW/g

Maximum value of SAR (measured) = 41.1 mW/g

Impedance Measurement Plot for Head TSL

18 Apr 2007 11:03:07

CH1 S11 1 U FS 1: 51.553 Ω -10.336 Ω 2.9612 pF 5 200.000 000 MHz

*
Del
Cor
Avg
16
↑

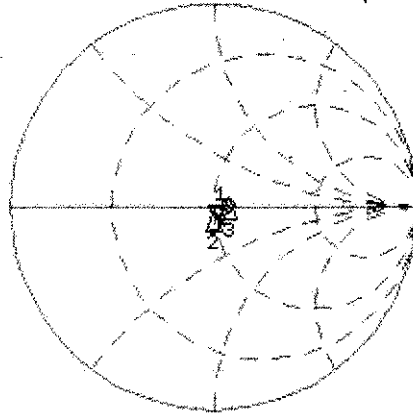

CH1 Markers

2: 48.855 Ω
-2.0313 Ω
5.50000 GHz
3: 56.441 Ω
3.7852 Ω
5.80000 GHz

CH2 S11 LOG 5 dB/REF -20 dB 1: -19.793 dB 5 200.000 000 MHz

Cor
Avg
16
↑

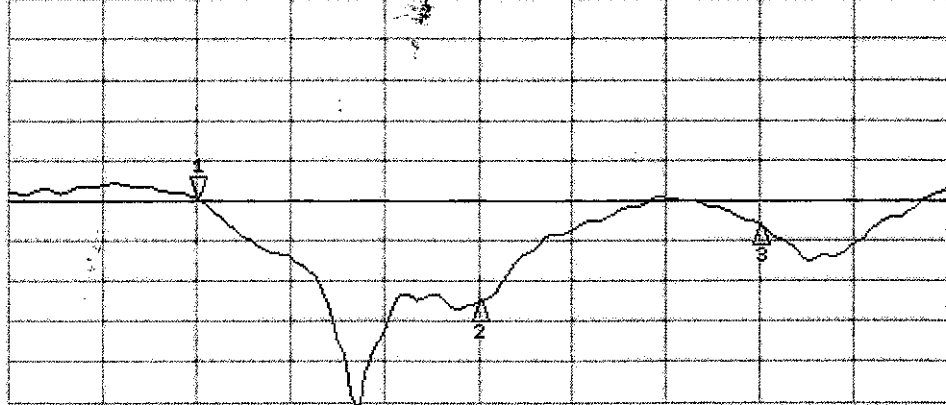

CH2 Markers

2: -32.548 dB
5.50000 GHz
3: -23.075 dB
5.80000 GHz

DASY4 Validation Report for Body TSL

Date/Time: 19.04.2007 19:34:02

Test Laboratory: SPEAG, Zurich, Switzerland

DUT: Dipole 5GHz; Type: D5GHz; Serial: D5GHzV2 - SN:1018

Communication System: CW-5GHz; Frequency: 5200 MHz Frequency: 5500 MHz Frequency: 5800 MHz; Duty Cycle: 1:1

Medium: MSL 5800 MHz;

Medium parameters used: $f = 5200$ MHz; $\sigma = 5.31$ mho/m; $\epsilon_r = 47.3$; $\rho = 1000$ kg/m³

Medium parameters used: $f = 5500$ MHz; $\sigma = 5.68$ mho/m; $\epsilon_r = 46.6$; $\rho = 1000$ kg/m³

Medium parameters used: $f = 5800$ MHz; $\sigma = 6.04$ mho/m; $\epsilon_r = 46$; $\rho = 1000$ kg/m³

Phantom section: Flat Section

Measurement Standard: DASY4 (High Precision Assessment)

DASY4 Configuration:

- Probe: EX3DV4 - SN3503; ConvF(4.96, 4.96, 4.96)ConvF(4.63, 4.63, 4.63)ConvF(4.76, 4.76, 4.76); Calibrated: 09.03.2007
- Sensor-Surface: 2mm (Mechanical Surface Detection)
- Electronics: DAE4 Sn601; Calibrated: 30.01.2007
- Phantom: Flat Phantom 5.0 (back); Type: QD000P50AA; ;
- Measurement SW: DASY4, V4.7 Build 53; Postprocessing SW: SEMCAD, V1.8 Build 172

d=10mm, Pin=250mW, f=5200 MHz/Zoom Scan (8x8x10), dist=2mm (8x8x10):

Measurement grid: dx=4mm, dy=4mm, dz=2.5mm

Reference Value = 79.0 V/m; Power Drift = -0.006 dB

Peak SAR (extrapolated) = 71.6 W/kg

SAR(1 g) = 19.5 mW/g; SAR(10 g) = 5.48 mW/g

Maximum value of SAR (measured) = 39.0 mW/g

d=10mm, Pin=250mW, f=5500 MHz/Zoom Scan (8x8x10), dist=2mm (8x8x10):

Measurement grid: dx=4mm, dy=4mm, dz=2.5mm

Reference Value = 75.8 V/m; Power Drift = 0.001 dB

Peak SAR (extrapolated) = 77.8 W/kg

SAR(1 g) = 19.6 mW/g; SAR(10 g) = 5.47 mW/g

Maximum value of SAR (measured) = 40.6 mW/g

d=10mm, Pin=250mW, f=5800 MHz/Zoom Scan (8x8x10), dist=2mm (8x8x10):

Measurement grid: dx=4mm, dy=4mm, dz=2.5mm

Reference Value = 70.5 V/m; Power Drift = -0.046 dB

Peak SAR (extrapolated) = 71.2 W/kg

SAR(1 g) = 17.6 mW/g; SAR(10 g) = 4.92 mW/g

Maximum value of SAR (measured) = 35.8 mW/g

Impedance Measurement Plot for Body TSL

18 Apr 2007 11:05:23

CH1 S11 1 U FS 1: 51.295 Ω -9.0332 Ω 3.3882 pF 5 200.000 000 MHz

*
Del
Cor
Avg
16
↑

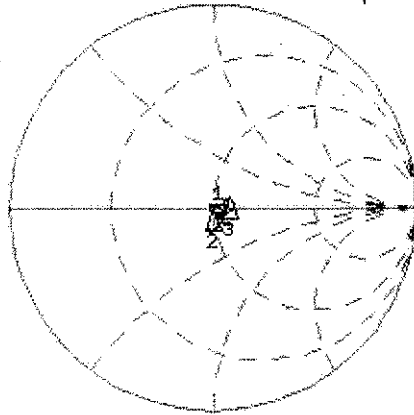

CH1 Markers
2: 48.998 Ω
-1.6113 Ω
5.50000 GHz
3: 57.291 Ω
5.2773 Ω
5.80000 GHz

CH2 S11 LOG 5 dB/REF -20 dB 1: -20.937 dB 5 200.000 000 MHz

Cor
Avg
16
↑

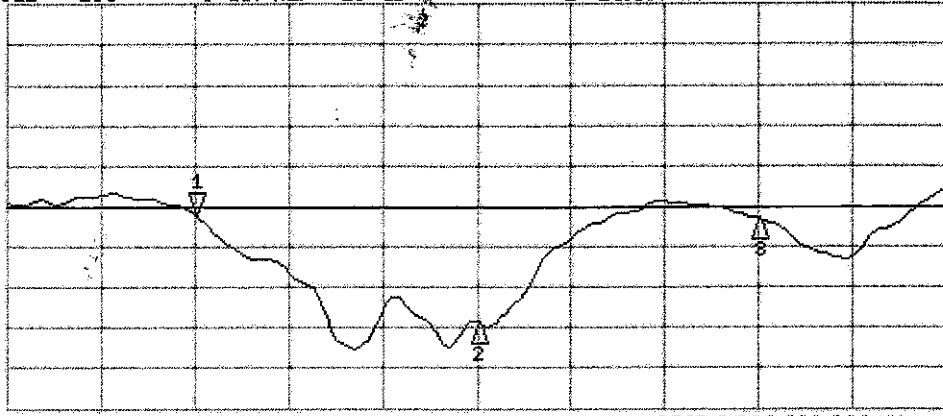

CH2 Markers
2: -34.340 dB
5.50000 GHz
3: -21.533 dB
5.80000 GHz