



FCC TEST REPORT (PART 24)

REPORT NO.: RF970216L05-4

MODEL NO.: MC7598

RECEIVED: Feb. 19, 2008

TESTED: Feb. 21 ~ Feb. 27, 2008

ISSUED: Feb. 29, 2008

APPLICANT: Symbol Technologies, Inc.

ADDRESS: One Symbol Plaza, Holtsville, NY 11742-1300,
U.S.A.

ISSUED BY: Advance Data Technology Corporation

LAB ADDRESS: No. 47, 14th Ling, Chia Pau Tsuen, Lin Kou Hsiang
244, Taipei Hsien, Taiwan, R.O.C.

TEST LOCATION: No. 19, Hwa Ya 2nd Rd., Wen Hwa Tsuen, Kwei
Shan Hsiang, Taoyuan Hsien 333, Taiwan, R.O.C.

This test report consists of 56 pages in total. It may be duplicated completely for legal use with the approval of the applicant. It should not be reproduced except in full, without the written approval of our laboratory. The client should not use it to claim product endorsement by TAF, A2LA or any government agencies. The test results in the report only apply to the tested sample.





TABLE OF CONTENTS

1	CERTIFICATION	4
2	SUMMARY OF TEST RESULTS	5
2.1	MEASUREMENT UNCERTAINTY	5
3	GENERAL INFORMATION.....	6
3.1	GENERAL DESCRIPTION OF EUT.....	6
3.2	DESCRIPTION OF TEST MODES.....	8
3.2.1	CONFIGURATION OF SYSTEM UNDER TEST	9
3.2.2	TEST MODE APPLICABILITY AND TESTED CHANNEL DETAIL.....	10
3.3	GENERAL DESCRIPTION OF APPLIED STANDARDS	13
3.4	DESCRIPTION OF SUPPORT UNITS	13
4	TEST TYPES AND RESULTS	14
4.1	OUTPUT POWER MEASUREMENT	14
4.1.1	LIMITS OF OUTPUT POWER MEASUREMENT.....	14
4.1.2	TEST INSTRUMENTS	15
4.1.3	TEST PROCEDURES.....	16
4.1.4	TEST SETUP	17
4.1.5	EUT OPERATING CONDITIONS.....	18
4.1.6	TEST RESULTS	19
4.2	FREQUENCY STABILITY MEASUREMENT	21
4.2.1	LIMITS OF FREQUENCY STABILITY MEASUREMENT.....	21
4.2.2	TEST INSTRUMENTS	21
4.2.3	TEST PROCEDURE	22
4.2.4	TEST SETUP	22
4.2.5	TEST RESULTS	23
4.3	OCCUPIED BANDWIDTH MEASUREMENT	24
4.3.1	LIMITS OF OCCUPIED BANDWIDTH MEASUREMENT	24
4.3.2	TEST INSTRUMENTS	24
4.3.3	TEST SETUP	24
4.3.4	TEST PROCEDURES.....	25
4.3.5	TEST RESULTS	26
4.4	BAND EDGE MEASUREMENT	32
4.4.1	LIMITS OF BAND EDGE MEASUREMENT	32
4.4.2	TEST INSTRUMENTS	32
4.4.3	TEST SETUP	32
4.4.4	TEST PROCEDURES.....	33
4.4.5	EUT OPERATING CONDITION	33
4.4.6	TEST RESULTS	34
4.5	CONDUCTED SPURIOUS EMISSIONS.....	35
4.5.1	LIMITS OF CONDUCTED SPURIOUS EMISSIONS MEASUREMENT	35
4.5.2	TEST INSTRUMENTS	35
4.5.3	TEST PROCEDURE	36
4.5.4	TEST SETUP	36
4.5.5	EUT OPERATING CONDITIONS.....	36



4.5.6	TEST RESULTS	37
4.6	RADIATED EMISSION MEASUREMENT (BELOW 1GHz).....	43
4.6.1	LIMITS OF RADIATED EMISSION MEASUREMENT	43
4.6.2	TEST INSTRUMENTS	44
4.6.3	TEST PROCEDURES	45
4.6.4	DEVIATION FROM TEST STANDARD	45
4.6.5	TEST SETUP	46
4.6.6	EUT OPERATING CONDITIONS	46
4.6.7	TEST RESULTS	47
4.7	RADIATED EMISSION MEASUREMENT (ABOVE 1GHz)	48
4.7.1	LIMITS OF RADIATED EMISSION MEASUREMENT	48
4.7.2	TEST INSTRUMENTS	49
4.7.3	TEST PROCEDURES	50
4.7.4	DEVIATION FROM TEST STANDARD	50
4.7.5	TEST SETUP	51
4.7.6	EUT OPERATING CONDITIONS	51
4.7.7	TEST RESULTS	52
5	INFORMATION ON THE TESTING LABORATORIES	55
6	APPENDIX A – MODIFICATIONS RECORDERS FOR ENGINEERING CHANGES TO THE EUT BY THE LAB.....	56



1 CERTIFICATION

PRODUCT : EDA (Enterprise Digital Assistant)

MODEL : MC7598

BRAND : Symbol

APPLICANT : Symbol Technologies, Inc.

TESTED : Feb. 21 ~ Feb. 27, 2008

TEST SAMPLE : PROTOTYPE

TEST STANDARDS : FCC Part 24, Subpart E

ANSI C63.4-2003

The above equipment (model: MC7598) has been tested by **Advance Data Technology Corporation**, and found compliance with the requirement of the above standards. The test record, data evaluation & Equipment Under Test (EUT) configurations represented herein are true and accurate accounts of the measurements of the sample's EMC characteristics under the conditions specified in this report.

PREPARED BY : Rennie Wang , **DATE:** Feb. 29, 2008
Rennie Wang / Senior Specialist

TECHNICAL ACCEPTANCE : Long Chen , **DATE:** Feb. 29, 2008
Responsible for RF Long Chen / Senior Engineer

APPROVED BY : Gary Chang , **DATE:** Feb. 29, 2008
Gary Chang / Assistant Manager

2 SUMMARY OF TEST RESULTS

The EUT has been tested according to the following specifications:

APPLIED STANDARD: FCC Part 24 & Part 2 / IC RSS-133			
STANDARD SECTION	TEST TYPE AND LIMIT	RESULT	REMARK
2.1046 24.232	Maximum Peak Output Power Limit: max. 2 watts e.i.r.p peak power	PASS	Meet the requirement of limit. Minimum passing margin is 26.55dBm at 1851.25MHz.
2.1055 24.235	Frequency Stability AFC Freq. Error vs. Voltage AFC Freq. Error vs. Temperature Limit: max. ± 2.5 ppm	PASS	Meet the requirement of limit.
2.1049 24.238(b)	Occupied Bandwidth	PASS	Meet the requirement of limit.
24.238(b)	Band Edge Measurements	PASS	Meet the requirement of limit.
2.1051 24.238	Conducted Spurious Emissions	PASS	Meet the requirement of limit.
2.1053 24.238	Radiated Spurious Emissions	PASS	Meet the requirement of limit. Minimum passing margin is -44.24dB at 881.50MHz.

2.1 MEASUREMENT UNCERTAINTY

Where relevant, the following measurement uncertainty levels have been estimated for tests performed on the EUT as specified in CISPR 16-4-2:

MEASUREMENT	FREQUENCY	UNCERTAINTY
Conducted emissions	9kHz ~ 30MHz	2.44 dB
Radiated emissions	30MHz ~ 200MHz	3.19 dB
	200MHz ~ 1000MHz	3.21 dB
	1GHz ~ 18GHz	2.26 dB
	18GHz ~ 40GHz	1.94 dB

This uncertainty represents an expanded uncertainty expressed at approximately the 95% confidence level using a coverage factor of $k=2$.

3 GENERAL INFORMATION

3.1 GENERAL DESCRIPTION OF EUT

PRODUCT	EDA (Enterprise Digital Assistant)
MODEL NO.	MC7598
FCC ID	H9PMC7598
POWER SUPPLY	3.7Vdc from rechargeable lithium battery 5.4Vdc from power adapter
MODULATION TYPE	OQPSK, HPSK
FREQUENCY RANGE	1850MHz ~ 1910MHz
NUMBER OF CHANNEL	1151
MAX. EIRP POWER	26.55dBm (0.452Watts)
ANTENNA TYPE	Monopole antenna
MAX. ANTENNA GAIN	2.5dBi
DATA CABLE	Refer to NOTE
I/O PORTS	Refer to user's manual
ASSOCIATED DEVICES	Battery
EUT EXTREME VOL. RANGE	3.7Vdc to 4.2Vdc

NOTE:

- The applicant defined the normal working voltage of the battery is from 3.7Vdc to 4.2Vdc.
- The models as identified below are identical to each other except of the following options:
 - Keypad: Numeric / QWERTY
 - Barcode reader: 1D laser scanner / 2D Imager

BRAND	MODEL	DESCRIPTION
Symbol	MC7598	EVDO 1D Numeric
Symbol	MC7598	EVDO 2D QWERTY
**the worst case had been marked by boldface.		

- The EUT is an EDA (Enterprise Digital Assistant). The functions of EUT listed as below:

	TEST STANDARD	REFERENCE REPORT
WLAN 802.11a/b/g (802.11a follows standard 15.247)	FCC Part 15	RF970216L05
WLAN 802.11a (follows standard 15.407)		RF970216L05-2
BLUETOOTH		RF970216L05-3
CDMA 850	FCC Part 22	RF970216L05-1
CDMA 1900	FCC Part 24	RF970216L05-4

4. The communicated functions of EUT listed as below:

		850MHz	1900MHz	With
3G	CDMA	√	√	802.11a/b/g + Bluetooth + GPS functions
	EVDO	√	√	

5. The EUT has one lithium battery listed as below:

LI-LON BATTERY	
BRAND:	MOTOROLA
MODEL:	82-71364-05 Rev A
RATING:	3.7Vdc, 3600mAh

6. The following accessories are for support units only.

PRODUCT	BRAND	MODEL	DESCRIPTION
RS232 charging cable	Motorola	25-102776-01R	1.2m non-shielded cable with one core
USB charging cable	Motorola	25-102775-01R	1.5m shielded cable with one core
Headset	Motorola	50-11300-050R	VR10 headset 0.8m non-shielded cable with one core
Power Supply Adaptor	Motorola	EADP-16BB A	I/P: 100-240Vac, 50-60Hz, 0.4A O/P: 5.4Vdc, 3A 1.8m non-shielded cable without core

7. Hardware version: 1c.

8. Software version: BSP16.

9. The above EUT information was declared by manufacturer and for more detailed features description, please refer to the manufacturer's specifications or User's Manual.

3.2 DESCRIPTION OF TEST MODES

1151 channels are provided to this EUT in the CDMA1900 band. Therefore, the low, middle and high channels are chosen for testing.

	CHANNEL	FREQUENCY	TX MODE
LOW	25	1851.25 MHz	SO55
MIDDLE	600	1880.00 MHz	SO55
HIGH	1175	1908.75 MHz	SO55

NOTE:

1. Below 1 GHz, the channel 25, 600 and 1175 were pre-tested in chamber. The channel 25 was the worst case and chosen for final test.
2. Above 1 GHz, the channel 25, 600 and 1175 were tested individually.
3. The channel space is 0.05MHz.
4. In this report, CDMA2000 (SO55) was the worst case for all test items, therefore, only the data was recorded in the following section.

3.2.1 CONFIGURATION OF SYSTEM UNDER TEST

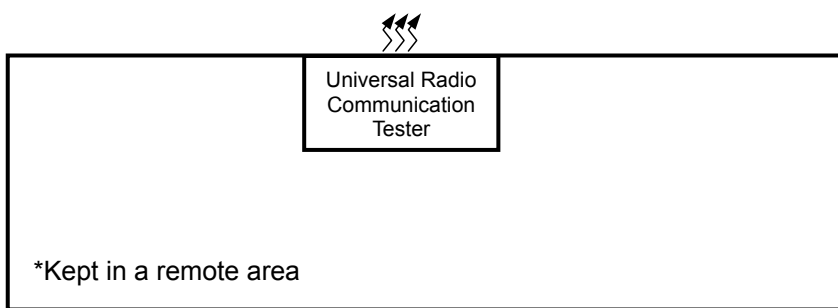
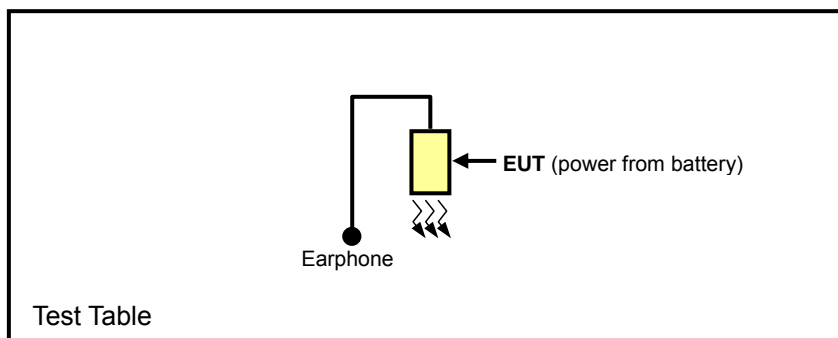

3.2.2 TEST MODE APPLICABILITY AND TESTED CHANNEL DETAIL

EUT CONFIGURE MODE	APPLICABLE TO							DESCRIPTION
	OP	FS	OB	BE	CE	RE<1G	RE≥1G	
-	V	V	V	V	V	V	V	-

Where **OP**: Output power **FS**: Frequency stability
OB: Occupied bandwidth **BE**: Band edge
CE: Conducted spurious emissions **RE<1G**: Radiated emission below 1GHz
RE≥1G: Radiated emission above 1GHz

OUTPUT POWER MEASUREMENT:

- Pre-Scan has been conducted to determine the worst-case mode from all possible combinations between available modulations, data rates, xyz axis and antenna ports (if EUT with antenna diversity architecture).
- Following channel(s) was (were) selected for the final test as listed below.

EUT CONFIGURE MODE	AVAILABLE CHANNEL	TESTED CHANNEL	MODULATION TECHNOLOGY	AXIS
-	25 to 1175	25, 600, 1175	CDMA	Z

FREQUENCY STABILITY MEASUREMENT:

- Pre-Scan has been conducted to determine the worst-case mode from all possible combinations between available modulations, data rates, and antenna ports (if EUT with antenna diversity architecture).
- Following channel(s) was (were) selected for the final test as listed below.

EUT CONFIGURE MODE	AVAILABLE CHANNEL	TESTED CHANNEL	MODULATION TECHNOLOGY
-	25 to 1175	600	CDMA

OCCUPIED BANDWIDTH MEASUREMENT:

- Pre-Scan has been conducted to determine the worst-case mode from all possible combinations between available modulations, data rates, and antenna ports (if EUT with antenna diversity architecture).
- Following channel(s) was (were) selected for the final test as listed below.

EUT CONFIGURE MODE	AVAILABLE CHANNEL	TESTED CHANNEL	MODULATION TECHNOLOGY
-	25 to 1175	25, 600, 1175	CDMA

BAND EDGE MEASUREMENT:

- Pre-Scan has been conducted to determine the worst-case mode from all possible combinations between available modulations, data rates, and antenna ports (if EUT with antenna diversity architecture).
- Following channel(s) was (were) selected for the final test as listed below.

EUT CONFIGURE MODE	AVAILABLE CHANNEL	TESTED CHANNEL	MODULATION TECHNOLOGY
-	25 to 1175	25, 1175	CDMA

CONDUCTED SPURIOUS EMISSIONS MEASUREMENT:

- Pre-Scan has been conducted to determine the worst-case mode from all possible combinations between available modulations, data rates, and antenna ports (if EUT with antenna diversity architecture).
- Following channel(s) was (were) selected for the final test as listed below.

EUT CONFIGURE MODE	AVAILABLE CHANNEL	TESTED CHANNEL	MODULATION TECHNOLOGY
-	25 to 1175	25, 600, 1175	CDMA



RADIATED EMISSION MEASUREMENT (BELOW 1 GHz):

- Pre-Scan has been conducted to determine the worst-case mode from all possible combinations between available modulations, data rates, xyz axis and antenna ports (if EUT with antenna diversity architecture).
- Following channel(s) was (were) selected for the final test as listed below.

EUT CONFIGURE MODE	AVAILABLE CHANNEL	TESTED CHANNEL	MODULATION TECHNOLOGY	AXIS
-	25 to 1175	25	CDMA	Z

RADIATED EMISSION MEASUREMENT (ABOVE 1 GHz):

- Pre-Scan has been conducted to determine the worst-case mode from all possible combinations between available modulations, data rates, xyz axis and antenna ports (if EUT with antenna diversity architecture).
- Following channel(s) was (were) selected for the final test as listed below.

EUT CONFIGURE MODE	AVAILABLE CHANNEL	TESTED CHANNEL	MODULATION TECHNOLOGY	AXIS
-	25 to 1175	25, 600, 1175	CDMA	Z



3.3 GENERAL DESCRIPTION OF APPLIED STANDARDS

The EUT is a RF product. According to the specifications of the manufacturer, it must comply with the requirements of the following standards:

- FCC 47 CFR Part 2**
- FCC 47 CFR Part 24**
- IC RSS-133**
- ANSI C63.4-2003**
- ANSI/TIA/EIA-603-C 2004**

NOTE: All test items have been performed and recorded as per the above standards.

3.4 DESCRIPTION OF SUPPORT UNITS

The EUT has been tested as an independent unit together with other necessary accessories or support units. The following support units or accessories were used to form a representative test configuration during the tests.

NO.	PRODUCT	BRAND	MODEL NO.	SERIAL NO.	CAL. DATE
1	Universal Radio Communication Tester	R&S	CMU200	101095	Apr. 11, 2008

NO.	SIGNAL CABLE DESCRIPTION OF THE ABOVE SUPPORT UNITS
1	NA

NOTE:

1. All power cords of the above support units are non shielded (1.8m).
2. Item 1 acted as a communication partners to transfer data.

4 TEST TYPES AND RESULTS

4.1 OUTPUT POWER MEASUREMENT

4.1.1 LIMITS OF OUTPUT POWER MEASUREMENT

The radiated peak output power shall be according to the specific rule Part 24.232(b) that “Mobile / Portable station are limited to 2 watts e.i.r.p” and 24.232(c) specific that “Peak transmit power must be measure over any interval of continuous transmission using instrumentation calibration in terms of rms-equivalent voltage.”



4.1.2 TEST INSTRUMENTS

DESCRIPTION & MANUFACTURER	MODEL NO.	SERIAL NO.	CALIBRATED UNTIL
Test Receiver ROHDE & SCHWARZ	ESCI	100424	Jul. 27, 2008
Spectrum Analyzer ROHDE & SCHWARZ	FSP40	100269	Aug. 05, 2008
BILOG Antenna SCHWARZBECK	VULB9168	9168-153	Jan. 03, 2009
HORN Antenna SCHWARZBECK	BBHA 9120 D	9120D-563	Jul. 30, 2008
HORN Antenna SCHWARZBECK	BBHA 9170	BBHA9170242	Jan. 06, 2009
Preamplifier Agilent	8449B	3008A01910	Sep. 19, 2008
Preamplifier Agilent	8447D	2944A10638	Dec. 19, 2008
RF signal cable HUBER+SUHNNER	SUCOFLEX 104	274039/223650	Nov. 07, 2008
RF signal cable Worken	8D-FB	Cable-HYCH9-01	Aug. 09, 2008
Software	ADT_Radiated_V7.6	NA	NA
Antenna Tower EMCO	2070/2080	512.835.4684	NA
Turn Table EMCO	2087-2.03	NA	NA
Antenna Tower & Turn Table Controller EMCO	2090	NA	NA

- NOTE:**
1. The calibration interval of the above test instruments is 12 months and the calibrations are traceable to NML/ROC and NIST/USA.
 2. The test was performed in HwaYa Chamber 9.
 3. The horn antenna and HP preamplifier (model: 8449B) are used only for the measurement of emission frequency above 1GHz if tested.
 4. The IC Site Registration No. is IC3789B-9.

4.1.3 TEST PROCEDURES

- a. The EUT was set up for the maximum peak power with CDMA link data modulation. The power was measured with R&S Spectrum Analyzer. All measurements were done at 3 channels: 25, 600 and 1175 (low, middle and high operational frequency range).
- b. The conducted peak output power used the power splitter via EUT RF power connector between simulation base station and spectrum analyzer. The path loss included the splitter loss, cable loss and 20dB pad loss. The spectrum set RB/VB 3MHz, then read peak power value and record to the test. (All transmitted path loss shall be considered in the test report data.)
- c. E.I.R.P peak power measurement. In the fully anechoic chamber, EUT placed on the 1.5m height of Turn Table, rotated the table around 360 degrees to search the maximum radiation power and receiver antenna shall be rotated vertical and horizontal polarization to find the maximum polar radiated power. The “Read Value” is the spectrum reading the maximum power value.
- d. The substitution horn antenna is substituted for EUT at the same position and signal generator export the CW signal to the calibration antenna. Rotated the Turn Table to find the maximum radiation power. “Raw” is the spectrum reading value, “SG” is signal generator export power, “TX Gain” is calibration antenna isotropic gain value, “TX cable” is the transmitted cable loss between the calibration antenna and signal generator. The “Factor” means that the transmission path loss is equal to $“SG” - “TX\ cable” + “TX\ Gain” - “Raw”$.
- e. Actually the real E.I.R.P peak power is equal to $“Read\ Value” + “Factor”$.

4.1.4 TEST SETUP

EIRP POWER MEASUREMENT:

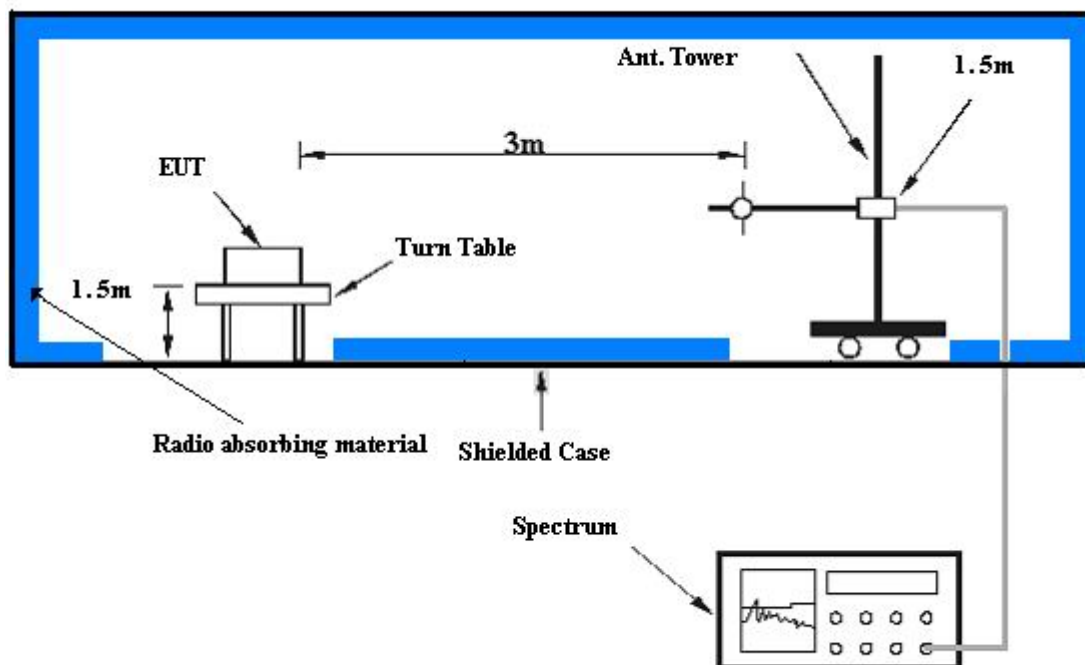

For the actual test configuration, please refer to the attached file (Test Setup Photo).

CONDUCTED POWER MEASUREMENT:

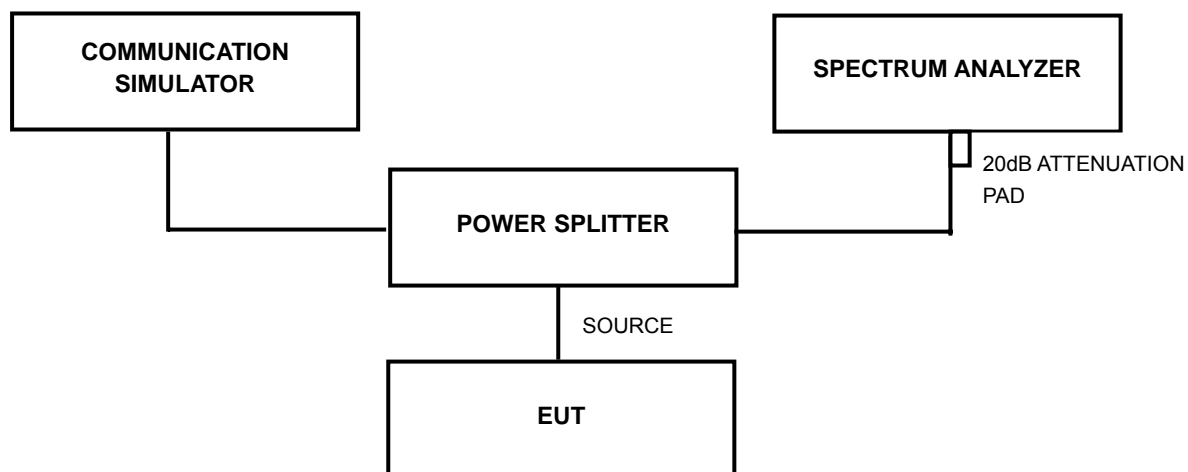

For the actual test configuration, please refer to the attached file (Test Setup Photo).

4.1.5 EUT OPERATING CONDITIONS

- a. The EUT makes a phone call to the communication simulator.
- b. The communication simulator station system controlled an EUT to export maximum output power under transmission mode and specific channel frequency.



4.1.6 TEST RESULTS

MODE	TX connected	DETECTOR FUNCTION	Average
INPUT POWER (SYSTEM)	120Vac, 60Hz	ENVIRONMENTAL CONDITIONS	23deg. C, 60%RH, 988hPa
TESTED BY	Match Tsui		

CONDUCTED POWER (1x EV-DO)								
CHANNEL	FREQ. (MHz)	RAW VALUE (dBm)		CORR. FACTOR (dB)	PEAK OUTPUT POWER			
					RTAP		FTAP	
		RTAP	FTAP		dBm	Watt	dBm	Watt
25	1851.25	22.61	22.63	1.00	23.61	0.230	23.63	0.231
600	1880.00	22.95	22.99	1.00	23.95	0.248	23.99	0.251
1175	1908.75	23.20	23.21	1.00	24.20	0.263	24.21	0.264

CDMA 2000 CONDUCTED POWER (SO2, SO55, TDSO SO32, SO3)											
CHAN.	FREQ. (MHz)	CDMA 2000 RC	RAW VALUE (dBm)				CORR. FACTOR (dB)	PEAK OUTPUT POWER (dBm)			
			SO2	SO55	TDSO SO32	SO3		SO2	SO55	TDSO SO32	SO3
25	1851.25	RC1	23.26	23.40	-	23.32	1.00	24.26	24.40	-	24.32
		RC3	23.23	23.41	23.41	23.31	1.00	24.23	24.41	24.41	24.31
600	1880.00	RC1	23.66	23.87	-	23.55	1.00	24.66	24.87	-	24.55
		RC3	23.64	23.88	23.78	23.53	1.00	24.64	24.88	24.78	24.53
1175	1908.75	RC1	23.74	23.90	-	23.60	1.00	24.74	24.90	-	24.60
		RC3	23.71	23.93	23.88	23.63	1.00	24.71	24.93	24.88	24.63

- REMARKS:** 1. Peak Output Power (dBm) = Raw Value (dBm) + Correction Factor (dB).
 2. Correction Factor (dB) = Power Splitter Loss (dB) + Cable Loss (dB).
 3. The value in bold is the worst.



MODE	TX connected	DETECTOR FUNCTION	Average
INPUT POWER (SYSTEM)	120Vac, 60Hz	ENVIRONMENTAL CONDITIONS	23deg. C, 60%RH, 988hPa
TESTED BY	Match Tsui		

EIRP POWER (1x EV-DO)								
CHANNEL	FREQ. (MHz)	RAW VALUE (dBm)		CORR. FACTOR (dB)	PEAK OUTPUT POWER			
					RTAP		FTAP	
		RTAP	FTAP		dBm	Watt	dBm	Watt
25	1851.25	-14.43	-14.33	40.03	25.60	0.363	25.70	0.372
60	1880.00	-15.52	-15.47	40.32	24.80	0.302	24.85	0.305
1175	1908.75	-15.57	-15.52	40.62	25.05	0.320	25.10	0.324

EIRP POWER (SO55)					
CHANNEL NO.	FREQUENCY (MHz)	RAW VALUE (dBm)	CORRECTION FACTOR (dB)	PEAK OUTPUT POWER	
				dBm	Watt
25	1851.25	-13.48	40.03	26.55	0.452
600	1880.00	-14.58	40.32	25.74	0.375
1175	1908.75	-14.77	40.62	25.85	0.385

- REMARKS:** 1. Peak Output Power (dBm) = Raw Value (dBm) + Correction Factor (dB).
 2. Correction Factor (dB) = Receiver Antenna Gain (dBi) + Cable Loss (dB) + Free Space Loss (dB).
 3. The value in bold is the worst.



4.2 FREQUENCY STABILITY MEASUREMENT

4.2.1 LIMITS OF FREQUENCY STABILITY MEASUREMENT

According to the FCC part 2.4235 shall be tested the frequency stability. The rule is defined that "The frequency stability shall be sufficient to ensure that the fundamental emission stays within the authorized frequency block." The frequency error rate is according to the JTC standard that the frequency error rate shall be accurate to within 2.5ppm of the received frequency from the base station. The test extreme voltage is according to the 2.1055(d)(1) Vary primary supply voltage from 85 to 115 percent of the nominal value for other than hand carried battery equipment and the extreme temperature rule is comply with the 2.1055(a)(1) $-30^{\circ}\text{C} \sim 50^{\circ}\text{C}$.

4.2.2 TEST INSTRUMENTS

DESCRIPTION & MANUFACTURER	MODEL NO.	SERIAL NO.	CALIBRATED UNTIL
* Hewlett Packard RF cable	8120-6192	01428251	NA
* Suhner RF cable	Sucoflex104	204850/4	NA
* WIT Standard Temperature & Humidity Chamber	TH-4S-C	W981030	Jun. 28, 2008

- NOTE:**
1. The calibration interval of the above test instruments is 12 months. And the calibrations are traceable to NML/ROC and NIST/USA.
 2. "*" = These equipments are used for the final measurement.
 3. The test was performed in ADT RF OVEN room.

4.2.3 TEST PROCEDURE

- a. Because of the measure the carrier frequency under the condition of the AFC lock, it shall be used the mobile station in the CDMA link mode. This is accomplished with the use of the communication simulator station. The oven room could control the temperatures and humidity. The link channel is the 600.
- b. Power must be removed when changing from one temperature to another or one voltage to another voltage. Power warm up is at least 15 min and power applied should perform before recording frequency error.
- c. EUT is connected the external power supply to control the DC input power. The various Volts from the minimum 3.7 Volts to 4.2 Volts. Each step shall be record the frequency error rate.
- d. The temperature range step is 10 degrees in this test items. All temperature levels shall be hold the $\pm 0.5^{\circ}\text{C}$ during the measurement testing.
- e. The each temperature step shall be at least 0.5 hours, consider the EUT could be test under the stability condition.

NOTE: The frequency error was recorded frequency error from the communication simulator.

4.2.4 TEST SETUP

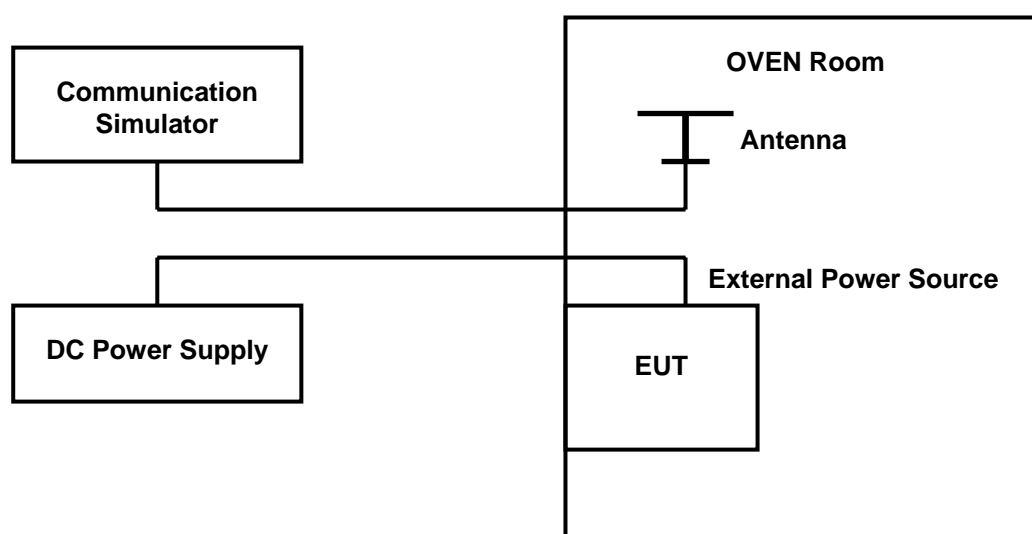



4.2.5 TEST RESULTS

MODE	Middle Channel	ENVIRONMENTAL CONDITIONS	23deg. C, 60%RH, 988hPa
INPUT POWER (SYSTEM)	120Vac, 60Hz	TESTED BY	Match Tsui

AFC FREQUENCY ERROR vs. VOLTAGE			
VOLTAGE (Volts)	FREQUENCY ERROR (Hz)	FREQUENCY ERROR (ppm)	LIMIT (ppm)
4.2	-10	-0.0053191489	2.5
3.7	-11	-0.0058510638	2.5

NOTE: The applicant defined the normal working voltage of the battery is from 6.0Vdc to 8.4Vdc.

AFC FREQUENCY ERROR vs. TEMP.			
TEMP. (°C)	FREQUENCY ERROR (Hz)	FREQUENCY ERROR (ppm)	LIMIT (ppm)
50	8	0.0042553191	2.5
40	-9	-0.0047872340	2.5
30	-10	-0.0053191489	2.5
20	11	0.0058510638	2.5
10	-13	-0.0069148936	2.5
0	-11	-0.0058510638	2.5
-10	-15	-0.0079787234	2.5
-20	17	0.0090425532	2.5
-30	-20	-0.0106382979	2.5

4.3 OCCUPIED BANDWIDTH MEASUREMENT

4.3.1 LIMITS OF OCCUPIED BANDWIDTH MEASUREMENT

According to FCC 24.238(b) specified that emission bandwidth is defined as the width of the signal between two points, one below the carrier center frequency and one above the carrier center frequency, outside of which all emissions are attenuated at least 26dB below the transmitter power.

4.3.2 TEST INSTRUMENTS

DESCRIPTION & MANUFACTURER	MODEL NO.	SERIAL NO.	CALIBRATED UNTIL
* ROHDE & SCHWARZ Spectrum Analyzer	FSP40	100035	Mar. 25, 2008
* Mini-Circuits Power Splitter	ZAPD-4	400005	NA
* Hewlett Packard RF cable	8120-6192	01428251	NA
* JFW 20dB attenuation	50HF-020-SMA	NA	NA
* Suhner RF cable	Sucoflex104	204850/4	NA

- NOTE:** 1. The calibration interval of the above test instruments is 12 months. And the calibrations are traceable to NML/ROC and NIST/USA.
 2. "*" = These equipments are used for the final measurement.

4.3.3 TEST SETUP

Same as Item 4.2.4 (Conducted Power Setup)

4.3.4 TEST PROCEDURES

- a. The EUT makes a phone call to the communication simulator. The power was measured with R&S Spectrum Analyzer. All measurements were done at 3 channels, 25, 600 and 1175 (low, middle and high operational frequency range.)
- b. The conducted occupied bandwidth used the power splitter via EUT RF power connector between simulation base station and spectrum analyzer. This splitter loss and cable loss are the worst loss 6.5dB in the transmitted path track.
- c. The communication simulator station system controlled a EUT to export maximum output power under transmission mode and specific channel frequency. FCC 24.238(b) required a measurement bandwidth is the fundamental emission below 26dB bandwidth.

MIDDLE CHANNEL

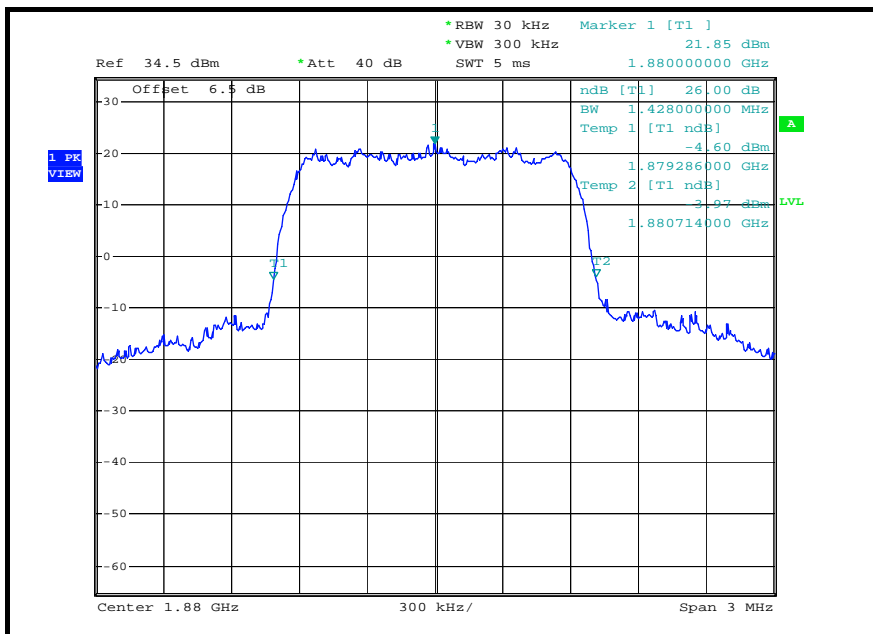

HIGH CHANNEL

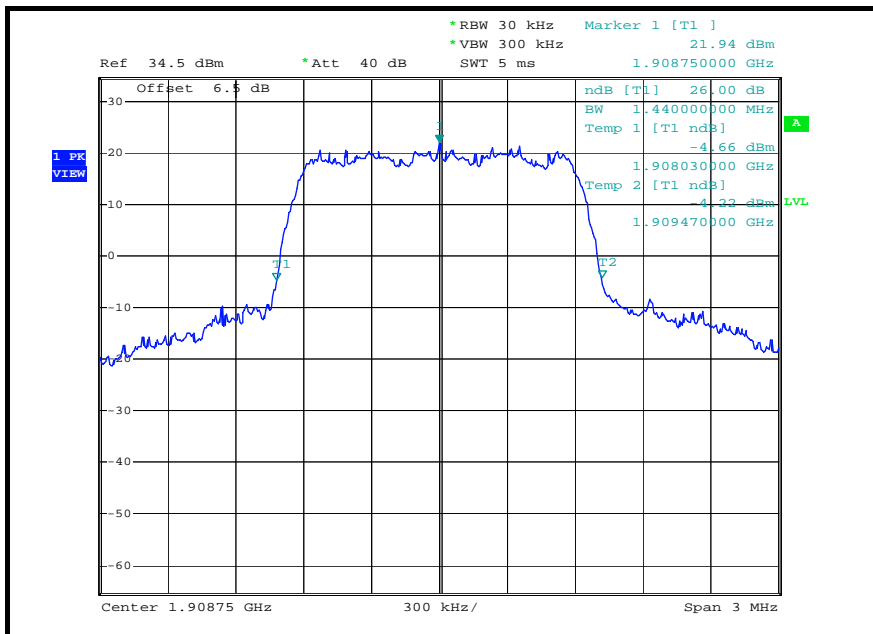

FOR EV-DO FTAP:

CHANNEL	MAX. OUTPUT POWER -26 dBc BANDWIDTH (kHz)
LOW	1.434
MIDDLE	1.422
HIGH	1.434

LOW CHANNEL

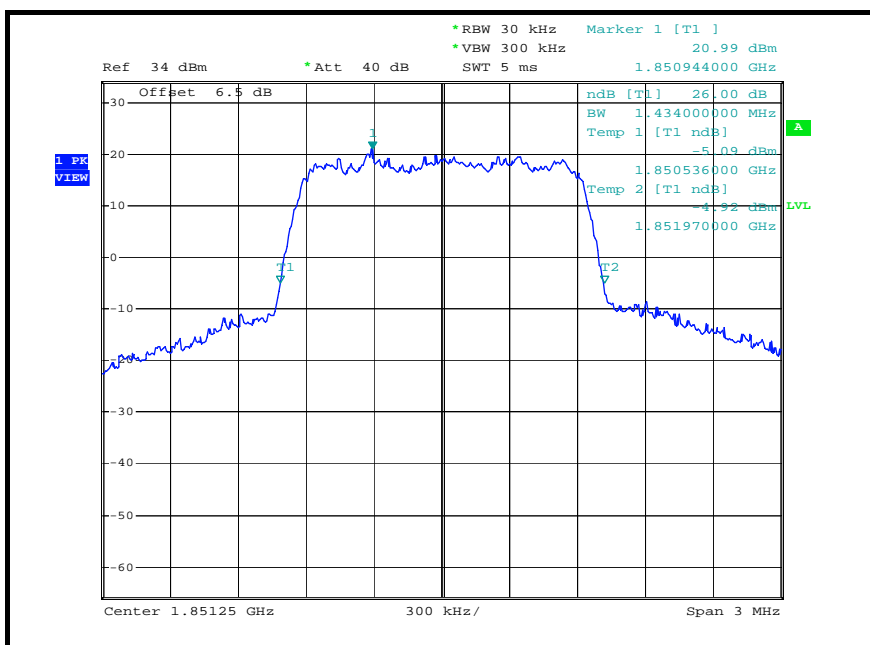

MIDDLE CHANNEL

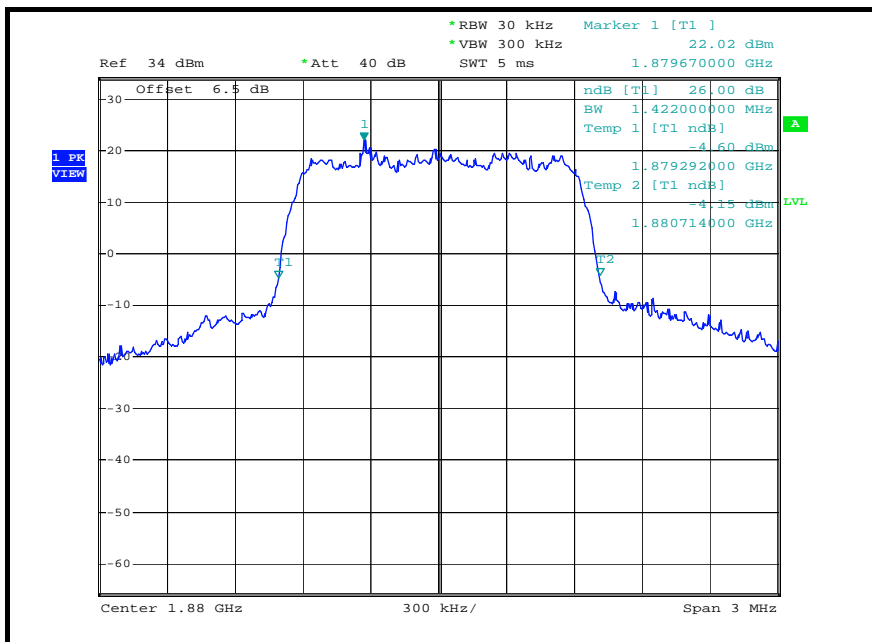

HIGH CHANNEL

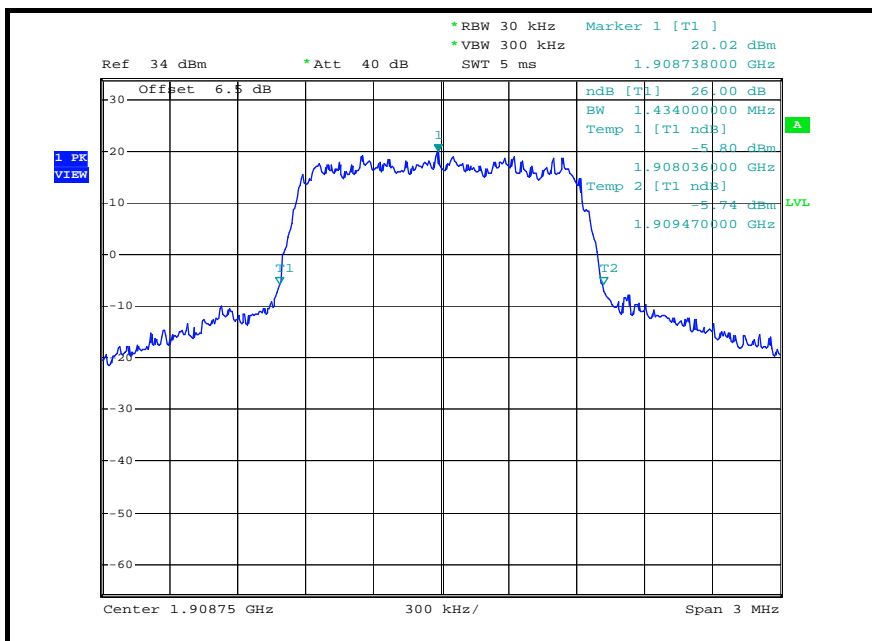

FOR EV-DO RTAP:

CHANNEL	MAX. OUTPUT POWER -26 dBc BANDWIDTH (kHz)
LOW	1.446
MIDDLE	1.446
HIGH	1.452

LOW CHANNEL

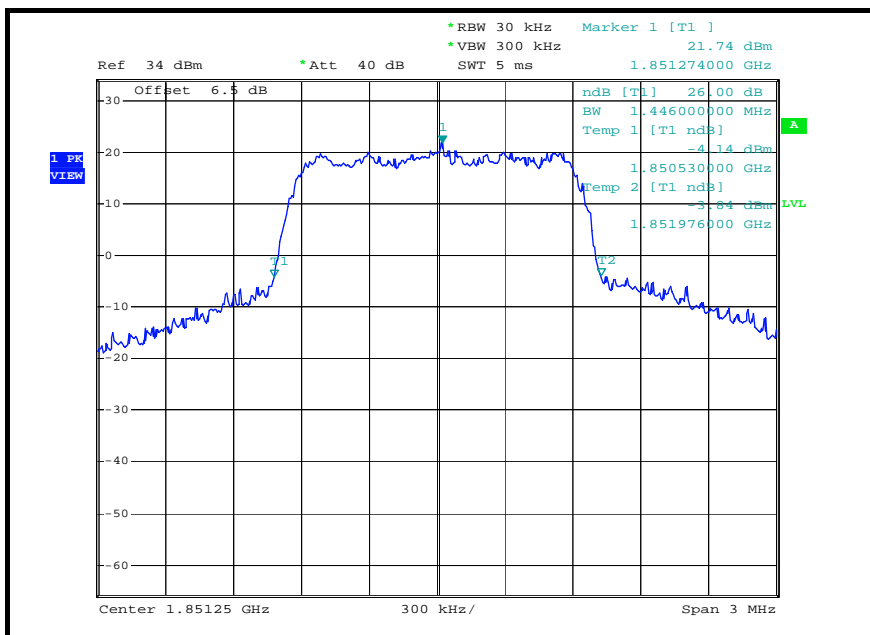

MIDDLE CHANNEL

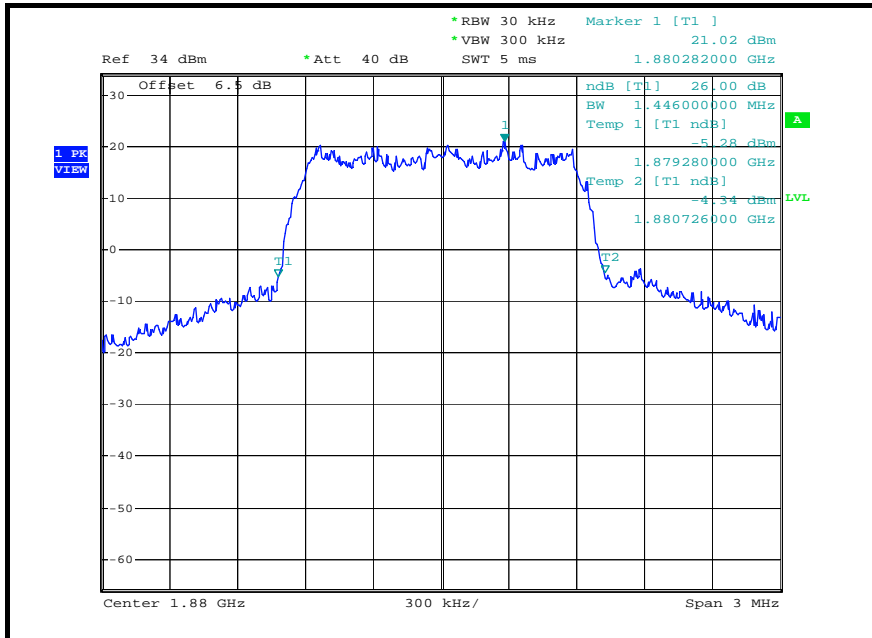

HIGH CHANNEL

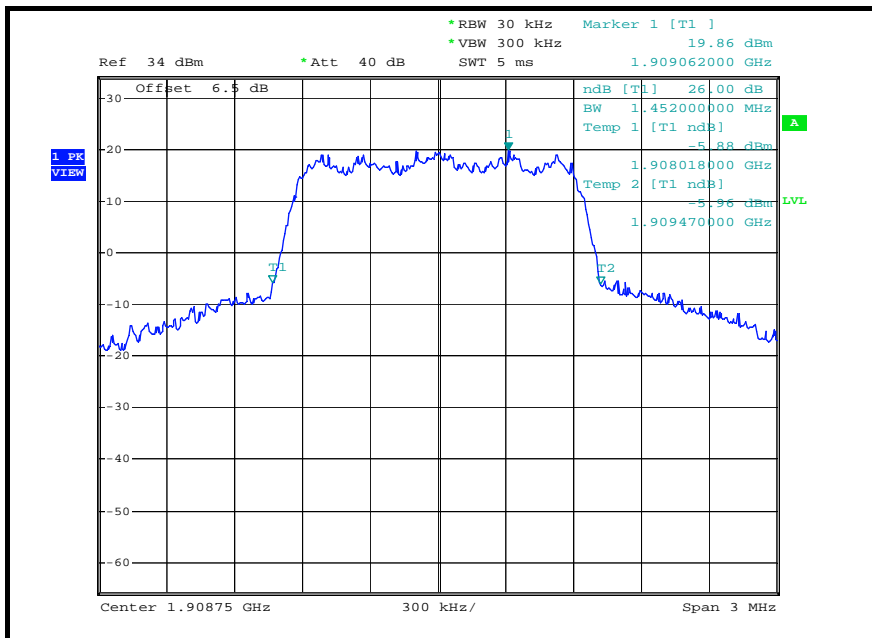

4.4 BAND EDGE MEASUREMENT

4.4.1 LIMITS OF BAND EDGE MEASUREMENT

The PCS frequency bands refer to the FCC 24.229 rule. According to FCC 24.238(a) specified that power of any emission outside of the authorized operating frequency ranges must be attenuated below the transmitting power (P) by a factor of at least $43 + 10 \log(P)$ dB. In the 1 MHz bands immediately outside and adjacent to the frequency block a resolution bandwidth of at least one percent of the emission bandwidth of the fundamental emission of the transmitter may be employed.

4.4.2 TEST INSTRUMENTS

DESCRIPTION & MANUFACTURER	MODEL NO.	SERIAL NO.	CALIBRATED UNTIL
* ROHDE & SCHWARZ Spectrum Analyzer	FSP40	100035	Mar. 25, 2008
* Mini-Circuits Power Splitter	ZAPD-4	400005	NA
* Hewlett Packard RF cable	8120-6192	01428251	NA
* JFW 20dB attenuation	50HF-020-SMA	NA	NA
* Suhner RF cable	Sucoflex104	204850/4	NA

- NOTE:** 1. The calibration interval of the above test instruments is 12 months. And the calibrations are traceable to NML/ROC and NIST/USA.
 2. "*" = These equipments are used for the final measurement.

4.4.3 TEST SETUP

Same as Item 4.2.4 (Conducted Power Setup)

4.4.4 TEST PROCEDURES

- a. The EUT was set up for the maximum peak power with CDMA link data modulation. The power was measured with R&S Spectrum Analyzer. All measurements were done at 2 channels, 25 and 1175 (low and high operational frequency range.)
- b. The band edge measurement used the power splitter via EUT RF power connector between simulation base station and spectrum analyzer. This splitter loss and cable loss are the worst loss 6.5dB in the transmitted path track.
- c. The center frequency of spectrum is the band edge frequency and span is 3 MHz. RB of the spectrum is 15kHz and VB of the spectrum is 15kHz.
- d. Record the max trace plot into the test report.

4.4.5 EUT OPERATING CONDITION

- a. The EUT makes a phone call to the communication simulator.
- b. The communication simulator station system controlled an EUT to export maximum output power under transmission mode and specific channel frequency.

4.4.6 TEST RESULTS

LOWER BAND EDGE

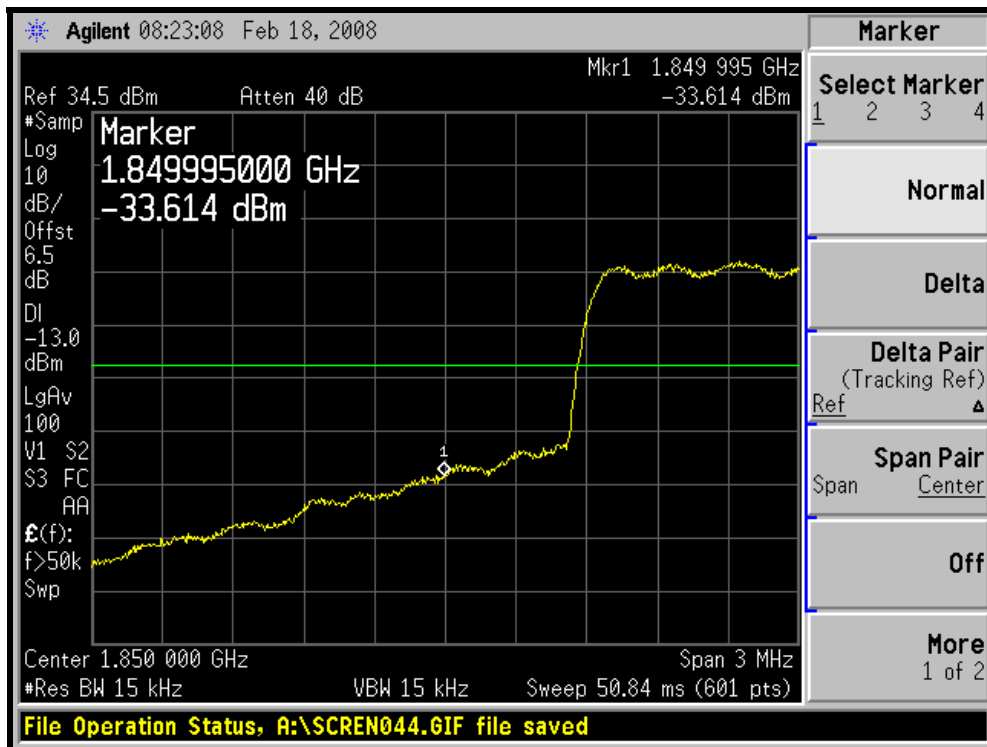

HIGHER BAND EDGE

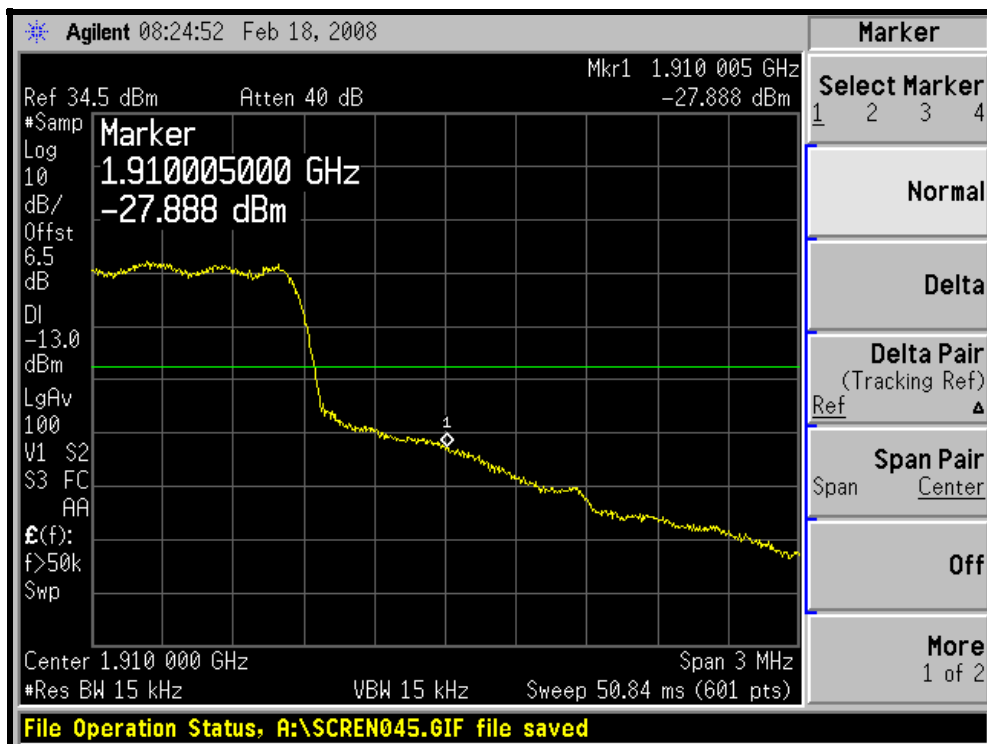



4.5 CONDUCTED SPURIOUS EMISSIONS

4.5.1 LIMITS OF CONDUCTED SPURIOUS EMISSIONS MEASUREMENT

In the FCC 24.238(a), On any frequency outside a licensee's frequency block within USPCS spectrum, the power of any emission shall be attenuated below the transmitter power (P) by at least $43 + 10 \log (P)$ dB. The specified minimum attenuation becomes 43dB and the limit of emission equal to -13dBm .

4.5.2 TEST INSTRUMENTS

DESCRIPTION & MANUFACTURER	MODEL NO.	SERIAL NO.	CALIBRATED UNTIL
* ROHDE & SCHWARZ Spectrum Analyzer	FSP40	100035	Mar. 25, 2008
* Wainwright Instruments Band Reject Filter	WRCG1850/1910-18 30/1930-60/10SS	SN1	NA
* Wainwright Instruments High Pass Filter	WHK3.1/18G-10SS	SN1	NA
* Mini-Circuits Power Splitter	ZAPD-4	400005	NA
* Hewlett Packard RF cable	8120-6192	01428251	NA
* JFW 20dB attenuation	50HF-020-SMA	NA	NA
* Suhner RF cable	Sucoflex104	204850/4	NA

- NOTE:**
1. The calibration interval of the above test instruments is 12 months. And the calibrations are traceable to NML/ROC and NIST/USA.
 2. "*" = These equipments are used for the final measurement.

4.5.3 TEST PROCEDURE

- a. The EUT was set up for the maximum peak power with CDMA link data modulation. The power was measured with R&S Spectrum Analyzer. All measurements were done at 3 channels, 25, 600 and 1175 (low, middle and high operational frequency range.)
- b. The conducted spurious emission used the power splitter via EUT RF power connector between simulation base station and spectrum analyzer. This splitter loss and cable loss are the worst loss 6.5dB in the transmitted path track.
- c. When the spectrum scanned from 9kHz to 3GHz, it shall be connected to the band reject filter attenuated the carried frequency. The spectrum set RB=1MHz, VB=1MHz.
- d. When the spectrum scanned from 3GHz to 20GHz, it shall be connected to the high pass filter attenuated the carried frequency. The spectrum set RB=1MHz, VB=1MHz.

4.5.4 TEST SETUP

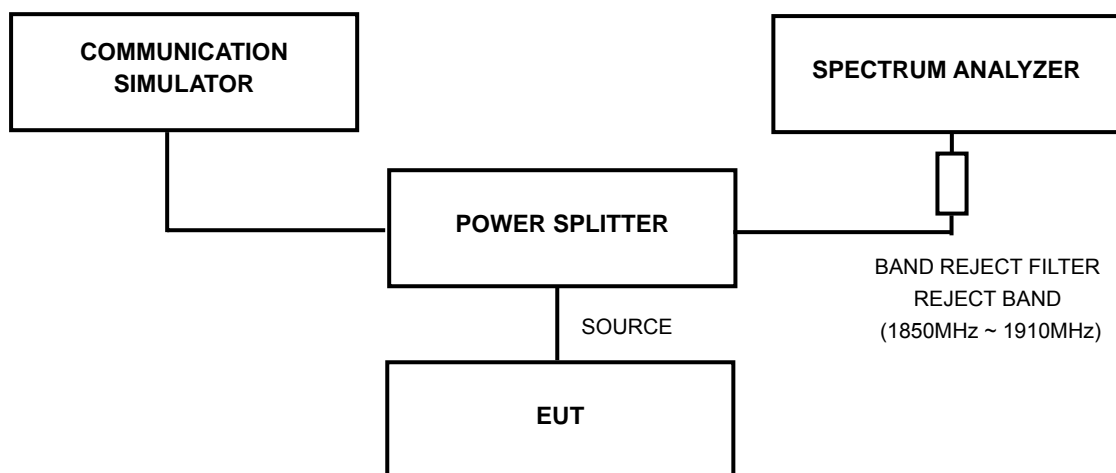

4.5.5 EUT OPERATING CONDITIONS

- a. The EUT makes a phone call to the communication simulator.
- b. The communication simulator station system controlled a EUT to export maximum output power under transmission mode and specific channel frequency.

4.5.6 TEST RESULTS

CH 25: 9kHz ~ 3GHz

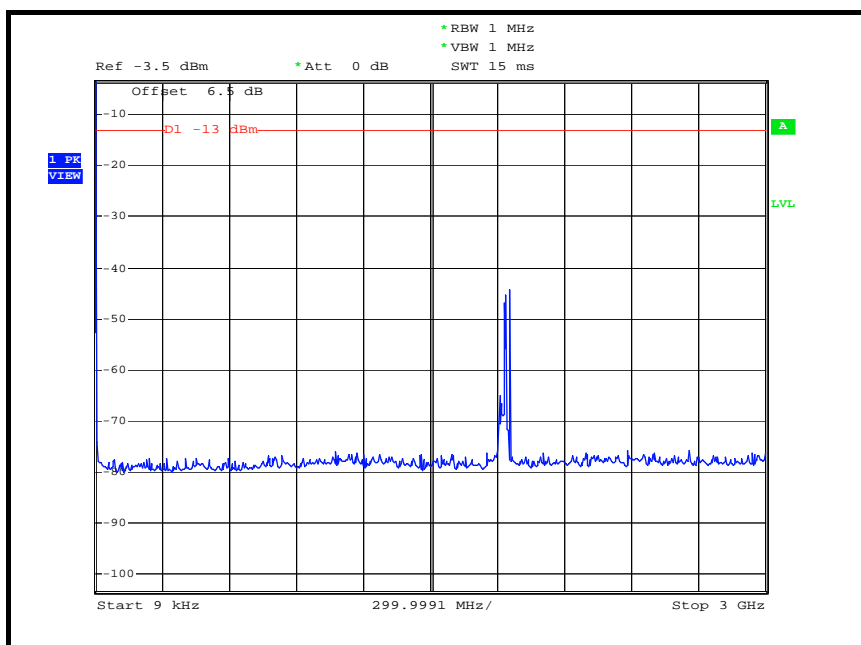

3GHz ~ 10GHz

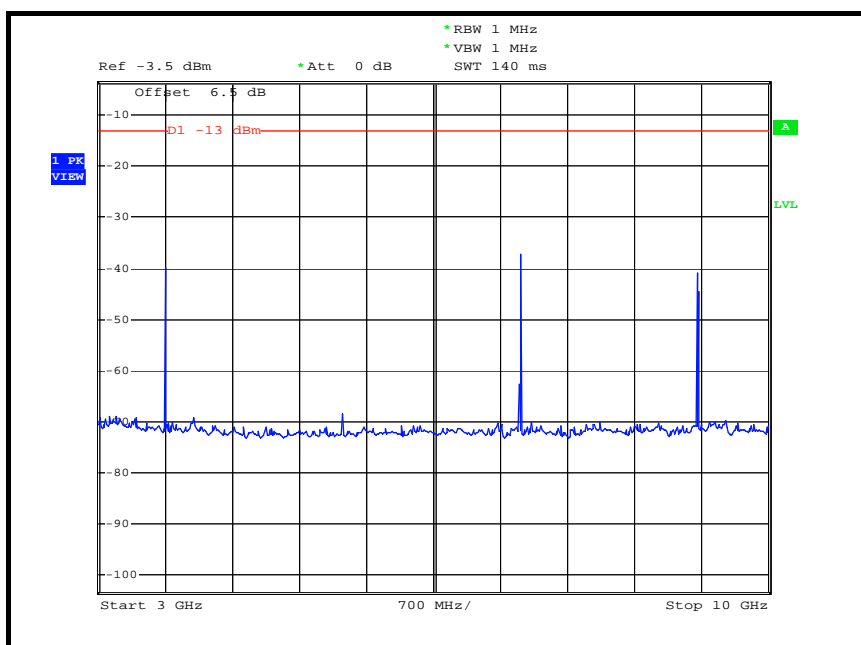

10GHz ~ 20GHz

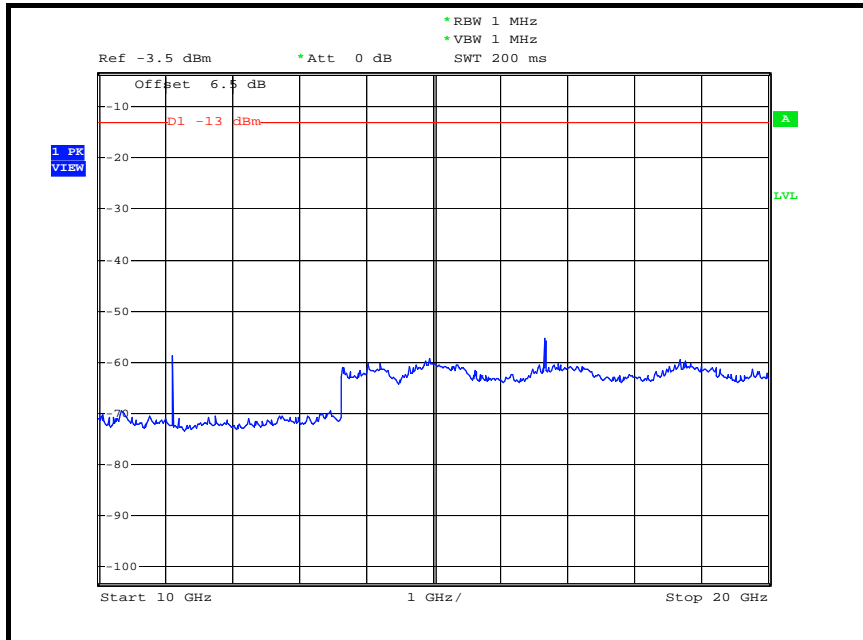

CH 600: 9kHz ~ 3GHz

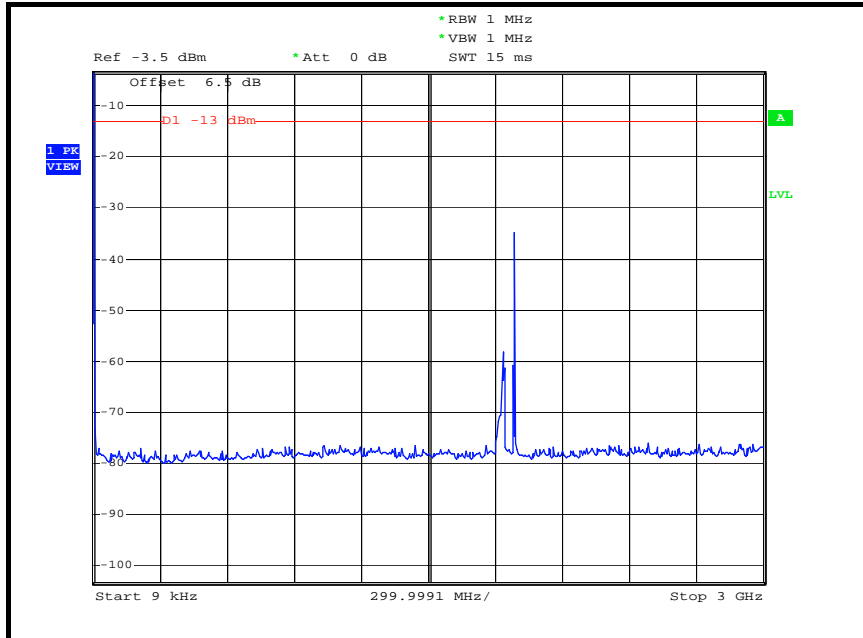

3GHz ~ 10GHz

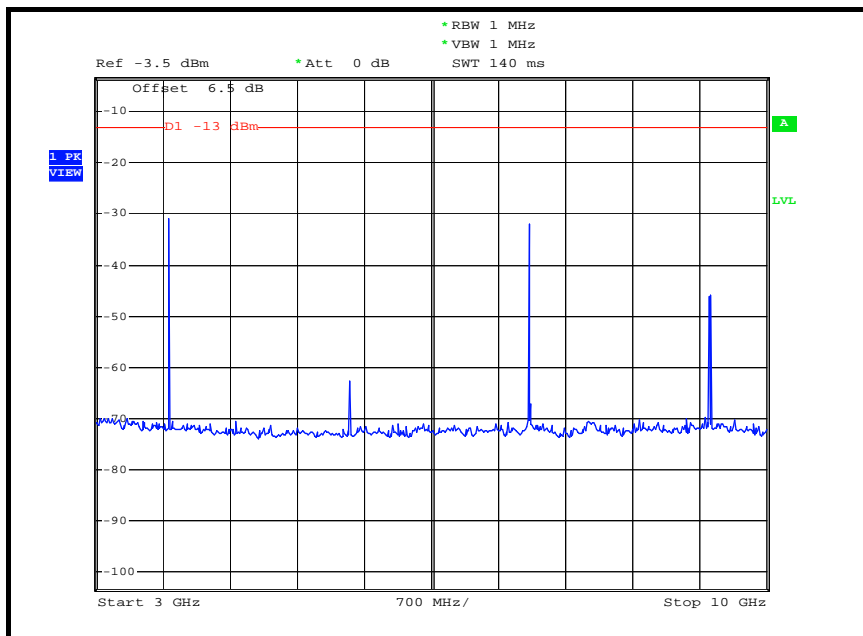

10GHz ~ 20GHz

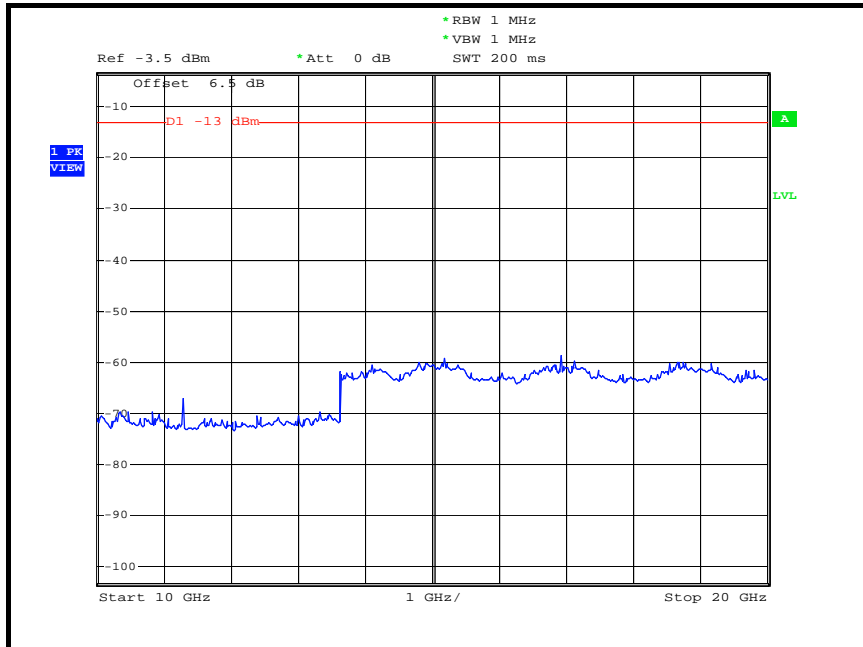

CH 1175: 9kHz ~ 3GHz

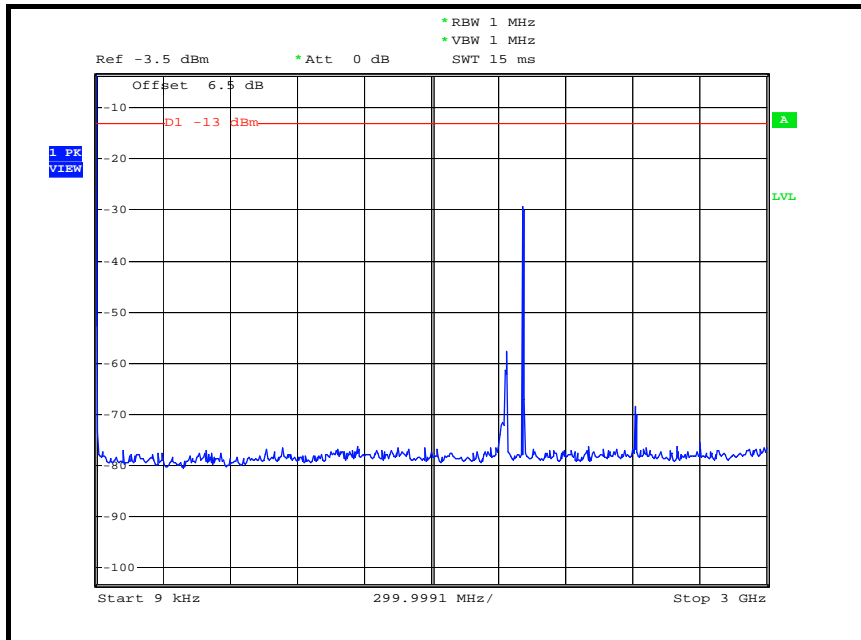

3GHz ~ 10GHz

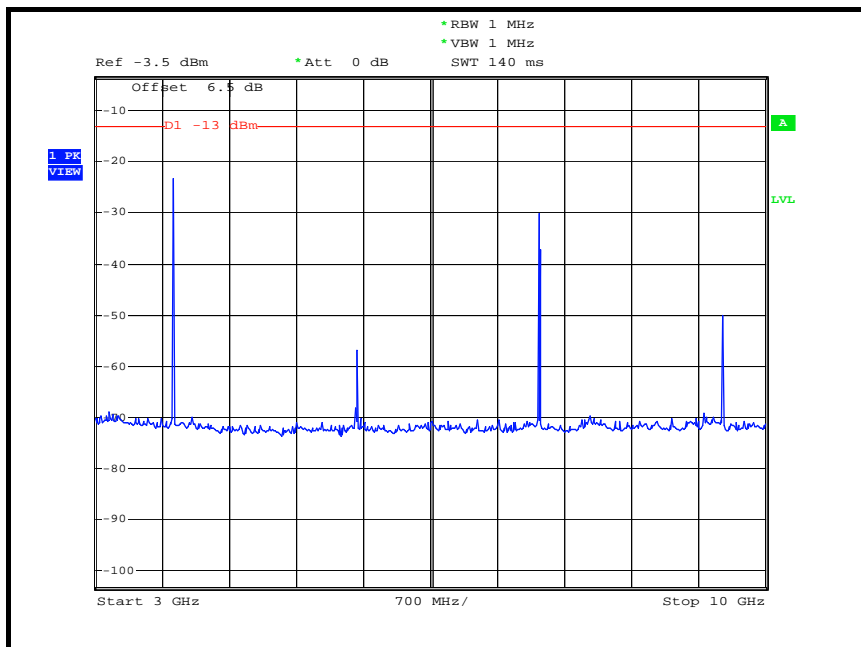

10GHz ~ 20GHz

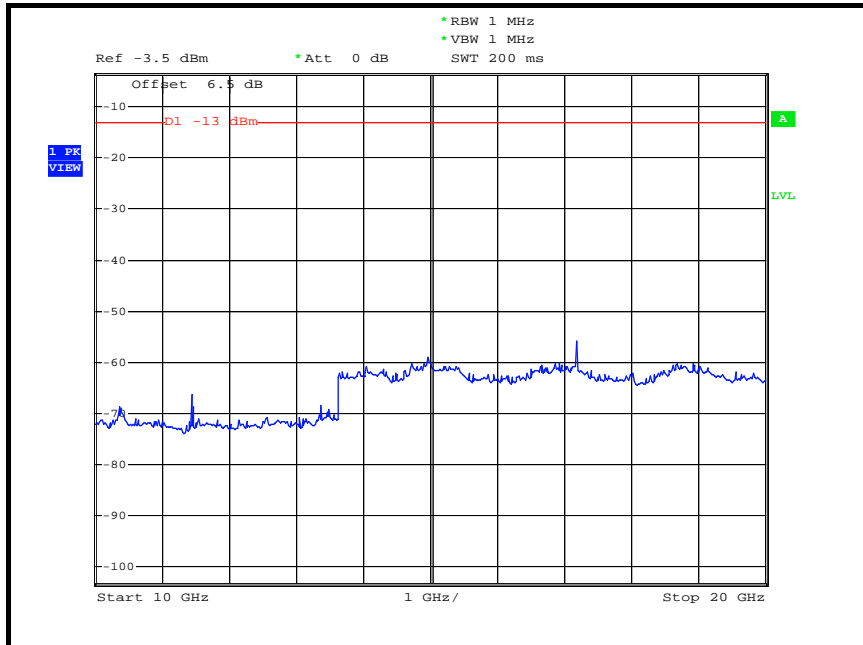

4.6 RADIATED EMISSION MEASUREMENT (BELOW 1GHz)

4.6.1 LIMITS OF RADIATED EMISSION MEASUREMENT

In the FCC 24.238(a), On any frequency outside a licensee’s frequency block within USPCS spectrum, the power of any emission shall be attenuated below the transmitter power (P) by at least $43 + 10 \log (P)$ dB. The specified minimum attenuation becomes 43dB and the limit of emission equal to -13dBm . So the limit of emission is the same absolute specified line.

LIMIT (dBm)	EQUIVALENT FIELD STRENGTH AT 3m (dBuV/m) (NOTE)
-13	82.22

NOTE: The following formula is used to convert the equipment radiated power to field strength.

$$E = [1000000\sqrt{(30P)}] / 3 \text{ uV/m, where P is Watts.}$$



4.6.2 TEST INSTRUMENTS

DESCRIPTION & MANUFACTURER	MODEL NO.	SERIAL NO.	CALIBRATED UNTIL
Test Receiver ROHDE & SCHWARZ	ESCI	100424	Jul. 27, 2008
Spectrum Analyzer ROHDE & SCHWARZ	FSP40	100269	Aug. 05, 2008
BILOG Antenna SCHWARZBECK	VULB9168	9168-153	Jan. 03, 2009
HORN Antenna SCHWARZBECK	BBHA 9120 D	9120D-563	Jul. 30, 2008
HORN Antenna SCHWARZBECK	BBHA 9170	BBHA9170242	Jan. 06, 2009
Preamplifier Agilent	8449B	3008A01910	Sep. 19, 2008
Preamplifier Agilent	8447D	2944A10638	Dec. 19, 2008
RF signal cable HUBER+SUHNNER	SUCOFLEX 104	274039/223650	Nov. 07, 2008
RF signal cable Worken	8D-FB	Cable-HYCH9-01	Aug. 09, 2008
Software	ADT_Radiated_V7.6	NA	NA
Antenna Tower EMCO	2070/2080	512.835.4684	NA
Turn Table EMCO	2087-2.03	NA	NA
Antenna Tower & Turn Table Controller EMCO	2090	NA	NA
Agilent Signal Generator	E8257C	MY43320668	Dec. 25, 2008

- NOTE:**
1. The calibration interval of the above test instruments is 12 months and the calibrations are traceable to NML/ROC and NIST/USA.
 2. The test was performed in HwaYa Chamber 9.
 3. The horn antenna and HP preamplifier (model: 8449B) are used only for the measurement of emission frequency above 1GHz if tested.
 4. The IC Site Registration No. is IC3789B-9.

4.6.3 TEST PROCEDURES

- a. The EUT was placed on the top of a rotating table 0.8 meters above the ground. The table was rotated 360 degrees to determine the position of the highest radiation.
- b. The EUT was set 3 meters away from the receiving antenna, which was mounted on antenna tower and its position at 0.8 m above the ground.
- c. For each suspected emission, the EUT was arranged to its worst case and the rotatable table was turned from 0 degrees to 360 degrees to find the maximum reading and recorded the value.
- d. Repeat step a ~ c for horizontal polarization.

NOTE: The resolution bandwidth of spectrum analyzer is 1 MHz and the video bandwidth is 3 MHz.

4.6.4 DEVIATION FROM TEST STANDARD

No deviation

4.6.5 TEST SETUP

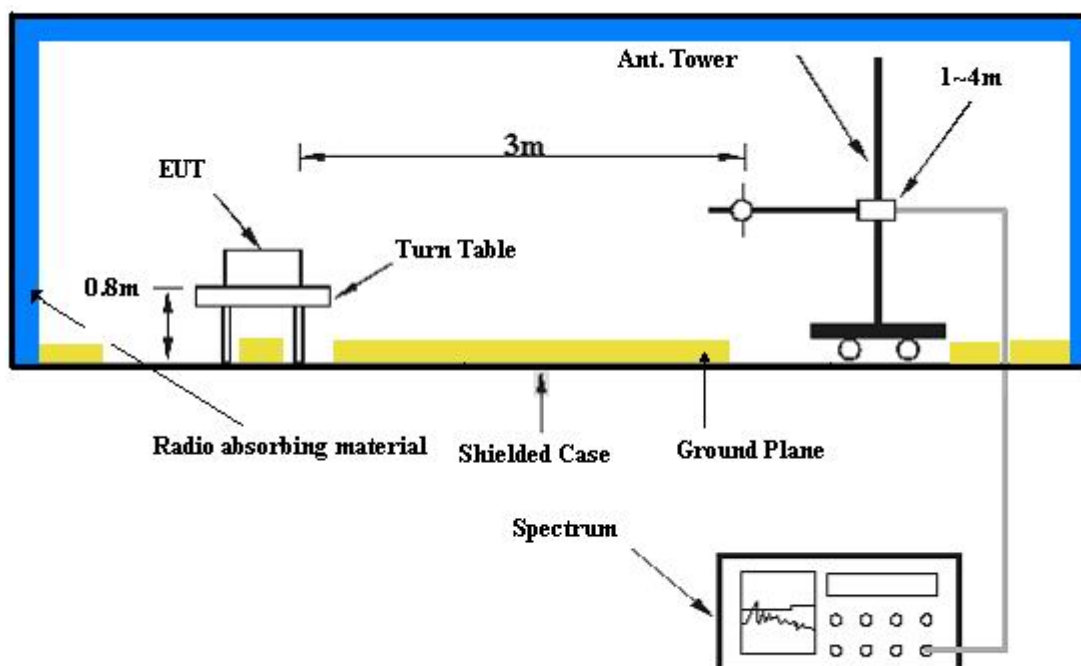

For the actual test configuration, please refer to the attached file (Test Setup Photo).

4.6.6 EUT OPERATING CONDITIONS

- a. The EUT makes a phone call to the communication simulator.
- b. The communication simulator station system controlled an EUT to export maximum output power under transmission mode and specific channel frequency.

4.6.7 TEST RESULTS

MODE	TX channel 25	DETECTOR FUNCTION	Quasi-Peak
FREQUENCY RANGE	Below 1000MHz	INPUT POWER (SYSTEM)	120Vac, 60Hz
ENVIRONMENTAL CONDITIONS	22deg. C, 69%RH, 988hPa	TESTED BY	Lori Chiu

ANTENNA POLARITY & TEST DISTANCE: HORIZONTAL AT 3 M								
NO.	FREQ. (MHz)	EMISSION LEVEL (dBuV/m)	LIMIT (dBuV/m)	MARGIN (dB)	ANTENNA HEIGHT (m)	TABLE ANGLE (Degree)	RAW VALUE (dBuV)	CORRECTION FACTOR (dB/m)
1	144.61	23.33 QP	82.22	-58.89	1.00 H	265.00	10.21	13.12
2	193.22	26.64 QP	82.22	-55.58	2.00 H	70.00	15.52	11.13
3	206.83	27.39 QP	82.22	-54.83	1.00 H	193.00	16.54	10.85
4	543.19	25.34 QP	82.22	-56.88	1.00 H	151.00	5.19	20.15
5	871.78	24.11 QP	82.22	-58.11	1.50 H	280.00	-1.48	25.59
6	881.50	36.89 QP	82.22	-45.33	1.00 H	271.00	11.22	25.67
7	910.66	24.35 QP	82.22	-57.87	2.00 H	127.00	-1.60	25.95
8	945.66	29.63 QP	82.22	-52.59	1.50 H	160.00	3.34	26.29

ANTENNA POLARITY & TEST DISTANCE: VERTICAL AT 3 M								
NO.	FREQ. (MHz)	EMISSION LEVEL (dBuV/m)	LIMIT (dBuV/m)	MARGIN (dB)	ANTENNA HEIGHT (m)	TABLE ANGLE (Degree)	RAW VALUE (dBuV)	CORRECTION FACTOR (dB/m)
1	179.61	21.71 QP	82.22	-60.51	1.00 V	319.00	9.42	12.29
2	337.10	24.80 QP	82.22	-57.42	2.00 V	34.00	10.31	14.49
3	430.42	26.41 QP	82.22	-55.81	1.00 V	190.00	9.49	16.92
4	494.58	27.37 QP	82.22	-54.85	1.00 V	151.00	8.43	18.93
5	547.08	25.38 QP	82.22	-56.84	1.00 V	199.00	5.14	20.25
6	698.74	26.87 QP	82.22	-55.35	1.00 V	205.00	4.40	22.47
7	852.33	24.17 QP	82.22	-58.05	2.00 V	196.00	-1.24	25.41
8	881.50	37.98 QP	82.22	-44.24	1.00 V	109.00	12.30	25.67
9	932.05	24.98 QP	82.22	-57.24	1.50 V	346.00	-1.17	26.15
10	945.66	29.08 QP	82.22	-53.14	1.00 V	43.00	2.79	26.29

NOTE:

1. Emission level (dBuV/m) = Raw Value (dBuV) + Correction Factor (dB).
2. Correction Factor (dB/m) = Antenna Factor (dB/m) + Cable Factor (dB).
3. The other emission levels were very low against the limit.
4. Margin value = Emission level – Limit value.
5. This is valid for all 3 channels.

4.7 RADIATED EMISSION MEASUREMENT (ABOVE 1GHz)

4.7.1 LIMITS OF RADIATED EMISSION MEASUREMENT

In the FCC 24.238(a), On any frequency outside a licensee's frequency block within USPCS spectrum, the power of any emission shall be attenuated below the transmitter power (P) by at least $43 + 10 \log (P)$ dB. The specified minimum attenuation becomes 43dB and the limit of emission equal to -13dBm .



4.7.2 TEST INSTRUMENTS

DESCRIPTION & MANUFACTURER	MODEL NO.	SERIAL NO.	CALIBRATED UNTIL
Test Receiver ROHDE & SCHWARZ	ESCI	100424	Jul. 27, 2008
Spectrum Analyzer ROHDE & SCHWARZ	FSP40	100269	Aug. 05, 2008
BILOG Antenna SCHWARZBECK	VULB9168	9168-153	Jan. 03, 2009
HORN Antenna SCHWARZBECK	BBHA 9120 D	9120D-563	Jul. 30, 2008
HORN Antenna SCHWARZBECK	BBHA 9170	BBHA9170242	Jan. 06, 2009
Preamplifier Agilent	8449B	3008A01910	Sep. 19, 2008
Preamplifier Agilent	8447D	2944A10638	Dec. 19, 2008
RF signal cable HUBER+SUHNNER	SUCOFLEX 104	274039/223650	Nov. 07, 2008
RF signal cable Worken	8D-FB	Cable-HYCH9-01	Aug. 09, 2008
Software	ADT_Radiated_V7.6	NA	NA
Antenna Tower EMCO	2070/2080	512.835.4684	NA
Turn Table EMCO	2087-2.03	NA	NA
Antenna Tower & Turn Table Controller EMCO	2090	NA	NA

- NOTE:**
1. The calibration interval of the above test instruments is 12 months and the calibrations are traceable to NML/ROC and NIST/USA.
 2. The test was performed in HwaYa Chamber 9.
 3. The horn antenna and HP preamplifier (model: 8449B) are used only for the measurement of emission frequency above 1GHz if tested.
 4. The IC Site Registration No. is IC3789B-9.

4.7.3 TEST PROCEDURES

- a. The EUT was placed on the top of a rotating table 0.8 meters above the ground. The table was rotated 360 degrees to determine the position of the highest radiation.
- b. The EUT was set 3 meters away from the receiving antenna, which was mounted on antenna tower and its position at 0.8 m above the ground.
- c. For each suspected emission, the EUT was arranged to its worst case and the rotatable table was turned from 0 degrees to 360 degrees to find the maximum reading and recorded the value.
- d. The EUT is replaced by a horn antenna connected to a signal generator tuned to the frequency of emission.
- e. The signal generator level has to be adjusted to have the same emission nature.
- f. The radiated power can be calculated via the factor and antenna gain.
- g. Repeat step a ~ f for horizontal polarization.

NOTE: The resolution bandwidth of spectrum analyzer is 1 MHz and the video bandwidth is 3 MHz.

4.7.4 DEVIATION FROM TEST STANDARD

No deviation

4.7.5 TEST SETUP

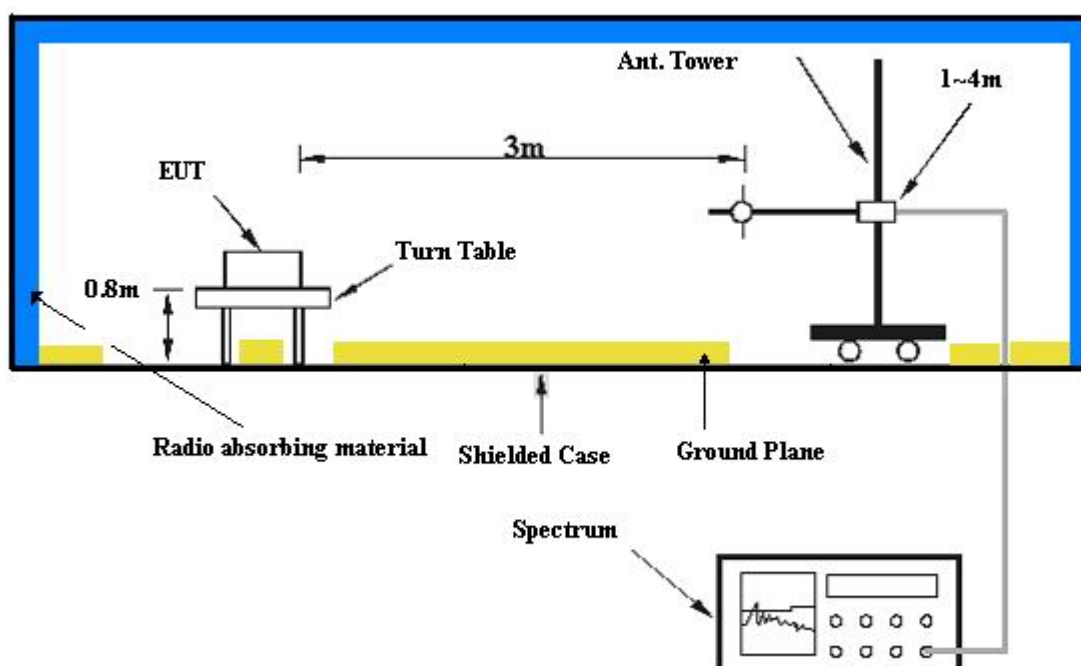

For the actual test configuration, please refer to the attached file (Test Setup Photo).

4.7.6 EUT OPERATING CONDITIONS

- a. The EUT makes a phone call to the communication simulator.
- b. The communication simulator station system controlled an EUT to export maximum output power under transmission mode and specific channel frequency.



4.7.7 TEST RESULTS

MODE	Channel 25	FREQUENCY RANGE	Above 1000MHz
INPUT POWER (SYSTEM)	120Vac, 60Hz	ENVIRONMENTAL CONDITIONS	23deg°C, 60%RH, 988hPa
TESTED BY	Match Tsui		

ANTENNA POLARITY & TEST DISTANCE: HORIZONTAL AT 3 M						
No.	Freq. (MHz)	Emission Level (dBuV)	Limit (dBm)	S.G Power Value (dBm)	Correction Factor (dB)	Power Value (dBm)
1	3702.50	42.33	-13.00	-63.02	10.12	-52.90
2	5553.75	41.74	-13.00	-64.98	11.49	-53.49

ANTENNA POLARITY & TEST DISTANCE: VERTICAL AT 3 M						
No.	Freq. (MHz)	Emission Level (dBuV)	Limit (dBm)	S.G Power Value (dBm)	Correction Factor (dB)	Power Value (dBm)
1	3702.50	45.75	-13.00	-59.60	10.12	-49.48
2	5553.75	38.28	-13.00	-68.44	11.49	-56.95

NOTE: Power Value (dBum) = S.G Power Value (dBm) + Correction Factor (dB).



MODE	Channel 600	FREQUENCY RANGE	Above 1000MHz
INPUT POWER (SYSTEM)	120Vac, 60Hz	ENVIRONMENTAL CONDITIONS	23deg°C, 60%RH, 988hPa
TESTED BY	Match Tsui		

ANTENNA POLARITY & TEST DISTANCE: HORIZONTAL AT 3 M						
No.	Freq. (MHz)	Emission Level (dBuV)	Limit (dBm)	S.G Power Value (dBm)	Correction Factor (dB)	Power Value (dBm)
1	3760.00	42.51	-13.00	-62.84	10.12	-52.72
2	5640.00	41.25	-13.00	-65.47	11.49	-53.98

ANTENNA POLARITY & TEST DISTANCE: VERTICAL AT 3 M						
No.	Freq. (MHz)	Emission Level (dBuV)	Limit (dBm)	S.G Power Value (dBm)	Correction Factor (dB)	Power Value (dBm)
1	3760.00	45.36	-13.00	-59.99	10.12	-49.87
2	5640.00	38.13	-13.00	-68.59	11.49	-57.10

NOTE: Power Value (dBum) = S.G Power Value (dBm) + Correction Factor (dB).



MODE	Channel 1175	FREQUENCY RANGE	Above 1000MHz
INPUT POWER (SYSTEM)	120Vac, 60Hz	ENVIRONMENTAL CONDITIONS	23deg°C, 60%RH, 988hPa
TESTED BY	Match Tsui		

ANTENNA POLARITY & TEST DISTANCE: HORIZONTAL AT 3 M						
No.	Freq. (MHz)	Emission Level (dBuV)	Limit (dBm)	S.G Power Value (dBm)	Correction Factor (dB)	Power Value (dBm)
1	3817.50	42.58	-13.00	-62.82	10.17	-52.65
2	5726.25	42.07	-13.00	-64.65	11.49	-53.16

ANTENNA POLARITY & TEST DISTANCE: VERTICAL AT 3 M						
No.	Freq. (MHz)	Emission Level (dBuV)	Limit (dBm)	S.G Power Value (dBm)	Correction Factor (dB)	Power Value (dBm)
1	3817.50	45.66	-13.00	-59.74	10.17	-49.57
2	5726.25	38.42	-13.00	-68.30	11.49	-56.81

NOTE: Power Value (dBum) = S.G Power Value (dBm) + Correction Factor (dB).



5 INFORMATION ON THE TESTING LABORATORIES

We, ADT Corp., were founded in 1988 to provide our best service in EMC, Radio, Telecom and Safety consultation. Our laboratories are accredited and approved by the following approval agencies according to ISO/IEC 17025.

USA	FCC, UL, A2LA
GERMANY	TUV Rheinland
JAPAN	VCCI
NORWAY	NEMKO
CANADA	INDUSTRY CANADA , CSA
R.O.C.	TAF, BSMI, NCC
NETHERLANDS	Telefication
SINGAPORE	GOST-ASIA (MOU)
RUSSIA	CERTIS (MOU)

Copies of accreditation certificates of our laboratories obtained from approval agencies can be downloaded from our web site: www.adt.com.tw/index.5/phtml.
If you have any comments, please feel free to contact us at the following:

Linko EMC/RF Lab:
Tel: 886-2-26052180
Fax: 886-2-26051924

Hsin Chu EMC/RF Lab:
Tel: 886-3-5935343
Fax: 886-3-5935342

Hwa Ya EMC/RF/Safety/Telecom Lab: Web Site: www.adt.com.tw
Tel: 886-3-3183232
Fax: 886-3-3185050

The address and road map of all our labs can be found in our web site also.



6 APPENDIX A – MODIFICATIONS RECORDERS FOR ENGINEERING CHANGES TO THE EUT BY THE LAB

No any modifications are made to the EUT by the lab during the test.